



this **ACIATE/CTTE yearbook** was

scanned at the department of

**Technology and Engineering Education,**

Central Connecticut State University



...by Johnny Kassay and Pat Foster from the collections of several educators, including David Sianez and James DeLaura.

**Responsibility for any copyright infringement is claimed by Patrick N. Foster.** We plan to improve this document by re-scanning, adding links, and/or direct neural input.

**INDUSTRIAL ARTS  
IN THE OPEN ACCESS  
CURRICULUM**

**1978**

*American Council on  
Industrial Arts Teacher Education*

**27th yearbook**

**INDUSTRIAL ARTS  
IN THE OPEN ACCESS  
CURRICULUM**



# **INDUSTRIAL ARTS IN THE OPEN ACCESS CURRICULUM**

Editor

Lowell D. Anderson, Ph. D.

## **27th Yearbook 1978**

*American Council on  
Industrial Arts Teacher Education*

A Division of the American Industrial Arts Association  
and the National Education Association

**Copyright 1978**

**American Council on Industrial Arts Teacher Education**

*All rights reserved. No part of this book may be reproduced, in any form, without permission in writing from the American Council on Industrial Arts Teacher Education.*

Lithographed in U.S.A.

Yearbooks of the American Council on Industrial Arts Teacher Education are produced and distributed by the McKnight Publishing Company, Bloomington, Illinois 61701

**Orders and requests for information about cost and availability of yearbooks should be addressed to the company.**

Requests to quote portions of yearbooks should be addressed to the Secretary, American Council on Industrial Arts Teacher Education, in care of the publisher, for forwarding to the current Secretary.

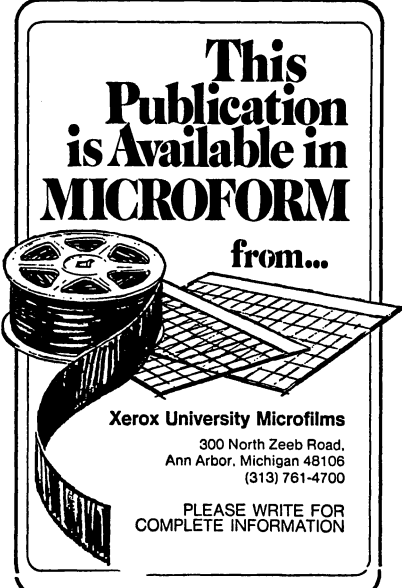

**This  
Publication  
is Available in  
MICROFORM**

from...

**Xerox University Microfilms**  
300 North Zeeb Road,  
Ann Arbor, Michigan 48106  
(313) 761-4700

PLEASE WRITE FOR  
COMPLETE INFORMATION

# Foreword

With the advent of changes in technology and an increasing emphasis in educational methodology within the public schools program, it is imperative that industrial arts evaluate useful or possible alternatives to classroom operation. This yearbook is an overview of the possibilities which the open access curriculum may have toward the structure of the laboratory environment. This yearbook is an attempt by the industrial arts profession to examine some of the concepts of open access education. The yearbook addresses itself toward the implications of open access structure to industrial arts and the possible changes or requirements in content which may exist as a result of this structure. It evaluates some alternatives or variations in teacher education as well as examines humanism and teacher competencies related to open access pedagogy.

ACIATE is grateful to the editor, Lowell D. Anderson, for his dedication in pursuing this publication and to the authors for giving of their time and talents. The quality of research and the willingness of these dedicated professionals in finding answers to changes occurring in educational technology says much for the profession. It is through their efforts that teacher education programs and classroom operation in the public schools will be improved.

The Council is also grateful for the contributions made by the McKnight Publishing Company whose support over the past 27 years has made the ACIATE Yearbook program possible.

*David L. Jelden*  
*President, ACIATE*





# Yearbook Planning Committee

## *Terms Expiring 1978*

Donald Maley

University of Maryland, College Park, Maryland

Bernard S. Proctor

Cheyney State College, Cheyney, Pennsylvania

## *Terms Expiring in 1979*

Ethan Svendsen

Indiana State University, Terre Haute, Indiana

Robert Swanson

University of Wisconsin-Stout, Menomonie, Wisconsin

## *Terms Expiring 1980*

John R. Ballard

Southwest Texas State University, San Marcos, Texas

Frederick D. Kagy

Illinois State University, Normal, Illinois

## *Terms Expiring 1981*

W. R. Miller

University of Missouri, Columbia, Missouri

Robert G. Thrower

Trenton State College, Trenton, New Jersey

## *Terms Expiring 1982*

Ralph C. Bohn

San Jose State University

John T. Fecik

Cheyney State College

# Officers of the Council

David L. Jelden, *President*  
University of Northern Colorado

Alvin E. Rudisill, *Vice President*  
University of Northern Iowa

Ervin A. Dennis, *Secretary*  
University of Northern Iowa

Jack Kirby, *Treasurer*  
University of Wisconsin — Platteville

# Yearbook Proposals

Each year, at the AIAA national convention, the ACIATE Yearbook Committee reviews the progress of yearbooks in preparation and evaluates proposals for additional yearbooks. Any member is welcome to submit a yearbook proposal. It should be written in sufficient detail for the committee to be able to understand the proposed substance and format, and sent to the committee chairman by February 1 of the year in which the convention is held. Below are the criteria employed by the committee in making yearbook selections.

ACIATE Yearbook Committee

## Guidelines for ACIATE Yearbook Topic Selection

With reference to a specific topic:

1. It should make a direct contribution to the understanding and the improvement of industrial arts teacher education.
2. It should avoid duplication of the publications activities of other professional groups.
3. It should confine its content to professional education subject matter of a kind that does not infringe upon the area of textbook publication which treats a specific body of subject matter in a structured, formal way.
4. It should not be exploited as an opportunity to promote and publicize one man's or one institution's philosophy unless the volume includes other similar efforts that have enjoyed some degree of popularity and acceptance in the profession.
5. While it may encourage and extend what is generally accepted as good in existing theory and practice, it should also actively and constantly seek to upgrade and modernize professional action in the area of industrial arts teacher education.
6. It can raise controversial questions in an effort to get a national hearing and as a prelude to achieving something approaching a national consensus.

7. It may consider as available for discussion and criticism any ideas of individuals or organizations that have gained some degree of acceptance as a result of dissemination either through formal publication, through oral presentation, or both.
8. It can consider a variety of seemingly conflicting trends and statements emanating from a variety of sources and motives, analyze them, consolidate and thus seek out and delineate key problems to enable the profession to make a more concerted effort at finding a solution.

Approved, Yearbook Planning Committee  
March 15, 1967, Philadelphia, Pa.

# Previously Published Yearbooks

1. *Inventory-Analysis of Industrial Arts Teacher Education Facilities, Personnel and Programs*, 1952. Walter R. Williams, Jr. and Harvey Kessler Meyers, eds.
- \* 2. *Who's Who in Industrial Arts Teacher Education*, 1953. Walter R. Williams, Jr. and Roy F. Bergengren, Jr., eds.
- \* 3. *Some Components of Current Leadership*. Roy F. Bergengren, Jr. *Techniques of Selection and Guidance of Graduate Students*. George F. Henry. *An Analysis of Textbook Emphases*. Talmage B. Young. 1954, three studies.
- \* 4. *Superior Practices in Industrial Arts Teacher Education*, 1955. R. Lee Hornbake and Donald Maley, eds.
- \* 5. *Problems and Issues in Industrial Arts Teacher Education*. 1956. C. Robert Hutchcroft, ed.
- \* 6. *A Sourcebook of Reading in Education for Use in Industrial Arts and Industrial Arts Teacher Education*, 1957. Carl Gerbracht and Gordon O. Wilbur, eds.
- \* 7. *The Accreditation of Industrial Arts Teacher Education*, 1958. Verne C. Fryklund, ed., and H. L. Helton.
- \* 8. *Planning Industrial Arts Facilities*, 1959. Ralph K. Nair, ed.
- \* 9. *Research in Industrial Arts Education*, 1960. Raymond Van Tassel, ed.
- \*10. *Graduate Study in Industrial Arts*, 1961. Ralph P. Norman and Ralph C. Bohn, eds.
- \*11. *Essentials of Preservice Preparation*, 1962. Donald G. Lux, ed.
- \*12. *Action and Thought in Industrial Arts Education*, 1963. E.A.T. Svendsen, ed.
- \*13. *Classroom Research in Industrial Arts*, 1964. Charles B. Porter, ed.
- \*14. *Approaches and Procedures in Industrial Arts*, 1965. G. S. Wall, ed.
15. *Status of Research in Industrial Arts*, 1966. John D. Rowlett, ed.
16. *Evaluation Guidelines for Contemporary Industrial Arts Programs*, 1967. Lloyd P. Nelson and William T. Sargent, eds.
17. *A Historical Perspective of Industry*, 1968. Joseph F. Leutkemeyer, Jr., ed.
18. *Industrial Technology Education*, 1969. C. Thomas Dean and N. A. Hauer, eds. *Who's Who in Industrial Arts Teacher Education*, 1969. John M. Pollock and Charles A. Bunten, eds.
19. *Industrial Arts for Disadvantaged Youth*, 1970. Ralph O. Gallington, ed.
20. *Components of Teacher Education*, 1971. W. E. Ray and Jerry Streichler, eds.
21. *Industrial Arts for the Early Adolescent*, 1972. Daniel L. Householder, Editor.
- \*22. *Industrial Arts in Senior High Schools*, 1973. Rutherford E. Lockette, Editor.

23. *Industrial Arts for the Elementary School*, 1974. Robert G. Thrower and Robert D. Weber, eds.
24. *A Guide to the Planning of Industrial Arts Facilities*, 1975. Donald E. Moon, ed.
25. *Future Alternatives for Industrial Arts*, 1976. Lee H. Smalley, Editor.
26. *Competency-Based Industrial Arts Teacher Education*, 1977. Jack C. Brueckman and Stanley E. Brooks, Editors.

\*Out-of-print yearbooks can be obtained in microform and in Xerox copies. For information on price and delivery, write to Xerox University Microfilms, 300 North Zeeb Road, Ann Arbor, Michigan, 48106.

# Contents

	<b>Page</b>
<b>FOREWORD</b> .....	<b>5</b>
<b>PREFACE</b> .....	<b>15</b>
<b>CHAPTER 1 NEW DIMENSIONS OF ACCESS</b> .....	<b>19</b>
<i>L. Craig Wilson</i> <i>University of Delaware</i> <i>Newark, Delaware</i>	
<b>CHAPTER 2 THE MEANING OF OPEN ACCESS FOR INDUSTRIAL ARTS CURRICULA</b> .....	<b>37</b>
<i>David L. McCrory</i> <i>West Virginia University</i> <i>Morgantown, West Virginia</i>	
<b>CHAPTER 3 LEARNING ENVIRONMENTS FOR INDUSTRIAL ARTS</b> .....	<b>59</b>
<i>Ronald D. Todd</i> <i>New York University</i> <i>New York, New York</i>	
<b>CHAPTER 4 OPEN ACCESS TECHNOLOGY: A DESIGN FOR SURVIVAL</b> .....	<b>89</b>
<i>J. Barry DuVall</i> <i>West Virginia University</i> <i>Morgantown, West Virginia</i>	
<b>CHAPTER 5 THE STATE OF THE ART-INDUSTRIAL ARTS IN THE OPEN ACCESS CURRICULUM</b> .....	<b>117</b>
<i>Lowell S. Zurbuch</i> <i>Kent State University</i> <i>Kent, Ohio</i>	
<b>CHAPTER 6 IMPLICATIONS FOR INDUSTRIAL ARTS TEACHER PREPARATION</b> .....	<b>145</b>
<i>Richard V. Barella</i> <i>and</i> <i>Donald F. Smith</i> <i>Ball State University</i> <i>Muncie, Indiana</i>	

<b>CHAPTER 7 THE OPEN ACCESS TEACHER .....</b>	<b>177</b>
<i>James S. Levande</i>	
<i>McDonald Middle School</i>	
<i>East Lansing Public Schools</i>	
<i>East Lansing, Michigan</i>	
<b>CHAPTER 8 HUMANISM IN AMERICAN EDUCATION: A HISTORICAL OVERVIEW .....</b>	<b>217</b>
<i>William H. McPherson</i>	
<i>Iowa State University</i>	
<i>Ames, Iowa</i>	
<b>CHAPTER 9 IMPLICATIONS FOR INDUSTRIAL ARTS IN THE OPEN ACCESS CURRICULUM ...</b>	<b>239</b>
<i>Lowell D. Anderson</i>	
<i>University of Manitoba</i>	
<i>Winnipeg, Canada</i>	
<b>INDEX .....</b>	<b>258</b>



# Preface

The American Council on Industrial Arts Teacher Education through the yearbook provides the opportunity for a few individuals to explore and report on a topic of interest to the profession. This year's twenty-eighth yearbook, *Industrial Arts in the Open Access Curriculum*, is the result of an inquiry into the concept of open education.

Open access curriculum as defined by Craig Wilson is the providing of opportunity for all to have greater access to knowledge. A basic premise is that this access to knowledge is the key to economic and social opportunity. It is frequently recognized that schools have frequently been more adept at channeling opportunity than successful with creating and producing opportunity. This access to society through the use of a formalized institution (the school) differs from the models of many proponents of open and alternative education.

Throughout the yearbook, open access is defined as a part of the continuum of open education ranging from closed to open. The recognition of "schooling" and the existence of a curriculum places Wilson's concept as being more conventional as compared to other options which advocate no curriculum or schooling. A concise separation of open access from the broader concept of open education would first require a clean definition of both. Advocates are casually forced to define open education as existing, "because it feels and looks proper," hardly a definition susceptible to empirical scrutiny.

However open education has gained considerable attention in the education community. The impact of the phenomenon in its many forms is being experienced by the classroom teacher. The purpose of the yearbook has been to help clarify the meaning of open education, to assist the teacher entering the profession and to give members of the profession an assessment of the state-of-the-art.

The yearbook is organized around the following topics. Chapters 1 and 2 are intended to clarify and give philosophical meaning to commonly used terms. Chapter 3 is on learning environments providing both a conceptual and practical model which can serve to challenge persons planning for open educa-

tion. Questions on the bases for curriculum are posited in Chapter 4 with a strong recommendation to consider technology. The perception of members of the ACIATE and other pertinent research on open education is given in Chapter 5 with specific recommendations for teacher education in Chapter 6. The experiences and observations of a classroom teacher in a middle school while implementing open education are the basis of Chapter 7. A historical investigation, Chapter 8, of our “roots in humanism” is an important contribution to an understanding of this evolutionary thread in our profession. An overview of the chapters and implications in Chapter 9 serves to conclude the yearbook.

I would like to thank the many contributors to this yearbook for researching, writing, editing, typing, and printing. Your contribution to the continued development of open access curriculum in industrial arts is sincerely recognized.

*Lowell D. Anderson*  
*Editor*



**Dr. L. Craig Wilson**

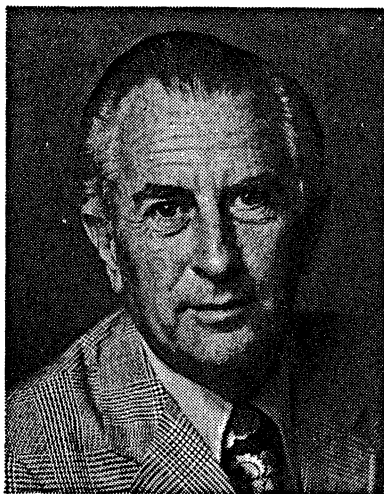

L. Craig Wilson, a Peabody Ph.D. of 1952, has changed career emphases three times, beginning with community development (major publications in 1955 and 1959), moving to incentive-style leadership on the state level (*Sociology of Supervision*, 1969), and culminating in the award-winning *Open Access Curriculum* in 1971. Currently in press with Allyn and Bacon is his latest application of open education theory, *Survival Behavior for Schools: Strategies for the Educator*.

The consistent thread throughout Professor Wilson's career at Peabody, Auburn, and the University of Delaware — as well as a state Director of Research and Planning — has been his advocacy of high-trust management, community decision-making, and personal autonomy for teachers. His primary teaching fields are curriculum design, supervision, and leadership theory.

# New Dimensions of Access

*L. Craig Wilson*

Education's future unfolds haltingly from a confused present, notwithstanding Yearbook attempts to illuminate the road ahead. Private visions of a better tomorrow clearly include the "open education" possibilities herein explored. However, an even more certain forecast which one can make is that new surprises also lie ahead. The underlying reason for persistent uncertainty is the bewildering array of counter forces, political, economic, and social which now compete for the control of "schooling." The reasons for this desired control is frequently quite extraneous to education and learning as conceived by members of the profession. These are the same forces which have caused previous educational futurists to be wrong more often than they have been lucky. The reason for frequent error experienced by educational planners is the under-estimation of the school's vulnerability to be subjugated through external pressure. This vulnerability is coupled with an idealized myth by members of the profession that they have complete professional autonomy.

The record on future educational planning is both interesting and disillusioning. For example, where did the idea of "Education as a growth industry" go when inflation decimated the public treasury, raised many critical costs of "schooling" beyond the grasp of the middle class, and abruptly shrunk the college-bound category of high school graduates below the anticipated 50 per cent (55% in 1968, 46% in 1976)? And, who was *really* ready for the end of the "baby boom" in terms of its now-proven capability for dislocating thousands of qualified teachers, closing hundreds of schools, terminating or deferring capital outlay pro-

grams in every state, and making Colleges of Education look little short of foolish for continuing to prepare people for non-existent jobs?

In the technological area, who would have thought that the miniature calculator would prove to be a more revolutionary educational change agent than the computer . . . that Xerox would produce the ultimate "teacher aid" revolutionizing the concept of information access . . . that TV picture tubes would replace Life Magazine-style picture magazines; and, that even Betty Ford, wife of past President Gerald Ford, would be caught up in the "everybody a good buddy" CB radio craze? Then comes the ultimate paradox of the communications-intensive culture producing a generation of non-readers whose scores on achievement tests have tumbled below previously established norms in almost every academic discipline.

Conversely, the profession's familiar dream of in-and-out life-long education has somehow managed to survive, perhaps even to thrive. Compulsory school attendance ages have simultaneously reversed themselves and now show signs of dropping below a reasonable estimate of the time required to bring a new wage earner to economic independence. Perhaps a factor contributing to the abandoning of the hard line on compulsory school age has been the degeneration of the "discipline problem" into a "crime problem" in some schools. Another factor is the recognition that money can be saved by cutting back on school's traditional "custodial function" as differing from our more formal mission of teaching. A more positive view of these changes might be that self-directed learning has finally come of age in our society.

When one mentally combines all of those variables, the puzzling impression emerges that the schools are self-destructing; and, at the same time, frantically generating exciting new dimensions of commitment and opportunity. The changes appear to be both profound and permanent — more like landslides than mere earth tremors. It is, therefore, unlikely that schools will ever "bounce back" to any previously better-understood or happier condition. "Recovery theories" are potentially dangerous for the same reason that an old rubber band has to be discarded after it has been stretched beyond its rebound capability. It would appear that in the future the wiser choice is to expect "improvement" to

be largely a matter of “invention” and only marginally a process of “restoration.” *What is being invented is new avenues of access* for some individuals while for many in society the *motivation is simple survival — behavior.*

Many illustrations could be cited to support these suppositions but the reality is that the schools have no way of surviving as an overwhelming labor-intensive establishment under the new economic conditions in the United States. A part of the solution will be to invent technology-intensive delivery systems to facilitate learning in fields where self-teaching is appropriate. More broadly, “learning” and “teaching” in our present conceptualization, can never again be considered synonymous.

## FROM “OPEN ACCESS” TO “COMMON MARKET” THEORIZING

This stress on invention is not a call for speculative futurism, which, as noted, has shown signs of failure. It is, rather, an invitation to generate a new overall image of “schooling,” not “de-schooling” but *different* schooling. Such a model is fortunately already beginning to appear in its *larger structural dimensions* — not through the wizardry of educational planners as much as through the accumulated survival behaviors of thousands of little people whose ambition is to be among the survivors themselves. This survival pressure is the primary force motivating for solution to evolving school problems.

The apparent evolving concept being applied to education is that of a workable political-economic cooperative arrangement known as the “Common Market.” Application of this concept to education is feasible. These principles of the common market arrangements common to international economic cooperation need to be examined prior to generalizing to education.

1. Territorial and political sovereignty.
2. An admission of territorial insufficiency — the impossibility of total independence within even large territorial limits.
3. Jurisdictional specialization reflecting indigenous resource advantages.

4. The eventual interdependence of specialty resources without regard for jurisdictions.
5. The controllability of exchange rates without the imposition of a master plan.
6. The desirability of a free flow of goods and services only minimally regulated at border crossings.

Common market logic begins to have meaning for educators when "school system" is substituted for "country" in the previous analogy. It then leads to:

1. Rejection of the "comprehensive school" which Harvard's James Conant sold the country on a quarter century ago.
2. The creation of specialized resource centers, connected by good passports, as the only way to break the mediocrity barrier which "comprehensiveness" imposes (excellence in everything, everywhere, is a fiscal impossibility).
3. The creation of a "free market" type of movement of educational clients to and from non-mobile resource bases (taking the student to the technology).
4. The managed availability of specialized mobile resources across jurisdictional lines (taking the teacher to the student).

Current trends, dichotomously, both support and negate such a system. For example; "special education," "adult education," and "technical education" have already established the concept of specialty learning centers. The centers typically exist under semi-autonomous administrative controls, enjoy financial equity which recognizes resource uniqueness, credential their teachers for specialized missions, employ technology peculiar to their specialty, and select students who can benefit most by such instructional experience. Other kinds of resource centers abound but the ones just cited are the oldest and most powerful in the education system.

In direct conflict with these specialized delivery centers is the current goal of "mainstreaming" students. The mainstreaming concept paralleled earlier the civil rights decisions which were made to promote the concept of "justice through parity." These court decisions were made in an attempt by the courts to solve complex social-educational problems by redrawing jurisdictional boundaries to reallocate both funding and people within society; the implication being that the basic problem was one of authority allocation or abuse of power.



A cursory examination of these decisions results in confusion. However a reasonable optimist might still see a possibility that schools will continue to move toward *increased specialization but in fewer areas of study*, that *administrative jurisdictions will tend to be smaller than*, rather than coterminous with, *the traffic patterns of students*. This concept will perhaps someday mature into a new cause, the "territorial liberation of the learner." Application of the common market concept could result in a dramatic *increase in the sanctioned diversity of student programs which will increase the school's survival potential* without proportionately increasing schooling costs.

This yearbook is, therefore, either an anachronism — the dying gasp of universal opportunity under increasing economic pressure — or, it is the initial vision of a "common market" design in which openness is the survival dynamic rather than an appealing but disastrously-costly frill. If the latter option "wins," then *"curriculum design" will become an approved network of specialized resource centers linked by compatible access policies and regulations. It will no longer be content "scope and sequence" within a given school building or administrative jurisdiction*. The decisions made by individuals on how to schedule and transport themselves within an open access model would increasingly be a personal matter.

The industrial arts components of both career and general education have a special stake in "network-type" program models. The "key" to survival of industrial arts is to have enough autonomy to maintain a distinctive high-technology resource base. More important, industrial arts survival is the *access authorization for students to tap the technology of modern man's economic and environmental survival*. Pragmatically, it is significant that consortium-type logic does not create discomfort in the technical community. The ability to develop links with science, government, business and industry using the total community is critical to an accessing curriculum. It will become increasingly critical for survival that all levels of technological expertise be tapped without costly duplications of technology and staff or curtailing student access. Consortia such as the West Virginia consortium of a few years ago serve to support that educational "common market" can be carefully planned, responsibly managed, and simultaneously remain creatively open. How "open

education" ever got maligned as unplanned, devoid of standards, and irresponsibly costly may remain a mystery. It never was any of these things but that is now unimportant. It led to the emergence of the "common market" version of *controllable openness* and that is the idea which has a solid claim on the future. Meanwhile, much of the "*open access curriculum*" logic will continue to be viable as the rationale for flexibility and personalization within the common market framework evolve. Structure and methodology thus combine to promote maximum economic efficiency optimizing student growth potential.

## **SURVIVAL COMPONENTS OF OPEN CURRICULA**

The school bureaucracy is somewhat like the European motorcycle which was advertised to "rust overnight but last forever" — it *does* appear to have the same paradoxical combination of unlimited life but only mediocre quality. Survival of individuals in a school setting, or survival of the school itself, is obviously possible under a wide variety of curricular designs. The issue is not "can it last?" but "can it sustain quality as long as it lasts?" Excellence and survival become the same when only the best is good enough.

Some people erroneously assume that interest in open access as a vehicle for survival is limited to the educationally deprived. Actually, all types of learners are currently deprived by school programs which require less initiative and independence than the larger culture, most especially the academically talented. The immediate relevance of open access as a survival concept derives from the characteristics which now follow.

### **Survival Factor #1 — Content Differentiation for a Degree of Stability**

Most of the obsolescence of current school programs is due to a factor which is so obvious that it becomes invisible. It is the simple fact that much of the content in every discipline, probably as much as 50 percent, has moved from the category of relatively *stable knowledge* ("fact," "truth," "popular consensus") into one of two much newer categories — *contested truth* (public forums, value revisions, new scientific information) or *exploratory hypothesis* (research, inspiration, creativity). The schools did not initiate these changes, nor is it fair to say that they resist them. The legitimate charge is that schedules, teacher assignments, and

testing procedures were originally established on the premise that the school's purpose was the transmission of high-consensus information and with it, the culture which generated it. Examples are evident that a critical mass of information and the newer categories of knowledge have not found a way to enter even the more progressive programs. For example, students cannot yet elect a technology-based "total communications" approach to language development. This occurs in spite of the constant bombardment of students' lives by electronic, instantaneous worldwide entertainment and news coverage. Reading is still important because some important kinds of communications will always be in book form. Theoretically, many students have a chance, not only to read, but additionally to access records, tapes, films, and computer libraries — modern extensions of the book. What is apparent is that few schools let students use these devices to create new content for themselves. Indeed, most schools are still trying to find enough room in the schedule for writing, speaking, and listening to compete successfully with literary history, language structure, and reading. Getting serious about using language to create new literature is just "too much." Examples are equally easy to cite in the scientific areas, one being the extreme difficulty which the college-bound student has in accessing the impressive modern technologies which the "tracking" system has relegated to industrial arts programs, vocational schools, technical centers, and commercial departments.

Technology is often the carrier of the new, so it is proper that each discipline be permitted to define its own "basic," "contested," and "exploratory" content, distributing technological studies across these three categories as appropriate. Similarly, since the three types of content elicit their own unique methods — lecture, seminar, or personal research — students can access their chosen disciplines through processes with which they are most comfortable. The act of re-thinking these options can, of course, provide the needed opportunity to rather quickly update all disciplines with the new "soft" content which is more oriented to search than certainty but which is no less respectable because of its relativity.

### **Survival Factor #2 — Sanction of the Super Disciplines**

Examine the transcripts of a number of undergraduate college students and the new taxonomies of the super disciplines of

the academic community become readily apparent. Elective clusters in the social sciences, for example, reflect the current societal problems with such entries as "Urban Affairs," "Black Studies," "Women's Awareness," "The Criminal Justice System," "Population Control," "Consumer Law," "The Multi-National Corporation," "Religions of the World," etc. Transitional labels of this discipline are "Cultural Anthropology," "Political Science," "Community Education," "Human Geography," and finally, the even more traditional categories of "History," "Geography," "Economics," and "Sociology." Turn to the sciences and the old and emerging categories once again chronologically appear — "Marine Studies," "Computer Sciences," "Energy Alternatives" at one end of the continuum and "Biology," "Chemistry," and "Physics" at the other.

One way to analyze the emerging patterns in disciplines is to sort out at least three orders of content evolution:

1. Social Problems Applications
2. Multi-disciplinary Studies, and
3. Root Disciplines

Clearly, this poses another "forcing structure" — unless it is to take forever to graduate — in which #3 has to shrink in order to make room for the other two orders. This is just the opposite of what some people mean by "back to the basics." A related problem peculiar to the public schools is a teacher certification affinity for #3 and a tendency for school districts to give teachers specific assignments to the traditional content designations on their licenses rather than to the emerging cross-disciplinary application of knowledge. Elective systems permit some updating as a result of teacher initiative, but the combination of content-committed licenses, school board contracts, and school organization is too much to be overridden by even extraordinary teacher performance.

Organizational remedies are in process of definition at the local school level. These remedies frequently outstrip in creativity anything currently being generated by Colleges of Education or State Education Agencies. Staff organization problems necessitate pragmatic model building for survival purposes; so as always, the place to monitor for future patterns is the local school. Here, one finds a *unique political-academic invention* which permits the "super disciplines" to remain in a healthy

state of self-evolution. Many variations can be found but most represent *delicate compromises between an "organizational model" which makes no academic commitments whatever ("schools within schools," "self-contained classrooms," etc.), and those which overly-specify the "academic" assignment and thereby freeze its normal evolution ("English Department," "Science Program, etc.).* The super disciplines ideally prevent schools from reverting to either exclusively political patterns or long out-of-date commitments to the basic disciplines. An example, lifted from actual practice, now follows in pictorial form, not to induce imitation but to illustrate the option of combining academic and structural factors in the same model to permit new kinds of curriculum planning to emerge comfortably and naturally.

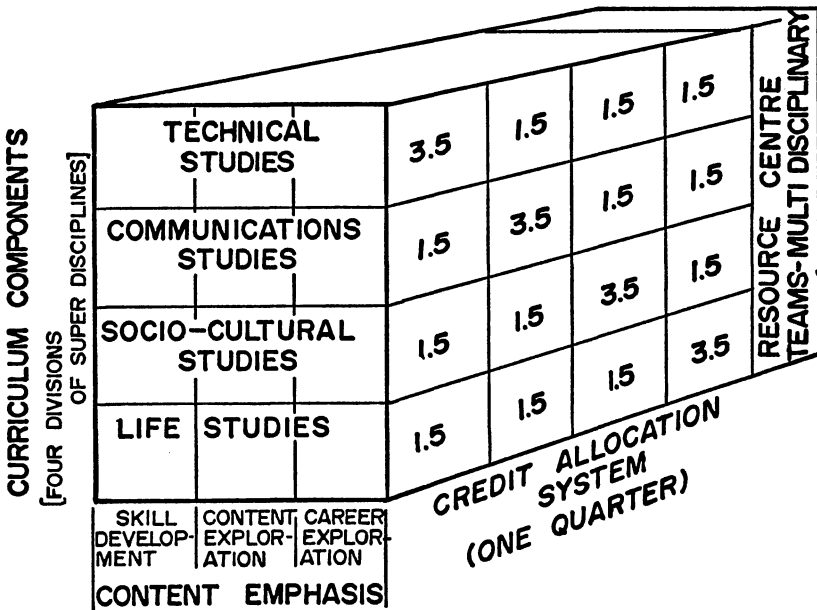

Fig. 1-1. Curriculum Design Components

**Survival Factor #3 — Multiple Entry and Exit Points**

Turnpike planners have no way of knowing how many travelers are going to take the long trip so they arrange for frequent entry and exit points. The driver does not have to get on or off just because the option exists but having once entered is obligated to proceed at least to the next exit. U-turns are not

permitted so every decision must be a serious one even though only a limited commitment is intended.

Schools are like this too. Originally, the educative design had no interchanges; once committed you went for the long journey or you "failed." The modern school calendar, as well as the school day, clearly indicate that the inflexible pattern has been broken. The first breakthrough was the short-term course, still the most popular feature of the open access curriculum. It is important because the randomization of, say, 3-, 6-, and 9-week courses effectively challenges unnecessary content sequences and eventually blocks the worst evil of all, tracking. Another almost hidden, advantage might be called "Project Re-start," after the pattern of "Head Start" or "Home Start." The chance to start over without penalty may be the most important because it can happen over and over again, not just in childhood. Exploration without penalty is most strongly supported when the permanent record accepts no failing entrees — just a "mission accomplished" statement or an "incomplete." Nobody really knows, anyway, when "incomplete" means "permanently withdrawn" or simply "temporarily sidetracked." And, even if the grading system is used for motivation or control, the "standard" still holds because credit is withheld pending project completion.

The equating of the academic task with "missions" indirectly sanctions the "project approach" to teaching. This, in turn, encourages the "engineering" emphasis in everything — the "doing," "applying," "performing side" of the discipline which takes the ultimate form of a tangible "product." Schools have traditionally taught the "fundamentals" first, then illustrated the mastery of fundamentals with the "classics" — citations of the successes of others — and finally, (time permitting) invited the learner to try to create his own classic. Suffice it to say, even when time did not run out for the final phase, motivation did. The "classics" are imposing and the "basics" are long and boring. *The way to get any student past the hurdles of a traditional program always has been to schedule his schooling "upside down and backwards" — that is, "projects first" and yes, "most advanced" first too.* Then, show examples of success by others, and lastly develop personal skills (fundamentals) as the project reveals a need for them. This does not preclude skill introduction on a formal basis but it does tend to shorten the initial

time investment and hasten the exciting day for the learner when he gets to try his own hand as a creator. The idea is as simple as getting the future golfer off of the driving range as quickly as possible, suggesting that he return for needed practice when an actual game reveals his personal weaknesses. Multiple entry and exit points are dependent upon content which is differentiated both in terms of stability and recognition of the super-disciplines. The following figure summarizes the relationships which provide the needed flexibility for truly unique "people paths" to be sanctioned by the school.

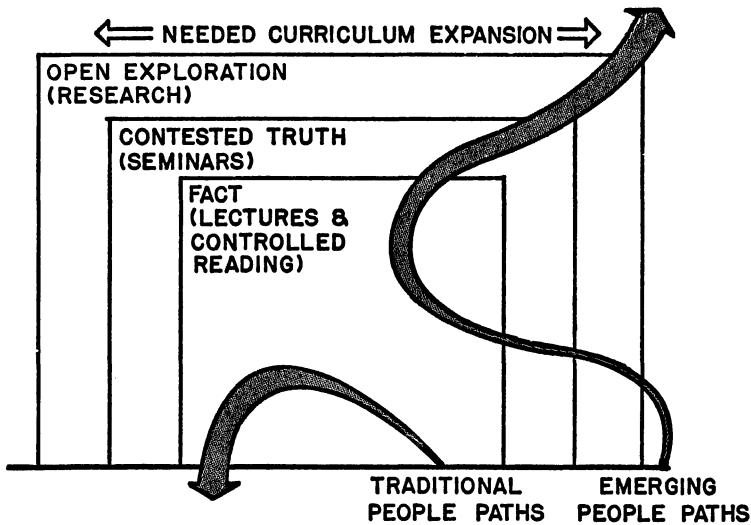

**Fig. 1-2. The Open Access Curriculum**

**Critical Factors:**

1. Multiple rather than single entry points.
2. Increased scope of content.
3. Abandonment of extended sequences and related tracking.
4. Learning styles related to both the nature and the disciplines and the methods of inquiry.
5. Differentiated teacher roles.

**Survival Factor #4 — Separation of the Social Control Function from Learning**

Nothing quite so thoroughly contaminates good teaching as the confusion of police functions with the liberation of the

learner. This is not to argue that learning can proceed from disorder, but it does mean that strategies for pupil discipline are often the antithesis of the best teaching strategies. To "make" the student behave in "socially responsible" ways is an interesting thought to begin with; to say that a "change in behavior" is the evidence that "teaching" has occurred is a common though somewhat frightening idea. "Behavior modification" *may* be the purpose of some legitimate teaching but the amount is probably quite small. The school provides access to tools. It permits learners to examine them, the result being that some tools are judged by some learners to be inappropriate or simply not interesting. No behavior has been modified; no attempt is needed. And, no tragedy has occurred. Others may examine the same tools and develop a friendly attachment to them. Proficiency may follow practice, just as practice follows familiarization. But, again, the goal of "changing student behavior" is an unnecessary defense of the teaching-learning act. The implied manipulation of the learner builds a negative relationship at the outset, later on becoming an authority confrontation if the learner does not begin to change in the preselected ways.

In many ways, the teacher is an efficient "stock room manager"; at other times, he is a "tool salesman" and "demonstrator." He may become a "learning counselor" as his customer selects a tool for personal mastery, and later he may appropriately become a "performance evaluator" as the student needs to know just how much proficiency he has developed.

Throughout the learning process, the "guide" relationship is healthier than that which begins with the behavior modification assumption. As previously acknowledged, there is a place for behavior change; there is also an institutional need for a sensible degree of law and order. But, the bulk of the learner-assistance act is something else and is best *not* permitted to follow the precedents of directive psychotherapy.

#### **Survival Factor #5 — Teachers as Curriculum Contributors**

There is no need to advocate openness for students and deny it to teachers; indeed, it may even be dangerous to do so. The teacher role traditionally expects both too little and too much — too little thinking, planning and creating; too much routine behavior management, repetitive information transmission, and ritualistic advisement. The recession has not helped either. In-



coming teachers are better qualified due to tough-minded recruiting from a labor surplus. Many remaining (e.g., surviving) teachers worry about continued layoffs and protect themselves by toned-down dissent and artificial interest in pleasing the forces of management. Supervision, meanwhile, easily drifts away from the advocacy of openness to the more comfortable role of resource management and personnel evaluation. One of the great intellectual paradoxes of modern education is the tendency for many to see "open access supervision" as a contradiction of terms. The result is a virtual death blow to *both* the revolution of access and supervision. The fully utilized teacher is, of course, the goal which the stalemate pushed beyond attainment.

To date, the "differentiated teacher role" has largely failed, along with teacher "teaming." The reason is that the differentiation has been made along the wrong lines and the resultant assignment of personnel has clustered specialties which were more similar than interdependent. Similarity alone breeds competition rather than reliance upon a teammate's higher level of competence in a specialty. To complicate an already difficult situation, the issue of delegated authority to teams never really achieved resolution either. Only mild persuasion remains after both professional respect and power-sharing fail. And, that is not enough.

"All or nothing" — every teacher a free agent or everyone a production line captive — is a self-limiting remedy, even as a militant union objective. The changing academic disciplines create a part of the problem with everything going multi-disciplinary (and, therefore non-specialized) to some degree. The consolidated arts program seem to be faring best, a kind of determined self specialization providing the reason for respecting the other teacher's right to be different too. Disciplines with heavy technological resource bases, again including the arts along with the sciences, find *distinctive tools to be a good excuse for distinctive roles*. This appears to be the strongest point of departure for arguing the case for increased teacher autonomy. But, even within such favored groups one can easily find people with "dependent life styles" who honestly feel most comfortable and competent with a production commitment as contrasted with a planning or a decision-making obligation. The problem is prob-

ably as simple as *asking teachers what they want their primary contract commitment to be — producing, instructing, counseling, planning* (projects and program development), or *deciding* (regulating, administering) and then working up professional teams with suitable representation from each *functional specialty* (as distinguished from the academic area within which the functional role would be performed). Different types of authority would thus gain recognition which could ultimately be reflected in differentiated schedules and compensation. Under such an arrangement, it would not be inconceivable for some teachers to be paid higher salaries than their administrators. It would all depend upon three factors: (1) functional role preference, (2) academic role, and (3) preparation and experience for the two selected roles. “Merit pay” is not recommended because it tends to politicize rather than professionalize the educational environment.

The logic of a new teacher role always circles back to the original question: *at a time of economic distress is the soundest leadership strategy the one which centralizes and constricts decision-making; or the opposite, which diffuses and shares the concerns of management with teachers?* “Open access” theorists feel that the latter option is best for both the long run and the immediate crisis. Unfortunately, current management trends still equate democratic practice with non-stress conditions and authoritarian regulation with troubled times. In the final analysis, *participatory professionalism for teachers is the only avenue to open access schooling. The hiring of proud autocrats just because the budget is tight is self-defeating.*

### **Survival Factor #6 — Distinctive Resource Collections**

An open access school tends to look somewhat like a supermarket. Its resource collection is more comprehensive than the average school and the physical grouping of the different types of resources reveals what is there to be accessed. The common resource components are:

1. The tool-intensive learnings
  - the shops
  - the studies
  - the laboratories
  - the data processing centers
  - the field-test locations

2. The information-intensive learnings
  - the libraries
  - the academic reading rooms
  - the electronic access terminals
  - the lecture halls
  - the film and TV viewing rooms
3. The interaction-intensive learnings
  - the seminar rooms
  - the theaters
  - the social centers
  - the planning rooms
4. The skill-intensive learnings
  - the gymnasiums
  - the practice fields
  - the performance centers
  - the skill monitoring and analysis centers
5. The reflection-intensive learnings
  - the private offices and studies
  - the retreats
  - the non-scheduled, non-programmed spaces
  - the access routes to the extra-school environment

The resource base of the typical school is nowhere close to the range and diversity implied by the above categorization. Working out access plans involving multiple buildings, and, in some cases, more than one school system helps. And, even if the school's consolidated aggregate resources remain inadequate, it would still be a giant step beyond the self-limiting tradition of the "self-contained" school. The reason is the long tradition of building curriculum designs on the single overriding assumption that learning is a teacher-intensive act. *The open access curriculum continues to access the adult personnel of the school but also makes it both legitimate and easy to access many resources directly as with the use of a student library card.* The up-dated version of the library card, however, will likely be a *general access authorization applicable to each of the outlined categories of resources.* When this happens, the open access curriculum will have become an irreversible trend.

## **STRUCTURED OPENNESS: A SUMMARY**

In summary, the emerging curriculum model is two-faceted, including: (1) the "common market" structure for openness, and (2) the "open access" environmental regulators within

authorized programs. As such, it is utterly manageable, yet non-oppressive, flexible, and affordable. It is a political feasibility as well as an operational value system. It permits extremely diversified programming for individuals including options for intense personal or occupational specialization. Costs are, in turn, held in check by abandoning the "comprehensive school," defined by tradition as a given school, often a single building. With a "school" becoming an *accessible network of services*, involving, as needed, *multiple administrative jurisdictions*, resource duplications are minimized — an especially important consideration for expensive high-technology programs. Another factor almost obscured by the appealing financial picture is the ultimate solution to the student discipline problem: the schools on the upper levels will have the option of simply abandoning custodial oversight and the regulation of student management. This is the highly workable junior college pattern, long overdue for extension to the levels below. Thus, the potential result can be more *specialization* (of resources and personnel), more *personalization* (of student programs), more *freedom of movement* (for everybody), relative *cost reductions* (for the taxpayer), and a significant *decrease in legal vulnerability* (for teachers and administrators). It adds up to a planned extension of access as an alternative to a faltering paternalism — an unparalleled formula for survival in a period of economic distress.

## REFERENCES

Wilson, C. *The Open Access Curriculum*. Boston: Allyn and Bacon, 1971.



*Dr. David L. McCrory*

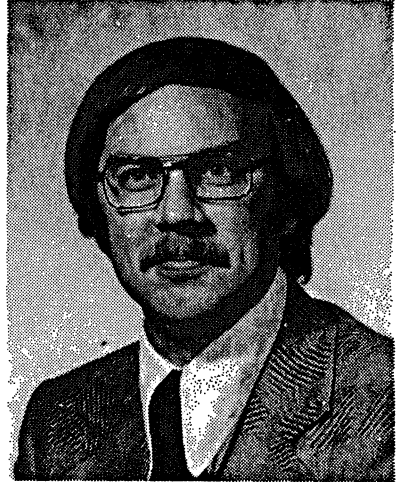

**Dr. McCrory received his Bachelor of Science and Master of Arts degrees in industrial arts from Kent State University and his Doctor of Philosophy degree in curriculum theory from Case Western Reserve University.**

**He has had teaching experience in junior and senior high schools and supervisory experience in an open concept middle school. He is currently Associate Professor and Coordinator of Field Services in Technology Education at West Virginia University, Morgantown, West Virginia, and directs numerous school curriculum development projects.**

**In recent years, Dr. McCrory has served on state task forces on middle school curriculum development and continuing education programs for teachers.**

# The Meaning of Open Access for Industrial Arts Curricula

*David L. McCrory*

*"These are puzzling times for those concerned about the functions and work ways of supervisors, principals, and teachers in the schools. There are many signs that an epoch in education is coming to a close; this means dealing with problems of transition from old, familiar forms of schooling to forms of education that are not yet clearly defined" (Lewis and Meil, p. 2).*

## EVOLUTION AND CONFLICT

Industrial Arts, as a program of study in contemporary schools, is using a process of evolution in search of new curriculum forms. With roots grounded in a Rousseauian concern for children and what they should know and are capable of knowing in order to survive in a complex society, industrial arts may find the concept of open access curriculum well suited to the task of curriculum reform.

In all of education, there continues to be a conflict of ideas about the nature of children and the process of learning on one side of the coin and the ideal structure of knowledge on the other. This saga of controversy over the major curriculum determinants is evident in current proposals for open access curricula because open schooling, in the final analysis, reflects a bias toward child-centered philosophies. A basic conflict becomes obvious, however, when one looks at the history of industrial education, and sees the evolution of a subject area in which structure of content has become the prime curriculum determinant. This paper will argue that the philosophical mismatch between a design for schooling based on consideration for the learner (open access)

and a school subject based upon mastery learning of industrial content (industrial arts) must be resolved if industrial arts is to play a significant role as a course of study in open access schools. Some implications of that conflict will be presented in this chapter.

The conflict of child-centeredness versus subject-centeredness in industrial arts programs is evident in Leslie H. Cochran's study of innovative program (1970). The child-centered influence of John Amos Comenius, Johann Pestalozzi, Phillip Emanuel Fellenberg, and Frederick Wilhelm Froebel is well recognized by those who have seriously studied the history of industrial education. The shift from the manual training movement of the 1880's to the manual arts concept of the turn of the century signaled a changing philosophical base. With the split between vocational education and industrial arts at the quarter-century mark, the ideological differences became even more apparent.

## CURRICULUM TRENDS

In recent years, however, there has developed a gradual but persistent trend as industrial arts has turned away from an earlier emphasis on the child, and is now heading along a path toward a new emphasis on structure of the content. Evidence of the change may be seen by reviewing past issues of professional periodicals such as *The Industrial Arts Teacher* and *Man/Society/Technology*, yearbooks of the American Council of Industrial Arts Teacher Education and proceedings of the annual conferences of the American Industrial Arts Association. But perhaps the most telling indicator of current curriculum emphasis is represented by a published rationale for the Industrial Arts Curriculum Project (IACP). The IACP rationale states that: "It is generally recognized that the central question involved in bringing about a major change in industrial arts education is the question of instructional content" (p. 1). The 22-page document goes on without a single reference to the nature of children or the process of knowing. The current trend follows a course parallel to that of science and mathematics in a post-Sputnik thrust of subject-centered curriculum development. Perhaps the time has come for a shift back to concern for the learner.

A basic premise of this paper is that curriculum designs for subjects within a school program should be logically, psycho-



logically, and philosophically consistent with that of the total school program. The current emphasis on structure of the content for industrial arts is thus a serious matter and deserves attention. If the child-centered ideas generated by the open school movement persist, and if "innovative" curriculum proposals for industrial arts continue to be primarily concerned with structure of the content, then a philosophical mismatch will occur and the value of industrial arts as a part of open access schools must surely be subjected to questions.

## CURRICULUM THEORY

It may be helpful at this point to examine a particular conceptual framework on which this paper is based. Earlier, the idea of an "open access" curriculum design was introduced. It should be understood that a curriculum is related to a curriculum design, but the two are not the same thing. "A curriculum," as the term is most commonly used, refers to a set of intended learning experiences (McCrory, 1974). It is a preactive plan that specifies curriculum content and process and leads to the active stage normally called "instruction." A curriculum *design*, on the other hand, identifies the philosophy, rationale, and underlying conceptual structure on which the curriculum is based. This scheme is represented in Fig. 2-1. Unfortunately, it is the curriculum *plan* which is most often explicated in school program proposals, while the curriculum design sometimes remains implicit.

Curriculum theories, differing from theories in the "hard" sciences, are not scientific in nature but are more properly considered philosophic and analytic. George A. Beauchamp, in his classic primer on curriculum theory (1968) defines it as a sub-theory of education, consisting of a set of related statements that give meaning to school curriculum by pointing up the relationships among its elements. As such, curriculum theories work along with theories of evaluation, administration, counseling, and instruction in guiding the activity of schooling.

The concept of curriculum embodies two different emphases. In some contexts the term "curriculum" refers to knowledge, skills, and attitudes intended for students to acquire as a result of schooling. There are other contexts where the term is used

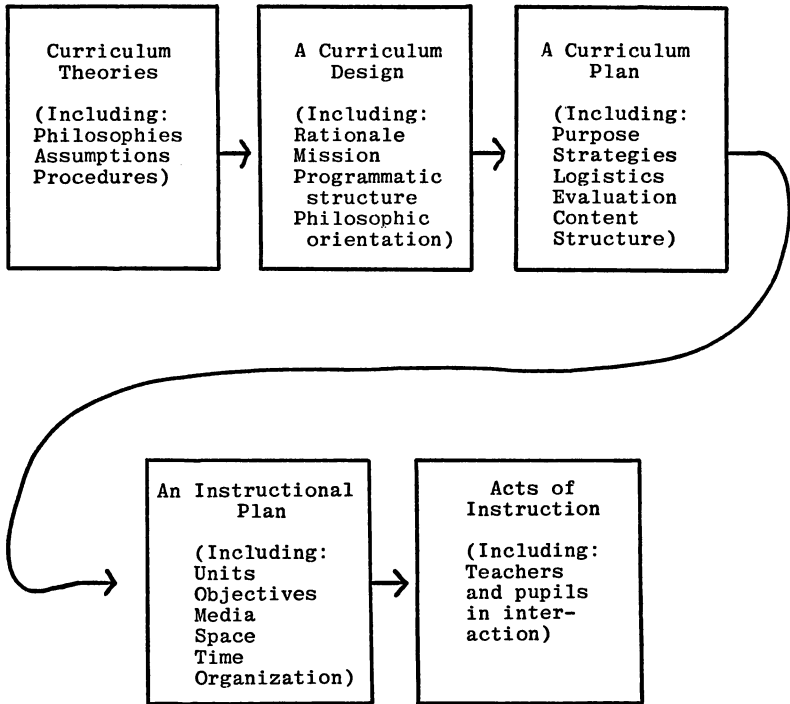

**Fig. 2-1. A Schema of Program Planning.**

to indicate what is to be involved in the teaching/learning process. This distinction is embedded in the linguistic contrast between curriculum as a plan for *what* students are to learn, and plans for *how* the learning will take place. It is the first of these meanings of the concept of curriculum that has dominated recent curriculum development efforts in industrial arts.

Curriculum development would be less complex if there were only one level of activity, but in reality the process continues at several levels as indicated in Fig. 2-2. A design for an industrial arts program, as a specific subject curriculum, exists within a larger design, normally at the school building level. In turn, building-level curriculum designs are usually intended to be consistent with the philosophic orientation of the larger system. It is at the building level where a breakdown of integrity could occur if a specific industrial arts program is designed to be at odds with the philosophy and rationale of the total school operation.

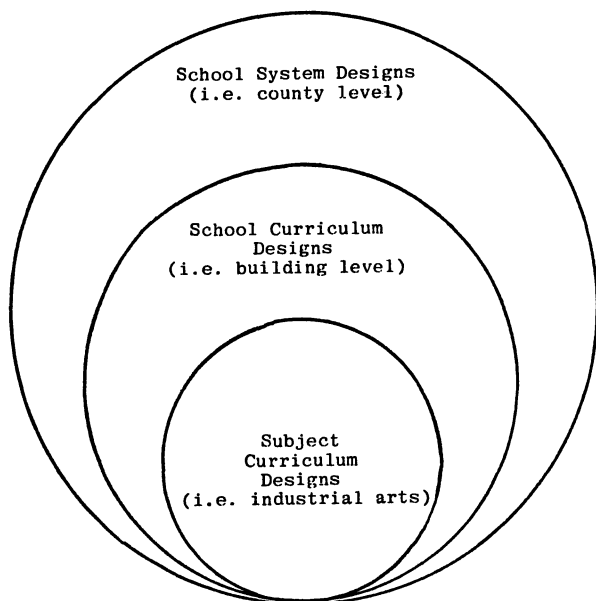

**Fig. 2-2. Levels of Curriculum Designs.**

## **CURRICULUM DESIGNS**

Curriculum designs are generally recognized by their central emphasis or by the priority given to one of three references: subject matter, social phenomena, or learners. A design that assigns top priority to learners implies a certain value position. A design that assigns arrangement of subject matter or structure of the discipline top priority must begin at a different point of departure in the curriculum development process than a design based on psychology of the learner. The point here is that an industrial arts program designed from a "structure of the discipline" philosophical base would likely be incongruous in an open access school.

Among current thinking in the industrial arts profession there are several viewpoints of how content for industrial arts programs should be structured. One camp believes that content should be structured logically, as derived from the content reservoir (either industry or technology). Such logical derivation is evidenced by a very careful taxonomic structure. The designers are usually academically inclined and are often leaders

in industrial arts teacher education. Their language is often couched in talk of "concepts" and "conceptual statements."

One of the arguments presented by proponents of subject-centered curricula is that there is a certain structure of the content base, whether it be defined as industry, as do Don Lux and Willis Ray for the IACP curricula, or as technology, as does Paul DeVore in his West Virginia University proposal. This argument proceeds along the line that there is a structure to be rationally derived for any school subject and, by implication, the structure is also to be presented in that fashion to students. This epistemological orientation to curriculum design holds that for too long the industrial arts profession has avoided the examination of its content, in favor of mucking around with various learning activities, equipment, and materials.

An additional justification given by those who tend toward knowledge as the predominate feature of industrial arts curriculum designs is that given a strong, rational structure of content in the curriculum, it will be adjusted by teachers to specific school organizations and specific learners. This ontological approach puts a high degree of control and yet a very great burden on those who must implement industrial arts programs in an open access setting.

The intent of such industrial arts curriculum designs seems to be largely to produce "little industrialists", "little technologists", or even "little researchers and developers" as in the case of Maley's R&D approach.

James Macdonald (1971) suggests this "control function" is one of three basic intents of curriculum designs; the other two, he calls the "consensus" and the "emancipation" models. They are worthy of examination here in order to shed some light on precedents and promise in the field of industrial arts.

### **Control Designs**

Curriculum designs based upon a "control" interest can be associated with the subject matter or structure of the disciplines approach exemplified by Benjamin Bloom and Jerome Bruner (1966). The central notion in this approach is that programs of curriculum and instruction should stress the underlying processes of each field of inquiry. The "alphabet soup" curricula of the 60s, including PSSC physics (Physical Science Study Com-

mittee), SMSG (School Mathematics Study Group) mathematics and the IACP (Industrial Arts Curriculum Project) curriculum are examples. Control-oriented curriculum designs seem to be oriented to the production of little physicists, little mathematicians, or little industrialists. The IACP curriculum design is a case in point. From the structure of content right through the classroom and laboratory activities, the manufacturing and construction curriculum for the junior high school is clearly intended to produce students who can "do" manufacturing. Even Maley's research and experimentation approach seems to be oriented to training students, especially the more academically capable, to be able to "do" research and development. Perhaps even DeVore's discipline of technology approach is intended to produce little technologists.

The intent here is not to denigrate the fine contributions these curriculum development efforts have had on the profession, but to question whether they will be adequate for schools dedicated to precepts of open access.

### **Consensus Designs**

Consensus curriculum designs are ones developed primarily to bring about the resolution of social problems or issues. Central orientation is toward "practical" knowledge rather than theoretical concern for the discipline, and the concept of pragmatism is sometimes associated with it.

John Dewey, in the Progressive School era of 1910-1950, saw consensus curriculum designs planned and implemented in the schools. Several philosophers and school leaders have been influential in the development of consensus designs, including Harold Rugg, William H. Kilpatrick, and William James. And, of course, it was during the heyday of the progressive movement that George S. Counts asked, "Can the schools build a new social order?"

Much of the career education movement initiated by former U. S. Commissioner of Education Sidney Marland is closely tied to this orientation. Often associated to industrial arts by laymen, career education programs provide a response to perceived problems of young people trying to cope in an increasingly complex society. At least one historical account (Spring, 1976) reports that the multi-million dollar federal expenditure in 1971-72 for

development of career education programs was intended to represent Maryland's solution to student rebellion, delinquency, and unemployment.

Many school programs of industrial arts have, in the past few years, begun to emphasize certain career development aspects. One wonders, however, if those who are in charge of the programs agree with or are even aware of the philosophical bases of their curricula.

### **Emancipation Designs**

A third type of curriculum design is based on the emancipation of students. Often called person or child-centered, emancipation designs are oriented to free learners from perceived limitations so as to fulfill their individual potential. Many of the "humanistic" curriculum proposals of this decade are associated with this design type.

Abraham Maslow (*Toward a Psychology of Being*) and Carl Rogers (*Freedom to Learn*) have been influential as sources of assumptions and rationale for emancipation curriculum designs. There is also a degree of existentialist philosophy (e.g. Kierkegaard, Sartre) involved in the philosophical positions represented by this curriculum orientation. Traditions of democracy are related to emancipation designs as they are implemented in schools, and many American open school philosophies are based upon these precepts.

There have been some curriculum proposals in this decade, most notably those by Delmar Olson (1963), that are dedicated to emancipation of students. Olson's approach leans heavily on identification of the structure of industry. Maley's anthropological approach, if one examines his emphasis on suggested procedures for student research activities, may be the major example of a child-centered curriculum orientation in the industrial arts field today.

At this point we have explored the current subject-centered orientation of industrial arts, and have compared it to some alternative curriculum designs, including one oriented to the child as central curriculum determinant. The open access curriculum approach is a recent child-centered school organization to which this yearbook is directed. We turn now to that concept.

## OPEN ACCESS AS OPEN EDUCATION

The idea of an open access curriculum is a specific kind of design for schooling related to the larger notion of open education. Although open access denotes a more definitive type of open education, it is important to examine some generalizations about open education that influence thinking about the concept of open access.

### From the Beginning

Grounded in the philosophy of Rousseau, Froebel, Dewey and Pierce, the idea of open education began to make its mark in 1920, when Sir Henry Hadow was commissioned by Parliament to study and report on the state of elementary education in Great Britain. The Hadow report urged that more experimentation be done, especially in the early childhood grades, to search for alternatives to the rigid discipline standards of the primary schools.

During World War II, parents in the major industrial areas of Great Britain sent their children to the country to escape nightly bombardments of the cities. The resulting mix of wealthy children from private schools and poorer children from public elementary schools, under already trying circumstances of war-time, gave teachers severe discipline and motivation problems. After attempting various methods to get the children to sit quietly and listen, some teachers became frustrated and gave up. Others began to rethink their theories and to experiment with the informal methods of schooling that had been tried in Great Britain on a small scale years before.

In 1967 the British Parliament commissioned another study of public schools, this one headed by Lady Brigit Plowden. The three-year study included middle class schools, poor and mixed urban schools, new schools with open spaces and old dilapidated schools with pupil-teacher ratios of 40 to 1. The Plowden Report, "Children and Their Primary Schools," described the new informal education methods in terms of what they meant to the children: "The school sets out deliberately to devise the right environment for children, to allow them to be themselves and to develop in the way and at the pace appropriate to them." Continuing in an optimistic vein, the report spoke of curricular

issues: "It insists that knowledge does not fall into neatly separated compartments and that work and play are not opposite, but complementary. The philosophical base of informal education was implied in the report with the statement that "A child brought up in such an atmosphere . . . has some hope of becoming a balanced and mature adult . . ." (NSPA, p. 11).

The Plowdon Report concluded that informal education was the best thing to happen to British primary schools in perhaps a century and that extension of the movement should be encouraged. In 1967, a series of articles by Joseph Featherstone in *The New Republic* got the attention of Americans by summarizing the Plowden Report and promoting the idea that was becoming known as the "open education movement." This came at a time when social criticism of institutions was predominant and a round of critics, including Jonathan Kozol (1967), Edgar Friedenbergr (1963), and Paul Goodman (1960) were chastizing public schools in America for being locked in a mindless bureaucracy of teacher-dominated methods designed to subordinate the needs and wants of children.

## THE COUNTER-REVOLUTION

At the time this yearbook is written, there is evidence that the pendulum of public concern has swung toward a more cautious retreat from the explosive political, economic, societal, and educational ideas of the 60's. The popular press now cites examples of a "back to the basics" movement, and suggest that one ideological extreme has been exchanged for another, although more conservative.

And yet, there is also evidence, obvious to those who regularly visit schools, that classroom practice has not kept pace with the creation of theory. The bureaucracy of schooling does not change quickly. School people have a way of bending with the wind, only to return to a comfortable position after the storm is over.

Nevertheless, the spirit of openness, flexibility, and experimentation born in the 60's has had its effects. A new generation of instructional materials has appeared on the market, to be touted as "fun," "relevant," "hands on," and "individualized." School building design now features more flexible space as the



egg-crate school joins the passing of the cornice. Museums have become educational centers where children can spin wool, grind corn, and engage in the kinetic activity of discovery that is an important part of the idea of open education. Perhaps the most important legacy of the era is a growing recognition of opportunities outside the school building as legitimate learning experiences. Philadelphia's Parkway School, for example, has become a model of this "school without walls" concept.

Current discussions of "mainstreaming" emotionally disturbed and handicapped children sound familiar to advocates of open schools as does "schools within schools" or "house plan" ideas now identified as solutions to the impersonal nature of many large schools. All this, and yet the "news" carries accounts of bookburnings and right-to-read programs. It might be said that the open education movement has gone underground. But it may be more accurate to say that the innovation has been given the ultimate tribute — it has been coopted by the system. The concept of openness is still very much in the mainstream of curriculum thought.

## **OPEN ACCESS AND THE CONCEPT OF OPENNESS**

Brian Hill (1975) identifies a continuum of usage of the term "open education," in which there are two polar extremes of emphasis. On one hand, there is a *procedural openness* which is a commitment to allow teachers and students freedom to select and use alternative ways to preconceived objectives. That is, in an open school teachers and students may be acting somewhat differently than in traditional schools, although the objectives may be the same. Open school industrial arts teachers in this context often give students options to choose projects and procedures that will likely result in preselected skills and understandings. In contrast, students in traditional industrial arts programs are often assigned to predetermined tasks, with little or no variation allowed. With this conception of openness, "open school" programs are most like traditional programs in that the distinction of instructional methods shade together at times. Industrial arts programs, as they currently exist in "traditional" schools, would thus require little change in order to be consistent with open school philosophy.

At the other pole of meaning lies a conception of openness that poses problems for those who profess allegiance to traditional curricular syntax. The idea of *normative openness* goes beyond consideration of teaching methods to include student participation in determining the structure of the content itself. Those who interpret open education in this sense would reserve the right and responsibility of students to determine the *what* as well as the *how* of learning. One of the trends in secondary schools, especially in the volatile era of the 1960s, was to provide for an array of optional courses for students who were more inclined to study yoga, rock music, and transcendental meditation than algebra. In extreme cases, some students were allowed to choose whether they would study any of the traditional subjects at all. Industrial arts teachers who believe in the worth of their courses would not likely be in agreement with that kind of option, but even the more conservative among them might agree that some amount of student participation in content selection is desirable. This latter approach is one that may be necessary if industrial arts is to play a supportive role in an open access curriculum.

A third meaning of openness is sometimes used by those who propose alternatives to the schooling process itself. This revolutionary sense of the word often comes into play in discussions of the neo-Marxist view of a need to accelerate social change by giving the "oppressed" socio-economic classes more control over their own education. George Dennison (1969) and John Holt (1969) use this interpretation in calling for a radical revision of schooling. This is a radical view of open education, however, and will not likely hold any significant implications for the field of industrial arts.

If, then, industrial arts is to fit with open schools in the "procedural openness" sense, then there are several alternatives open to those engaged in curriculum development. First, since open schools dedicated to the more limited concept of procedural openness intend to achieve the same ends as traditional schools, then any number of traditional industrial arts programs of content and structure will do. There can be, however, a variety of instructional plans such as the research and experimentation approach, the unit plan, the project plan, and many others. The point is that the ideal industrial arts curriculum for an open

school in the first sense would be one that allows for a variety of instructional means intended to result in an accepted set of learnings. The major responsibility of curriculum developers, then, would be to develop and test alternative learning experiences and teaching methods, as well as structure of the content.

In an open school in the second sense, one that subscribes to normative openness, an appropriate industrial arts program would be one with few predetermined goals for students, except those intended to capitalize on student interests. It would include many options in content areas as well as in learning activities. For example, if a specific student should be motivated to construct a helium neon laser, and was capable, then he would be permitted to do so. For the industrial arts curriculum developer, the challenge under these circumstances would move from a concern for predetermined structure of the content, to a greater concern for providing access to the accumulated knowledge, skills, and attitudes and the means for students to acquire them. Industrial arts in this latter sense would truly be an open access curriculum. However, if such curriculum designs are to become a reality, then there is much work to be done.

## **OPENNESS AND CURRICULUM**

Although the open access and open education may be defined in various ways, the concept of openness remains central.

Along with experimentation of temporal/spatial considerations and teacher/student groupings, curricular aspects have also undergone change in the 60's and 70's. Alexander Frazier, a past president of the Association for Supervision and Curriculum Development, identifies a continuum of recent curriculum proposals that have received impetus, at least in part, by the recent interest in open education (1972). On one end of the continuum there are curriculum proposals that call for a "free-as-free-can-be" approach where students and teachers cooperate as partners in curriculum building. These proposals come from those who have had poor experience with the traditional authoritarian methods of predetermining school and subject curricula. Trust is the ultimate issue, and proponents of this model of curriculum believe that there are important lessons to be learned

in responding to the wishes, wants, and expressed needs of learners regarding the ends, as well as the means, of schooling. Perhaps it is fair to note that such proposals normally find greatest favor among the established, upper-middle socioeconomic class parents often found in the suburbs of America. In contrast, struggling minority group parents in urban areas often are skeptical of proposals in which the promise of achievement of "basic skills" seems weak. Recent curriculum proposals for industrial arts programs based on research and experimentation or research and development have characteristically been better received in suburban schools than urban or rural, for the same reason. There are not many industrial arts curriculum proposals in this category, possibly because of the trade-training background of many members of the profession.

At the other end of the continuum, there are curriculum proposals arising out of an approach toward "new formalism." Among the proposals are those taking a new look at what learning is "fundamental." Proponents in the new fundamentalist camp would have schools wholly concern themselves with, or at least emphasize, what is necessary to know and be able to do in order to function in the world. Several programs proposed for industrial arts in the 60's clearly fall into this category. The Industrial Arts Curriculum Project (IACP) and the American Industries Project (IAP) were variations on this theme. Each was an attempt to rethink the fundamentals of school programs intended to prepare youngsters for useful lives in a future presumed to be technological in nature.

## **CURRICULUM DEVELOPMENT FOR OPEN ACCESS**

As the evolution of industrial arts curricula continues, the most important factor influencing the resulting design may be the manner in which the design process is accomplished. O'Hanlon (1974) describes three contemporary process models used in the development of curriculum designs. They are the management model, the systematic model, and the open access model. From an analysis of the models we can see some important implications for future curriculum development efforts in industrial arts.

### **Management Model**

The management model of curriculum development is the most widely used today. It is a hierarchical structure of decision-making with a school administrator or subject matter expert as the top authority on all curricular decisions. Goals are usually stated in terms of what the school will do for (or to) the learner.

This model is related to, and most appropriate for, development of control-oriented curriculum designs mentioned earlier. Curricula developed on this model sometimes involve nationally-recognized persons or teams, and then are passed along to the schools to be implemented (Goodlad, 1964).

The management model of curriculum development should sound familiar. Macdonald (1971) calls it the "linear-expert model." The model has been the dominant procedure for developing school programs since the turn of the century. From his study of the formative years in the curriculum field, Kliebard gives this historical perspective:

The picture that emerges from the apparently frenetic educational activity during the first few decades of this century seems to be one of growing acceptance of a powerful and restrictive bureaucratic model for education which looked toward the management techniques of industry as its ideal of excellence and source of inspiration (1971, p. 74).

Mary Louise Seguel (1966) notes that the trend toward efficiency began about 1900, peaking perhaps by the end of the first decade. John Franklin Bobbitt (1918) is usually credited with beginning the era of "scientific" curriculum development. Bobbitt was influenced by the work of Frederick Winslow Taylor (1911) and his study of a worker he called "Schmidt" at a Bethlehem Steel plant.

It occurred to Bobbitt that the fundamental tasks of management in industry were similar to those in schools. Using industry as his controlling metaphor, he considered the school a factory, the child the raw material, the ideal adult the finished product, the teacher an operative, the supervisor a foreman, and the superintendent a manager. The whole process of schooling was to be controlled by the science that would produce the end product. The method of developing the curriculum was to be based on task analysis. To Bobbitt, that meant a study of life itself, and the characteristics needed by adults to live.

Though temporarily overshadowed in the 1930s and 40s by the child-centered ideals of the Progressive era, the bureaucratic

approach to curriculum theorizing may be in a period of revival. Jim Popham's Instructional Objectives Exchange now makes possible the purchase of thousands of behavioral objectives that were David Sneddon's dream in the 1920s.

Ralph Tyler's course syllabus from the University of Chicago (1950) built upon the management model by identifying the curriculum development procedure of identifying objectives, selecting content and teaching strategies, specifying logistical considerations, and, finally, evaluation based upon the objectives. The "Tyler Rationale" is virtually the working model for school curriculum development today.

The significance of the management or bureaucratic model is summarized by Kleibard:

The bureaucratic model, along with its behavioristic and technological refinements, threatens to destroy, in the name of efficiency, the satisfaction that one may find in intellectual activity. The delight in intellectual activity is replaced by a sense of urgency. The thrill of the hunt is converted to an efficient kill. The wonder of the journey is superseded by the relentless pursuit of the destination. And to condition the victim to enjoy being conditioned is certainly less humane than open coercion or bribery (1971, pp. 91-92).

Certainly, the Taylor anecdote and the model of curriculum development process should be familiar to industrial arts educators. As has been noted above, it has been this "trade analysis" approach to curriculum development which has single-handedly controlled program development over the years in the entire field of industrial/vocational education. It was precisely this model that was used to develop the major science and industrial arts projects of the 60s. Pointing again to the Industrial Arts Curriculum Project (IACP), one can see that the curriculum design evolved from the research and development of a handful of subject matter specialists, most residing at Ohio State University. With the structure of the content arranged and a series of learning activities devised, the curriculum was tested and revised to achieve a measure of practicality under real-school conditions. It should be noted, however, that the basic structure of content was not measurably altered from the original design. The basic assumptions behind the content structure, and even the applicability for certain age levels, was not changed. After field testing, a series of teacher workshops was then offered to

prospective users who were in turn trained to implement the design. The basic point here is that a design such as the IACP plan, formulated however rationally, is limited by the process of development to remain less than appropriate for open access schools.

### **Systematic Model**

There is another model of curriculum development somewhat related to the management model. The systematic model of curriculum development is grounded in behavioristic psychology. It depends largely on precisely-stated purposes for its direction. No central management figure exists, but decision areas are specified according to need, much as is the practice in business and industry. As the process evolves, the curricular purposes are established and a sequence of strategies and tasks are identified to achieve the purposes. Planning techniques such as Program Evaluation and Review Techniques (PERT) are used for documentation and control of the process.

Systematic curriculum development is unique among the models of development, in that no particular curriculum design, or philosophic orientation need be assumed, except that of efficiency. In that regard, the model is associated with the mentality of school operation Callahan (1962) calls the "cult of efficiency."

Because there are not clear cases of the systematic curriculum development model being used on large-scale industrial arts curriculum development projects, it is difficult to tell what form the resulting curriculum designs might take. However, because of some basic assumptions regarding the nature of the process, it would seem logical to deduce that the model would be most appropriate for developing curriculum designs oriented to social problems, rather than child-centered concerns or to subject-centered designs.

### **Open Access Model**

The humanistic tradition in philosophy and psychology influences the open access model of curriculum development. In strong contrast to the top-heavy management model, it operates on the premises of participatory democracy (O'Hanlon, 1974; Wilson, 1971). All players in the game of schooling are potential curriculum decision-makers. Leadership is situational, with a great deal of freedom to try-it-and-see. Decisions are open to recon-

sideration at any time. There is no preconceived, unified curriculum structure. The intent is not to force consensus, but to allow for all to have input into shaping the curriculum. Criteria for success of the curriculum are based upon stated values about knowledge and the process of knowing.

Macdonald (1971) offers another description of a similar curriculum development approach he calls the "dialogical model." The curriculum emerges from dialogue between those who are developing the curriculum and those who are to be affected by it (teachers and learners). As such, the model calls for a matching of needs and interests with resources. It may be that this is the most salient point of the open access curriculum design. It would seem, then, that a curriculum design (open access) that is oriented toward emancipation of learners would most likely result from a curriculum development procedure similar to that described above.

There have been no major industrial arts curriculum development projects in which the open access model was used. However, it would seem that if industrial arts programs are to fit into open access schools, then this model for development is one that shows great promise.

## CONCLUSION

This paper began with the premise that a philosophical mismatch now exists between the predominately subject-centered orientation of contemporary industrial arts programs and the child-centered emphasis of open access curriculum proposals. It was shown that industrial arts curriculum theory parallels the structure-of-the-discipline approach prevalent in the sciences and mathematics since the 1960s. A rationale was posited, calling for philosophical consistency between industrial arts curriculum designs and the larger school programs within which they must operate. Several curriculum design perspectives were also cited, with implications for curriculum development activity in industrial arts. The background of the open education movement was examined and was found to have given birth to some ideas about schooling which hold potential for industrial arts to break out of its current bureaucratic mode of curriculum orientation. The core idea of openness was analyzed for implications for develop-



ment of open access curricula. Finally, several models of curriculum development were explicated for their potential impact on curriculum designs.

One thing appears quite clear at this point — if the field of industrial arts is to relate at all to future concepts of open access schooling, it must break out of the “trade analysis” mentality that dominates today’s curriculum approaches. Those who are currently active in curriculum leadership appear to be at odds with the philosophical roots of industrial arts as a child-centered portion of public schooling.

In the final analysis, the open access curriculum approach is a curriculum design for open schooling. Open schooling is a pluralistic concept — of differing forms, perhaps — but certainly grounded in defensible ethical and moral position. As local communities grow more pluralistic in the years ahead, there will be a trend toward alternative curricular programs. The political right will have their “back to the basics” programs and the political left will have their open classrooms, flexible scheduling, and optional mini-courses. Here is where the idea of open access will flourish, and it is here where industrial arts will stand or fall as each group struggles for limited resources for its brand of schooling.

## REFERENCES

- Beauchamp, George A. *Curriculum Theory*. 2nd ed. Wilmette, Illinois: The Kagg Press, 1968.
- Bloom, Benjamin S., ed. *Taxonomy of Educational Objectives: The Cognitive Domain*. New York: David McKay Company, Inc., 1956.
- Bobbitt, Franklin. *The Curriculum*. Boston: Houghton-Mifflin Company, 1918.
- Bruner, Jerome S. *Toward a Theory of Instruction*. New York. W.W. Norton and Company, Inc., 1966.
- Callahan, Raymond E. *The Cult of Efficiency*. Chicago: University of Chicago Press, 1962.
- Cochran, Leslie H. *Innovative Programs in Industrial Education*. Bloomington, Illinois: McKnight Publishing Company, 1970.
- Dennison, George. *The Lines of Children*. New York: Random House, 1969.
- Frazier, Alexander. *Open Schools for Children*. Washington, D. C.: Association for Supervision and Curriculum Development, 1972.

- Friedenberg, Edgar Z. *Coming of Age in America*. New York: Vintage Books, 1963.
- Goodlad, John I. *School Curriculum Reform in the United States*. New York: Fund for the Advancement of Education, 1964.
- Goodman, Paul. *Growing Up Absurd*. New York: Vintage Books, 1960.
- Hill, Brian V. "What's 'Open' About Open Education," *The Philosophy of Open Education*. Edited by David Nyberg. Boston: Routledge and Kegan Paul, 1975.
- Holt, John. *The Underachieving School*. New York: Pitman Publishing Corporation, 1969.
- "Industrial Arts Curriculum Project Rationale: A Brief Description." Columbus, Ohio: The Ohio State University, September, 1968.
- Kleibard, Herbert M. "Bureaucracy and Curriculum Theory," *Freedom, Bureaucracy, and Schooling*. Edited by Vernon F. Haurbrich. Washington, D. C.: Association for Supervision and Curriculum Development, 1971.
- Kozol, Jonathan. *Death at an Early Age*. Boston: Houghton-Mifflin Company, 1967.
- Lewis, Arthur J. and Alice Miel. *Supervision for Improved Instruction*. Belmont, California: Wadsworth Publishing Company, Inc., 1972.
- McCrorry, David L. "The Concept of Curriculum Theory: An Analysis," Unpublished Ph.D. dissertation. Cleveland: Case Western Reserve University, 1974.
- Macdonald, James B. "Curriculum Theory," *Journal of Educational Research*. 64, no. 5 (January, 1971), 196-200.
- Maley, Donald. "Research and Experimentation in the Junior High School," *The Industrial Arts Teacher*, 18 (March-April, 1959), 12-17.
- National School Public Relations Association. *Informal Education*. Arlington, Virginia: The Association, 1972.
- O'Hanlon, James. "Three Models for the Curriculum Process," *Curriculum Theory Network*. 4, no. 1, 1974.
- Olson, Delmar W. *Industrial Arts and Technology*. Englewood Cliffs, New Jersey: Prentice-Hall, Inc., 1963.
- Seguel, Mary Louise. *The Curriculum Field: Its Formative Years*. New York: Teachers College Press, Columbia University, 1966.
- Spring, Joel. *The Sorting Machine*. New York: David McKay Company, Inc., 1976.
- Taylor, Frederick W. *The Principles of Scientific Management*. New York: Harper and Brothers, 1911.
- Tyler, Ralph W. *Basic Principles of Curriculum and Instruction*. Chicago: University of Chicago Press, 1950.
- Wilson, L. Craig. *The Open Access Curriculum*. Boston: Allyn and Bacon, Inc., 1971.



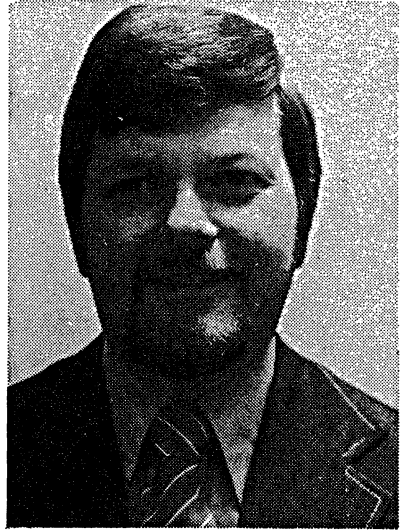

*Dr. Ronald D. Todd*

Ron Todd is currently the Chairman of the Department of Technology and Industrial Education at New York University. He received his Bachelor and Masters degrees from Kent State University at Kent, Ohio, the Doctor of Philosophy degree from Case Western Reserve University in Cleveland, Ohio.

He has been active in facility, equipment and curriculum design and innovation for more than fifteen years. He has authored numerous professional articles and contributed to the 25th Yearbook of ACIATE. He is currently involved in several funded curriculum development and management projects and is director of the Education Professional Development program at New York University. His newest project is to utilize a flexible equipment and facilities approach with schools and industries in emerging countries.

# Learning Environments for Industrial Arts

*Ronald D. Todd*

## INTRODUCTION

Our present state of development in using research results in planning industrial arts facilities does not reflect what is known about people and how they interact with each other and their environment. We appear to have focused most of our attention on space arrangement to the neglect of human factors. Our efforts have been well intended. Many of us in the profession have spent considerable time in looking for innovative ways in which our facilities could be arranged to better support new curricular programs. Much of our effort, however, seems to fold back upon itself with little apparent payoff. This does not mean that the energy expended was wasted — quite the contrary. In Perkin's view, such effort “. . . is the surface symptom of questing attitude for physical expressions of the learning environment” (1972, p. 15). Our energies may well have been misdirected, with too much attention given to the manipulation of the objects within the physical environment and too little attention to the more pervasive and even more important concerns. Indeed “. . . we tend to overlook the influences of the form of a building on the people in it” (Hall, 1969, p. 183).

The one eternally new idea that has received scant publicity and even embarrassed apology from architects and educators alike is the quality, the appropriateness, and yes, the beauty of (the) environment for the learning and teaching processes (Perkins, 1972, p. 15).

The intent of this chapter is to turn attention to learning environments and their role and potential in affecting humans and what that might mean for those in industrial arts who work

as facility designers and instructional managers. To these ends the chapter will describe three major concepts related to learning environments for industrial arts. These include:

1. the conceptual foundations of factors affecting humans as they function and interact within environments,
2. an approach to environmental design with implications for industrial arts facilities and facility designers and,
3. the management, planning and use of learning environments.

## CONCEPTUAL FOUNDATION AND DIMENSION OF LEARNING ENVIRONMENTS

One problem in developing a conceptual foundation for any area of concern is to determine a structure that will hold all the necessary parts together and allow an adequate treatment of those parts and their relationships. This problem is accentuated for areas of explorative and transitional knowledge, that is — a field of study that has a minimum of stability and a maximum of introspective endeavors. Such is the case with learning environments. To facilitate the treatment of this subject a definition of learning environments is stipulated, a set of key elements of that definition is identified and defined and finally, the interrelationships of those elements are explored. The result of this effort will be a conceptual foundation of learning environments adequate at least for our concerns here.

As a step toward a usable definition of the concept learning environment, let us first consider a definition of each term separately. A common definition of learning is held to be “. . . an act of gaining information, knowledge and skills,” while environment is defined as “. . . all the conditions, circumstances and influences surrounding, and affecting the development of an organism or group” (Webster, 1967). Obviously, these terms relate to our arena of interest but are too expansive to be of much help. Therefore, the following definition is stipulated and will be used throughout this chapter: “*Learning environment*, the collective social, physical and technical setting in which teachers, teacher agents and students interact with instructional objects for purposes of gaining and sharing skills, knowledge and attitudes.”

Central to this definition is the idea of coexisting social, physical and technical dimensions of learning environments

which will be discussed in detail. Within the three dimensions are found people and objects. The people include *teachers* as those individuals who assume instructional roles toward other individuals (students may also assume such roles and become teachers) and *students* as those individuals who assume recipient roles during instructional actions (teachers may also assume such roles and become students). *Teacher-agents* are special interactive devices that assume aspects of the instructional roles of teachers (a tape recorder could be used as a teacher-agent). The instructional objects include machines, materials, tools and media that serve as the "stuff" used by students, teachers and teacher agents during the teaching/learning act.

The three coexisting dimensions of an environment are not separable since each affects the others as well as the person(s) operating within that environment. Homans proposed that ". . . the environment may be broken down into three main aspects: physical, technical and social, all of which are interrelated and any one of which may be more important than the others for any particular group (of people)" (Homans, 1950).

Social interactions are modified and controlled in part by the physical layout in an environment, the placement of the furniture and other non-human objects and the technical processes in use. The physical and technological dimensions are also modified by the social norms and structure of the group involved. For example, the placement of work benches and the size of a work area will influence significantly the forming of social groups. The use of tools and machines that require cooperation of workers will affect social interaction differently from processes that are manageable by the individual working alone. On the other hand, if a group has strong social ties, the group may change some physical aspects of the work setting to maintain desired contacts.

There is another dimension of environmental impact on people. The history of technology is replete with instances of the impact of technical processes, often in the form of machines, on social and human aspects of the environment. A generalizable example may help at this time. The wheeled plow introduced into farming in the middle of the sixth century changed the social structure of the time. A demand for more motive power

in the form of oxen and longer as well as larger fields to maximize the potential of the plow forced the isolated peasant to form into larger social groups. "The adoption of the new plow, therefore, helps to explain the communal pattern of manorial life in Northern Europe" (White, 1967, p. 72).

Many other more specific technological developments have changed the nature of the social interaction in work and school settings. The small electric motor changed the physical setting in industries and school shops, allowing more individualized and separate working conditions. The rise of instructional machines — record players, tape recorders, movie projectors, computer terminals and portable calculators — have changed how teachers and students relate. New developments will continue to modify the interaction of students and teachers with each other. The major question those of us in industrial arts must ask is: what is the nature of possible changes that are being effected on ourselves and our students by the environments we design and create?

Social norms tend to cause their own set of effects. Industrial and school environments may change more slowly than one expects because frequently specific and previously accepted social conventions take precedence. For example, if teachers are viewed, by themselves and others, as the major source of information, those technological developments that would wrest this major activity from the teacher will be disregarded and rejected.

The physical aspects of an environment also affect changes and modifications in work and school settings, although much remains to be learned through research regarding these interactions. Research into the physical aspects of work settings may well have received a major setback from the findings of the Hawthorne study in the early thirties. Homans, in a closing paragraph on a report about that study, observed that "a continuous increase in productivity had taken place, irrespective of changing physical conditions of work" (1941, p. 65). It is unfortunate that the findings were worded thusly. Research cited elsewhere in this chapter suggests that the uncontrolled social/psychological aspects of that study may produce a stronger effect than the physical aspects. Nevertheless, the reported findings established connotations largely unintended, that the physical environment was unimportant. Now more than forty years after the Hawthorne study, except for research related to the effect of



color on humans, we still know far too little about the effects of the physical environment on people in physiological or psychological terms.

Hall, in *The Hidden Dimension*, suggests that the inter-relationships of the different dimensions of the environment are shaped by the culture-laden experience of a given group. He emphasizes that virtually everything that people are and do is associated with the experience of space. A person's "Sense of Space" is a synthesis of many sensory inputs: visual, auditory, kinesthetic, and thermal. Not only is each of these a complex system as, for example, the dozen different ways of experiencing depth visually, but each is molded and patterned by culture. Hence there is no alternative to accepting the fact that people reared in different cultures live in different sensory worlds (Hall, 1969, p. 181).

Within the context of a multiple-dimensional environment, several types of phenomena are important to the central theme of this chapter. These include such major people/environment relationships as territoriality, grouping and independence. Each is discussed in turn.

### **Territoriality**

A major concept in people/environment relationships of learning environments is that of territoriality and the related idea of "turf". Territoriality as an idea was drawn from the study of animals with particular applicability for birds (Bourliere, 1954; Carpenter, 1964). Attempts have been made to develop and define the concept of territoriality in such a way as to make it useful (Lipman, 1970). These initial applications of territoriality to human interaction were generally gross translations of spatial requirements of animals to people as though requirements were essentially the same for animals and humans. Lyman and Scott, however, approached territoriality as having symbolic and cultural dimensions related to human psychology, in addition to the accepted biological dimensions (1967). They went on to distinguish four types of territories, different types of territorial encroachment and three types of reactions to these encroachments. These ideas are presented graphically in Fig. 3-1.

The first of the four types of territories is described as *public territories* which are theoretically open to all but have

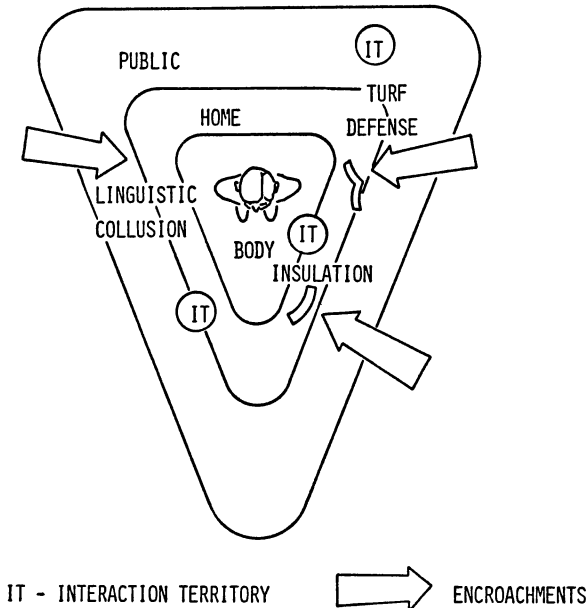

**Fig. 3-1. Four Types of Territories.**

regulations for use and rules of conduct. Times when these territories can be used, acceptable behaviors in those settings, and who may be excluded (such as children from factories) restricts the publicness of some territories.

The second type of territory is described as *home territories* or those “. . . areas where regular participants have a relative freedom of behavior and a sense of intimacy and control over the area.” (Lyman and Scott, 1967, p. 68). Home territories could include a drive-in restaurant, a street corner or several city blocks taken over by teenagers as their home base. The third territorial type is the *body*. Body territory includes a bubble of space around the body and an inner space of thought and reflection. This space is seen by many as sacrosanct; consequently they may react directly to any encroachment into this personal territory. The fourth type of territory is *interaction territories* or areas in which a social gathering may occur. Interactional territories may occur within public or home territories and include parties and discussion groups.

All four of the above territories are open to encroachment. Reaction to encroachment takes the form of *linguistic collision*, *insulation* and *turf defense*. Linguistic collision is a form of indirect influence by words or actions to cause an outsider to leave an immediate area. Insulation is the placement of some form of barrier between an individual or group with outsiders. Turf defense takes on more active and drastic forms of expulsion when other reactions to encroachment have failed.

### **Grouping**

For our interest here, the review and analysis of literature focuses on the phenomena related to grouping. Because of the importance of the individual learner in our discussions, a psychological perspective of the social group is taken and is defined as “. . . a number of people who (1) interact with one another, (2) are psychologically aware of one another and (3) perceive themselves to be a group” (Schein, 1965, p. 70). A crowd or student body would most likely not be a group because of a lack of mutual interaction and mutual awareness. Work groups, teams, and even classes would fit this definition because such composites tend to provide a “sense of belonging and being a part of a larger entity which Erickson identified as important ingredients of group identify” (Festinger, 1951).

Grouping, the coming together of individuals to form a group, is important here in terms of why people seek membership in a group. Festinger identifies three sources of attraction of groups for individuals: (1) groups frequently mediate the attainment of important individual goals, (2) the activities in which the group engages are frequently attractive to the member and (3) most people have needs that can be satisfied only by personal relationships with other people (1951). The importance of need fulfillment of a group for its individuals is also supported by Schein (1965).

Wells, who takes the perspective that architecture can play a facilitative role in fostering social interaction, found that social interaction and consequently the tendency to form groups was shaped significantly by the size of the room and the distance between individuals, which in turn influenced lines of communications (1965). Schein's observations support this in that environmental factors such as work organization, workers' location, and time scheduling will influence who interacts with whom, con-

sequently determining who will most likely form into groups (1965, p. 67). The work suggests that if groups are to be encouraged, the work environment must promote the forming of groups.

The use of any physical environment is greatly determined by the characteristics of the environment and the social structure of those using it. Given an instructor who acts as a resource person and tasks that promote interaction and involvement, some physical arrangements may be easier to use or may more easily facilitate these processes than others (Sommer, 1974, p. 99). For example, small rooms seem to contribute to internal cohesiveness of groups. These related products of internal cohesiveness such as high morale, tension, competition or cooperation are still to be determined. Further study into the effects of spatial arrangements is needed for effective use of space from the standpoint of building an organizational management.

Festinger concludes that grouping is very much shaped by the similarity of the individuals in the larger group. Consequently, spatial organization and design may be less powerful in bringing about group cohesion in socially heterogeneous than in socially homogeneous groups (1951).

The perspective taken by the manager of the environment, therefore, could play a pivotal part in how groupings are handled — whether by facilitation or by fiat. Schein identified four perspectives that may influence grouping. These include: *rational-economic*, *social*, *self-actualizing* and *complex*. A person who holds the rational-economic perspective would not be likely to value grouping since the interest is in maximizing individual efficiency. The social perspective would foster formation of groups but might underplay rational choices to facilitate such performance. The self-actualizing perspective places primary emphasis on psychologically meaningful work and secondary emphasis on psychologically meaningful groups. Grouping in this instance is at best tolerated and seldom encouraged.

Schein places most emphasis on the complex perspective that assumes that groups are not the right answer to every problem. Organizations that look carefully at the viability of different groups are generally the most effective users of groups. He proposes a diagnostic approach to forming groups that takes into account past records of group uses, availability of people competent as group members and the available leadership.

Grouping appears to be a natural yet complex phenomenon of importance to the facility designer. Since instruction in technology-oriented learning environments often requires and attempts to exploit deficiencies of a social group, we would be well served by identifying those factors that enhance or detract from forming, maintaining and dissolving of groups and determining how these factors might be controlled and managed. Wells' observations at this point become almost self-evident when he notes that further study into the effects of spatial arrangements is needed for effective use of space from the standpoint of space and group management (1964, p. 881).

A counterpart of the phenomenon of grouping is privacy. Privacy, propoerts Swartz, is necessary to maintain harmonious social relations between peers with rules of privacy in terms of contact normally spelled out rather clearly (1968). Privacy as a facet of the environment is determined largely by the physical configuration and regulation provided by the building. Perhaps the most regulatory device for privacy is the door. Unlike a window that is oriented on an in-to-out basis, that is viewing outside from within, the door has bidirectional flow both in and out. Generally accepted rules of who may open which doors and when they may be opened tend to regulate flow and separateness. A wall, on the other hand, denotes separation. Doors close out; walls enclose ". . . Islands of privacy exist in all establishments . . . These islands are protected by an intricate set of rules. When these rules are violated, secret places are sought after, discovered and employed as facilities for secret action" (Swartz, 1968, p. 750).

### **Independence**

Within the theme of independence, the individual becomes very important as the major component of the social group as well as the totality of a single learner. Turning first to the individual, the literature on human development is quite important since a major concept within that field is the need for independence by the human. The drive of an individual to secure control over some physical and psychological space in which he/she can comfortably operate is a major component of the developmental perspective of Erikson (1963) and Argyris (1960). This view

holds that most individuals will strive to develop into mature self-determining or self-actualizing people, albeit at different rates and combatting different potentially destructive forces.

Argyris' view of dependency problems for the individual in an organization structure appears to have currency for teachers and students in learning environments. He states that ". . . problems . . . arise because relatively healthy people in our culture are asked to participate in work situations which cause them to be dependent, subordinate, submissive, and to use few of their . . . abilities" (1960, p. 190). As these feelings increase so do the levels of frustration which then leads to regression, aggression and tension, and finally conflict. Individuals who experience these feelings will find some way to adapt, usually in non-productive ways. They may choose escape, acceptance, rationalization or apathy. Most of the adaptive moves, however, tend to distract from the individual's self image and involvement (1960).

From his research and review of institutional settings, Sommer poses the sobering thoughts that people are susceptible to effects of isolation and routine as identified by a variety of names such as institutionalization, depersonalization or desocialization, (the term to be used herein). Sommer's treatment of this process and its symptoms, by whatever names, is compelling, but it is the insidious changes toward dependency in the person who has succumbed to desocialization that most concerns us here (Sommer, 1974). For example, the desocialized person has decreased efficiency in making decisions partially because the institutionalized procedures and the environment gradually usurp more and more of his/her decision-making powers. Even though schools may not induce as severe desocialization as other institutions, such as prisons, there is still adequate reason for concern.

Teacher and student independence within an open-space facility may carry a sense of ambiguity. As Hall notes: ". . . to design houses and offices without regard to traditional patterns . . . sometimes results in great barnlike rooms where 'territory' of scores of employees in a 'bullpen' is ambiguous." This ambiguity may be a contributing factor in the need for many teachers to be trained to work in open-space schools. The difficulty of teachers is not just the living in an open-space, but in dealing with the student behavior that is encouraged in an open-space setting. If we take out walls and carpet the floor, students will

be tempted to sit on the floor, take off their shoes, sit and study under a table and even to run. This testing and exploring should not be considered aberrant behavior. The physical space has changed. New behaviors must be expected and channeled appropriately into new learning experiences (Busselle, 1972).

### Summary

In the past we have given considerable attention to the physical aspects of facilities and learning environments. Increasingly more attention must be turned to the technical and social aspects of the learning environment. As indicated by work of the Educational Facilities Laboratory staff, “. . . a successful (facility) depends more on atmosphere—a creative learning atmosphere — than on its enclosure” (EFL, 1972, p. 6). The assumption upon which this section was based was that all three of the dimensions — the social, physical, and technical of the learning environment — must be considered lest we ignore important aspects of appropriate and successful settings for learning.

Professionally, we remain naive in our understanding and control of the cultural/social aspects of the general learning environment. Most of the sociological personality that these learning environments take on is largely unintended and unpre-scribed. For example, because of our acculturation we are moderately successful at staging social settings that encourage competitive behavior. However, if we are called upon to describe the *procedures* for *choosing* activities to encourage competition or to modulate the degree of competition to a given group of students, we may be at a loss. Worse yet, if we are asked to establish social settings, to encourage cooperative behaviors, we may be at a loss not only staging the activities, but also in describing the procedures and rationale underlying our choices.

## ENVIRONMENTAL DESIGN

The goal of environmental design is to provide facilities that will support envisioned and desired curricular programs and instructional actions. This supportive role of facilities requires that curricular programs be conceptualized and articulated in a manner that will enable a facility designer to identify clearly (a) the goals and philosophy guiding the program; (b) the activ-

ities and behaviors to be staged within the program and its facility; and (c) the procedures and sequences used for arranging the learning experiences and activities.

There are definite, although usually unidentified, limits and possibilities for which any facility or learning environment can provide. As a first step toward maximizing those possibilities, it is necessary to have appropriate approaches to facility design and development. This in turn requires us to focus on that part of the total environment with which we can deal, and further, to identify the tools, however crude, with which we can work.

In discussion of facility design, the concept of the "near environment" will be used for delimiting our sphere of concern and influence. The near environment is generally that space from a person's skin to the walls of the enclosed space in which that person is functioning. The near environment would include the individual's clothing, and all furnishings, decoration and facility layout. Ostrander notes that ". . . the public is still unaware of the potential the near environment holds for uplifting our spirits or intensifying our frustrations" (1972, p. 2).

A recently emerging field of interdisciplinary work, namely environmental analysis, holds promise as a potentially usable tool for facility design and development. Environmental analysis is defined by Ostrander as "the systematic empirical study of the physical and social settings in which behavior occurs and needs are satisfied" (1972, p. 2).

Building upon Ostrander's work, the use of environmental analysis for facility design was conceptualized and articulated as a three-phase systems approach by the division of non-environment systems at Pennsylvania State University. In the first phase, the goals for which a facility or facilities are built are identified. In the second phase, the facility designer describes the human behaviors that are necessary to achieve the goals stated in phase one. Finally, in the third phase, the designer determines if the existing or planned facility will facilitate or hinder the desired behavior.

Following this general approach, the Department of Design and Environmental Analysis in the New York State College of Human Ecology developed six questions to be answered by an environmental analyst as preparatory to the design of human environments. "The answers to these questions can provide him



with a reasonably comprehensive assessment of the environment and offer data on human and social factors that can help designers in arriving at solutions" (Ostrander, 1972, p. 2). For purposes of illustration, the following responses were made to the six questions in the design of a program of technology studies that would be compatible with the open curriculum (Todd, 1974).

### **Basic Questions Answered Through Environmental Analysis**

1. *What objectives or goals are these physical and social arrangements created to accomplish?*

This technology facility will be created to educate young children and adolescents through activity-oriented experiences. The facility is intended for exploration in the use of tools, materials and equipment with emphasis on problem solving. The facility is to support group endeavors such as setting up a production line, organizing an enterprise, involvement in simulated transportation systems (such as land travel or space navigation), and erecting a variety of structures and enclosures.

2. *Is there a particular philosophy, theory or point of view to be followed in achieving these objectives?*

The guiding philosophy for the envisioned facility includes a general definition of technology as "the application of knowledge of application to purposeful ends." The desired program is to be cumulative, integrative, individualized, synergistic, flexible, and cost-conscious.

3. *What behaviors or activities must be carried out?*

To achieve the cumulative objective, students will engage in individual and group efforts. Specific tool usage and problem solving will be done within a context of application. Students will assume such roles as product designers, project engineers, production line workers, researchers, builders, managers, in-plant printers, model makers. The work of these roles will be coordinated through larger group efforts in production, transportation and communication.

4. *Where do these behaviors and activities happen?*

A large percentage of the activities and behaviors will be staged within the school-based technology environment. Out-

of-school activities such as field trips and industrial visitations will be related directly to preparatory and follow-up activities in the school or facility. Small group and individual activities will be pursued in more private space around the perimeter of the facility and in mobile seclusion pods in the center of the area if appropriate.

5. *What kinds of procedures, routines or programs have been developed and put into practice to help achieve the objectives?*

A student who assumes a specific role, such as a product designer, is helped to fulfill that role by looking at what a product designer in industry actually does.

- The teacher, when not formally lecturing or demonstrating, will work as a consultant to the students in production or other activities.
- Decisions within these activities are to be made by students, not by teachers.
- Teachers will utilize work projects and research of students to introduce new information and processors into the program.

6. *When are goal-related behaviors exhibited and in what sequence?*

This question is answered through observation of the program in operation (either by direct observation or by indirect simulation for envisioned programs) and the use of patterns, individual and group space usage and flow patterns. Spaces within a facility will have high and low usages at different times of the day and hour. Specific student activities will be compatible and can be run simultaneously; other activities will require different time schedules. Additionally, longer range plans (yearly sequences of program activities) will provide important data for making facility design decisions. The output of an environmental analysis will require some visual, statistical and written presentation regarding aspects of conflict in the existing or planned facility. From this data, the facility designer can determine if the environment does, in fact, support the desired learner activities and behaviors, if the activities to be staged together are compatible, and if the curricular and instructional activities are supported by the facility. This requires that the facility designer identify how the people and instructional objects interact within an envi-

ronment and how they relate one to another. The following section provides a systems view of learning environments to facilitate that work and comparisons.

### A Systems View to Learning Environments Design

Learning environments by their very nature dictate a systems approach to their understanding and their design. The analogy of a learning environment's "system" proposes that a learning facility is a functioning "whole" with identifiable operating "parts." The sum of these operating parts represents the total learning environment. The model of an environment system to be used here includes four parts as shown in Fig. 3-2. These include facilities, equipment, materials and people sub-systems.

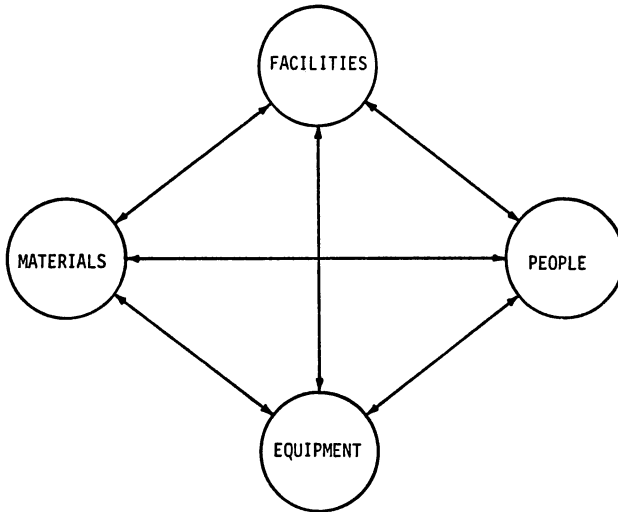

**Fig. 3-2. A Systems View of Learning Environments Design.**

The consideration of the interplay of these four components of the learning environment is important because of the influences generated not only by the educational building and furnishing but by the routine programs, procedures and approaches that are used within the learning environment. Although facilities, equipment, materials and people are all viewed as important and integral parts of a learning environment, discussion here will be limited to systems of facilities and equipment.

### The Facilities System

The facilities system includes those parts of the learning environment that provide space and services to support learning activities. It will be productive, therefore, to consider the space and service aspects of a facility as sub-systems and determine ways in which they can help provide a more usable facility, and at the same time maximize the money spent on the facility. A specific approach developed by Durkin and Todd is presented here as an example. In this approach, specific sub-systems, including support and power, exhaust, and air, were identified and designed to form an integrated whole.

### Support and Power Sub-System

This sub-system utilizes an overhead power grid that, through universal electrical connections, could provide 220 VAC (single and 3 phase) or 120 VAC (single phase) to virtually any point on the floor below.

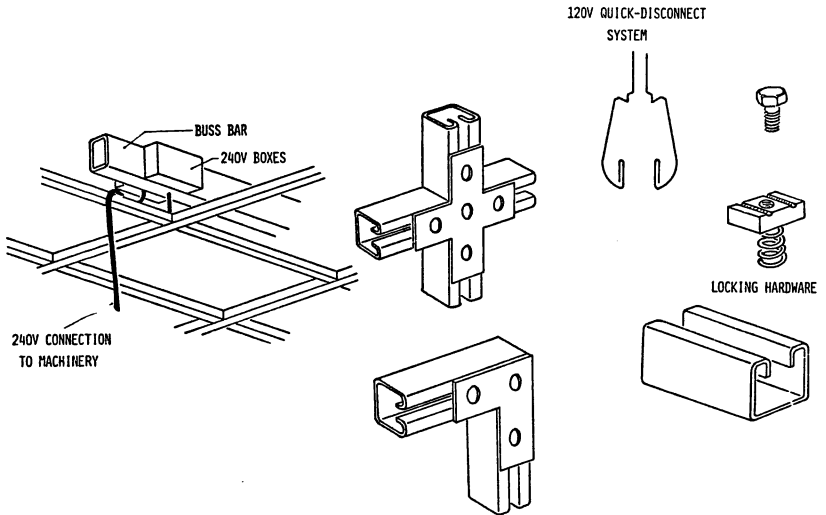
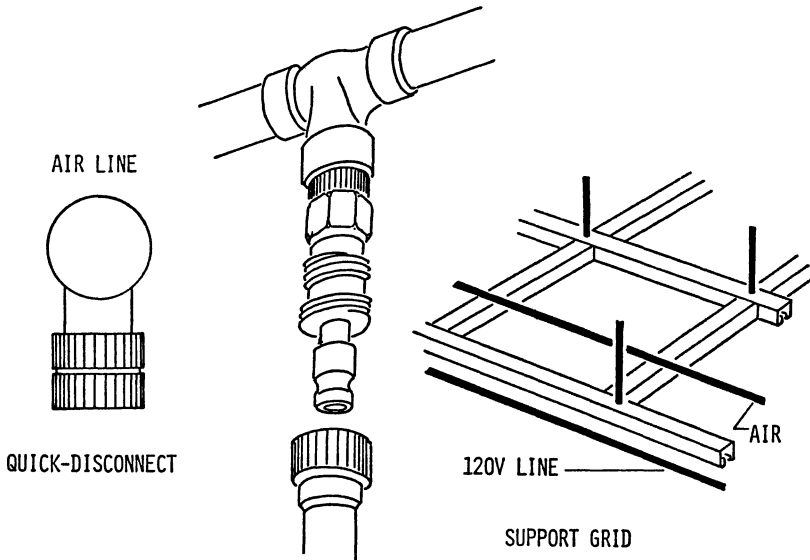

**Fig. 3-3. Support and Power and Power Sub-System.**

Additionally, a standardized structural grid allows the ceiling to also be a usable part of the facility. Wall units can be attached to the grid and such devices as conveyors, photographic lights and drying racks can be hung from it.

### Air Supply Sub-System

The flexible facility is equipped with an air supply system mounted directly above the support grid. A variety of air hoses equipped with quick connective plugs allow a flexible connection from the equipment to the service grid. This sub-system allows compressed air to be delivered to any point on the facility floor below or close to the service grid. Machines requiring air may be erected within this large general area.



**Fig. 3-4. Air Supply Sub-System.**

### Exhaust Sub-System

Debris and fumes are eliminated from the facility through two separate parts of the exhaust system, one for fume exhaust and one for dust exhaust. Each of these are located above the support and service grid, yet remains easily accessible. The flexible hoses and nozzles drop from the major runs above, providing separate as well as overlapping floor areas that can be used for heat/fume and dust/chip generating processes.

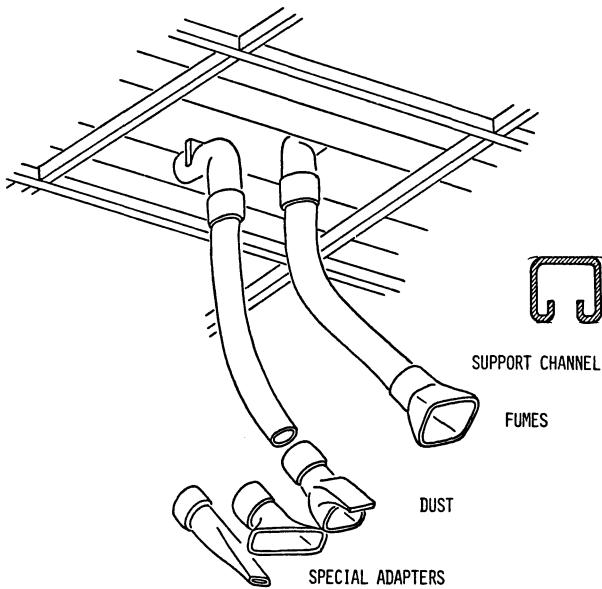

**Fig. 3-5. Exhaust Sub-System.**

### **The Equipment Sub-System**

Machines and equipment normally found in our labs and shops are not systemitized in any sense as the term is used here. Most equipment is developed, produced, purchased and used in isolation of other pieces of equipment. Consequently, the cumulative effect of equipment acquisition is deterred. A systems design approach to equipment holds considerable promise for enhancing a cumulative effect for enriching learning environments. One such approach, designed and developed by Durkin, Shackelford and Todd, utilizes the systems approach in maximizing the educational and economic payoff of each piece of equipment acquired (1972).

At the risk of successive fragmentation, machines were themselves viewed as a set of identified sub-systems. The three equipment sub-systems identified were 1) the support and cover sub-system, 2) the power transmission sub-system and 3) the guidance and control sub-system. The natural extension of this approach resulted in the development of a unique Flexible Equipment (FLEX) System. A simplified graphic display of the Flex System is presented in Fig. 3-6.

Components are drawn from each of the appropriate equipment sub-systems to provide the necessary parts to erect a desired machine. Once the machine is no longer needed, the parts are returned to storage for later use in other machines.

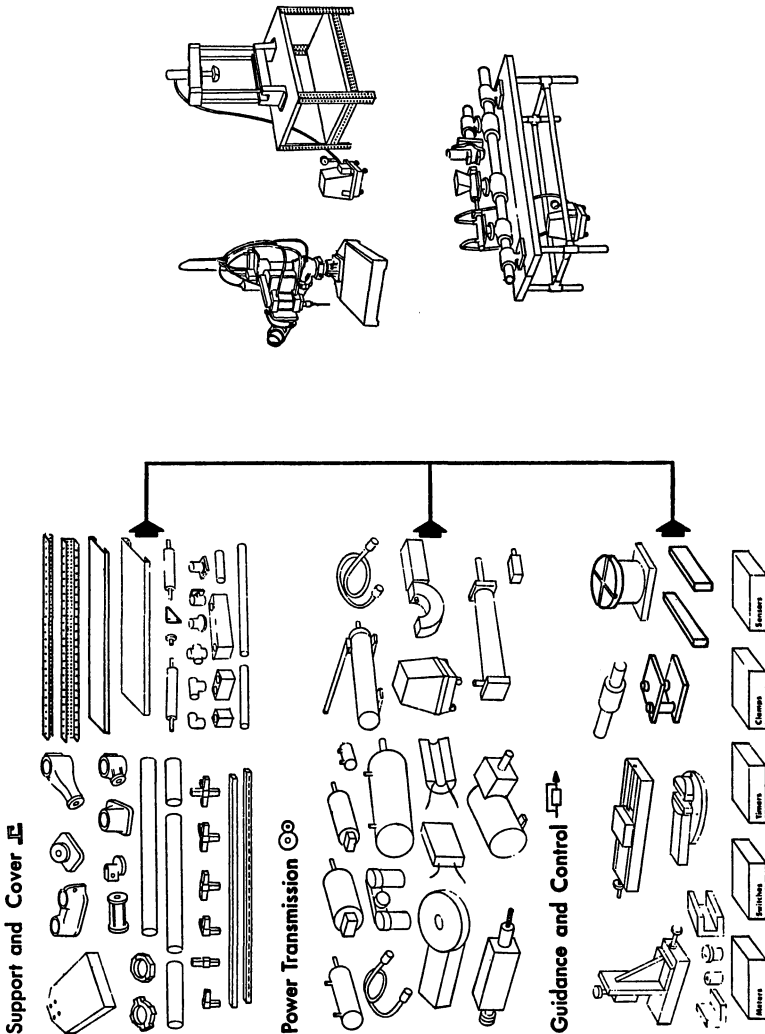

Fig. 3-6. The Equipment Sub-System.

### Summary

Although all parts of the learning environment affect each other, our focus of interest is on the effect of environmental design on student behavior. To that end a procedure of environmental analysis was considered followed by a systems view design of learning environments. This included a description of supportive facilities and equipment systems as related to the people in the learning environment. As Beckman notes "the things of education, buildings and furnishings influence human behavior. The routine programs that people follow also affect human behavior. It is a pity that many of us are insensitive to these facts, because in an effort to improve education, a wealth of advantage remains unexploited" (Beckman, 1972, p. 45).

## THE MANAGEMENT, PLANNING AND USE OF LEARNING ENVIRONMENTS

The management, planning and use of the learning environment is predicated on the notion that there are parts of the environment that can be manipulated and that we have the necessary tools to make the desired changes. The management of the physical learning environment can be described as the product of the curriculum decision-making concerned with logistics. Decisions about how the six logistical elements to time, space, equipment, materials, grouping, and centers of attention should be allocated, arranged and articulated fall within management acts.

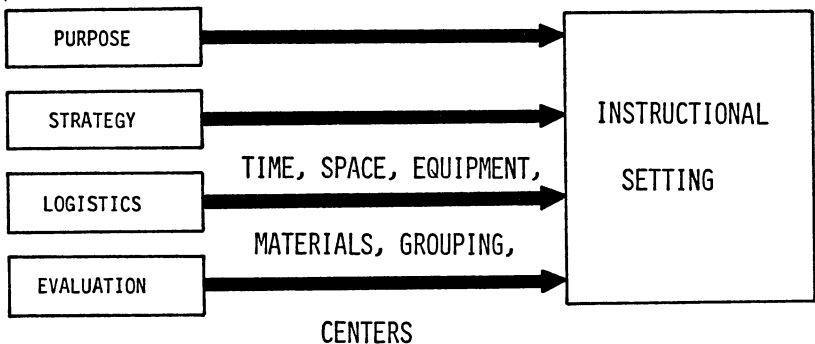

Fig. 3-7. Curriculum Decision-Making Relative to Instructional Settings.



Planning acts include those decisions made before instruction that comprise a set of intents to be accomplished. The determining of specifics of the six logistical elements for an upcoming instructional session are included in *planning* of learning environments. In the use of learning environments during instruction the six elements are manipulated by the teacher in deciding the “where”, “when”, and “with what” of an instructional session.

### **Managing the Learning Environment**

The management of learning environment during instruction goes far beyond the pedestrian monitoring of tool distribution, equipment operation, materials dispersal and shop clean-up. The changing nature of activities within a learning environment may dictate that the learning environment change also. The changing of the environment often resides with the teacher/manager who must continually monitor how the system is operating. The manager must consider if the facility provides the kind of tools, information, and space needed for the ongoing activity. Is the facility obstructing or diminishing the activity? Identifying needed changes in order to maintain the facility as a supportive learning environment and prevent a break-down is one of the responsibilities of the teacher/manager.

### **Facilities**

Management is part of the observable behavior of teachers as they apply what they know of physical, social and technological systems in providing productive instances of human actions and interactions. The manager of the learning environment, unlike the facility planner, remains as a part of the operating milieu. Consequently, the teacher manager not only must understand the principles of facilities design as they are used to provide a shop or laboratory, but must apply those principles in ongoing systems to modulate and control the environment to achieve predetermined and emergent purposes.

The reconsideration of the physical environment dictates drawing on the knowledge of several different fields. Perhaps the most obvious is the knowledge of architecture as it applies to space utilization for learning. Although, as indicated in other sections of this chapter, architects have not been significantly concerned with how space and facilities contribute or detract from learning, there are guiding concepts that can be derived from some of their work in other arenas.

Approaches used in the movement of people and the focusing of their attention in the design of museums, galleries, and expositions suggest some possibilities for us. Of particular note are 1) the use of visual barriers to provide a sense of separateness and privacy from larger busy environments, 2) the use of sound, in the form of white noise, to minimize the effect of short term high decibel sounds and 3) the use of lighting to focus attention, to set moods and to reduce the decibel level of student talk. These ideas and others as used by industrial designers in the development of displays and exhibits have implications for use in facility design and management.

### **Planning the Learning Environment**

Having described some general principles to guide the management and control of the larger learning environment, it is appropriate to turn our attention to the specifics of dealing with the immediate environment of instructional settings. Approaches for staging and modifying acts of instruction fall primarily within the field of curriculum and instruction. One such approach, utilizing behavior objectives and organizing centers, appears to have significance for the planning of the physical learning environment.

Behavioral objectives are used widely and require little explanation. Essential to our discussion is the notion that behavioral objectives include a statement of desired student action. These actions, or behaviors, represent evidence indicating that the student has acquired some desired knowledge, attitude or skill.

The organizing center is actually comprised of two parts — a “center” and an “organizer.” The center serves to focus the attention of the learner and teacher on common events during instruction. The organizer serves as a theme and a conceptual direction for the instructional interaction.

Centers of attention are directly related to behavioral objectives since it is the “center” that not only focuses learner attention but also supports learner activity, consequently eliciting student behavior. Centers of attention and behavioral objectives, therefore, can be used cooperatively to elicit learner behavior and then to analyze that behavior to determine if desired instructional goals are being attained.

The behavioral objective and organizing center approach to the analysis of equipment, tools, kits and instructional media follows the general procedures described in the chart below.

The use of learning environments takes place during instruction. This use is represented in what the teacher does in manipulating the logistical elements of space, time, equipment, materials, groupings, and centers of attention to facilitate desired learning. Decisions are made, therefore, in determining how long an activity will run, where it will take place, what machines and materials are needed, which students will be involved and what will be the focus of the activity. Facilities that lend themselves to changing their physical arrangement, to storing equipment until it is needed and to supporting different student groupings allow teachers to make decisions about how to use those learning environments. Facilities should not be solidified products of planning that leave few options of use-decisions for teachers.

Continuing within the theme of decision-making, we can ask what guidelines can be used to facilitate rather than usurp decision-making of teachers and students. One straight-forward guideline seems obvious. Does the learning environment provide options from which a student can choose? If the student is to be involved in decision-making, there must be a possibility of choice. In order to be a possibility of choice, there must be two or more comparable options. Lacking these options, an environment restricts choice and consequently interferes with decision-making.

### **ANALYSIS OF EQUIPMENT AND INSTRUCTIONAL MEDIA THROUGH USE OF BEHAVIORAL OBJECTIVES AND ORGANIZING CENTERS**

1. The machine, tool or kit is analyzed to determine what could be learned by a relatively uninformed learner.
2. This potential learning is identified as potential skills, information and attitudes.
3. These skills, information and attitudes are stated as behavioral objectives that are attainable through the use of the materials.
4. The same sequence is performed for the instructional media to determine the behavioral objectives that are attainable through the use of the materials.

5. The media is then reanalyzed using the organizing center approach to determine what themes or ideas are introduced in and through the content.
6. These ideas are translated into potential concepts to be transmitted by the content.
7. The specific pieces of equipment (machines and tools) are analyzed to determine what concepts can be gained through their use by students.
8. All the concepts and objectives are then studied to determine the general direction and purposes that are supported by the materials being analyzed.
9. These characteristics are stated as general goals and approaches of learning.
10. The goals and approaches are then integrated into the six environmental analysis questions presented in a preceding section.
11. The degree and suitability of the match of the goals and approaches derived from the instructional media and equipment to the envisioned program goals and approaches determines if those materials should be selected for inclusion in the learning facility.

For purposes of clarification, the following example is given. When a student is given or is faced with a problem of making a hole in a piece of material, a standard lab or shop often provides the answer — drill it. That is what we teach and what we provide for generating a hole in materials. If decision-making is to be facilitated, a learning environment with options must be planned. Other processes of punching, burning, extruding, etching and forming around the hole (negative space) are only a few that could be provided. The guideline could be applied over and over again to determine the availability of options for the kind of decisions we want students to be able to make. These options then must be identified and translated into some physical form, often a machine for inclusion in the learning environment.

### **Projected Environments**

Learning environments in the future will take on more divergent forms than what are presently in use. Alternative programs will begin to make quiet, yet demanding changes on standard facilities. In fact, standard facility as an idea will eventually

pass. There is no such thing as a standard environment for learning "because a successful (facility) depends more on atmosphere — a creative learning atmosphere — than on its enclosure. This does not mean that space design and location are insignificant, but that existing facilities can be made into exciting places for learning despite their original state" (EFL, 1972, p. 6).

If a new standard facility does emerge it will essentially be a flexible one. To insure maximum utilization of space, it will be necessary to provide flexible rather than open space, which can at times be restricting and non-open in the sense that specific possibilities are disregarded. Facilities locked in the open position disregard that some space utilization can best take place in a closed or standard format. Flexible facilities, therefore, will hold considerable power because both standard and open environments will be stageable on demand.

Flexible space is not an entirely new idea at all. Some years ago an interesting idea for facility planning entitled the "empty shop approach" showed briefly. The essential idea behind this approach was to bring items of furniture and equipment into the laboratories only when and as needed. Students as well as teachers could, therefore, be involved in determining what was needed for a given activity. That idea was implemented and studied in only a few isolated instances and the concept has received virtually no attention by the profession during the intervening ten years. This harbinger of flexible space still holds considerable potential and warrants a more adequate testing as a viable approach to staging learning environments.

The reality faced by most of us in the profession in making environmental changes is that new facilities will often be out of the question. Changes in facilities will come primarily through renovation and, although many times more difficult, such changes can be significant in providing more usable and powerful learning environments.

Learning environments that are "locked" into any format whether standard or open are doomed to inadequacy. Standard facilities that have permanent and unyielding work stations and open classrooms with little or no separated space for students and especially for teachers are doomed to be less than optimally successful. Inflexible facilities may well have a second and more important dimension of potential failure. Facilities that do not

change and cannot be changed by teachers and students eliminate a significant aspect of learning, namely experiencing the effects of environments on human behaviors. Lacking these experiences and the capability to modify their environment, it is unlikely that students will gain those insights important to the design and control of their own learning and living environments.

### Chapter Summary

The underlying theme of this chapter has been the importance of rational decision making about learning environments as designed for and used by humans. Consequently, no attention has been given to rules for facility planning such as maintaining a two to one ratio of length to width, providing for north lighting, and insuring a set number of square feet of floor space for each student. These rules may help develop adequate shops but could also lead to inflexible, inhumane and inefficient learning environments. It is imperative to realize that establishing learning environments on rule-of-thumb bases rather than as a studied concern for such key concepts of space design and utilization as territoriality, grouping, independence and decision-making activities may well produce unintended and undesired consequences that can seriously affect the quality of the learning and human interaction within those environments.

## REFERENCES

- American Council on Industrial Arts Teacher Education. *Guide to the Planning of the Industrial Arts Facilities*. Bloomington, Illinois: McKnight Pub. Co., 1975.
- Anderson, Lowell D. "Trends in Laboratory Designs for the Middle School," *Man/Society/Technology*. Vol. 32, No. 6, March 1973, pgs. 239-241.
- Argyris, Chris. "Individual Actualization in Complex Organizations," 1960 in *Organizations in Human Behavior*. Fred Carver and Thomas Sergiovanni, eds. New York: McGraw Hill, 1969.
- Beckman, Ronald. "Interior Space: The Things of Education," *The National Elementary Principal*. Vol. LII, No. 1, September 1972, pgs. 45-49.
- Bourtiere, F. *The Natural History of Mammals*. New York: Alfred A. Knuff, 1954.
- Busselle, S. M. "Training Teachers to Work in Open Space," *The National Elementary Principal*, Vol. LII, No. 1, September 1972, pgs. 87-90.

- Carpenter, C. R. *Naturalistic Behavior of Nonhuman Primates*. University Park, Pa.: Pennsylvania State University Press, 1964.
- Coates, Gary J. *Alternative Learning Environments*. Stroudsburg, Pa.: Dowden Hutchinson and Ross, Inc., 1974.
- Deasy, C. M. "When Architects Consult People," *Psychology Today*. Vol. 3, No. 10. March 1970, pgs. 54-79.
- Durkin, James and Todd, Ronald. "A Proposed Flexible Technology Laboratory." Terre Haute: Indiana State University, Mimeo 1967.
- Educational Facilities Laboratory. *Found Space and Equipment for Children's Centers*. New York: EFL 1972.
- Erickson, Eric. *Childhood and Society*. New York: V. W. Norton, 1963, pgs. 247-274.
- Festinger, Leon. "Architecture and Group Membership." 1951 in *People and Buildings*. Robert Gutman (ed.). New York: Basic Books, 1972, pgs. 120-134.
- Goodlad, John I. "The Teacher Selects, Plans, Organizes." Madison: The University of Wisconsin, Department of Curriculum and Instruction, Mimeo, Updated.
- Hall, Edward T. *The Hidden Dimension*. Garden City, New York: Doubleday Co., 1969.
- . *Beyond Culture*, Garden City, New York: Doubleday, 1976.
- Homans, George. The Western Electric Researches from *Fatigue of Workers*. New York: Reinhold Pub. Corp., 1941, pgs. 56-65.
- . *The Human Group*. New York: Harcourt, Brace, and World, Inc., 1950.
- Lipman, Alan. "Territoriality: A Useful Architectural Concept?" *RIBA Journal*. 1977, No. 2, Feb. 1970, pgs. 68-70.
- Lyman, Stanford M. and Scott, Marvin B. "Territoriality: A Neglected Sociological Dimension," in 1967 *People and Buildings*. Robert Gutman (ed.). New York: Basic Books, 1972, pgs. 68-82.
- Ostrander, Edward R. "Environmental Analysis in Design," in *Human Ecology Forum*. Vol. 3, No. 2, Autumn 1972.
- Perkins, Lawrence B. "New Trends in School in School Design," in *The National Elementary Principal*. Vol. LII, No. 1, Sept. 1972.
- Schein, Edgar H. *Organizational Psychology*. Englewood Cliffs, New Jersey: Prentice Hall Publishing Co., 1965.
- Shackelford, Ray. "The FLEX Equipment System" in *Manufacturing Forum*. Vol 1, No. 3, Spring 1977, pgs. 23-28.
- Sommer, Robert. *Tight Places: Hard Architecture and How to Humanize It*. Englewood Cliffs, New Jersey: Prentice Hall Pub., 1974.
- Swartz, Barry. "The Social Psychology of Privacy," *American Journal of Sociology*. Vol. 73, May 1968, pgs. 741-752.
- Thieme, Eberhard: "Environmental Designs," in *Industrial Arts for the Elementary School*. ACIATE 23rd Yearbook, pgs. 171-189. Bloomington, Ill.: McKnight Pub. Co., 1974.
- Todd, Ronald. "A Conceptual Framework of Curriculum and Its Relationship to Instruction and Evaluation." New York: New York University, mimeo 1974.

- Webster Collegiate Dictionary*. Springfield, Massachusetts: G&C Merriam Co., 1967.
- Wells, B. W. P. "A Psychology Study with Office Design Implications," *The Architects Journal Information Library*, 1964.
- Wells, B. W. P. "The Psych-Social Influence of Building Environment," 1965 in *People and Buildings*. Robert Gutman (ed.). 1972, pgs. 97-119.
- White, Lynn Jr. "Technology in the Middle Ages," in *Technology in Western Civilization*. Kranzberg, Melvin and Purcell, Carroll (eds). Vol I (New York: Oxford University Press, 1967).





*Dr. J. Barry DuVall*



Dr. DuVall is currently associate professor and program coordinator, Master's degree program in Technology Education, College of Human Resources and Education, West Virginia University. He received his B.S. and M.S. degrees from Indiana State University, and his Ph.D. degree from the University of Maryland.

He has background experience in technical writing, research, accounting, communications, and public school and university teaching, and has written numerous articles on communications, systems analysis, work, and curriculum development. He is currently completing a text on Communications Technology for use at the senior high school level.

Dr. DuVall first worked in the open access environment while serving as an instructor in the Orchestrated Systems Laboratory at Indiana State University in 1967. Since then his major activities have focused primarily on content and method for use in basic education programs for the study of Technology.

# Open Access Technology: A Design for Survival

*J. Barry DuVall*

## INTRODUCTION

Many would say that the ultimate function of schooling is to enhance the “cope-ability” of all learners. Few would argue that this is the function of the schools alone. It is known that learning takes place prior to birth and continues until death and occurs during every waking moment of every day. Current research on dreams even seems to indicate that learning takes place during sleep.

Learners gain access to information and later convert it to knowledge by engaging the world: seeing, hearing, touching, tasting, smelling, putting together, taking apart, discovering, breaking, bending . . . inventing laws. Learners are philosophers, inventors, lawyers, story tellers, kids and adults. Very often they lack the background information, comparative judgement, and internal controls that will enable them to cope — to live effectively as intelligent citizens in a changing world. Teachers, parents, friends, and others function as suppliers of these missing ingredients.

Visits to a great number of schools across the nation indicate that most educators have not succumbed to this way of thinking. Most generally, school rooms seem to be places where mini-vignettes of “reality” are played back year after year for the benefit of all learners. The vignettes have become so ingrained in the educational mentality that they have taken on a distinctive aura

of respectability as part of our educational culture. Craig Wilson refers to them as “stable knowledge.”

Educators have always approached the adventure of curriculum design in terms of content specifics, sacred truths that have met with little contention over time. This seems particularly true in the humanities, and even to some extent in the sciences, where much of today’s innovative thought seems to be directed toward questions such as: *how can* class control be maintained? or *how does* one teach a particular subject? No longer do the content specifics of a particular discipline seem of sufficient interest to warrant scrutiny — at least not to the extent shown by educational research directed toward methods or evaluation.

The adventure of designing curriculum has grown out of this mentality, this quest for stability between content and method. The pendulum has moved back and forth, pointing in the post-Deweyan years to an emphasis on methods and during the post-Sputnik era on content. Many changes have been made, but much dysfunction and confusion has occurred, mainly because of non-consequential debates between curriculum planners on which was most significant.

More recently, studies conducted with poor, minority group children have shown that the methods used in the classroom are closely related to what one is trying to teach. Weinstein and Fantini, (1970, 16-17) in reference to their research conducted in the inner city of Syracuse, New York, commented:

Experience with the socio economically different pupil has made it dramatically clear that no teaching procedure can be effective if the content is of little interest to the class.

There seems to be no question about the fact that the citizens of tomorrow cannot function without continually increasing their level of cognitive knowledge. Yet knowledge per se does not necessarily lead to more desirable behavior. Knowledge can generate passive reactions but it takes strong feelings to generate action.

Many attempts at curricular reform have focused on the active involvement of the learner, through content and method emphasizing more than stable knowledge (stable knowledge + contested truths and exploratory hypotheses).

During the last decade a preponderance of new plans emerged. All of these were directed toward curriculum improvement, and

most were conceived simply as alternatives to what "was." From the outset it seemed apparent that the proponents of these plans were concentrating on curriculum improvement directed toward specific locales. Gradually, however, many of these innovators became confident and convinced that they had the one "grand plan." Consequently some of these plans met with fairly widespread adoption and a new era of "national" curriculum approaches emerged. National or universal approaches, which were supposed to contain the appropriate mix of learning ingredients for all learners, have always been around to affect the tenor of the educational climate. These efforts, and the movements they have created, have generally been sporadic and the specific plans were seldom widely adopted over any length of time. "Progressive Education," "The Core Program," "The Community School," and "Career Exploration" are all examples of curriculum movements which became fairly well known but did not receive widespread and long term adoption.

Curriculum *concepts* such as "open education," "competency-based education," and "objective testing" seem to have had more long term effects and are still widely used.

Attempts in the mid-sixties at "nationalizing" curricula was evidenced by efforts such as: the "new mathematics," "team teaching," "PSSC Physics," "Head Start," "educational television (ETV)," the "New Biology," and "language laboratories." Teacher aids, media experts, and new planning and instructional strategies also appeared on the scene. New textbooks — now more colorful and fun to read, wildly illustrated student activity manuals, and more informative teacher handbooks bombarded the educational arena almost overnight. Funded projects at the Universities directed toward teacher in-service workshops and institutes were directed toward helping teachers to update content and improve their methods and instructional strategies. "Experts" and "outstanding authorities" emerged from all corners. New state curriculum guides funded by interested State Departments of Education added more tinder to the already rapidly burning intellectual fire.

There have been many attempts at assessing the effectiveness of these plans, strategies, and methods. Data from these analyses has and will continue to help in re-shaping the nature and characteristics of American education. In terms of long term

adoption however, few of these “national” efforts have been successful in evoking significant advancement in their disciplines.

Frymier points out that behavior is a function of how things seem to be. To educators, who are subjected to externally-imposed curricular change, what things really are is never as important as how things seem to be. People react to the facts as they understand them. It is essential to start the process of curriculum design with people where they are. People must move from the known to the unknown. Before movement can be made to a higher level one must start at the level where the individual is. (Frymier, 1970, pp. 25-27).

Most of the national approaches to curriculum design, in all disciplines, ignored the importance of local inputs. Data such as the stage of development of the teacher, the experiential characteristics of the learner, and the nature of the community were seldom given adequate consideration. In any regard, evaluative data on the effectiveness of these approaches has given perceptive educators many new insights on the process of curriculum design, implementation, and adoption. Martin Mayer (1964, 12-13) points to one of the major revelations in his book on social studies in the American schools:

One of the elements that distinguishes teaching from miscellaneous communication is the control of irrelevancies; the goal of teaching is to enable the student to control irrelevancies by himself . . . and (the major function of the curriculum designer is to) generate new models that will help him to do this.

The idea of controlling irrelevancies means that learners must become more adept at coping and educators must become more proficient at stimulating coping behavior.

An ideational session conducted at Syntectics, Inc., Cambridge, Massachusetts, students, teachers, and young people attempted to summarize their conceptions of the role of education. They felt that education should enable the student to:

cope with their society; understand themselves; care about their future; feel important as individuals; understand the nature of change; learn how to affect change; incorporate classroom learning into their own environments; and transfer concepts learned to future responsibilities.

(McDaniel, in Toffler, 1974, 104)

Every experience that we have, every “happening” that we observe or relate to, and every action that we take or don’t

take serves to broaden our experience pool. Dewey (1902, 8-9) said it beautifully:

The child lives in a somewhat narrow world of personal contacts. Things hardly come within his experience unless they touch, intimately and obviously, his own well-being, or that of his family and friends. His world is a world of persons with their personal interests, rather than a realm of facts and laws.

Education occurs through the process of living. This does not make the role of education any less significant; in many ways it makes it more difficult.

Marshal McLuhan coined the phrase "information implosion," referring to a time when humanity will be confronted with so much information to process that no one will any longer be able to communicate. Alvin Toffler (1971, 234) uses the word "overchoice," referring to social paralysis resulting from too many choices.

Learners must be able to cope with change. This seems to infer that the schools must be concerned with much more than stable knowledge. Motivational techniques must be used that provoke application and affective learning.

For most educators the challenge of transcending from an emphasis on stable knowledge to contested truths and exploratory hypotheses, or from the passive state student (PSS) to an actively involved and self-motivated learner (SML) appears difficult if not unsurmountable. Dwight Allen (1974, 10) points out that:

By moving to a Maslovian psychology of man and a new conception of information we can revise educational content to reflect the challenges we will face in the future. These changes . . . represent my conception of the ideal education system for America for the next thirty years. To implement this conception, we must revise three of the pervasive educational values: our fear of educational change, our myth of educational sameness and our glorification of educational objectivity.

Change is not new to education; all one needs to do is to compare one day with the next to know that change and education go hand in hand. In terms of responsiveness to change, however, education is probably the slowest to evolve of all of the major institutions in our culture. This may be due to the fact that most educational changes made are incremental, and not often highly influential. Changes in curricula have been sporadic,

being in most instances linked to federal funding. New options in instructional hardware have always been available. All that seems lacking is school money to keep pace with the costs of new educational technology.

This is not the case however. Technological hardware and even some tamperings with content are tolerated, but basic philosophies of education and personal attitudes have changed very little during the past several decades. Major changes in attitudes and beliefs necessitate changes in society. American society has changed in many ways, but most of these changes have not yet impacted on education. Furthermore, it seems likely that these changes will not occur to the extent necessary unless educators can assume a more active stance — get in the driver's seat and lead society. This assumes a different plan of attack than waiting passively until society rattles the chain.

The idea of sameness has long been a deterrent to innovation in both teaching and learning. It has even taken on a cultural flavor, with bits and pieces being passed down from generation to generation. Children are taught to conform and they are taught well — with grades and notes in the cumulative file recording critical events. Teachers must also conform to preset stereotypes, ways of operating that will not contrast with the mold established by the middle American. Dwight Allen (1974, 14) points out that:

Our science-minded culture has ridiculed the teaching of subjective opinions and values and has made student evaluation a matter of percentages and numbers. We have glorified the unbiased teacher and the objective grading curve, but we have never really had either one.

Over the last decade efforts concerned with making the process of education more humanistic have become so prevalent that a new movement has emerged, largely in response to "overkill" on objectivity. Some of the branches of the movement have been: "values clarification," (University of Massachusetts), the "Affective Education Project," (Philadelphia Public Schools), "Syncon," (Committee for the Future), and even "Open Education." These different branches vary in emphasis, but in all instances they have been directed toward helping participants in clarifying values and dealing with alternatives.

Louis Rath in *Values and Teaching*, (1966) said that values must meet seven criteria. Value education helps the learners to:



- (1.) *discover what* is important to them
- (2.) *stand up for* what they believe
- (3.) *choose from* alternatives
- (4.) *examine consequences* of alternatives
- (5.) *make free* choices
- (6.) *act on* beliefs, goals, and ideals
- (7.) *develop plans* of action and emphasize cherished values.

Humanistic education implies valuing, searching, exploring, questioning, considering alternatives and learning! Humanistic education involves experiencing and tasting of reality. Dewey (1916, 140) says it well:

Learning from experience is to make a backward and forward connection between what we do to things and what we enjoy or suffer from things in consequence. Under such conditions, doing becomes a trying; an experiment with the world to find out what it is like; the undergoing becomes instruction — discovery of the connection of things . . . experience is primarily cognitive.

Many of the disciplines are confused and haven't found the way to go. Perhaps part of the confusion may be due to the fact that many of the "traditional" disciplines have really given little thought to the responsibility of education and the function of each discipline to it. Goodlad (1966, 92) states:

. . . the objectives of schooling have become the composite of the objectives set for each subject . . . The goals of today's schools do not extend beyond those subjects that have succeeded in establishing themselves in the curriculum.

## **INDUSTRIAL ARTS IN THE OPEN ACCESS CURRICULUM**

Curriculum designers in industrial arts have approached the challenge of curriculum improvement in much the same way as educators in other curriculum areas. Curricular activity in the sixties was intense in nearly every content area, and industrial arts was no exception. Many innovative plans emerged; a handful even gained regional status. Instructional materials, state guides, and even textbooks on the plans emerged — and the quest for national status began.

From a vantage point in the seventies it seems appropriate to reflect on the impact of these efforts. Two probing questions need to be addressed: (1) What was the extent of adoption of

these plans? (Adoption is used here to mean: awareness, interest, evaluation, trial and adoption as adapted from Everett Rogers, *Diffusion of Innovation* (1962), and (2) What impact did they have on the field of industrial arts? Before attempting to provide answers to these questions it may be helpful to view the era in total perspective.

The burst of curricular reform activities that occurred during the sixties provided the groundwork for today's reality. Of the many plans that were developed, today only a handful still remain in operation. Few met with wide spectrum adoption on a regional basis, and continued interest in any single plan across the nation today is not apparent. In spite of all of these efforts it is evident that very few of these plans survived the test of time. This does not mean that they were not influential in altering the character of industrial arts in today's schools. Their impact on the field and influence on the changing character of industrial arts was of great significance. It is largely because of these plans that the profession is once more questioning and reflecting about which way to go.

Part of the confusion is due to the fact that leaders in the field of industrial arts have been guilty of making the same mistakes made by educators in other content areas. In most instances constructive attempts at curriculum change have been made while hanging on to a "security blanket" of stable knowledge — old attitudes, beliefs, content, and methodological "have to's." Seldom have curriculum theorists attempted to determine what "ought to be," analyzed "what is," and formulated appropriate plans of action to get there. In the main, old biases and "mind sets" have contaminated what could be. Consequently the field professes to be moving toward the study of technology, but the movement is seemingly pathetically slow. Departmental names have changed (Industrial arts and Technology, Industry and Technology, and even Technology). Names can be deceiving however. Warner points out in *The Decades Ahead* (1966) that the Guilds Institute in London labeled their program the "Department of Technology." The year was 1900!

**Table 1**

**Curriculum Activity During the Sixties That Influenced Our Present Reality**

**THE PRECIPITATOR:** (Russian introduction of SPUTNIK)

**THE REACTION:** (Funding priorities directed toward Science)

**THE RESULT:**

**IN ALL CONTENT AREAS**

- (1) curriculum emphasis shifted from an emphasis on method to a greater concern for content
- (2) attempts were made to create "national" or "universal" curriculum approaches
- (3) increased efforts were placed on the space effort and science
- (4) increased availability of educational technology and instructional hardware

**IN INDUSTRIAL ARTS**

- (1) most innovative plans emphasized content more than method
- (2) some plans were promoted on a regional or national basis. Today few of these plans are still in operation and none of them in their original form. Many adaptations were made. Elements were taken from one, titles from others. The result seems to be a greater emphasis on clustering common concepts
- (3) some programs began to try to identify with technology (aerospace) but most were still steeped in industry as the primary content base
- (4) when the money ran out some programs focused on multi-purpose equipment and emphasized the idea of flexibility. The concept became the order of the day

- (5) increased interest in alternatives for all learners
- (6) increased interest in accountability
- (7) return of “humanistic education”

- (5) experimentation with team teaching, role playing, mass production, enterprise
- (6) emphasis on behavioral objectives, and more recently, competencies
- (7) some programs began to emphasize futures study, valuing, the birth of the futures movement in industrial arts, increased concern for coping behavior

Other data however, seems to indicate that things are changing. Titles of content areas within departments now often read: communications, manufacturing, production, materials and process, construction, and power and energy. Publications have centered around technology (the theme of several ACIATE yearbooks during the past *ten* years; textbooks during the past *two* years; and occasional articles in *Man/Society/Technology*). AIAA conference themes center around technology and have provided evidence that the field is at a turning point — “Crossroads 76”, and “Which Way Now?”. The field is definitely gravitating toward alternatives, the study of technology (refer to Fig. 4-1).

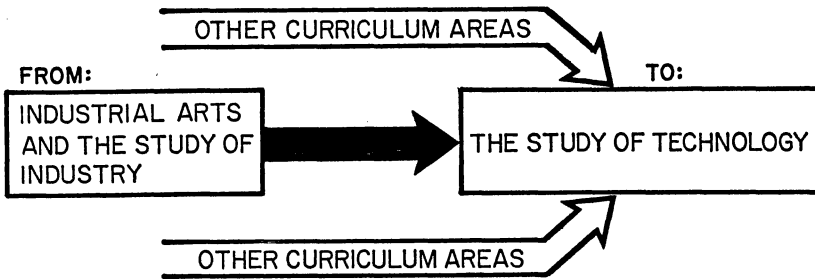

**Fig. 4-1. The Content Emphasis for Industrial Arts is Shifting from Industry to Technology.**

Industry has always been the content base (primary emphasis or source for deriving content) for industrial arts. With an industrial base it was not difficult to know where to go to derive content. All that one had to do was identify the “types” of industry which were prevalent in the American society and the process of content identification was possible through analysis and synthesis.

Other curriculum areas have emerged (construction, manufacturing, etc.) but in nearly every instance the content base has remained the same. With the current movement toward a new content base for industrial arts (technology) the field has pursued the same plan of attack. Types of technology which are prevalent in the contemporary culture have been extracted for study. Figure 4-2 typifies the yield of such an effort.

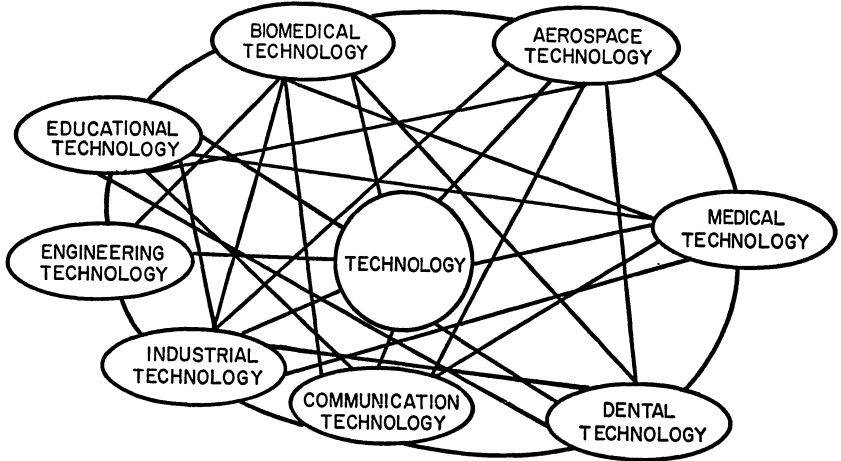

**Fig. 4-2. The Study of Technology — Is It the Study of Types?**

Figure 4-2 shows that there are many types of technology. In fact, industry is one of these major types. This is where the logic of curricular reform in the new industrial arts has gone astray. Since industry is a type of technology (industrial technology) many curriculum designers have assumed that all that is needed to transform a good industrial arts program into a program for the study of technology is to emphasize the industrial technologies. Consequently, many programs have become much like conventional engineering programs, with increased emphasis on math and pre-engineering skills. Most of these programs have become slanted toward the preparation of technicians or management-oriented supervisory personnel. They have retained the old content base (industry) and have professed to move to the new content base (technology). In doing this they have assumed a compromise base — industrial technology. Many of these programs have become so specialized that they have lost track of the original purposes of industrial arts — as general (comprehensive) education essential to all learners.

The study of technology is more than a study of types of technology. Figure 4-3 points out some of the factors that contribute to the construct of technology. It will be noted that the major institutions influencing our culture (religion, family, government, economics, society, and industry) are all cultural deter-

minants. That is, they impact on the development of culture (things passed down from generation to generation). All of these institutions influence each other. They are dynamic (constantly changing) and as such constantly affect both culture and technology. It is these institutions that affects man's use of technology and are influenced in turn. Social groups use the telephone, become dependent on it, and eventually change (attitudes, beliefs, wants, etc.) as a result of it.

What about the structure of technology, the bits and pieces that work together to create the construct? Can't one extract the pieces, study each of them, and then reconstruct the whole? No, it cannot be done like this. Technology is much like a complex systems model. Models are made up of parts. Each of the parts influences each of the others, and in essence, is dependent on them. If the character of one part changes so does the nature of each of the others. Even more importantly, so does the construct of the total model. Technology is like this. It cannot be studied by extracting out specific types (biomedical, dental, agricultural, etc.) for study and then hoping to reconstruct the whole. Technology is like a synergy – it is greater than the sum of the parts (refer to Fig. 4-3). The parts (institutions) represented in the center of the model are institutions that impact on technology

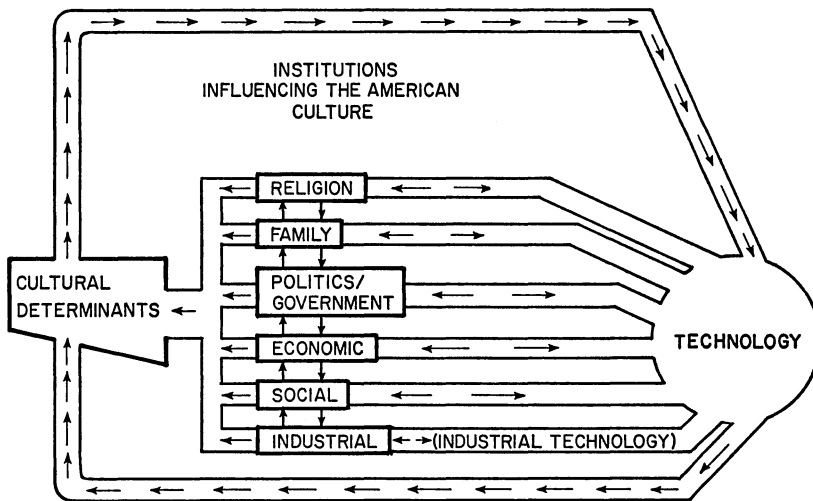

**Fig. 4-3. The Impact of Major Institutions on Technology and Culture.**

and culture, but the study of each of these out of context does not represent the same reality that is created when they impact on each other. This means that a study of these parts will never account for the reality of the whole.

The themes "Crossroads 76" and "Which Way Now?" indicate that the field is again at a turning point in the process of development. Maybe now the conditions are right for the profession to move towards the study of technology.

In this country early efforts such as *The Ohio Prospectus* (1934) led the way for a new industrial arts. Programs began, in varying degrees, to become more representative of contemporary industry and technology and their impact on society. Beginning with the early work of William Warner and others in *A Prospectus for Industrial Arts in Ohio*, the nature of industrial arts began to change. Many examples can be cited, such as the use of descriptors like "communication" and "transportation." Authors of the *Prospectus* (1934, 90) pointed out that:

Any study of the industrial arts unit on transportation, including automobiles, will involve many related studies in the sciences as well as history and geography. The first coast-to-coast railway, for example, greatly affected and stimulated the spread of commerce, the migration of people, and the growth of cities.

While the authors did not use the word technology in the *Prospectus*, it was evident that curriculum design moved in that direction.

Since Warner's early efforts in stimulating the technology movement a great number of new curriculum have emerged. In reality, however, only a very few of these have been significant in advancing the technology movement in this country. The majority of these approaches simply offered new ways for studying industry. In the future, programs such as these, with primary emphasis on industry, will continue to exist, mainly for pre-vocational purposes, but will have little effect on industrial arts in the open access curriculum.

## TOWARD THE MIDDLE GROUND

The technology movement really began to gain momentum with Warner's work in 1934. After his update (1947), called a *Curriculum to Reflect Technology*, three other scholars in the



field (Delmar Olson, Donald Maley, and Paul DeVore) offered new curricular designs which served to further this movement. Each of these designs for studying technology differed in emphasis, largely as a result of the era in which the plan was introduced. Each offered an alternative strategy whereby the field could change to the study of technology. Without the intense dedication and commitment to a cause shared by these men it is unlikely that conference themes like: "Crossroads 76," or "Which Way Now?" would have been formulated.

In the forties Warner's "Laboratory of Industries" at Ohio State gained national prominence. The AIAA feature presentation made by Warner in April of 1947 should help to provide additional perspective prior to analysis:

Content in the new Industrial Arts curriculum is derived via a socio-economic analysis of the technology and not be job or trade analysis as of old . . . Now the subject matter classifications are conceived of as including: Power: tidal, solar, atomic, electrical . . . Transportation: land, sea, air . . . Manufacturing . . . (Warner, 1947, p. 41)

Today one might accuse Warner of mixing apples and oranges, different types and levels of content organizers. He used content descriptors such as power, transportation, and communication with others like manufacturing and management. While the former have significance for many subject matter areas in today's schools, the descriptors, manufacturing and management, relate more specifically to industry. Some of the organizers would have been more appropriate in a program concerned with the study of industry and others with the study of technology. These points are nearly unsequential, however, considering the point in time when the idea was conceived. Many programs today have not even reached this level of development.

Delmar Olson, with his Industrial Arts and Technology approach (1957) offered a new concept base to study technology in Industrial Arts. Olson's early thinking, apparent in his book entitled *Industrial Arts and Technology*, might lead one to the conclusion that Olson assumed a compromising stance between industry and technology as the content base. A closer look at his later writing entitled, *Tecnol-o-gee — Industrial Arts — Interpreter of Technology for the American Schools*, (1972) yields evidence that technology, not industry, was his intended base for curriculum.

Olson offered a transitional approach to the field. He felt that industrial arts was the "interpreter of technology" and as such should emphasize the study of technology rather than the study of industry or industrial technology. This is apparent in his definition of industrial arts (1972, 1):

Industrial arts, a discipline in general education, is the study of the technology: its origins, development, advance, and impact on man, environment, and culture; its technical, social, economic, occupational, cultural, recreational nature, influences and outcomes.

. . . through study, research, experiment, design, invention, construction, and operation with ideas, materials, tools, processes, products, and energies.

. . . for the purposes of acquainting the student with the technological culture, aiding him in the discovery and development, release and realization of his own native potential therein, and enabling him to better cope with cultural and environmental change caused by technological advance.

It is apparent from this definition that Olson advocated the study of technology and its impact on man and culture. Later on he recommends that a technology action area learning environment should include concepts such as wheels, mechanisms, and systems, and content descriptors such as electronics, communications, printing, and photography (p. 16). It seems that here Olson has attempted to show the field that some areas common to industrial arts (electronics, graphic arts) still are viable in his proposed curriculum design. The approach definitely provided a departure from the industrial base, but the strategy for implementing the curriculum design needed further development, refinement, and evaluation. While the definition proposed a comprehensive study of technology the implementation strategy emphasized the industrial technologies almost exclusively. Nevertheless, Olson's thinking had far reaching impact on the transitional stages of the movement.

The development of *The Maryland Plan* by Donald Maley (1959) added a completely new dimension to the study of technology. While both Warner and Olson had emphasized the structure of content, Maley emphasized the human characteristics through identification of "developmental tasks" of youth, and supporting methods to develop these behaviors.

Maley viewed industrial arts as the study of both industry *and* technology, and this approach is evidenced in the program.

At the 7th grade level he recommended an anthropological approach for studying the elements common to all civilized mankind: tools and machines, power and energy, communication and transportation (Maley, 1973, 19). At this level it seems apparent that the program emphasizes content organizers that have validity for both the study of industry and technology.

At the 8th grade level Maley proposes the study of American industry, through the use of the group project method and the line production approach (1973, 19). Here it seems apparent that his primary focus is on industry, or industrial technology.

At the 9th grade level Maley attempts to provide alternative methods for exploration which enable the attainment of the unique characteristics of each individual. Alternatives are provided such as: research and experimentation, the group project method, line production, and others (1973, 19).

Through Maley's development of the Maryland Plan, having emphasis on both industry and technology, it seems evident that he is focusing on industrial technology as the content base for industrial arts. Like Warner and Olson, he provided, and continues to provide, a necessary option in the profession — a strategy whereby educators can continually modify programs to more effectively reflect the rapid changes in technology. Maley has also communicated to the profession that increased emphasis must be placed on the needs of "real learners" in "uniquely different" locales.

Warner, Olson, and Maley were significant in helping the field to move to what might be called the "middle ground" — a position about mid-way between the study of industry and the study of technology. The content base for programs in the middle ground is industrial technology.

## **OPEN ACCESS TECHNOLOGY — A DESIGN FOR SURVIVAL**

Early writing by Paul DeVore (1968) *Structure and Content Foundations for Curriculum Development*, provided the field with an alternative strategy. DeVore emphasized the comprehensive study of technology in terms of major systems, or cultural universals (communication, production, and transportation). DeVore pointed out that: "the technical areas of production, communi-

cation, and transportation are found in all cultures regardless of their stage of development. Hence they meet the criterion of universalism" (1968, p. 12).

During the past five years the Program for the Study of Technology at West Virginia University, under DeVore's leadership, has been involved in developing, implementing, and evaluating field-based programs for the study of production, communication, and transportation systems — emphasizing both technical and socio-cultural aspects of technology. None of these programs have been identical in structure, content, or method. Each has provided alternative designs for the study of technology. The West Virginia effort has provided vital clues regarding the construct and viability of open access technology.

Further attempts at making sense of the content of technology will not be easy, and will take time and thought. This should be expected when addressing content delineation in any developing discipline. The complex nature of technology has certainly not been simplified by many of the most prominent writers.

Jacques Ellul, *The Technological Society*, (1964) caused many scholars to reconsider the impact of technology on society. In fact, largely as a result of Ellul's treatise a new "anti-technology" movement has emerged. Writers from all fronts have condemned technology as some sort of Frankenstein monster that can not be controlled and makes human life intolerable. Vestiges of this movement have surfaced in the form of the "new ecology" effort.

Today much of the reflective thinking seems to be even more effectively redirected through efforts such as "intermediate technology," as in E. F. Schumacher's book, *Small is Beautiful*, (1973) and even more recently, the "appropriate technology" movement.

Other writers, such as Henryk Skolimowski (1970), have pointed out that technology is created and directed by man, and as such has no autonomy in and of itself. Skolimowski has done much to operationalize the construct. Figure 4-4 illustrates Skolimowski's concept.

Definitions of technology are not sufficient to explain the phenomenon. This is due primarily to the synergetic nature of technology. Any definition becomes dated before it is put in print.

It is possible, however, to create a construct (understanding) of the phenomenon to facilitate meaningful study.

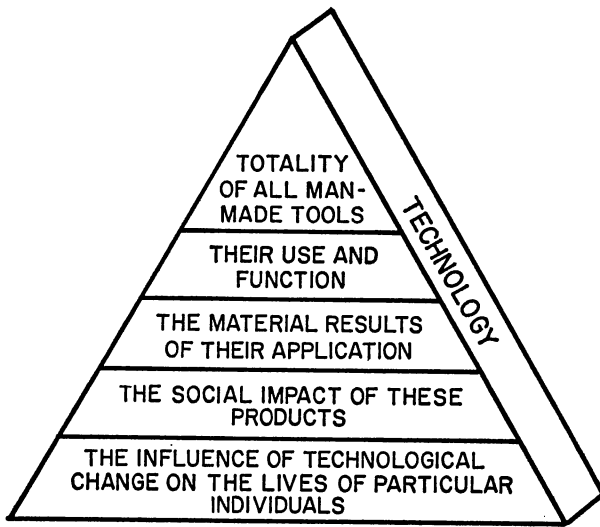
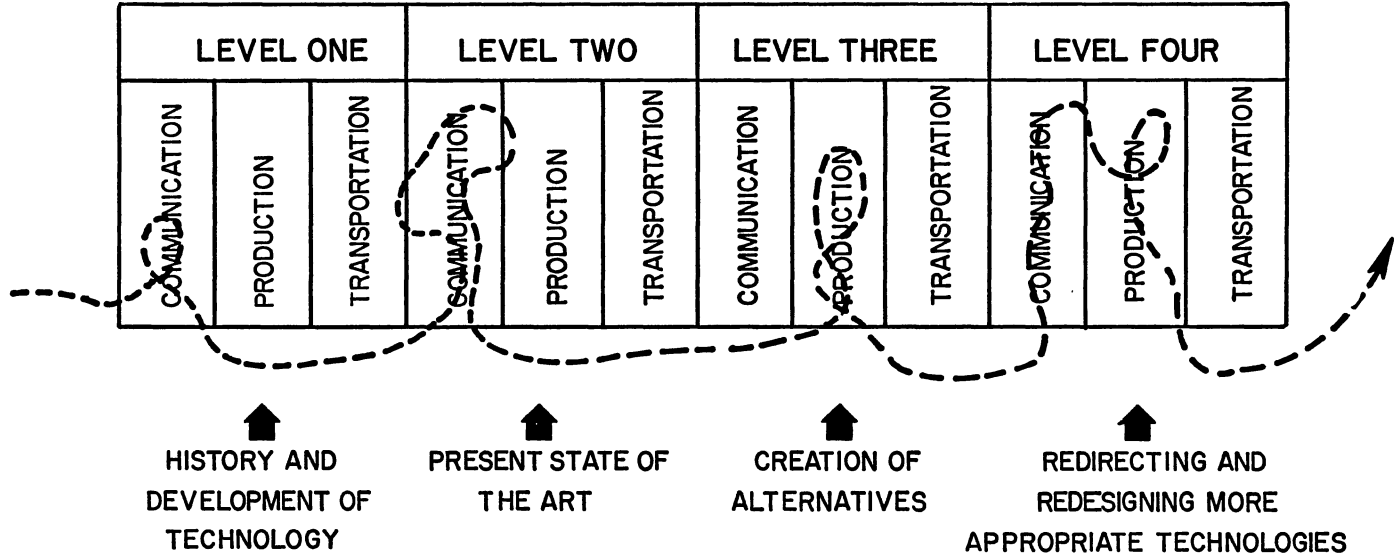

**Fig. 4-4. Skolimowski's Conception of Technology.**

“Construct building” is a uniquely personal experience. Everyone has a different set of life experiences. The experiences contribute to a variety of different constructs of technology. One way that the reader might internalize the problem is by creating a “construct focuser,” a series of sentence fragments which provide revelations of different aspects of technology. By carefully analyzing the fragments one can then begin to understand the threads of meaning which work together to create the synergism called technology. A construct focuser might look like:

systems . . . knowing how . . . tools, their use, product, and effects . . .  
our material culture . . . extensions of man's self . . . an artificial  
phenomena . . . doing . . . shaping and creating . . . making life more  
enjoyable . . . affecting culture . . . organizing rational action.

Further exploration will enable one to discover that technology is artificial (synthetic) — a phenomenon created by man. It involves man's use of natural elements — things like materials, processes, energy, information, machines, and techniques. Technology impacts on society and has always been a fundamental element in the formation of culture. The study of technology includes the study of natural phenomena (materials, energy, resources) and how man uses them.



**Fig. 4-5. Sequencing Content in Open Access Technology.**

It seems sensible to approach the study of disciplines such as technology in systems fashion. Major content organizers such as communication, production, or transportation can be studied at many levels. Since the process of learning occurs both in and out of school, learners might reach a state of preparedness and bypass certain beginning levels. The open access mode affords one the freedom of entry and exit at any level of study. Figure 4-5 presents a concept of how one might approach the sequencing of content for open access technology.

Level one, the history and development of technology, would enable the learner to discover the origins, evolution, and significance of foundational technical developments that impacted on society. This would provide the groundwork for the study of present-day technology. Why do we follow present day practices? Why does it work like it does? How does the whole operation fit together?

Level two learnings involve the development and refinement of competencies in duplicating the present state of the art. This would include actions such as: observing, comparing, practicing, imitating, and evaluating. Level two would provide answers to the "how" and the "why."

Level three would deal with the discovery and creation of alternatives. What might be a better way? New technologies are created this way, by reflecting, comparing, contrasting, and recreating.

Level four deals with the assessment, evaluation and promotion of the better way (the concept of appropriate technology). What technological solution might be developed that would consume fewer natural resources, would be more labor intensive, and would have a more humane impact on society?

This contrasts greatly against traditional education where learning often takes place something like this:

- (1.) The student learns of the historical significance of the technology: what is communication technology; how did we get to the development of the television; who was responsible . . .
- (2.) After the student develops an appreciation for, and an understanding of communication technology the next phase of learning can take place.
- (3.) Next the student observes and practices techniques used in communication technology. The instructor first demonstrates the process then the student mimics the actions of the instructor. After

continued practice the student is said to be competent in the specific process.

- (4.) The student goes to the next process, and when he has “learned” each process an understanding of communication technology is said to have occurred.

Let’s stop at this point and consider what has transpired. Refer to Fig. 4-6. The student studies the past and the present (points one and two). Seldom do they transcend beyond this point. Although some may filter beyond to point three (creation, innovation), a very few will ever reach point four. Seldom will their learnings ever have any real effect on the pool of stable knowledge (points one and two).

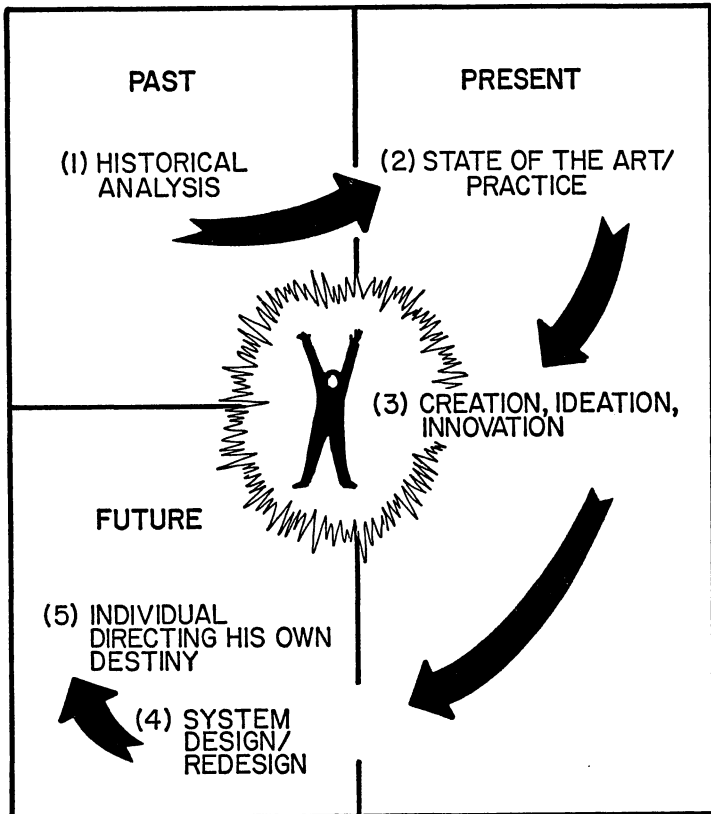

Fig. 4-6. The Learning Curve.



All indication seems to be that the cultural universals introduced by DeVore have viability for the future. What is now needed is for others to also take up the charge. Content models must be developed, compared, contrasted, debated, and modified. Eventually, with continued awareness and reflection, a much greater consensus of agreement on the structure of each of these system areas will occur. No longer will questions relating to the "what" of open access technology have to be asked.

Open access technology does not end with a consensus of agreement on the content universals and system relationships. Also needed are lists of possible learning activities and instructional strategies which might be used to implement the content in the classroom. The content analysis, alternative learning activities, and instructional methods represent what might be called an ideal or "grand plan." This plan may or may not work in the real world. The final element of success is dependent on how well the curriculum innovators mesh the plan with the "real needs" of the adopting community. Questions will need answers. What methods will work best with which learners? What teachers should be involved with which kids in the open access technology laboratory? What community resources are available to support the activity?

## **INSTRUCTIONAL STRATEGIES IN OPEN ACCESS TECHNOLOGY**

The concept of open access technology necessitates a variety of instructional strategies for motivating learners. Techniques will be cultivated which will facilitate both individual and group learning, but since no two learners learn exactly the same way, prefer exactly the same instructional strategies, and have exactly the same experiential frames of reference, teams of facilitators with a variety of instructional options will be needed.

Teaching the new technology will require a different awareness toward learning and knowing. In a change-oriented environment there will be no single "correct" answers, only alternatives. There will be no handbook of "have to's" certain instructional tricks that will be used to "turn on" learners. Some techniques will be found effective while others will be redesigned for use with other learners at other times.

It is not necessary to speculate on what types of instructional methods will likely be used in open access technology. In a study conducted by DuVall, Krajeski, and Chowdhury (1977, 5) at West Virginia University, the authors investigated the critical factors that affected creative behavior. The study illuminated key constructs (attributes) most frequently reported by forty-nine authors on creativity. In the final analysis three major attributes received the greatest frequency of mention. These were:

- (1.) Sensitivity: stimulated by everything around them — open to new experiences.
- (2.) Self-confidence: aware of their ability to create to the extent that they themselves are the most critical evaluators.
- (3.) Synergetic: able to think in terms of relationships and to skillfully reconstruct new realities from old experiences and new knowledge.

These attributes should be relevant here. They provide the basis for selection of techniques most likely to succeed in the open access technology environment.

How about the instructional techniques that you now use in your own environment? Do they really help to promote creative behavior and strengthen the potential of open access? Refer to Table 2 and take the test yourself.

Many methods that stimulate participatory involvement are gaining in popularity: synectic mechanisms, gaming, the use of the metaphor, systems modeling, simulations, scenario building, dialogue focusers, the seminar, and many more. One day learners will no longer be forced to learn, but through appropriate matching of method and learning styles will want to learn. Passive, non-responsive learners will no longer exist. Those who do not want to learn will not be in school.

Open access technology represents an attitude, a belief that all that happens in life is a potentially educational event. A society that is really concerned with life-long learning will be one that accepts and respects varied ways of thinking and doing. We will be ready with open access technology. How about you?



## REFERENCES

- Allen, Dwight. What the Future of Education Might Be. In Theodore Hipple, *The Future of Education: 1975-2000*. Pacific Palisades, California: Goodyear Publishing Company, 1974.
- DeVore, Paul. *Structure and Content Foundations for Curriculum Development*. Washington, D. C.: American Industrial Arts Association, 1968.
- Dewey, John. *Democracy and Education*. New York: Macmillan, 1916.
- Dewey, John. *The Child and the Curriculum*. Chicago: The University of Chicago Press, 1902.
- DuVall, J. Barry, Krajewski, Richard, and Chowdhury, A. *What Makes Johnny Creative?* (research on creativity conducted at West Virginia University, Morgantown, West Virginia), March, 1977.
- Ellul, Jacques. *The Technological Society*. New York: Alfred A. Knopf, Inc., 1964.
- Goodlad, John. *The Changing School Curriculum*. New York: The Fund for the Advancement of Education, 1966.
- Maley, Donald. *The Maryland Plan — the Study of Industry and Technology in the Junior High School*. New York: Benziger Bruce and Glencoe, Inc., 1973.
- Mayer, Martin. *The Social Studies in American Schools*. New York: Harper and Row, 1964.
- McDaniel, Michael A. Tomorrow's Curriculum Today. In Alvin Toffler, *Learning for Tomorrow*. New York: Vantage Books, 1974.
- Olson, Delmar. *Industrial Arts and Technology*. Englewood Cliffs, New Jersey: Prentice-Hall, Inc., 1963.
- Olson, Delmar. *Tecno-lo-gee — Industrial Arts, Interpreter of Technology for the American School*. Raleigh, N. C.: Office of Publications, North Carolina State University, 1973.
- Raths, Louis E., Merrill Harmin, and Simon, S. *Values and Teaching*. Columbus, Ohio: Chas. E. Merrill, 1966.
- Rogers, Everett, M. *Diffusion of Innovation*. New York: The Free Press, 1962.
- Schumacher, E. F. *Small is Beautiful — Economics as if People Mattered*. New York: Harper and Row, 1975.
- Skolimowski, Henryk. "Extensions of Technology: from Utopia to Reality," presentation made at the American Industrial Arts Association National Conference, Louisville, Ky., 1970.
- Toffler, Alvin. *Future Shock*. New York: Bantam Books, 1971.
- Toffler, Alvin. (ed.) *Learning for Tomorrow — the Role of the Future in Education*. New York: Vantage Books, 1974.
- Warner, William. *A Curriculum to Reflect Technology*. AIAA Feature Presentation, April 25th, 1947. Columbus: Epsilon Pi Tau, Inc., 1965.
- A Prospectus for Industrial Arts in Ohio*, The State Committee on Co-ordination and Development of Industrial Arts Professional Interests in Ohio. Columbus: State Department of Education, 1934.
- Warner, William E. *The Decades Ahead*. Columbus: Epsilon Pi Tau, Inc., 1966. p. 8.



*Dr. Lowell S. Zurbuch*

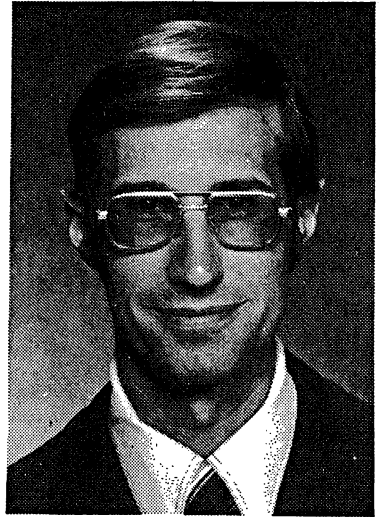

Lowell S. Zurbuch received his B.S. and M.A. from Kent State University as a student of Delmar W. Olson. His Ph.D. was granted by Michigan State University. During residency at Michigan State, Dr. Zurbuch served as a research assistant to Dr. George Ferns who wrote *Michigan's Vocational-Technical Education Personnel Development Needs 1971-1975*.

Dr. Zurbuch's dissertation, "A Study of the Acceptance of Open Education Concepts by Industrial Arts Teacher Educators", was directed by Dr. C. Blair MacLean and believed to be one of the earliest studies of open education within industrial arts. His interests extend to instructional development, instructional television, and cinematography. He has directed and produced a 16mm motion picture, "The Poor Scholar's Soliloquy", which was written by Stephen Corey. The film, including a poignant vignette as to the misuse of industrial arts, is available for rental from Kent State's Audio-Visual Services. Currently, Dr. Zurbuch serves as Assistant Professor of Technology at Kent State where he teaches undergraduate courses in technical drawing and design and graduate courses in evaluation and contemporary theories.

# The State of the Art- Industrial Arts in the Open Access Curriculum

*Lowell S. Zurbuch*

## STATUS OF OPEN EDUCATION TODAY

Although open education received considerable attention in the literature and within the schools only a few years ago, it must be admitted its clout has considerably diminished. The 1975 Gallup poll indicated only 27% of those interviewed had even heard of open education and with approval coming from only 13% (Sealey, 1976, p. 615). What has led to the decline of its impact? Numerous factors both within and outside the schools have affected change away from open education.

It was a period of advocacy during the late 60's and early 70's with considerable philosophic and psychological arguments in favor of open education but with precious little research findings save that of Great Britain's Plowden Report (National Union of Teachers, 1969). Much of the early literature castigated school practices as exemplified by Charles Silberman's *Crisis in the Classroom*. While not dismissing truly remarkable achievements within America's schools, the fact remains that gross shortcomings exist. During a period of enormous social upheaval ranging from the civil rights movement to the war in Viet Nam, it is not surprising that our schools were criticized.

Perhaps it was too much to expect that open education would solve the problems which lie deep. Donald Armstine was led to describe open education as "an aspirin for the plague" (Nyberg, 1975, p. 160). He questioned whether the bureaucracy

found in schools allows for truly open education practices to repair the educational program. Much of the current literature suggests agreement that open education's shortcomings are not so inherent but rather caused by misinterpretation.

A composite of positions taken by Myers, Sealey, Rogers, Barth, and Cremin suggests we borrowed too freely from informal education practices found in Great Britain without realizing how American and English parents differ. English parents tend to afford considerable autonomy to school personnel concerning school practices while Americans see an education as a vehicle to success and upward social mobility. As a result we find ourselves caught up in a quest for improvements at a near mania level. New programs and innovations have been prized too often for their freshness rather than their validity or worth. Rogers notes how programs are conceived in the fall, implemented during the spring, and discarded during the summer in favor of the coming fall's new program. He suggests we become more realistic and design five- or ten-year plans. Change is far easier than the agony of refinement growing out of the absence of an unsteady philosophy and psychology. Rogers has cautioned against over-reliance of experts imported to solve problems or implement change (Rogers, 1974, p. 23).

Even today many writers continue to respect open education's credibility, but point out shortcomings of implementation. These range from the false assumption that open education should be free of structure, to the shortage of appropriate resource materials other than common texts which lead to closure of ideas, a failure to capitalize upon instruction by peers, and too much faith in intrinsic motivation. Sealey, after observing many open classrooms, found many activities centered around problem-solving rather than problem-finding (Sealey, 1976, p. 627). (Those of us involved with industrial arts would do well to ponder such notion.) Also Barth cited the need for universities to serve as agents of educational change. He charged that what is most needed in open education teachers, as all others, is a strong sense of security and maturity. He feels there is danger from those liberals drawn to teaching suffering an identity crisis (Barth, 1972, p. 207).

Cremin and others suggest those promoting curricular change appear to be ignorant of the significance of the Coleman



report including the effects of the "hidden curriculum" (Cremin, 1974, p. 73). Apparently those promoting open education have failed to heed the mistakes which led to the decline of progressive education.

Currently the back-to-basics movement is receiving considerable attention and support. Van Til comments that the back-to-basics movement is being led by dissatisfied parents, more so than educators, who desire a return to a simpler but unavailable society and educational results seemingly not produced by open education (Van Til, 1975, p. 8). Frustrated parents find in the schools the only reachable governmental body in which their wishes can be felt. Again the Gallup poll discloses that parents select discipline as the highest priority within the schools (Gallup, 1975, p. 236).

What lies ahead for open education? Myers forecasts that its adoption will be limited, partially due to the shortage of required competent teachers. As such, its continuance will probably be limited to the earlier grade levels (Myers, 1974, p. 64). Sealey is prompted to suggest that open education will be limited as long as the mistaken belief is held that achievement levels are to be expected even though the level is one of mediocrity (Sealey, 1976, p. 626).

A growing number of open educators now appear to at least accept portions of Ivan Illich's beliefs found in *Deschooling Society*. Such a belief suggests an over-reliance on schools. It is held that society itself must be altered for the realization of human potential. We remain "school bound" by not accepting that education occurs elsewhere besides the schools.

When implemented, proponents agree that open education must be chosen rather than forced. Likewise Rogers cautions against the danger of monolithic change (Rogers, 1974, p. 24). It is most important that students encounter meaningful and wholesome experiences be it in an open or traditional classroom.

### Research Findings

Considerable research findings now exist which were unavailable only a few years ago. Not all studies are in agreement as is often the case. Attention herewith is directed to open education research concerning academic achievement, creativity, and personality factors.

One of the finest sources of open education research findings is provided by the North Dakota Study group on Evaluation which reports on academic achievement as well as other topics. Fifty-seven study results were reported concerning comparisons between open and traditional classrooms on academic achievement. Results are as follows: 3.5% disclosed no consistent differences; 7% of the studies indicated traditional schools were better; 17.5% indicated open classrooms were better; no significant difference was able to be determined in 40.3% of the research findings; 29.8% provided mixed results; and 1.7% through poor methodology were inconclusive (Horwitz, 1976, pp. 20i - 20xviii).

Certain studies also have been directed toward measuring creativity in open and traditional classrooms. Solomon and Kendall cite numerous studies indicating open education is superior for creativity (Solomon and Kendall, 1976, pp. 613-625). Other studies are less able to conclude open education categorically promotes greater creativity. When sixty students enrolled in grades 1, 4, and 8 were administered the Torrance Tests on Creative Thinking, results disclosed that open education students were superior on figural creativity while traditional students excelled in verbal creativity (Ramey and Piper, 1974, p. 560). Another study of forty-eight fifth graders found that open education affects social behavior and independence in approaching tasks more than creative thinking (Sullivan, 1974, p. 500).

Other studies have concentrated on whether open education affects personality and related matters. A study of 115 fourth grade students enrolled in traditional and open classrooms disclosed that the personal characteristics of entering students most affects their performances, but evidence gathered suggested the open programs may have some influence independent of entering characteristics (Solomon and Kendall, 1976, p. 623). Open education has been promoted for fostering healthy self-concepts within students and positive attitudes toward school. A study attempting to determine whether such claims are valid disclosed no such difference between open and traditional classrooms although the investigators note inconsistencies with Purkey's work. (Klaff and Docherty, 1975, p. 102). An associated study of Ross and Zimiles revealed less destructive behavior from students enrolled in open education classrooms (Rogers and Church, 1976, p. 83).

Two separate studies explore whether sex and age make any difference in acceptance of open education environments. Arlin cites many studies designed to measure whether students enrolled in open education have more positive attitudes toward school than those enrolled in traditional schools. Results were inconsistent and limited to students in grades 1 - 3. Therefore a study of 2,000 students enrolled in grades 1 - 8 was conducted. Results disclosed that young students and also older boys preferred traditional schools. Open classrooms were preferred by young girls and older students of both sexes (Arlin, 1976, pp. 223-224). A similar study of thirty girls and thirty-two boys aged 8 - 10 tended to support Arlin's findings. This study found that both sexes were better able to cope with the open education environment than that of the traditional school. However, the gains were greater for girls. It was found that girls were more conscientious in open classrooms than in traditional programs (Farrall and Thaller, 1976, p. 445).

Teachers too were studied to assess whether personality traits affect success as an open educator or traditional teacher. Sixty teachers whose abilities were rated high and low within open and traditional schools were tested using the Edwards Personal Preference Schedule and the Thurstone Temperament Schedule. Results disclosed no significant personality differences between high- and low-rated open and traditional teachers (Coletta, 1975, p. 251).

Although considerable research supports open education practices, there are those who continue to warn about interpretation of research results. Rogers argues that as yet research techniques lack sophistication appropriate to the uniqueness of open education. He contends that simple paper and pencil testing is inappropriate for an educational opportunity whose effects may not be fully realized and appreciated until much later (Rogers, 1974, p. 24). Accordingly Skager notes that all too often the product or outcome of an education is evaluated rather than the process of learning (Goodlad *et al.*, 1975, p. 100).

## **INDUSTRIAL ARTS AND THE OPEN ACCESS CURRICULUM**

As open education literature swept across our country during the late '60's and early '70's, one schooled in the industrial

arts might naturally be expected to reflect upon such "new concepts." It was, as it were, an academic *deja vu*. Wasn't much of open education drawn from progressive education? Doesn't industrial arts find itself buttressed upon an open education foundation?

Thus began a multi-faceted doctoral dissertation at Michigan State University to document industrial arts' open education heritage and to also attempt to determine whether such beliefs are today held by industrial arts teacher educators (Zurbuch, 1973).

While it is not the purpose of this chapter to isolate on the past, it should be noted that industrial arts indeed has an open education heritage. Using a number of rare books of the late William E. Warner's personal library, now housed at Kent State University's Library, evidence was provided to establish such a bond. Countless times early industrial arts authors expressed what are now known as open education beliefs. For example, William Hunter spoke out for socialization of tests (Hunter, 1938, p. 5) while Richards had applauded the freedom and unexpected results of Gary, Indiana's industrial arts program (Richards, 1918, p. 111). Frederick Bonser, as one of industrial arts' finest scholars, saw so clearly what can only be regarded as open education concepts with implications for industrial arts. He wrote of how the traditional school tends to be in conflict with the society and the difference between a rigid curriculum as opposed to one adjusted by needs and circumstances. Furthermore he questioned whether there can ever be homogeneous grouping (Bonser, 1932, p. 248). Also recognizing the open access nature of industrial arts, William E. Warner, as one of our strongest leaders, wrote of industrial arts existing in many places other than the schools. Clearly speaking for an open access curriculum, Warner advocated an industrial arts curriculum as a "point of departure" (Warner, 1934, p. 26). Perhaps one of the most cogent thoughts was expressed by Lee Hornbake when he wrote, "Industrial arts for *all* should also mean industrial arts for *each*" (Hornbake, 1955, p. 1).

The preceding is but a vignette of how earlier industrial arts leaders advocated open education concepts. It is uncanny how a lineage of industrial arts leaders long ago expressed views nearly verbatim with those presently called open education.

Others too have acknowledged the rather unique insight early industrial educators had for the role of schools in one's education. Lawrence Cremin in his thorough study of progressivism within the schools credited founding industrial educators, John Runkle and Calvin Woodward, and agriculture educator, Liberty Hyde Baily, as leaders in educational reformation (Cremin, 1964, pp. 23-78). While it is gratifying to demonstrate that many industrial arts leaders have been pacesetters in curriculum innovation, there is considerable danger in complacency.

*Design of the study.* Having established that industrial arts has in its past an affinity toward open education concepts, it became important to determine whether today those concepts are accepted. Thus, the author began a research activity to determine whether industrial arts teacher educators accepted open education concepts. Questionnaire results were examined to determine whether the population accepts open education beliefs.

*Population description.* The American Council on Industrial Arts Teacher Education (ACIATE) was selected as the organization to participate in this study for several reasons. Membership in the ACIATE by industrial arts professors throughout the United States is assumed as being an indication of each member's professional concern for the welfare and promotion of industrial arts. The ACIATE membership roles also contain a leadership cadre which parallels early industrial arts leaders. Therefore, the ACIATE today serves as a group of industrial arts teacher educators whose attitudes toward education can be compared with beliefs held by earlier industrial arts leaders. In regards to size, the 1970-1971 ACIATE membership directory, the most current directory at the time of the study, listed 1,096 members of which 300 names were computer selected for the study. Presumably educational attitudes held by teacher educators within the ACIATE have a strong impact on the attitudes held by all industrial arts teachers throughout the United States.

*Instrument description.* Concurrently a search was underway to select or design an instrument which purportedly measured the participants' attitudes toward open education. A questionnaire for such a purpose was found in *Phi Delta Kappan* magazine (Barth, 1971, pp. 98-99). The questionnaire had been prepared by Dr. Roland Barth as a part of his doctoral disserta-

tion at Harvard University after he and a colleague, Dr. Charles Rathbone, visited informal classrooms throughout Great Britain. Permission was granted to use the Barth Scale by its author and publisher.

There were few instruments suitable for measuring attitudes pertinent to open education. However, it is noteworthy that John Holt, a noted open education writer, contends the Barth Scale is the most accurate, comprehensive, and concise statement on open education.

*Validity.* Dr. Barth has not subjected his scale to any statistical treatment. Fortunately, however, Anthony Coletta at the University of Connecticut undertook as his research the validation of the Barth Scale. He found the Barth Scale to be valid (Coletta, 1972, pp. 1-2).

*Reliability.* Coletta does not report the reliability of the Barth Scale during his study. However, the Barth Scale was examined for its reliability when administered to the ACIATE sample and is subsequently reported.

*Factor analysis.* Coletta subjected the Barth Scale to factor analysis. Construct validity testing for interrelationships was achieved by administering the Barth Scale to 191 elementary teachers including 78 open and 113 traditional teachers from throughout the Atlantic states. Consequently, Coletta utilized a principal components analysis and an obliquimax transformation to achieve a 28 x 28 matrix. (Items 10 and 22 on the original Barth Scale were combined.)

As a result Coletta found the Barth Scale contains eight factors but chose to classify only seven factors inasmuch as one factor was comprised of but one item. It should be noted that the Barth Scale items were reordered between the *Phi Delta Kappan* article, Coletta's testing of the instrument, and its administration to the ACIATE. This was required for printing convenience. However, it should be noted that items on Coletta's instrument were juxtaposed with the ACIATE questionnaire to assure identical items comprise the seven factors.

*Data collection and processing.* Within three weeks 66% of the participants had returned completed questionnaires. A follow-up letter for non-respondents was prepared which realized a total response of 83.6%. Data was thus analyzed by totaling the sum of each participant's responses to produce a value indicative of

the ACIATE's acceptance of open education. An item analysis was also employed to produce means and standard deviations.

A subsequent investigation was initiated for correlations between age and open education acceptance. Likewise a correlation between years of teaching and acceptance of education concepts was performed. An estimate of reliability was also performed as previously mentioned.

Univariant analysis of variance was also performed to determine whether variance of open education acceptance by geographical regions existed within the ACIATE membership.

Regional differences were also examined by the use of computer graphics. Four national maps showing regional variances were displayed graphically. The maps include plan views by the choropleth and isarithm (contour) methods, utilizing the Michigan State University Symap program. Similarly block diagrams (three view perspective) displayed by the choropleth and isarithm techniques were made.

*Testing and hypotheses.* The hypotheses were that industrial arts has an open education heritage and that industrial arts teacher educators continue to hold beliefs about learning and knowledge which are in agreement with open education concepts. The information strongly suggests that the first hypothesis is true; namely, industrial arts has an open education heritage. Repeatedly it was found that many industrial arts authors over the years have expressed views which are virtually identical to those now expressed by open educators.

To test the remaining hypothesis, the Barth Scale was administered to a random sample drawn on the membership of the American Council on Industrial Arts Teacher Education. Table 4-1 provides an explanation of the numerical assignment procedure.

**Table 1**

**Numerical Assignment of Responses to Barth Scale**

Response	Value × 29	Total Score
Strongly Agree	1	29
Agree	2	58
No Strong Feeling	3	87
Disagree	4	116
Strongly Disagree	5	145

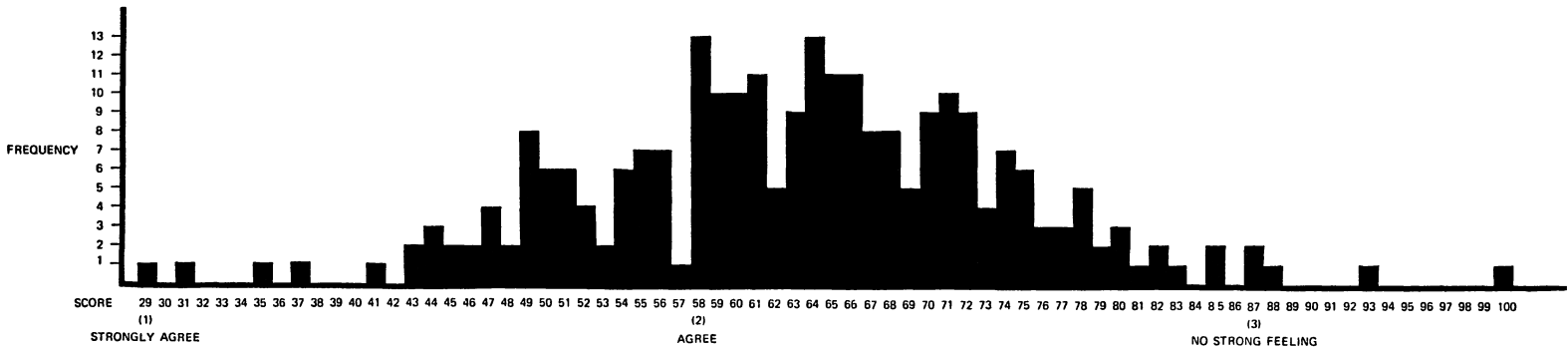
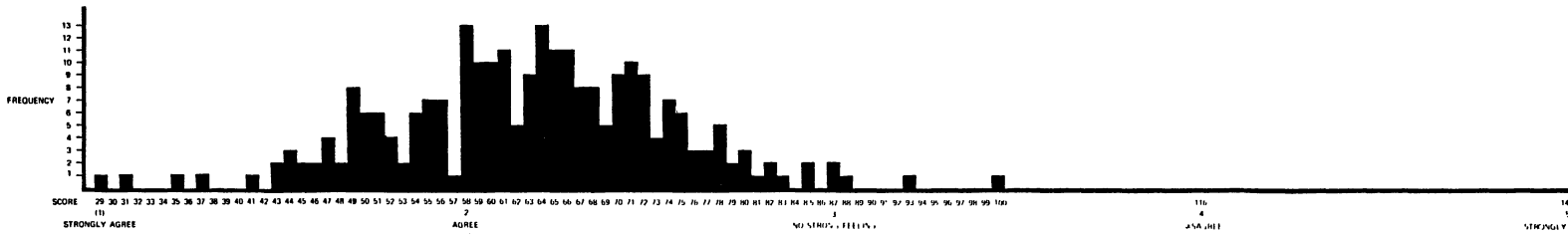

MEAN - 63.1

POPULATION - 1,096

MEDIAN 63.6

RANDOM SAMPLE 300

STANDARD DEVIATION 10.82

RESPONSE 83.6% N 251

**Fig. 5-1. ACIATE Aggregate Responses to Barth Scale.**



Analysis of the data discloses a mean of 63.1 for the 251 respondents, which falls very close to the specific agree value of fifty-eight as shown on Table 1. Accordingly with the mean of 63.1 and a standard error of .68, the mean of the entire ACIATE membership to the Barth Scale can be predicted. Thus with 95% confidence the population mean can be predicted to be no less than 61.77 nor no more than 64.43. Inasmuch as 300 members of the 1,096 membership for 1970-1971 of the American Council of Industrial Arts Teacher Education were polled and 251 (83.6%) responded, one may reasonably infer that the mean is characteristic of the entire organization.

An examination of the aggregate scores of all respondents is herewith reported in Fig. 5-1. Note that one individual strongly agreed with all open education assumptions on the Barth Scale. The other extreme is provided by a respondent whose score was 100, which nearly classifies him as disagreeing with all open education assumptions on the Barth Scale.

Figure 5-1 represents the acceptance the respondents from the ACIATE gave to the Barth Scale. Results strongly suggest industrial arts professors in the main favor open education concepts.

*Item Analysis.* In addition to examining the ACIATE response to the complete Barth Scale, it is worthwhile to reveal responses to individual items. Herewith are the individual items including means and standard deviations.

---

Assumption 1: Children are innately curious and will explore their environment without adult intervention.

SA = 43.0%	A = 42.2%	NSF = 10%	D = 3.2%	SD = 1.6%
1	2	3	4	5

N = 251    Mean = 1.781    Standard Deviation = .8694

SA = Strongly Agree    A = Agree    NSF = No Strong Feeling  
D = Disagree    SD = Strongly Disagree

---

Assumption 2: Exploratory behavior is self-perpetuating.

SA = 16.7%	A = 49.4%	NSF = 20.7%	D = 11.2%	SD = 2%
1	2	3	4	5

Mean = 2.323    Standard Deviation = .9484

**Assumption 3: The child will display natural exploratory behavior if he is not threatened.**

SA = 33.1%	A = 52.6%	NSF = 10%	D = 4%	SD = 0.4%
1	2	3	4	5

Mean = 1.861 Standard Deviation = .7801

Reaction to Assumptions 2 and 3 appear to indicate industrial arts professors believe children are responsible for initiating and sustaining learning. Undoubtedly teachers are obliged to guide toward general objectives and intervene when safety is an issue.

**Assumption 4: Confidence in self is highly related to capacity for learning and for making important choices affecting one's learning.**

SA = 49.4%	A = 36.3%	NSF = 8.8%	D = 4.4%	SD = 1.2%
1	2	3	4	5

Mean = 1.717 Standard Deviation = .8875

Reaction to Assumption 4 supports a belief that industrial arts offers many children success which is perhaps unobtainable in the academic disciplines. Industrial arts may not merely be easier but rather a better facilitator of learning.

**Assumption 5: Active exploration in a rich environment, offering a wide array of manipulative materials, will facilitate children's learning.**

SA = 62.9%	A = 33.9%	NSF = 2.4%	D = 0.4%	SD = 0.4%
1	2	3	4	5

Mean = 1.414 Standard Deviation = .6030

Such a reaction to Assumption 5 is hardly unexpected in industrial arts inasmuch as it should be a rich environment offering a wide array of manipulative materials.

**Assumption 6: Play is not distinguished from work as the predominant mode of learning in early childhood.**

SA = 42.2%	A = 39.4%	NSF = 12%	D = 4%	SD = 2.4%
1	2	3	4	5

Mean = 1.849 Standard Deviation = .9471

**Assumption 7: Children have both the competence and the right to make significant decisions concerning their own learning.**

SA = 10%	A = 34.7%	NSF = 17.5%	D = 31.5%	SD = 6.4%
1	2	3	4	5

Mean = 2.896 Standard Deviation = 1.1442

The diversity of opinion revealed in Assumption 7 is probably caused by the uncertainty over the extent implied by the term "significant" decisions. It should be noted that a great deal of industrial arts literature advocates the desirability of student project selection to promote creativity among other desirable traits.

---

Assumption 8: Children will be likely to learn if they are given considerable choice in the selection of the materials they wish to work with and in the choice of questions they wish to pursue with respect to those materials.

SA = 20.3%	A = 55%	NSF = 16.3%	D = 7.6%	SD = 0.8%
1	2	3	4	5

Mean = 2.135    Standard Deviation = .8518

---

Assumption 9: Given the opportunity, children will choose to engage in activities which will be of high interest to them.

SA = 44.2%	A = 47.8%	NSF = 4.4%	D = 2.4%	SD = 1.2%
1	2	3	4	5

Mean = 1.685    Standard Deviation = .7698

---

Reaction to Assumptions 8 and 9 appear to support the belief that industrial arts offers a diverse choice of materials, problems, and enjoyable activities.

---

Assumption 10: If a child is involved in and is having fun with an activity, learning is taking place.

SA = 25.1%	A = 37.5%	NSF = 20.7%	D = 12.7%	SD = 4%
1	2	3	4	5

Mean = 2.331    Standard Deviation = 1.1055

---

Perhaps concern is expressed to the reaction to Assumption 10 to the uncertainty over types of activities. A misinterpretation could lead to activities which are miseducative or entirely recreational.

---

Assumption 11: When two or more children are interested in exploring the same problem or choose the same materials, they will often choose to collaborate in some way.

SA = 11.2%	A = 56.2%	NSF = 24.7%	D = 8%	SD = 0%
1	2	3	4	5

Mean = 2.295    Standard Deviation = .7699

---

Assumption 12: When a child learns something which is important to him he will wish to share it with others.

SA = 22.7%    A = 50.2%    NSF = 23.9%    D = 3.2%    SD = 0%  
 1                    2                    3                    4                    5  
 Mean = 2.076    Standard Deviation = .7683

Reaction to Assumptions 11 and 12 tend to support the desirable social relationships cited as a goal by Wilber (Wilber, 1954, p. 83).

---

Assumption 13: Concept formation proceeds fairly slowly.  
 SA = 12%    A = 47.8%    NSF = 20.7%    D = 15.1%    SD = 4.4%  
 1                    2                    3                    4                    5  
 Mean = 2.522    Standard Deviation = 1.0288

---

Assumption 14: Children learn and develop intellectually not only at their own rate, but in their own style.  
 SA = 33.5%    A = 52.2%    NSF = 11.2%    D = 3.2%    SD = 0%  
 1                    2                    3                    4                    5  
 Mean = 1.841    Standard Deviation = .7420

---

Assumption 15: Children pass through similar stages of intellectual development, each in his own way and at his own rate and in his own time.  
 SA = 32.3%    A = 54.6%    NSF = 10.4%    D = 2.8%    SD = 0%  
 1                    2                    3                    4                    5  
 Mean = 1.837    Standard Deviation = .7164

The uniqueness of industrial arts apparently is interpreted by industrial arts teacher education in Assumption 13 through 15 as being supportive of a variety of methods and activities to achieve educational goals.

---

Assumption 16: Intellectual growth and development take place through a sequence of concrete experiences followed by abstraction.  
 SA = 14.3%    A = 49.8%    NSF = 25.5%    D = 8.8%    SD = 1.6%  
 1                    2                    3                    4                    5  
 Mean = 2.335    Standard Deviation = .8852

---

Assumption 17: Verbal abstraction should follow direct experience with objectives and ideas, not preceding them or substituting for them.  
 SA = 15.5%    A = 37.8%    NSF = 29.9%    D = 14.3%    SD = 2.4%  
 1                    2                    3                    4                    5  
 Mean = 2.502    Standard Deviation = .9975

Assumption 18: The preferred source of verification for a child's solution to a problem comes through the materials he is working with.

SA = 12.7%	A = 48.6%	NSF = 29.9%	D = 8%	SD = 0.8%
1	2	3	4	5

Mean = 2.355    Standard Deviation = .8329

Reaction to Assumptions 16 through 18 provide results which aren't unexpected. A founder of industrial arts, John Runkle, when President of M.I.T., initiated manual training to provide engineering students concrete experiences preceding verbal abstractions (Cremin, 1964, p. 25).

Assumption 19: Errors are necessarily a part of the learning process; they are to be expected and even desired, for they contain information essential for further learning.

SA = 35.9%	A = 51.4%	NSF = 8.8%	D = 2%	SD = 2%
1	2	3	4	5

Mean = 1.829    Standard Deviation = .8237

The results to Assumption 19 are not unexpected. Industrial arts activities foster immediate feedback of successes and failures without teacher intervention or interpretation.

Assumption 20: Those qualities of a person's learning which can be carefully measured are not necessarily the most important.

SA = 41.4%	A = 47.0%	NSF = 8.4%	D = 1.6%	SD = 1.6%
1	2	3	4	5

Mean = 1.749    Standard Deviation = .8030

Assumption 21: Objective measures of performance may have a negative effect upon learning.

SA = 15.1%	A = 41.0%	NSF = 21.9%	D = 17.1%	SD = 4.0%
1	2	3	4	5

Mean = 2.554    Standard Deviation = 1.0882

Assumption 22: Learning is best assessed intuitively, by direct observation.

SA = 5.6%	A = 29.1%	NSF = 31.5%	D = 28.3%	SD = 5.6%
1	2	3	4	5

Mean = 2.992    Standard Deviation = 1.0119

Assumption 23: The best way of evaluating the effect of the school experience on the child is to observe him over a long period of time.

SA = 26.3%    A = 55.0%    NSF = 12.4%    D = 6.4%    SD = 0%  
 1                    2                    3                    4                    5  
 Mean = 1.988    Standard Deviation = .8024

Reactions to Assumptions 20 through 23 indicate a mixture of attitudes toward evaluation. Apparently industrial arts professors sense a dilemma between observation as an evaluation technique and objective testing particularly when incomplete or invalid.

---

Assumption 24: The best measure of a child's work is his work.  
 SA = 10.4%    A = 44.6%    NSF = 24.3%    D = 15.1%    SD = 5.6%  
 1                    2                    3                    4                    5  
 Mean = 2.610    Standard Deviation = 1.0426

Due to the nature of the subject, one might prematurely assume industrial arts professors tend to consider one's work as the best measurement. Reaction to Assumption 24 suggests that other less tangible criteria are also considered important. Assumptions 25, 26, 27, and 28 were reordered for printing convenience when preparing the ACIATE questionnaire. These assumptions were later correctly ordered for factor analysis comparisons with Coletta's findings.

---

Assumption 26: Knowledge is a function of one's personal integration of experience and therefore does not fall into neatly separated categories of "disciplines."  
 SA = 36.3%    A = 45.8%    NSF = 8.8%    D = 8.0%    SD = 1.2%  
 1                    2                    3                    4                    5  
 Mean = 1.920    Standard Deviation = .9347

There is evidence by Assumption 26 that industrial arts may be viewed as an integrator in the curriculum.

---

Assumption 28: Little or no knowledge exists which it is essential for everyone to acquire.  
 SA = 9.2%    A = 18.3%    NSF = 14.3%    D = 36.7%    SD = 21.5%  
 1                    2                    3                    4                    5  
 Mean = 3.430    Standard Deviation = 1.2642

The high mean and standard deviation to Assumption 28 suggest both a rejection and diversity of opinion. Perhaps respondents feel everyone should have a broad general education or at least have survival knowledge for a technological society.

Assumption 25: The quality of being is more important than the quality of knowing; knowledge is a means of education, not its end. The final test of an education is what a man is, not what he knows.

SA = 31.9%	A = 46.2%	NSF = 13.1%	D = 6.8%	SD = 2%
1	2	3	4	5
Mean = 2.008    Standard Deviation = .9508				

---

Assumption 27: The structure of knowledge is personal and idiosyncratic; it is a function of the synthesis of each individual's experience with the world.

SA = 23.9%	A = 49.4%	NSF = 17.5%	D = 8.0%	SD = 1.2%
1	2	3	4	5
Mean = 2.131    Standard Deviation = .9092				

---

Assumption 29: It is possible, even likely, that an individual may learn and possess knowledge of a phenomenon and yet be unable to display it publicly. Knowledge resides with the knower, not in its public expression.

SA = 23.1%	A = 51.4%	NSF = 15.5%	D = 7.6%	SD = 2.4%
1	2	3	4	5
Mean = 2.147    Standard Deviation = .9414				

---

Wilber's eight goals for industrial arts suggest agreement with Assumptions 25 through 29 (Wilber, 1954, pp. 47-88).

*Reliability.* Results of the data were subjected to a Hoyt estimate for reliability. Results disclosed a reasonably high reliability value of .8227. Therefore, a decision was made not to subject the data to factor analysis. The standard error was found to be a reasonably low 4.4963.

*Factor analysis.* As discussed earlier, Coletta subjected the Barth Scale to factor analysis. Herewith on Table 4-2 are the results when the ACIATE sample data means of means were ranked according to the factors determined by Coletta.

Table 2 indicates that participants in this study were most favorable toward the factor which Coletta labeled "Learning Facilitators" — so much so that their responses to this factor (1.684) fell between strongly agree and agree. Moreover the standard deviation value of .8083 is the lowest of those reported indicating a greater amount of unanimity of opinion toward this factor. It is noteworthy that this factor is comprised of items which address themselves to self-concept, a rich learning environ-

**Table 2**  
**Barth Scale Factors Ranked by Mean of Means**

Factor Number by Coletta	Factor Label by Coletta	Identity of Items via Assumption Numbers	Mean of Means	Mean of Std. Dev.
5	Learning Facilitators	4, 5, 26	1.684	.8083
3	Evaluating the Child	19, 25, 27, 20	1.929	.8717
2	Intellectual Development	27, 23, 15, 17, 14, 9, 20	1.962	.8200
7	Learning through Exploration	3, 6, 1, 9, 17, 8, 16	2.021	.8716
4	Learning through Involvement	10/12, 11, 12, 15, 2, 27	2.221	.8679
6	Evaluating the Child's Work	18, 24, 21, 27, 1	2.286	.9485
1	Curriculum Flexibility	28, 7, 8	2.820	1.0860

Mean of Means: 1 = Strongly Agree, 2 = Agree, 3 = No Strong Feeling, 4 = Disagree, 5 = Strongly Disagree



ment, and opposition to discrete disciplines of knowledge. Such a result should not be too surprising in view of the many years of industrial arts literature which advocated such beliefs.

The factor of second greatest acceptance is "Evaluating the Child." Items comprising this factor address themselves to the value of errors while learning, the test of an education, its idiosyncratic nature, and the questionable value of objective evaluations. The high acceptance of this factor is perhaps explained by the informal nature of industrial arts, which prompts insight to the students' achievements.

The third most acceptable factor is labeled "Intellectual Development." Items comprising this factor include statements addressing idiosyncrasy of intellectual development, value of direct experience, multiplicity of learning rates and styles, interest, and again the questionable value of objective evaluations. Undeniably industrial arts provides a fine setting in which students can satisfy their unique interests in a fashion which is both real and adaptable.

The fourth most acceptable factor to the ACIATE audience was labeled by Coletta as "Learning through Exploration." Included in this factor are items dealing with impulse to learn, value of play, curiosity, interest, direct experience, and selection of materials. The title of "Learning through Exploration" alone is a most accurate descriptor of the possibilities of industrial arts.

"Learning through Involvement" is found to be the fifth most acceptable factor. Included are items concerning fun of learning, self-perpetuation, and idiosyncrasy of education. Involvement is *sine qua non* to industrial arts. Surely the industrial arts classroom is the last place to expect to find passive students.

"Evaluating the Child's Work" is found to be the sixth most acceptable factor. It should be noted that responses to this factor center near the "agree" value. Items contributing to this factor include statements about verification of solutions to problems, criteria for evaluation, negative effects of objective evaluations, meaning of an education, and curiosity. The higher standard deviation for this factor (.9485) indicates a greater difference of opinion to this factor than the preceding.

The least acceptable factor to the ACIATE participants in this study is labeled "Curriculum Flexibility." Here it should be noted that the mean of 2.820 indicates a value approaching "no

strong feeling" rather than disagreement. Supportive of such a response is the highest standard deviation (1.0860). Items included in this factor address themselves to the basic education and curricular decisions made by students. It may be that this factor represents views too radical for the ACIATE members, is of no particular interest, or attends to issues for which the individuals were unprepared to respond.

*Correlation between open education acceptance and age.* It is important to discover whether there is a correlation between the respondents' ages and acceptance of open education concepts. Implementation of open education practices might be inhibited if younger respondents were found to be receptive toward open education while older respondents were less enthusiastic or vice versa.

Examination of the data discloses an age span of the respondents from twenty-four to sixty-seven with a mean of 43.6 years. Analysis of data by the Pearson Product-Moment Correlation tests disclosed no significant correlation at the .05 level between age and acceptance of open education concepts. To achieve significance at the .05 level, a correlation value of .1946 is required. Instead the data provided a correlation value of .1086, which at the less meaningful .086 level indicated older respondents were less receptive to open education.

*Correlation between open education acceptance and years of teaching.* Respondents were found to have taught from one to forty-six years with a mean of 18.1 years. Analysis of the data by the Pearson Product-Moment disclosed at the .05 level no significance between acceptance of open education and years of teaching.

*Analysis of variance by geographic regions.* The data was subjected to an analysis of variance to determine whether respondents in eight geographic regions throughout the United States differed significantly in their acceptance of open education. Similarities of climate, physical features, economy, people, traditions, and history identified by *World Book Encyclopedia* served as criteria (*World Book Encyclopedia*, 1972, p. 46). Means are reported in Table 3.

**Table 3**  
**Means of Acceptance of Open Education Concepts**  
**by Geographic Regions**

Geographic Region	Mean (National Mean = 63.1)	N
Middle Atlantic States	61.3	30
Midwestern States	63.9	109
New England States	64.2	4
Pacific Coast States	61.2	21
Rocky Mountain States	66.6	19
Southern States	59.3	38
Southwestern States	66.0	28
Hawaii	57.5	2

A univariate analysis of variance provided an F value of 1.61, which is not significant at the .05 level. Exact significance was found to equal .1314. The data thus indicates there is no significant regional variation from the national mean when the ACIATE sample responded to the Barth Scale. Table 4 supports such a conclusion.

**Table 4**  
**Analysis of Variance for Difference by Geographic Regions**  
**for Open Education Acceptance**

Sources of Variation	S.S.	d.f.	M.S.	F.	Significance less than
Regions	1313.557	7	187.6511	1.6161	.1314
Error	28215.3132	243	116.1124	—	—

Subsequently graphical displays of the data depicted on Figures 5-2 and 5-3 appear to substantiate Table 3. It is interesting to note by the height of the pinnacles that open education tends to be more popular with industrial arts professors living in states with high ACIATE membership. It should be noted that the dense symbols in Figs. 5-2 and 5-3 indicate those areas of the country where ACIATE members were most favorable toward

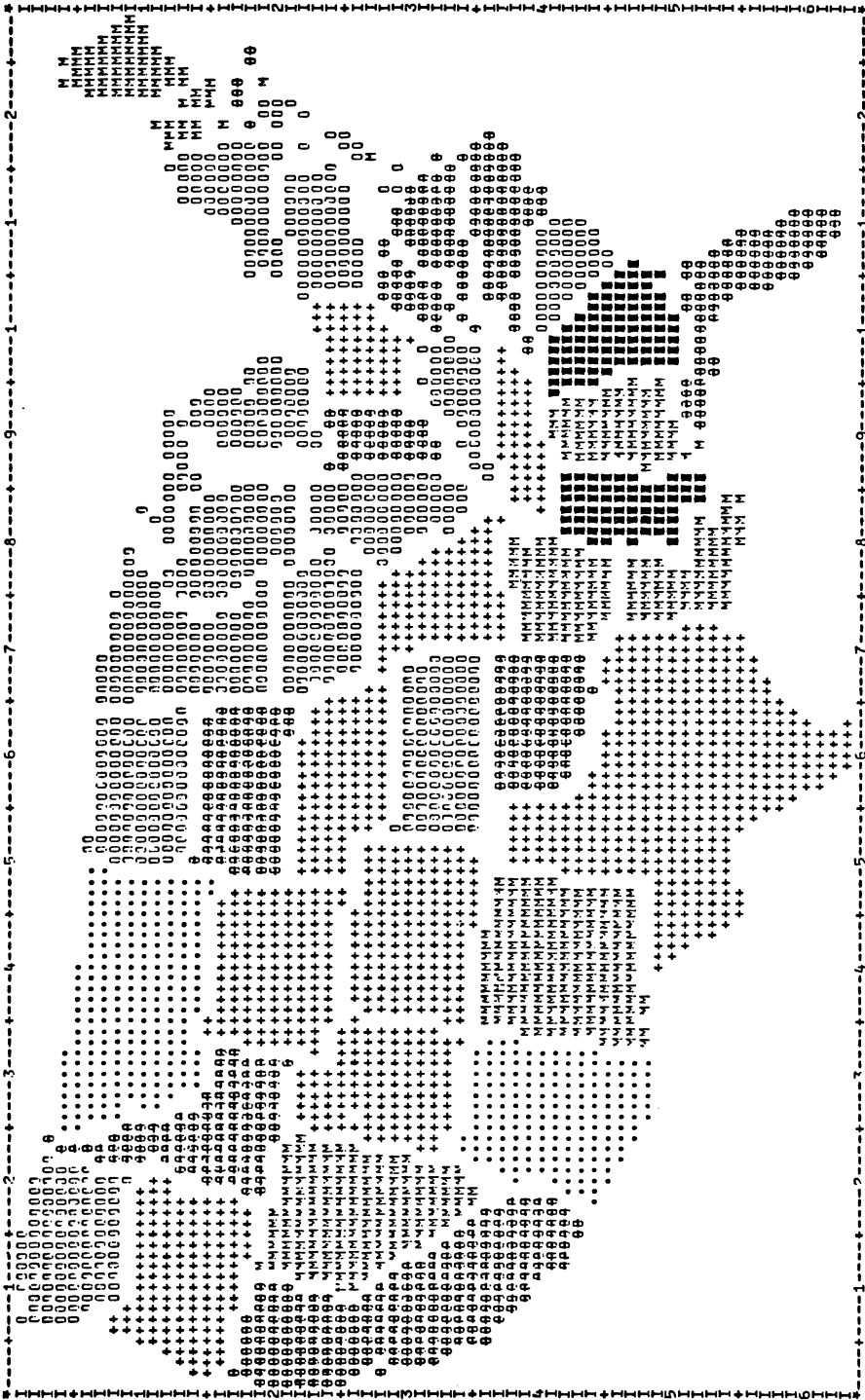
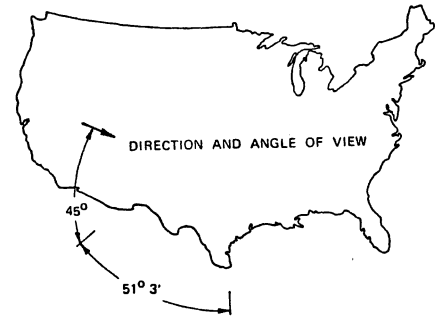
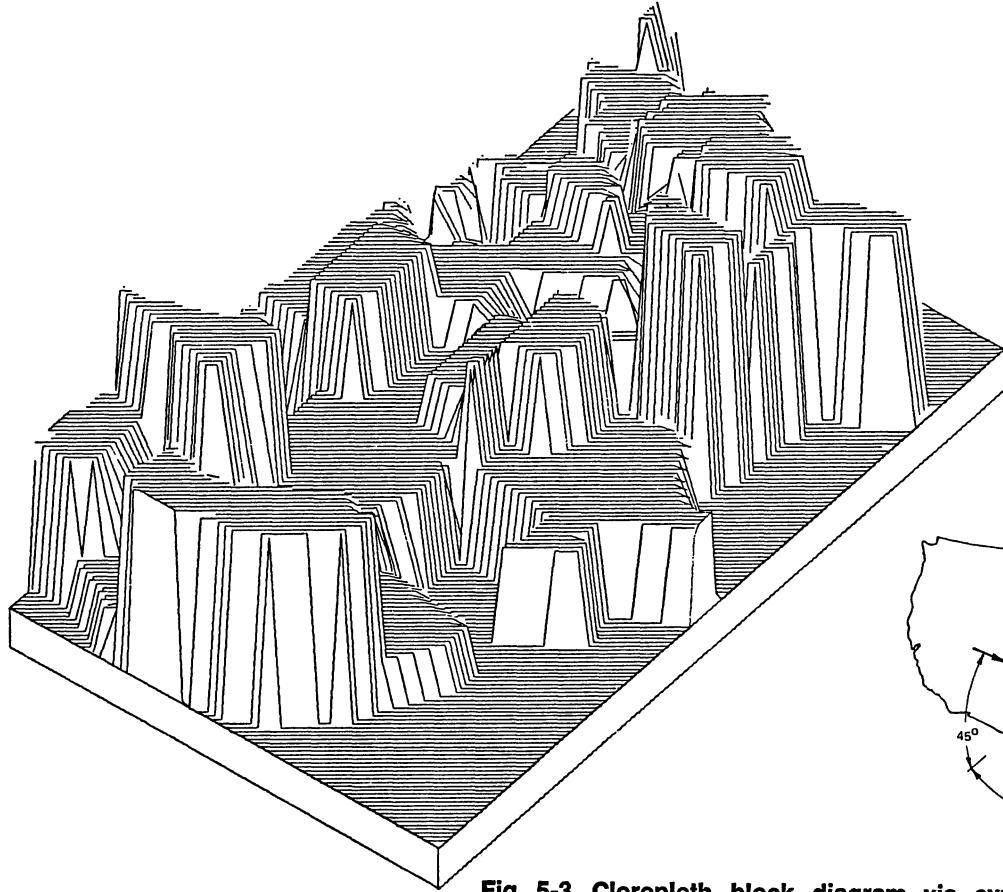

Fig. 5-2. Cloropleth display of ACIATE data. The dark areas represent geographic regions having strongest support for open education. M represents missing data.

SYMAP



**Fig. 5-3. Choropleth block diagram via symvu program of ACIATE membership support of open education. The higher peaks represent greater support.**

open education concepts. This is not to suggest that industrial arts professors living in other states indicated with light symbols disagree with open education concepts. The symbols merely indicate extent of favor toward open education. Furthermore those areas represented with the letter "M" indicate missing data which resulted when the random sample failed to draw anyone from a particular state.

## SUMMARY

Analysis of the data appears to indicate industrial arts professors support open education concepts. Furthermore the study suggests their acceptance of open education is unaffected by their age, years of teaching, or geographical region. Factor analysis disclosed varying degrees of acceptance to factors labeled "Learning Facilitators," "Evaluating the Child," "Intellectual Development," "Learning through Involvement," and "Evaluating the Child's Work." It is interesting to note that a remaining factor labeled "Curriculum Flexibility" received a mean response approaching "no strong feeling" by the ACIATE respondents.

Currently open education has been supplanted on center stage by basic education. Some describe education as a pendulum swinging from one set of beliefs to another. Such a seemingly unsteady course is caused by a number of factors which may be pedagogical, social, political, and/or economic. Disenchantment with a particular educational practice may be caused by misinterpretation and resultant aberrations as unfortunately was the case often with progressive education. Furthermore, Americans seem unable to suspend judgment and tend to expect immediate results from the schools.

In many respects the open access curriculum for industrial arts allows each student to proclaim a declaration of independence: independence as a confident self-assured individual; and, also, independent as one who understands our technological culture. Others are agreeing that whatever mission industrial arts takes, it has a most unique and natural opportunity to participate within the open access curriculum (Rumble, 1975).

Industrial arts can and should contribute to each student gaining a better understanding of self. Where else can students find the freedom to interact with each other and the materials, processes, and ideas which satisfy present and future needs? Industrial arts offers through the open access curriculum a limitless array of opportunities for exciting experiences whereby students come to know firsthand more about themselves and their culture. What could better be called general education?

Far too many students and adults are woefully ignorant about their highly industrialized and technological culture. They have lost their self-independence and can no longer assess technological impact upon themselves and the environment. We see evidence that many in our society wish to regain that which is lost. The desire for a self-sufficient life style again appeals to many. Yet, to do so requires that one must be confident by believing in self and possess technical skills to affect change and control one's destiny.

Properly conceived and taught, industrial arts through the open access curriculum offers much to the contribution of one's education. In fact there is danger from disinterest toward the rest of the curriculum offered elsewhere throughout the school. The implications for the open access curriculum within industrial arts are many. To affect an open access curriculum utilizing open education beliefs requires that we teacher educators not only teach the technical skills but also extol in our students an empathy for their future students. Included is a spirit of humanism and an understanding of the growth and development process.

It may be said that even now industrial arts remains at a crossroads without a theoretical base. Maybe so. However, there is considerable room for optimism when examining curricular developments undertaken during the past ten years. When one studies open education beliefs in particular, one is easily drawn to conclude open access considerations have been central to industrial arts for much of its history. Our mission becomes clear to those of us preparing this yearbook if we draw content from the wealth of sources within industry and offer such experiences through an open access curriculum. If we have no focus, we are apt to become replaced by less expensive or federally funded programs. The point is that we have an incredible opportunity to enrich the lives of all students. Lowell Anderson said it well

when he earlier wrote to those of us contributing to this year-book, "Industrial arts could increasingly reflect components of an open access curriculum, not as a means of interpreting technology or a means of preparing persons to fit a technological based society; but, as a means of individual identification." How different is this from Cremin's goal of an "educationally autonomous individual." (Cremin, 1974, p. 74).

## REFERENCES

- Arlin, Marshall. "Open Education and Pupils' Attitudes," *The Elementary School Journal*, LXXVI (January, 1976), 219-228.
- Barth, Roland S. *Open Education and the American School*. New York: Agathon Press, Inc., 1972.
- Barth, Roland S. "So You Want to Change to an Open Classroom," *Phi Delta Kappan*, LIII (October, 1971), 98-99.
- Bonser, Frederick G. *Life Needs and Education*. New York: J. J. Little and Lives Co., 1932.
- Coletta, Anthony J. "Personality Characteristics Held by Open and Traditional Teachers," *The Journal of Educational Research*, LXVIII (March, 1975), 250-252.
- Coletta, Anthony J. "Personality Characteristics and Assumptions Held by Open and Traditional Teachers of the Poor." Preliminary research results for doctoral dissertation, University of Connecticut, 1972. (Mimeographed.)
- Coletta, Anthony J., and Robert K. Gable. "An Examination of the Content and Construct Validity of the Barth Scale: Assumptions of Open Education." Preliminary research results for doctoral dissertation, University of Connecticut, 1972. (Mimeographed.)
- Cremin, Lawrence A. "The Free School Movement — a Perspective," *Today's Education*, LXIII (September-October, 1974), 71-74.
- Cremin, Lawrence A. *The Transformation of the School*. New York: Vintage Books, 1964.
- Dennis, Ervin A. (compiler). *Industrial Teacher Education Directory*. Cedar Falls, Iowa: American Council on Industrial Arts Teacher Education and National Association of Industrial and Technical Teacher Educators, 1976.
- Farrall, Clayton and Karl Thaller. "Children's Personality — Does it Differ in Traditional and Open Classrooms?" *The Elementary School Journal*, LXXVI (April, 1976), 440-449.
- Gallup, George H. "Seventh Annual Gallup Poll of Public Attitudes Toward Education," *Phi Delta Kappan*, LVII (December, 1975), 227-241.
- Goodlad, John I., et al. *The Conventional and the Alternative in Education*. Berkley, California: McCutchan Publishing Corporation, 1975.



- Hornbake, R. Lee. "Industrial Arts for All." Paper read before New England meeting, circa 1955. (Mimeographed.)
- Horwitz, Robert A. *Psychological Effects of Open Classroom Teaching on Primary School Children: A Review of the Research*. Grand Forks, North Dakota: North Dakota Study Group on Evaluation, Center for Teaching and Learning, University of North Dakota, 1976.
- Hunter, William L. "Socializing Tests and Measurements," *Industrial Arts and Vocational Education*, XXVII (January, 1938), 5-7.
- Klaff, Frances R. and Edward M. Docherty. "Children's Self-Concept and Attitude Toward School in Open and Traditional Classrooms," *Journal of School Psychology*, XIII (Summer, 1975), 97-103.
- Myers, Donald A. "Why Open Education Died," *Journal of Research and Development in Education*, VIII (Fall, 1974), 60-67.
- National Union of Teachers. *Plowden/the Union's Comments on Some of the Major Issues of the Plowden Report*. A Report Prepared by the National Union of Teachers. London: Hamilton House, 1969.
- Nyberg, David. *The Philosophy of Open Education*. Boston: Routledge and Kegan Paul, 1975.
- Ramey, Craig T. and Vera Piper. "Creativity in Open and Traditional Classrooms," *Child Development*, XLV (June, 1974), 557-560.
- Richards, Charles R. *The Gary Public Schools/Industrial Work*. New York: General Education Board, 1918.
- Rogers, Vincent R. "Open Education: Where Is It Now? Where Is It Heading?" *Music Educators Journal*, LX (April, 1974), 20-24.
- Rogers, Vincent R. and Bud Church. *Open Education: Critique and Assessment*. Washington: Association for Supervision and Curricular Development, 1975.
- Rumble, Brian J. "A Conceptual Framework for Industrial Arts in the Open Classroom," *Man/Society/Technology*, XXXIV (May/June, 1975), 239-241.
- Sealey, Leonard. "Open Education: Fact or Fiction," *Teachers College Record*, LXXVII (May, 1956), 615-630.
- Solomon, Daniel and Arthur J. Kendall. "Individual Characteristics and Children's Performance in 'Open' and 'Traditional' Classroom Settings," *Journal of Educational Psychology*, LXVIII (October, 1976), 613-625.
- Sullivan, Joanna. "Open — Traditional — What is the Difference?" *The Elementary School Journal*, LXXIV (May, 1974), 493-500.
- "United States," *World Book Encyclopedia*, XX (1972), 46.
- Van Til, William. "Back to Basics — With a Difference," *Educational Leadership*, XXXIII (October, 1975), 8-13.
- Warner, William E., et al. *A Prospectus for Industrial Arts in Ohio*. Columbus: The Ohio Education Association and the Ohio State Department of Education, 1934.
- Wilber, Gordon O. *Industrial Arts in General Education*. 2nd Ed. Scranton, Pennsylvania: International Textbook Company, 1954.
- Zurbuch, Lowell S. "A Study of the Acceptance of Open Education Concepts by Industrial Arts Teacher Educators." Unpublished doctoral dissertation, Michigan State University, 1973.



**Dr. Richard V. Barella**

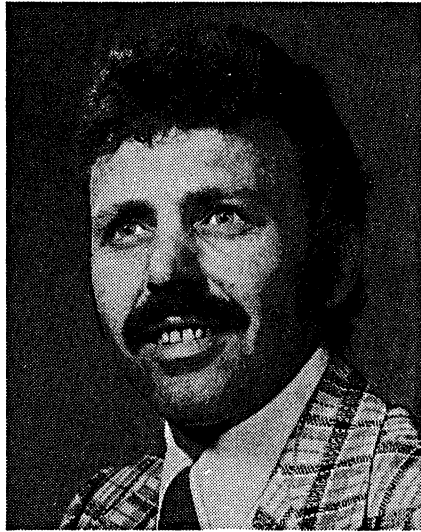

Dr. Richard V. Barella, Associate Professor, Department of Industrial Education and Technology, Ball State University, Muncie, Indiana.

Dr. Barella is Associate Professor in the Department of Industrial Education and Technology at Ball State University, Muncie, Indiana. He earned his B.S. degree from Central Connecticut State College, his M.A.Ed. degree from Ball State University, and his Ph.D. from Ohio State University. He has taught at the middle school, junior high, and senior high school levels and has been a faculty member at Ball State since 1972.

Dr. Barella was the developer of the Parma (Ohio) Approach to the study of industry and technology at the junior high school level and initiated a similar program for the middle school in Newington, Connecticut. Both programs were in concert with the open concept since they permitted students to assume more autonomy for their learning. His interest in the concept of open education has continued to be reflected in his undergraduate and graduate courses and is exemplified in his co-development of professional courses which include school-based experiences for prospective industrial education teachers.

He served as a teaching and research associate on the IACP development, is co-editor of the *Manufacturing Forum*, and is co-editor for the 1981 ACIATE yearbook to be titled *An Interpretive History of Industrial Arts: The Interrelationship of Society, Education, and Industrial Arts*. He has also authored several professional journal articles and has made presentations at local, regional, and national professional meetings on topics concerning manufacturing, elementary industrial arts, and school-based experiences in industrial teacher education.

**Dr. Donald F. Smith**

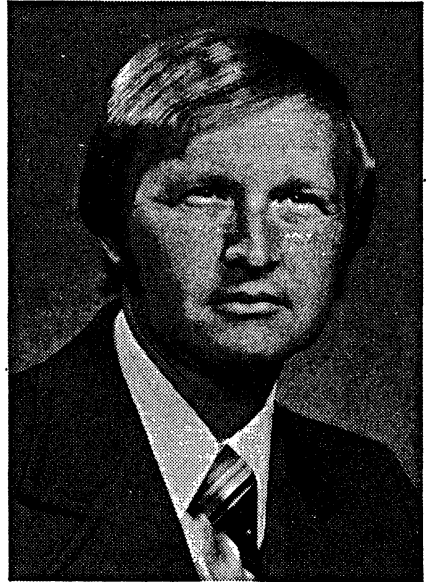

**Dr. Donald F. Smith, Associate Professor, Department of Industrial Education and Technology, Ball State University, Muncie, Indiana.**

**Dr. Smith is currently Associate Professor in the Industrial Education and Technology Department, Ball State University. He received his BS degree from Wilmington College, Ohio; his ME degree from Kent State University; and his EdD degree from the University of Maryland. He has taught at the middle school, junior high, senior high and university levels during the past 17 years. He has served on the Ball State faculty since 1972.**

**He is currently co-editor of the *Manufacturing Forum*. In the past ten years he has made numerous presentations to local, regional and national organization meetings in the areas of manufacturing, middle school industrial arts and elementary school industrial arts.**

**Dr. Smith has had a continued interest in "openness" in industrial arts programs at all levels. His program development in the public school and at the university have reflected this interest. His doctoral research involved openness in middle school arts programs.**

# Implications for Industrial Arts Teacher Preparation

*Richard V. Barella*

*Donald F. Smith*

*The history of American education is the long, turbulent record of a nation that wasn't afraid to risk failure or trouble or confusion in pursuit of a goal that at first seemed widely impractical: to give every American child a chance to develop to the limit of his ability. It is still one of the most radical ideas in human history, yet it grew out of the American soil as naturally as wheat or corn.*

John W. Gardner

## INTRODUCTION

In previous chapters, the authors have emphasized that students, as individuals, are the focus of the open access curriculum in industrial arts. This concern for and commitment to individuals is but a reaffirmation of those themes that have been predominant since the creation and development of our nation. As a reflection of our society, the American system of public education, too, has been and is expected to provide experiences and opportunities so that *all* students may become all they can within their capabilities. Yet in spite of attempts through the years to achieve this goal, our dream to date has gone unrealized. And while meager progress has been made, the thread of constancy which characterizes the history of education is that all students at all levels of schooling have tended to be taught in a similar manner in the same environment. Sameness and conformity have prevailed where diversity should.

In a society marked by high speed change this is hardly a healthy situation. For in our democratic nation educators have a major responsibility for dealing with variability. Unfortunately, much more lip service than implementation is given to gearing educational programs to individuals although it is a known fact that human beings are indeed different. Moreover, educators almost universally agree that our schools should produce citizens capable of independent action, self-direction, and self-propulsion. The evidence mounts, however, that public schools as well as institutions of higher education are not doing this due to what Frymier (1976) has termed the "control mentality" (p. 24) of schooling. This situation has come about largely by our adherence to a single pedagogical model.

The Transmission-of-Knowledge Model pervades all of education including industrial arts teacher education. Assuredly, it is based on important assumptions about knowledge, curriculum, teaching, and learning. Yet it has serious drawbacks. It is a model that focuses on teachers and instruction rather than on learners and learning. That is, teachers do most of the initiating and are highly active while students are reactors. Johnson (1970), writing about industrial arts teacher education, alluded to the Transmission-of-Knowledge Model when he stated that our present programs are ". . . teacher-centered, group oriented, and textbook based" (p. 383). This comment, although somewhat overstated, does highlight the fact that most teacher educators typically determine the materials, tools, processes, and equipment with which students are to work and learn. Not only is the instructor in the Transmission-of-Knowledge Model the primary decision maker, but also the one who assumes major responsibility for determining what students are to know and do, when they are to know and do it, and if in fact they have assimilated the information and completed activities according to his criteria. Since the instructor is set up as the authority and director of learning we have a system which in Frymier's (1976) words "minimizes choice and maximizes similarity" (p. 25). This control orientation which characterizes the Transmission-of-Knowledge Model tends to produce learners who exhibit *dependent* rather than *independent* behavior. Indeed, Trent and Medsker (1968) conducted a study in which they discovered that most college graduates are apathetic to intellectual inquiry. During the

same year Katz and associates (1968) presented the results of a five-year longitudinal study of changes in college students. They found that college had little impact on student development. The researchers concluded that changes must be made in the curricular offerings and other components of the educational environment. The authors proposed that the thrust of education should be on students and their development, rather than on the accumulation of course credits.

The Transmission-of-Knowledge Model in which the teacher is the dominant figure was under scrutiny in an investigation conducted by Wood (1970). It was discovered that when instructors were directive and did little if anything to acknowledge or use the ideas of students, that students remained at the lowest cognitive level while the instructors' level of cognition was considerably higher. On the other hand, when instructors based their instruction on the ideas of students, using information and hypotheses which were student initiated, there was a close relationship of cognition of instructors and learners. The result was a higher level of achievement for students of instructors who used the latter approach.

The Transmission-of-Knowledge Model has been highly successful in industrial arts teacher education programs. It has been proven beyond a shadow of a doubt that teacher educators are able to prepare teachers to implement traditional industrial arts programs. The sameness of our programs is abundantly documented in our literature. Our almost religious adherence to the Transmission-of-Knowledge Model has in large measure perpetuated this situation. It is this model, too, that has led Letcher (1970) to voice the criticism that our present concept of teacher training produces industrial arts teachers who are ". . . passive, dogmatic, intolerant, authoritarian, inflexible, conservative personalities, who desperately need to resist change in an effort to keep their illusion of certainty intact" (p. 385). Is it our desire to continue to prepare teachers with these qualities? We think most in the field would respond in the negative.

But what can be expected when models of directive teaching are all that students have experienced through sixteen years of schooling? They perceive teaching and learning as a teacher-directed process and thus adopt similar roles. Based on what is known about perception, this is not unusual. Perceptions are

formed by past experiences and provide individuals with their functional reality. It is from these feelings of reality that people gain their sense of surety. And they must have this in order to have the confidence to act. Our perceptions serve as directives for our actions (Kelly, 1947, pp. 25-48). What this means is that teachers teach as they do based on their past experiences. But it is known, too, that perceptions vary with individuals. If teachers have experienced similar teaching approaches throughout their schooling, however, then it seems likely that their collective perceptions will more nearly approximate each other. Since most teachers use the teacher-directed approach is it any wonder that teacher educators hear in negative tones the often used phrase "Teachers teach as they've been taught"?

This discussion of the Transmission-of-Knowledge Model is not meant to condemn it or those who use it. What it does intend to point out is that it must be placed in proper perspective and no longer dominate our teacher education programs. The expansion of knowledge in every direction, constant and rapid change, and the growing diversity of individuals entering our programs makes it increasingly more apparent that no one pedagogical model will provide the panacea that will solve the problems of educating all learners. To base our programs primarily on the Transmission-of-Knowledge Model is to settle for small stakes indeed.

The remainder of this chapter outlines some important considerations for designing broader based teacher education programs. The importance of teacher educators being life-long students of the teaching-learning process will be discussed. Learning styles and their application in teacher education will, likewise, be reviewed. Additionally, a proposal for teacher education will be offered with practical suggestions for moving present programs toward more "openness."

## **TEACHER EDUCATION REDIRECTED**

Our goal seems clear. Industrial arts teacher educators must begin to direct their efforts at redesigning programs that are capable of producing not common but rather uncommon teachers. This will occur only if bold steps are taken toward proclaiming the primacy of individuals. This means that teacher educators



first prize diversity and uniqueness rather than standardization. It means, too, that our students must be enlisted as partners in shaping teacher education programs. As students are permitted to make decisions and assume responsibilities, greater opportunities are created for them to feel personally involved and hopefully committed to self-education. Furthermore, the process of individualization is a means of pushing students to the limits of their abilities. It requires that students gain the essential knowledge that all prospective teachers must possess — the knowledge that they must be able to think and learn for themselves. If our teachers cannot do this, go beyond what their instructors have thought or learned, they will quite likely remain enslaved to other men's ideas.

All attempts, however, to fashion programs that accommodate individuals demand alternative patterns to teaching and learning. This is essential if our programs are to produce independent, self-directed, responsible, in short, uncommon teachers.

### **Faculty Development**

What can be done to revise teacher education programs to deal effectively with human individuality? It seems apparent that an important first step should be for teacher educators to heed Dewey's (1904) call made over seventy years ago for "students of teaching" (p. 15). In fact, faculty development programs with the primary purpose of improving the quality of teaching are currently operating in a large number of colleges and universities (Change, 1976). These programs, although utilizing varying approaches, attempt to reflect the research which clearly supports pluralistic teaching.

Faculty development programs should be developed by and for faculty members in industrial arts teacher education. If industrial arts teacher education is to become a truly effective force for education improvement, then faculty teaching approaches and practices must be seen as exemplary models by our students. As teacher educators learn about alternative teaching strategies and methods, they must also learn when and where to use them. This requires that teacher educators also become *students of learners*. Being able to assess learner competencies, interests, aspirations, and other personal, social, and intellectual characteristics is the hallmark of programs that cater to individuals. Certainly greater

attention should be directed toward the concept of learning styles. The term learning styles is used with regularity by advocates of open education, but has largely been ignored in teaching. Yet it is a powerful concept that has important implications for the teaching-learning process at all levels of education.

## LEARNING STYLES

Learning styles refer to an individual's unique manner of acquiring and organizing information. Researchers have identified several dimensions of learning styles but the two shown in Fig. 6-1 appear to have the most potential for industrial arts education.

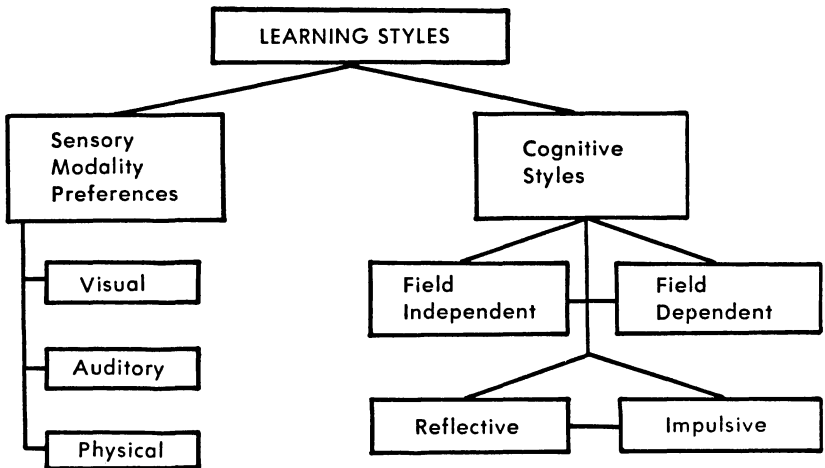

**Fig. 6-1. Two Dimensions of Learning Styles.**

### Sensory Modality Preferences

The first dimension, sensory modality preferences, refer to the major reception channels used for processing information. The three sensory modalities most applicable to industrial arts education include the visual, the auditory, and the physical. Individuals with a visual orientation learn best by observing or reading. Auditory individuals prefer to learn by listening, while persons with a physical modality preference learn best by doing.

There are, of course, individuals who favor more than one sensory modality. For example, such combinations as auditory-physical and visual-physical learners are quite possible.

An individual's sensory modality preference is developed at an early age and is not subject to fundamental change. It can, however, be molded and further developed. This does not mean that a person with a particular modality preference cannot learn through other senses. For example, individuals who learn best by doing (physical style) may in fact learn to read (visual style) quite well, however they are unlikely to change their primary modality completely. Although these persons may learn to read quite well, their best and thus deeper learning will occur through the physical manipulation of objects (Riessman, 1976, p. 95).

Few people know their own sensory modality preference or preferences. Thus, the challenge of teacher educators is to assist prospective teachers to become aware of their particular styles. At the same time options must be provided so that learners are able to utilize their sensory modalities to their greatest advantage.

### **Cognitive Styles**

The second dimension of learning style is associated with cognitive styles. Cognitive styles are information processing habits that represent an individual's typical modes of perceiving, thinking, remembering, and problem solving. Researchers have identified several types of cognitive style, but much of the work is still in its infancy (Cahen, 1972, p. 130). Two types of cognitive styles, however, have been studied quite extensively and appear, at present, to have import for education. These two cognitive styles include field independence versus field dependence and reflective versus impulsive.

Field independent individuals are able to analyze and differentiate discrete parts of wholes. By comparison, people who are field dependent utilize a global approach meaning that they tend to perceive the wholeness of a context and have difficulty separating it into component parts. It is important to emphasize that people are not strictly field independent or field dependent as shown in Fig. 6-2. In reality, individuals fall somewhere on a continuum from extremely field independent to extremely field dependent.

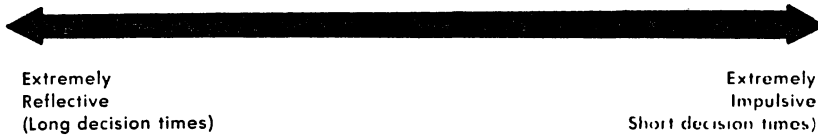

**Fig. 6-2. Field Independent versus Field Dependent Continuum.**

At the same time research has shown that there is an increase from field dependence to field independence from early childhood up to late adolescence where a leveling off takes place. This apparent return to field dependence has been found to last for only a few years. However, the process of limited differentiation (field dependence) begins to increase again in the late thirties up to old age (Witkin, et al., 1967).

Field independence versus field dependence is the result of both intellectual and perceptual functioning and thus are a part of the total personality. Because of this, cognitive styles are habits that are spontaneously applied without conscious choice in myriad situations (Messick, 1972, p. 112). Although field dependent people may at times adequately analyze problems or situations they cannot compete with field independent persons, who, in fact, perform better on tasks requiring analysis. It must be stressed, however, that although field independent individuals have a marked advantage on analytical intelligence tests, they are in no way superior in verbal or even general intelligence (Goodenough and Karp, 1961; Witkin, et al., 1962).

The cognitive style termed reflective versus impulsive represents the speed with which an individual processes information and reports hypotheses or problem solutions. Individuals with a reflective disposition approach problem situations slowly, carefully considering hypotheses, problem solutions, and the manner in which they will reveal their results. By comparison, impulsive people are quick to select and solve problems and report solutions with little regard for accuracy. As with the cognitive style previously discussed, it should be noted that people are not purely reflective or impulsive. Instead, they fall somewhere on a continuum from extremely reflective to extremely impulsive as shown in Fig. 6-3.



**Fig. 6-3. Reflective versus Impulsive Continuum.**

The study of reflective versus impulsive cognitive style has also produced several other results. For example, the tendency to be reflective or impulsive is relatively stable over time. Moreover, reflectiveness tends to increase with age, as does accuracy. Furthermore, the tendency to display long or short decision times is revealed in the performance of numerous tasks including the selection of the correct response from a list of alternatives, producing the correct response in the absence of an alternative, and answering questions during interviews (Kagan, 1965; Kagan, 1972).

It seems apparent from the foregoing discussion of learning styles that no one method, organizational scheme, or teaching style suits every individual learner. Learners do differ and in fact are more dissimilar than they are similar. Because of this, instructional approaches, organizational arrangements, and sequencing of curriculum content must vary, too. What teacher educators do must occur as a result of individual student learning needs. Thus, greater attention should be given to a pedagogical model based on flexibility so that the diverse needs of individual learners can be more effectively met. At the same time prospective teachers should have the opportunity of being exposed to a variety of exemplary teaching models. This in turn allows each teacher in preparation to analyze and work out his or her own personal style of teaching.

## **A PROPOSAL FOR A "MORE OPEN" TEACHER EDUCATION PROGRAM**

What can be done to "open up" teacher education programs to meet the needs of individuals? One approach could be to propose radical changes in our present programs. To follow this course may in fact inspire some to make major program adjust-

ments that would accommodate individual learners. The risk is that many, if not most, would do nothing. Another proposal, equally risky, could advocate a completely separate teacher education curriculum for prospective teachers who desire to teach in an open education setting. A proposal of this nature, however, seems unworthy for a variety of reasons. One reason is the confusion and lack of departmental unity that would inevitably occur. The most feasible approach seems to be one which calls for gradual and modest revisions in all teacher education programs. It is the conviction of the authors that gradual, orderly modifications in present programs would result in the greatest pay-off for students and in turn for the profession.

The remainder of this chapter will present an approach for opening up teacher preparation programs in an evolutionary rather than a revolutionary manner. As indicated earlier, few teacher education programs could support a new and separate program for individuals who aspire to teach in open teaching-learning environments. Likewise, few programs could withstand radical change without severe consequences. Nearly all of our programs, however, could adjust to modest revisions. To suggest modest revisions for teacher education does in no way minimize their importance or the work that will need to be done. Our programs, as well as teacher education programs in general, have applied little of the significant results that research has generated. The research cited earlier in this chapter gives us some powerful guideposts for gearing our teacher education programs to students as individuals.

The authors believe that the model being advocated will bring our programs more in line with present knowledge about what is good education for all of our students. At the same time it will provide an avenue for preparing some students to meet the demand for "open education teachers." Yes, "open education teachers" will always be needed. What is known about learners and learning demands that teachers be prepared who are capable of adapting to the widely varying needs of young people.

Few would argue that our public schools should produce independent learners who gain and value a sound liberal education. But to produce individuals with these qualities means that teachers understand, appreciate, and value independent learning and liberal education. It seems to follow then that teachers must

have had significant experience and success as independent learners themselves. Logically, this must take place in our teacher education programs. If this is to come about, changes must be made. For example, we have, as a profession, for many years espoused Dewey's principle of "learning by doing." But, for the most part this principle has been applied to the skill development aspect of our programs. Why has not the equally important problem solving aspect of industrial arts curricula received the same systematic emphasis as has skill development? Is not one of the important purposes for studying industry and technology to prepare youth to *improve* our technological society by solving its problems?

Teaching students to use tools efficiently simply provides them with the ability to shape materials, not necessarily with the skills to solve societal problems. Far too often industrial arts personnel have considered the ability to shape materials with tools as *the* goal of industrial arts. But this has merely produced underdeveloped students because programs have focused primarily on the knowledge, comprehension, and application levels of cognitive performance. Tool skills *combined* with problem solving skills represented by higher level analysis, synthesis, and evaluation performances in the cognitive domain afford greater opportunities for truly independent learning while at the same time increasing the potential for societal improvements. Why the profession has minimized higher levels of cognitive performance which would assist students in sharpening problem solving skills is not clear. But because of this, it becomes rather easy to understand why the general public, and many in our field, cannot differentiate between industrial arts and vocational education.

Another component of our programs that requires attention is that concerned with "how to teach." Why is it that teacher educators so often "tell" students how to teach yet provide so few opportunities for them to practice teaching with real live youngsters? "Telling" how to teach does little to inspire imaginative teaching practices. We, as teacher educators, have become so preoccupied with lecturing about teaching that we have failed miserably in presenting ourselves as models to be emulated. We owe our students more. Our programs require some semblance of balance. Prospective teachers must be provided with tool skills,

problem solving skills, and opportunities to work on their own personal teaching skills and styles of teaching. Equally important, and an effective means for helping students to grow, is to allow them to interact with instructors who are themselves searching, changing, and growing.

**Learning Opportunities Model**

The Learning Opportunities Model shown in Fig. 6-4 is proposed by the authors as one that can be used for dealing with learner variability. It is this model that we believe is the basis of the open access curriculum.

Decisions		Responsibilities		
		Instructor	Shared Instructor and Student	Student
Learner Diagnosis				
Initiation of Subject				
General Objective(s)				
PERFORMANCE OBJECTIVE(S)	Observable Performance			
	Level of Performance			
	Conditions			
Evaluation				
Methods and Resources				
Sequencing and Scheduling				
Participants				
Environment				

**Fig. 6-4. Learning Opportunities Model.**



The proposed model consists of a series of decisions with three possibilities for making each decision. The responsibility for reaching these key decisions may be assumed by the instructor, the student, or both may decide. The nature of each learner, the course, and activities within a course will determine how the decisions are reached.

The Learning Opportunities Model strongly urges opening up the system of teaching and learning. It is hoped, too, that the model may assist in opening up "closed" instructors. "Closed" instructors are those individuals whose teaching style is rigid and authoritarian. Instructors in this category typically limit the freedom of students to make decisions and assume responsibilities for their own learning. By comparison, the "open" teacher is characterized as being flexible. As Hamachek (1964) has written:

By far the single most repeated adjective used to describe good teachers is "flexible." Either implicitly or explicitly (most often the latter), this characteristic emerges time and again over all others when good teaching is discussed in the research. In other words, the good teacher does not seem to be overwhelmed by a single point of view or approach to the point of intellectual myopia. A good teacher knows that he cannot be just one sort of person and use just one kind of approach if he intends to meet the multiple needs of his students (p. 343).

Flexible or open teachers are often called facilitators or managers rather than directors of learning. However, this does not mean that good teachers abdicate their responsibility for directive teaching. The uniqueness of the Learning Opportunities Model is that it includes what was described earlier as the Transmission-of-Knowledge Model. For example, it seems naive to expect all students entering industrial arts teacher education courses to immediately take on total responsibility for making all decisions concerning what, how, and when they are to learn. Even the staunchest advocates of open education do not advocate total freedom. In the early stages of a course, the instructors should assume almost sole responsibility for making decisions in order to set the context of the course and to assist students to gain the all important functional knowledge and skills that will prepare them for designing their own learning. Nevertheless, it should be the goal of teacher educators to help learners to become less dependent on them as they progress through each course throughout the program. Only in this way, by allowing students to practice being independent learners, will the profession ever

reach the goal of producing teachers who are stimulators, questioners, challengers, and problem solvers.

### Diagnosing Learners

Teaching according to any definition cannot be separated from an understanding of learners. That instructors know their students well is fundamental to effective teaching. Therefore, the first component of the model, learner diagnosis, is crucial to the teaching-learning process.

Certainly, instructors who gain satisfaction from teaching should learn to diagnose their students and assist them in diagnosing themselves. Furthermore, faculty development programs would be less than complete if they did not address the topic of methods used to diagnose learners and how to aid learners in diagnosing themselves.

To be able to adapt teaching to the learning needs of *each* student means that instructors seek out or devise both informal and formal techniques and instruments in order to gather pertinent data. Information about the physical, educational, intellectual, and emotional characteristics, as well as interests and goals should result in a profile for each student. The key here is in developing profiles for *each* learner rather than groups of learners. The usual approach is to assess groups of students. The fallacy of assessing groups is that it does not help educators to learn about individuals. This in turn limits an instructor's ability to adapt teaching to individual students.

Teacher educators must also help students to diagnose themselves. For example, students might be asked their motives for learning. Of the three common motives for learning (ambition, curiosity, and necessity), curiosity appears to be the worthiest of development.

Students should also be helped to identify their response to the school environment. Are they "grade seekers" or "knowledge seekers"? Grade seekers are typically not dedicated learners for they exert their energies toward "playing the game" and/or "psyching out the professor." They have either lost or never learned the true value of learning. Knowledge seekers, however, have already been prepared somehow and somewhere to value learning. This type of student tends to be dedicated and sincerely interested in self-improvement. Teacher educators must assist all students to value learning since it is the most fundamental of all educational objectives.

Instructors can aid students to diagnose their prime time learning period(s). Prime time learning periods may be: (1) early morning, (2) mid-morning, (3) early afternoon, (4) late afternoon, (5) early evening, or (6) late evening. An awareness of prime learning times requires that students learn to set priorities and attempt to avoid or reduce factors which might infringe on their most effective time(s) for learning.

Teacher educators must also help students to become aware of their learning styles. Surprisingly, there are no standardized instruments available for assessing sensory modality preferences (Sperry, 1972, p. 316-317; Walsh and Soat, 1975, p. 40). Instruments, however, can be developed by instructors for this purpose. An item on an instrument might include: The easiest way(s) for me to learn new information in a particular course is to (1) read about it in books, (2) hear about it through lectures or recordings, (3) see it in visual form (charts, films, filmstrips, etc.), or (4) engage in hands-on activities.

Knowing this information will require that instructors have available various types of instructional materials and media in order to accommodate the sensory modality preferences of each group of learners. Another procedure would be to use a multi-method-media approach which would permit students to learn in their preferred sensory modality(s).

A number of tests are on the market to assess the cognitive style of field independence versus field dependence. However, three have been most commonly used. They are the Rod and Frame Test Series 3 (RFT), the section of the Tilting-Room-Tilting-Chair Test termed the Body-Adjustment Test (BAT), and the Embedded Figures Test (EFT). The first two tests require special equipment while the latter is a paper and pencil test. In the Embedded Figures Test (EFT) a person first sees then attempts to locate a simple geometric figure in each of twenty-four complex designs. Scores for the test are calculated by determining the mean amount of time required to identify each of the figures (Witkin, et al., 1962).

Two instruments have typically been used, primarily with young children, to measure the cognitive style of reflectiveness versus impulsivity. These are the Matching Familiar Faces Test (MFF) and the Haptic Visual Matching Test (HVM). In the

MFF test a person attempts to match a standard drawing with one exactly the same in a series of similar drawings, only one of which is identical. Performance is determined by the amount of time needed to select the correct response and by the number of errors committed.

The HVM test calls for matching a prescribed wooden figure that is explored with the fingers, but is not seen, with a series of similar figures only one of which is exactly the same. Performance is measured similarly as with the MFF test (DeCecco, 1968, p. 76-77).

The cognitive style of field independence versus field dependence can also be assessed in an informal manner by making these observations:

1. Does the learner require help from others in solving problems?
2. Does the learner consistently experience difficulty in planning and organizing problems or projects?
3. Does the learner tend to respond to concrete rather than abstract information or experiences?
4. Does the learner have difficulty identifying logical errors?
5. Does the learner prefer a structural learning environment?

Yes answers indicate that individuals are closer to the field dependent end of the continuum. Therefore, instructional strategies for learners with this cognitive style call for more teacher direction and support. It should be noted, however, that even though instructors may make more instructional decisions and assume more responsibilities as shown in the model, attempts should still be made to encourage curiosity, as well as the thinking and problem solving abilities of field dependent learners.

Instructors, too, may informally assess the cognitive style of reflective versus impulsive individuals by observing and then answering the following questions:

1. Does the learner tend to answer questions or respond to problem situations without giving much thought to them?
2. Does the learner tend to complete assignments without regard for quality?
3. Does the learner tend to be in a hurry to speak or act?

Yes answers tend to place students closer to the impulsive end of the reflective-impulsive continuum. Since impulsive learn-

ers also tend to be field dependent or nonanalytical they require teacher direction and guidance in addition to teaching techniques that emphasize speed. Group discussions, seminars, role playing, and projects which allow impulsive learners to set their own pace, tempered by teacher guidance, may be effective. On the other hand, reflective persons who also tend to be field independent or analytical thinkers and problem solvers require activities where speed is deemphasized. Lectures that allow reflective-analytical learners to think through and analyze ideas, experiments, and independent study which allows for self-pacing will probably result in optimal performance for these learners.

### **Content Selection**

Industrial arts by definition is concerned with studying industry and technology. The swift advance of technology in recent history would seem to offer a basis for an extremely exciting field of study. Unfortunately, to many industrial arts educators it has been a source of trepidation. Many in the profession have asked, "How can we keep pace with rapid technological change"?

A natural reaction to advancing technology has been to require more and more technical competence of our prospective teachers. We in teacher education have added more content in more areas with the result that students have had less input into their own professional development. At first glance this reaction seems to be a logical one. It is felt, however, that this reaction has led many in the profession off course. Many of our programs appear to be developing competent "machine operators" but less than competent teachers and independent thinkers in the technologies. Consequently, many of our graduates are quite capable of developing tool skills in their students but less than capable of fostering independent learning in their students.

Competency-based teacher education has been offered as a vehicle through which to develop even more technical knowledge and skills for our students. The public outcry for accountability, to a large extent, legitimized competency-based programs as the proper prescription for an educational illness. The authors seriously question this solution to educational problems. Some were even questioning the competencies route before it became a movement in education. In 1965 Combs wrote:

A vast complex of competencies, all of which are demanded as criteria for good teaching, leaves the individual defenseless before criticism. No matter what he does well, it is never enough! There is always so much more that he might have done, or should have done, that he can rarely find pleasure or satisfaction in his accomplishments. Add to this fact that many of the competencies demanded do not fit the particular personality, and so could probably never be achieved anyhow, and the defeat of the individual becomes almost inevitable (p. 5-6).

A number of concerns about competency-based education can be raised from Combs' statement. One of the more serious ones seems to be that, from the student's point of view, it is an "incompetencies approach." They may, in fact, spend most of their undergraduate years "curing" incompetencies. In light of what is known about the importance of a positive self-concept for both learning and teaching, do teacher educators dare dwell too long on incompetencies? Weingartner (1974, p. 194) reported that intellect and emotion cannot be separated and that healthy learning is only built on a feeling of adequacy, competence, and confidence of the learner in himself. The gravity of this viewpoint was also shared by Combs (1965) who, while discussing the adverse effects of a poor self-concept on learning, stated, "Millions of people are victims of the beliefs they hold about themselves" (p. 15).

Mitchell (1976), discussing effective teacher education programs, suggested that for competencies and objectives to be of optimum value they should be written at a level that is neither so general that they ". . . constitute gossamer, directionless tripe nor so specific as to be endlessly time-consuming . . ." to achieve (p. 7). He further cautioned that teacher educators must not become simply check-raters of unending competencies. The authors agree with this point of view and advocate a teacher education program that balances the acquisition of technical competencies with other important skills and experiences.

An important issue discussed throughout this chapter has been the value of developing independent learners. To prepare teachers to foster independence rather than control in our public schools will require revisions in many teacher education programs. Time must be found in programs for prospective teachers to become independent learners and problem solvers themselves. This is imperative if they are to grasp, internalize, and value the importance of it for others; namely the youngsters with whom they will interact.

Finding time in our programs to consciously and methodically develop new skills is not an easy task. What can be dropped to acquire the time? It is certain that inadequately prepared teachers may not only fail to provide students with the sound education to which they are entitled, but they may also endanger their physical well-being. These are unquestionably valid concerns. The authors are vividly aware of the need for graduating technically competent individuals who can adequately and professionally handle their teaching assignments. In view of this, the following suggestions are offered as practical ways to open up our programs to allow for the development of more independent learning.

Substantial cuts should be made in the amount of teacher directed lecture and demonstration time which now characterize our programs. Far too often we in teacher education have not allowed sufficient time for our students to become involved in problem solving situations. This is a result of our continual addition of content and skills in a futile attempt to keep pace with the *techniques* of industry and technology. What teacher educators should be more concerned with are *conceptual structures* and *problem solving processes* as they relate to industry and technology. By teaching the latter we have the hope of being able to produce flexible, self-renewing professionals who will be able to instill the same understandings and values in their students. Required technical sequences, whether they be courses or competencies, must be carefully scrutinized to determine how instructors can more effectively teach the basic technical knowledge and skills. Time must then be made available for our students to use their technical knowledge and skills to develop problem solving skills. In discussing industrial arts programs of the future, DeVore and Lauda (1976) related that knowledge is for ". . . use rather than possession" (p. 147). Our teacher education students must be given ample opportunity to *use* their knowledge rather than simply *acquire it*.

One method of systematically promoting independent learning would be to organize each technical course so that fundamental competencies are developed in the early stages. The remainder of the time would be devoted to student- or student/teacher-planned activities in which the new knowledge and skills

would be applied to challenging problem solving situations. This would, admittedly, be a conservative method of implementing the ideas presented in this chapter, but it could be a meaningful first step for many. At the same time it would reinforce the fact that industrial arts involves *using* knowledge and skills.

A second approach which holds much more promise for developing the kind of industrial arts teachers that are needed involves increasing the amount of student freedom and responsibility as they move through teacher education programs. This could begin with a technological orientation and a concentration of technical knowledge and skills. Students would then progress into courses as described in the previous example in which problem solving accompanies skill acquisition. From here, students would advance into a series of independent study projects and/or seminar courses designed to broaden and sharpen their knowledge about areas of industry and technology that are of interest to them. A primary objective, of course, would be to allow students to develop their independent learning abilities.

This second approach has much in common with the proposals of Wilson (1971) for the open-access curriculum. Wilson's model advocates much more time spent by learners in "Open Exploration" than in acquisition of "Fact." Broudy (1974, p. 4) also emphasizes the importance of more freedom and responsibility for students when he proposes more heuristic teaching — an interchange where problems are identified by teacher and learners together.

There are several benefits to be derived from this approach. Students would be thoroughly schooled in the basic competencies plus gain extensive expertise in areas of personal interest. Since students would be developing themselves as individuals they would possess something intensely and personally their own. In turn they will become professionals with unique talents and interests. In this way students would also be developing characteristics representative of good teachers and not become in Combs' (1965, p. 9) words the "carbon copies" that teacher education programs often produce. Allen (1974, p. 10), writing about the future of education, stresses the importance of diversity for the mental well-being of all individuals, students as well as teachers.



Adopting this second plan may also be easier to accomplish with existing departmental faculty. Faculty members who teach best in structured situations may feel more comfortable teaching courses where structure is desirable. For example, these individuals should be successful in preparing students with fundamental technical knowledge and skills. Instructors whose teaching styles fall somewhere between structured and informal may serve students best in courses where the development of basic technical competencies is followed by teacher/learner-planned problem solving experiences. Those instructors who function best in informal settings should help students flourish in independent study situations where students would assume greater decision making responsibilities.

While the purpose of the plan described here is intended to develop more independent learners among our future teachers, another benefit is that it can expose students, in a systematic manner, to several teaching styles and strategies. Joyce (1972, p. 8) suggested that while prospective teachers may want to be taught the "right" and "best" methods of teaching, teacher educators must admit to them that no such thing exists. Therefore, they will always need to be participants in the study of education and the process of teaching. It is our feeling that this can be adequately accomplished by using a plan such as the one previously outlined.

What we have proposed and that which is reflected in the Learning Opportunities Model (Figure 6-4), is that subjects, or content, should be initiated by instructors in some instances, by students and instructors in other cases; and by students themselves in still other instances. However, it should be implemented systematically rather than haphazardly and only after learner diagnosis has taken place.

### **Resources and Environments**

How can teacher educators open up the learning resources and environments for students? The preceding discussion implies many ways in which this could be accomplished. Several will be suggested here, but first it might be helpful to categorize this section as follows: (1) industry and technology, the source of our content and (2) youth and the schools, the future occupational environment of our students.

*Industry and Technology.* Much of the knowledge prospec-

tive teachers acquire takes place in school laboratories. Several guidelines were posited by DeVore and Lauda (1976, p. 152-154) for designing more relevant, flexible environments in our laboratories. They suggested transforming unit laboratories into more open space concepts to allow for flexibility in learning activities. Within existing facilities it is also possible to provide greater "open-access" to students. Scheduled lectures and demonstrations followed by "open laboratory" periods would make the resources and environment of departments more available to students. This in turn would allow students to plan their time more efficiently and also undertake more comprehensive studies than is possible with more structured scheduling arrangements.

According to Allen (1974, p. 4), the greatest problem facing education today is the attitudes that interaction between education and society should be avoided. Sadly, we in industrial arts education have not helped to dispel this attitude. Industrial arts educators have insisted that a study of industry and its technology should be a part of the liberal education program for all. Yet most have neglected to initiate programs that involve closer relationships with industry. Do we as teacher educators really believe that we can prepare students to teach about industry if our teacher education programs include no involvement with industry? It appears essential that actions be taken to develop a greater relationship between industry and teacher education programs. Industries are a rich resource indeed, and most are willing to cooperate with faculty and students in educational pursuits. Most colleges and universities are within easy access to industrial firms. We as teacher educators would be negligent if we did not use them as resources. Our students desperately need *first-hand* experiences if they are to adequately interpret the practices, careers, and problems of industry and technology to their students.

Field trips may be one method of providing the above mentioned first-hand experiences. These visits to industry are certainly not new in industrial arts education. Many teacher educators, however, become lax in scheduling appropriate visits to industry because these trips are no longer exciting to *them*. It should be kept in mind, though, that this may be the only opportunity for many students to see applications of concepts and careers learned in classrooms and laboratories. Having the oppor-

tunity to observe and question management and engineering personnel could be invaluable to some in strengthening their understanding of industry and technology.

Industry should be a primary source of information for many students working on independent study projects. To draw on the knowledge and resources of technologists, engineers, and managers could substantially enhance learning. It could also do something even more important by helping students identify with industry and, in turn, generate an increased enthusiasm for teaching about it to public school students.

Another method that holds much promise for our students is that of waiving introductory courses where proficiency can be shown. Much of our students' professional development time is wasted by requiring them to take courses in which they are already competent. If they could use this time to develop competencies in an area or areas of interest it would surely benefit them as well as their future students.

Many departments allow a limited number of credits to be earned by showing proficiencies through examinations and demonstrated skills. It would seem to serve the student better to maximize the number of courses offered on a credit-by-examination basis. But instead of reducing the amount of education required for the degree the student could be allowed to move into the independent study block sooner in lieu of enrolling in certain introductory courses.

*Youth and the Schools.* Our undergraduate programs, in many instances, have filled students with technical knowledge and skills, talked to them about good teaching methods, and then thrust them into student teaching experiences where they often feel unprepared. Barth (1972) summed up the feelings of many when he stated ". . . those in the business of preparing teachers can ill afford to be either blind to or ignorant of what they are preparing teachers for. . . . Teachers, as part of their training, must have ample opportunity to experience the problems of the real world for which they are being prepared . . ." (p. 207).

A strategy similar to that discussed earlier concerning the development of technical competencies could also serve well in developing teaching skills. This sequence could be composed of teacher-directed courses that address the "content" of teaching

methodology followed by student/instructor-planned teaching units to be implemented in public schools. The final experience (student teaching) would give each student the major responsibility for instructional planning.

Figure 6-5 depicts how a program utilizing the aforementioned plan has been employed in the professional course sequence at Ball State University (Barella and Henak, 1976).

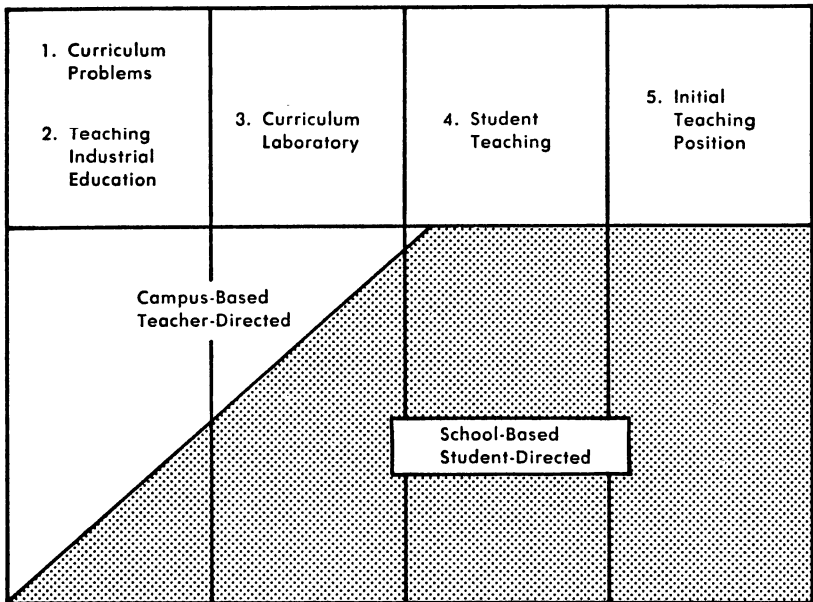

**Fig. 6-5. Progression of Experience in Professional Sequence.**

This articulated professional sequence moves students through a series of three courses plus student teaching with students gradually moving away from a campus-based, teacher-directed mode toward one which is primarily school-based and student-directed.

Another system in use at West Virginia University involves two graduate students — one planning teaching materials at the university while the other uses them in a public school industrial arts program. This approach should offer some imaginative adaptations for use at the undergraduate level.

### **The Contract Method**

The Learning Opportunities Model (Figure 6-4) was proposed earlier as a means of opening up teacher education programs to work with individual learner differences. Several suggestions have been made regarding the more critical aspects of the model. The model has been and can be implemented through the use of learning contracts. Learning contracts serve to help both instructors and students in the planning of learning activities. They particularly provide the opportunity for students to be the initiators and directors of their own learning. The use of learning contracts is based on the premise that students should be encouraged to take responsibility for their own learning. Instructors should serve primarily as managers and co-designers and only when needed as directors of learning. As stated earlier, however, instructors should typically assume the responsibility for making all key decisions in the early phases of a course. Once students have gained essential knowledge and skills they should be encouraged to build on what they learned by either sharing or taking full responsibility for designing their own learning. This can be done effectively using the contract method. Since the contract is a plan for learning it should be: (1) prepared by each student or in conjunction with the instructor, (2) agreed upon by students and instructor, and (3) a plan for which students will be held accountable.

The only decision component in the model which is not included in the contract is that termed learner diagnosis. Learner diagnosis should be accomplished by the instructor beforehand and also by the instructor and students in individual conferences to determine how best to meet the needs and accommodate the learning styles of each learner. Once this is done contracts can be prepared effectively.

What follows is a brief description of how contracts can be prepared using the eight decision components of the model:

1. **Subject area(s)** — Students state the subject area(s) related to the course which they intend to investigate. The instructor may also list or suggest possible areas for investigation.
2. **General Objective(s)** — Before objectives can be stated students should be advised to do some preliminary investigation. The instructor may suggest certain books, articles, films, dis-

- cussions with peers, instructors, and industry personnel. With this done students should state one or more general objectives which help them to focus in on their topics.
3. Performance Objective(s) — Specific objectives are the heart of the contract. Here students should be able to “key in” on their topics. A well written performance objective should include three components: (1) what the students will *do*, (2) under what *conditions* they will do it, and (3) to what *extent and level of performance* they will do it.
  4. Evaluation — It should be specified here who will evaluate whether students have in fact completed their performance objectives as stated. The instructor, of course, may decide to be the sole evaluator but it seems more appropriate to have joint instructor-student evaluations.
  5. Methods and Resources — Students should indicate the specific methods and resources they will use to collect their information. Methods may include discussions with instructors, writing letters, interviews, and seminars with other students and instructor. Resources may include specific people, data, or things.
  6. Sequencing and Scheduling — Here students indicate the appropriate order of their activities as well as important times and dates.
  7. Participants — Students should state if they will be working alone, with another student or with a group. If they are working with others they should write in their names.
  8. Environment — Students indicate here any special environments where they will be doing some or all of their work. For example, much of their work will be done in the usual environments such as the library, classroom, laboratory, and at home. However, if the instructor encourages students to design their own learning, then it might mean that studying in other environments may assist best in the achievement of objectives. Depending on the type of course, for instance, students may visit or even arrange to work in various industrial situations.

It should be noted, that the contracts when completed are binding, yet still open to modification. That is, the instructor and students may find that alterations may need to be made if, for

example, new information is discovered and unforeseen obstacles are encountered.

## SUMMARY

In this chapter an attempt has been made to show important areas in which teacher education programs must be “opened up.” It is paramount that teacher educators give students, as individuals, more responsibility for planning their own education — not only for their own self-development but also for the development of the youngsters and programs they will teaching in the public schools. Our present system has produced many dependent learners who, in turn, are teaching programs of accumulating knowledge without giving proper opportunities for its use.

The Transmission-of-Knowledge Model has been characterized as only the foundation for exciting and unique pieces of “artwork” — our students. The tragedy is that all too often we as teacher educators have not let the artwork be formed. We have continued to build the foundation for the duration of our students’ education. The result has been the “rubber stamps” mentioned earlier.

The authors have emphasized that if teacher education programs are to produce self-directed, flexible teachers then alternative patterns of teaching and learning are essential. To this end we have suggested that faculty development programs be initiated that focus on improved teaching practices and methods of diagnosing learners.

Particular attention was given to the concept of learning styles. Both formal and informal means of assessing learning styles were presented.

The Learning Opportunities Model was proposed as a means of opening up present programs to meet the needs of individual students. A number of methods were suggested for using the model in both the technical and professional aspects of our programs. These methods were meant to be evolutionary in nature meaning that they could be implemented in most programs without destroying existing strengths. Finally, it was shown how the Learning Opportunities Model could be implemented through the use of learning contracts.

The major emphasis throughout this chapter has been directed at revising teacher education programs to nurture diversity and uniqueness rather than standardization. It must be remembered that diversity, ingenuity, and individuality have made our country the greatest in the world. Teacher education programs that do not attend to learner variability and that do not produce self-directed, creative, flexible teachers fail everyone — the students, the schools, the profession, and the nation they are designed to serve.

## REFERENCES

- Allen, D. "What the future of education might be." In T. W. Hipple (Ed.), *The future of education: 1975-2000*. Pacific Palisades, Cal.: Goodyear, 1974.
- Barella, R. V. and Henak, R. "From campus-based to school-based experiences in industrial teacher education." *The Teacher Educator*, 1976, 12(1), 10-16.
- Barth, R. S. *Open education and the American school*. New York: Agathon, 1972.
- Broudy, H. S. "Education: 1975-2000." In T. W. Hipple (Ed.), *The future of education: 1975-2000*. Pacific Palisades, Cal.: Goodyear, 1974.
- Cahen, L. "Comments on Professor Messick's paper." In L. Sperry (Ed.), *Learning performance and individual differences*. Glenview, Ill.: Scott, Foresman, 1972.
- Change*. Fostering faculty talent. Author, 1976, 8(8), 10-13.
- Combs, A. C. *The professional education of teachers*. Boston: Allyn & Bacon, 1965.
- DeCecco, J. P. *The psychology of learning and instruction: Educational psychology*. Englewood Cliffs, N. J.: Prentice-Hall, 1968.
- DeVore, P. W. and Lauda, D. P. "Implications for industrial arts." In L. H. Smalley (Ed.), *Future alternatives for industrial arts*, 25th Yearbook of American Council on Industrial Arts Teacher Education, 1976.
- Dewey, J. "The relation of theory to practice in education." In *The relation of theory to practice in the education of teachers*, Third Yearbook of the National Society for the Scientific Study of Education, Part I. Chicago: University of Chicago Press, 1904.
- Frymier, J. R. "Issues in perspective." *Theory Into Practice*, 1976, 52, 23-30.
- Gardner, J. W. *No easy victories*. New York: Harper & Row, 1968.
- Goodenough, D. R. and Kays, S. A. "Field dependence and intellectual functioning." *Journal of Abnormal and Social Psychology*, 1961, 63, 241-246.
- Hamachek, D. "Characteristics of good teachers and implications for teacher education." *Phi Delta Kappan*, 1969, 50, 341-344.



- Johnson, I. H. "A teacher for tomorrow." *Proceedings of the American Industrial Arts Association's 32nd Annual Convention*, 1970, 382-384.
- Joyce, B. "The teacher innovator: A program for preparing educators." In B. Joyce and M. Weil (Eds.), *Perspectives for reform in teacher education*. Englewood Cliffs, N. J.: Prentice-Hall, 1972.
- Kagan, J. "Impulsive and reflective children: Significance of conceptual tempo." In J. D. Krumboltz (Ed.), *Learning and the educational process*. Chicago: Rand McNally, 1965.
- Kagan, J. "Reflective-impulsivity: The generality and dynamics of conceptual tempo." In L. Sperry (Ed.), *Learning performance and individual differences*. Glenview, Ill.: Scott, Foresman, 1972.
- Katz, J. (Ed.) *No time for youth*. San Francisco: Jossey-Bass, 1968.
- Kelley, E. C. *Education for what is real*. New York: Harper & Row, 1947.
- Letcher, D. A. "Teacher preparation: Training or education." *Proceedings of the American Industrial Arts Association's 32nd Annual Convention*, 1970, 384-385.
- Messick, S. "The criterion problem in the evaluation of instruction: Assessing possible, not just intellectual outcomes." In L. Sperry (Ed.), *Learning performance and individual differences*. Glenview, Ill.: Scott, Foresman, 1972.
- Mitchell, J. V., Jr. "The evaluation of teacher education programs: Conceptual dimensions and implications from research." *The Teacher Educator*, 1976, 12(2), 2-10.
- Riessman, F. "Student's learning styles." *Today's Education*, 1976, 65(3), 94-98.
- Sperry, L. (Ed.) *Learning performance and individual differences*. Glenview, Ill.: Scott, Foresman, 1972.
- Trent, J. W. and Medsker, L. L. *Beyond high school*. San Francisco: Jossey-Bass, 1968.
- Walsh, R. and Soat, D. "How trainees learn." *Training*, 1975, 12(6), 40-41 +.
- Weingartner, C. "Schools and the future." In T. W. Hipple (Ed.), *The future of Education: 1975-2000*. Pacific Palisades, Cal.: Goodyear, 1974.
- Wilson, L. C. *The open access curriculum*. Boston: Allyn & Bacon, 1971.
- Witkin, H. A., Dyk, R. B., Faterson, H. F., Goodenough, D. R., and Karp, S. A. *Psychological differentiation*. New York: Wiley & Sons, 1962.
- Witkin, H. A., Goodenough, D. R., and Karp, S. A. "Stability of cognitive style from childhood to young adulthood." *Journal of Personality and Social Psychology*, 1967, 7, 291-300.
- Wood, S. "A multidimensional model for the observation, analysis and assessment of classroom behavior." *Journal of Research and Development in Education*, 1970, 4, 89-94.

*Dr. James S. Levande*

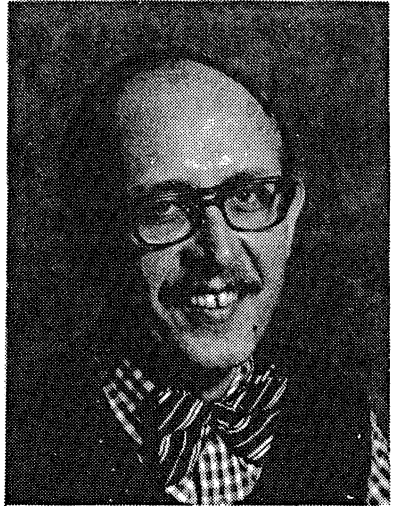

Dr. Levande is an industrial arts teacher in the MacDonald Middle School, East Lansing, Michigan.

He has taught both graduate and undergraduate courses dealing with industrial arts and career education at the university level.

For the past several years he has served as a consultant on topics concerning the middle school and on career education to various local school systems, Michigan State University and the State of Michigan. He has also served on the industrial arts advisory boards of Michigan State University and Lake Superior State College.

He is actively involved in the area of professional development, currently serving as chairperson of a multi-district, regional professional development advisory council.

He has also served the profession through publications and presentations at state and national conferences.

# The Open Access Teacher

*James S. Levande*

## INTRODUCTION

The industrial arts teacher in the "open setting" is faced with many complex problems. This chapter is one teacher's view of the problems in which one becomes involved as to the theory, concepts and philosophy of the open school. The view presented comes from within the organization. The focus is practice and the everyday events and activities which occur. The chapter presentation traces a teacher's involvement from initial contact with open education, through the operation of a program and a look at some alternatives for the future. Included is one practitioner's definition of the open school, the problems dealing with openness, the nature of the learner in the laboratory-classroom, organization and management of facilities, decision making and articulation as experienced by a teacher in an open education middle school.

## THE TEACHER IN OPEN EDUCATION

### What is An Open School?

Many would contend that an open school has large open areas which permit the free movement of students as they proceed through various learning activities. This attention placed on the physical aspects of the school environment is secondary to the true definition. An open school is one that focuses on the

learner and directs its efforts at providing the flexibility to use what is known about the learner to provide for student needs and reach educational goals in society. Depending upon local resources and circumstances open concepts can be fostered in both conventional and open area physical space.

Open education is frequently exemplified in the United States through the middle school movement. Starting in the early 1960's the middle school educational organization was exemplified by open education concepts. Open areas, flexible scheduling, individualization, and team teaching were just a few of the innovations in curriculum, administration and facilities.

The ACIATE's 21st yearbook (Householder, 1971) describes and documents the place of industrial arts in the middle school. The writers in that yearbook presented the underlying theory and concepts of middle school education and the philosophy and practices of industrial arts in relation to this form of education. The case studies used by these writers to exemplify their presentations exposes a broad spectrum of programs and activities for adolescent students. All of that information is contributory to understanding the position of the individual teacher in a middle school.

"Open education" has been incorporated extensively into the middle school and because the school about which this is being written is a middle school, this chapter shall emphasize open education at that level.

## **THE TEACHER DECISION-MAKING PROCESS**

In most communities the decision to implement a middle school program is premised on the belief that change is required. The schools of the United States have never been without criticism based on justifiable standards and evaluation. This criticism and the resultant remedies are a basis for the belief in change as a remedy.

Holt (1966, 1967, 1969), and Sibberman (1970, 1973) criticize and propose remedies based on the humanization of the educational endeavor. Their proposals indicate that a change in the direction of humanization results in a growth toward openness for individuals, schools and society as a whole. Open education is a manifestation of these ideas.

The impetus to make the decision for change and growth derive from these critics and their remedies. The reasons offered for the decision vary from the pragmatic necessity to relieve overcrowded elementary and high school classrooms, through restructuring of junior high school programs, to the consideration of the special needs and developmental stages of early adolescents.

### **Committees**

The teacher becomes involved through representation and participation on the various planning groups formed by the community to consider changes. These committees and commissions make recommendations about the feasibility and organization of a middle school. Usually the teacher is an observer of the process at this stage. These study groups may solicit input from the teacher but more frequently the teacher must seek out representatives to the group to make known ideas and concerns. Once the decision is made to develop a middle school program, then the teacher becomes actively involved.

### **Involvement**

Direct, active involvement takes on a number of forms. Cross-discipline faculty advisory groups, intra-disciplinary groups and individual efforts are means by which the teacher's efforts are channelled in the development of the philosophy and resultant curriculum for the middle school. The advisory group usually oversees and coordinates the efforts of the program's development; it makes decisions about the program and recommends policies to the superintendent and school board. Intra-disciplinary groups concentrate on their particular field, i.e., industrial arts, language arts, mathematics. The individual teacher effort concentrates upon gaining knowledge and personal insight with respect to facilitating the learning process and managing learners in the open program.

In the case of most industrial arts teachers, because of the number of different groups, one must spread one's efforts thinly. This has been caused by most schools having one industrial arts teacher per three hundred to five hundred students as compared to other areas of study where there may be a teacher for every one hundred twenty-five students. At most there will probably be only two industrial arts teachers to speak for their field.

A key factor in being heard is selecting those groups which have the potential for formulating the largest share of the program and working actively with these groups.

### **Philosophy**

The industrial arts teacher, working within the committee structure, must present and promote industrial arts as a part of a total general education program. This philosophy of industrial arts must be argued in the consideration of each and every alternative as the program develops. If our field is truly an integral segment of general education then its principles and objectives must be represented in the overall organization of an open curriculum.

The industrial arts teacher, to be effective, must be willing to communicate with others and to develop a more global view of industrial arts as an area of study for young people. The uniqueness of industrial arts, as compared to the other disciplines, must be described and defended in an objective manner. It must be pointed out that industrial arts, because of its uniqueness, supplements and enhances all other parts of the school program.

In presenting and arguing the unique contributions made by industrial arts to general education and, in particular, open education the teacher must avoid compromising basic principles. In many instances compromises are made for the sake of integrating the objectives of various disciplines into an open program. Under these circumstances industrial arts becomes a portion of the program which relegates the study of technology to a position of secondary importance. Frequently the emphasis is on fine arts concepts using different media for student expression. Unless the industrial arts teacher can be influential, no concern is given to understanding basic materials, machine processes, the impact of past and current technologies on society in the form of individual and group efforts, and the impact of technology on the way we live and will continue to live.

Intra-disciplinary program planning is also a part of the committee process as well as an individual process. This focuses on a review of the current, or existing, industrial arts program in the light of an open school philosophy. Questions such as these must be considered: What objectives must be rewritten to focus

on the learner's needs and abilities? What concepts must be re-ordered into new configurations? What kind of instructional activities will be necessary to deliver the concepts to the student? Will team teaching approaches be required? As the industrial arts teacher and other teachers in the school work within the domain of the field, they are required to review the entire school philosophy and emerging program as the middle school develops so that program alternatives may be considered. The teacher must also look outside the field for additional information and resources that can help to develop the best possible plans for an active and flexible program.

### **Decision-Making**

The individual teacher's efforts in entering the open education curriculum rests on the decision to work with teachers in interdisciplinary planning groups. Prior to entering this work the individual will need to analyze his or her personal philosophy and commitment in relation to the organization of the new open school program. If a decision is made to continue involvement, then an assessment of personal strengths and weaknesses is required. These strengths must be matched with all aspects of the total program. In those areas found to be in need of understanding and development, a plan of action must be designed to assess the necessary knowledge and competencies required.

Perhaps it should be argued that the teacher should consider a commitment to the open concept from the time it becomes a serious topic as means to operate the middle school. The lines of strengths and weaknesses, along with their assessment, are not as clearly drawn or resolved as would appear in the previous statement. Each individual has different personal perceptions and self-images. These characteristics enter into the decision making: perceptions and self images must match the new program, its administration and physical facility. This process of deciding helps to define and balance the teaching role in the new situation. If this personal matching and decision making fails to provide the individual with an easy transition into the open concept the alternatives are to work for changes in the structure or to seek a different teaching position.

The decision making and perception matching encompasses the characteristic of being a real person (Barth, 1971) in an open

classroom setting. In encountering the situation teachers must recognize that they will be required to participate in an open educational system. Industrial arts to be successful must strive to be integrated through planning committees into the total program. This participation must be based on consistency of teacher behavior in all forms of human interaction in the development and operation of an open education school.

### **Problems in Making the Decision**

The biggest problem in making the choice to stay in an open education school is understanding one's personal and educational philosophy of both industrial arts and the open education concept. Teacher preparation programs in industrial arts include basic philosophy and principles in the field. However, the individual must develop a personal philosophy combining industrial arts and a belief system. A great deal of confusion is created for all teachers, once they are in the field, when they are confronted by a decision that mandates a change to a new program or curriculum. Not only is the teacher required to set a personal philosophy/value system straight with their discipline but the added requirement of reconciling the variable of the innovation or change burdens the thought and decision making processes.

## **OUTSIDE SUPPORT FOR DECISION MAKING**

### **Administrative**

If a local district decides upon the open concept for its program then some of the burden must rest on the administrators to provide information and support. A classroom teacher making curriculum decisions needs the support of his principal, supervisor and superintendent.

In most instances this support takes the form of involving the teacher in the decision making very early in the process and in providing the opportunity to explore personal philosophies as they relate to the open educational program. This opportunity to test personal theories and ideas in a non-threatening atmosphere is beneficial to effective decision making. But in the end there is still the act of making a personal choice. Even with the administrators taking the responsibility to provide support there must be a return to that final lonely place of personal decision making.



### **Local Teacher Organizations**

Teacher groups also share in the responsibility for supporting the decision-making process. Their role falls into two areas. Upholding the standards and ethics of the profession with respect to the proposed changes is the first area. The second is to provide a support system for the individual teacher's right to be heard with respect to these changes.

The specifics of responsibility regarding professional standards and ethics are defined by the teacher organization and contractual agreements with local school boards. The organization, within these set limits, must speak out when it appears that the changes will compromise sound educational and professional standards. In this manner the voices of individual teachers are joined together. This provides an effective foundation for decision-making where a single voice might not carry weight and authority.

In supporting the individual's right to be heard, the teacher organization provides a basis for the industrial arts teacher to argue for the field within the developmental process of an open middle school. As in most group planning efforts, the initial development of an open middle school plan can contain misconceptions and omissions as to the intent and purposes of industrial arts. Advocating industrial arts, or any other discipline, in the face of an attitude of *laissez-faire* or opposition would be impossible. Organizational support supplies access to a forum for the objective and rational presentation of ideas.

The individual who, through personal decision making, fails to help make an easy transition to the open concept finds support in the teacher organization. As it was noted above, these teachers have the alternative to work for changes in program direction and structure. The teacher organization supports their right to be heard just as it does in the case of the industrial arts teacher advocating his or her discipline's place in the open middle school.

### **Colleague Support**

The development of perceptions and attitudes central to an open middle school program requires the consistency of a person across time and situation (Barth, 1971). Colleague support must foster an atmosphere where this "real person" can operate. This consistency can develop by not demanding that various roles be enacted as the committee process organizes the school's program.

The teachers must provide each other with encouragement to express views, opinions and ideas. Criticism, censure and condemnation should be directed at the objective merits of the argument and not at the person as an individual. The knowledge that one's ideas can be questioned while he or she as a person has value outside of the point in contention provides security to speak out.

### **THOSE WHO DON'T ENTER THE OPEN MIDDLE SCHOOL**

What of those who do not choose to work with the open middle school concept? Their choices are limited. One of the alternatives mentioned earlier was to seek a different teaching position. At times it is impossible to provide them with other teaching responsibilities within the district. A move to another school district may be necessary in order to work under a philosophy similar to theirs. And yes, some choose to stay. The motivations for the remaining are many: age, family commitments, the desire to remain in the community. Of those who do choose to stay, many become assets in the process of developing and operating an open program. Their questions are the ones that require the most thoughtful and reasoned answers. The problems of adjustment for all those who decide to work within an open program are just as great whatever the reason for making the commitment.

In summary the teacher must become involved in a series of critical and frequently personal decisions to be effective in an open education philosophy. These decisions involve making a commitment and an active involvement in the process of program development. Most of all these decisions require the teacher to become involved in working in an effective manner with other people.

### **IMPLEMENTING THE OPEN EDUCATION SCHOOL CURRICULUM**

Our exploration has already begun in decision making. After a choice is made, the teacher must become actively involved as the staff begins exploration and development.

To start, let us assume that a major decision has been made to develop an open middle school. The community's motivations to make this decision will have been based on a mixture of philosophical and pragmatic considerations; i.e., student needs, space constraints, enrollment fluctuations. The school's administration will organize its efforts to begin implementing this decision. Through the use of inservice and professional development programs, travel to other schools and conferences, the entire staff begins to examine concepts, philosophy and organizational patterns.

### **Staff Development**

The objective of staff development is to create a harmonious group of professionals having a positive attitude toward and a commitment to the open education process. The focus of the philosophy of the staff is on planning a student oriented program. The administration of the schools plays an important role in this area. Central administrators will be taking on greater responsibility for developing leadership and a strong support program. The building principal, in turn, must demonstrate a commitment to the open concept and have the ability to transmit this commitment to teachers. In a sense the principal operates on the same open basis as teachers are expected to do in their classes. The atmosphere that prevails must be a learning/growing process for the staff.

A secondary aspect of staff development is to develop linkages with the community as a whole. These linkages serve two purposes; an ongoing communication with parents and the organization of resources for enhancing and expanding instruction. Parent communication provides a link to maintain a consistency of goals between home and school. The purpose of this communication is not to wait for academic or behavioral problems to arise but anticipate and solve them before the program begins. The mutual agreement of parents and teachers about desired outcomes for the child provide a starting point for instruction and prevent problems during the school year. The organization of community resources for instructional purposes reveals the school's goals and gains support for school activities; they result in resource persons with special skills and experience which pro-

vide an outside view and give credibility to in-school activity. Usually a community member is only peripherally associated with the school through elections and funding campaigns and, at most, if they have a child in school, their focus is through the child's interests. By working in the school as a resource they gain a sense of being involved with the program.

### **The Nature of the Learner**

As the staff begins to explore implementation in earnest it increasingly turns to discussions about the nature of the learner. This topic falls into these three areas: displayed behavior, needs and learning process. If the curriculum and organization of the school is going to allow each child the opportunity to follow individualized paths, then these three areas must be examined in light of what is to be accomplished.

The behaviors displayed by children who are served by the middle school are a natural expression of their growth and development. The behavior is task oriented and falls into these categories: Increasing independence, increasing concern with the peer group, increasing heterosexual functioning, and changing perceptions of self. (Blom, Gerard and Kinsinger, 1974).

As educators, we frequently mention the "needs of students." What are they? Physical or basic needs for survival are a minimum requirement. But what of the other needs to be dealt with in an open setting? Social acceptance, including peer recognition, is another level of need. With respect to functioning in the social setting there are the needs for intellectual stimulation, challenge and expression. There are also the needs to be unique, make an impact on the environment and to problem solve with respect to making one's impression on the environment.

The learning process used by the child at the middle school level varies. One can turn to Piaget, Bruner, and others to explore these concepts and theories in detail. Interacting with the environment is a key factor in the learning process at this and all ages. In the case of the middle school, that interaction is a concrete, physical, manipulative one; it is just reaching into abstract processes. The range of students within this learning continuum is vast and curriculum organization and instruction must match this range.

## **Organizing for Learning**

How does the teacher and the middle school attempt to organize to meet the above stated behaviors, needs and learning characteristics? All middle school programs base their curricula on the idea that responsibility for learning must be transferred to the learner. The teacher's efforts are directed at motivating the student to seek knowledge rather than dispensing knowledge.

Open middle school teachers operate with many forms of organization to accomplish the task of bringing the child to this self-reliant approach to learning. Three common methods in which this is done are: "school within a school," houses, and teams. Along with these structures various scheduling procedures are followed to allow for flexible use of time during each school day and week. Each of the three methods of structuring has a myriad of variations. A short description can help to set each in perspective.

### **School Within a School**

The school within a school is an option for students to participate in an open learning environment. Complete responsibility is given to the student. The remainder of the school operates much as most traditional learning environments and serves as a resource to the student and school within a school. Coping with this activity requires the ability to be flexible and patient. The teacher is a reference point, facilitator and coach. Working one-to-one is the nature of the teaching atmosphere. The coming and going of students in almost random fashion means organizing instructional materials and processes for quick start up and take down. A vast amount of reference material, in a variety of hard- and soft-ware, must also be on hand. Instruction relies on the proper diagnosis and prescription for the student. Asking the right questions and eliciting the desired response are important in helping the child to continue the learning process. Monitoring the activities to see that the prescription is followed and/or changed is the evaluative mode in the school within a school.

### **House**

A more common structure is the house concept. Here the student is assigned to a group of learners that cross grade and age levels. He or she will spend their entire middle school career in this group or house. Usually the teachers in the house will take

full responsibility for instruction in Math, English, Science and Social Studies, and schedule students in and out of group and individual instruction for a large block of the school day. About two hundred minutes are used in each school day. The remainder of the day is used for instruction in industrial arts, home economics, physical education, music, art, and foreign languages. Here again, the teacher must be an active observer and participant in the learning process. The house concept requires that the teacher maintain continuity across time. Three years, as is found in most middle schools, provides for in-depth interaction with students and requires a longer range view of the learning process. As the child grows and matures the teaching strategies change. Goals and objectives may remain the same but the means to achieve them will change. There is the requirement that the teacher initiate and carry out instructional strategies that go from one school year to the next.

Relationships with colleagues change from the more traditionally conceived roles in the house concept. The flexibility of the program day can capitalize on using individual teacher talents to their full potential. These talents should complement each other. Open communication is an important ingredient in this relationship. Regular meetings dealing with the curriculum organization, instructional strategy and pupil performance form a core in the effective functioning of a house program. These meetings will also provide for cross-discipline reinforcement of concepts. For example, a requirement that all students be able to write complete sentences can be carried over into areas outside the language arts instruction. Colleague communication can develop a strategy to enact the goal, to agree upon standards and to evaluate the outcome.

### **Team Teaching**

Team teaching is the third form of organization used in open middle schools. Again, as in the house concept, the colleague relationship plays a vital role in the team's functioning. The team is usually organized on the basis of using a block of time each day for instruction in Math, English, Science and Social Studies. The difference between this and the house is that only one grade and age range is serviced.

A typical team will break up the daily time block to fit its instructional goals. A film might be shown to the whole group

using 35 to 40 minutes. After this some students will be scheduled into smaller groups for the purpose of discussing the film or to do other activities. Time is used to gain the best advantage for the nature of the activity. Science labs may take longer while presentations of math or language skill concepts will require a shorter time span.

The other instructional areas or programs, industrial arts, physical education, music, etc., serve the team as in the case of the house organization. No direct communication link is established in the team or the house setting. Consistency in standards and evaluation are the inevitable loss in this structuring. For the industrial arts teacher, the case is that he or she is serving the entire school population and the cycling in and out of team or house students cannot be accommodated. Time and space are used to their fullest capacity. Mutual planning time is also ruled out in the house and team approaches because of the full capacity of the lab and time.

Just because there is no involvement does not mean that teachers outside the team or house stay away from involvement. Joint school efforts, such as career carnivals, bicentennial projects or all-school events, become the vehicles for this involvement. Time is usually the prohibiting factor in enabling these activities to occur on a regular basis. If the industrial arts teacher is serving the entire school population and his or her objectives are the same as a colleague's, then the activity has the potential for interaction. In most cases this means that the teacher integrates the industrial arts objective with the objectives of the other activity.

Another, less prevalent, form of teaming is intra-disciplinary in nature. This format limits the fullest range of openness in the program but does have the ability to expose the student to the relatedness of concepts as they cross areas within the discipline of technology. Its isolation from the rest of the program prevents cross over of mutual goals, criteria, standards and evaluation. Only a segment of the entire structure of knowledge and curriculum is explored in the intra approach.

### **Scheduling**

The scheduling of schools within schools, houses and teams presents a problem for most middle schools. Computerization has

provided some help in this matter. The word, mod, for module of time is frequently mentioned in this context. Mods are blocks of time ranging from five to as much as twenty minutes of a school day. The mods are usually regular increments or intervals. They are used like building blocks in assembling schedules. The teachers will set down a program of mods for each student or small group of students on a periodic basis — weekly, bi-weekly or monthly. So many blocks or mods of time for math, industrial arts, English, etc., will be prescribed and the computer will be programmed to set up schedules. These schedules will set number, time and location for the mod or mods and indicate to the teachers where a student will be assigned on any given day and time. Variables such as lunch, planning time, and physical space limits are built into the program. A drawback in the use of computer scheduling is that conflicts and overlaps can happen if there is no flexibility in the school day. This flexibility usually means unassigned time for students. Space and supervision must be provided for these unassigned students. Most communities object to having middle school students involved in activities that are not associated with a regular part of the subjects and disciplines in the curriculum. For the most part, sound goals and policies for the use of unassigned time are absent and the majority of schools still hand process schedules or computerize scheduling to insure that students are engaged in some part of the regular instructional program. The teacher holds a responsible position in this scheduling format. Pupils must be accounted for. Truancy and absenteeism are the results of teacher irresponsibility in accounting. A portion of planning and preparation time is regularly devoted to the scheduling activity to help in meeting this responsibility.

## TEACHER ADJUSTMENT

In the above curricular structures, problems of staff adjustment, exclusion, preservice and inservice education, and communication are major areas of concern.

It was noted earlier that commitment to the concept of open schools is important on the part of the individual. Even if there is a commitment the teacher encounters various perceptions of what is open. Adjustments become necessary in working out a



consensus definition based on these perceptions. Agreement on basic philosophy is the foundation for discussions in the development of a working definition of open. The teacher must be willing to make rational arguments for his or her views. These arguments must be substantiated on the knowledge produced through sound research and the philosophy and principles of the teacher's chosen field. All too frequently, emotional arguments arise bringing discussions down to a level that involve personal self-centered motivations as a primary basis for decision making. Teachers value that which they teach for various reasons. Adjustment requires that the real merit and value of each curricular area be meshed with all others on an objective basis.

In many schools that employ the open concept, staff members are encouraged to consider how their area or discipline relates to the others in the school program. A positive approach is used in initiating the rational and objective development of the open concept. "What other disciplines do I use in approaching my own?" is often a first question in the adjustment process. "If I were to team up with any other discipline for instructional purposes, what could we do to integrate, complement and supplement each other?" is the next question. Answers to these questions open alternative approaches and develop mutual concern for each person's role in the program.

Exclusion is an aspect that all teachers face in the development and operationalization of any open program. Personal choice may allow teachers to exclude themselves from involvement; this results in the person seeking employment in other areas within and without the system. Under the current climate of declining enrollments and over supply of teachers in some areas, the choice of personal exclusion may not be available. A person may still be opted into becoming involved. Another form of exclusion is that of structure. As was stated above in the house and team structures, a particular form of program will exclude certain areas of the program. Industrial arts is more often than not excluded on the basis of structure. Later in this section we will examine a means to open up the industrial arts area even if there is this notion of separation by design.

The teachers who exclude themselves by personal choice do so because of education and orientation toward an isolated approach to traditional disciplines. One teacher overheard by this

writer expressed it as “math, English, science and social studies. Take their initials and you spell MESS with three s’s.” When persons such as these must stay and be involved with the program, the school’s administration plays an important role in utilizing their talents. There are always students that need more structured approaches to knowledge. The idea is to take these teachers and utilize them in working with the structured approaches. The principal, as the school leader, takes the responsibility to balance the students’ needs with the talents of the structured staff members.

Formal exclusion through program design prevent the committed teacher from fully participating in the program. The teacher, in this case, must work at incorporating as much as possible into their curricular area and instruction. The knowledge developed in designing the program and communicating with other staff members is used to help provide instructional activity in the industrial arts lab or other excluded area. There is no prohibition against requiring students to use the concepts and skills learned in math, language arts, and social studies in the pursuit of industrial arts objectives and in fact, making them industrial arts objectives. Writing a sentence for a properly thought out plan may have more meaning for a seventh grader than writing a sentence for a social studies report. The industrial arts plan, in all likelihood, will meet a more immediate need for the student: the object is constructed and put to quick and certain use.

### **Staff Education**

Education of the staff serves to help in easing adjustment and exclusion and to enhance development. Education for middle school teachers has fallen primarily into the post baccalaureate area. This does not say that institutions of higher education are not aware and involved with open middle school concepts. For the most part these institutions and programs are isolated geographically or make up only one aspect of an already demanding program of teacher preparation. Two avenues are usually pursued in the process of staff education — inservice/professional development and professional organization resources, conferences and workshops.

Inservice education is found most often at the local school district level and is based on staff commitment, consensus and

needs. Administrators and teachers work together developing the format and programs. In some cases outside consultants and resources are called in to help. Often times local staffs discover their needs can be met by a colleague who has the necessary expertise. The questioning activity, discussed as part of adjustment, is frequently used in professional development programs as a start for organizing middle school programs.

A more recent aspect of organizing for local inservice needs is the area or regional "Professional Development Center." At this time, the U. S. Office of Education is developing guidelines for the use of federal funds for such centers (Federal Register, 1977). These centers act as clearing houses and resource centers for their geographic areas. Teachers usually have a majority voice in the policy development and governing of these centers. Under the federal guidelines, teachers will be given the authority to hold a majority vote in these areas of decision making. The center staff acts to help facilitate, organize and provide resources for the expressed needs of teachers. Teachers concerned with developing new skills and concepts about open middle school programs are turning to these centers to help them.

Professional organizations such as the National Middle School Association and its state level affiliates are making efforts to help teachers with inservice and up-dating on concepts and practices. One such state level organization, the Michigan Association of Middle School Educators (MAMSE), can serve as an example. MAMSE is composed of teachers from all disciplines and administrators. It has as its purpose the development and implementation of sound middle school philosophy and practices. The organization maintains a resource library containing literature and tapes on a variety of subjects related to middle schools for its membership. It also serves as a consultant clearing house, matching members who require assistance with those who have experience in the area of need. An annual conference is held to provide a platform for teachers, counselors and administrators to present ideas and share concerns. Middle school students and parents also meet under the sponsorship and in conjunction with these annual conferences. These latter activities provide a broader base for community involvement in this educational concept. This has also helped to remove students and especially parents

from the isolation of their local community in order to share their concerns and ideas.

### **Teachers for the Middle School**

In those programs and institutions that do work with the middle school concept there is a consistent effort directed at exposing the practitioner in training to those same aspects and concerns of the teacher in the field. One means employed is to place the teacher in training into the field prior to student teaching. Volunteer work, tutoring and teacher assistance are activities that these people engage in.

There is even impetus to develop special standards for the certification of middle school teachers. Some states are considering special requirements. These requirements are being assembled through discussion between teachers, administrators, teacher preparation institutions and state boards of education.

## **VOLUNTEERS AND COMMUNITY RESOURCES**

The organization of community resources, including those of the teachers in training, for instructional purposes helps to reveal the school's purposes and gains support for school activities. Of course, the primary purpose for the teacher is for these efforts to help with the improvement of instruction. Guests with special skills and unique experiences provide reality and give creditability to classroom activity. The community member gains a sense of being involved with the program when usually this person is only peripherally associated with the school through school board elections, funding referendums and board debates on controversial issues.

Community resources take on many forms. Volunteer programs, resource persons and field locations for trips and student activity are three important uses of such resources. Resource persons and field locations are used more or less in most school situations. One new aspect in the use of these resources is computer based cataloging with cross-referencing. A teacher can now locate the special person or site that fits the current instructional need without endless telephoning and/or leg work. Each teacher helps in keeping this data bank of resources up to date through their securing new resources and evaluating those already in use.

Volunteer programs can take on various characteristics and procedures. In the one that is described below, the objective was to match teacher needs with people who were willing to commit themselves to working in the school on a regular basis. Usually, the teacher would indicate to the program coordinator, in this case another volunteer, that they needed someone to help slow readers, monitor small groups doing library reference work, teach machine use skills to individuals, or help non-English speaking students with interpretation of materials. If a person with the needed abilities were available, then the teacher and the volunteer would work out a mutually agreed upon schedule and goals to be achieved. The volunteer's presence relieves the teacher to concentrate on other instructional goals and provide more individualized attention to each student. One other aspect of the volunteer program gives the student exposure to the community's commitment to the school and a sense of belonging to the community.

### **Students in the Community**

Another aspect of community involvement for students can be found in programs where the learner moves into the community on a regular basis. While in the community setting, the child works as a volunteer or, in the case where labor regulations permit, in paid employment.

The volunteer experience brings the middle schoolers in contact with people that they can help. They can work as teacher aides in elementary classrooms; tutoring elementary children in reading, math and other skills. They can act as interpreters for English as a second language children and provide supervision on field trips. All of these experiences contribute to developing a sense of contribution and self-worth in the learner.

Paid employment becomes an alternative for those students who can qualify under local and state regulations. The nature of this employment varies but it normally places students in jobs which require them to interact with adults in responsible shared tasks. They take on work in custodial, maintenance and food service activities. In this writer's case, one of the students who is enrolled in industrial arts classes during the day returns each afternoon to clean the laboratory. A condition for working in such a program is the requirement that the student maintain a

good record of attendance and performance in the daily school program.

In both of the above examples, the school provides a staff member to coordinate the activity and to serve as a counselor/advisor to the student.

Industrial arts classes and groups also become involved in these community activities and services. Some examples are described below.

In the first example, students, as part of their regular industrial arts objectives, are required to become involved with a service project. This project must benefit some other person or group other than the student. In one instance, the teacher, through the use of community resources, keeps a list of projects from which the student can select. Repairing toys, puzzles and games for local day care and nursery school programs, is one such type of project. In all of these cases the students make contact with the person or group, discuss objectives and capabilities and set down a plan of action.

Another avenue is for the students to organize to build toys for the Toys-For-Tots Program of the United States Marine Corps, help with equipment for Head Start or other school programs.

Involvement in all of these examples requires contact with the people to be served. Communication about expectations brings out the benefits that each side can gain. Observing the situation and location where the effort is to be directed or accomplished also exposes the learner to the various social environments that exist in the community.

## **AN OPEN TEACHING MODEL**

Up to this point our look at the classroom teacher has focused on the involvement and operation of an open middle school in a general fashion. What about the industrial arts teacher?

The actions of the individual industrial arts teacher that can bring about the open concept can be described as a pattern or patterns of behavior: role. In adjusting to or working with a commitment to a middle school program, the teacher faces changes in the role that he or she has been using in the class-

room and with colleagues. The changes in the program, curriculum and methods required by opening up the middle school force one to think in new patterns and act in new ways. The industrial arts teacher must approach the new program with personal insight.

Let us examine this topic by looking at what theory and research has presented with respect to the decision making, development and adjustment of the teacher and relate it to the practices of an industrial arts teacher in an open middle school.

Argyris and Schön (1976) have shown that the behavior of the professional practitioner can be changed through an application of self-scrutiny and self-evaluation. Their research has demonstrated that change can be achieved in the direction of bringing espoused theories in line with actual personal practice. A major component of this approach follows the same avenue as Wilson (1971) suggests (p. 153): liberalize the teacher. Argyris and Schön term this liberalization the maximizing of free and informed choice by the professional. Other important points in their theory are that communication based on valid information is necessary for the development of an effective professional and the individual professional must maximize internal commitment to decisions made. The valid information provides a basis for an informed choice. The informed and freely made decision leads to the person committing strong efforts towards implementing the decision.

In bringing about a change in the direction of an open role the teacher's behavior patterns in terms of action, prescription, evaluation, description and sanction must be analyzed and compared to a model of open access role (Biddle and Thomas, 1966). This model must serve as a measure by which change and effectiveness can be gauged. Barth (1974) in working with open classroom settings in the United States and Great Britain has developed such a model. This model lends itself to an application in industrial arts in that it can systematically accommodate a technological knowledge base, a developmental approach to the acquisition of knowledge, the inquiry method, and the structure of an open access curriculum.

Barth postulates four characteristics for the teacher in an open classroom. They are the teacher as: a person, a knower, a facilitator of learning, and a manager of learners. These charac-

teristics are not roles but categories for the behavior patterns defined by Biddle and Thomas. They encompass the ideal, or espoused theory, of professional practice for the open teaching role and serve as the bench mark for determining an increased effectiveness in the open middle school setting.

### **The Person**

It is necessary for the teacher to recognize that he or she is part of a total educational system and that the successful functioning of an industrial arts program is an integral part of that system. There is only one set of behaviors for a teacher in this system. They must allow for free and informed choice and personal commitment to the decisions resulting from that choice making. The teacher must provide consistent valid input into interactions with students, colleagues and community members. A confusion on the part of the teacher as to which behaviors to apply in various human interactions can only result in a fragmented approach to life. Each new exchange would, in this form of behavior, produce a multiplicity of espoused theories and practices, one for each individual and/or group encountered.

As Barth (1977) notes, a major problem is that teachers are role players; they behave in a way more or less consonant with another person's expectations of them. The distinction is between role and roles. Roles, in the plural, are counterproductive. It is less necessary, in playing roles, for teachers to be fully aware of their own beliefs and philosophies. It is also less likely that teachers will respond to learners in manners which provide individuals with that unique set of conditions under which they can learn best and most.

The main factor in this characteristic is displaying emotions rationally and honestly while acting on the structure of consistency between the espoused belief and the actual practice. This rational and honest approach to personal emotions requires an attitude which is not immutable in terms of growth and change. Increased effectiveness requires the teacher to reflect upon behavior, as indicated by Argyris and Schön, in order to bring about the required consistency between belief and practice.

The establishment of good human relationships is not the sole or main goal of the teacher's behavior. The relationships established must serve as a foundation to achieve the educational



goals of the curriculum. The relationship is a means by which the teacher through consistent behavior facilitates the learning process. In this sense the person becomes the foundation characteristic in the Barth model.

### **The Knower**

In this aspect of the model the teacher is confronted with the theoretical basis for imparting knowledge and the "knowns" to be imparted. This process-content distinction requires that the teacher recognize that he or she is interlocked with the student in achieving the desired educational goals. Both the teacher and the student use the process. The former to impart what is known and the latter to develop knowledge and inquiry skills. The basis for imparting the knowns is the process of open access, including those behaviors necessary to operationalize the process. The knowns are those things which make up, in the broadest scope, the realm of technology. The educational goal is to create learners with "discipline" (inquiry skills) (Thelen, 1972) in the search for and the development of technological knowledge.

The Piagetian conceptualization of how a person learns and develops is accepted within the field of industrial arts. Piaget explains that the learner develops a process to expand upon personal knowledge in a meaningful way. Through what is termed adaptation and assimilation the learner proceeds from what he or she knows to expand personal knowledge. The open industrial arts teacher can use the knowledge of this theory to set up technological knowledge in such a manner that the learners can be confronted with situations that allow them to gain new knowledge and insight through personal action.

The teacher's responsibility is twofold in the application of this theory. The teacher must: 1) become a constant explorer and learner in areas of learning theory and technological knowledge in order to develop pertinent classroom experiences, and 2) become an integrator of knowledge, a trans-disciplinarian, one who allows the learner the freedom to explore in areas outside the domain of technology. A case in point would be the development of activities and situations that confront the learner with applying those concepts already assimilated in mathematics, science, the social sciences, language arts, and other areas. This approach uses the knowns as a platform upon which the learner can stand to reach into the realm of the unfamiliar. The personal

security of this platform shows the teacher's respect for the learner's experiences and encourages further activity.

The open model depicts the learner, in the traditional approach to education, as working primarily in the realm of fact while occasionally entering the areas of contested truth and open exploration (Wilson, 1971). Open access would allow the learner to enter from that personal platform of knowledge experience in order to proceed through all the areas of knowledge. No limitation is placed on the exact point of entry. Wilson, in citing the need to expand the curriculum, stresses that the expansion take place in the area of open exploration. This leads to a curriculum that does not restrict itself to the transmission of content; it allows the learner to act upon knowledge through inquiry and reflective action. (Thelen, 1972). This participative inquiry and action means that each individual will be working in different ways at different times. Access to knowledge then comes from all directions. The teacher is one, not the only avenue, for the learner. The teacher must be that kind of person who knows and can accept a position where his or her behavior is such that it allows for the process to be fully actualized.

The allowance of access to knowledge from all directions does not abrogate the teacher's responsibility as a knower. Expanding the opportunities for learners means that the teacher must be aware of and knowledgeable with a multitude of learning alternatives.

### **The Facilitator**

Open education, with its basis on active participation, requires the creation of a situation where all learners are fully involved with activities that incorporate the entire scope of the technological knowledge base. This actualization is made up of interrelated and simultaneous activities on the part of the teacher. Included in these activities are the areas of:

- a) Respect for and encouragement of the learner.
- b) Management of the environment.
- c) Provision of materials.
- d) Direct instruction and consolidation of the learner's experience.

The respect for and encouragement of the learner rests on the ability of the teacher to be that "person" described in the

first characteristic of the open role. A self-confidence on the part of the teacher provides a non-threatening atmosphere in which to foster the learner's personal individuality; it encourages activity and independence.

The classroom methodology leading to individuality avoids grouping by arbitrary means and the homogeneity that results from such grouping. Spontaneous or of-the-moment needs may bring about groups but these groups should not become permanent or dictated; when a group's inquiry is complete there should be no need to sustain its existence as a unit for the sole purpose of administrative ease or convenience. The methodology should encourage the learner to be active as an individual. This individuality should lead to independence for the learner.

If the student learns in his or her own individual way then the teacher should promote an independent approach to problems. This requires a self-examination each time a learner asks for help or even looks like he or she is failing in some activity. The self-interrogation should go somewhat like this: "Is my intervention in this situation really going to help?" "Is the learner really in need of help?" "Am I the best source of help?" "What other sources of help are there?" The examination should lead to allowing the learner to find a personal solution. The types of behavior that can be applied in this portion of the role are evaluative, prescriptive and sanctioning.

Of course there should be a constant concern for the health and safety of the individual in the laboratory. Individual activity should be permeated with responsibility of the safety of oneself and others. This point will be examined below under the topic of the teacher as a manager of learners.

Individuality and independence on the part of the learner can now progress to activities that are meaningful and full of learning potential. The freedom to be leads to self-confident action. Maintaining a place for this action is the next area in being a facilitator of learning.

The industrial arts lab-classroom offers a fertile ground for the independent, active student. It is up to the teacher to arrange the environment in a way to obtain maximum use for maximum activity. Physical plants that are available to the teacher vary to a great degree. They range from the traditionally conceived buildings of the 1920's and 1930's to contemporary structures

planned with the cooperation of educators and architects. Whatever the conditions of the situation are the teacher should look at them from the new direction of the open concept. With this viewpoint and creativity the teacher can provide opportunities for multiple activities in traditionally conceived facilities as well as in newer and more unique arrangements of space and equipment. Resource and reference centers, planning and design areas, areas devoted to the exploration of various material technologies, places to be alone in the pursuit of an idea — all lend themselves to the concept of open education.

We now have a description of the learner and the environment necessary for the learning activity. Within this environment there must be a great deal of material for the learner's use. Open education proponents (Barth, 1974), believe that manipulative materials are a key factor in the learning process. The industrial arts teacher comes with a strong advantage in this area. Manipulative materials are a primary factor in all phases and levels of industrial arts instructional programs. Barth offers some criteria for selecting appropriate materials. It should be noted, in the interest of conservation, that quantity is not as important as variety in providing materials. The criteria are general in nature and need careful consideration by the teacher. The technological knowledge base will influence the final selection of materials. The criteria are:

- 1) Encourage and permit the learners to supply their own materials.
- 2) Allow for exploration outside the lab-classroom and outside the school.
- 3) The best materials are common ones, which are inexpensive, familiar and easily available. (Industrial arts has the responsibility to introduce new materials but one can always start with the familiar.)
- 4) Multiprogrammed materials which suggest a wide number of paths of exploration should be preferred.
- 5) Materials should have a high likelihood of initiating, sustaining, and extending exploration.

Most of the basic materials used in industrial arts meet one or more of these criteria. These criteria not only apply to the hardware; they also apply to the software. The resources and references used along with the wood, plastic, metal, etc. require the same care in their development, preparation, and selection.

Reaching closure within the environment and through the use of the materials is the next part of the facilitator's task. Closure is brought about through the use of language. Helping the learner relate to what has been experienced in terms common to others, so that the experience can be shared, is what the teacher must accomplish. Observing behavior in an environment of activity should pose no problem. The problem is in communicating with the student.

As many teachers have experienced, there have been those instances when a learner has come to them using vague and unfamiliar terms with regard to some material, tool or process. This is the time to start the consolidation of the learner's experiences through the use of common and accepted terminology. In asking for a meaningful response from a learner the teacher must accept the notion that the correct terminology might not be present. The task is to understand the vague or invented terms for what they are and then provide the proper terms. This consolidation of the experience of the learner with the use of the correct terms prepares the way for further study, activity and exploration. The industrial arts student now has a foundation or base for continued meaningful learning.

Interaction in the areas described above brings the student through a cycle of activity. One important element is missing in this cycle. If progress is to continue the learner must move forward and not revolve around a fixed point. There is a time when the learner will not discover the skills or information needed to pursue meaningful activity. This is the instance when the teacher must assume responsibility for direct instruction. Direct instruction falls into the category of representative behavior. To fail to take responsibility at this point can mean curtailing the purposeful activity of the learner.

Another instance, one touched on earlier, that requires direct instruction is when activity and exploration will create a danger to the person, others, or the equipment to be used. No teacher can allow a hazardous activity to take place. This does not mean that the teacher becomes a dogmatic authoritarian. The teacher becomes a person whose knowledge about the activity, the environment, and materials is used in developing the appropriate instructional mode for the activity. This mode will be such that it will draw out the learner and allow for the exploration of the

hazards. This instruction sets the danger before the learner and develops a personal responsibility for safe action.

In the description of the facilitator characteristic, the emphasis has been placed on working with individual learners. Group inquiry and reflective action, as proposed by Thelen, (1972) can also be facilitated by the teacher. As was noted, group work arises from need and not artificially. In pursuing and developing technological knowledge, the teacher should use his or her skills to precipitate group formation. The formed groups can foster the elements of human interaction necessary for functioning in a complex world where inter-human dependency is required for survival and growth.

### **The Teacher as a Manager of Learners**

In this fourth major characteristic the teacher moves away from being a facilitator and becomes a person that provides order, structure, and control which are prerequisites for independent exploration. Here is where authority, constituted as a representation of accumulated experience, knowledge, and insight, becomes essential. The teacher must develop and use insight into the nature of the learner and the learning process in order to develop the student's experience and knowledge. This authority must lead to a shared responsibility on the part of both teacher and student for general classroom behavior so that independent activity can occur. When behavior leads to the destruction of materials and/or equipment or interferes with other learners, the teacher is required to step in to maintain an atmosphere of purposeful activity. The consequences for inappropriate behavior must be set and the intervention of the teacher is necessary. This does not mean that the teacher removes the disruptive learner from the situation and stops with that act. The teacher must also take the responsibility for determining the causes of the behavior in question. Help should be provided to the disruptive learner so that the difficulty can be overcome.

Another factor of the management function is the evaluative one. Some would suggest that evaluation is primarily for the benefit of the learner. The open model practitioner would disagree with this because the teacher also needs to apply self-evaluation for continued personal and professional growth.

Evaluation for the benefit of the learner requires the teacher to provide feedback about the consequences of classroom activity.

The learner's awareness of these consequences and the use of this new knowledge then becomes a factor in the improvement of future learning activity. This approach can also help in describing to the parent or guardian the place where the learner is at and the alternatives available for further growth and development.

The teacher, through self-evaluation, can help to expand upon the facilitator function in this model. A fixed behavior pattern may cause the process of facilitation to break down resulting in a disruption of the activities taking place in the lab-classroom. As was indicative in the Argyris and Schön model, self-scrutiny provides the basis for growth and change. This evaluative activity can also isolate those areas that are impeding ordered class activities, lead to change in personal behavior, and result in the desired effect in continuing the operation of the program.

## **AN INDIVIDUAL TEACHER EFFORT**

At this point it is necessary to extend our examination to focus on how an individual can operationalize upon the constructs of an open teaching role. This example describes the role as it applies to a single teacher effort. This description is based on a review of current middle school philosophy and practice and this writer's experiences with such programs.

The actualization of the open role and practice, like other forms of educational methodology, requires a supportive atmosphere. The degree to which the support is present enhances the potential for the total development and use of the practice. It is not necessary that all the following components of the environment be present. The minimum, however, is that the individual teacher be committed to the concept. The components of such an ideal atmosphere are cooperative colleagues in other areas of the school's program; administrators with a willingness to allow teachers the freedom to make and actualize decisions; the assistance of specialists in counseling services, learning disabilities and other support personnel; and a community which recognizes and encourages the development of competently organized programs in its schools.

### **An Individual Teacher Effort**

At this point it is necessary to briefly describe the teacher's functioning as an individual within the context of the model. As a preface to this it should be noted that there can be more than just this one mode of functioning within the model. To hold true to the model, with respect to the teacher as a person, there should be as many ways as there are individuals. It also goes to say that there can be no static situation because the evaluative process should produce change and growth.

The teacher's classroom behavior and activity must conform to the standards set down as a foundation for open education and the characteristics set forth by Barth. The point of actualization is reached through the process of continued self-evaluation, freedom or liberalized decision making, and commitment to the decided alternative. The vehicle used in this description is creative problem-solving and a systems analysis of the classroom process with regard to implementing individual activity in achieving industrial arts objectives.

One would certainly recognize the classes taught under this mode of behavior as part of an industrial arts program. There are units in orientation and safety, design and communication, woods, plastics, metals, graphic arts, and quantity production. The activity takes place in what can be conceived of as a typical lab with its equipment, storage areas, and instructional materials.

The units are part of the school system's total industrial arts program. They reflect in their content the exploratory areas that lead to other activities in the high school and the area career center. They set limits on the domain of technical knowledge. The lab sets a physical constraint on space and equipment.

In the function of the knower and within the learning process, the student is allowed to approach knowledge in an individualized and active way. The first step in achieving this is the development and use of instructional materials that actively involved the learner in recognizing and utilizing a process to approach technological knowledge and problems. The methodology of the technique is to give the learner a problem that uses their previous experiences (Levande, 1975). This problem also introduces a process that can work for them in all the unit areas.

The result is a group of problems which incorporated the use of familiar materials (string, scrap paper, drinking straws, rubber cement, etc.) and tools (rulers, scissors, needles, etc.). For example, one problem was to design a device that would



span a 15 cm space and support 2500 gm of weight. Materials use is restricted to four sheets of 21.5 cm x 28 cm scrap paper and rubber cement adhesive. The tools are rulers and scissors. Criteria for a successful solution requires that the device does not crumble, tumble or drop the weight. The learners are asked to follow a set of steps which are given to them; these steps follow a logical sequence from defining the problem to evaluating the solution.

This instructional situation sets the stage for the facilitator and manager functions to emerge and it exposes the teacher's behavior and norms for the industrial arts program. Respect of and encouragement for the learner are present in that learners are asked to be creative, original, and independent in their solutions while using past and familiar experiences. The environment and materials are provided. The experience is consolidated in terms of the language used to describe the process of solving the problem and to describe what is occurring during the activities of designing, construction, and testing. Direct instruction (descriptive behavior) is provided in how to effectively use the rubber cement. Testing or evaluation is performed under the authority of the teacher. A final evaluation is provided in the form of feedback about how the process was used and the success of the device's functioning.

In microcosm this exercise reflects the activity that occurs in all units of instruction throughout the program. The materials for the other units incorporate the same problem solving process. The facilitator and manager functions expand to introduce new activities and materials while the learner progresses at an individual pace. Direct instruction is provided as learners reach the point of needing new information; this instruction also provides a motivational device for those who are progressing at a slower pace.

The systematic approach to the entire process provides a familiar ground for the learner's activity in all areas of the program. In fact it is useful to analyze the entire program in terms of operations and systems concepts. The flow chart in Fig. 7-1 presents such an analysis; this depicts the learner's activity when involved in the process in all the units with the exception of quantity production. The quantity production unit is oriented toward a group activity and limits the individual in using the whole process.

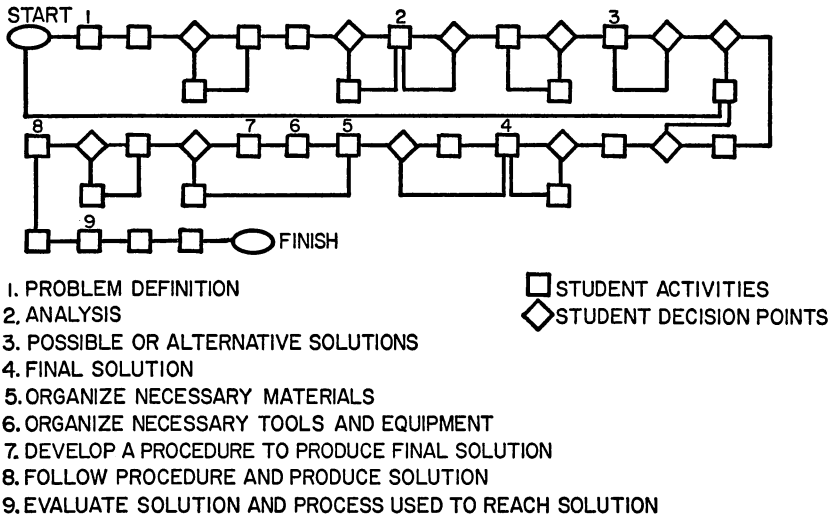

**Fig. 7-1. Flow Chart: Student Problem Solving Process.**

The cycle in the diagram repeats itself during the entire instructional term. Learners progress from one unit to the next at their own paces. Check points are built into the cycle to allow the teacher to evaluate progress, provide feedback and instruction, and consolidate the experience.

As a manager of learners it is also necessary to be accountable to their parents. In this situation the format adopted by some school systems aids in the process and enhances the open concept. Computer assisted reporting is used to tell parents about performance and behavior.

In industrial arts, as in the other areas of the curriculum, there is a bank of descriptive narrative statements related to the unit areas and other topics. In addition to the unit areas mentioned earlier there are statements on: planning and problem solving; written communication; pictorial communication; computation and measurement; careers; safety; learning skills and habits; and personal-social skills and habits. In some systems there is a potential for as many as one thousand lines of print out.

If this system of reporting is applied in the same manner that traditional letter grading systems are used, the teacher

would not be able to function. Record keeping and reporting become a continuous process throughout the term. The teacher and the student mark the appropriate statements as activities are completed in this system. Expectations and standards in the reports are printed out and distributed on a nine week cycle. This situation allows the evaluation to be a learning experience which benefits the learner and helps to set goals for the next round of activity. Figure 7-2 is an example of a report from such a system.

In summing up this description it is necessary to reinforce the notion that one must utilize as much of pedagogical and technical knowledge as can be obtained, work to facilitate learning, and be a manager of learners within the school setting in actualizing the open classroom. But, most of all, the teacher must be a person, as described in the first characteristic of the model.

### **Cross Discipline Approach**

Another avenue open to the industrial arts teacher is that of working with the concepts developed in other areas of the curriculum. In this kind of structure the central focus is on learner needs. Attention is given to problem-solving across disciplines or subject matter areas. This type of activity requires an environment which contains those elements that are beyond the scope of the individual practitioner's immediate sphere of influence, especially with respect to the cooperativeness of colleagues and administrators. A mutual effort can be the only means to success in this approach.

The needs identification of the learner produces two paths or alternatives for the teacher. The problem-solving and inquiry can center on individual need or group need.

In the case of the person's individual desire to produce a product or service that can fulfill a personal want the inquiry is directed to accomplish that goal. Examples of this type of need and problem identification may produce common items to keep personal belongings in order, hobby equipment for leisure time use, or gifts to commemorate special events such as parental anniversaries, holidays, or sibling birthdays.

Group needs produce another type of result. Student groups often find it necessary to publicize events or present information to other students or the greater community. Fund raising activities fall into this area. Sponsoring special projects such as chari-

STUDENT NAME

TEAM 71 HOMEROOM

REPORTING PERIOD

09/04/75 TO 11/07/75

SUBJECT-INDUSTRIAL ARTS  
TEACHER-A. PEDAGOGG

ACADEMIC ACHIEVEMENT IN INDUSTRIAL ARTS

YOUR CHILD HAS MET ALL OF THE OBJECTIVES SET FOR  
HIM OR HER FOR THIS REPORTING PERIOD

HAS DEMONSTRATED KNOWLEDGE OF AN OUTLINE OF GENERAL STEPS  
FOR PROBLEM SOLVING THAT INCORPORATES SKILLS, IDEAS,  
MATERIALS, TOOLS AND MACHINES AS RESOURCES

HAS SUCCESSFULLY COMPLETED WORK WITHIN THE AREAS COVERED  
IN THE WOODS UNIT

HAS ATTAINED A PASSING SCORE ON A TEST OF GENERAL LAB  
SAFETY RULES

HAS ATTAINED A PASSING SCORE ON TESTS OF SAFETY RULES  
FOR THE MACHINES AND EQUIPMENT COVERED DURING THIS  
EVALUATION PERIOD

OTHER COMMENTS IN INDUSTRIAL ARTS

EFFORT IS CONSISTENT IN CLASS

HAS A POSITIVE ATTITUDE TOWARD CLASS WORK  
WORKS CAREFULLY AND METHODICALLY

Fig. 7-2. Sample Computer Assisted Report.

table fund drives, in-school development for special equipment or field trips can utilize the technological knowledge base for group inquiry and reflective action. Examples of this can be found in posters, circulars, tickets and programs developed and printed in industrial arts. Line production of items to generate revenue for the desired goal are also part of this area of activity.

A social consciousness and self worth component are present in the cross discipline approach. Educators, especially proponents of the middle school concept, see these activities as providing this type of intrinsic value. Egnatuk *et al* (1975) indicates that middle school adolescents require activities that allow them to demonstrate their abilities to provide products and services that can be valued by others. In providing such a product or service through industrial arts activities, the individual is able to develop confidence to achieve a greater degree of development through the reward of seeing friends, family and/or the community obtaining benefits from this personal involvement. The goal is the development of social consciousness with the added factor of the contributions made by technology to this effort. The examples noted earlier under community service are some tested means to foster this consciousness and self worth.

As a facilitator and manager, the teaching role requires behavior which precipitates learner action along paths that take them to other people — teachers, family and community members. Colleague communication and mutual agreement on goals are necessary parts of the mode of operation. In many cases, the industrial arts teacher must reduce descriptive behavior in his or her role and, as a knowledgeable person, direct the learner to other persons who have the resources required by the learner. This approach is jeopardized, as noted by Suess (1972), when industrial arts teachers hold to autonomous and independent roles in articulation across the curriculum. The characteristic of being a secure person is a vital part of implementing this behavior and removing barriers that prevent activities that cross subject matter lines.

A typical case of cross discipline problem-solving arises when a student recognizes a need to create a gift for an upcoming holiday or family event. Through discussion with family members and teachers, the student might settle on the development and production of a device to serve food. After this problem

definition phase, the student works with teachers in home economics and science to explore the feed items served in nutritious meals and the chemical reactions of various foods on materials used to serve foods. The student might then determine that some form of plastic spatula would fit the current need. Through further research, the student discovers that the amounts of plastics are limited leading to opportunities in social studies for the exploration of relationships about the reliance of the petrochemical industry on crude oil for plastics production, world resources, and international political forces. In designing and constructing the product, the student would be able to work with the art, math and industrial arts teachers; in knowledge areas such as design principles and elements; use math skills in measurement, notation and calibration; and apply material and tool technology. The resultant product is then assessed on its ability to function, the adequacy of the process used to produce it and the reaction of family and friends to its usefulness and appearance.

## SUMMARY

In closing it must be noted that the teacher is at a focal point in the open curriculum structure. The actions of community members, administrators and colleagues are channeled through this focal point. The industrial arts teacher must make a conscious decision to be placed at this point. This decision leads to other decision making in the areas of program development, implementation, management and evaluation. The focal point becomes a passive channel if the teacher does not take an active part in the entire process. Advocacy of the philosophy and position of industrial arts in the open school is required in all phases of the process of curriculum building. In implementing and managing the curriculum the teacher must continue to speak out on the issues that affect industrial arts.

The teacher does not stand in this position without the support of the other people who are working in the process. One works with those same people who helped to make the decision to operate an open school. This support requires an atmosphere which fosters open communication . . . communication where ideas are judged on their merit . . . communication where information flows freely so that a teacher can make an informed

choice and act responsibly on that choice. By developing and supporting such an atmosphere each person builds a foundation for effective open evaluation, evaluation that allows the curriculum to change and grow.

In the industrial arts classroom that is part of the open school the teacher continues in an active manner. Here the effort is channeled at providing the student with all the possibilities available in the entire school's curriculum. This activity is based on informed decision making; it revolves around the idea that the teacher is a person who establishes good human relationships with students, colleagues, administrators, parents and community members. Using these established relationships the teacher operates on a knowledge base that includes learner characteristics, technology and educational practice to facilitate an active participation on the part of the students. Once this participation is established the teacher manages the students and physical facility in order to continue purposeful activity for each child.

Barth (1977) has indicated that open education, in general, has had the effect of expanding and extending the scope of instructional ideas, materials and methods used by teachers. The industrial arts teacher, by deciding to become a focal point in the open middle school curriculum, brings this diversity and expansion into the classroom. By extending and expanding the realm of industrial arts for the middle school student the teacher helps in meeting the ever-expanding demands and complexities of the 21st century.

## REFERENCES

- Argyris, C. and Schön, D. A. *Theory in Practice: Increasing Professional Effectiveness*. San Francisco: Jossey-Bass, 1976.
- Barth, R. S. *Open Education and the American School*. New York: Schocken Books, 1974.
- Barth, R. S. "Beyond Open Education." *Phi Delta Kappan*, Vol. 58, No. 6, February 1977, pp. 489-492.
- Biddle, B. J. and Thomas, E. J. *Role Theory: Concepts and Research*. New York: John Wiley and Sons, 1966.
- Blom, F. S., Gerald, G. K. and Kinsinger, A. *A Middle School Belief System*. East Lansing, Mich.: Michigan Association of Middle School Educators, 1974.
- Egnatuck, T. and others. *The Middle School*. East Lansing, Mich.: Michigan Association of Middle School Educators, 1975.
- Federal Register*, Vol. 42, No. 113 — June 13, 1977, pp. 30290-30293.
- Holt, J. C. *How Children Fail*. New York: Pittman, 1966.
- Holt, J. C. *How Children Learn*. New York: Pittman, 1967.
- Holt, J. C. *The Underachieving School*. New York: Pittman, 1969.
- Householder, D. (ed.). *Industrial Arts for the Early Adolescent*. 21st Yearbook of the American Council on Industrial Arts Teacher Education. Bloomington, Ill.: McKnight, 1972.
- Levande, J. S. "Initial IA Problems: Simulations for Actualizing Individualized Instruction." *Man/Society/Technology*, Vol. 35, No. 2, November 1975, pp. 42-43.
- Silberman, C. E. *Crisis in the Classroom*. New York: Random House, 1970.
- Silberman, C. E. *The Open Classroom Reader*. New York: Vintage Books, 1973.
- Suess, A. R. "The Industrial Arts Curriculum for the Early Adolescent." In D. Householder (Ed.). *Industrial Arts for the Early Adolescent*. 21st Yearbook of the American Council on Industrial Arts Teacher Education. Bloomington, Ill.: McKnight, 1972.
- Thelen, H. A. *Education and the Human Quest*. Chicago: University of Chicago Press, 1972.
- Wilson, L. C. *The Open Access Curriculum*. Boston: Allyn and Bacon, 1971.





*Dr. William H. McPherson*



Dr. McPherson has taught industrial arts at the elementary, middle school, junior high, high school and university levels. He is currently an associate professor in the Industrial Education Department at Iowa State University, Ames, Iowa. His responsibilities at Iowa include undergraduate and graduate level teaching in the areas of: the introduction to industrial arts education, materials and processes, student teacher supervision and the history and philosophy of industrial arts education.

Dr. McPherson received his Bachelor of Science degree from Central Connecticut State College, his Master of Arts degree from Teachers College, Columbia University and the Doctor of Education degree from the University of Maryland.

In recent years he taught at the Swetman Learning Center (The State University of Oswego campus school) in the area of elementary industrial arts. The campus school serves three hundred children from grades K-6 and an industrial arts teacher education department with over eight hundred students. Dr. McPherson's interest in history, methods, career education and safety is evidenced by a number of articles and/or publications in these areas.

Presently, Dr. McPherson is working on a chapter for the 28th ACIATE yearbook. The chapter will deal with the accomplishments of deceased leaders in the field of industrial arts education.

# Humanism in American Education: A Historical Overview

*William H. McPherson*

## INTRODUCTION

The development of humanism in the United States had its beginning in Europe with the work of such men as Jean Jacques Rousseau, Johann Pestalozzi, and Friedrich Froebel. Their belief in the dignity of man and the needs of children led to a *new* educational philosophy.

This new educational philosophy, a more humanistic philosophy, developed the Progressive Education Movement in America. Leaders within this new movement were men like Francis W. Parker, John Dewey, William H. Kilpatrick, James E. Russell, and Frederick G. Bonser. Many persons formulated the foundation for this *new* educational philosophy. Some are: Parker's "Quincy System" (Parker is considered by some to be the "Father" of Progressive Education); Dewey's "Psychology of Occupations" along with his many books and articles; Kilpatrick's "Project Method" and the "Industrial Social Theory" by Russell and Bonser.

Along with understanding the contributions that these men made, one must also consider the importance of Teachers College, Columbia University and the experimental schools of Teachers College, in particular the Speyer School.

Herein lies the foundation of humanism in the United States and the role that industrial arts education played in this *new* education.

### The European Influence

No thought or concept is born in a vacuum. Humanism in American education was influenced and cultivated by the writings of many European educators and philosophers. At the root of modern progressivism — the birth of humanism in American education — were men like Jean Jacques Rousseau (Goodlad, 1975, p. 90), Johann Pestalozzi, and Friedrich Froebel. One must understand their *new* vision of the role of the child and the nature of man in a *new* educational framework.

*Jean Jacques Rousseau (1792-1778)*. A philosopher-educator and political spirit of the French Revolution, Jean Jacques Rousseau established the groundwork for Progressive Education. Rousseau's belief in the natural goodness of man and his encouragement of children to develop and express their own natural impulses would establish Rousseau as the creator of the "child-centered school" (Brameld, 1955, p. 126), a concept which is the cornerstone of an open access curriculum. Another "modern" concept advocated by Rousseau was that of self-actualization of the individual in as smooth and natural a transformation as possible (Goodlad, 1975, p. 91). A further humanistic view of Rousseau can be seen in his insistence that children should be treated as children and that educators must recognize childhood as a vital part of the maturing process, through which children must be allowed to progress. Although Rousseau provides many insights into the development stages of the life of children, he reminds educators to know their pupils and to center education around man; man capable of self-direction (Brameld, 1955, p. 126).

*Johann Pestalozzi (1746-1827)*. A Swiss reformer of education in the late 18th century, Johann Pestalozzi was to develop further the ideas and revelations of Rousseau. Pestalozzi's love for children as *children* can be seen throughout his works. Insight into Pestalozzi's personality and character was best expressed by Messenger (1931) when he wrote:

If the term humanistic could be used to mean filled with human sympathy, having interest in human beings, and willing to serve human needs, then Pestalozzi would be a great humanist . . . There is no good word to describe Pestalozzi. Humanitarian approaches the meaning . . . (p. 185).

An important part of Pestalozzi's educational philosophy is that the child should be an active member in the educational process rather than passive. He rejected rote memory work, a dominant educational practice in the 18th century. To Pestalozzi, concrete situations for the child were paramount to learning. What a child sees in directed "self-activity" he will remember much more vividly than what he only hears (Mayer, 1960, p. 267). Pestalozzi's belief in a child-centered activity approach to education and in children engaging in activities that would help them grow naturally into adulthood also stressed the importance of having a workshop for the crafts, fields for agriculture and a complete home so that children could be trained in the "crafts" of home and family life (Anderson, 1926, p. 89).

*Friedrich Froebel (1782-1852).* Pestalozzi's disciple was Friedrich Froebel, who studied under him. From the writings of Comenius and his own work with Pestalozzi, Froebel developed his educational philosophy. His most remembered contribution to education is what he called, "kleinkinderbeschäftigungsanstalt," an institution for the occupation of little children (Meyer, 1939, p. 24). This word was later shortened to the contemporary term "kindergarten."

Froebel insisted, as did Comenius and Rousseau, in the right of children to free expression. Freedom and creativity were two key concepts in Froebel's philosophy. Froebel believed that man — children — were naturally creative. Hence, the good teacher was to be a guide, not a commander, and a threat to natural creativity. Froebel was one of the first to be concerned with the involvement of activities in educational methodology. Credit for the now famous 20th century progressive education statement: "We learn best by doing . . ." must go to Froebel (Messenger, 1931, p. 206). Froebel's methodology centered around play experiences, for through play, the child developed patterns of socialization and could express his inner self or nature. Froebel concluded that play ". . . gives, therefore, joy, freedom, contentment, inner and outer rest, and peace with the world. It holds the source of all that is good" (Froebel, trans. 1896, p. 55). Another humanistic concern of Froebel was that for education to be effective he felt that it should be founded around the needs of children (Mayer, 1960, p. 283).

The ideas and philosophies of these three educators may seem commonplace and are taken for granted by many today. Yet, at the times when these concepts were fostered they were as revolutionary as any "new" educational concept of the last twenty years. These great European educators of the 18th and 19th centuries have laid the foundation for humanism in 20th century education as well as the beginnings of Progressive Education in the United States at the turn of the century.

### **Humanism and the Development of Progressive Education in America**

(Even though John Dewey is considered the most influential educator of the 20th century, one would be remiss not to include Francis W. Parker in a discussion of progressive education in this country.)

*Francis W. Parker (1837-1902).* Francis Wayland Parker has been given many titles. He was referred to as "The American Comenius" (Dangler, 1943, p. 19) and the "Father of the Activity Movement" (Dangler, 1942, p. 370); Dewey called him a pioneer for a new educational philosophy. We see in Parker a man truly dedicated to a more humane treatment of "little folks" (Parker, 1902, p. 240). For Parker the humane treatment of children must be brought about in the schools. Parker saw the school as an institution that would preserve democracy in this country, and he felt that "democracy without efficient common schools is impossible" (Parker, 1937, p. 341). Colonel Parker went so far as to imply that the destiny of the country was in the hands of the teacher and the school.

Parker had great faith in children and believed in their essential goodness as individuals. Parker stated:

There never was a bad child. There are bad homes, bad habits; twists, due to poor heredity and environment, but what every child needs is to be understood — to have the security which affection gives — to have a friend (Cooke, 1937, p. 588).

One can see from this statement the influence that Rousseau and others had upon Parker. Parker was in the middle of an educational revolution, a revolution begun by Rousseau, Pestalozzi, Froebel and others, that emphasized a shift of educational philosophy from a subject-centered to a child-centered approach. One can see in Parker's educational philosophy that the center of all learning should revolve around the child (Dangler, 1942, p.

370). Parker also saw the child taking an active part in the learning process rather than a passive one: "We learn to do by doing, to hear by hearing, and to think by thinking" (Parker, 1883, p. 155).

Francis W. Parker carried out his educational ideas at Quincy, Massachusetts; his ideas were promoted as the "Quincy System" and/or the "Quincy Method." Parker denied that any such "system" or "method" existed. Despite his denial Parker's educational "spirit" became well known, as did Parker himself. Parker ended his educational career as the principal of the Chicago Institute, which became the School of Education at the University of Chicago a year before his death. With the mention of the University of Chicago the discussion will proceed with the man whom many consider to be the most influential educator of the 20th century, John Dewey.

*John Dewey (1859-1952).* John Dewey's influence upon the educational community can be said to have started with his appointment to the University of Chicago in 1894. Dewey's work at Chicago lasted until 1904 when he left for Columbia University (Archambault, 1966, p. xxi). While at the University of Chicago Dewey founded the "Laboratory School;" Dewey used the lab school to emphasize the practical aspects of his educational theory. This discussion will also note the importance that Dewey placed on manual training; (today Dewey would call this Industrial Arts Education). For Dewey, manual training symbolized the merging of the theoretical and the practical; it gave Dewey the opportunity to translate the intellectual understandings into practical hands-on activities (Archambault, 1966, p. xxv).

There have been hundreds of books written about Dewey's influence upon American education. It is not the intent of this discussion to summarize these works but to discuss the importance of John Dewey to industrial arts educators and to the humanistic movement of the 20th century. Dewey's major contribution to the field is found in his "Theory of Occupations," which was first published in *The Elementary School Record* in 1900. This article was later published in a revised edition of *School and Society* in 1915. In Dewey's "Psychology of Occupations," which became known as his "Theory of Occupations," he defined the term "occupations" as:

By occupation I mean a mode of activity on the part of the child which reproduces, or runs parallel to, some form of work carried on in social life (Dewey, 1915, p. 131).

This definition had the characteristic of not being obsolete. As the "work carried on in social life" changed with time, the school would therefore have to develop new modes of activities to represent the new work "carried on in social life." One of Dewey's main themes in this educational reform — that of socializing education — was also brought out in the definition. Dewey's "social" education was to bring about coordination between the individual and society. Dewey's new approach to education was to be accomplished by redesigning the school to be a form of "community-life" (Wirth, 1966, p. 125). Dewey wanted to redesign the traditional school because he felt that the greatest waste in schools of the 19th century was the lack of relating subject matter to everyday experiences and, in turn, relating daily experiences to the school (Dewey, 1915, p. 67).

The isolation that Dewey saw in the schools could be broken down in two ways — first, by using all the experiences the child brings to school; and second, by giving the child experiences he could use in everyday life. Dewey did not interpret "social" only in the sense of "social development" or "social adjustment" of the child. Arthur Wirth interpreted Dewey's social adjustment theory by stating that:

A common interpretation is that Dewey meant social only in the sense of "social adjustment" to the group, or to contemporary social realities. This is false. It must be remembered that one of his uses of "social" referred to the products and processes of human inquiry as represented in scholarship, science, and school subject matter (1966, p. 124).

Along with "occupations" as a vital part of his curriculum, Dewey incorporated the areas of communication and expression, social studies and science to further enhance and broaden the study of the occupations (Wirth, 1966, p. 126).

Dewey's theory of occupations contained possibilities to integrate intellectual and practical experiences — one of the fundamental concepts of industrial arts education. Dewey, very much aware of the presence of manual training and vocational education, made an important distinction at this point. The study of "occupations" was not to be interpreted as a form of vocational training. Dewey wrote:



Occupation as thus conceived must, therefore, be carefully distinguished from work which educates primarily for a trade. It differs because its end is in itself; in the growth that comes from continual interplay of ideas and their embodiment in action, not in external utility (1900, p. 82).

To show the difference between manual training and the "occupations," Dewey criticized manual training for stressing the mastery of "certain tools" and "certain objects" as the primary end of an educational philosophy. Dewey continued to attack the manual training movement for its tendency to develop skills through "mere habit, routine, or custom" which was unconscious and mechanical; "occupations," however, stressed putting "the maximum of consciousness into whatever is done" (Dewey, 1900, p. 83).

Dewey stated that by occupation he did not mean to advocate a form of educational "busy work" (Dewey, 1900, p. 82). Wirth said that Dewey's concept of the "occupations" experienced considerable opposition. A common misinterpretation of "occupations" was that it was "busy work" or a form of manual or vocational training. Wirth argued that:

he (Dewey) had no interest in the occupations as busy work, nor was he interested in training children to be chefs, seamstresses, or carpenters (1966, p. 131).

The activities or forms of practice that Dewey advocated were not to be ends in themselves. The following statement is highly significant to industrial arts educators:

In other words, the object of these forms of practice in the school is not found chiefly in themselves, or in the technical skill of cooks, seamstresses, carpenters, and masons, but in their connection, on the social side, with the life without; while on the individual side they respond to the child's need for action, of expression, or desire to do something, to be constructive and creative, instead of simply passive and conforming (Dewey, 1915, p. 72).

One can see in Dewey's statement a fundamental concept of industrial arts education as it is found in general education. A concept that gives the field meaning and value as part of an educational system. And, more important, it distinguishes industrial arts education from vocational education. As Dewey pointed out, the "occupations" were a means to an end — an end that would bring about the socialization of the child. The child would respond with his natural instincts and interests and learn to be

part of society — part of the world outside the classroom. Experiences outside the school were inherent in his definition of “occupations.” These experiences included activities that were familiar to children and common to the home and the surrounding environment. The use of the “occupations” offered Dewey still another educational concept with which to work. This concept was the place that *interest* played in school work. Dewey did not leave to chance the *interest* that students possess and recognized that students have all kinds of interests, good and bad. Taking this into account, Dewey selected activities which were: (1) of interest to all children, and (2) possessed educational value. The second of these has been overlooked by many of Dewey’s critics. Wirth explained that these activities:

should be basic, that is those that provide for fundamental needs such as food, clothing, or shelter, such activities are genuine and timeless. Their reality excites the interest of the child and enlists his efforts, for they are what his elders do, have done, and must continue to do (1966, p. 131).

The activities selected, along with being “basic,” were to provide ways for using four natural instincts of the child: (1) the constructive, which employed simple physical coordination and developed “into the use of tools and technical skills;” (2) the investigative and experimental; (3) the social, which provided a means for the child “to share and communicate his experiences;” (4) the expressive, “which is related to the others, but requires adequate material for outlets” (Wirth, 1966, p. 132).

Dewey’s interpretation of how the areas within the curriculum should be used, studied and taught was seen as quite different from the traditional approach of that time. For Dewey, *content* of what was taught was to center around the “content of social life” in which the child found himself, and *method*, simply, the “capacities of the child” (Archambault, 1966, p. xxvii). Archambault further explains *method* “as the means by which the child actively experienced this content by merging impulse and desire with the problems that social life set forth” (1966, p. xxvii). Dewey continually related subject matter or integrated it, not only with other disciplines but also with relations found in the outside world:

relations with the outside world are found in the carpentry and textile shops. They connect with the country, as the source of their materials,

with physics, as the science of applying energy, with commerce and distribution, with art in the development of architecture and decoration (Dewey, 1915, p. 75).

Dewey saw no problem in relating subject matter — simply; “Relate the school to life and all studies are of necessity correlated” (Dewey, 1915, p. 81). John Dewey had many contemporaries and followers; the most important of these was William H. Kilpatrick, close friend, faculty colleague, and a disciple of Dewey.

*William H. Kilpatrick.* William H. Kilpatrick joined the faculty of Teachers College, Columbia University in 1913 and became the interpreter of the Dewey philosophy. Kilpatrick was one of the most popular and controversial professors at Teachers College. He became known for his “Project Method,” a form of teaching method in the field of education. In 1918, Dr. Kilpatrick published an article “The Project Method — The Use of the Purposeful Art in the Educative Process” (Kilpatrick, 1918).

Since industrial arts educators center methodology around the “project,” Kilpatrick’s article is very significant and yet unknown to many in the profession. Professor Kilpatrick began his article with a discussion of the word “project.” He suggested that the word “project” must pass the test of two questions. The first was whether there was a desire and/or need for such a term that would give appreciable service to educational thinking. The second question asked whether the term project fitly designated the waiting concept (Kilpatrick, 1918, p. 3). Kilpatrick went on to declare that the name of the concept was unimportant in comparison to the concept itself, his discussion would deal with the first of these two questions. Kilpatrick felt that some other term could be used, such as “purposeful act,” for this concept. For Kilpatrick this new educational concept must emphasize *action*, “preferably wholehearted vigorous activity” (Kilpatrick, 1918, p. 3). He concluded that the term to be found would be a concept engulfed in purposeful activity taking place in a social environment. Kilpatrick then went on to define the term “project:” “it is to this purposeful act with the emphasis on the word purpose that I myself apply the term ‘project’ ” (Kilpatrick, 1918, p. 4).

Professor Kilpatrick acknowledged that he neither invented nor introduced the term to the educational community. He did, however, acknowledge that he had given the term a new meaning.

If, as a synonym to Kilpatrick's "project," the phrase "heartily purposeful act" was used, the new term would take on a more meaningful concept. Kilpatrick tied this term "project" into life. If the purposeful act were a typical unit of the worthy life in a democratic society, this purposeful act should then be made the typical unit of the school. If this were done, the goal that education should be life itself and not mere preparation for later living would be accomplished. If this format were followed, education would indeed become life. This latter concept was one of Dewey's and other progressive educators' main concerns.

With the work of Parker, Dewey, Kilpatrick and others the Progressive Education Movement in the United States was well on its way. In the midst of this "new" education, Industrial Arts Education was "born." The birth of Industrial Arts Education was achieved by the work of James E. Russell and Frederick Gordon Bonser. Before discussing their major work (which became to be known as the Industrial Social Theory), it is important to look at the influence that Teachers College, Columbia University had on American education and industrial arts education. It can be said that Teachers College was the birthplace of industrial arts education.

*Teachers College, Columbia University.* Like a great idea or new educational philosophy, an institution has a background, a history, events and people that influenced its beginning and structure. So does Teachers College, and it is important to understand the background of this most influential educational institution of higher learning.

The founding of Teachers College, Columbia University, was based on the need for an institution to train teachers in the area of industrial education (Cremin, Shannon and Townsend, 1954, pp. 10-18). Two associations played an important part in the development of Teachers College. These two associations were the Kitchen Garden Association and the Industrial Education Association, incorporated in 1880 and 1884 respectively (Cremin, Shannon and Townsend, 1954, p. 13). The latter was the outgrowth of the former. From 1884 to 1886 industrial education grew rapidly; the Industrial Education Association's annual budget in a four-year period grew from two thousand to over thirty-eight thousand dollars! In 1886, with the help of Miss Grace H. Dodge, the Industrial Education Association was to take on new

responsibilities. At a time when industrial education was getting much publicity the Association was forced to focus its attention upon the training of teachers. In order to undertake this new task a reorganization of the Association was necessary. Both Alexander Webb, the president, and Miss Dodge, vice president, stepped down; the running of the Association was put in the hands of a Board of Trustees. "Ten Articles of Faith" were drawn up by the trustees to state the Association's principles and aims and "to guard its work from 'degenerating into a manual training school'" (Cremin, Shannon and Townsend, 1954, p. 17). One of the aims as stated in the "Ten Articles of Faith" stressed the importance of industrial training combined with general education (Cremin, Shannon and Townsend, 1954, p. 17).

It is no coincidence that this "Article of Faith" expressed one of the fundamental concepts or principles of industrial arts education; that is, *industrial arts is a vital part of general education*.

As the newly elected president of the Association, Nicholas M. Butler organized the "New York College for the Training of Teachers" (Cremin, Shannon and Townsend, 1954, p. 18). One year after Dr. Butler's resignation from the Association in 1892, the college was granted its permanent charter and the name was changed to Teachers College. In 1894, Teachers College moved to West 120th Street, New York City, its present location.

The leadership of Teachers College was put in the able hands of James E. Russell for almost thirty years, starting in 1897. The men and women that he brought to Teachers College and the influence that this institution had on education at the beginning of this century are a tribute to his great leadership abilities.

*James Earl Russell.* In 1897 James E. Russell was appointed head of the Department of Psychology and General Method at Teachers College. That same year he was elected Dean of the institution. During Russell's years at Teachers College the growth of the institution was rapid. In 1900 Teachers College listed 593 undergraduate students; in 1915 it had 1999 students. In 1902 it had 83 graduate students, and in 1915 there were 619 graduate students (Russell, 1919, p. 8). When comparing Teachers College to other universities with graduate students in education, Russell wrote in one of the annual reports:

figures disclose the remarkable fact that Teachers College alone has during the academic year (1915-16) more matriculated graduate students in education than all other prominent universities in the United States and Canada combined (1919, p. 24).

To many industrial arts teachers, James E. Russell, along with Frederick Bonser, is known for "The Russell-Bonser Plan" or "The Industrial Social Theory." These terms first appear in David Snedden and William Warner's book, *Reconstruction of Industrial Arts Courses* (Snedden and Warner, 1927, p. 7). A discussion of the Industrial Social Theory will take place later in this article.

In searching through James E. Russell's papers at Teachers College, some interesting correspondence between William T. Bawden, then managing editor of the *Manual Training and Vocational Education Magazine*, and Dean Russell (Letter/Bawden to Russell, 1915) was found. In a letter dated December 2, 1915, Dr. Bawden asked if Dean Russell would make a statement about future changes at Teachers College which would be of interest to the magazine's readers. What a statement it was! On December 15, 1915 Dr. Russell replied with the assertion that, due to the new emphasis in vocational education on skills and shop work as well as the ability to teach:

We do not have the equipment, nor is it in accord with our plans, to specialize in the training of classroom teachers in this field. Consequently, we have decided to abandon all shop work of a highly technical or vocational character. In future our rooms, equipment, and endowment will be devoted to the strengthening of our work in industrial arts for elementary and junior high school (Letter/Russell to Bawden, 1915).

It seems apparent from this correspondence that at this point in history the leader of *the* institution of higher education founded to train teachers in the field of industrial education establishes the break between vocational education and industrial arts education. In doing so, Russell sets the stage for the formulation of the development of industrial arts education as conceived by himself, Frederick Bonser, John Dewey, Lois Mossman, William H. Kilpatrick and others. At the same time Russell places industrial arts education right in the center of the Progressive Education Movement in the United States "as a more humanistic education, child centered, and activity oriented." Now let us look at the work and contributions of Frederick G. Bonser to the further development of our profession.

At this point a short summary might be helpful to the reader before going further. The Progressive Education Movement in the United States had its beginnings with such European educators as Pestalozzi, Froebel and Rousseau. The philosophies and ideas of these men were studied abroad and brought back to the United States by Francis Parker and others. Francis Parker was one of the first American educators to experiment with the "new" education. His work at Quincy, Massachusetts and the Cook County Normal School in Illinois attest to this fact.

The supporters of the "new" approach to education were critical of the traditional approach to education. The advocates of the "new" education recommended an activity-oriented curriculum, an understanding of the nature of the child, an understanding of the learning process, and the necessity of using children's interests to help carry on the learning process. The focus of the "new" education was that of a humane child-centered approach to education.

The work of John Dewey and Edward L. Thorndike promoted the "new" education from the philosophical and psychological aspects of education. Dewey's "Psychology of Occupations" was the basis for carrying out the "new" education within the classroom. Dewey incorporated the child-centered concepts of earlier educators into the theory of occupations. Edward L. Thorndike's work in the area of learning theory was to form the basis for the science of learning for many years to come.

The work of other educators, such as Kilpatrick, Russell and Bonser, further promoted the Progressive Education Movement in the United States. William H. Kilpatrick, a disciple of the Dewey philosophy, became known for his "Project Method" and was a caustic of the traditional approach to education. James E. Russell's most important role in the development of the Progressive Education Movement in the United States was the growth of Teachers College, Columbia University, under his leadership. No institution had such an outstanding and influential faculty as did Teachers College. Along with its fine faculty, Teachers College's experimental schools — Speyer School, Lincoln School and the Horace Mann School — were important in developing the "new" concept in educational thought.

Within the "new" concept of education, industrial arts was to find an important place. Teachers College staff advocated an

industrial education program of a general nature, adhering closely to the philosophy of Industrial Arts Education of today. James E. Russell and Frederick G. Bonser envisioned industrial arts as a vital part of the modern day school curriculum. The role of industrial arts was first explained in their "Industrial Social Theory."

*The Industrial Social Theory.* Bonser returned to Teachers College in 1910 (he had been at Teachers College in 1905 on a fellowship, working under Edward L. Thorndike) where he finished his doctoral dissertation and was appointed Assistant Professor of Industrial Arts and Director of the Speyer School. As a member of the faculty of Teachers College, Bonser became a leader in the area of elementary education and an advocate of the use of industrial arts to enrich the total school curriculum. The Speyer School had been set up ten years before Bonser took over the directorship. It was initially established as an experimental school for Teachers College, Columbia University.

The Speyer School offered Bonser the opportunity to put into practice some of the ideas he had written about and experimented with while at Cheyney, Washington and Macomb, Illinois. In 1910, in the article "Fundamental Values in Industrial Education" (Bonser, 1910), Bonser reaffirmed his philosophy of education and the role of industrial arts he had developed earlier.

The Industrial Social Theory can be found in a booklet entitled *Industrial Education* (Russell and Bonser, 1914). This booklet contains two articles; "The School and Industrial Life" by Russell and "Fundamental Values in Industrial Education" by Bonser. Both articles were attempts to focus attention on the importance of studying selected industries in a technical-industrial society. Bonser and Russell criticized the manual training movement at the time. They both concurred that their theory of industrial arts would bring about a curriculum that would integrate all the school subjects into a more meaningful educational experience. The significance of this "theory" is that it stressed the importance of introducing the study of industry into the elementary school. Both men saw industrial arts as the discipline to undertake the study of industry. By an organized study of the vital industries which provide for man's basic life needs (food, clothing and shelter), an understanding of the industrial fiber of



society could be gained. Dean Russell's article was considered by Snedden and Warner as "laying the foundation for the present study of Industrial Arts" (Snedden and Warner, 1927, p. 7). Both articles are very similar and can be thought of as the formulation of a single concept by two men.

At this point some statements made by other researchers should be clarified. Bonser's position on the place of industrial arts in the elementary school curriculum was stated in his 1910 article and can be traced back to his earlier writings and speeches on industrial arts. Some researchers have implied that Bonser's article was nothing more than a rewrite of Russell's article because the two were similar and Bonser's was written some two years after Russell's. The evidence does not support this point of view. Russell's article was a collection of thoughts and ideas of the faculty at Teachers College — this can be documented. Secondly, Bonser's earlier writings (in particular, "A Syllabus of Educational Principles for Professional Discussion" printed in the *Normal Seminar*, September, 1904) stressed Bonser's main point of view. Also in the article, "Industrial and Social Work in the Elementary School," (printed in March 1909, in the *Normal School Quarterly*) Bonser followed so closely the main thought and ideas of his 1910 article that it could be interpreted as a forerunner to that article, and it would indicate that Bonser had been formulating these ideas for some time.

*The Speyer School Curriculum.* The implementation of these ideas was carried out in the Speyer School from 1910-1913 while Bonser was the director. The work at the Speyer School was presented in the publication *The Speyer School Curriculum in 1913*. This publication outlined the type of classroom activities that were to be carried on in the activity-oriented curriculum. The significance of this new curriculum approach to education was manifested by the continued demand and sale of the publication long after the Speyer School was discontinued. The publication subsequently passed through several reprints (Mossman, 1931, pp. 1-18).

The school's basic aim was "social efficiency" which was to be achieved by implementing the following principles:

1. The curriculum of the School should represent the needs and interests of present day life in our own immediate environment and the world at large, the *social* factor.

2. The work, at any given stage of the child's development, should be that which is adapted to the immediate enrichment of his life as measured by his individual needs and capacities, the psychological factor (The Speyer, 1913, p. 2).

Two corollaries to the foregoing principles were presented. The first of these was the principle that the school must be democratic enough to provide an education for what the article called "concrete thinkers" (those that manage things, affairs and people) as well as for "abstract thinkers" (those that manage ideas and think in terms of symbols). The second corollary embodied the idea that the school must provide real life experiences in an active and participatory way. Emphasis was to be placed on the importance of the industrial, commercial and economic aspects of society as vital parts of the education of children. Of paramount importance was:

Through and through, the courses of study are humanistic — a means of participating in life's activities and interpreting them in terms of their value for human well being (The Speyer, 1913, p. 2).

Bonser's work as Director of the Speyer School came to a close in 1913. He returned to full time teaching as a Professor of Education at Teachers College. Working in this atmosphere of the "new" education, Bonser was to refine and lay the ground work for the present industrial arts philosophy. Bonser's philosophy of industrial arts evolved around the "child-centered" concept. This concept considered as paramount both the interests of children and an understanding of their "inner and outer environment." Bonser maintained that it was vital to the learning process to know the inner workings of children: how they learn, why they react as they do, and an awareness of their home and community life.

Bonser held that the main purpose of education was the socialization of children. His educational goal was to provide a child with the ability to live and function effectively within an industrial society. Bonser stressed that through an activity-oriented curriculum (industrial arts), one wherein a child could relate life experiences to school life, a child could better cope with life itself. Bonser considered the things of everyday life as "life needs" and in turn wanted to make them educational. The school and education were not to be isolated from life — home, work, community, and society.

According to Bonser, the specific purpose or objectives to be accomplished in industrial arts were: (1) a health purpose, (2) an economic purpose, (3) an art or aesthetic purpose, (4) a social purpose and (5) a recreational purpose. These purposes were to be accomplished by utilizing the psychological or natural impulses of children toward expression or action. Bonser identified six psychological impulses naturally expressive in children. They were (1) the impulse to manipulative activity, (2) the impulse to investigate, (3) the impulse to art activities, (4) the impulse to play, (5) the impulse to communicate and (6) the social impulse (Bonser and Mossman, 1923, pp. 33-39).

The role of industrial arts was to contribute to the development of these natural impulses into effective habits or attitudes by providing educational direction. The educational experiences should therefore be based on the child's psychological and mental growth.

*Bonser's Units of Study in Industrial Arts Education.* The basis for Bonser's curriculum in industrial arts (that industrial arts was to concern itself with man's basic needs — food, shelter, clothing) remained constant throughout his career. Bonser considered the organization of the industries the key to bring the study of the industries into the elementary school curriculum. At the Speyer School, he experimentally worked with an organization based on "materials concept" which was an implementation of the approach advocated by Russell and himself. Bonser later modified this concept to a new organization based on the use of products. This change was brought about because Bonser's work at the Speyer School indicated that there was no unity in materials as materials. Such raw materials as clay, metals, and wood, for example, enter into many industrial fields far removed from one another. This diversity gave little sense of unity or continuity in the organization of the industries.

A new form of classification was needed. This new classification was that of products, justified on the grounds that the basic needs of man are based on products rather than on raw materials (Bonser and Mossman, 1923). These changes that Bonser made in the units of study can be seen by looking at the following:

1910

“food products, textiles, wood products, iron and other metals, and clay and allied earth products” (Bonser, 1910, Tech. Bulletin).

1913

“food; shelter; clothing; records; utensils; and tools, machines, and weapons” (The Speyer, 1913).

1923

“food; clothing; shelter; utensils; records for transmitting experiences; and tools and machines” (Bonser and Mossman).

1930

“(1) food; (2) clothing; (3) shelter and home furnishing; (4) utensils; (5) tools and machines; and (6) records, or books and other publications” (Bonser, 1930).

Therefore, while Bonser did modify his initial units of study, the basis or structure for his curriculum remained constant — man’s basic needs of food, clothing and shelter.

Bonser’s lifelong interest in an “activity-oriented” curriculum led him to accept the chairmanship of the Committee on the Activity Movement, National Society for the Study of Education. This committee was charged with the responsibility of producing a yearbook on the activity movement. Bonser never saw the completed product, entitled *The Thirty-Third Yearbook of the National Society for the Study of Education/Part II The Activity Movement*; it was published three years after his death.

## CONCLUSION

With the death of Frederick G. Bonser, industrial arts education lost force in its quest for a place in the elementary school curriculum. Bonser was considered by many to be the “Father” of industrial arts education, a father who did not leave a son to carry on the “family” tradition. Bonser’s ideas were carried on after his death by many educational leaders. With the changing times — depression, World War II — the emphasis on industrial arts in the elementary school was to change to one in which industrial arts was seen as being more appropriate at the junior high school level. With the work of men like William E. Warner,

the concept of the general shop was refined around broad concepts and humanistic characteristics.

The purpose of this chapter has been to "set-the-stage for what industrial arts education will be or could be in the future. We have "roots" in a humanistic and progressive education beginning. We must not forget these "beginnings" but must capitalize on them. This is the background with which an open-access curriculum must be developed. For that matter, any *new* educational undertaking must build and constantly be aware of its achievements and failures.

## REFERENCES

- Archambault, Reginald D. *Lectures in the Philosophy of Education: 1899 by John Dewey*. New York: Random House, 1966.
- Bawden, William T. Letter to Russell, James E. New York: Teachers College, Columbia University, Archives File, December 2, 1915.
- Bonser, Frederick Gordon. *The Elementary School Curriculum*. New York: Macmillan Company, 1920.
- Bonser, Frederick Gordon. "Fundamental Values in Industrial Education," *Technical Education Bulletin*, No. 10. Teachers College, 1910.
- Bonser, Frederick Gordon. "The Industrial Arts in the Elementary School," *School Arts Magazine*, XIII No. 3, November, 1913, pp. 183-186.
- Bonser, Frederick Gordon. *Industrial Arts for Public School Administrators*. New York: Teachers College, Columbia University, Bureau of Publications, 1930.
- Bonser, Frederick Gordon. *Life Needs and Education*. New York: Teachers College, Columbia University, 1932.
- Bonser, Frederick Gordon. "The Significance of a Name," *Industrial Arts Magazine*, I, March, 1914, p. 112.
- Bonser, Frederick Gordon, and Mossman, Lois C. *Industrial Arts for Elementary Schools*. New York: Macmillan Company, 1923.
- Brameld, Theodore. *Philosophies of Education in Cultural Perspective*. New York: The Dryden Press, 1955.
- Cremin, Lawrence, Shannon, David and Townsend, Mary. *A History of Teachers College*. New York: Columbia University Press, 1954.
- Cremin, Lawrence. *The Transformation of the School/Progressivism in American Education 1876-1957*. New Ycrk: Alfred A. Knopf, 1962.
- Dewey, John. "Psychology of Occupations," *The Elementary School Record*, April 23, 1900, pp. 82-84.
- Dewey, John. *The School and Society*. Revised. Chicago: The University of Chicago Press, 1915.
- Dewey, John. *The Child and the Curriculum* and *The School and Society*. Chicago: The University of Chicago Press, 1956.

- Goodlad, John I. *The Conventional and the Alternative in Education*. Berkeley, California: McCutchan Publishing Corporation, 1975.
- Jones, Howard Mumford. *American Humanism Its Meaning for World Survival*. New York: Harper & Brothers Publishing, 1957.
- Kilpatrick, William H. "The Project Method," *Teachers College Bulletin*, 10th Series, No. 3, October 12, 1918.
- Lamont, Corliss. *Humanism as a Philosophy*. New York: Philosophical Library, 1949.
- Mossman, Lois C. "Frederick Gordon Bonser," *Teachers College Record*, XXXIII, October, 1931, pp. 1-8.
- Phipps, Raymond W. "Frederick Gordon Bonser: A Biographical Study of His Life and Works." Unpublished master's thesis, Ohio: The Ohio State University, 1935.
- Russel, James E. Letter to Bawden, William T. New York: Teachers College, Columbia University, Archives File, December 15, 1915.
- Russell, James E. "Teachers College New York City," A Report from the Dean, Unpublished, New York: Teachers College, October 30, 1919, p. 24.
- Russell, James E. and Frederick G. Bonser. *Industrial Education*. New York: Teachers College, Columbia University, 1914.
- Silvius, G. Harold and Curry, Estell H. *Teaching Multiple Activities in Industrial Education*. Bloomington, Illinois: McKnight Publishing Company, 1956.
- Snedden, David and Warner, William. *Reconstruction of Industrial Arts Courses*. New York: Teachers College, Columbia University, 1927, p. 7.
- The Speyer School Curriculum*. New York: Teachers College, Columbia University, 1913.



*Dr. Lowell D. Anderson*

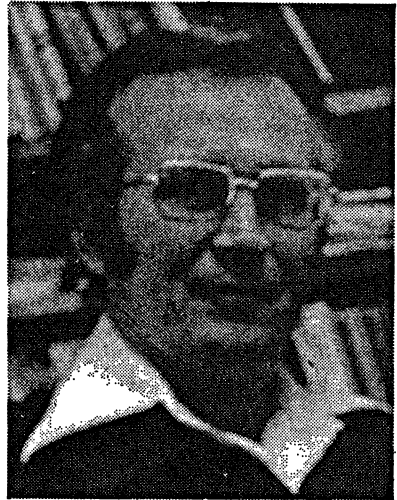

Lowell D. Anderson received his Bachelor of Science and Master of Science degree from St. Cloud State College in Minnesota. A Doctor of Philosophy degree was granted from Michigan State University with study emphasis in curriculum and sociology.

He has taught at the junior and senior high school having experienced the forecast "social dynamite" of the large urban schools in the industrial midwest to the small native schools of Alaska. His college teaching experience was at Northern Michigan University and the University of Maryland. Currently he is coordinator of industrial studies at the University of Manitoba.

Dr. Anderson has been active in the middle school and open education concept for almost ten years. He has published a number of articles and been involved in curriculum projects in middle schools. He has been very active in developing teacher education programs in recent years and advocates that the development of human potential is our most crucial problem.



# Implications for Industrial Arts in the Open Access Curriculum

*Lowell D. Anderson*

But what good is it to pose questions of motives? of Why? All that must be the work of some miserable intellectual who balks at technical progress. The attitude of the scientists, at any rate, is clear. Technique exists because it is technique. The golden age will be because it will be. Any other answer is superfluous.

Jacques Ellul, 1967

## INTRODUCTION

This quote by Jacques Ellul in *The Technological Society* (1967) poses one of the prime reasons for writing a yearbook, that reason being to raise questions and suggest alternatives. However, as occurs in most professional groups, an open, objective questioning of the basic philosophical premises primary to existence of the group, a continuous process demanding considerable time, is frequently very threatening to its members.

Only recently in one of the American Industrial Arts Association convention forums this questioning did occur. One of the keynote speakers found several members of the audience entering into the pro-con debate on the philosophical bases for curriculum design in industrial arts. His plea was not to get involved in these interminable debates but to get moving with the task-at-hand. The ends justifies the means. That the goal of implementing a curriculum based on the four areas of technology was clear. That continuous debate on these philosophical issues only

serves to stifle progress. However, the reaction of a few members of the audience assured the speaker that to fail to question was to introduce the possibility of total failure in the process of curriculum design.

Questioning is a part of the theme of the twenty-fifth yearbook, *Future Alternatives for Industrial Arts* (Smalley, ed., 1976). Attention to implications in planning curriculum is brought to the members of the profession. However the philosophical premise to acceptance of alternatives is that, "education is an enculturation process, we cannot escape the responsibility of delving into a study of technology," (Smalley, ed., 1976, p. 141) with the orientation being an eye towards the future.

It is with this attitude of questioning that the writers of the twenty-eighth yearbook, *Industrial Arts in The Open Access Curriculum*, an integral part of the open education movement, postulate another alternative for industrial arts curriculum design. The philosophical premise to this design dwells on the importance of the child, encourages curriculum to be child-centered, and asks that schooling not be a process of indoctrination or cooption of a child into a pre-determined value system.

This chapter is a summary of several issues which were influential in the open education movement: (1) the role of technology in society as seen by advocates of open education, and (2) social and educational movements influencing open education in the United States. A third part of the chapter shall be implications which have been proposed by the chapter writers.

## **TECHNOLOGY AS THE BASE FOR CURRICULUM**

Leaders for the past half century have presented different curriculum designs which would broaden the base for content identification (discipline of knowledge) for industrial arts. Their goal was a curriculum that would help youth to identify within the technological society. Implementation of these recommendations is reflected in programs by a change in emphasis; i.e., from basic skills common to the tradesman, studies of the products and processes of industry to a study of the relationship of man in society based on technology. This curriculum base could serve industrial arts in the open access curriculum.

Open access curriculum should provide students with an increased diversity of programs to meet special interests; strategies need to be developed for increased use of specialized resources having compatible policies and regulations, and links need to be developed so that education can work more closely with science, government, business, and industry. This concept has many characteristics of the "common market" as found evolving between countries (Wilson, Chapter I, p. 5). According to Craig Wilson, the survival of industrial arts is *the access authorization for students to tap the technology of modern man's economic and environmental survival*.

However, the literature on the many different variations of open education is not filled with descriptive uses of industrial arts. The emphasis in open education is more frequently on values, activities, self-discovery and the growth of the individual and frequently written at the elementary or middle school grade level. Industrial arts as an area which could provide activities in interdisciplinary programs and could serve to help children become involved in understanding technology could serve in the open education model as a valuable part of the learning experience.

### **Technology and Values**

Industrial arts curriculum generally has as its purpose the study of how man affects the mechanics and materials of new and different products and processes of industry. Technology becomes defined as "material culture" (Olson, 1972) a study of the relationship between man working with materials. A very small portion, if any, of the curriculum emphasizes the effect that technology has on man. It is this technology, "Technique," (Ellul, 1967) which is so important to our modern world, affecting civilization — the organization and life styles of man — which is critical to better understanding the relationship of "self." This subtlety of difference between man affecting technology and technology affecting man becomes the value portion of the curriculum which is missed. It is the questioning of, "Where does mankind stand . . . ?" (Toynbee, 1948) that could serve to help clarify its role.

The announcements of the growth experienced by the industrialized societies since the turn of the century have been laced with exciting adjectives of more, greater, easier and better with supportive data on the size and rate of growth as indicated by the

gross national product. Impending problems were being forecast but few wanted to hear. President Dwight Eisenhower warned that society needed to assume a watchdog role by the coining of the phrase "Military-Industrial Complex." The concept of the megamachine (Mumford, 1966) as a means of assuring greater power for a few through the control, organization and exploitation of the masses became the theme of a few in society. That the nature of man should be life-centered, not work-centered or power-centered, that the setting aside of individual purposes and goals in pursuit of those of the organization, ". . . the subordination of belief to the needs of the industrial system" (Galbraith, 1967) should have served as value warnings to individuals in society. Herbert Muller (1970) argues that man still has the option of choices, technology is still not rampant, but that ". . . for my concern was not merely the transformation of our economy by the modern technology but primarily its social, cultural consequences, *its effects upon people.*"

This recognition by Galbraith, Mumford, Toynbee, Muller and others from such disciplines as economics, politics, history and anthropology on the role of man could serve as the necessary stimulus for members of the profession to continue the search for a curriculum design based on a humane technology.

The impacting of future studies motivated by "shock waves" (Toffler, 1970) of transitional changes served as a necessary stimulus toward the examination of our own welfare. Quickly a number of persons within the profession took up the theme and effectively argued that industrial arts had an important role in decreasing the information gap between the technological elite and the masses of people suffering from technological illiteracy.

The viewing of our universe as a closed ecological system in which resource development through industrialization was frequently really excessive and negligent consumption was a rude *value* awakening. The computerized scenario in *Limits to Growth* (Meadows, Meadows, Randers and Behrens, 1972) examining relationships between population, food production, industrialization, pollution and use of nonrenewable resources was further evidence that technological values were in need of increased focus in our curriculum. This awakening served as a motivator to many that the traditional curriculum based on tradesman skills failed to grapple with the broader concepts of a technological society.

However, for our curriculum to have changed from reflecting the teaching of cabinet and furniture skills to carpenter and managerial skills neither reflects a philosophical change in the profession nor a more comprehensive understanding of the role of technology. What is missing are those critical understandings of the delicate relations between man, technology and the physical universe with a questioning of the future.

This concern with future studies, according to Toffler (1974) can serve to portray a more accurate and complete image to youth about our constantly changing society. This society, *The Republic of Technology* (Boorstein, 1977) is exemplified as a throwaway use of man-made commodities (newspapers, clothing, cars, radios, cans, bottles), packaging materials with seemingly automated ease, each constantly changing our immediate environment. We picture a society in which people frequently experience extreme isolation, one-way communication with television, closed earphones, individual transportation, cubicle offices and massive schools in which the individual reaches out for stable contact. The search for that contact increasingly leads to obtaining artifacts from the past — those beautiful antiques, houses of different vintage, real wood, lamps, tables, rugs, cars, picture frames — all symbols of staying in contact with the past while rapidly moving into the future. This contact is symbolic of a prime human need to be both understood and to understand, to be the universal comprehensive comprehender (Fuller, 1969). We must focus our abilities on these values of critical importance in considering curriculum: human understanding, sense of purpose in life, security and a knowledge that man determines the direction of technology.

This process of the masses increasingly controlling technology causes an increased focusing on values, for it is a form of social planning (Mesthene, 1970). Although the technical equipment and procedures have been developed, the decision to use this technical development is couched in human values supported by depersonalized data. This cry for values can be heard in public demands placed on government, armament decisions, energy decisions and the pressure to return to a moral structure which is more easily understood in the context of increasingly complex technological society.

In our culture according to Williams (1967) are fifteen value-belief clusters: (1) activity and work, (2) achievement and success, (3) moral orientation, (4) humanitarianism, (5) efficiency and practicality, (6) science and secular rationality, (7) material comfort, (8) progress, (9) equality, (10) freedom, (11) democracy, (12) external conformity, (13) nationalism and patriotism, (14) individual personality, and (15) racism and related superiority. Many of these value clusters are closely inter-related with the content of programs. However clarification is not accomplished unless this becomes a goal of the teaching process. For example, to teach line production focusing only on the mechanics, the teacher, and student misses the opportunity to enter into the areas of the previously identified value-belief clusters. In effect what could happen is that this emphasis on mechanics becomes a form of one-sided training in the technics of technology and could be used to the detriment of the study of the impact of technics on the technology of man.

This focusing on industrial materials processing, “. . . the fabrication of raw materials into intermediate components or finished products by primarily mechanical means dependent on inanimate sources of power” (Moore, 1965) frequently becomes the program base of industrial arts. It would seem that this emphasis without a more complete understanding of the inter-relationship of man in a technological society would support the supposition that the program is a form of social efficiency, a process of social enculturation that to be good in society is to be productive and to support the process of industrialization (Fisher, 1967). The value premise emphasizes material growth, man over nature, competitive self-interest, rugged individualism, rationalism (Elgin and Mitchell, 1977) which tend to be different from those advocated by proponents of open education.

### **Summary**

The curriculum base for industrial arts has changed from emphasizing the trades skills to a study of industry, to industrial technology. This study of technology has been advocated as the knowledge base for the structure of curriculum with an emphasis that this should be a study of a humane technology. Values have also received attention, but industrial arts is still perceived as a model of social efficiency and the teaching continues of the acceptance of industry as a universal good.

A principal of an open education middle school summarizes industrial arts programs as having changed but retained the role of serving industrialism. Because of this premise, in his judgment, the compatibility between open education philosophy and industrial arts is at best tenuous. A program which uses activities common to fine art, crafts or a unified art program would better serve the school in developing youth.

Seemingly industrial arts could play a more important role in open education if it were to adopt a role of clarifying values founded in a technological society.

## OPEN EDUCATION

Educators are frequently accused of excessive use of jargon. Jargon frequently serves as a way of popularising new ideas, movements within a profession and as a disguise clouding the real meaning of fads. The use of jargon, however, is not uniquely the problem of educators; one has only to examine the selection of words and supportive symbols used by the political lead man, the advertiser, the professional and more recently the "CBers" of our highways to find various forms of specialized jargon serving to define and restrict special groups.

Open education, just the word "open," can be a form of specialized jargon. The word can convey a total message within the group, a form of sloganizing, i.e., the connotations of the word open being "right." To be open, according to Hill, (Nyberg, ed., 1975) ". . . is to be not closed, restrictive, prejudiced, or clogged; but, free, candid, generous, above board, mentally flexible, future oriented, etc." For many persons in the open education movement, to associate with *open* was to disassociate with the problems and criticisms of the educational system in the United States during the sixties and seventies. However, to accept this simplification of open education as total dogma is likely to place one in the position of not opening the concept to professional critique and inquiry prior to making decisions.

A classification system in which to place the different individuals, groups and educational movements seems to be a logical means of identification of the forces motivating the development of open education in the United States. One such system was developed by Christe and Walber (Spodek and Walberg, ed.,

1975); and, using the major components of open education, identified researchers, reporters, advisers, practitioners, historical writers, progressive educators and critics. These categories are: learning provision, diagnosis, instruction, reflective evaluation, humanness, student growth, self-perception and ideas about children. The intent was to assess the development of the movement.

However the categories used in this chapter differ because the intent is not assessment; but, to gain some insight into the individuals and general social-educational mood during the period.

The following three categories are used: (1) *reactive-supportive* are persons who react strongly against the existing educational organization and its goals and weakly support an alternative education model such as open education, (2) *historical-transportive* are persons who perceive open education as a logical evolution of education having a humane philosophy as a *modus operandi*. They see the open education movement as a continuation of the British Primary (Infant) School and a logical continuation of humanism in Europe and including the progressive education movement in the United States, and (3) *innovators-practitioners* are persons who actively develop and implement models of open education in different school settings, from the teachers college through the public school. It is not intended for purposes of the yearbook that the categories be totally inclusive or exclusive; but to serve the reader in examining the open education movement. For example, Craig Wilson (Chapter I) would be identified in the innovator-practitioner category but his model of open access education would be identified as conservative as compared to some persons in the movement. The open access curriculum (Wilson, 1971) is viewed as a part of the total open education concept.

### **Reactive-Supportive Category**

During the early fifties, peaking in the mid sixties and continuing into the seventies the educational system of the United States experienced an onslaught of criticism from both within the profession and persons outside of the formal education organization. Criticism ranged widely covering management, curriculum, personnel, and socialization of children with an overwhelming attitude of negativism and failure. This questioning fre-



quently drills deeply into the social and moral fiber of society. *Dare the School Build a New Social Order* (Counts, 1969) became more than an intellectual game of alternative scenarios but a theme of considerable concern to many. James Conant in anticipation wrote *The American High School* (1959) and later *The Comprehensive High School* (1967), in which he gently introduced many problems of the school organization and forecasted impending "Social Dynamite" in our large urban centers. These two served as the philosopher and the qualified observer to announce to the profession that all was not well.

The researcher using new techniques and the popular symbol of advanced technology (the computer) set about gathering empirical data to support various hypotheses about formalized schooling. James Coleman and *The Coleman Report* (1969), following the first analysis of the *Equality of Educational Opportunity Survey* (1966), served well to point out limitations of the system. Silberman's *Crisis in the Classroom* (1970) and Christopher Jenck's *Inequality: A Reassessment of the Effect of Family and Schooling in America* (1972) continued the theme that schools had limitations, each limitation supported through the use of data and the structuring of logic. These were just a few of the reports which influenced the organizational structure, philosophy, programs and architectural design of school buildings. The evolving of alternatives ranging from storefront schools, voucher systems and middle schools seemed to pull away from the formalized criticism while centering on the development of the child as the goal of schooling.

These were the more gentle critics, reacting against the school establishment and supporting either mild internal reform and/or the development of alternative models. These models still supported the need for some form of organization having the responsibility for enculturation of the child.

However, more serious critics of the school system were coming to the forefront. Ivan Illich, in *Deschooling Society* (1970), advocated the abandoning of the concept of "schooling." In its stead, society should develop a means of servicing personal, creative and autonomous interactions among people. Central to this model is the emergence of a set of values which could not be substantially controlled by technocrats (Illich, 1970, pp. 2-4). *School is Dead*, (Reimer, 1967) was introduced by Margaret

Mead stating, "My grandmother wanted me to have an education, so she kept me out of school," and this sets the tonal quality of the book. In the same vein, *Burn the Schools — Save the Children* (Melton, 1975) was a continuation of the thesis that schools and the process of teaching were detrimental to the development of children. Schools had become the socializing agent for children — transmitting values, shaping attitudes and conferring status on the child — all premised on the degree to which the child accepted or rejected a value system based on the concept of an industrial-business ideology of society.

Many others such as Holt, Friedenberg, Kohl, Kozol and Goodman served to stimulate a rethinking of education in society. A realization of the linking of economics to the educational system and the values it taught became important, e.g., "Schools throughout the history of American Education have been used as instruments to teach the norms necessary to adjust the young to the changing patterns of the economic system . . . so that if any major change in basic core values occurs, it will result from a fundamental shift in the economic system." (Karier, 1973).

Value oriented education, a process of examination, is advocated by many of the persons identified in the reactive-supportive category. However an alternative is proposed that the school should return to its primary purpose of training (Bereiter, 1973), and, that the responsibility for teaching values is that of community and parents, that schools have far outreached their role in society. This alternative is quite unique as compared to the vast majority of the critics of schools.

### **Historical-Transportive Category**

Open education is commonly associated with the development and evolution of humanistic or child-centered education in Europe and the progressive education movement in the United States (McPherson, Chapter VIII). Open education is linked with the philosophies of Plato, Rousseau, Tolstoy, Comenius (Spodex & Walberg, 1975, p. 29). More recently the movement in open education has been influenced by the British Primary School.

The British Primary School, resulting in part from the Plowden Report, (A Report of the Central Advisory Council for Education: England, 1967) resulted from the motivation toward changes in elementary education in England. Promoting reform, the substance of the report considered the achievement of chil-

dren, structure of the school, curriculum, buildings, teachers, costs and role of government in education (McCrory, Chapter II, pp. 16-18). Joseph Featherstone, author of *British Primary Schools Today: An Introduction* (Featherstone, 1971) is credited with having been influential to Roland Barth (1972) in implementing some of his concepts of open education. Featherstone advocated that a good school ought to be a planned environment in which children could work independently or in groups in a process of development. Two of the primary principles guiding open education schools are the recognition of individual differences and the assertion that children learn from active experiences (Rogers, 1970, pp. 5-15).

The influence of the progressive education movement, European philosophers, and the British Primary School served to establish the philosophy of open education in the elementary and middle schools in the United States. Paramount is the recognition of the child as central to the school and the implementation of a humane philosophy.

#### **Innovator-Practitioner Category**

The classroom teacher is probably the person most intimately involved in implementing the concept of open education in the public school. The experience of one person in a middle school having an open philosophical base (Levande, Chapter VII) would indicate that to be successful involves a dedication to change. Probably one of the most difficult problems in innovation is the lack of a clear, concise definition of the concept. However, most persons in open education are of the opinion that they can observe a classroom and know that it is right because it seems right.

Increasingly the movement has been identified with (Franklin, 1973) such innovations as learning centers, open areas, classroom centers featuring activities and materials which are student-selected but utilized after careful planning by the teacher. The consistent elements which are repeated are:

1. The child is the center of the teaching activity and teachers become students of learning.
2. Knowledge is important but is used to promote the total growth of the child.
3. The learning theories of Jean Piaget are frequently used in the elementary and middle school models.

4. Individual differences in the teaching environment are recognized and supported.
5. The development of a value system through differentiation is critical to the growth of the child.

However a concise definition is frequently identified as one of the major limitations of the movement (Meyers, 1973; Perrone, 1972; Spodek and Walberg, 1975; and Nyberg, 1975). This opens the movement to faddism and sloganism common to many poorly defined concepts in education innovation.

Frequently the teacher is asked to implement without a curriculum definition with undefined goals and objectives and without programs designed to prepare teachers. The tremendous philosophical difference between conventional and open education can lead to very high work loads resulting in teacher dissatisfaction and potential collapse of a new program. Parents, children, administrators and schools in the system need to be involved in innovation.

Roland Barth, *Open Education and the American School* (1972), Vito Perrone (1972), Dean of the New School of Behavioral Studies in Education at the University of North Dakota, Joseph Featherstone (1971), and Craig Wilson (Chapter I), author of *The Open Access Curriculum* (1971), are just a few of the persons who are identified on the national level as leaders of the open education movement. Generally, the movement has been best supported in the elementary and middle school. Industrial arts is not usually mentioned in the literature. However, the use of activities and the manipulation of tools and materials are commonly used in learning centers to make learning a more meaningful experience.

### Summary

Open education as a movement in education has evolved from pressures on education and the influence of humanistic philosophies in Europe and the United States. Three categories are identified: reactive-supportive, historical-transportive, and innovators-practitioners which serve to clarify the development of the movement.

One of the critical problems of open education is the lack of a concise definition. This causes researchers, administrators, teachers, writers and parents considerable difficulty. The best

definitions — which identify different components, frequently identified throughout education, i.e., individualization, learning centers, learner oriented, child-centered, activity based, humane philosophy — do not clarify the picture but serve to increase the level of mystique.

Values are at the crux of the open education movement. The more radical position states that schools and the concept of schooling have been detrimental to the child, that alternatives should be explored which promote individualism. The more conservative position favors modification of existing concepts of schooling with an emphasis on humanism. Industrial arts has several options in open education, the use of activities in elementary and middle schools; and, secondly, an opportunity to teach *about technology* and its relationship with man.

## IMPLICATIONS FOR STUDY

Eight implications have been synthesized from the previous chapters of the yearbook and are recommended for use in curriculum design and program development. Seemingly, two consistent themes tie together this yearbook. First, industrial arts can provide avenues of access through the use of multiple information resources for youth to survive in a society premising its existence on the use of technology. Second, the teacher must become a student of learners and the development of the individual is primary to the philosophy of open education. The eight implications become integral to these themes.

The authors recognize that some of the enthusiasm for open education has waned in favor of a return to the basics. However, industrial arts has historically been progressing in both the direction of understanding technology and a concern for humans as indicated by our convention proceedings (AIAA proceedings 1970, 1971, 1972 and 1974). Thus, as curriculum and programs are introduced, these implications seem appropriate and consistent with our recognition of the dynamic characteristics of time.

### Implication Number I

Industrial arts, if it is to survive, must have the authority to provide students with avenues of access to use information from a world community to better understand technology.

The survival of industrial arts as a part of the school would seemingly be dependent on providing youth with access to study the technology of man's economic, industrial and environmental survival. This will require the development of critical links between science, government, business and industry in a world community. Access will mean the adoption of a "common market policy" which will permit the authorization and use of resources more efficiently. This will be accomplished during a period of stable or decreasing growth of spendable resources in the educational system.

The concept of a school, a building, (Wilson, Chapter I) would change to a manageable use of authorized programs having multiple exit and entry points using an accessible network of school and community services. The results will be more specialization for resources and personnel, more personalization of students' interests and more freedom of movement. The obvious implication is that the high cost of duplicating expensive industrial laboratories and use of limited material resources may force adoption of an open access (common market) model in order to survive.

#### **Implication Number II**

Industrial arts curriculum based on stable knowledge (a defined set of facts which can be taught repeatedly) is not compatible with the emphasis on process and human development in open education.

Many of the programs in industrial arts are based on stable knowledge identified through the "passing-on" of basic skills from public schools through teacher education institutions and returning to the schools. The emphasis on identification of a content base has also been consistent with our professional striving for legitimacy by having a discipline of knowledge. Frequently our curriculum design strategies have been very reflective of the techniques of trade and job analysis as the means of content identification. Rarely has the profession focused on *process* emphasizing the development of human characteristics as the content of the profession. One exception has been the development of the use of behavioral task analysis (Maley, 1969) as used in the Maryland Plan (Maley, 1973).

The degree to which the profession adopts open education (McCrary, Chapter III) will in part be premised on the degree process is accepted as compared to content. Currently it would

appear that contested truth and open exploration as process in the study of technology seems most feasible.

### **Implication Number III**

Learning environments in an open access curriculum must utilize rich resources of information in the community.

Our current design of learning environments does not reflect our knowledge about people or recognize the dwindling available resources required to build and maintain industrial laboratory facilities. A conceptualization of learning environment (Todd, Chapter III) needs to be developed and used which recognizes the collective social, physical and technical settings in which people explore, interact and learn.

Increasingly, we must recognize that our survival may depend on the restructuring and designing of environments which have multiple and full-time student use requiring a stable or decreased dependence on large amounts of money. Duplication of industrial equipment or industrial settings in school laboratories could render the concept of industrial arts obsolete in periods of economic stress.

### **Implication Number IV**

Industrial arts curriculum to be premised on a study of technology must recognize that a study of small components of technology in isolation may negate a conceptualization about the massive effect of technology.

Three reasons seem to account for our current dilemma in grappling with a curriculum based on the study of technology: first, an over-dependence on stable knowledge; second, the problems of change; and, third, the complexity of technology as a concept.

Curriculum projects frequently emphasize content identification not based on "Universals" (DeVore, 1966) essential in defining a structure. These universals are stable, not confined to one area of study, capable of replication and not susceptible to time. Emphasis is on stable knowledge (Wilson, Chapter I and Duvall, Chapter IV) which is rendered obsolete in attempting to study the dynamic characteristics of society. The extensive use of stable knowledge does not permit the development of intellectual curiosity requiring research, debate, analysis, evaluation and other highly transferable human skills.

The degree of professional resistance to change is difficult to assess. Course title changes, name changes, and publication themes are not always good indicators of actual change. However these changes may be indicators of projected or future changes.

The profession is currently in need of an intellectual elite whose interests and capabilities are to develop and use ideas which could serve to design future options.

#### **Implication Number V**

Teacher education programs need to prize diversity and uniqueness in their students rather than conformity, commonness and standardization. Teachers must become *students of learners*.

Teacher education faculties must develop exemplary teaching practices in preparing teachers to become "students of learners" (Barella & Smith, Chapter VI). It is suggested that teacher education programs make gradual and modest revisions to assure that students develop characteristics of individuality, uncommonness and an orientation to the principles of open education. Programs having an over emphasis on manual skill development begin to mute this emphasis in the process of promoting problem-solving, inquiry and other methodologies. Teacher education programs should involve students in teaching and curriculum decisions; students need to learn teaching by teaching; and, students must become involved in the community as a source of information. The major change in teacher education is the focus on learner behavior as differing from focusing on materials or processes of industry as the final product.

#### **Implication Number VI**

Surveyed members of the American Council on Industrial Arts Teacher Education support many of the basic principles of open education as measured by the Barth Scale.

A majority of the professors surveyed using the Barth Scale support many of the principles of open education (Zurbuch, Chapter V). The more acceptable principles are premised on the natural curiosity of children, that they are intrinsically motivated to explore and learn through the use of activities. Learning is perceived as an individual process different for each person. This individuality means that knowledge does not fit into neat little categories and is not the same for all people. However, the profession does support the concept that a *core of knowledge*



*exists* in industrial arts which should be learned by all students. However, to generalize that these principles apply only to open education and that acceptance of these principles means acceptance of open education could be misleading.

#### **Implication Number VII**

Open education and middle school concepts are different and require careful planning and extensive involvement if they are to be implemented successfully.

Making the decision and implementing curriculum and organizational changes of the magnitude required by middle schools having an orientation towards open education requires considerable lead time and extensive involvement of the total community served by the school (Levande, Chapter VII). The failure to provide adequate planning time and supportive decisions has in some situations resulted in extreme stress being experienced by teachers, students and parents as the new concept is implemented. Innovations such as open area, pod organization, team teaching, individualization of instruction and complete philosophical change require time and support; if not, resistance and failure of a new concept frequently occur.

#### **Implication Number VIII**

Industrial arts during the progressive education period lead by Frederick Bonser gained considerable recognition in the elementary school. Industrial arts was both content and method, bringing activity to the classroom. This historical recognition of the learner as the center of the curriculum is consistent with current principles of open education.

This humanistic base, "our roots," should play a vital role in our continuing growth (McPherson, Chapter VIII).

## **CONCLUSION**

The development of open education in the United States is one of several alternative education models evolving during a period of rapid change. The open access model of curriculum is suggested as a model in which industrial arts can provide youth with the opportunity to explore and experience the many facets of a society using technology. These changes are motivated by the needs of people and the changing nature of society and tech-

nology. If industrial arts is to survive, members of the profession must carefully design and modify its premise, making it an area which gives youth the most realistic picture of the future.

## REFERENCES

- Bailey, Stephen. *The purpose of education*. Bloomington, Ind.: Phi Delta Kappa, 1976.
- Barth, Roland S. *Open education and the American school*. New York: Agathon Press, 1972.
- Bereiter, Carl. *Must we educate?* Englewood Cliffs, N. J.: Prentice-Hall, 1973.
- Conant, James B. *The American high school today*. New York: McGraw-Hill Book Company, Inc., 1959.
- . *The comprehensive high school*. New York: McGraw-Hill, 1967.
- Counts, George S. *Dare the school build a new social order*. New York: Arno Press, 1969.
- Department of Education and Science. *Children and their primary schools: A report of the Central Advisory Council for Education (England)*. London: Her Majesty's Stationery Office, 1967.
- DeVore, Paul W. *Structure and content foundations for curriculum development*. Washington, D. C.: American Industrial Arts Association, 1966.
- Elgin, Duane and Mitchell, Arnold. Voluntary simplicity life style of the future. *The Futurist*, August, 1977, 11 (4), 200-206.
- Ellul, Jacques (translated by John Wilkinson). *The technological society*. New York: Alfred A. Knopf, 1967.
- Featherstone, Joseph. *British primary schools today: An introduction*. London: Macmillan Education, Ltd., 1971.
- Fisher, Bernice. *Industrial education: American ideals and institutions*. Madison: The University of Wisconsin Press, 1967.
- Franklin, Marian P. (editor). *Classroom centers and stations in America and Britain*. New York: MSS Incomration Corporation, 1973.
- Galbraith, John K. *The new industrial state*. Boston: Houghton Mifflin Co., 1967.
- Goodlad, John I., et al. *The conventional and the alternative in education*. Berkeley: McCutchan Publishing Corporation, 1975.
- Illich, Ivan. *Deschooling society*. New York: Harper and Row, 1970.
- Karier, Clarence, Violas, Paul and Spring, Joel. *Roots and crisis: American education in the twentieth century*. Chicago: Rand McNally and Company, 1973.
- Maley, Donald. *The Maryland plan*. New York: Bruce, 1973.
- . *The Maryland plan and the behavioral task analysis approach*. American Industrial Arts Association (convention report), 1969.
- Melton, David. *Burn the schools: Save the children*. New York: Thomas Y. Crowell Company, 1975.

- Muller, Herbert J. *The children of Frankenstein: A primer of modern technology and human values*. Bloomington, Ind.: Indiana University Press, 1970.
- Mumford, Lewis. *The myth of the machine: Technics and human development*. New York: Harcourt, Brace and World, Inc., 1966.
- Myers, Lilian and Myers, Donald. *Open education re-examined*. Lexington, Mass.: D. C. Heath and Company, 1973.
- Nyberg, David. (editor). *The philosophy of open education*. Boston: Routledge and Kegan Paul, 1975.
- Oliver, Donald W. *Education and community: A radical critique of innovative schools*. Berkeley: McCutchan Publishing Corporation, 1976.
- Olson, Delmar. "Industrial arts: Interpreter of technology for the American school." *Man/Society/Technology*, Sept.-Oct., 1972, 32 (1), 34-39.
- Peaker, G. F. *The Plowden children four years later*. England: National Foundation for Educational Research, 1971.
- Perrone, Vito. *Open education: promise and problems*. Bloomington, Ind.: Phi Delta Kappa Educational Foundations, 1972.
- Proceedings of annual conventions of the American Industrial Arts Association*, Washington, D. C., 1970, 1971, 1972, 1974.
- Reich, Charles A. *The greening of America*. New York: Random House, 1970.
- Reimer, Everett. *School is dead: Alternatives in education*. Garden City: Doubleday and Company, Inc., 1970.
- Riordan, Robert C. *Alternative schools in action*. Bloomington, Ind.: Phi Delta Kappa Educational Foundation, 1972.
- Rogers, Vincent R. *Teaching in the British primary school*. New York: The Macmillan Company, 1970.
- Silberman, Charles E. *Crisis in the classroom: the remaking of American education*. New York: Random House, 1970.
- Silberman, Melvin L., Allender, Jerome S. and Yanoff, Jay M. *The psychology of open teaching and learning*. Boston: Little, Brown and Company, 1972.
- Smalley, Lee (editor). *Future alternatives for industrial arts*. American Council on Industrial Arts Teacher Education. Bloomington, Ill.: McKnight Publishing Co., 1976.
- Spodek, Bernard and Walberg, Herbert (editors). *Studies in open education*. New York: Schocken Books, 1975.
- Student development — An essential base for program development*. Convention report of American Industrial Arts Association, 1975.
- Toffler, Alvin. *Future Shock*. New York: Random House, 1970.
- . *Learning for tomorrow: the role of the future in education*. New York: Vintage Books, 1974.
- Toynbee, Arnold J. *Civilization on trial*. New York: Oxford University Press, 1948.
- Williams, Robin. Individual and group values. *Annals of the American Academy of Political and Social Science*, 1967, 37, 30.
- Wilson, Craig L. *The open access curriculum*. Boston: Allyn and Bacon, Inc., 1971.

# Index

- ACIATE**, survey of, 254  
**ACIATE** Yearbook XXI, 178  
 "Abstract thinkers," 232  
 Access authorization, 241  
 Access avenues, 251  
 Activity movement, the, 234  
 Activity-oriented curriculum, 232  
**Allen, Dwight**, 93, 94  
 Alternatives, 99  
 American Industries Project, 50  
**Argyris**, 67  
**Argyris and Schon**, 197
- Barth model, 199  
**Barth Roland**, 118, 196-205, 213  
 Barth Scale, 123-134  
**Beauchamp, George A.**, 39  
 Behavior, inappropriate, 204  
 Behavior modification, 30  
 Behavioral objective, 81  
**Biddle and Thomas**, 198  
**Bobbitt, John F.**, 51  
 Body Adjustment Test, 161  
**Bonser, Frederick G.**, 122, 230
- Career Education, 43  
 Child-centered school, 218  
 "Closed" instructors, 159  
 Closure, 203  
**Cochran, Leslie H.**, 38  
 Cognitive learning style, 153  
   field independence in, 153  
   reflective vs. impulsive, 154  
**Combs (1965)**, 163  
 "Common market" theory, 21  
 Community resources, 194  
 Community service, 195
- Competency-based education, 164  
 "Comprehensive comprehender," 243  
 Computer-assisted reporting, 208, 210  
 "Concrete thinkers," 232  
 Conservative swing, 46  
 Consolidation of learning, 203  
 Construct building, 107  
 Construct focuser, 107  
 Contested truth, 24  
 Contract method, 171  
 Criticism and change, 178  
 Cross-discipline approach, 209  
 Content and method, 224  
 Content base, 99  
   industry or technology, 42  
 Content differentiation, 24  
 Content emphasis, 100  
 Content evolution, 25  
 Content selection, 48, 163  
 Content sequencing, 108  
 Content vs. method, 90  
 Cultural determinants, 100  
 Cultural universals, 105  
 Curriculum —  
   adaptations, 42  
   child-centered, 37  
   conflict, 37  
   congruity with philosophy, 41  
   contributors, 30  
   development, 56, 40, 49  
   nationalized, 91  
   plan, 39  
   reform, 90  
   theory, 39  
   trends, 38

- Curriculum design, 23, 38, 92  
 anthropological base of, 44  
 content base of, 240  
 and control function, 42  
 consensus of, 43  
 emphasis on, 252  
 in the Sixties, 97  
 levels of, 40  
 and student emancipation, 44
- Data bank of resources, 194  
 Dependent learners, 148  
 Democratic education, 220  
 Desocialization, 68  
 Developmental tasks, 104  
**DeVore, Paul**, 105  
**Dewey, John**, 43, 93, 221  
 Differentiated teacher role, 31  
 Direct instruction, 203  
 Diversified faculty, 167
- Ecology and values, 241  
 Educational change, 93  
 Educational planning, 19  
 Elementary industrial arts, 230  
**Ellul**, 1967, 239  
 Embedded Figures Test, 161  
 Environmental analysis, 70-72  
 Environmental design, 69  
   facilities system, 74  
   facility designer, 72  
   lighting, 80  
   managements, 78, 79  
   "near environment," 70  
   planning of, 78  
   sound, 80  
   "systems" parts, 73  
   visual barriers, 80  
 Environmental regulators, 32  
 Equipment analysis, 81  
 Evaluation, 204  
 "Exploratory" content, 24
- "Facilitators," 159, 200  
**Featherstone, Joseph**, 46  
 Field trips, 168  
 Flexible facilities, 83  
 Flexible models, 155
- Flexible space, 83  
**Frazier, Alexander**, 49  
 "Free expression," 219  
**Froebel, Friedrich**, 219  
**Frymier**, 92  
 Functional specialities, 32  
 "Fundamentals," 50
- Gallup**, 1975, 117, 119  
**Gardner, John W.**, 147  
 General education, role of  
   industrial arts, 179  
**Goodenough and Karp**, 1961, 154  
**Goodlad**, 95  
 Group inquiry, 204  
 Group management, 67  
 Grouping, 80, 201  
   cohesion, 66  
   complex perspective, 66  
   rational-economic perspective,  
   66  
   self-actualizing perspective, 66  
   social perspective, 66  
   sources of attraction, 65  
   spatial arrangements, 66
- Haptic Visual Matching Test,  
 161  
 Hueristic teaching, 166  
**Hill, Brian**, 47  
 Historical-transportative persons,  
 246, 248  
 "House" organization for  
 learning, 187  
 Humanism in education,  
 95, 217, 243  
**Hunter, William**, 122
- Impacts of technology, 107  
 Independence, 67  
 Independent learners, 156  
   environment for, 38, 201  
 Individualized programs, 148  
 Industrial arts,  
   "roots of," 255  
 Industrial Arts Curriculum  
   Project, 38, 50, 52

- Industrial Education Assn., 1884, 226  
 Industrial Social Theory, 228, 230  
 Industry, as a resource, 168  
 "Information implosion," 93  
 Information-intensive learning, 33  
 Innovators, practitioners, 246, 249  
 Instructional Objectives Exchange, 52  
 Instructional strategies, 111  
   attributes to creativity, 144, 112, 113  
 "Insulation," 65  
 Interaction-intensive learnings, 33  
 "Interpreter of technology," 103  
 Intra-disciplinary planning, 179, 180  
  
**Kagan, 155**  
**Kilpatrick, William H., 225**  
 "Kindergarten," origin of, 219  
**Kliebard, 51**  
 "Knower," the, 199  
  
 Learning activities, 224  
 Learner assistants, 30  
 Learner diagnosis, 160  
 Learner needs, 105  
 Learner profiles, 160  
 Learner variability, 158  
 Learners, nature of, 92, 93  
 Learning behavior, 186  
 Learning contracts, 171  
 Learning curve, 110  
 Learning environment, 60, 167  
   definition of, 60  
   flexible facilities, 83  
   organizing centers, 80, 81  
   physical layout, 61  
   projected, 82  
   providing choices, 81  
   social interaction, 62  
   social norms, effect of, 62  
   space utilization, 79  
   spatial relationships, 63  
   use of community, 253  
  
 Learning Opportunities Model, 158  
 Learning process, 186  
 Learning resources, 167  
 Learning styles, 152  
**Letcher, 149**  
 Linguistic collusion, 65  
  
**MacDonald, James, 42**  
**Maley, Donald, 42, 43, 44, 104**  
 Mainstreaming, 22, 47  
 Manipulative materials, 202  
 Manual training, 221  
**Maslow, Abraham, 44**  
 Matching Familiar Faces Test, 161  
 "Material culture," 241  
 Maryland Plan, 104, 252  
**Mayer, 92**  
**McDaniel, 92**  
 Media analysis, 81  
 Michigan Association of Middle School Ed., 193  
 Mobile students, 22  
 Mods, 190  
 Motives for learning, 160  
 Multiple administrative jurisdictions, 34  
 "Multiple entry and exit," 27  
 Multi-method-media approach, 161  
  
 Natural impulses, 233  
 Needs identification, 209  
  
**O'Hanlon, 50**  
 Ohio Prospectus, 102  
**Olson, Delmar, 103**  
 Open access technology, 105  
 Open education —  
   acceptance of, 4, 121, 136  
   and creativity, 120  
   classification, 245  
   demise of, 117  
   definition, 245  
   elements of, 249  
   essential planning, 255  
   for industrial arts, 121  
   history of, 45

- impact on industrial arts, 96
  - "normative openness, 48
  - "procedural openness," 45
  - research, 119
  - research on acceptance, 126
  - support by ACIATE, 140
  - teachers, 156
- Open exploration, 200
- "Open" instructors, 159
- Open schools —
  - administrative support, 182
  - colleague support, 183
  - definition, 177
  - role of personal philosophy, 182
  - role of self images, 181
  - staff development, 185
  - supportive atmosphere, 205
- Open teaching role, 198
- "Overchoice," 93
  
- Parker, Francis W.**, 220
- Parkway School, 47
- Participatory Professionalism, 32
- Passive state student, 93
- "People paths," 29
- Personal commitments, 181
- Pestalozzi, Johann**, 218
- Piagent**, 199
- Plowden report, 45
- Pluralistic teaching, 151
- Prime learning times, 161
- Privacy, 67
- Problem-solving, 206
  - cross-discipline, 41
- Process models, 50
  - linear-expert, 51
  - management, 51
  - open-access, 53
  - systematic, 53
  - trade-in analysis, 52
- Professional standards, 183
- Proficiency exams, 169
- Program Evaluation and Review Techniques, 53
- "Project Method," 225
  
- Public education,
  - criticism of, 246
  - limitations of, 247
  - "Purposeful acts," 225
- Purposes, of industrial arts, 233
  
- Quincy System, 221
  
- Rathbone, Charles**, 124
- Raths, Louis**, 94
- Reactive-supportive persons, 246
- Reflection-intensive learnings, 33
- Regional Professional Development Center, 193
- Research on acceptance of open education —
  - aggregate responses, 126
  - analysis of variance, 39
  - correlation with experience, 39
  - data collection and analysis, 124, 133
  - factor analysis, 140
  - reliability, 138
- Resource centers, 22
- Resource collections, 32
- Rod and Frame Test Series, 161
- Rogers, Carl**, 44, 118
- Rousseau, J. J.**, 218
- Russell, James E.**, 227
  
- Sealey**, 118
- Scheduling, 189
- "School within a school," 187
- Self-activity, 219
- Self-evaluation, 204
- Self-motivated learner, 93
- Self-worth, developing, 211
- Sensory modality preferences, 152
- Skill-intensive learnings, 33
- Skolimowski**, 107
- Smalley**, 1976, 240
- Socialization, 232
- Specialty learning centers, 22
- Speyer School, 231
- Social adjustment, 222

- "Social" education, 222
- "Social efficiency," 231
- Social enculturation, 244
- Social control function, 29
- Stable knowledge, 96
- Staff adjustment, 190
- Staff education, 192
  - in service, 192
  - professional organizations, 193
- Staff exclusion, 192
- Student needs, 186
- Students as volunteers, 195
- "Students of learners," 151, 254
- Structured openness, 33
- "Super-disciplines," 25
- Synectics, Inc., 92
- Synectic mechanisms, 112
- System relationships, 109
  
- Teacher agents, 61
- Teachers College, Columbia, 226
- Teacher-directed approach, 148
- Teacher education, 150
  - change in, 155
  - conceptual structures, 165
  - problem-solving processes, 165
- Teacher roles, 148
- Team teaching, 188
- Technology, defn., 106
  - and values, 241
  - study of, 100
  - systems approach, 101, 109
  - universals of, 253
  - "technol-o-gee", 104
- Territoriality, 63-64
- "Theory of Occupations," 221
- Tool-intensive learnings, 32
- Transmission-of-Knowledge
  - Model, 148
- Turf defense, 65
- Tyler, Ralph, 52
  
- "Use" of knowledge, 165
  
- Value-belief clusters, 244
- Values clarification, 94
  
- Warner, William E.**, 103, 122
- Weinstein and Fantini**, 90
- Witkin**, 1967, 154
- Wood**, 1970, 149
  
- Zurbuch dissertation (1973), 122
  - data analysis, 127
  - data collection, 124
  - factor analysis, 158, 124
  - hypotheses, 125
  - instrument, 123
  - item analysis, 127
  - population, 123
  - reliability, 124, 133
  - validity, 124