

Title Page

Fitness, Flexibility, and Suspension:
An Aquatics Facility on Washington, D.C.'s Southwest Waterfront

Michelle Biesiadny-Mrstik

Thesis submitted to the Faculty of the Virginia Polytechnic Institute and State University in partial fulfillment of the requirements for the degree of

Master of Architecture

Susan Piedmont-Palladino, Chair _____

Paul Emmons _____

Brian Kane _____

Date of Defense: May 13, 2004

Alexandria, Virginia

Keywords: Fitness, Suspension, Cable, Swim

Copyright 2004, Michelle Biesiadny-Mrstik All rights reserved.



Table of Contents

Title Page	
Table of Contents	i
Abstract	ii
Introduction	1
1. Site Analysis	3
2. Frankenstein Process	5
3. Study Models & Tools	13
4. Final Drawings	16
References	32
Vita	33

Abstract

To create a legible building, the structure's form must describe and reinforce the mission of the organization that inhabits it. This proposal for a regional competition, training and recreational aquatics facility demonstrates ideas of physical fitness through an exploration of muscles, cables, tension, joints, and bones. The building is part of a larger urban strategy for redeveloping the Washington Channel waterfront in Southwest Washington, D.C. Early images of transformed beach glass, thread, and basswood generated the inspiration for the basic architectural components: the wall, the columns, and the suspended jewels. The following document gives definition to the basic elements.

6:30 PM

Thursday, May 13, 2004

“I started with the intention of designing a restaurant on a small site on the Southwest Waterfront. My focus was to explore the idea of comfort. I ended up with a competition, recreation, and practice swimming and diving facility that fits into a much larger urban strategy on the Southwest Waterfront and explores the ideas of fitness and suspension. Thus, tonight I am defending the process of how I got here because I see it as just as important, if not more important, than the building itself. I initially made “site interpretation models” with a notion of comfort on the site in mind. The beach glass model emerged as the one with the greatest architectural potential. I then learned a key lesson that “nothing is precious, and there is another generation waiting to be created.” So I photographed the beach glass model and used the “Frankenstein Process” to create these images, with an architectural sensibility in mind. I selected one image with the intent of turning it into a building. The form suggested a suspended swimming pool with light and heavy structural elements. I made study models that indicated the actual forces that would be acting on the building, including models with water balloons. I discovered that the wall needed to be angled, and the foundation needed to connect the wall to the column. I explored notions of what the suspended pools could be, and I followed the lessons of Dulles Airport’s roof. I filled the wall with the necessary program elements that could be enclosed, such as the locker rooms and chemical storage rooms.

The urban strategy incorporates similar buildings along the Waterfront that are all strung together with an elevated, outdoor jogging track. The other proposed buildings could be for living, working, or parking cars. The large south-facing walls act as thermal masses, and they are complimented with columns on the North side that allow indirect daylight to enter into the suspended elements of the buildings.

There are five floors in this building. The entry floor plan touches the city, and the main lobby aligns with Arena Stage across the street. The other floor plans include the Staff / Water Entry Level, the Competition Level, Diving/Spectator Level, and the Leisure/Jogging Track Level.”



Comfort

The thesis project began with an investigation of comfort. Comfort can be sensed in many ways.

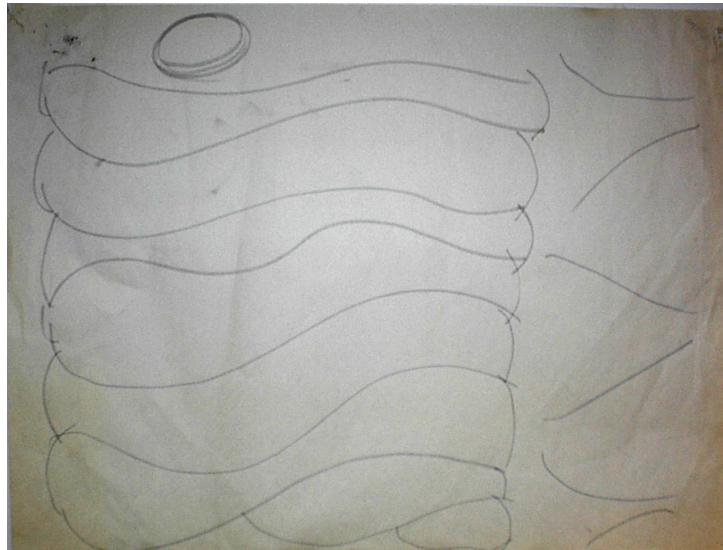

Pillows and feathers. A sketch with comfort in mind.

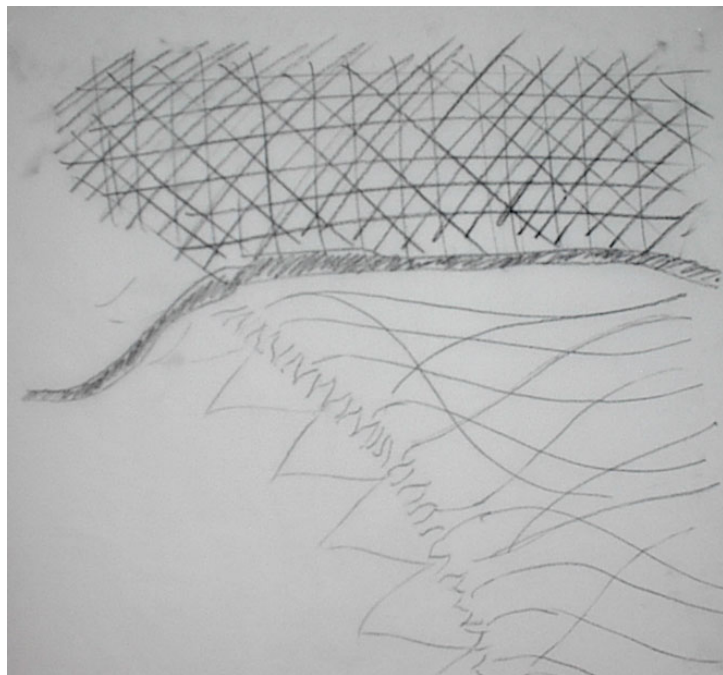

Diagram of the city. Noisy and fast-paced parts of the city are represented with many close-knit lines. The Southwest quadrant, however, is represented with softer lines that indicate the quiet, slower-paced nature of the area.



A pair of khaki pants can be comfortable. The folds of the soft fabric can be overlaid as a diagram of the city.

The character of Southwest D.C. distinguishes the area from the other three quadrants of the city. Specifically, the Waterfront along Maine Avenue embodies a unique character that is fortified with nautical imagery. The urban planning strategies that were introduced to the quadrant through urban renewal in the 1960's left object buildings in a park-like setting. The fish market is one of the most vibrant attractions on the waterfront. Arena Stage is also an active landmark that will also be undergoing physical changes in the coming years.



Collage of the Character of Maine Avenue.



Current map from the D.C. Office of Planning. Current plans exist of a new vision for the Southwest Waterfront. This thesis expands upon the basic planning ideas that have been set forth.

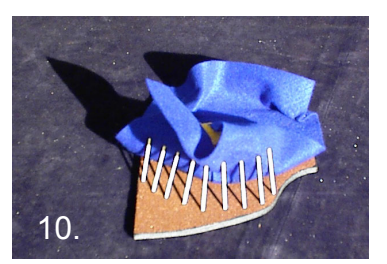
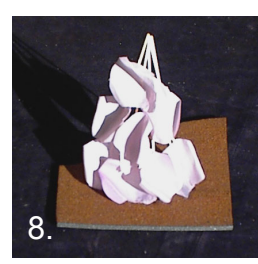

Site Interpretation Models

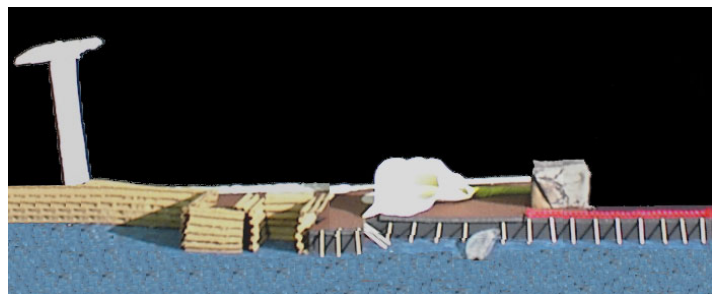
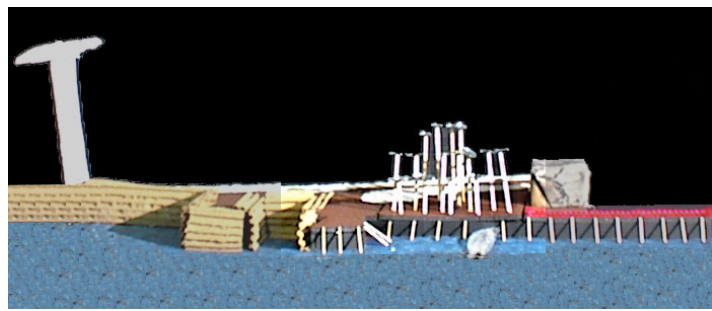
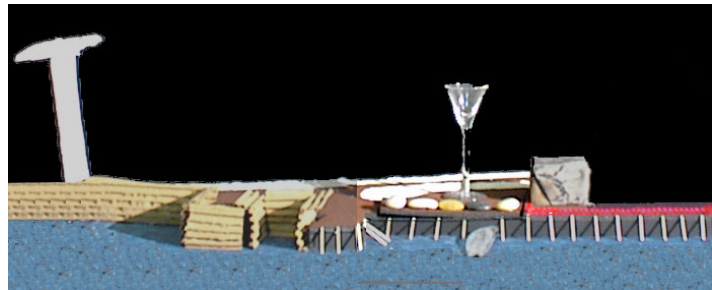
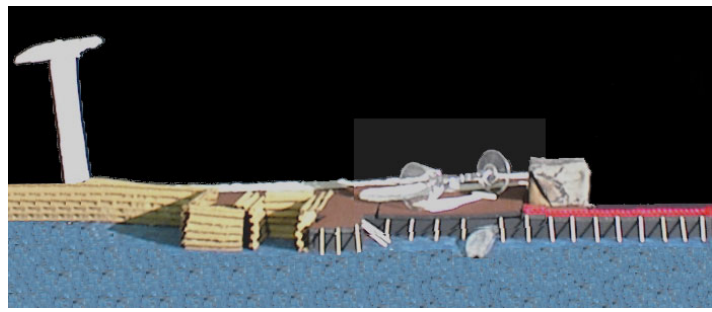
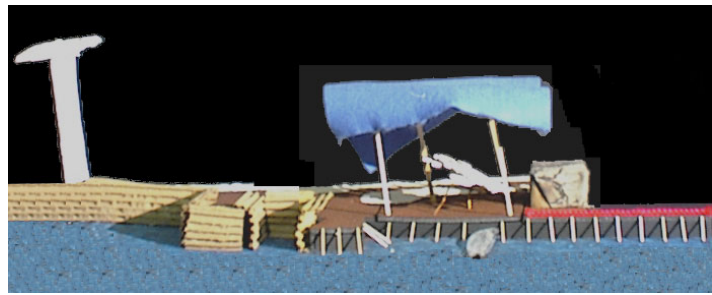
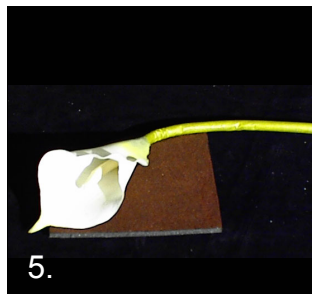
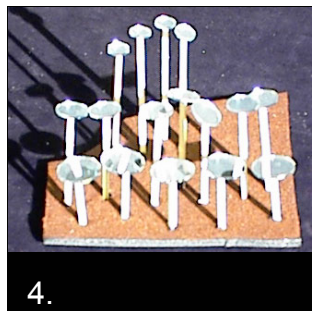
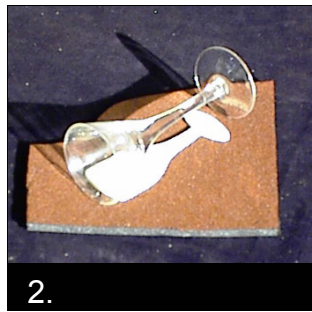
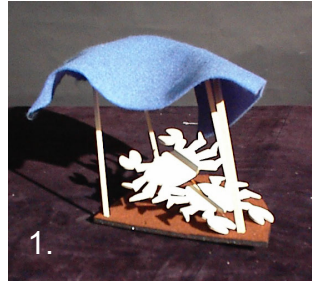

- 1. Felt
- Bass Wood
- Copper Wire
- Wood Fish Cutouts

- 2. Bass Wood
- Wine Glass
- 7. Treasure Bag
- Polished Stones

- 3. Wine Glass
- Polished Stones
- 8. Bass Wood
- Flower Petals

- 4. Bass Wood
- Round Mirrors
- 9. Treasure Box
- Net
- Polished Stones

- 5. Artificial Flower
- 10. Felt
- Bass Wood
- Sponge

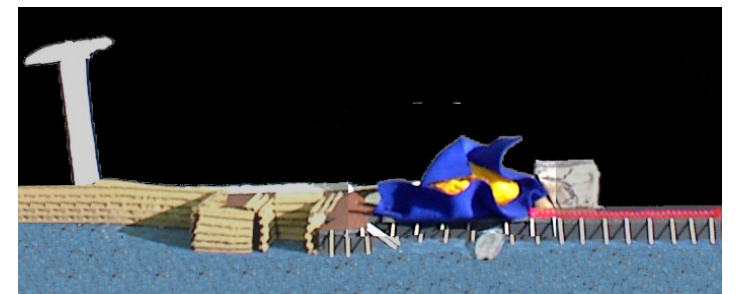
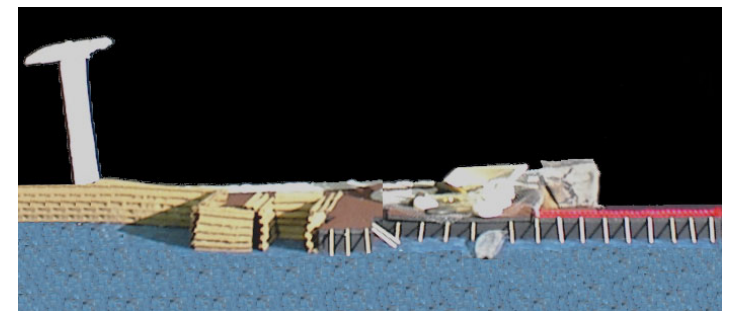
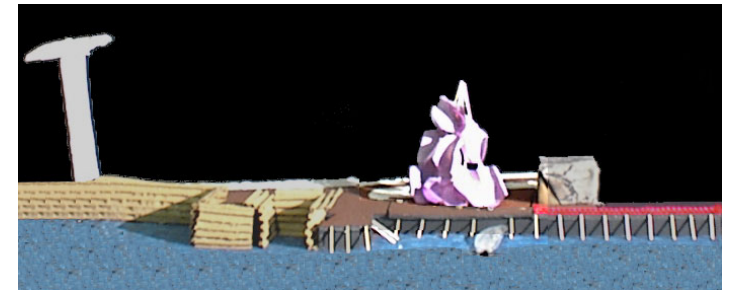
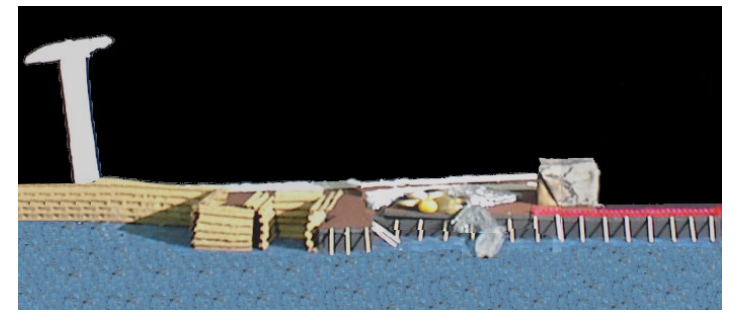
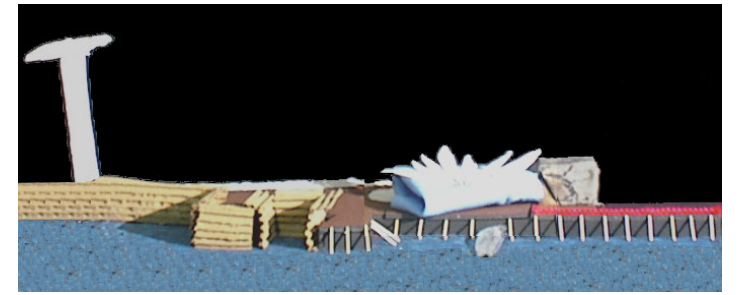

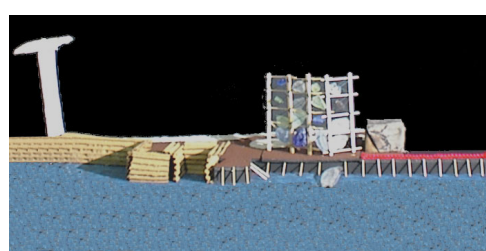

11.
Beach Glass
Bass Wood
Thread

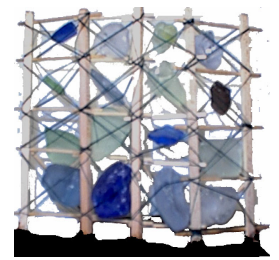
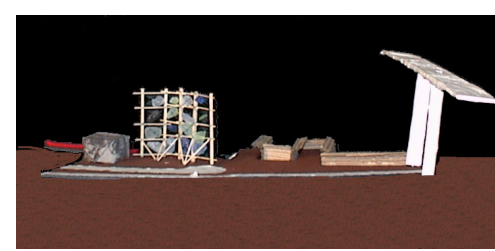

Chapter 2

Frankenstein Process: Family Tree

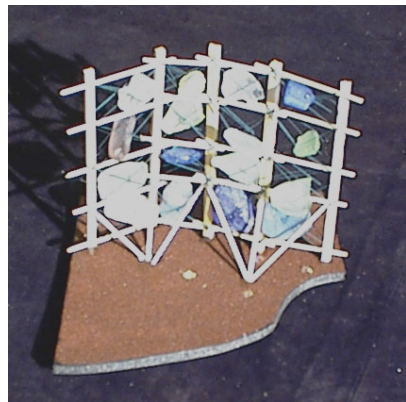

The 'Frankenstein Process,' taught by Ray Mullican, is a way of manipulating architectural images to generate new possibilities for buildings. The Process is based on creating new generations by selecting desirable elements from previous generations and applying mutations to them. A family tree demonstrates lineage of the "family."

The beach glass model is the "parent."



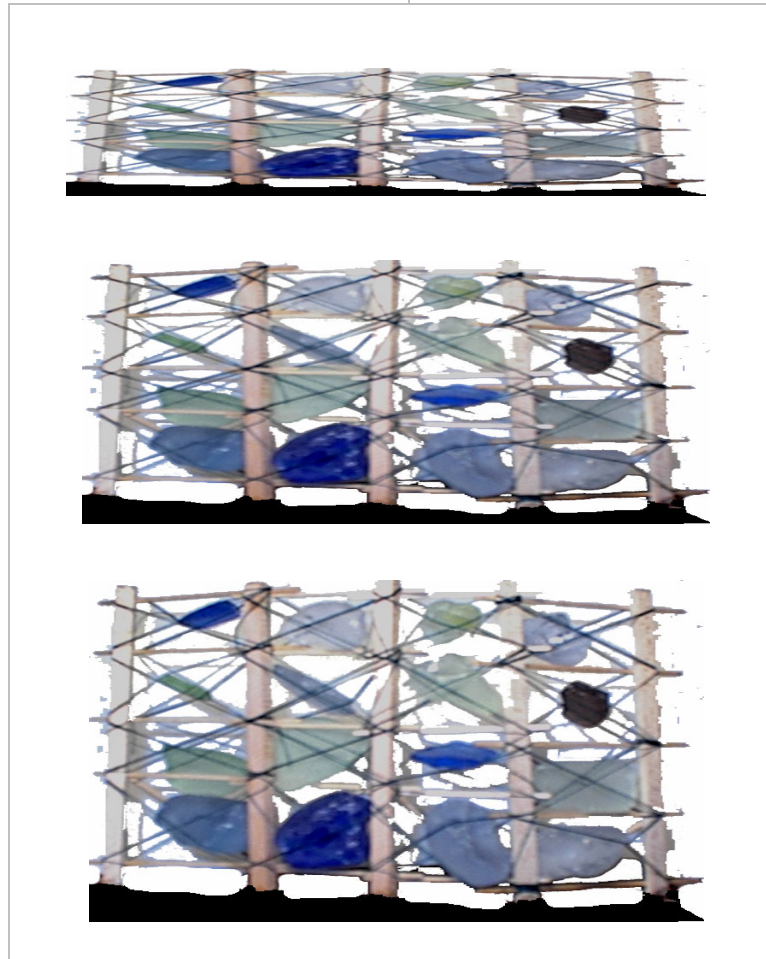

Stretch Horizontal

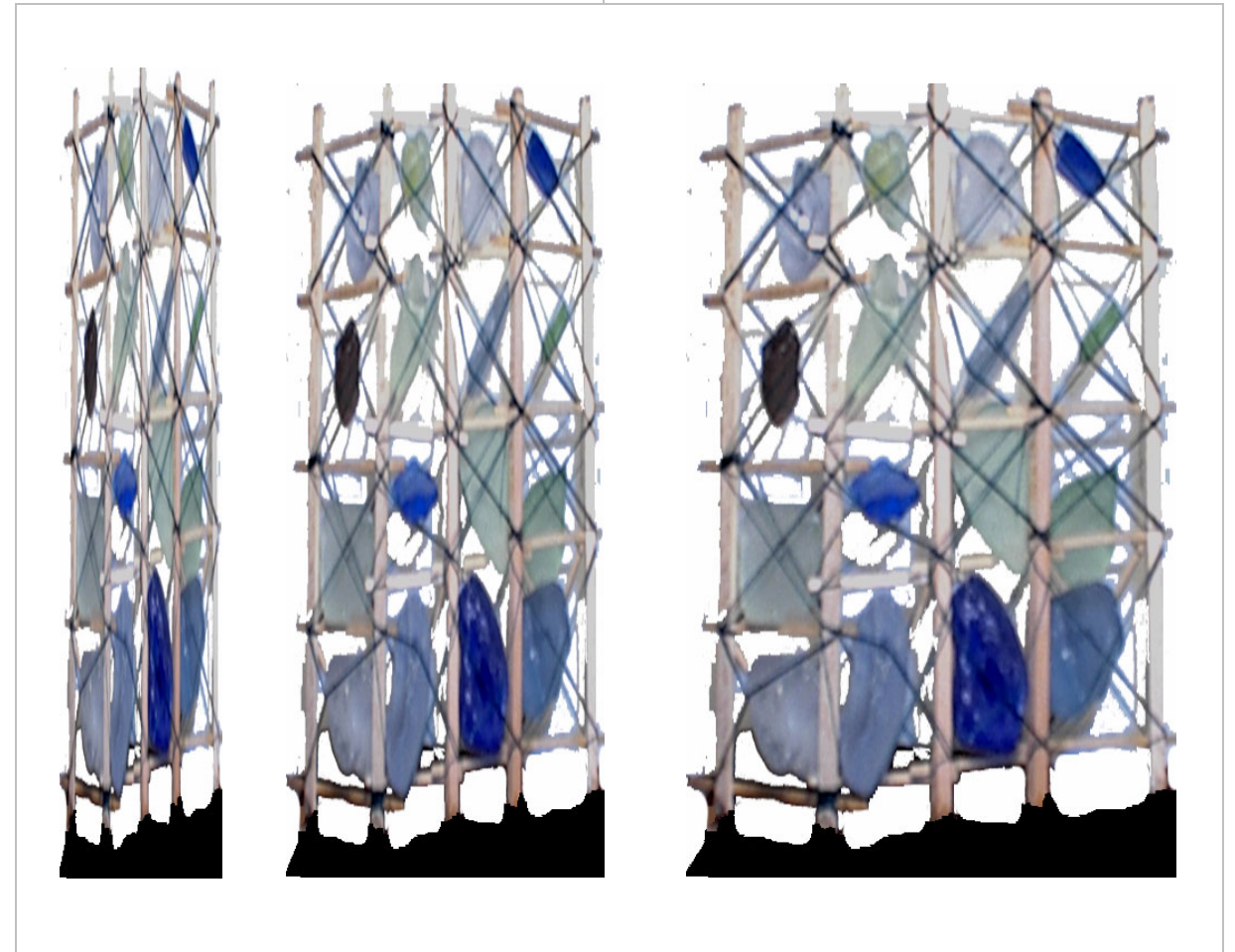

Stretch Vertical

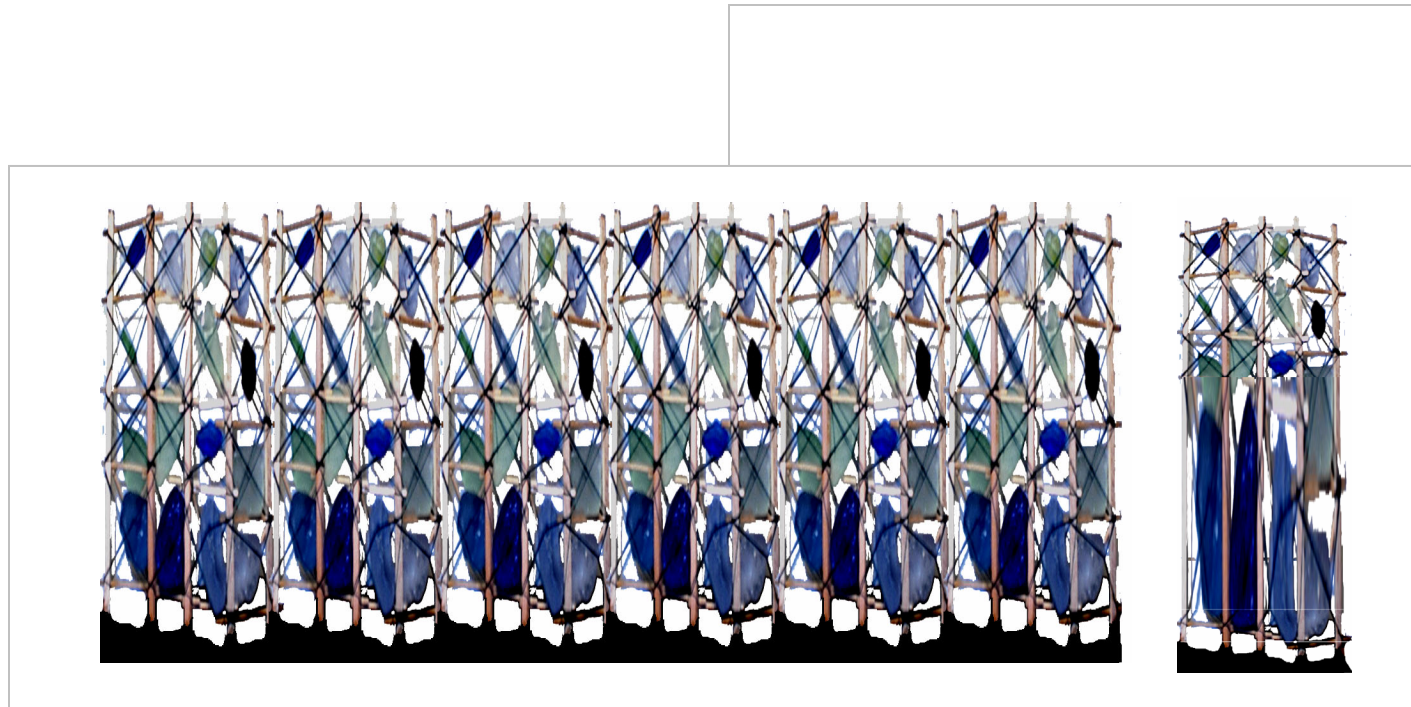

Multiply Horizontal, Stretch Selection Vertical

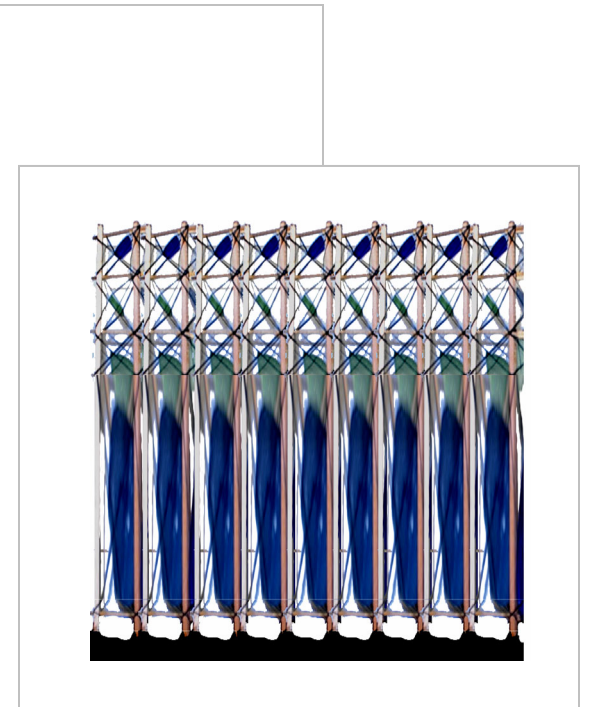

Slice Vertical, Multiply Horizontal

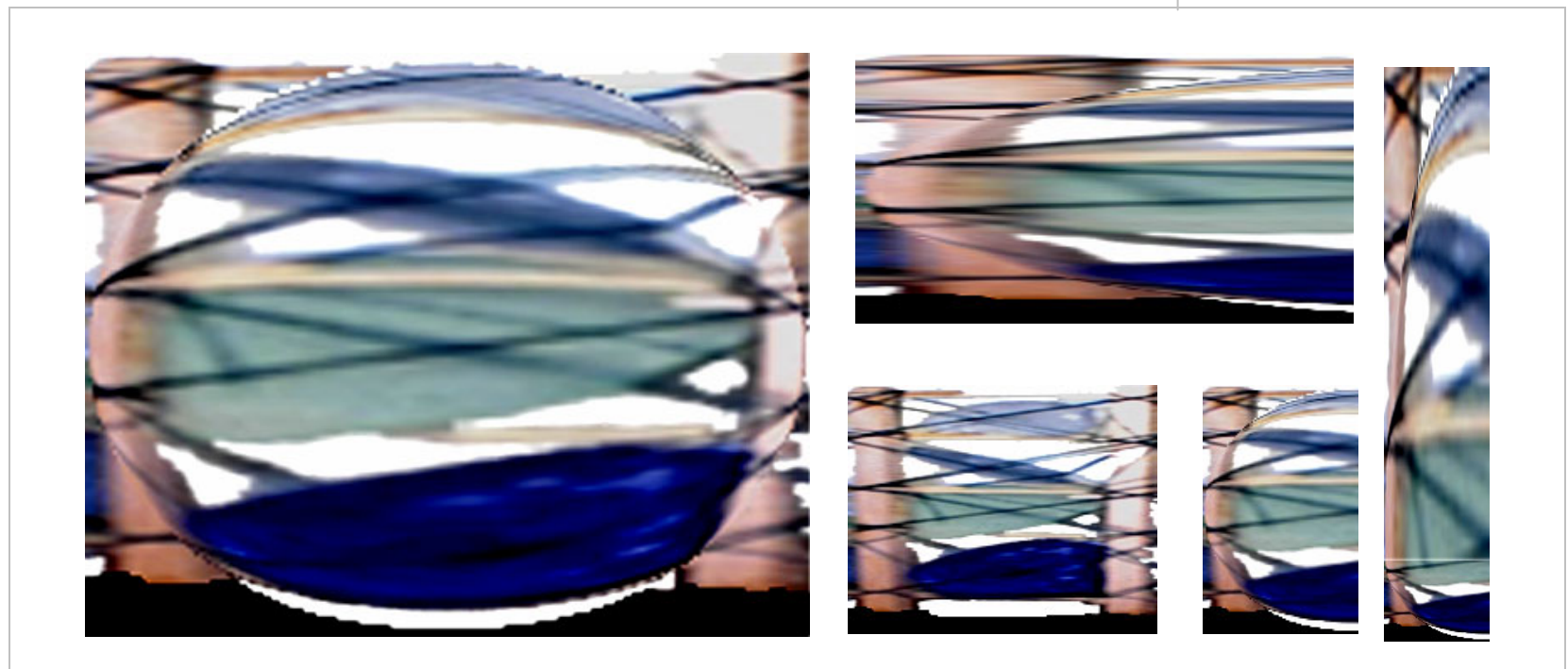

Slice, Stretch Horizontal and Vertical

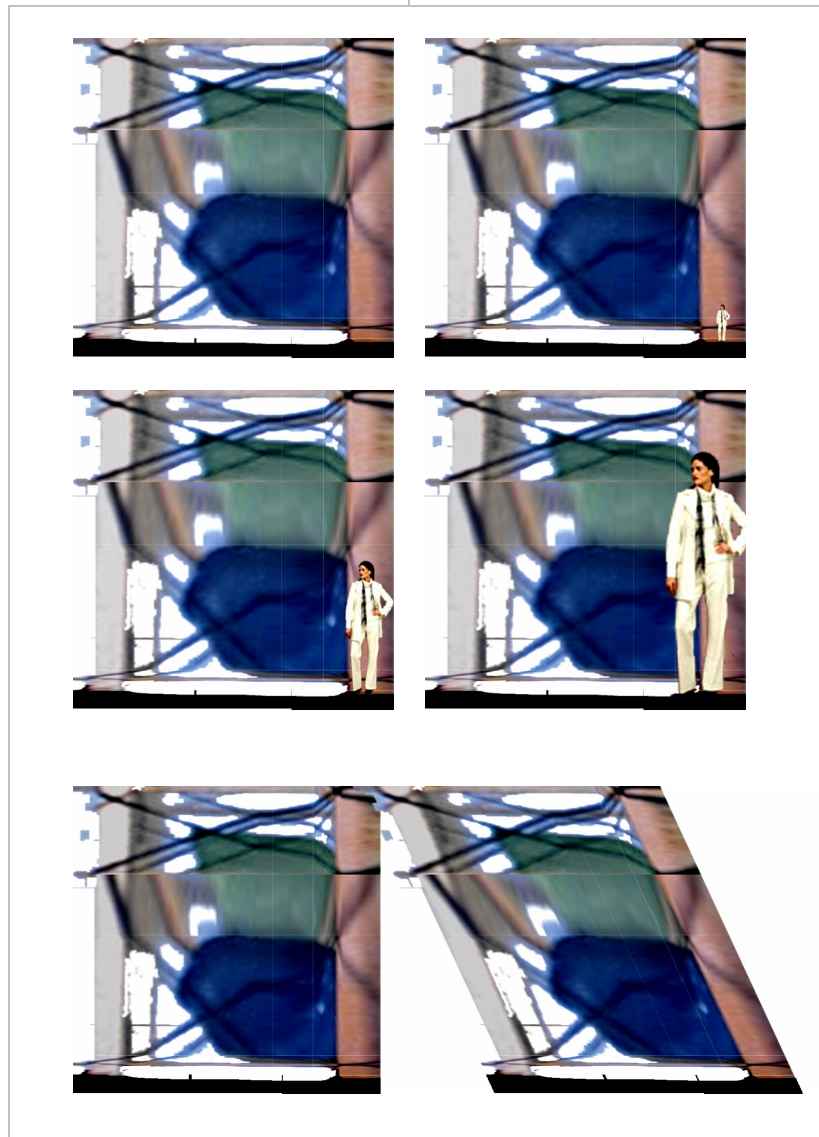

Slice, Enlarge, Skew

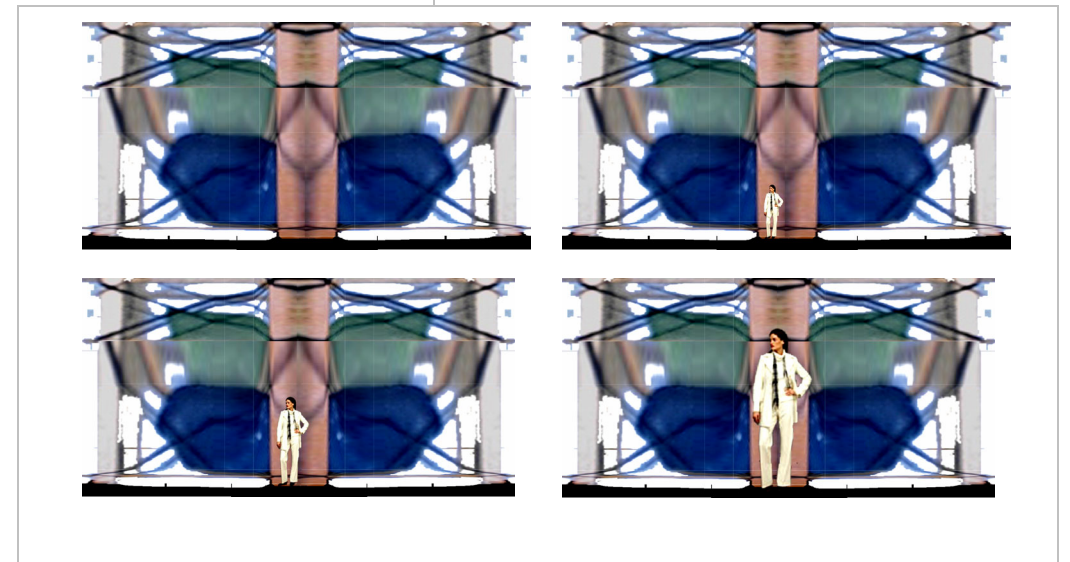

Mirror

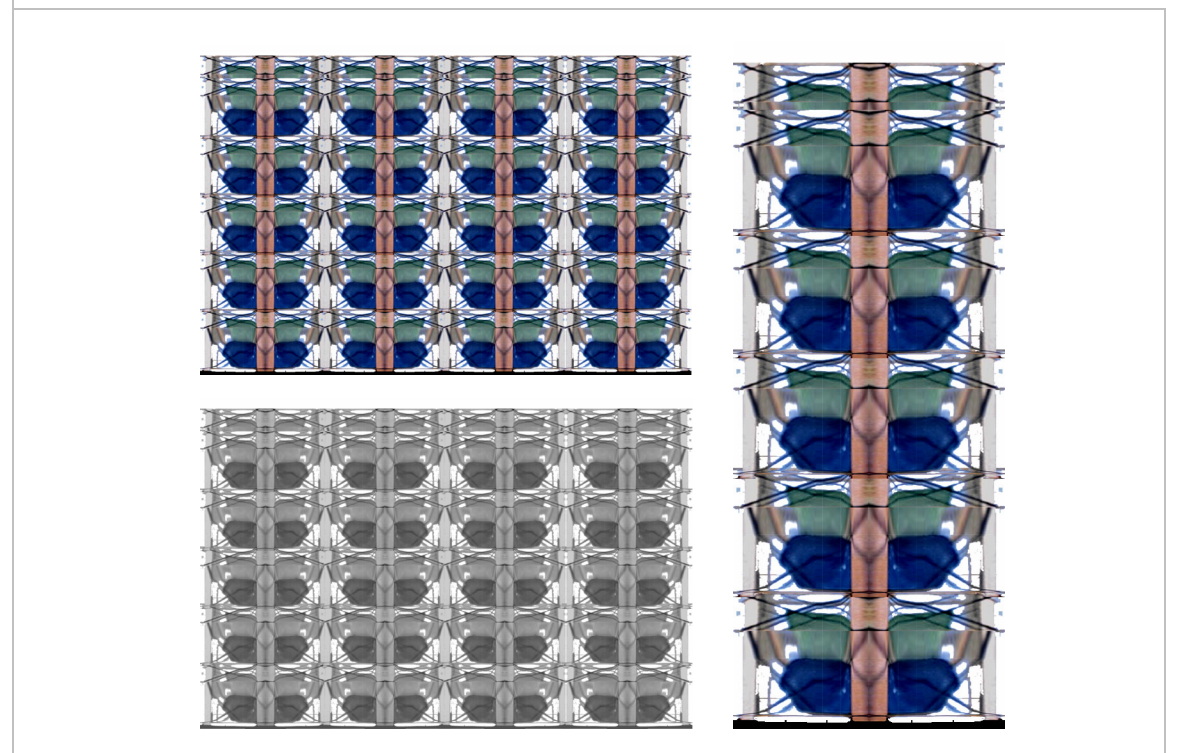

Multiply Horizontal and Vertical

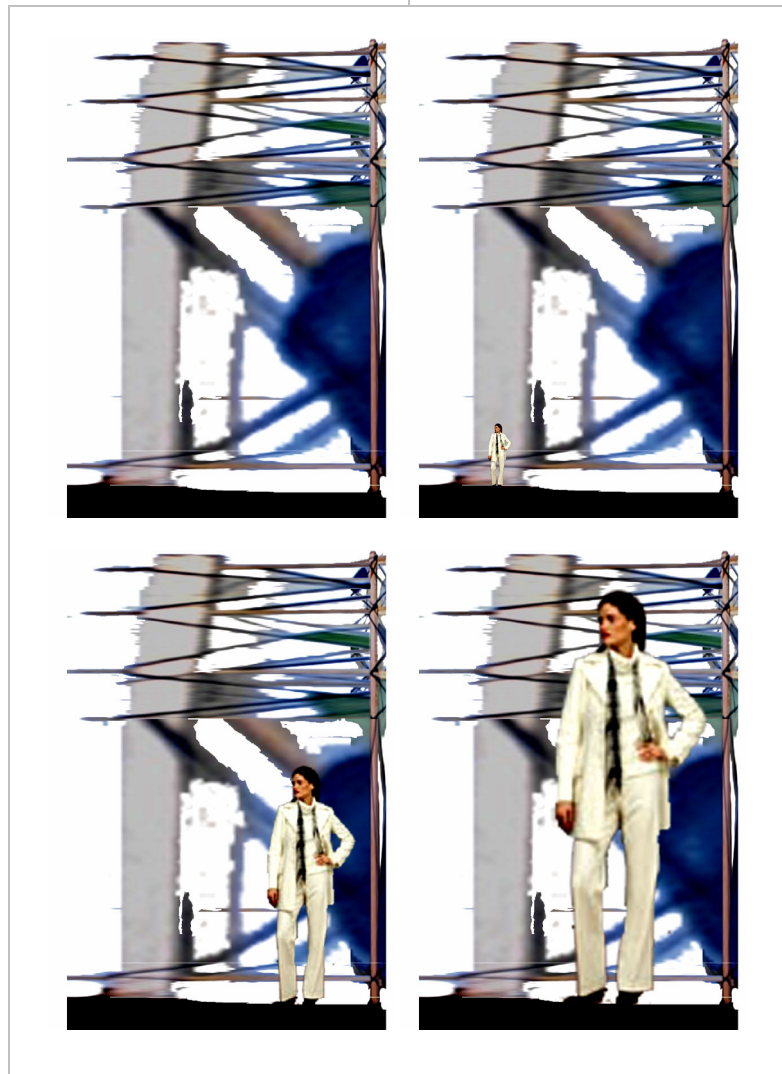

Stretch Selection Horizontal and Vertical

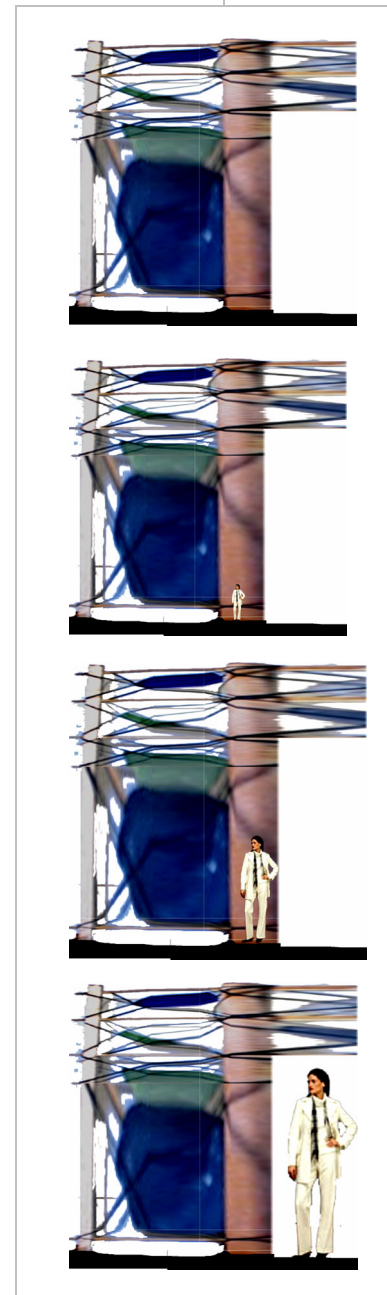

Stretch Horizontal and Vertical

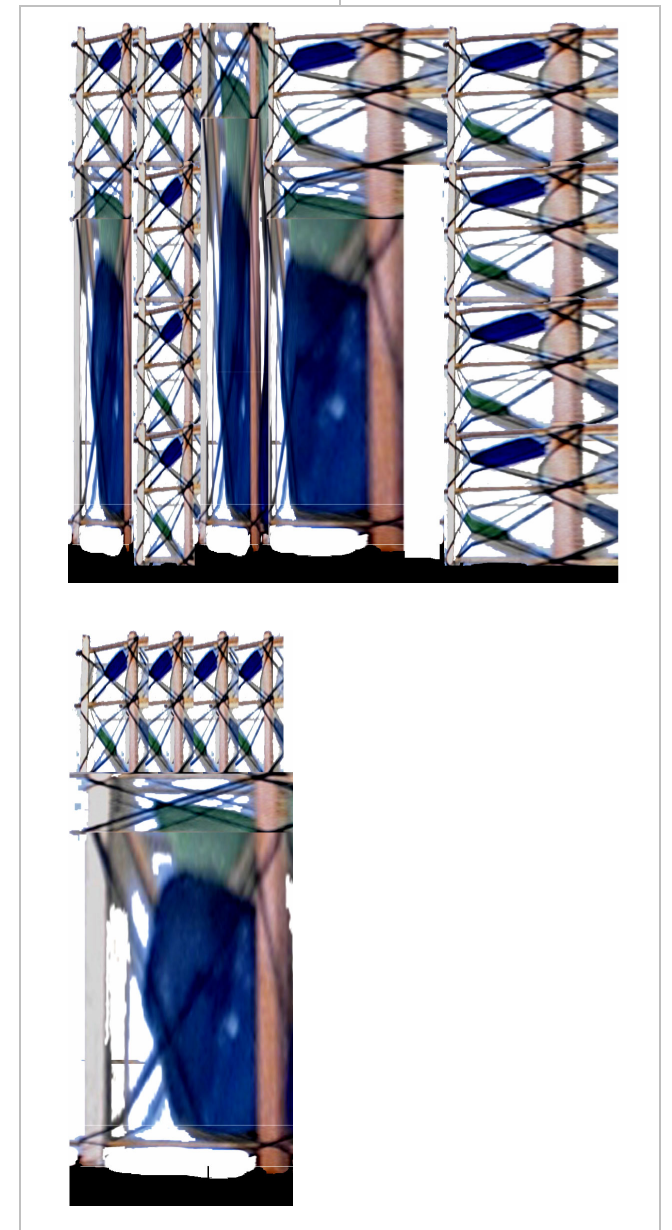

Integrate Previous Generations, Stretch Vertical

(This image was adopted as the conceptual section for the project. It was the starting point for the design and the test for many decisions.)

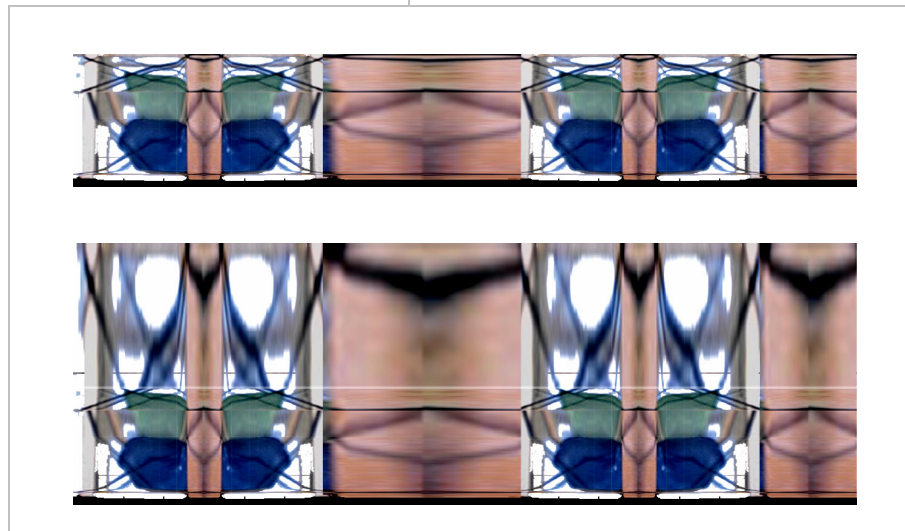

Mirror, Multiply, Stretch Selection Horizontal and Vertical

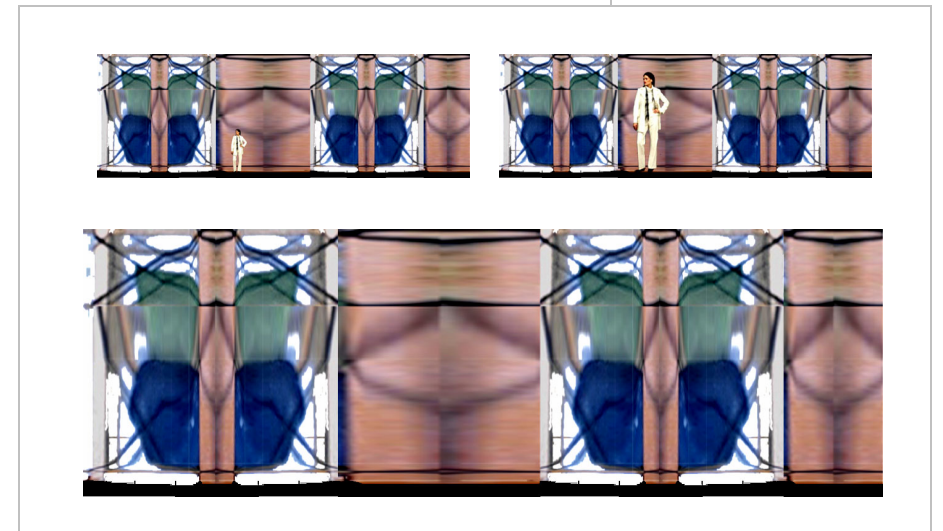

Mirror, Multiply, Stretch Selection Horizontal and Vertical

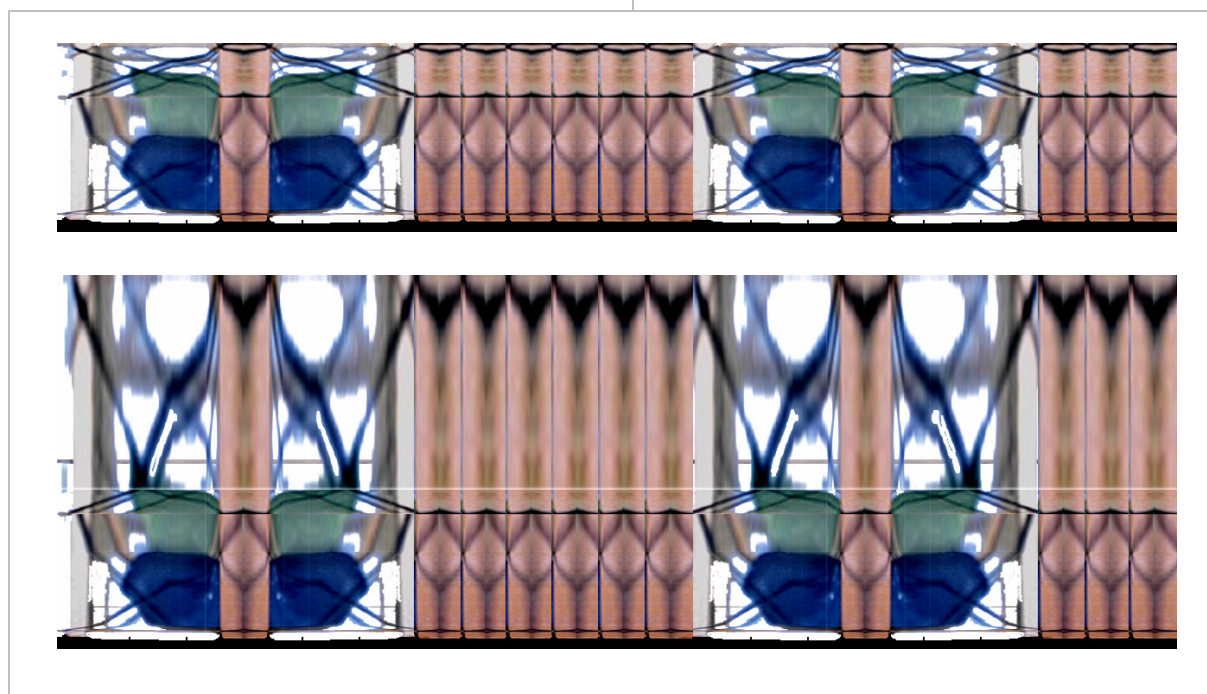

Mirror, Multiply, Stretch Selection Horizontal and Vertical



Slice, Stretch Vertical

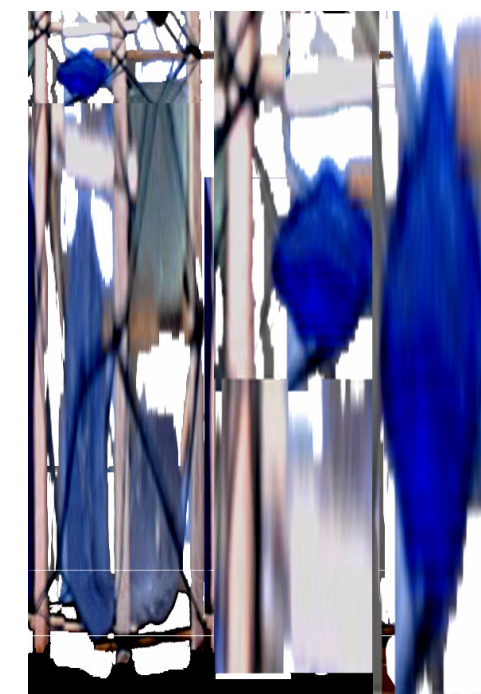
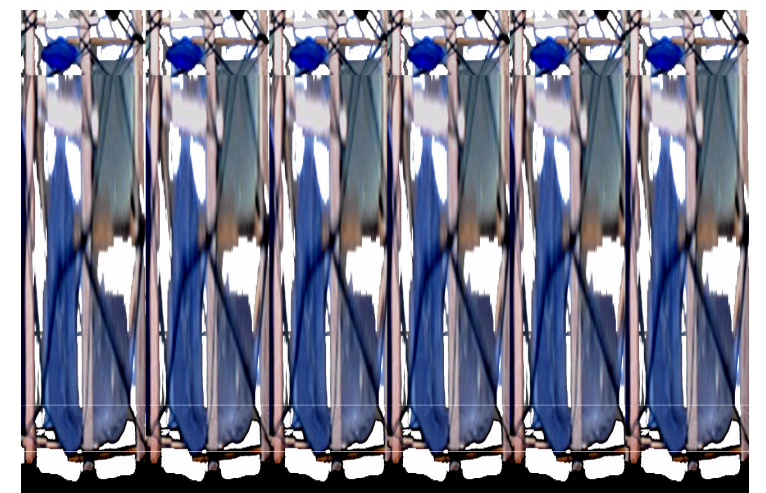

Multiply Horizontal, Stretch Vertical

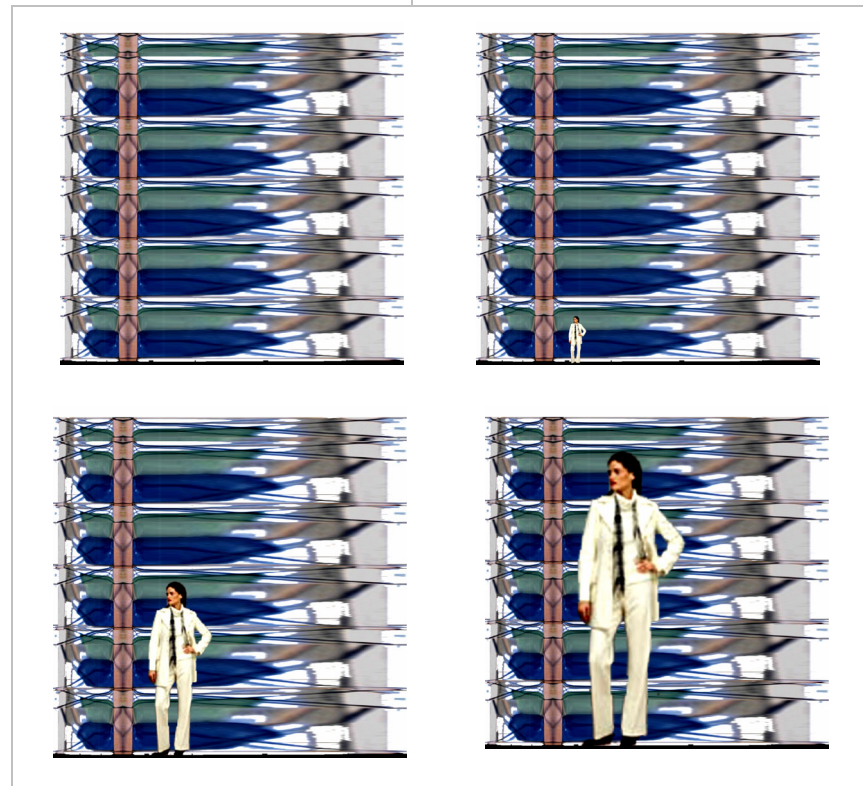

Stretch Horizontal

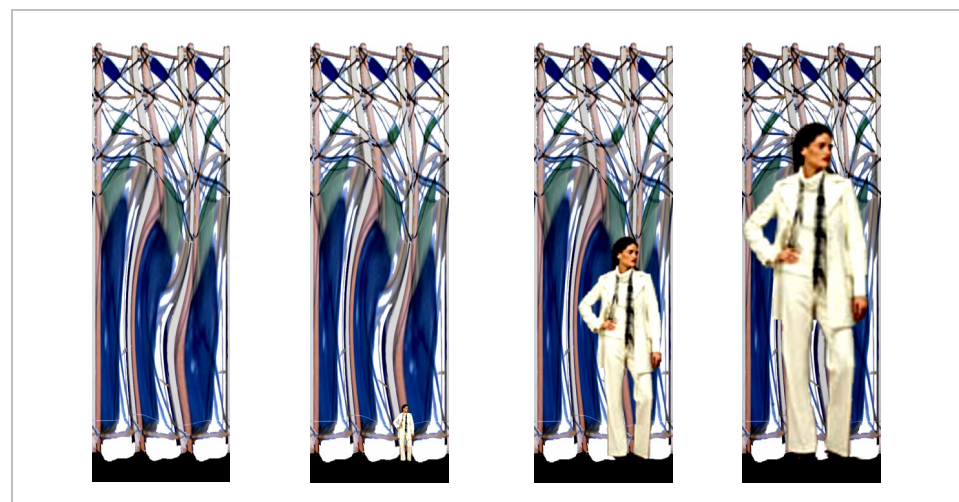

Swirl

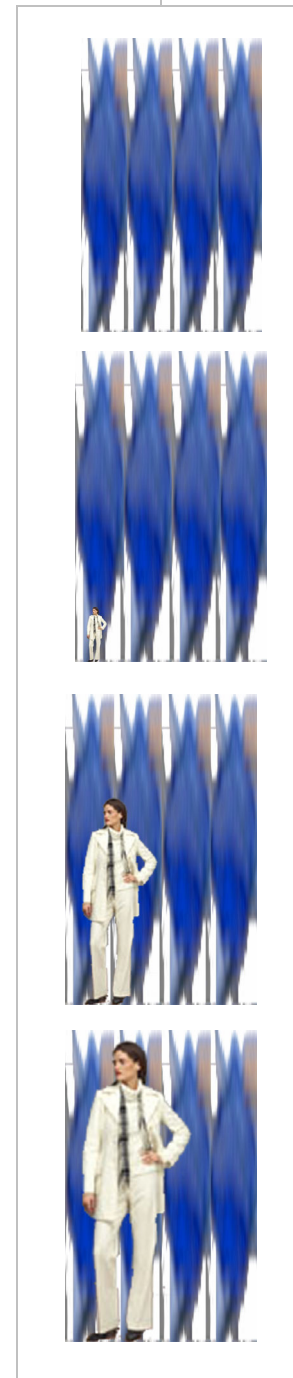

Slice, Multiply Horizontal, Stretch Vertical

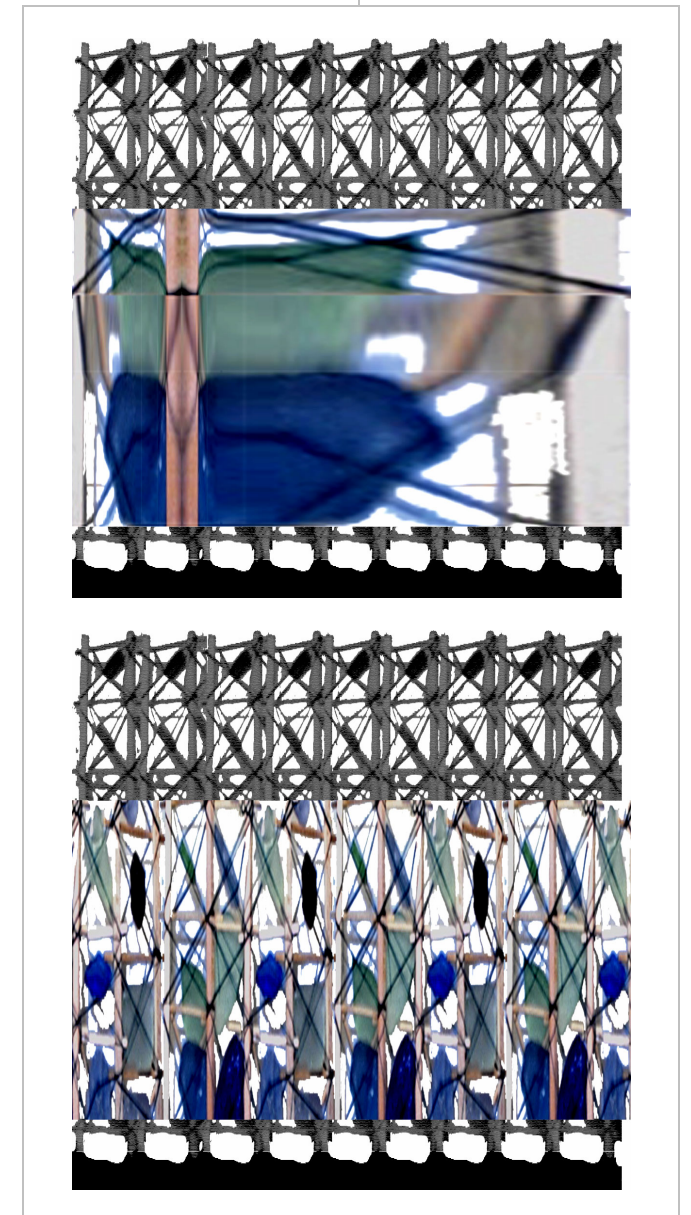

Integrate Previous Generations, Stretch, Multiply Horizontal

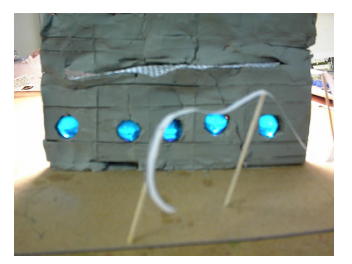
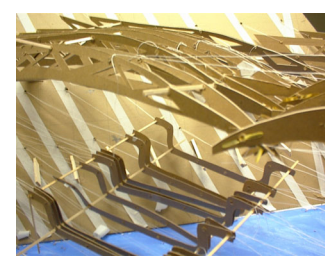
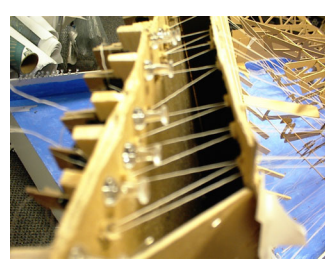
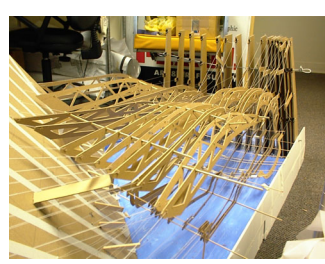

Chapter 3

Study Models

Study models were crucial to the understanding of gravity's role in shaping the building.

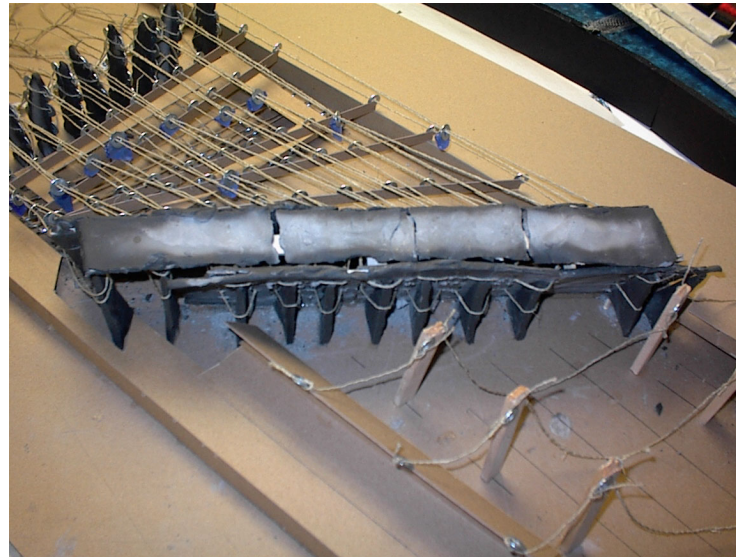

Mid-project study model. It is composed of clay, yarn, washers, cardboard, and beach glass.

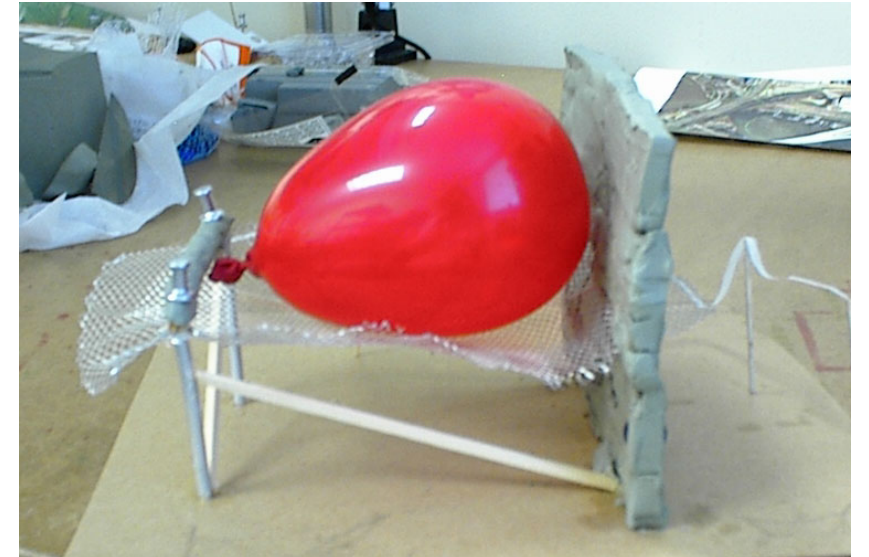

Water balloon model. In order to test a conceptual model of a wall and columns, filled and unfilled water balloons were placed on a net connecting the structural elements.

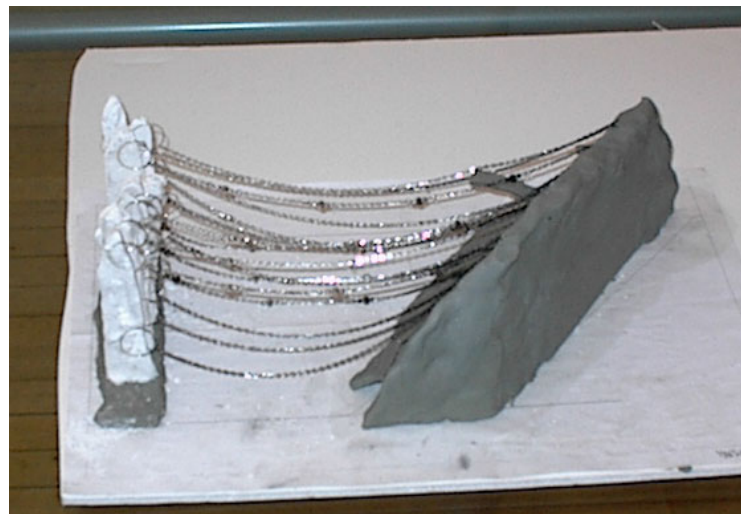

Chain model. Simple chains demonstrate the shapes that the pools would take. The lower chains represent the lap pool, the middle chains represent the diving well, and the upper chains represent the cables from which the glass roof would be suspended.

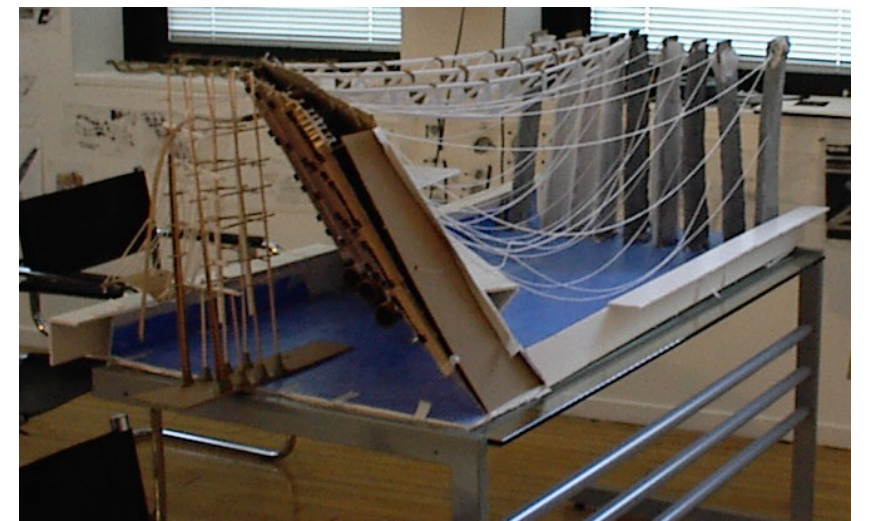

Study model at 1/8" = 1'-0." It was assembled and disassembled many times. It was a true lesson in tension, and it allowed a study of the project at a larger scale. At various times throughout the project, it was composed of cardboard, foam core, paper mache, balsa wood, nylon thread, binder clips, yarn, glue, bass wood, acrylic paint, and drafting tape.

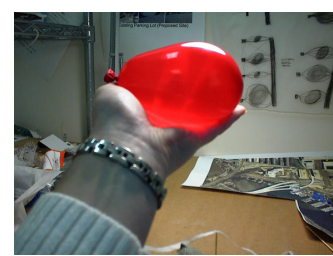

Tools

14

Much of the inspiration for this project came from found objects. For instance, the translucent properties of beach glass and marbles represented ideas for internal rooms within the building.

Metal washers and drafting dots represented connections.

Water balloons were used to test the strength of the study models. They displayed similar qualities to the beach glass and marbles.

The final drawings were rendered with solid charcoal, and the rooms within the building were erased.





The Process of Drawing

15



In order to see all of the drawings constantly, they were pinned in an interior hallway.

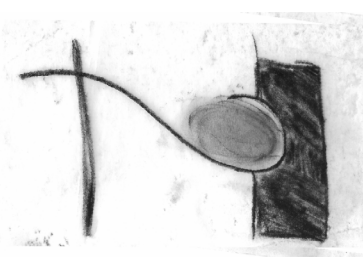
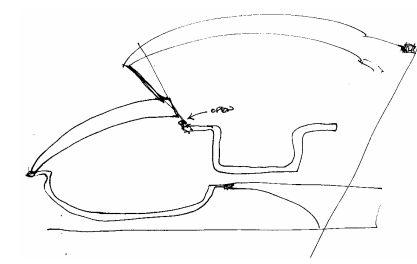
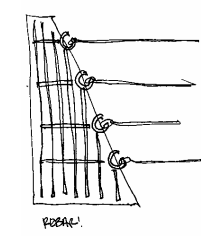
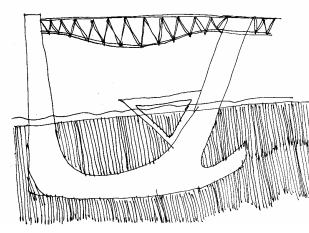
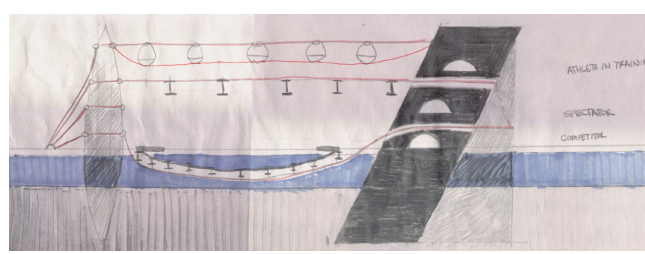

Chapter 4

Final Drawings: Section Through Diving Well & Competition Pool

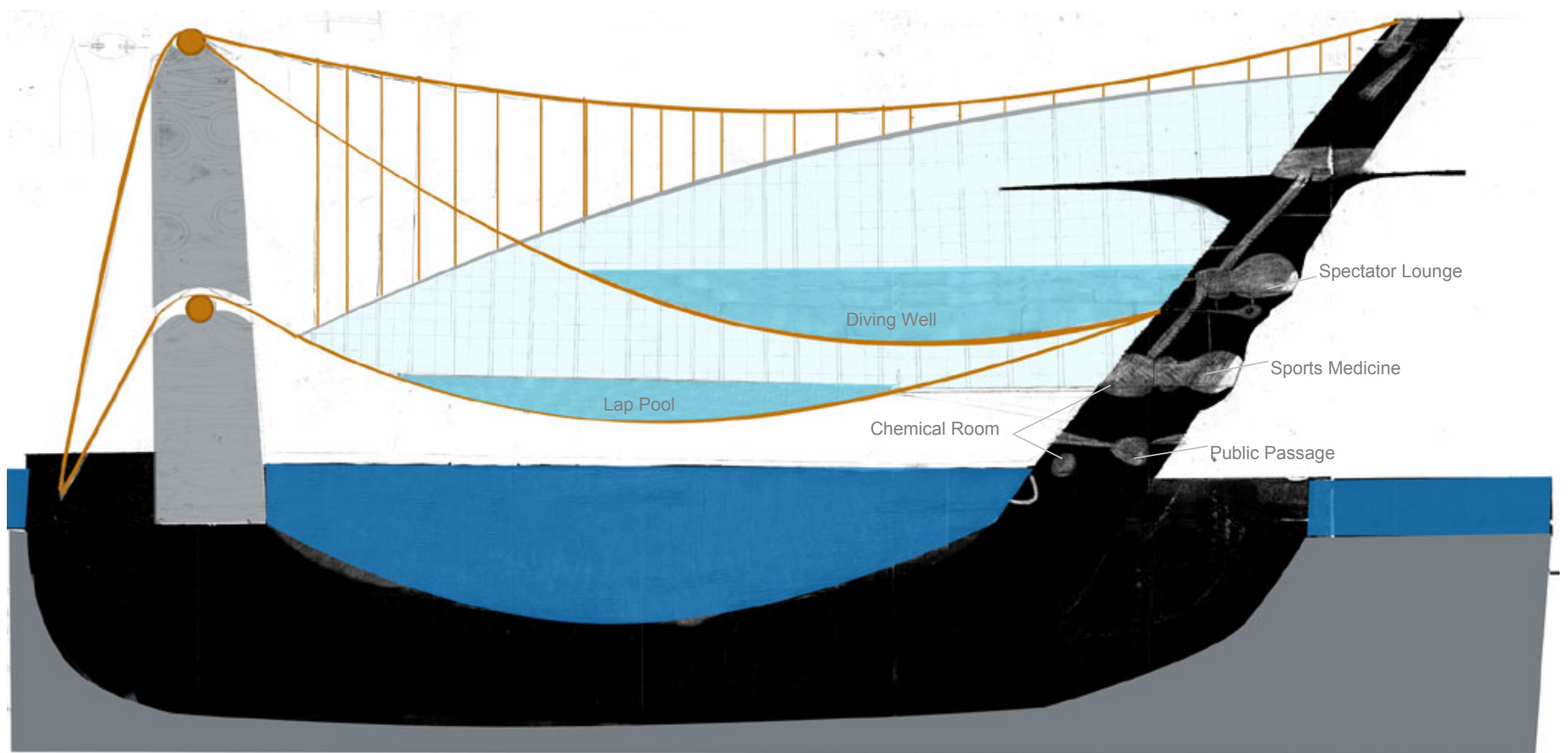
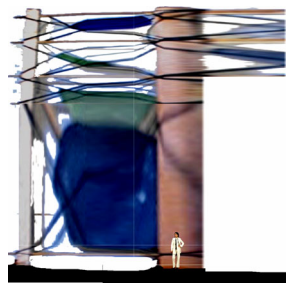
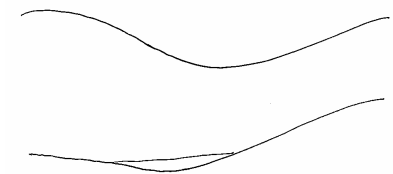
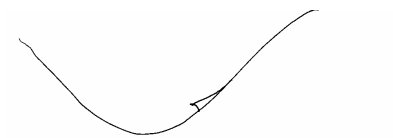
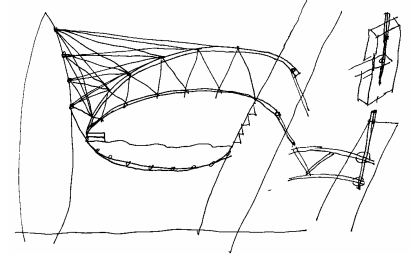
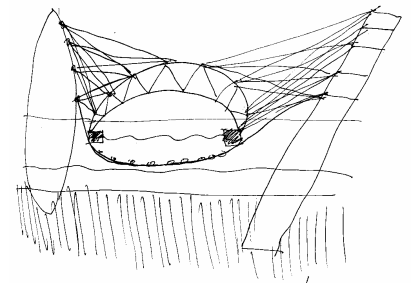
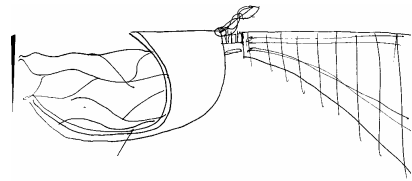

Section through the pools, looking toward the city. It demonstrates the use of cables to support the lap pool, the diving well, and the roof. Spaces are carved out of the structural "wall."

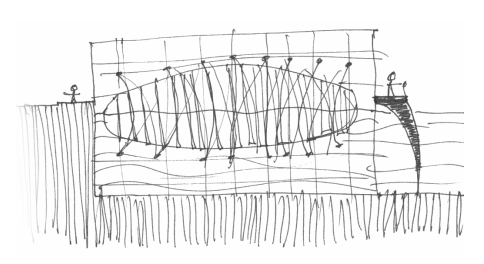
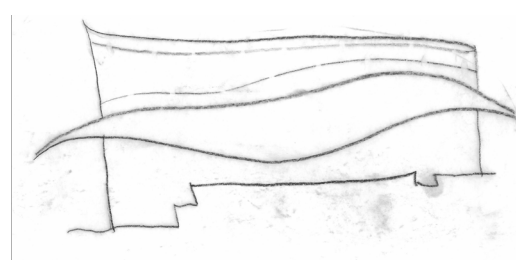
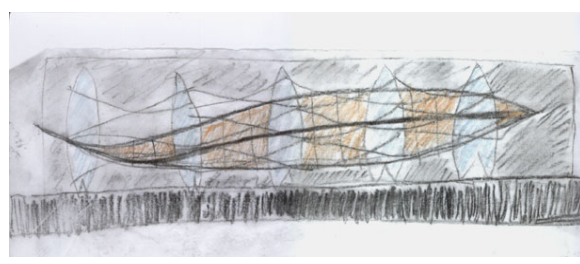

Section Through Competition Pool

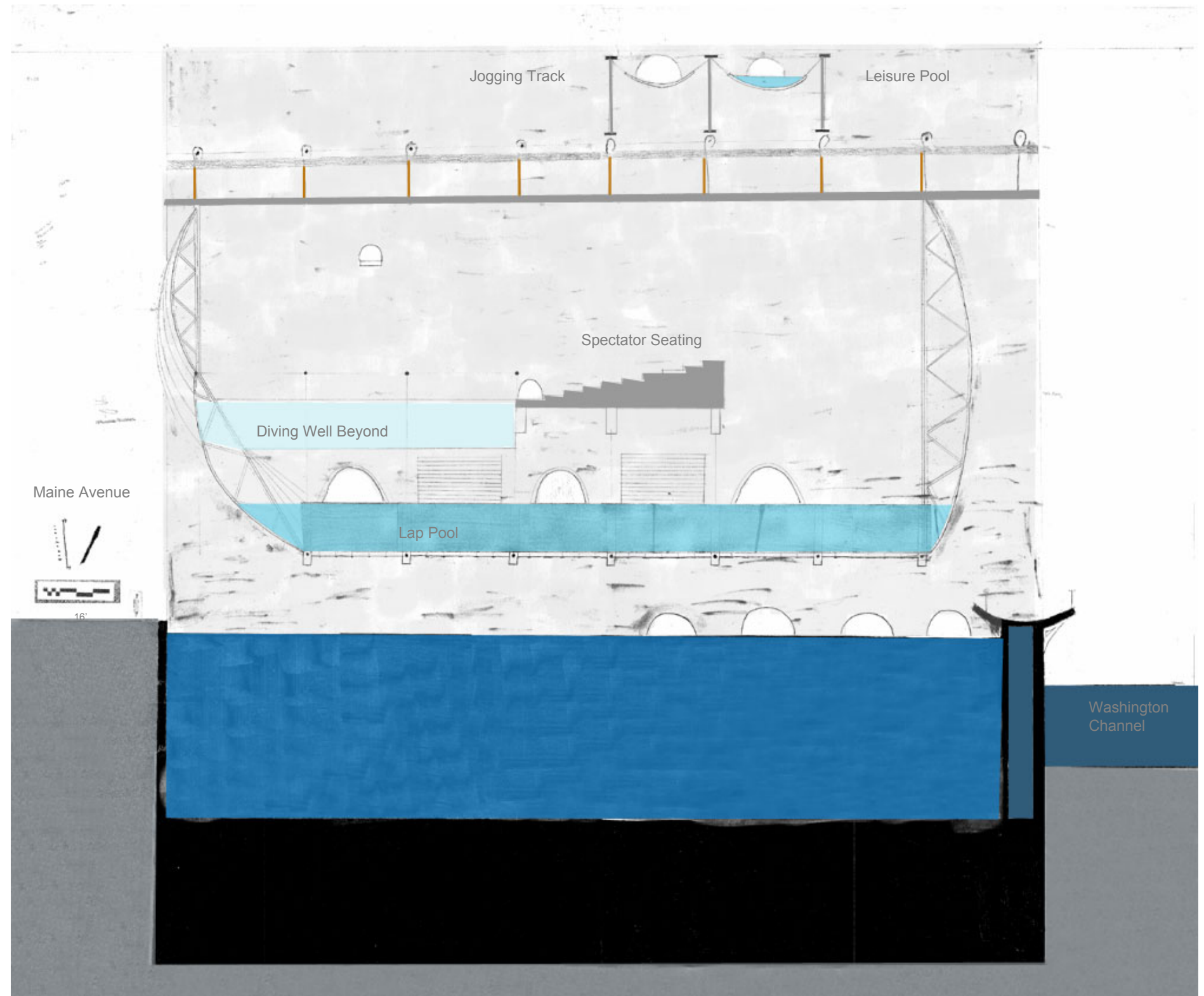
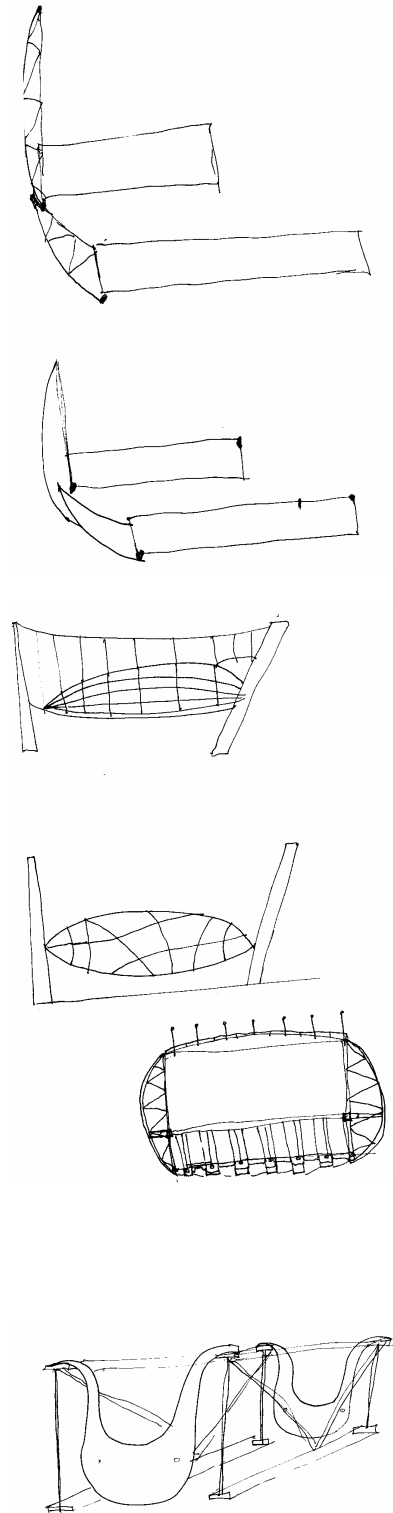

Section through the competition pool, looking at the structural "wall."

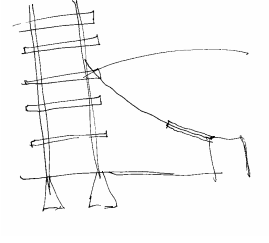
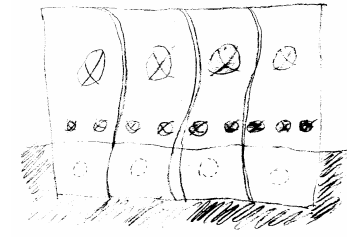
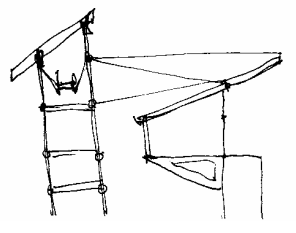
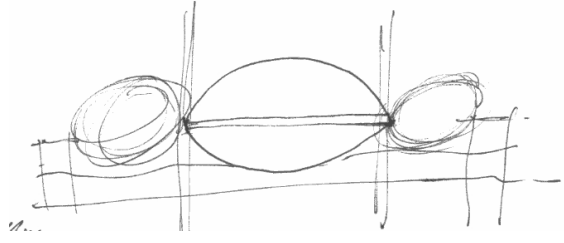

Section Through Public Space

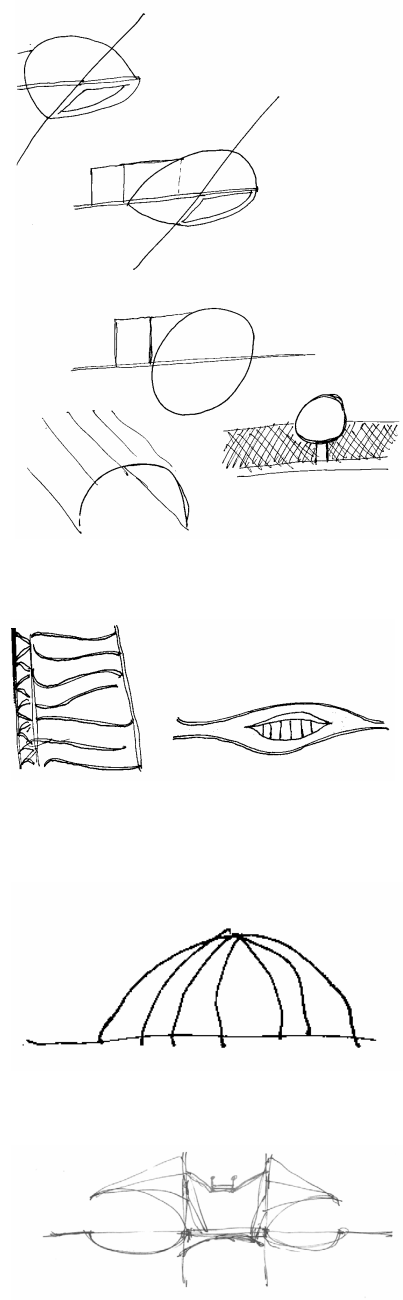
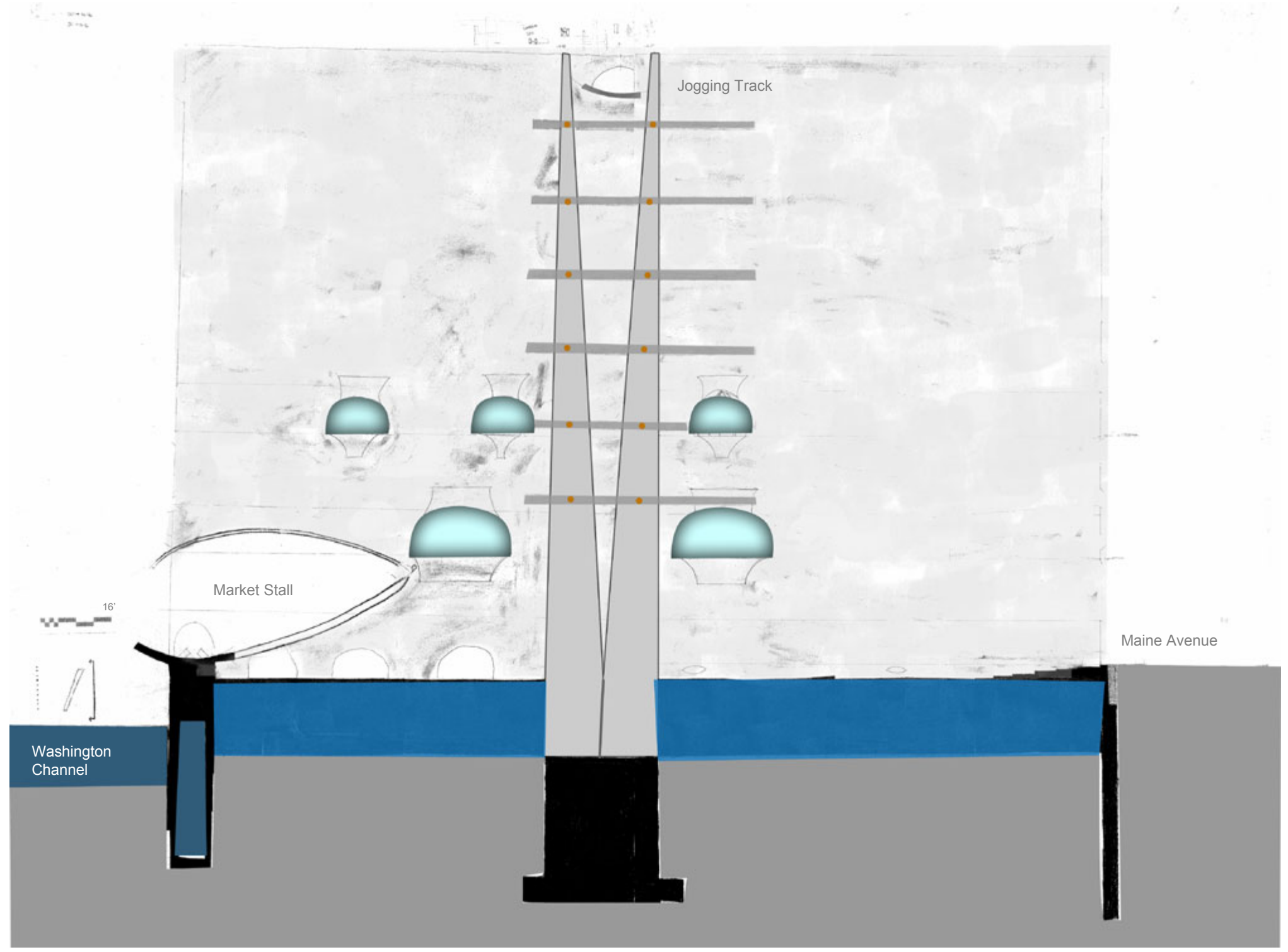

Section through the jogging track and public market stalls, looking at the South-facing side of the structural "wall."

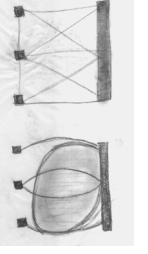
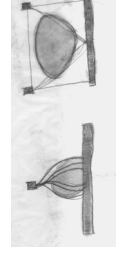
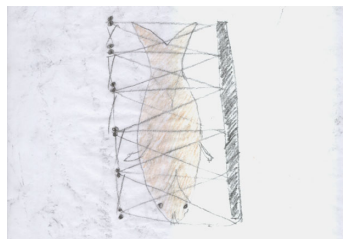
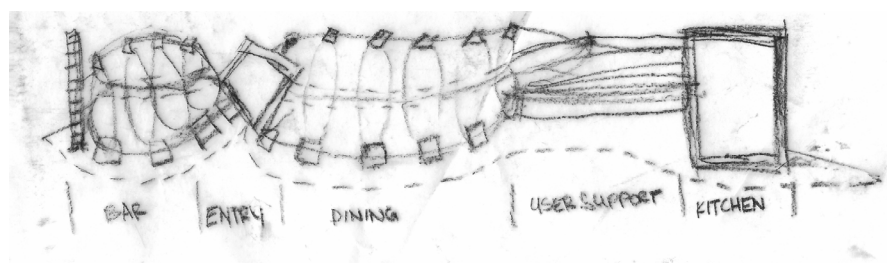

Floor Plans



Leisure / Jogging Track Level

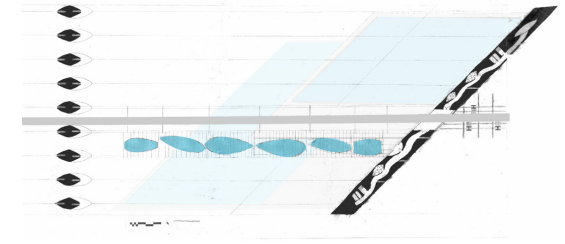

Diving Well/ Spectator Level

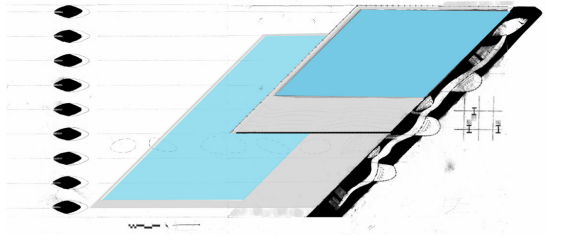

Competition Level

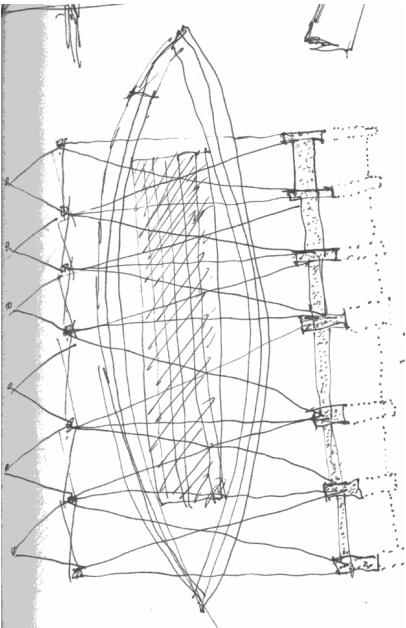
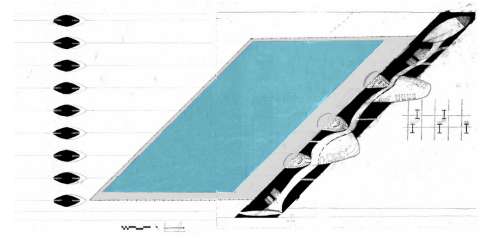

Public Level Plan

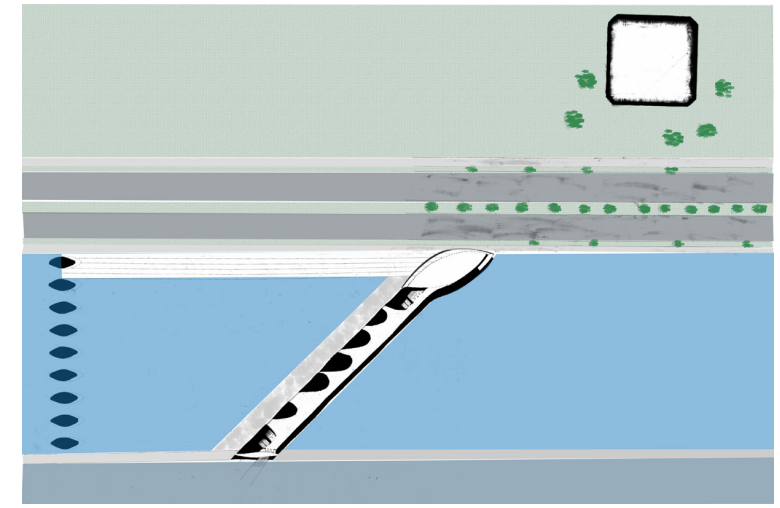

Water Entry / Staff Floor Plan

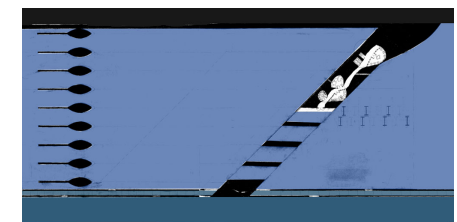

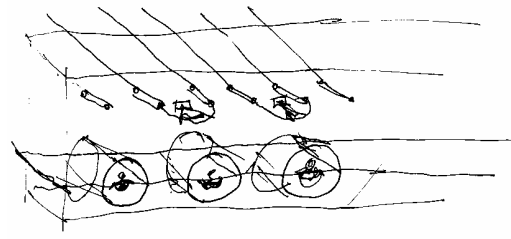

Water Entry / Staff Floor Plan

The water level is the entry point for outdoor recreation activities. It also hosts interior spaces such as storage rooms.

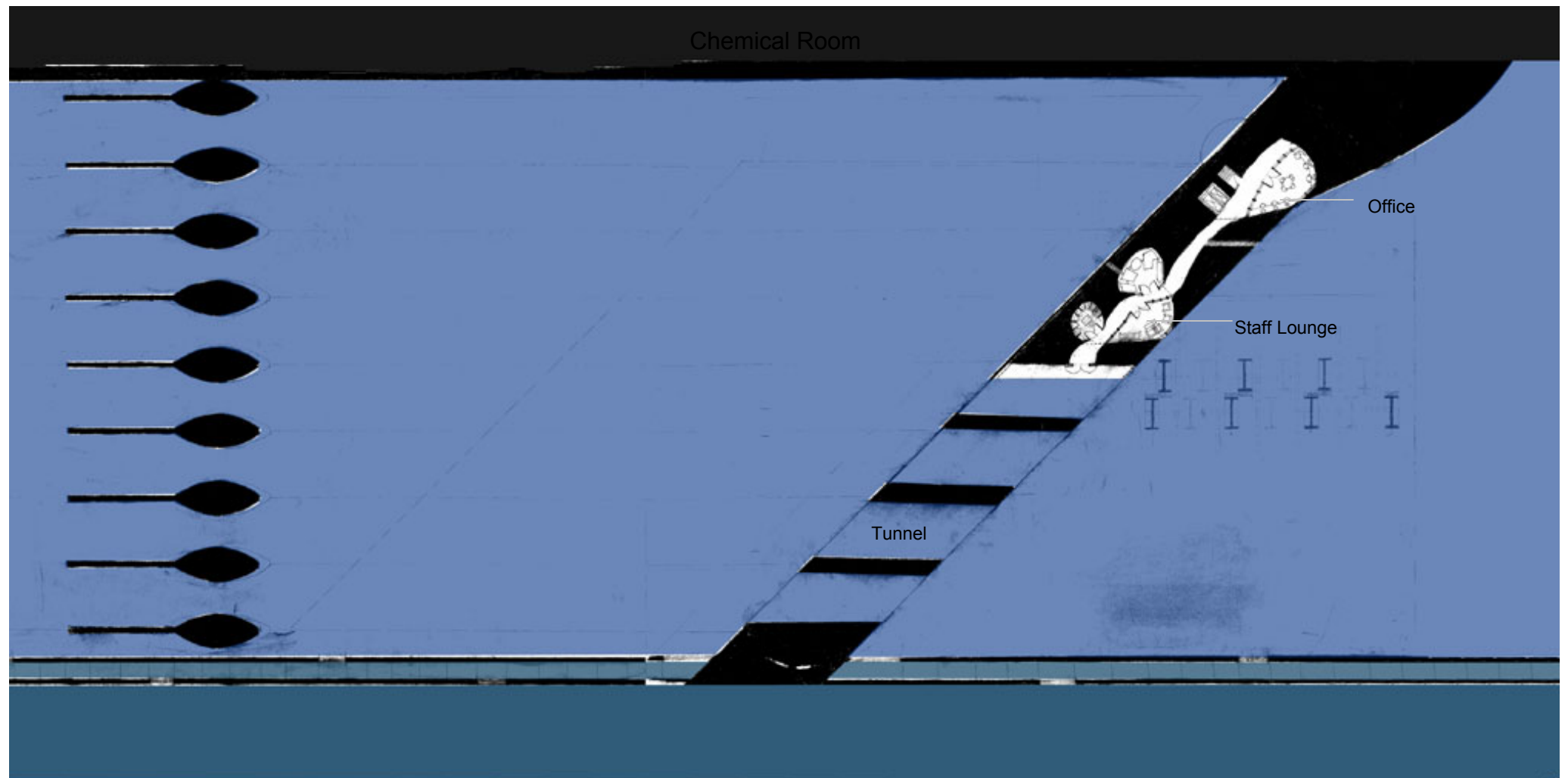

Water Level Plan

The lobby reaches out to form a metaphorical connection to Arena Stage and draw the public into it. The public level acts as a connection between Maine Avenue and the Washington Channel.

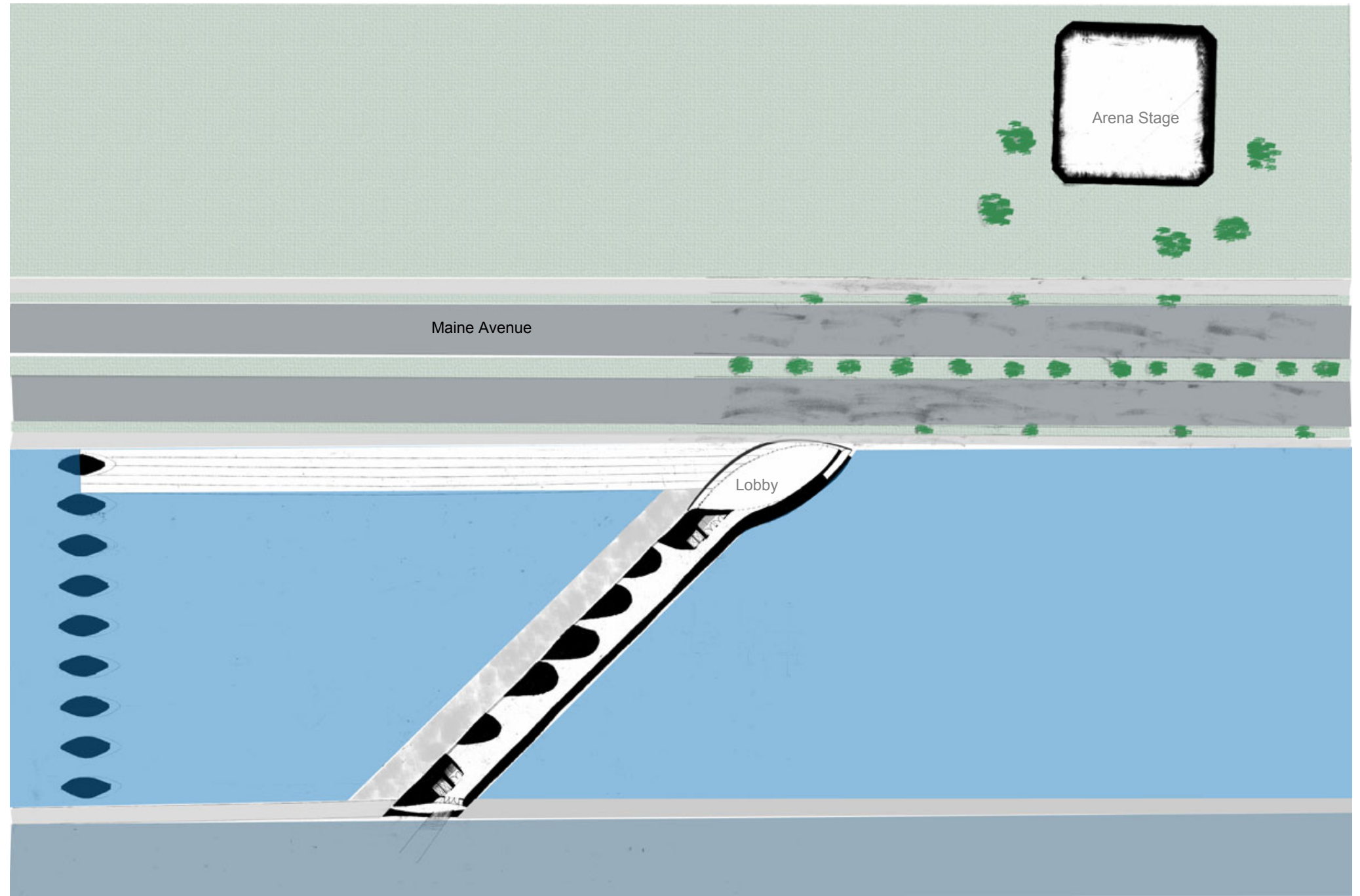

Public Level Plan



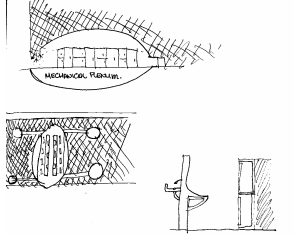
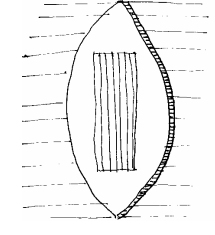
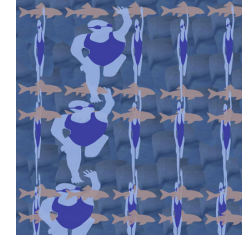
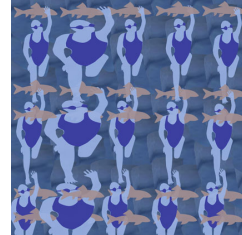
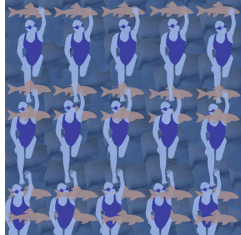
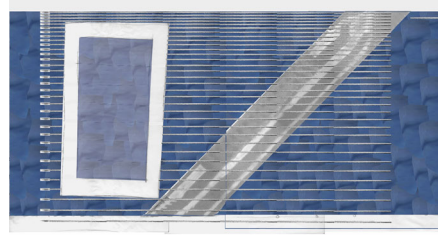

Competition Level

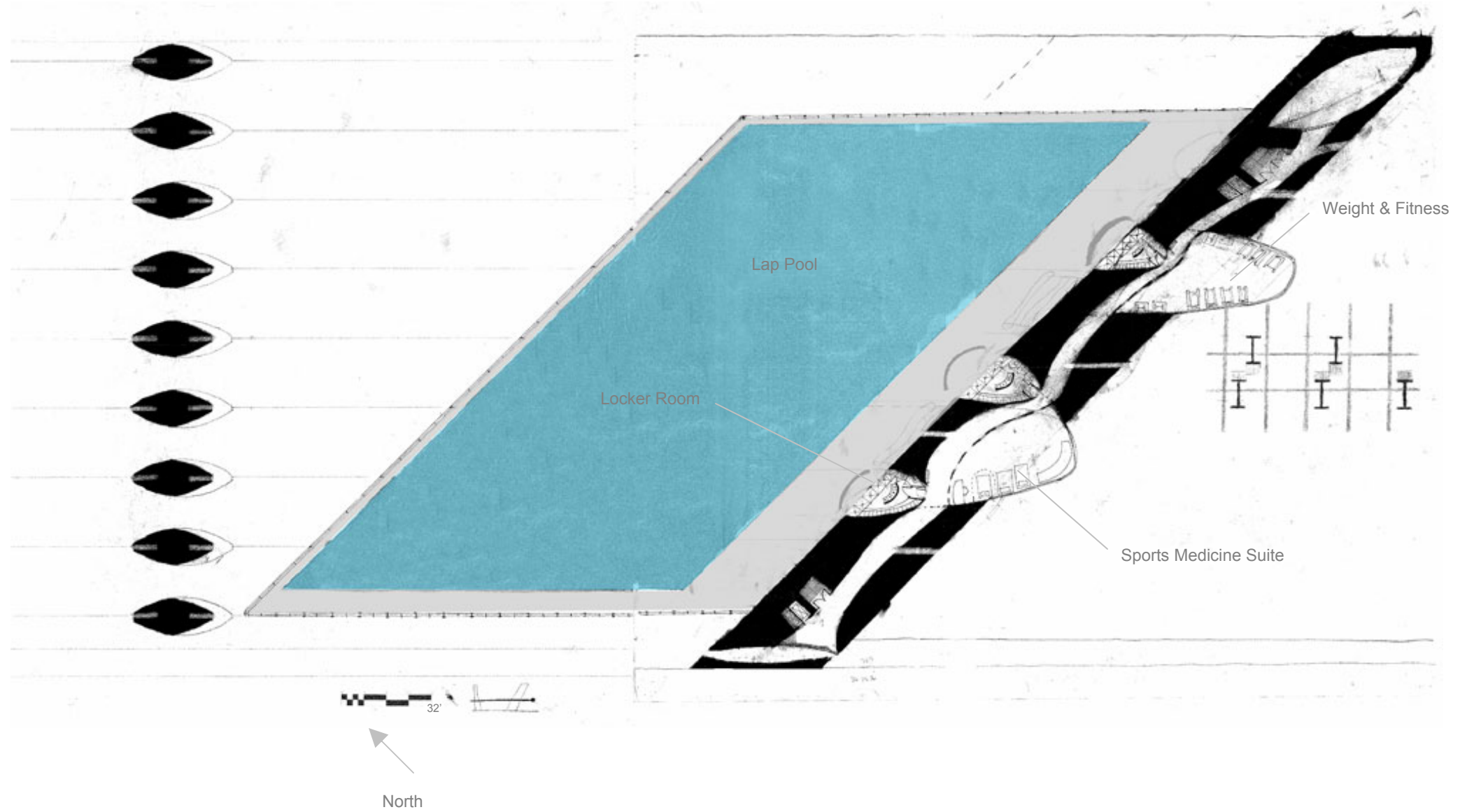
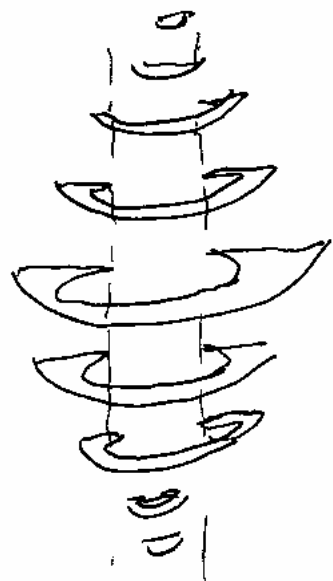
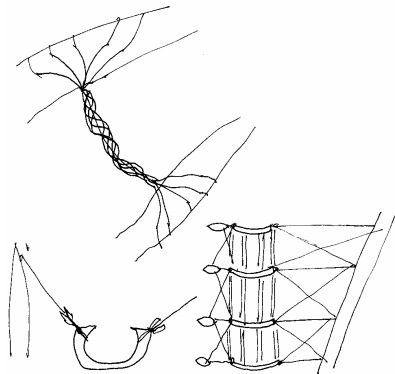
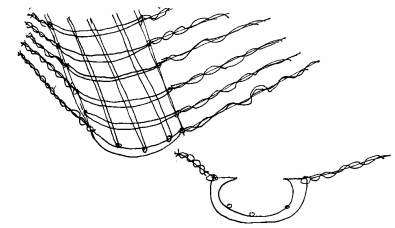
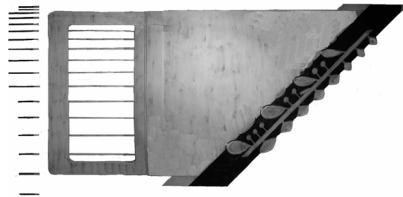

Competition Level Plan. The floor provides dedicated facilities for athletes who are in training or competition. Climate-controlled locker rooms are located on the North side while the sports medicine room is located on the South side to receive the sun's radiance.

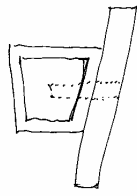

Diving Well / Spectator Level

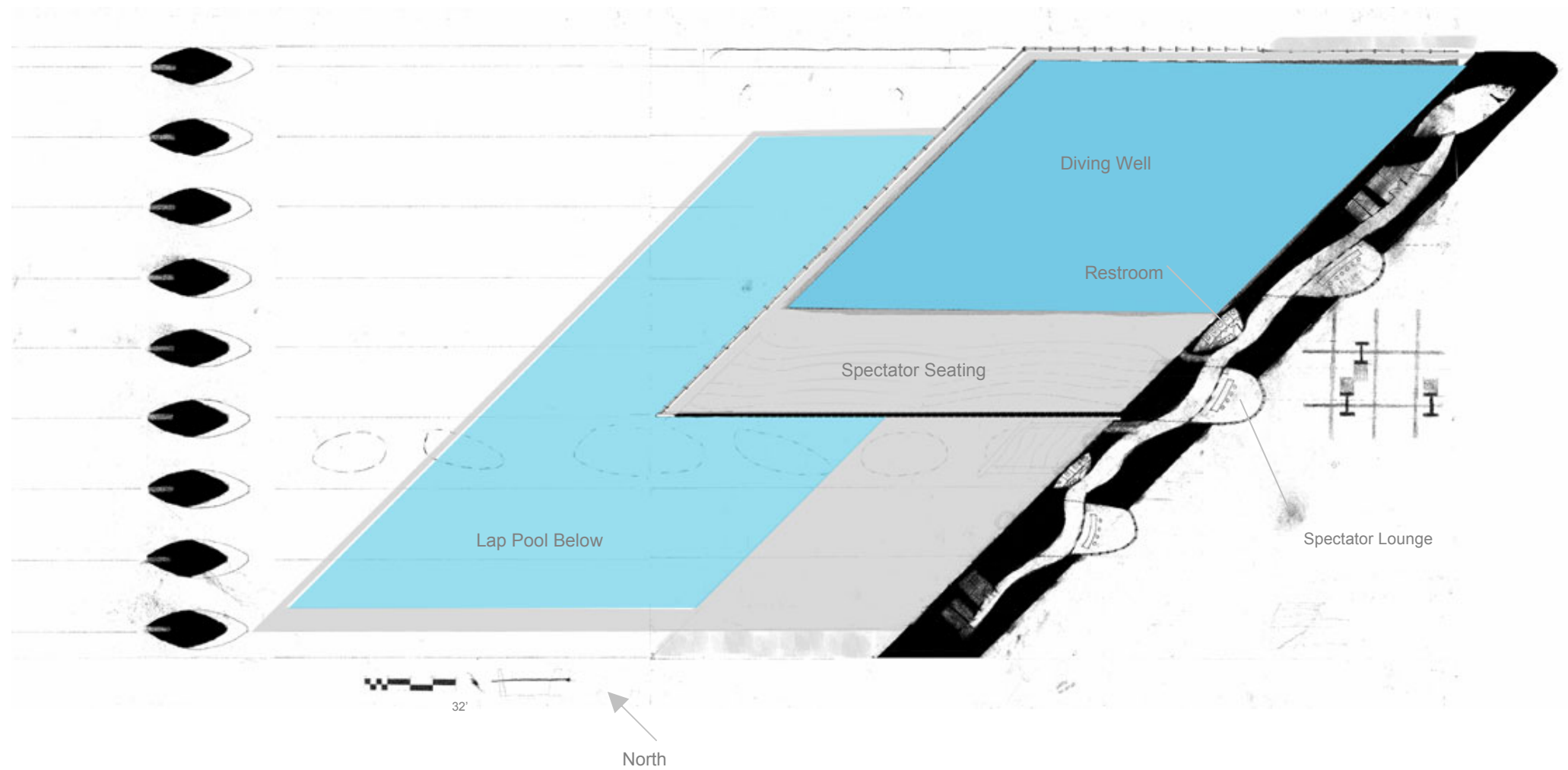
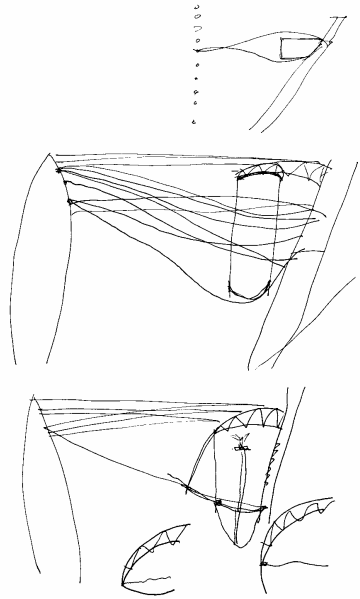

Spectator Floor Plan. From this level spectators can ascend to view the diving well or descend to watch the lap pool. Large lounges are located on the South side of the building to allow sun into the building for relaxation.

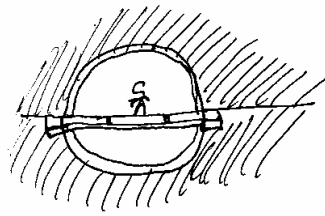

Leisure / Jogging Track Level

24

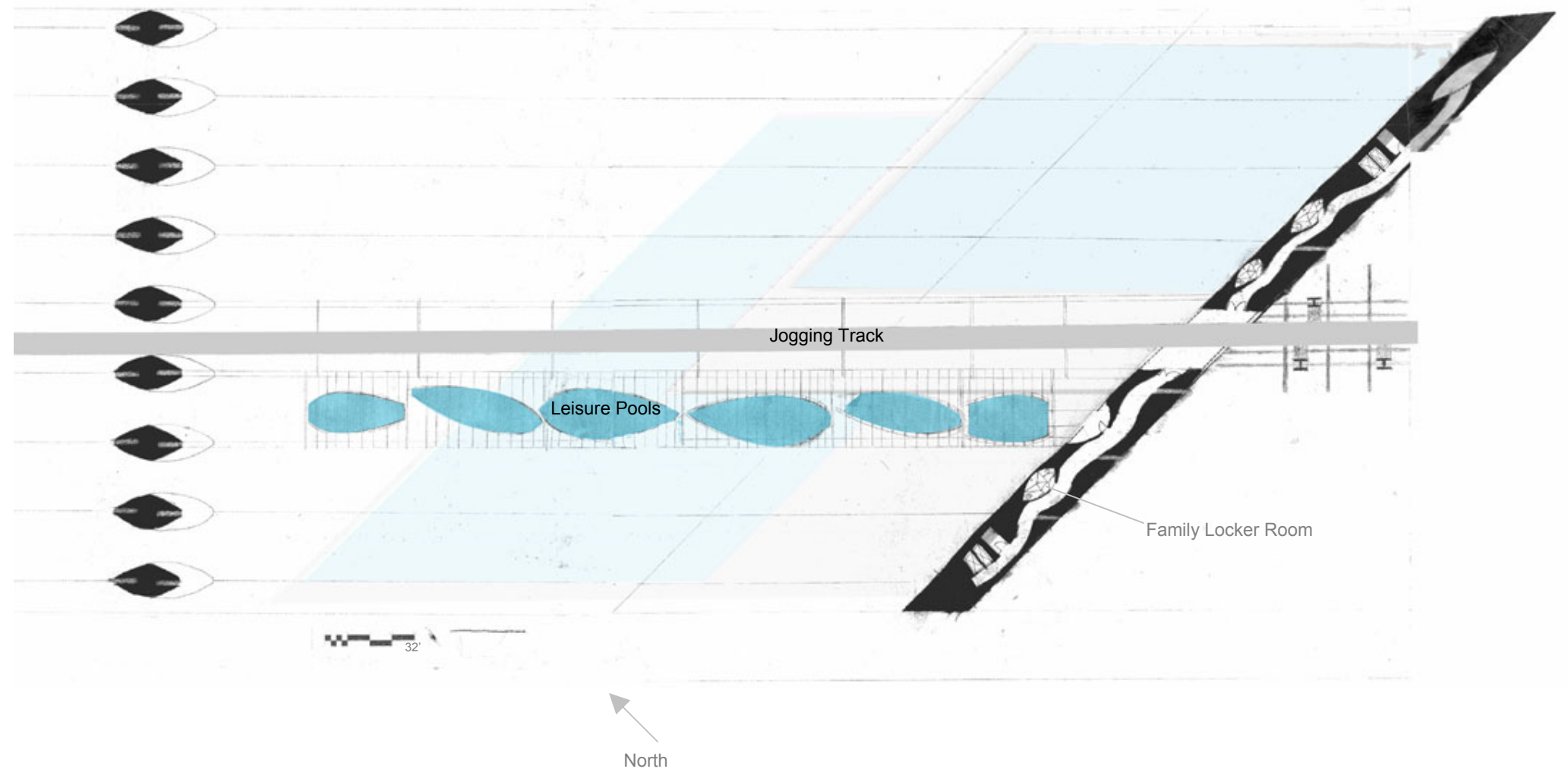
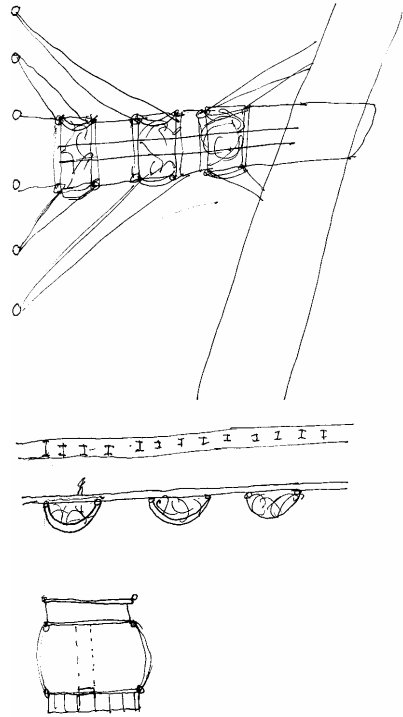

Leisure Level Floor Plan. Patrons at this level can use small locker rooms and step out onto a series of small, interconnected pools for relaxation. The elevated jogging track also slices through the building at this level and acts as the physical link to the other buildings on the waterfront.

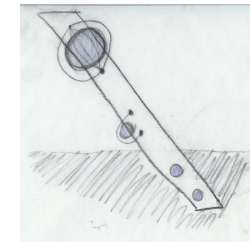
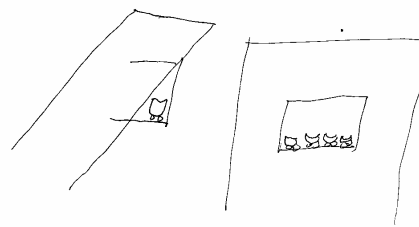
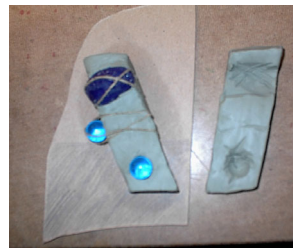

Stair Section

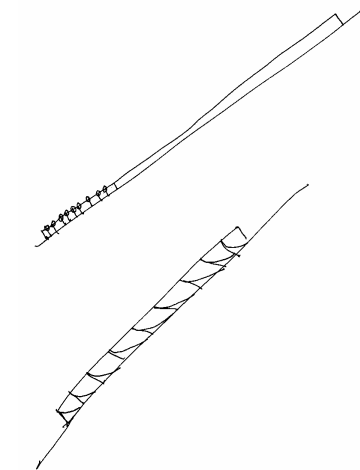
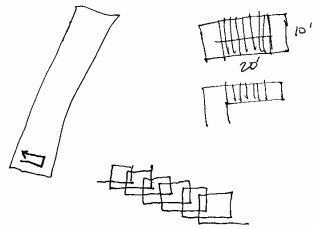
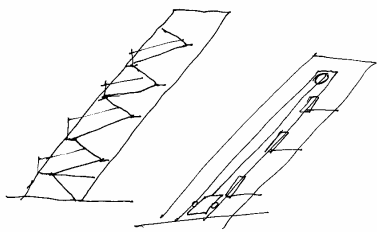

The large wall is approximately 40' to 60' wide and is a building within itself. Spaces are carved or erased from the interior of it.

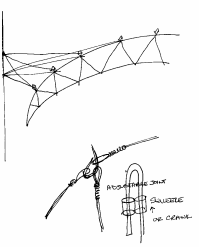
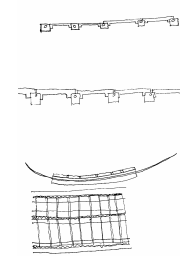
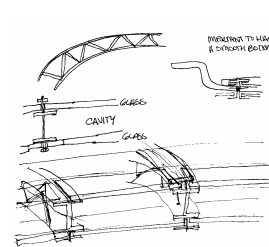
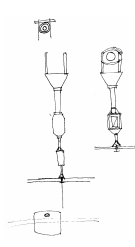
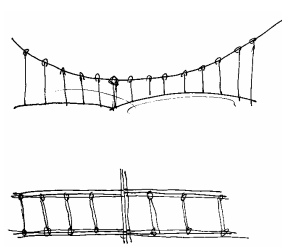

Details

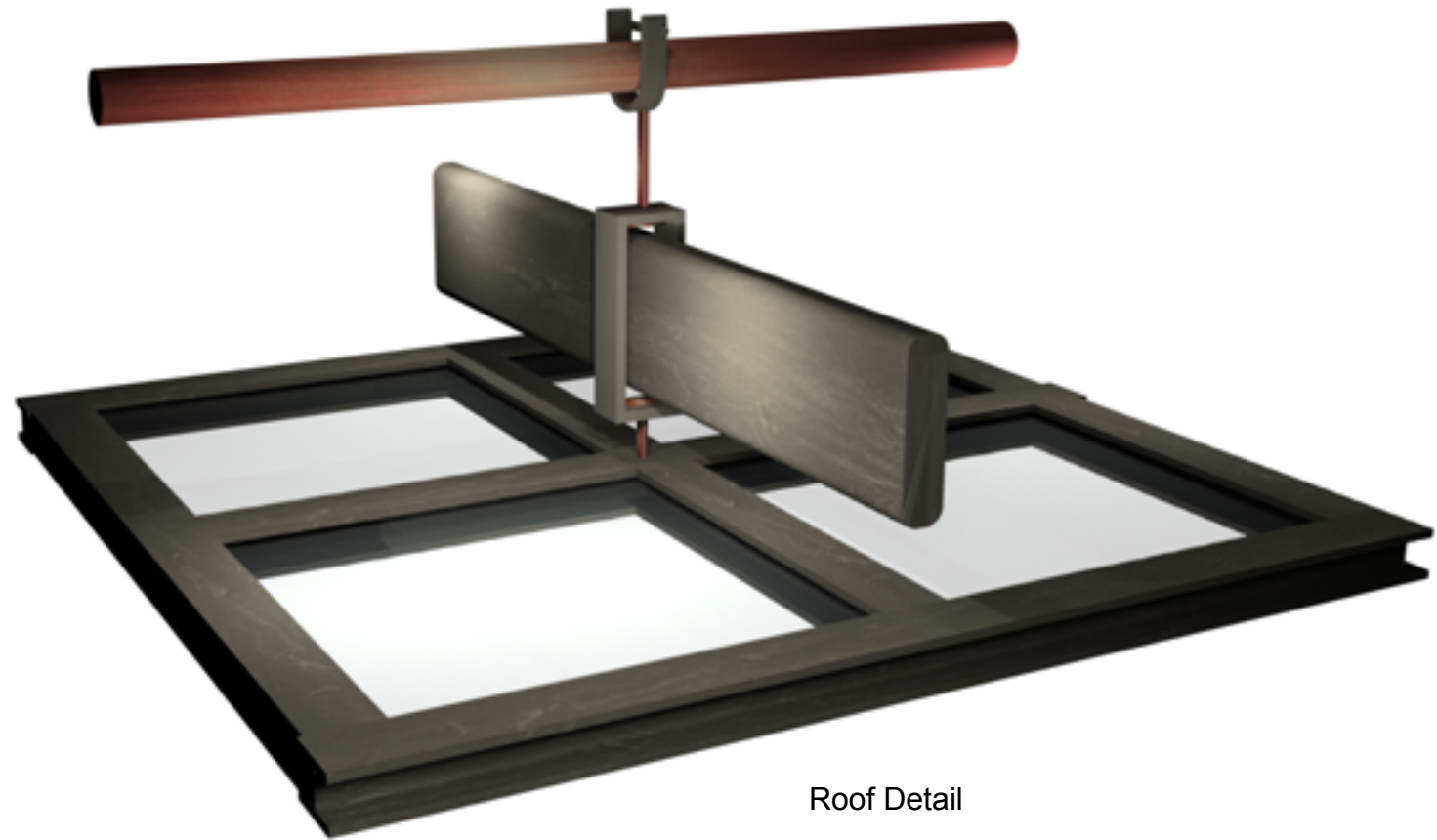
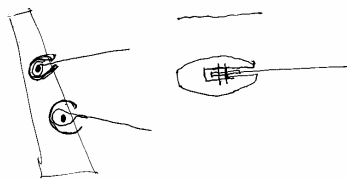
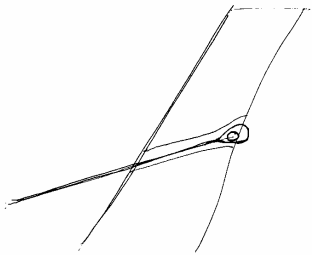
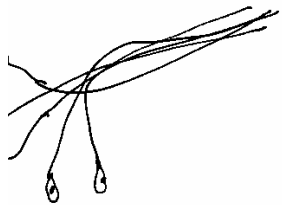
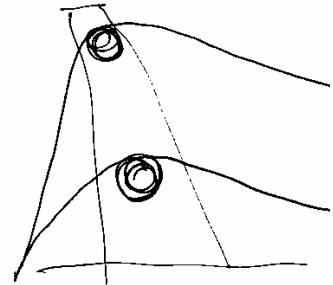

Roof Detail

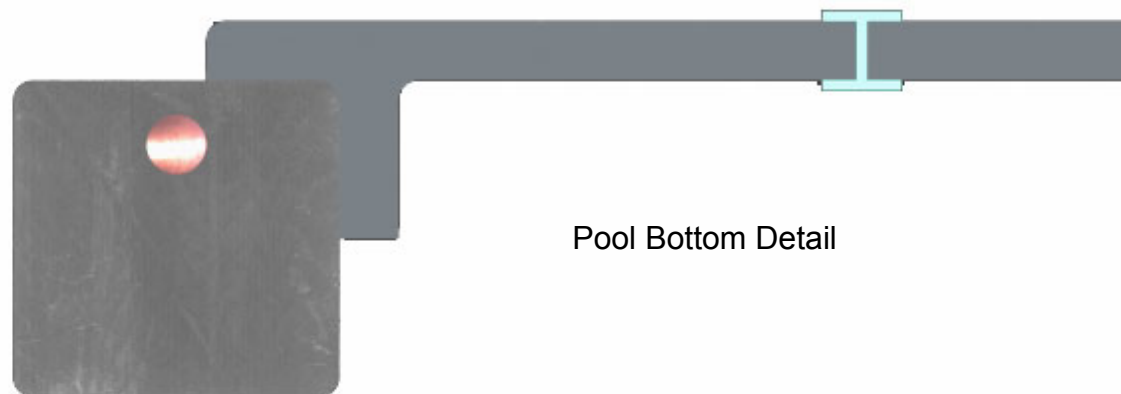

Pool Bottom Detail

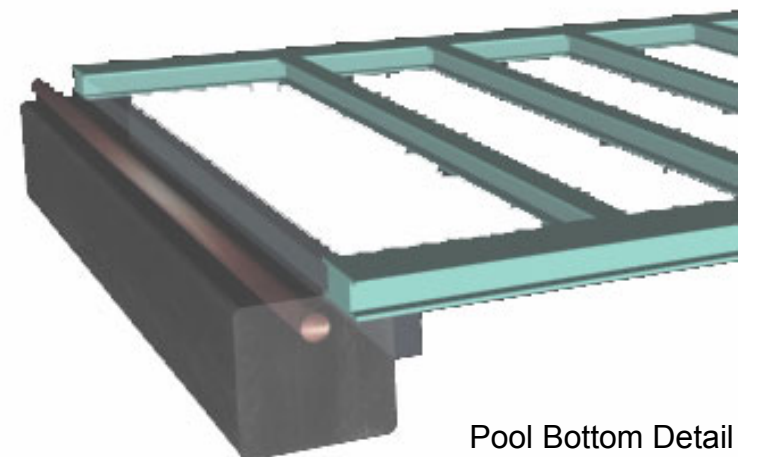

Pool Bottom Detail

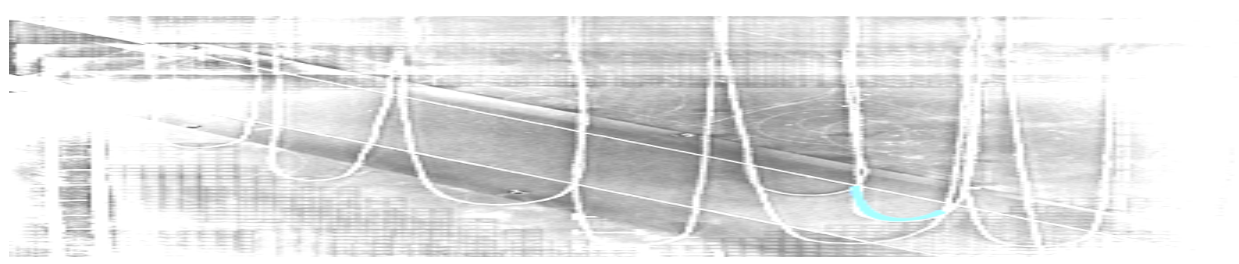

$$y = a \cdot \cosh(x/a)$$

Strategy for Creating Spaces within Wall

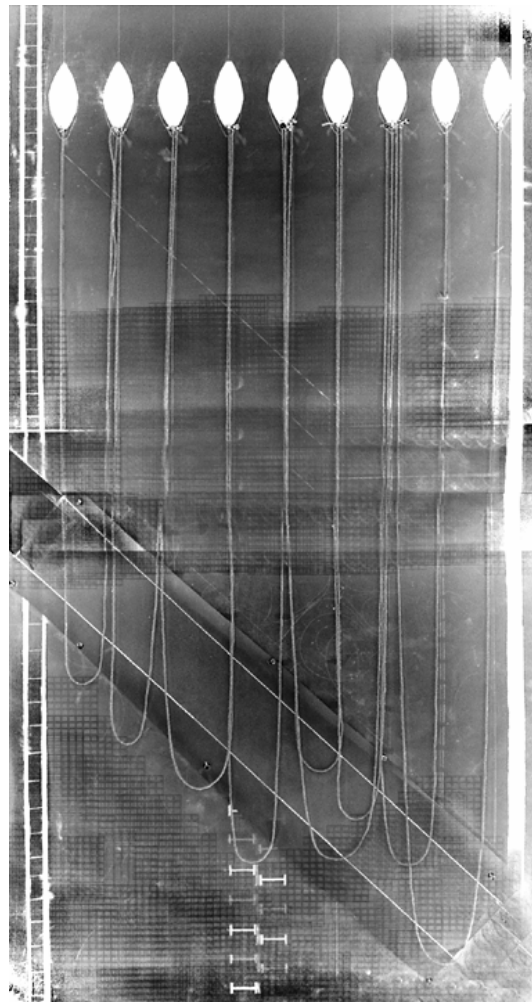
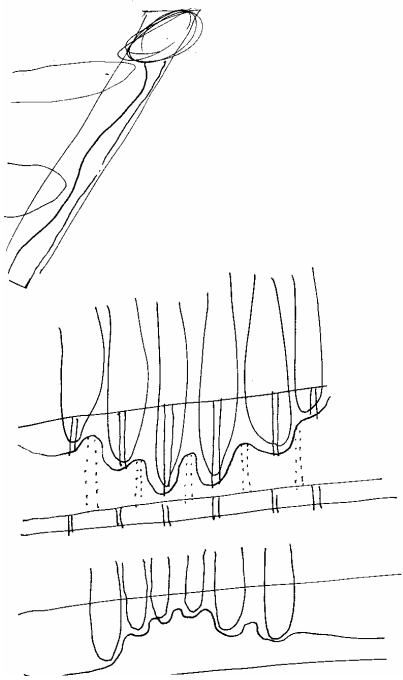

Water Level

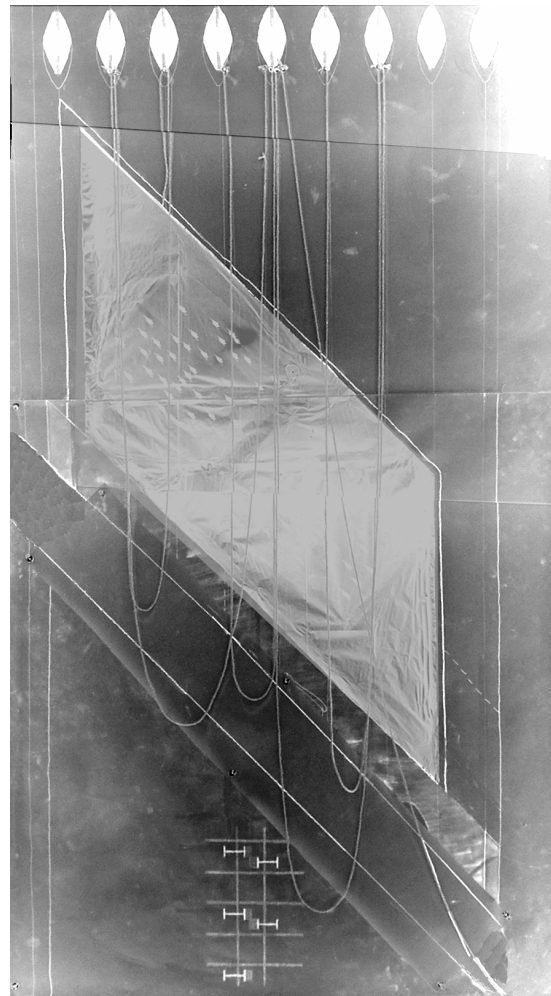

Competition Level



Spectator Level

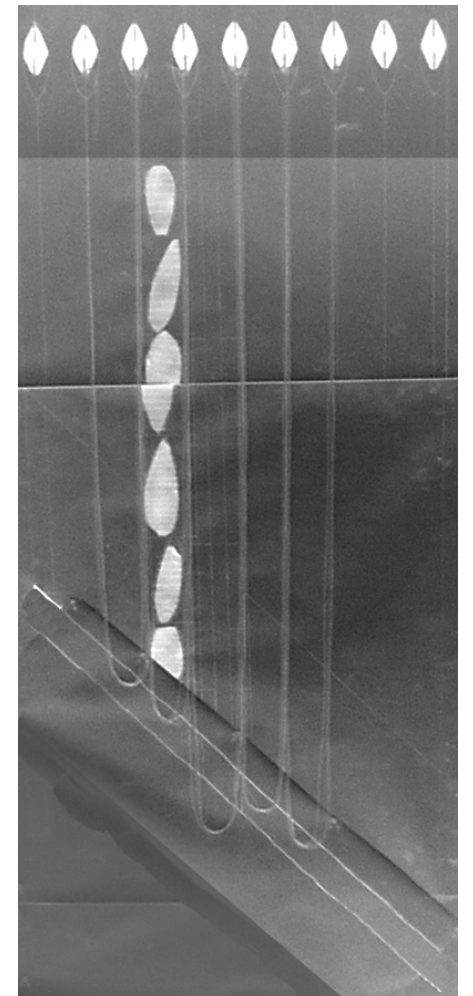

Leisure Level

The Harper Collins Dictionary of Mathematics defines catenary as: the curve described by a uniform heavy flexible cord hanging freely between two points; when symmetrical about the y-axis, its equation is $y = a \cdot \cosh(x/a)$, with a the point of intersection with the y-axis.

The plans were hung on the wall, and strings were attached to the edges of the columns. The catenary shapes guided the decisions for carving out spaces within the wall.

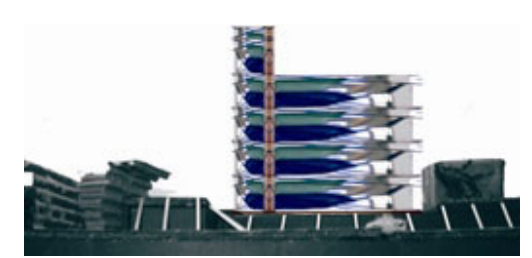
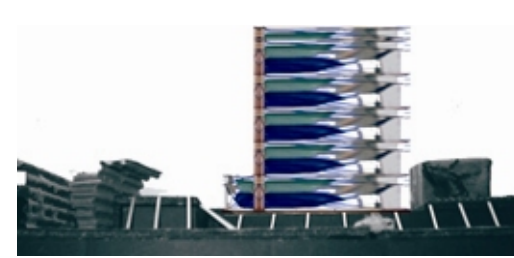
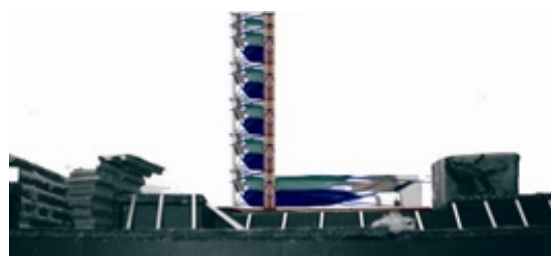

Site View

The mass of the building relates to the other object buildings that exist in Southwest, D.C. However, the urban strategy integrates the large buildings with the pedestrian realm through smaller open market structures and building entrances.



Left: View of the proposed view on the site.
Below: Existing Waterfront.



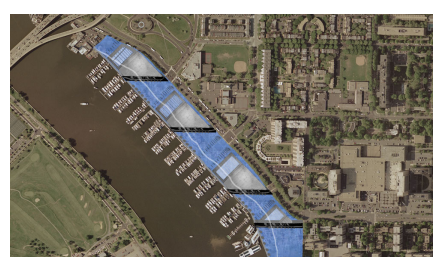
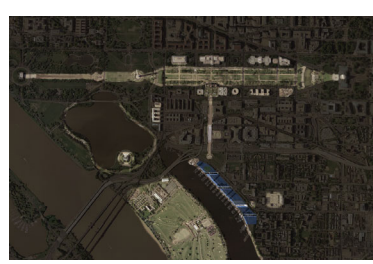

Urban Strategy : Plan and Section

29

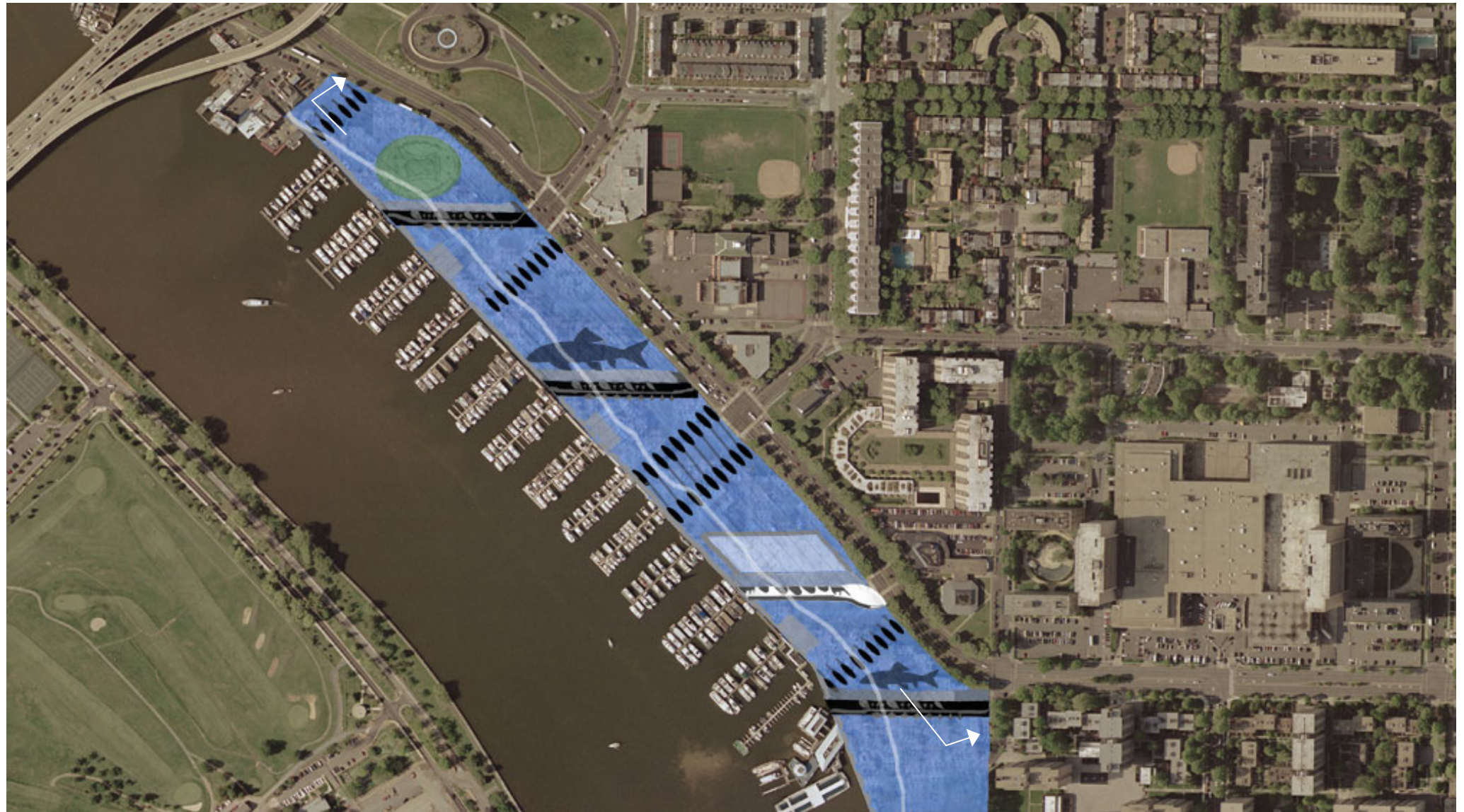

Above: Urban Plan. Below: Master Section. The strategy incorporates similar buildings with suspended elements that are strung together with an elevated jogging track.

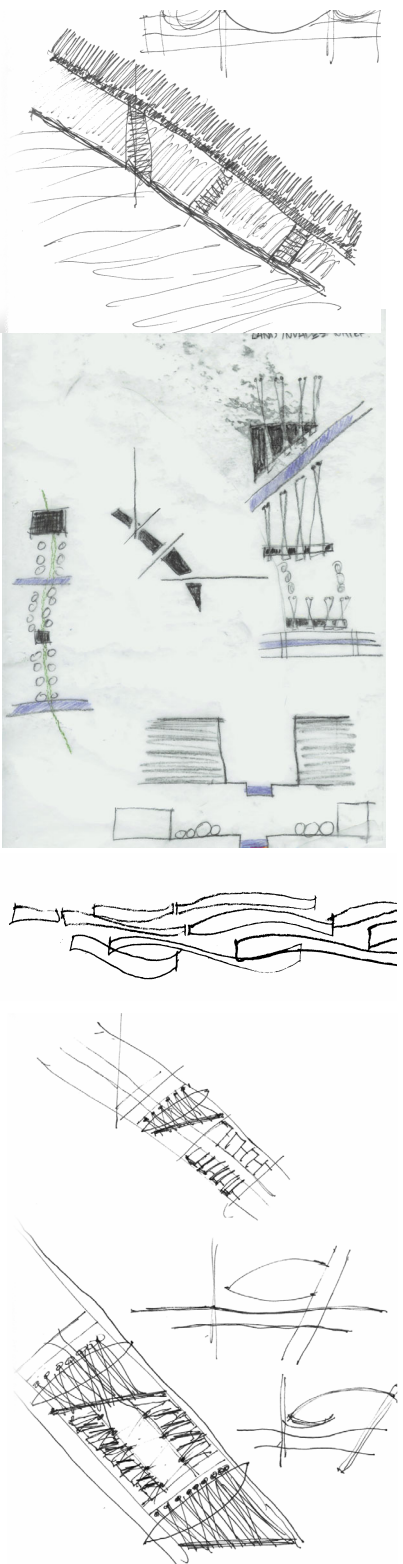

3-Dimensional Images

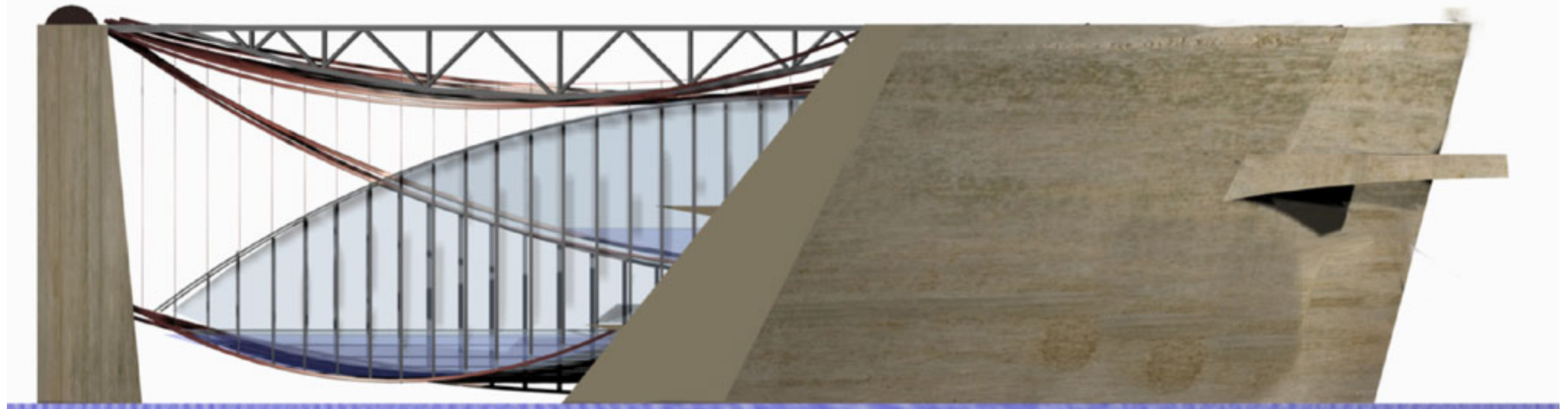

Southwest Elevation (As seen from the Channel)

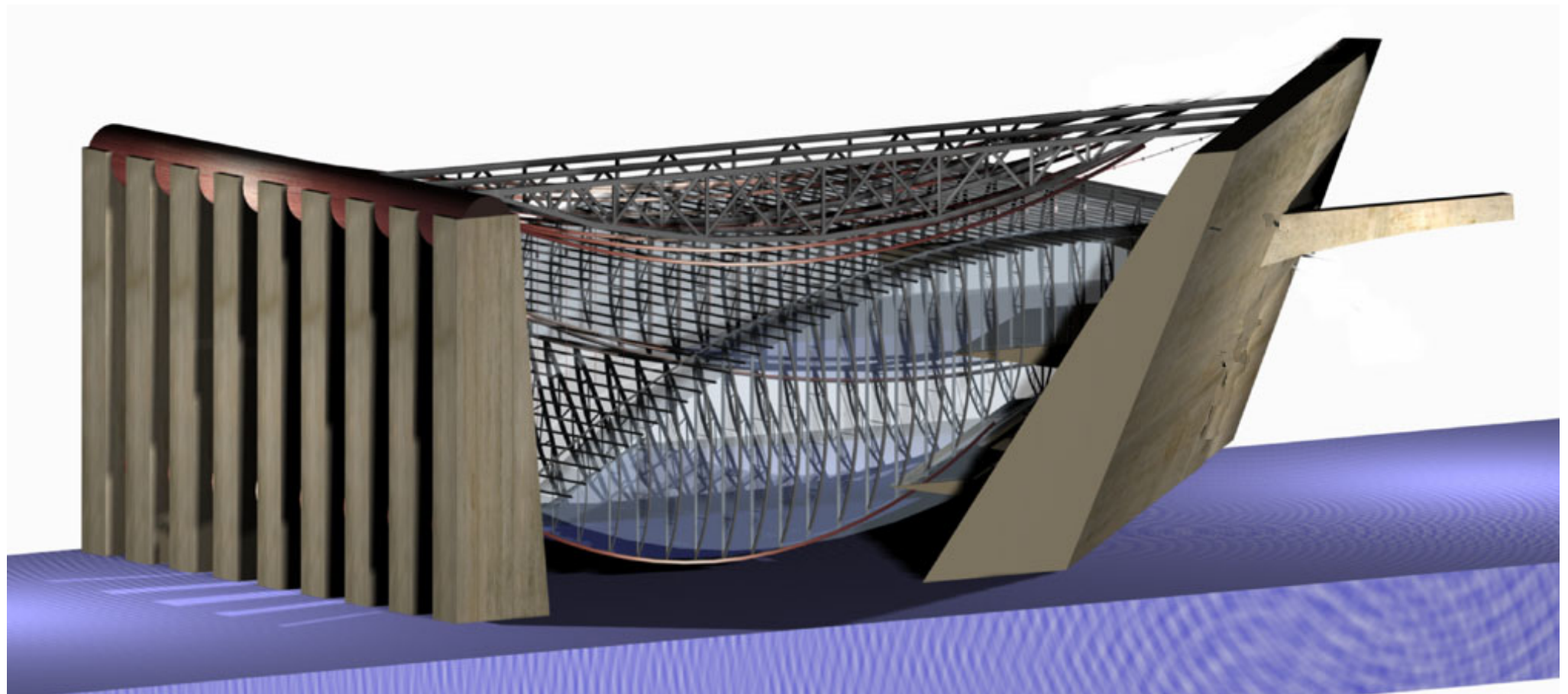

West Perspective (As seen from the Channel)

3-Dimensional Images

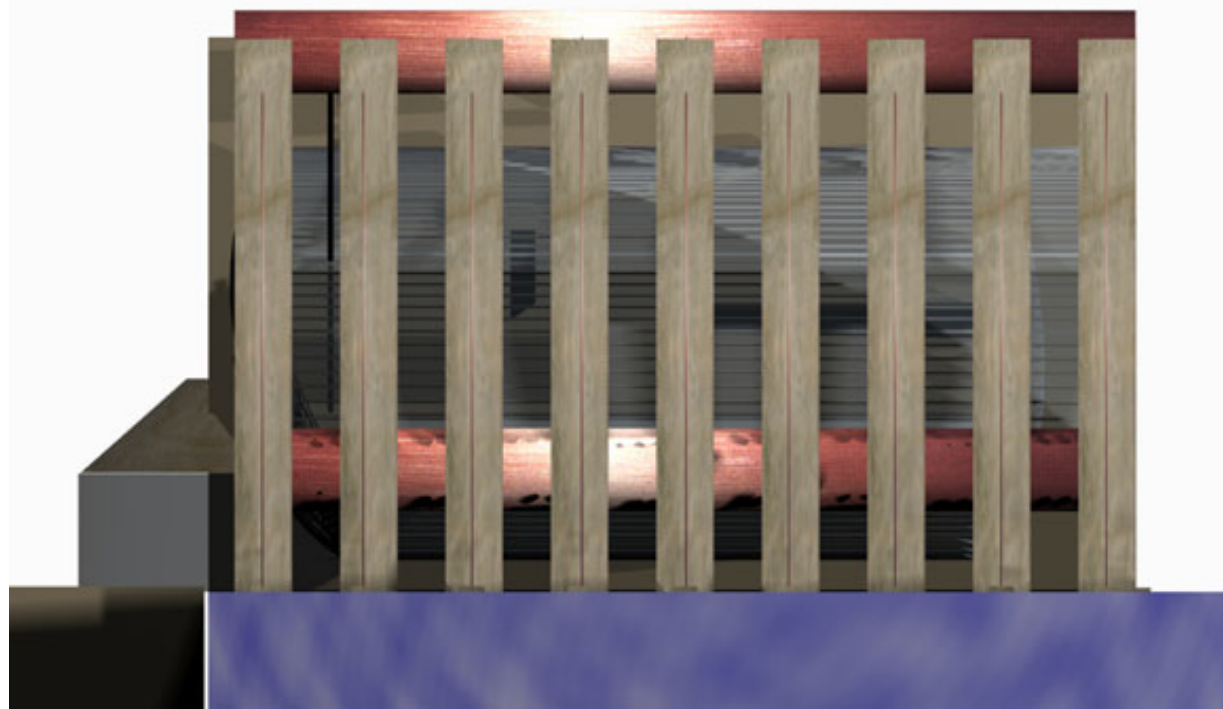
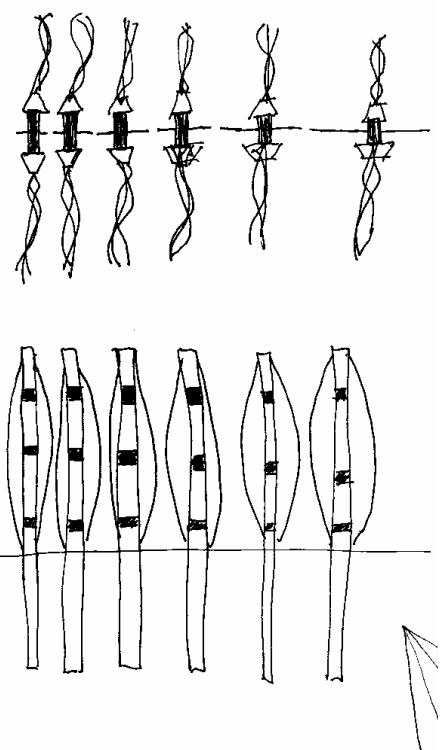

Northwest Column Elevation (As seen from the recreational water area)

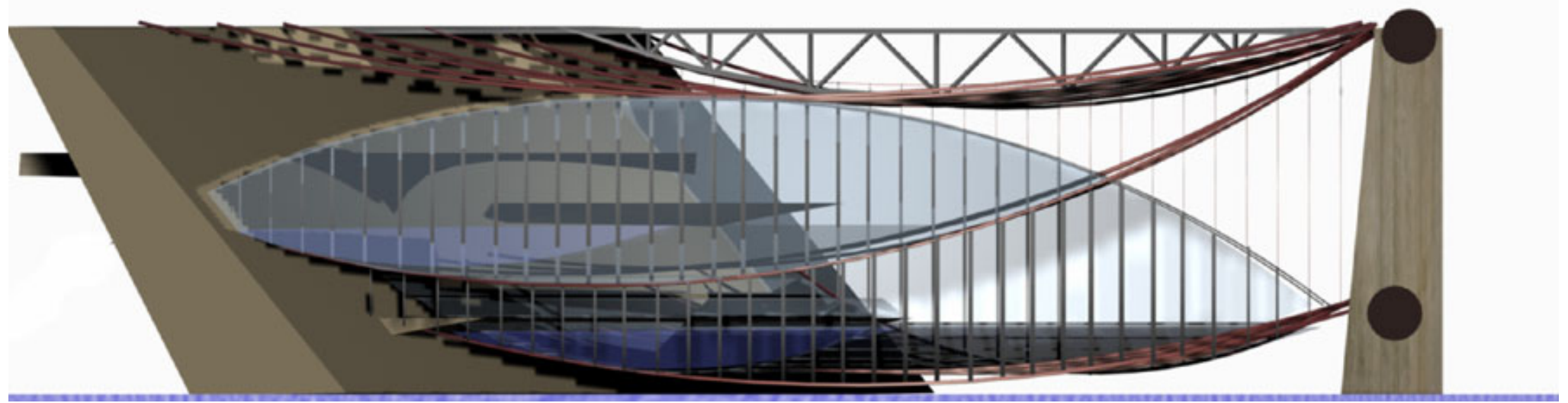
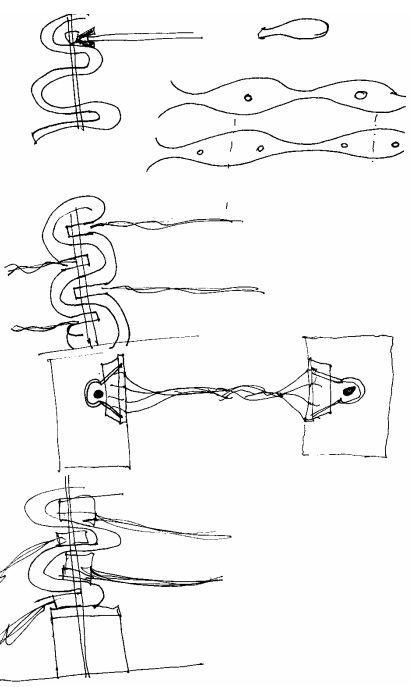

Northeast Elevation (As seen from the city)

Borowski, E.J. and Borwein, J.M. The Harper Collins Dictionary of Mathematics. New York: Harper Collins Publishers, 1991.

U.S. Geological Survey. "The National Map Viewer." Updated 30 January 2004. <<http://nmviewogc.cr.usgs.gov/>>. Cited 20 June 2004.

Washington, D.C. Office of Planning. Southwest Waterfront Vicinity. Washington, D.C. Office of Planning, 2003.

The following references were sources of general inspiration:

Great Buildings Online. "Dulles Airport – Eero Saarinen." Updated 2004. <http://www.greatbuildings.com/buildings/Dulles_Airport.html>. Cited 27 June 2004.

Archimetal. "Siège de la Banca Popolare di Lodi - Renzo Piano." Updated 16 December 2003. <<http://www.archimetal.com/applications/batiments/lodi1.htm>>. Cited 27 June 2004.

Masaharu, Takasaki. Takasaki Masaharu: An Architecture of Cosmology. Princeton: Princeton Architectural Press, 1998.

Tzonis, Alexander and Rosselli, Paolo. Santiago Calatrava: The Poetics of Movement. New York: Universe Publishing, 1999.

Blaisdell. San Francisciana Photographs of Sutro Baths. San Francisco: Marilyn Blaisdell Collection, 1987.

Michelle Marie Biesiadny-Mrstik

Education

Master of Architecture

Virginia Polytechnic Institute and State University, Blacksburg, Virginia

Expected 2004

Bachelor of Science in Architectural Studies

Urban Planning Certificate

University of Wisconsin – Milwaukee

2001

Work Experience

Project Analyst

June 2004 – present
Brailsford & Dunlavey
Washington, D.C.

Intern

December 2002 – May 2004
Brailsford & Dunlavey
Washington, D.C.

Architectural Intern

January 2002 – December 2002
Sutton Yantis Associates Architects
Vienna, Virginia

Architectural Intern

March 2000 – December 2001
Eppstein Uhen Architects
Milwaukee, Wisconsin

Accounting Intern

September 1999 – March 2000
Eppstein Uhen Architects
Milwaukee, Wisconsin

Marketing Intern

May 1999 – September 1999
Eppstein Uhen Architects
Milwaukee, Wisconsin

Office Services Assistant

June 1997 – May 1999
Eppstein Uhen Architects
Milwaukee, Wisconsin