

**Determination of Extractables from Cranberry Seeds using  
Supercritical CO<sub>2</sub>**

**Mansi Bhagdeo**

Thesis submitted to the faculty of Virginia Polytechnic Institute and State  
University in partial fulfillment of the requirements for the degree of

Master of Science  
In  
Chemistry

**Committee**

Larry Taylor, Chair  
Brian Hanson  
Gary Long

**Blacksburg, VA.  
May 14, 2004.**

Key words: supercritical fluids, cranberry seeds, nutraceuticals, fatty acids,  
polyphenols, GC-MS, HPLC

**DETERMINATION OF EXTRACTABLES FROM CRANBERRY SEEDS USING  
SUPERCRITICAL CO<sub>2</sub>  
BY  
MANSI BHAGDEO**

**ABSTRACT**

An alternative method for extraction of therapeutically beneficial compounds such as sterols, fatty acids, and tocopherols from cranberry seeds with pure SF CO<sub>2</sub> has been provided. The supercritical fluid extraction (SFE) operating conditions such as extraction temperature, pressure of CO<sub>2</sub>, extraction time, and CO<sub>2</sub> flow rate were optimized to maximize the extraction yield. The amount and type of SF extractables (pure CO<sub>2</sub>) have been compared with Soxhlet extractables (hexane) to evaluate the feasibility of SFE as an alternative extraction method. The extractables obtained via hexane and SF CO<sub>2</sub>, which were derivatized and identified by gas chromatography mass spectrometry (GC-MS), contained mostly methylated fatty acids.

*To my mom and dad  
Ila and Pravin Bhagdeo*

## **ACKNOWLEDGEMENTS**

I would like to express my gratitude to my research advisor, Dr. Larry Taylor, for his patience and guidance throughout my research. I am also grateful to my committee members, Dr. Gary Long and Dr. Brian Hanson, for their suggestions and understanding, and for taking the time to serve as my committee members. I am thankful to the Taylor research group members for being such a tremendous support system and making my experience in the lab enjoyable. My special thanks to Dr. Medhi Ashraf-Khorassani for his time, encouragement, and advice whenever I have needed it. I would also like to thank all my friends in Blacksburg who have helped in making me feel at home here. I am grateful to my family, the Thanawala's and Bhagdeo's, for taking on so many of my responsibilities so that I could concentrate on my research at Virginia Tech.

I am also grateful to Air Products and Chemicals Inc. (Allentown, PA) for supplying the carbon dioxide used for supercritical fluid extractions and to David Cunningham and Ocean Spray for donation of cranberry seeds for our research. Finally, I am indebted to my uncle, Mrugesh Thanawala, and my parents, Ila and Pravin Bhagdeo, for their unconditional love and prayers at all times.

## TABLE OF CONTENTS

	<b>Page</b>
Abstract	ii
Dedication	iii
Acknowledgement	iv
List of Figures	vi
List of Tables	vii
<b>1. Introduction</b>	
1.1 Nutraceuticals	1
1.2 Cranberry : Taxonomy and History	2
1.3 Cranberry Seeds	4
1.4 Supercritical Fluid Extraction	4
<b>2. Determination of Pure Supercritical CO<sub>2</sub> Extractables</b>	
2.1 Introduction	10
2.2 Health Benefits of Essential Oils and Tocopherols	12
2.3 Experimental	15
2.3.1 Soxhlet Extraction	16
2.3.2 Supercritical Fluid Extraction	16
2.3.3 Derivatization	17
2.3.4 GC-MS Analysis	18
2.3.5 SPME Analysis	18
2.4. Results and Discussion	19
2.4.1 Extraction	19
2.4.2 Composition of Extracts	22
2.5. Conclusion	35
References	37
Appendix	39
Vita	66

## LIST OF FIGURES

Figure	Description	Page
1	Distribution of commercial cranberry production in US	4
2	Phase diagram of CO <sub>2</sub>	5
3	Structure of Resveratrol	7
4	Schematic of SFE apparatus	9
5	Structure of Linolenic acid	13
6	Structure of Linoleic acid	13
7	Structure of Tocopherols	15
8	Structure of Triundecanoin	16
9	Effect of CO <sub>2</sub> pressure on percent recovery	20
10	Effect of extraction temperature on percent recovery	20
11	Effect of CO <sub>2</sub> flow rate on percent recovery	21
12	Effect of extraction time on percent recovery	21
13	Soxhlet extract (12 min to 35 min)	26
14	SFE extract (12 min to 35 min)	26
15	GC-MS chromatograms of derivatized Soxhlet extractables (peak 1 through peak 14)	27
16	GC-MS chromatograms of derivatized SF extractables (peak 1 through peak 14)	27
17	GC-MS chromatograms of derivatized Soxhlet extractables (peak 15 through peak 21)	28
18	GC-MS chromatograms of derivatized SF extractables (peak 15 through peak 21)	28
19	Extracted ion chromatogram of Linoleic acid (C 18:2)	29
20	Extracted ion chromatogram of Oleic acid (C 18:1)	30
21	Extracted ion chromatogram of Linolenic acid (C18:3)	31
22	Mass spectral data of pentadecanoic acid methyl ester	32
23	McLafferty Rearrangement	32

## LIST OF TABLES

Table	Description	Page
1	Summary of common nutraceutical products found on the market	2
2	Physico-chemical properties of Gases, SF's, and Liquids	6
3	Optimized SFE conditions for CO <sub>2</sub> extraction of cranberry seeds	22
4	Fatty acids identified in cranberry extract as their methyl esters using GC-MS	25
5	Composition of neutral lipid extract and SF extract	33,34

# 1. Introduction

## 1.1 Nutraceuticals

*“Let food be your medicine and medicine be your food.”*

- Hippocrates 400 B.C.

Nutraceuticals<sup>1</sup> are naturally occurring bioactive chemicals which are present in foods and ingestible substances and they exhibit medicinal or physiological effects in addition to their nutritional benefits. Nutraceuticals can be in the form of foods or as dietary supplements. Nutritional foods are essential for normal growth and maintenance of body; whereas nutraceuticals are primarily associated with improving the quality of life and disease prevention and cure. There has been a paradigm shift in our perception of food. Though the primary goal of food is sustaining life, it is increasingly looked upon as a natural source for fighting diseases.

Consumers are increasingly more informed concerning the effect of diet and exercise on their health and the association between dietary habits and disease. They are seeking more healthier and natural alternatives as a complement to traditional drugs. The above mentioned reasons coupled with the rising costs of health insurance have led to the increasing acceptance of nutraceuticals.

Research, drug discovery, and treatment of cancer<sup>2</sup> sets the society back by an estimated \$104 billion per year. Also, western medicine does not have satisfactory<sup>3</sup> solutions in the treatment and prevention of cancer. Research has shown that altering ones lifestyle (dietary habits and exercise) is effective<sup>2</sup> in preventing two thirds of the cancer cases. So the nutraceutical industry has been led by foods that show anti-



carcinogenic effects. The current nutraceutical market<sup>3</sup> is \$16.7 billion and is expected to grow to \$28 billion by 2006. The range of nutraceutical products is diverse and complex.

Table 1 shows a summary<sup>4</sup> of these products.

**Table 1. Summary of common nutraceutical products found on the market**

Vitamins
Multiple vitamins
Minerals
Multiple vitamins and minerals
Herbal extracts
Botanical substances e.g. tea, essential oils
anti-oxidants, carotenoids, procyanidins, essential fatty acids

According to the Dietary Supplement Health and Education Act (DSHEA), the FDA has 75 days to approve<sup>5</sup> a new dietary supplement. Dietary supplements are not required to receive FDA approval before marketing their product after 75 days. This has contributed to a rapidly growing nutraceutical market. So, to protect the consumer and to ensure the quality of these dietary supplements, standardization and validation of the analytical methods for evaluating these products is vital.

## **1.2 Cranberry : Taxonomy and History**

Taxonomy

Kingdom : Plants

Phylum : Magnoliophyta (Angiosperms)

Class : Magnoliopsida (Dicotyledons)

Order : Ericales

Family : Ericaceae

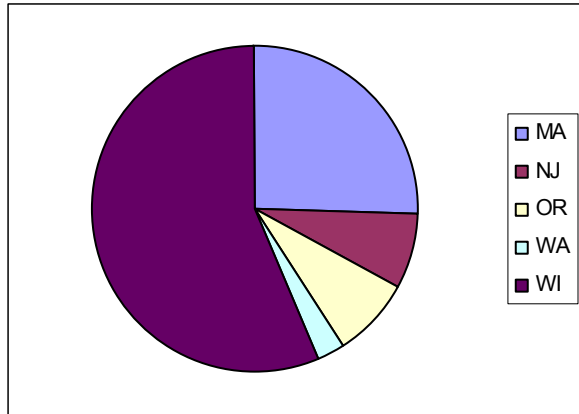
Genus : *Vaccinium*

Species : *macrocarpon* (American cranberry), *oxycoccus* (small cranberry)

The cranberry belongs to the genus *Vaccinium* along with other berries such as blueberry, bilberry, huckleberry, and grouseberry. The two cranberry species<sup>6</sup> are similar but genetically they differ in the number of chromosomes present in their cells, *Vaccinium macrocarpon* is diploid (contains 2 copies of each chromosome); whereas *Vaccinium oxycoccus* is tetraploid (contains 4 copies of each chromosome). The small cranberry (*oxycoccus*) is mostly found in Europe and Russia ; whereas large or American cranberry (*macrocarpon*) is grown in the Northern parts of America such as Newfoundland, New England, the northern portions of Great Lakes states, western Washington, and Oregon.

American cranberry (*Vaccinium macrocarpon*), along with blueberry and Concord type blue grape, is one of the three commercially important fruits that originated in North America. *Vaccinium macrocarpon* Ait. was a part of North America long before the Europeans first established settlements. Native Americans have used cranberry as food, medicine, and dye. Cranberry is commercially grown in parts of North America particularly in open bogs, swamps, and wet shores. The commercial American cranberry production is 5.83 million barrels (one barrel is equal to 100 lbs.)(released August 19, 2003 by National Agricultural Statistics Services (NASS), USA.). Thus, cranberry

(*Vaccinium macrocarpon* Ait.) is, traditionally and economically, an important fruit in the US.



**Figure 1. Distribution of the commercial cranberry production by state in US**

### 1.3 Cranberry Seeds

Cranberry seeds are the waste that is left behind during processing of cranberries for juices or other cranberry related products. After the cranberry is pressed to extract its juice, the remaining pulp (waste) is air-dried, and the seeds are separated. Disposing of wastes is highly undesirable both economically and environmentally. Cranberry seeds are believed to contain high levels of unsaturated omega acids that are associated with lowering of total cholesterol and inhibiting the oxidation<sup>7,8</sup> of low density lipoproteins (LDL). There is an increasing public awareness about the need to preserve the natural environment. Recycling of wastes is an effective strategy for conserving the environment. Recovering of ‘high value’ materials helps towards making the recycling of wastes economically viable. Thus, the extraction, isolation, and identification of these ‘high value’ materials from cranberry seeds are justified.

### 1.4 Supercritical Fluid Extraction (SFE)

SF's can be best described by referring to a phase diagram. Figure 2 shows the phase diagram<sup>15</sup> of CO<sub>2</sub>. The critical temperature ( $T_c$ ) is the highest temperature at which a gas can be converted into a liquid by an increase in pressure and the critical pressure ( $P_c$ ) is the highest pressure at which a liquid can be converted to gas by an increase in its temperature. When the temperature and the pressure<sup>15</sup> of any substance are above its  $T_c$  and  $P_c$ , it is considered to be a SF.

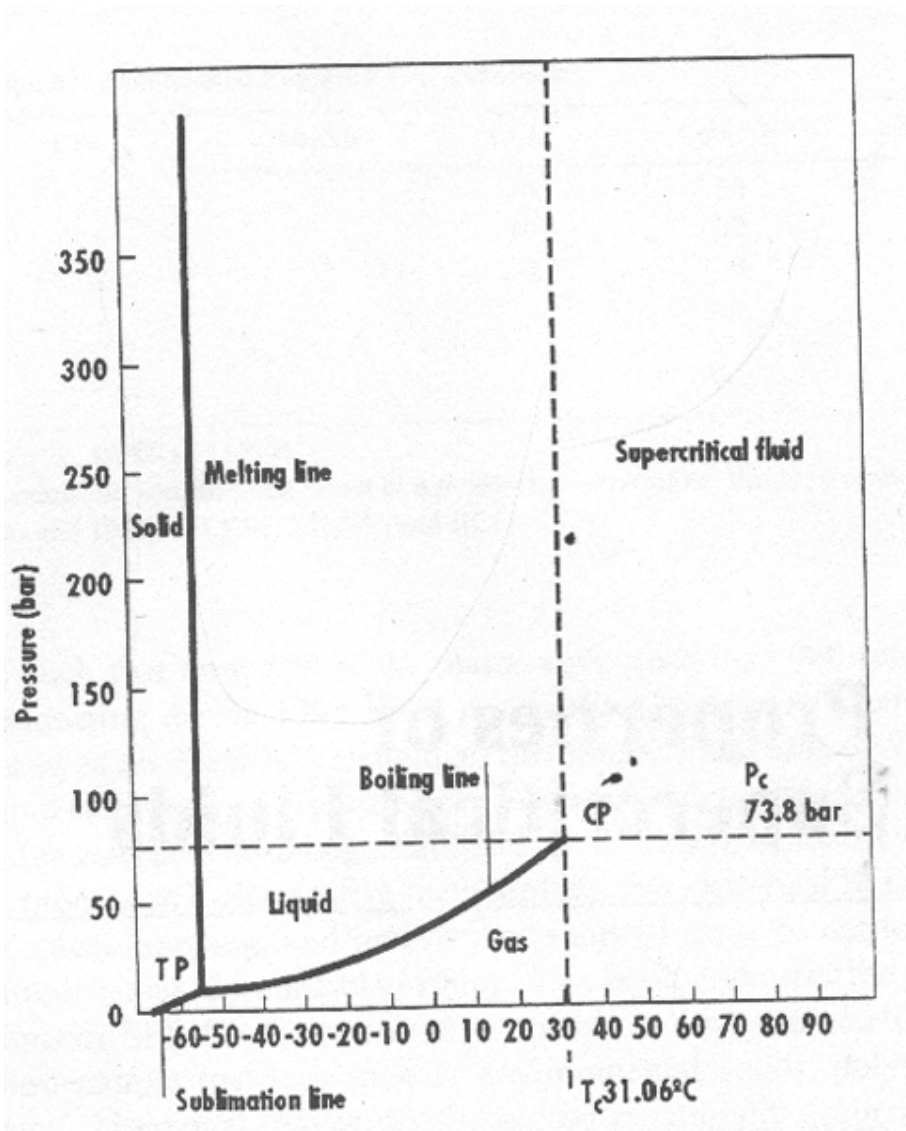


Figure 2. Phase Diagram<sup>15</sup> of CO<sub>2</sub>

Conventional solvents have fixed solvating strength. However, SF's have 'tunable' solvating power. By adjusting the physical parameters such as temperature and pressure, it is possible to vary the solvating strengths of SF fluids.

**Table 2. Physico-chemical properties<sup>15</sup> of Gases, SF's, and Liquids**

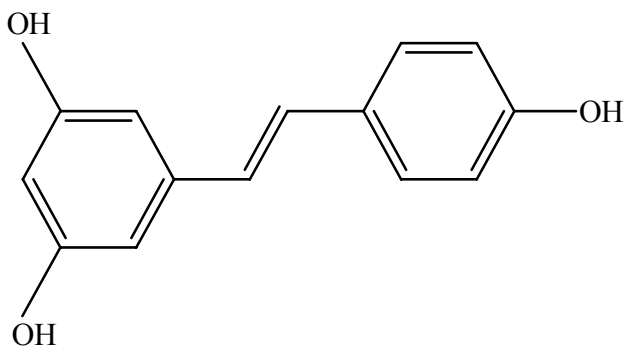
	Density (g/mL)	Dynamic viscosity (g/cm-sec)	Diffusion coefficient (cm <sup>2</sup> /sec)
Gas (ambient)	0.0006-0.002	0.0001-0.003	0.1-0.4
Supercritical fluid (T <sub>c</sub> , P <sub>c</sub> )	0.2-0.5	0.0001-0.0003	0.0007
Liquid (ambient)	0.6-1.6	0.002-0.03	0.000002-0.00002

The physico-chemical properties (Table 2) of SF are intermediate between those of a gas and a liquid. The higher diffusivity of the SF compared to conventional solvents makes it ideal for extraction of solid or powdered matrices. This property also leads to shorter extraction times. SF can be easily removed after extraction by reducing its pressure, thereby eliminating the need for solvent evaporation. SF CO<sub>2</sub> has been considered as a potential alternative to conventional solvents due to its relative non-toxicity and non-flammability, as well as its low critical temperature and pressure.

Sample preparation is a critical step in qualitative analysis and a necessary prerequisite for quantification. For extraction of nutraceuticals like fatty acids, SFE displays some inherent advantages.

1. Absence of light

Phenolic compounds such as resveratrol can exist in two isomeric forms of which only one shows biological activity. Light can catalyze a reaction transforming the compound from active to inactive form <sup>16,17,18</sup>. SFE can be carried out in the absence of light, so it can prevent photochemical isomerization of the compound.



**Figure 3. Structure of trans-resveratrol**

#### 2. Absence of air

Several compounds, such as catechins, react easily with air at high temperatures and are oxidized. However, SFE is carried out in an oxygen free atmosphere thereby eliminating oxidative degradation<sup>19</sup>. This also helps in conserving the anti-oxidant properties<sup>20</sup> of the extracts.

#### 3. Decreased extraction time

Extraction times with conventional methods<sup>19</sup> using organic solvents are long giving rise to possible degradation of the products. Enzymes already present in the sample matrix, which are released during extraction, can promote degradation reactions. Shorter extraction times (less than one hour) may reduce the adverse effect of enzyme activity.

#### 4. Superior quality of extracts

The antioxidant activities of SF-CO<sub>2</sub> extracts<sup>16</sup> in black pepper were found to be superior as compared to extracts by conventional methods.

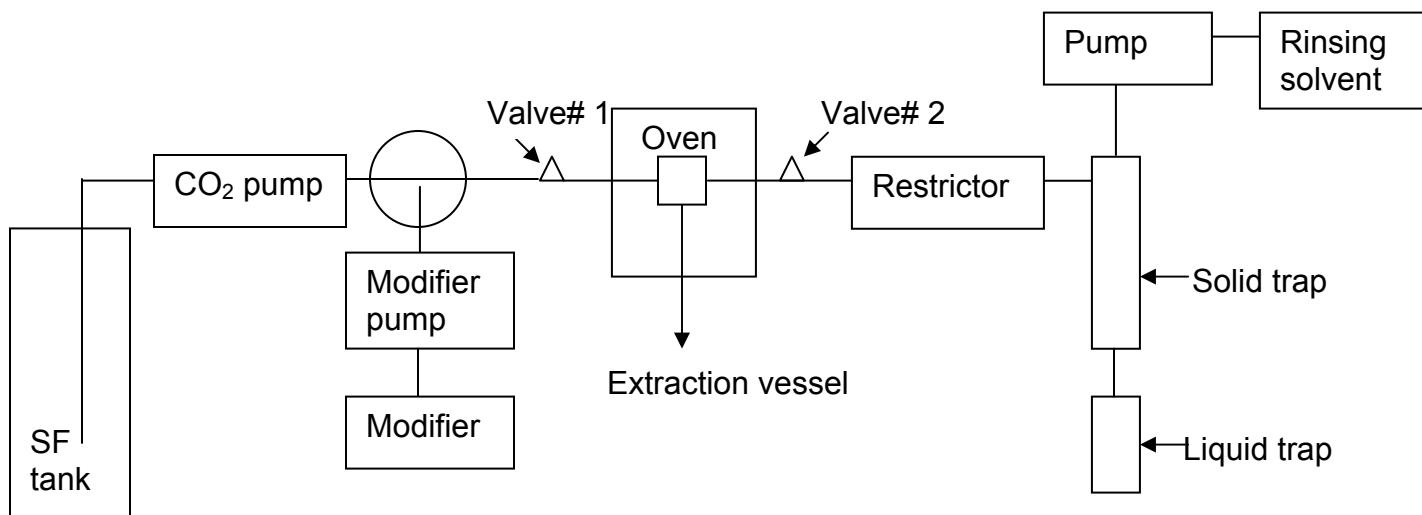
#### 5. Mild experimental conditions

To avoid any significant changes like oxidation, thermal degradation, isomerization or any other biochemical changes in the extract, mild conditions can be employed. SF-CO<sub>2</sub> with at critical conditions ( $P_c = 73 \text{ atm}$ ,  $T_c = 31^\circ\text{C}$ ) offers gentle extraction parameters, thus degradation of labile compounds<sup>16</sup> can be avoided.

#### 6. Amount of organic solvent used

The amount of toxic<sup>21</sup> organic solvent used in SFE is less than the organic solvents used for liquid-liquid extraction.

Figure 4 illustrates the main components of a typical SFE system. The SFE system used for the experiments performed in this thesis was an AutoPrep 44. It consists of a tank of gaseous CO<sub>2</sub>, a pump to pressurize the CO<sub>2</sub>, a reservoir of organic solvent (modifier), modifier pump, an oven containing an extraction vessel, restrictor, and trapping<sup>15</sup> systems (which are outside the oven). CO<sub>2</sub> and the modifier (if used) were pressurized to the desired value and mixed in the desired proportion before being introduced into the extraction vessel. The extraction vessel was placed inside an oven to maintain the required temperature. The variable restrictor maintains the backpressure and also allows flow rates to be adjusted to constant levels at different pressures. The trapping system consists of a solid trap and/or a liquid trap. The solid phase trapping system can be packed with inert solids like silanized glass or stainless steel beads, chromatography column packings like C18-silica, and solid adsorbents such as graphite. After the analytes are trapped, the solid trap is rinsed with an appropriate rinsing solvent.



**Figure 4. Schematic of SFE apparatus**

Extraction strategies in SFE involve static, dynamic, or coupled static/dynamic modes<sup>15</sup>. During static extraction, the sample interacts with a fixed amount of SF whereas during dynamic extraction, fresh CO<sub>2</sub> is continuously passed over the sample. For static extraction, valve #1 is opened to allow the required amount of SF into the extraction vessel. After the required amount of SF has flowed into the extraction chamber, the valve is closed and then the extraction is allowed to proceed. After the extraction is completed, the second valve is opened to permit the extraction fluid to pass through the restrictor. For dynamic extraction, both valves are opened and the extracting fluid is passed through the restrictor and trapped by the trapping systems, throughout the extraction. Most SFE methods, including the ones described in this thesis, employ a combination of these methods to incorporate the benefits of both modes of extraction.



## 2. Determination of Pure Supercritical CO<sub>2</sub> Extractables

### 2.1 Introduction

Cranberry has been considered, traditionally and economically to be an important fruit of Northern America. Commercial cranberry products are available in a variety of forms such as juice, sauce, fresh fruit, and dried fruit. Cranberry seeds are removed as waste products during the manufacture of sauces and juices. So extraction of 'high value' products from cranberry seeds is, environmentally and economically, justified. So far, there have been only two published reports describing the extraction of "high value" compounds<sup>7,8</sup> from cranberry seeds .

R. Croteau and J. Fogerson<sup>8</sup> extracted lipids from cranberry seeds with boiling isopropanol, followed by CHCl<sub>3</sub>-isopropanol, and finally CHCl<sub>3</sub>. The three extracts were combined and concentrated under vacuum and were purified by elution through Sephadex with CHCl<sub>3</sub>-methanol (1:1) which was saturated with water. The lipids were found to constitute 23.3% (w/w) of the total isopropanol/CHCl<sub>3</sub> extract. The lipids were then fractionated by column chromatography on a silicic column. Neutral lipids (95.5%) were eluted with CHCl<sub>3</sub>, glycolipids (3.4%) were eluted with acetone, and phospholipids (1.1%) were eluted with methanol. The extracts were derivatized with BF<sub>3</sub>/MeOH and bis-(trimethylsilylacetamide) and analyzed by GC-FID. The neutral lipid extract showed the presence of fatty acids, sterols, hydrocarbons, and triterpenic compounds.

A method for performing extractions<sup>7</sup> on large quantities of cranberry seeds

(1450 g-1850 g) using hexane as the extracting solvent has been reported. Fatty acids were reported to be the major components of the hexane extract; while sterols, triperpenic compounds, and tocochromanols were the minor components.

The conventional methodology for extracting fatty acids from matrices such as grape seeds involves Soxhlet extraction with either hexane<sup>22</sup> or diethyl ether<sup>23</sup>. Supercritical CO<sub>2</sub> has been considered as an alternative to conventional solvents due to its relative non-toxicity and non-flammability, as well as its low critical temperature and pressure. SFE has been used for example in the extraction of fatty acids from diverse matrices such as grape seeds,<sup>22,23</sup> ginseng seeds<sup>24</sup>, wood pulp<sup>25</sup>, and infant formula<sup>26</sup>. The absence of oxygen and light during the supercritical extraction process will, no doubt, help prevent degradation of the extract. For example, Tipsrisukond, et al.<sup>16</sup> found higher anti-oxidant activity in SF extracts of pepper than extracts obtained by conventional means. Furthermore, due to the higher diffusivity of supercritical fluid compared to liquid solvents, extraction times were shorter for SFE than for corresponding liquid/solid extraction.

The objective of this research was to determine the quantity and chemical nature of pure CO<sub>2</sub> extractables from cranberry seeds. SFE parameters such as CO<sub>2</sub> pressure, extraction temperature and time, and CO<sub>2</sub> flow rate were optimized to obtain the best possible extraction conditions. The amount and type of SF extractables were compared to Soxhlet extractables to evaluate feasibility of SFE as an alternative method. The SF and Soxhlet extracts were compared by gravimetric determination followed by trans-esterification of their fatty acids into methyl esters and finally determination of their compositions by GC-MS.

## **2.2 Health Benefits of Essential Oils and Tocopherols**

Coronary heart disease and cancer are important leading causes of death in the US. So, health care professionals are increasingly engaged in the prevention and cure of these diseases. Nutraceuticals such as essential oils and tocopherols are gaining acceptability and popularity as natural alternatives for maintaining cardiac health and prevention of cancer.

### **Essential oils**

Fatty acids can be divided into saturated and unsaturated fatty acids on the basis of the absence or presence of a double bond in their alkyl chains. It is known that saturated fatty acids are more closely linked to the risk of coronary heart disease<sup>27,28</sup> than unsaturated fatty acids. Fatty acids<sup>28</sup> derived from plant sources contain higher concentrations of unsaturated fatty acids; whereas saturated fatty acids are more dominant in animal sources. Omega-3 and Omega-6 fatty acids are a special group of unsaturated fatty acids which are essential components of cellular membranes but cannot be synthesized within the body. So we must depend on external sources for our intake of essential oils. Saturated fats are not essential in our diet as our body can synthesize them.

Omega-3 fatty acids have their first double bond at the third carbon atom (carbon atoms are counted from the hydrocarbon end to the carboxylic group).

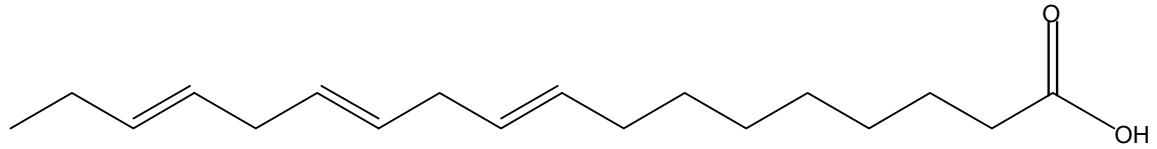
Omega-3 fatty acids include

- (1) Linolenic acid (18:3)
- (2) Eicosapentaenoic acid (EPA) (20:5)

(3) Docosahexaenoic acid (DHA) (22:6)

(4) Docosapentaenoic acid (22:5)

(a:b) where a= number of C atoms, b= number of double bonds



**Figure 5. Structure of Linolenic acid**

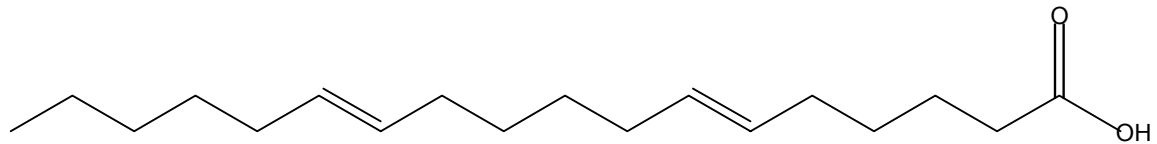
Omega-6 fatty acids have their first double bond at the sixth carbon atom (carbon atoms are counted from the hydrocarbon end to the carboxylic group).

Omega-6 fatty acids include

(1) Linoleic acid (18:2)

(2) Arachidonic acid (20:4)

(a,b) where a= number of C atoms, b= number of double bonds



**Figure 6. Structure of Linoleic acid**

Only marine sources are rich in important omega-3 fatty acids such as EPA<sup>27</sup> and DHA, which help in the prevention of atherosclerosis (narrowing of arteries). The human body has necessary enzymes to convert linolenic acid to EPA and DHA. So vegetarians must take particular care to include foods containing linolenic acids in their diet.

Unsaturated fatty acids have also been suggested to possess anti-inflammatory<sup>3</sup>, anti-fungal, and anti-bacterial properties. Omega-3 fatty acids<sup>22,30</sup> play an important role in the reduction of platelet aggregation.

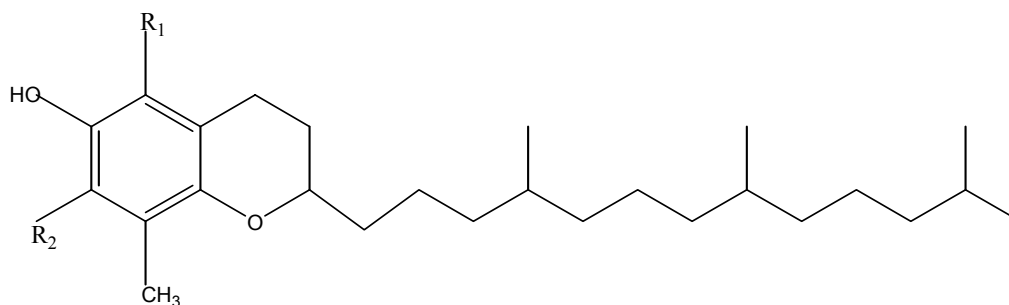
Cholesterol is produced in the liver by a series of biochemical reactions. Since cholesterol is not soluble in blood, it is transported along the body by carrier protein

molecules. Depending on the density of the carrier, they are classified as low-density lipoproteins (LDL) and high-density lipoproteins (HDL). LDL carry the cholesterol from liver to the body tissues and if too much cholesterol is present, it starts dumping the excess cholesterol in the arteries, which in turn leads to arterial blockages. HDL carries the excess cholesterol and returns it to the liver. Thus, higher levels of HDL and lower levels of LDL are beneficial. Unsaturated acids, such as omega acids, have been associated with the maintenance of cardiac health by lowering of the total cholesterol and LDL (low density lipoprotein) <sup>27,30</sup> cholesterol.

EPA is necessary for the manufacture of prostaglandins. The prostaglandins are responsible for making the blood platelets less sticky and easing the flow of blood throughout the human body. This helps in the reduction of platelet aggregation<sup>29</sup>, inhibition of blood clots, and ultimately helps in the prevention and cure of atherosclerosis.

### **Tocopherols**

Tocopherols (vitamin E) are lipid soluble antioxidants. Tocopherols play an important role in preventing the oxidation of biological material and lipoproteins caused by free radicals<sup>31</sup>. Clinical trials have shown that mixed tocopherols inhibit platelet aggregation in humans<sup>32</sup>. Oxidation of lipoproteins is one of the causes of atherosclerosis<sup>33</sup>. There also appears to be a strong correlation between damage to DNA and cancer<sup>34</sup>.



**Figure 7. Structure of Tocopherol**

$\beta$ -tocopherol :  $R_1 = \text{CH}_3$  and  $R_2 = \text{H}$

$\gamma$ -tocopherol :  $R_1 = \text{H}$  and  $R_2 = \text{CH}_3$

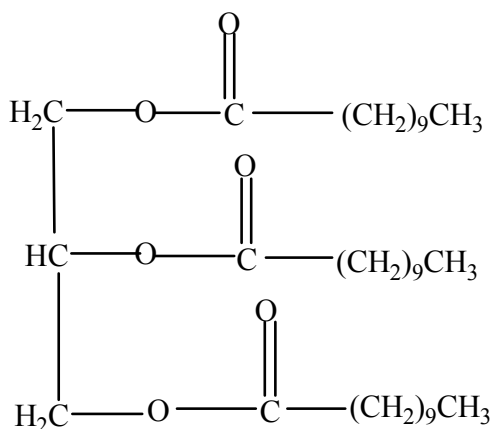
Normal physiological processes such as aerobic respiration and metabolism produce free radicals. Some of the free radicals formed by the body include superoxide anion and hydroxyl radical. These free radicals are extremely reactive and attack damaged body cells. Antioxidants react with these free radicals and get oxidized, thereby protecting the body cells from oxidation. In this way, tocopherols help in the inhibition of cancer and atherosclerosis.

## 2.3 Experimental

### Materials

Cranberry seeds were obtained from Ocean Spray Cranberries, Inc. (Lakeville-Middleboro, MA) and stored in polyethylene containers at 10°C. The seeds were freshly ground prior to each extraction. HPLC grade methanol, water, and toluene were obtained from Burdick & Jackson Laboratories, Inc. (Muskegon, MI), acetyl chloride was obtained from Sigma-Aldrich Chemical Co. (Milwaukee, WI), and sodium carbonate and Ottawa Sand Standard (20-30 mesh) were obtained from Fischer Scientific (Houston, TX). The internal standard,  $\text{C}_{11}$  triglyceride (triundecanoin), was obtained from Nu-Check Prep,

Inc. (Elysian, MN). CO<sub>2</sub> (SFC/SFE grade) with helium headspace was supplied by Air Products and Chemicals, Inc. (Allentown, PA).



**Figure 8. Structure of Triundecanoin**

### 2.3.1 Soxhlet Extraction

Conventional extraction was carried out with 200mL of hexane on 10g of crushed cranberry seeds. The extraction was allowed to proceed for 24h at the boiling point of hexane. The extract, thus obtained was concentrated by rotary evaporation and the residue was left under continuous vacuum for 24h to remove traces of solvent. The weight of this residue was considered to be 100% recovery. The experiments were performed in triplicate.

### 2.3.2 Supercritical Fluid Extraction

An Isco-Suprex (Lincoln, NE) AutoPrep (AP-44) system equipped with a variable flow restrictor was used for all supercritical CO<sub>2</sub> extractions. Ground cranberry seeds (1g) were mixed with Ottawa Sand and placed in a 5 mL stainless steel extraction vessel. Pure CO<sub>2</sub> was used for all extractions. The solid trap was packed with C<sub>18</sub>-silica and after each extraction it was rinsed with 5 mL of a mixture of dichloromethane and methanol (1:1). The fixed restrictor was heated to 55°C during the extraction, while the solid phase

trap was held at  $-30^{\circ}\text{C}$  and  $25^{\circ}\text{C}$  during the collection step and rinsing step respectively. All the samples were extracted in the static mode for 15 min. The extraction conditions were varied as follows :  $\text{CO}_2$  pressure (250atm to 450atm), extraction temperature ( $45^{\circ}\text{C}$  to  $100^{\circ}\text{C}$ ),  $\text{CO}_2$  flow rate (1mL/min to 2mL/min), and dynamic extraction time (45 min to 90 min). All extractions were performed in triplicate. The trapped SF extracts were rinsed into pre- weighed vials. The vials were then placed on a hot plate at  $50^{\circ}\text{C}$  and a stream of nitrogen was passed over them. The yields of the dried extract, expressed as percent recovery, were defined as the percentage ratio of the weight of SF extractables to the weight of Soxhlet extractables.

### **2.3.3 Derivatization**

Fatty acids can be present in cranberry seeds as free fatty acids, alkyl esters of fatty acids, or as triglycerides. In the presence of acetyl chloride/ MeOH, free fatty acids are esterified to form methyl esters and the alkyl esters (except methyl esters) are transesterified to methyl esters. The dried extracts (0.2 g) were transferred to 25 mL screw cap vials for derivatization<sup>35</sup>. The dried extracts were redissolved in 10mL of toluene/ MeOH (1:1) and spiked with 10  $\mu\text{L}$  of 45 mg/mL of triundecanoin (internal standard)  $\text{C}_{11}$  standard. Acetyl chloride was added to this solution, which reacted with methanol to provide a catalytic amount of HCl required to initiate acid hydrolysis (i.e. digestion). The vial was then purged with a stream of nitrogen, capped and placed on a sand bath for 1 hour at  $100^{\circ}\text{C}$ . After the vial was cooled to room temperature, 10 mL of 6% sodium carbonate was added to quench the reaction and the resulting solution was mixed vigorously to assist phase separation. This solution was further centrifuged for 5 minutes and the organic layer that resulted was then used for GC-MS analysis.



#### **2.3.4. GC-MS Analysis**

A Hewlett Packard (Little Falls, DE) 5890 Series II GC was interfaced to an HP 5972 series Mass Selective Detector (MSD) for GC-MS analysis. A DB-5 MS (0.25mm × 30m,  $d_f = 0.25\mu\text{m}$ ) from J&W Scientific (Folsom, CA) was used for separations. An HP 7673 GC automatic injector was used to introduce 1  $\mu\text{L}$  of organic layer in the splitless mode. The injector and detector temperatures were maintained at 300°C. The oven temperature was held initially at 40°C for 2 min and then ramped to 145°C at 4°C/min and held for 1 min, then heated at 5 °C/min to 220°C and held for 30 min, and finally heated at 7°C/min to 300°C and held for 10 min. The extractables were identified using an HP Chem Station equipped with the Wiley library of mass spectral data. The composition of the extracts is expressed in terms of weight percent of each identified analyte in the total extract.

#### **2.3.4 Solid Phase Micro Extraction (SPME) Analysis**

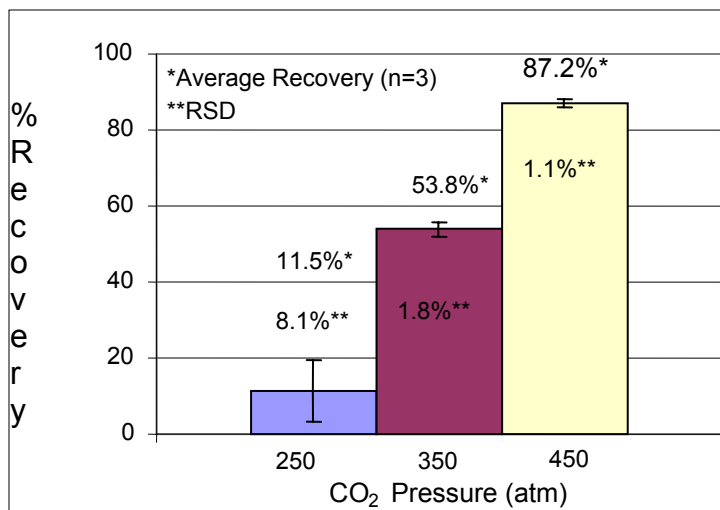
SPME was used to determine the presence of volatiles in cranberry seed extract. The optimized SF extract was diluted with 5mL of a mixture of dichloromethane and methanol (1:1). A carbowax/divinylbenzene (CW/DVB) fiber (Supelco Inc., Bellefonte, PA) was exposed for 60 min to the headspace of the diluted cranberry seed extract<sup>36</sup>. The assembly was kept at 30°C with stirring. The fiber was then desorbed for 5 min in the injection port of an HP 6890 Series GC interfaced with a HP 5973 Series MSD. The injector temperature was maintained at 220°C. The helium flow was kept at 2mL/min. The oven temperature was initially maintained at 40°C for 3 min and then ramped at 4°C/min to 100°C and finally heated to 220°C at 15°C/min.

## 2.4 Results and Discussion

### 2.4.1 Extraction

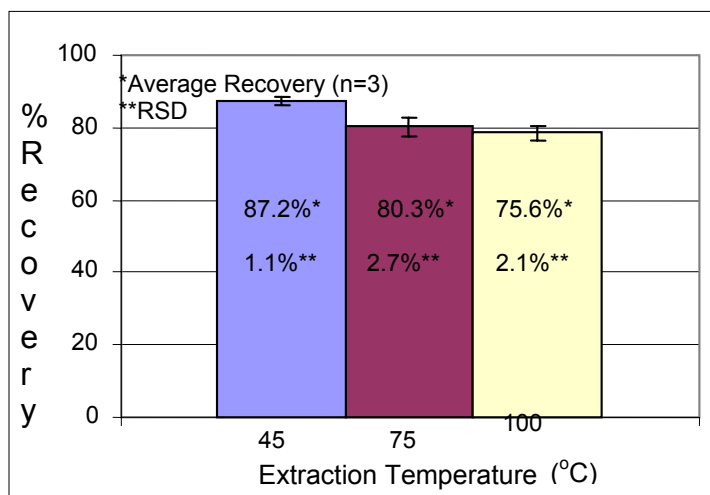
SFE parameters such as CO<sub>2</sub> pressure, flow rate, extraction temperature, and extraction time were varied in order to estimate the best extraction conditions. Figure 5 shows the relationship between CO<sub>2</sub> pressure and percent recovery. At a constant temperature (45°C), as the density increased from 0.87 g/mL (250 atm) to 0.97 g/mL (450 atm), the percent recovery increased dramatically from 11.5% to 87.2%. Since the density of CO<sub>2</sub> at 450 atm is greater than the density of CO<sub>2</sub> at 250 atm and the extraction time is same, the amount of CO<sub>2</sub> used was greater when the extraction was done at 450 atm as compared to the extraction done at 250 atm. This dramatic increase could be due to the increased solvating power of CO<sub>2</sub> at higher densities.

Generally, an increase in temperature at constant pressure causes an increase in the vapor pressure of the solute (which increases analyte extractability) but a decrease in supercritical solvent density (which decreases analyte extractability). So the extraction is governed by two opposing factors. Figure 6 shows the effect of extraction temperature on the percent recovery. Paired t-testing at 95% confidence limit shows that the recovery at 45°C (87.2%) was significantly higher than at 75°C (80.3%, p-value = 0.02) and at 100°C (75.6%, p-value = 0.006) seems to indicate that CO<sub>2</sub> density is the more dominant factor. A p-value less than 0.05 for two values suggests that the two values are significantly different from each other at 95% confidence limit.



**Figure 9. Effect of CO<sub>2</sub> Pressure on Percent Recovery**

Extraction temp. : 45°C, Extraction time : 45 min, CO<sub>2</sub> Flow rate : 1mL/min

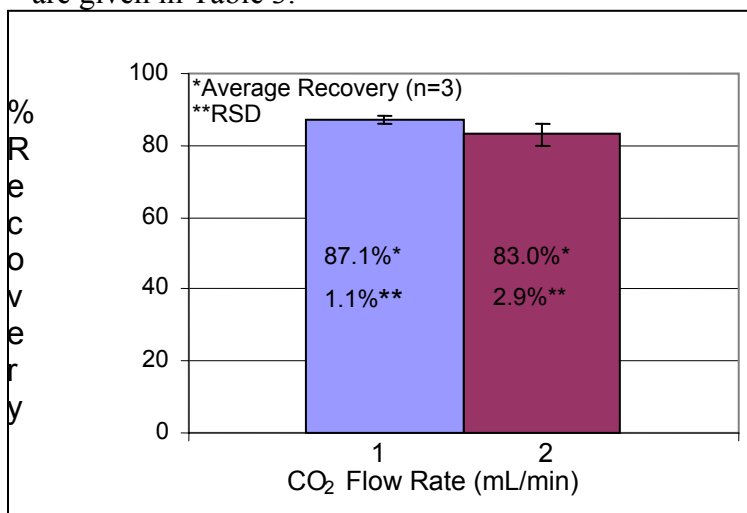


**Figure 10. Effect of Extraction Temperature on Percent Recovery**

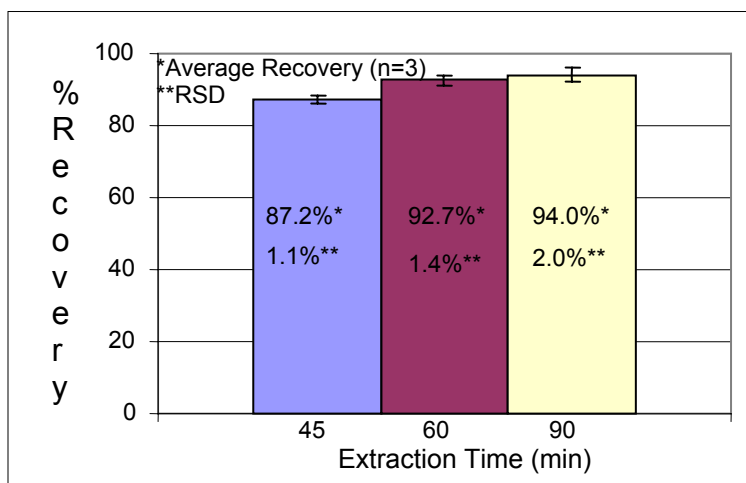
CO<sub>2</sub> Pressure = 450 atm, Extraction time : 45 min, CO<sub>2</sub> Flow rate : 1mL/min

As the CO<sub>2</sub> flow rate (Figure 6) was increased from 1mL/min to 2mL/min, recovery did not significantly change (p-value at 95% confidence was 0.057), in spite of the fact that twice as much CO<sub>2</sub> was used at the higher flow rate. This could be due to the additional force generated by decompressed gas at the restrictor at the higher flow rate (~1000mL/min versus 500mL/min of decompressed CO<sub>2</sub>) resulting in 'blow-by' trap

loss. Figure 8 shows that extraction in the dynamic mode for 45 minutes was significantly less than dynamic extraction for 60 min (p-value at 95% confidence limit was 0.041) whereas the recoveries were not significantly when the dynamic extraction time was increased from 60 minutes to 90 minutes (p-value at 95% confidence limit was 0.123). Based on these data, the optimized SFE extraction conditions, for pure CO<sub>2</sub> extractables, are given in Table 3.



**Figure 11. Effect of CO<sub>2</sub> Flow Rate on Percent Recovery**  
CO<sub>2</sub> pressure : 450 atm, Extraction time : 45 min, Extraction temp. =45°C



**Figure 12. Effect of Extraction Time on Percent Recovery**  
CO<sub>2</sub> pressure : 450 atm, Extraction temp. =45°C, CO<sub>2</sub> Flow rate : 1mL/min

**Table 3. Optimized SFE conditions for CO<sub>2</sub> extraction of cranberry seeds**

Extracting Solvent	Pure CO <sub>2</sub>
Restrictor Temperature	55°C
Trap	C <sub>18</sub> Silica
Trap Rinsing Solvent	5 mL (1:1 DCM + MeOH)
Static Time	15 min
Trap Temperature-Extraction	-30°C
Trap Temperature-Rinse	25°C
Pressure of CO <sub>2</sub>	450 atm
Extraction Temperature	45°C
Dynamic Time	90 min
CO <sub>2</sub> Liquid Flow Rate	1mL/min

Comparison of optimized SFE with a 24 hour Soxhlet extraction in terms of percent recovery, extraction time, and reproducibility shows significant differences. Both the methods, SFE and Soxhlet (e.g. SFE=94% relative to Soxhlet). An obvious advantage of SFE (1.5 hours) over Soxhlet (24 hours) lies in the time required for extraction. SFE (RSD=2.0%) was also more reproducible than Soxhlet extraction (RSD=3.4%) although the mass of the seed extracted via supercritical CO<sub>2</sub> was smaller than that extracted by Soxhlet (1g versus 10g).

#### **2.4.2 Composition of extracts**

When the free fatty acids were chromatographed on the DB-5 capillary column, some fatty acids remained on the column even after the end of the run. So the Soxhlet and the SFE extracts were derivatized to convert the free fatty acids in the extracts into their methyl esters because the methyl esters are more volatile as compared to the free fatty acids.

When the Soxhlet and the optimized supercritical CO<sub>2</sub> extracts were derivatized and subjected to GC-MS, 21 analytes were separated and identified (Table 4). The GC-MS chromatograms (Figures 9,10,11,12) show that both methods extracted the same analytes and the composition of the extracts was similar. The extracts contained methyl esters of saturated fatty acids such as palmitic acid, docosanoic acid, tricosanoic acid, tetracosanoic acid, and hexacosanoic acid (peaks 4,14,15,16,17 respectively). Among the unsaturated fatty acids, the extracts contained methyl esters of omega-3 fatty acid such as  $\alpha$ -linolenic acid (peak 9), omega-6 fatty acids such as linoleic acid and eicosadienoic acid (peak 7 and 10), and omega-9 fatty acids such as oleic acid, palmitoleic acid, and eicosenoic acid (peaks 8,3, and 11). In addition, several hydrocarbons were tentatively identified (e.g. peaks 13 and 19). An alkyne such as 4-hexadecen-6-yne (peak 13), a hydrocarbon such as squalene (peak 18) and a phytosterol such as  $\beta$ -sitosterol (peak 21) were also found. Peak 19 showed mass spectral data characteristic of tocopherols and could contain either  $\gamma$ -tocopherol (match quality =93) or  $\beta$ - tocopherol (89) or a mixture of these two tocopherols. The mass spectra of peak 20 shows ions at masses 426,411,218,203, and 189 which is characteristic of amyirin (pentacyclic triterpene alcohol) and was identified accordingly. No readily volatile material was found in either of the extracts.

M.Palma<sup>37</sup> et al studied the extraction of grape seeds with pure SF CO<sub>2</sub> and analyzed the extracts by GC-MS. These extracts were found to contain volatiles such as aliphatic aldehydes in addition to fatty acids and sterols. Even though we used similar conditions for our SFE extraction and GC-MS analysis, we were unable to detect any similar volatile compounds.

To further investigate the presence of volatiles in the cranberry seed extract, we adapted a SPME method from the work of Jelen et al.<sup>36</sup> who had developed it for the characterization of volatile compounds in different vegetable oils. SPME followed by gas chromatography was performed on the headspace of the cranberry seed extract to test the presence of volatile compounds in different vegetable oils. The GC trace failed to show the elution of any components for either of the two extracts.

The major component of cranberry seed extracted via pure CO<sub>2</sub> or hexane was linoleic acid (omega-6 fatty acid). The broad intense linoleic acid peak is believed to be a mixture of the positional isomers of the C18:2 fatty acid such as 9,12-Octadienoic acid, 8,11-Octadienoic acid, 5,7-Octadienoic acid, and 9,11-Octadienoic acid. The C18 dienoic acid accounted for the major bulk of both cranberry seed extracts as were determined by total ion chromatogram and extracted ion chromatogram (Fig.8) with an internal standard. Two other C18 fatty acids were identified: oleic acid and linolenic acid. The extracted ion of mass  $297 \pm 0.5$  (Fig. 10) seen at retention time 44.296 min corresponds to oleic acid (molecular weight = 296.5, match quality = 91%). The extracted ion of mass  $293 \pm 0.5$  (Fig. 11) seen at retention times 44.318 corresponds to linolenic acid (molecular weight = 292.46, match quality = 99%).

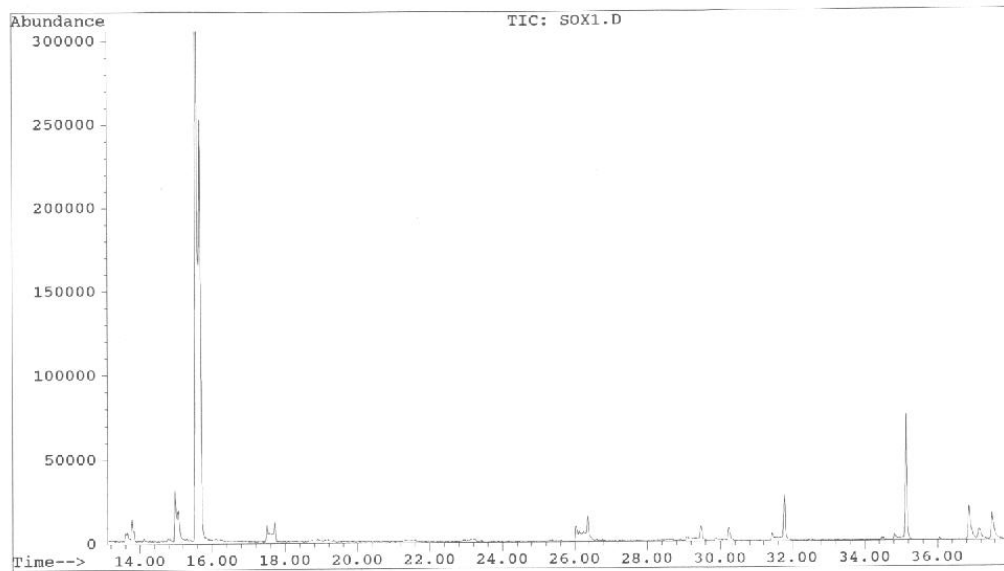
Some of the peaks between 9 and 10 corresponded to various positional isomers of esters of fatty acids but they were not identified in this work due to their poor match quality (<70%).

**Table 4. Analysis of extractables from cranberry seeds using GC-MS**

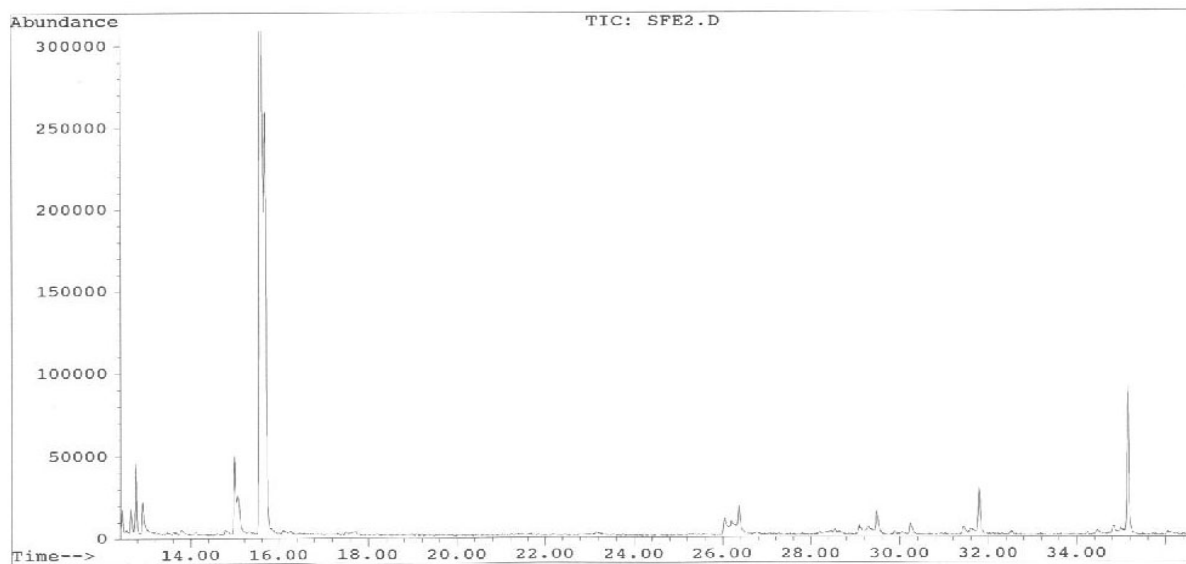
Peak No.	Analyte identified	Match quality	Soxhlet (w/w)	SFE (w/w)
1	Tridecanoic acid, 12-methyl- (13:0)	94	0.1%	0.1%
2	Pentadecanoic acid (15:0)	93	0.01%	0.01%
3	Palmitoleic acid (16:1)	93	0.07 %	0.6%
4	Palmitic acid (16:0)	97	9 %	6%
5	Cyclopentanoic acid, 2-hexyl	78	0.05%	0.04%
6	Heptadecanoic acid (17:0)	95	0.02%	0.02%
7	Linoleic acid (18:2)	95	71 %	72%
8	Oleic acid (18:1)	91	13%	13%
9	Linolenic acid (18:3)	90	6%	6%
10	Eicosadienoic acid (20:2)	95	0.2%	0.2%
11	Eicosenoic acid (20:1)	93	0.3%	0.1%
12	Eicosanoic acid (20:0)	98	0.1%	0.1%
13	4-Hexadecen-6-yne	91	0.1%	0.1%
14	Docosanoic acid (22:0)	99	0.1%	0.1%
15	Tricosanoic acid (23:0)	90	0.01%	0.01%
16	Tetracosanoic acid (24:0)	98	0.04%	0.03%
17	Hexacosanoic acid (26:0)	90	0.03%	0.02%
18	Squalene	70	0.005%	0.005%
19	$\gamma$ -tocopherol	93	0.02%	0.01%
	$\beta$ - tocopherol	89		
20	<sup>+</sup> Amyrin			
21	$\beta$ - sitosterol	90	1.1%	1.0%

<sup>+</sup>The mass spectral data for this peak shows ions at masses 426,411,218,203, and 189 which is characteristic of amyryn





**Figure 13. Soxhlet Extract (12min to 35 min)**



**Figure 14. SF Extract (12 min to 35 min)**

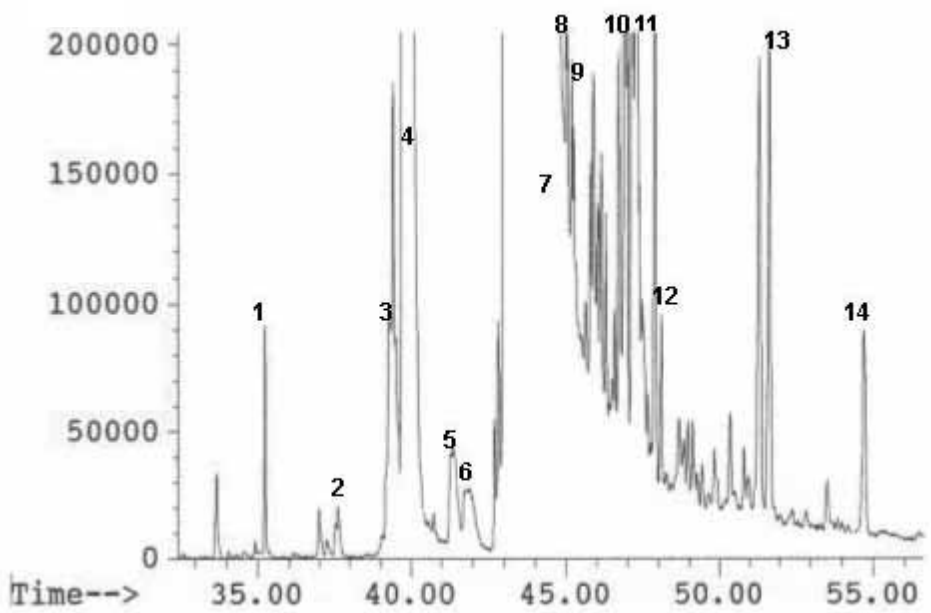


Figure 15. Derivatized Soxhlet extractables (peak 1 through peak 14)

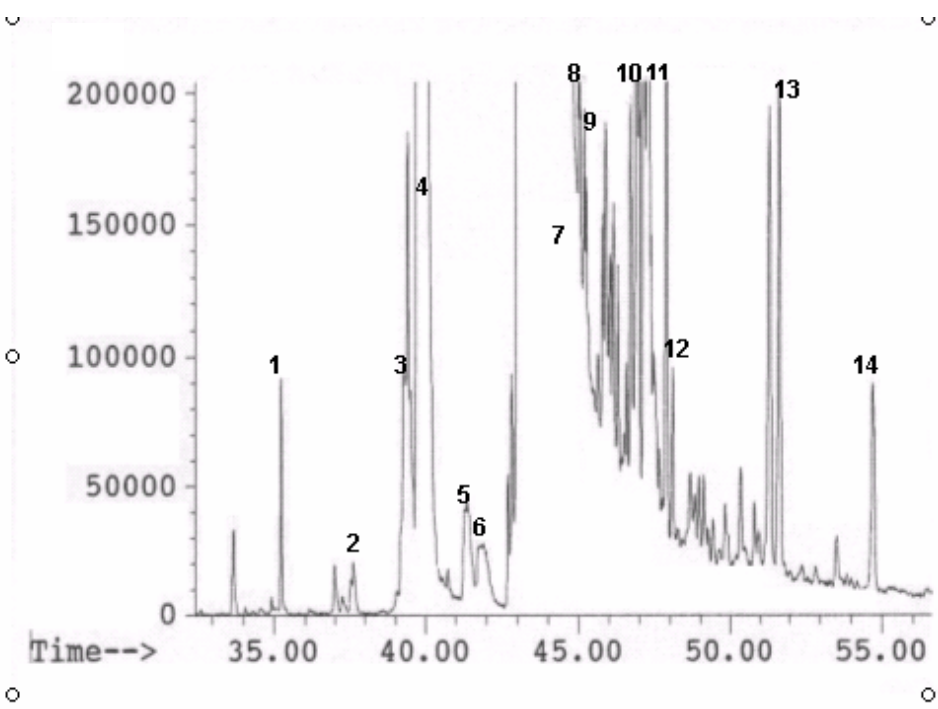
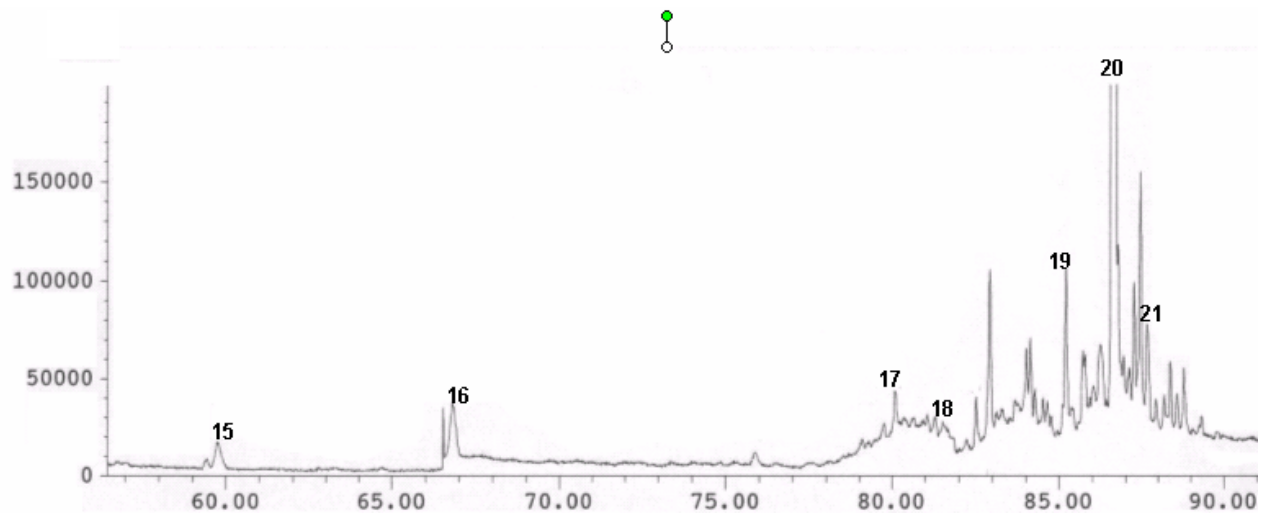
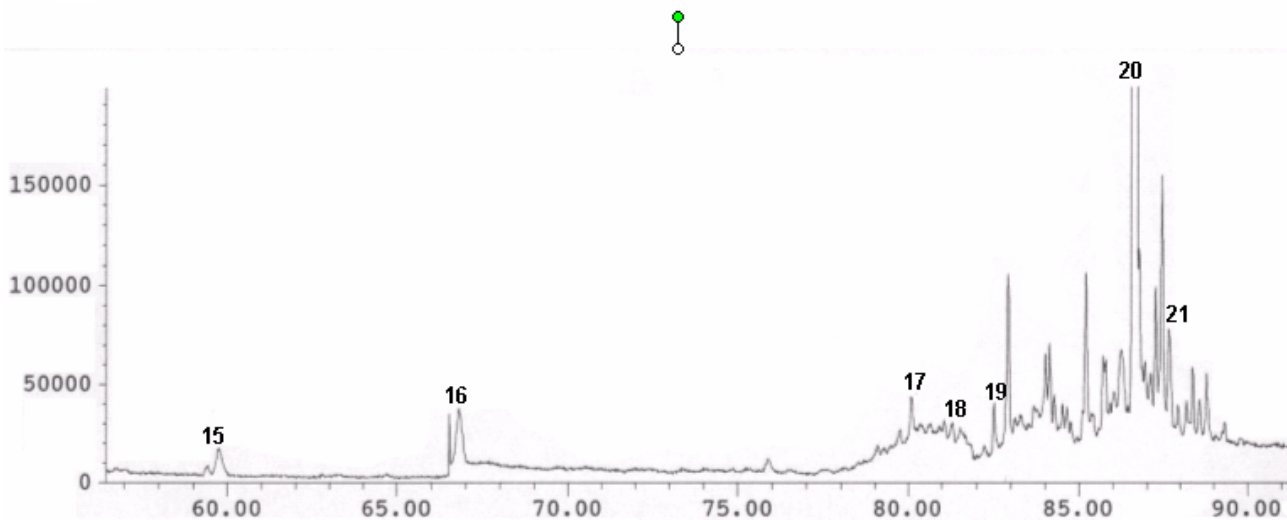


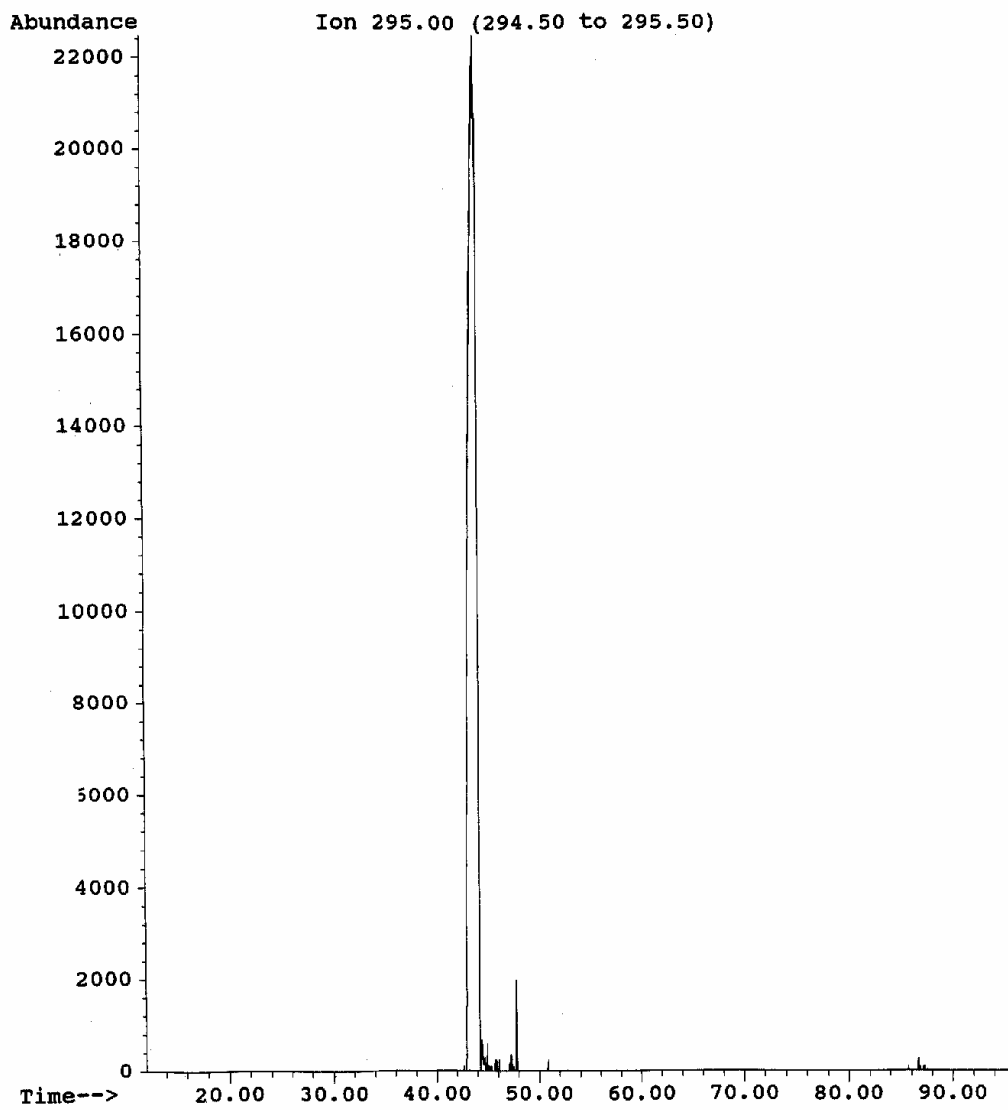
Figure 16. Derivatized SF extractables (peak 1 through peak 14)



**Figure 17. Derivatized Soxhlet extractables (peak 15 through peak 21)**



**Figure 18. Derivatized SF extractables (peak 15 through peak 21)**



**Figure 19. Extracted ion chromatogram of Linoleic acid (C 18:2)**

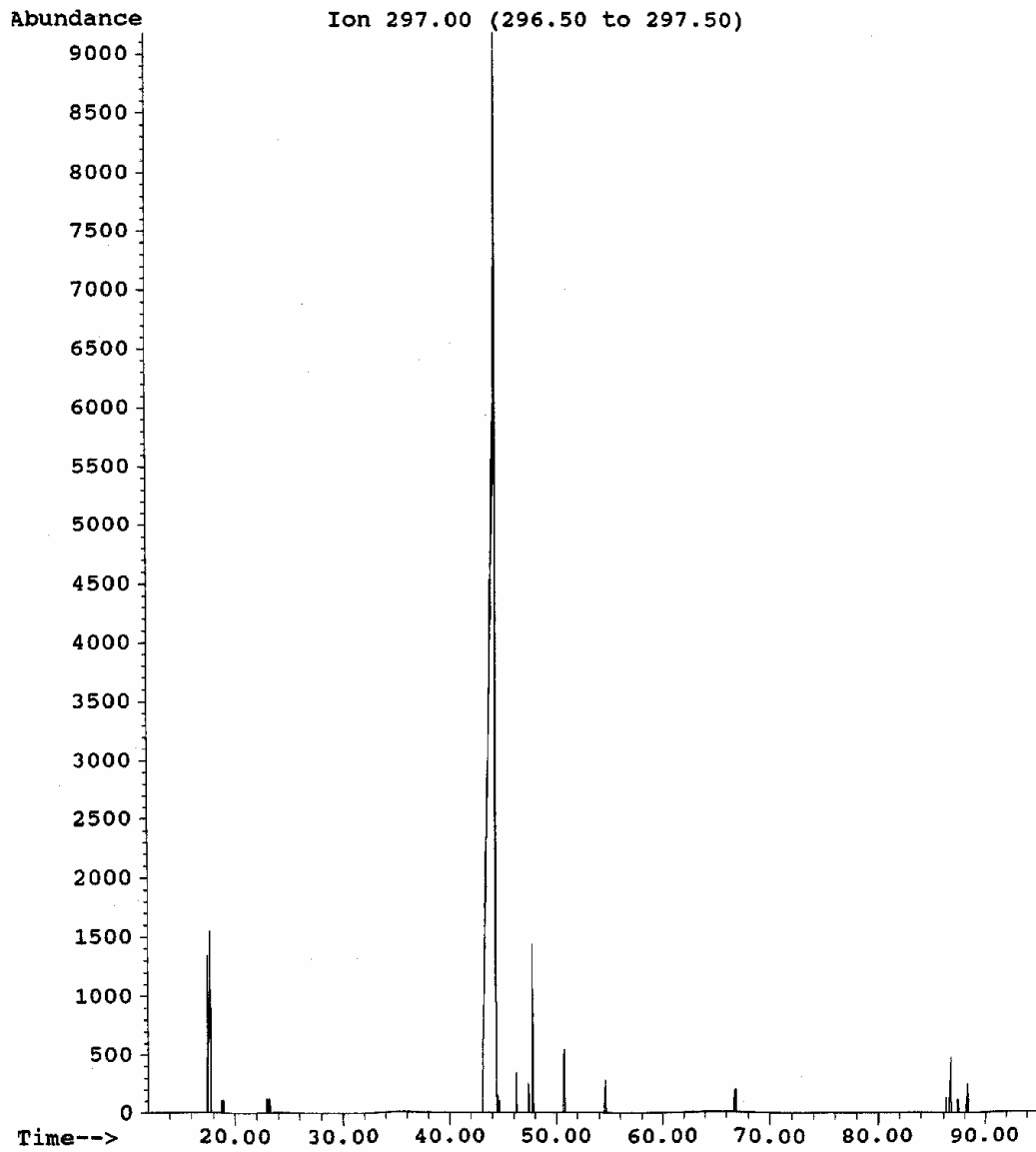


Figure 20. Extracted ion chromatogram of Oleic acid (C 18:1)

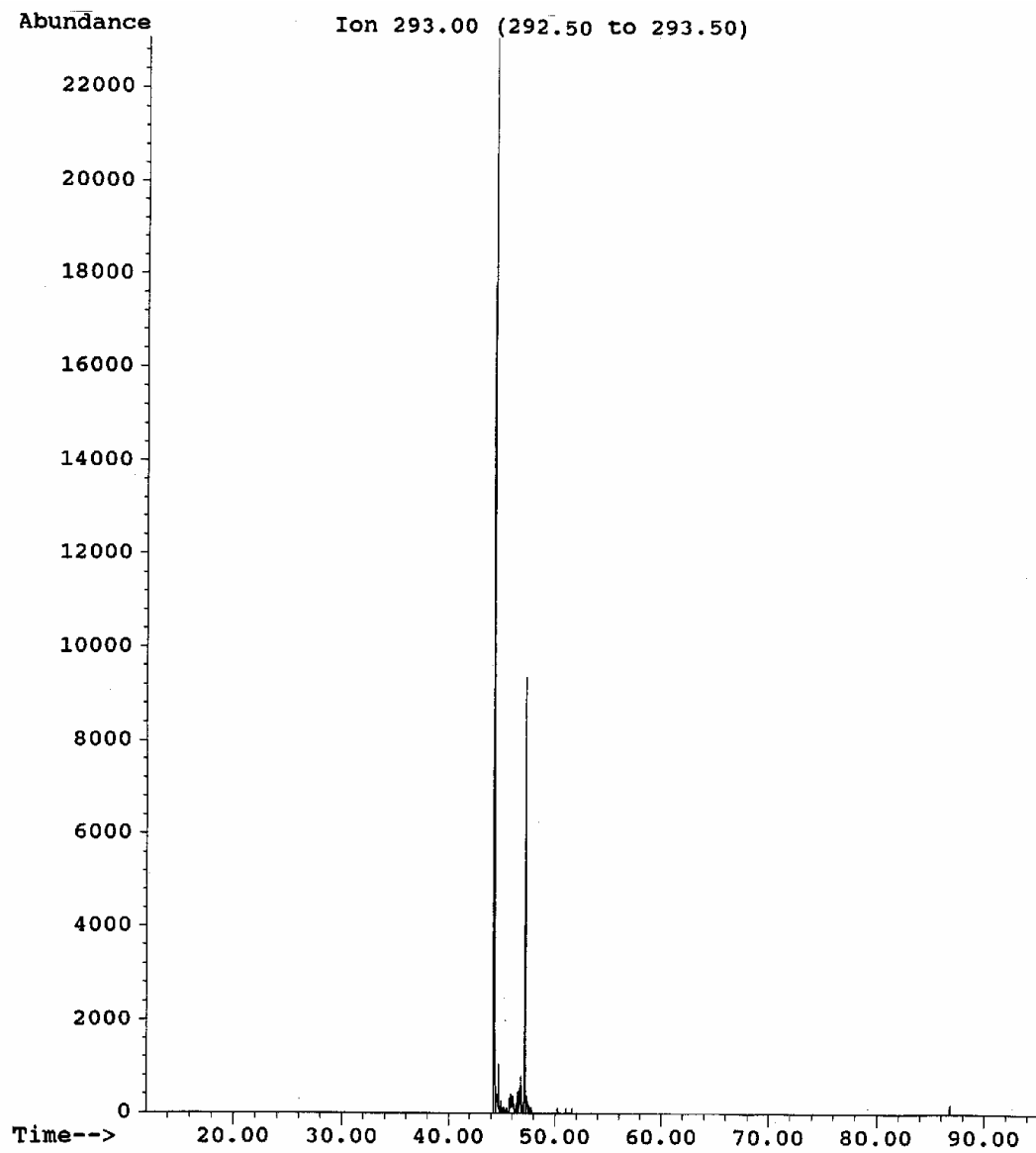
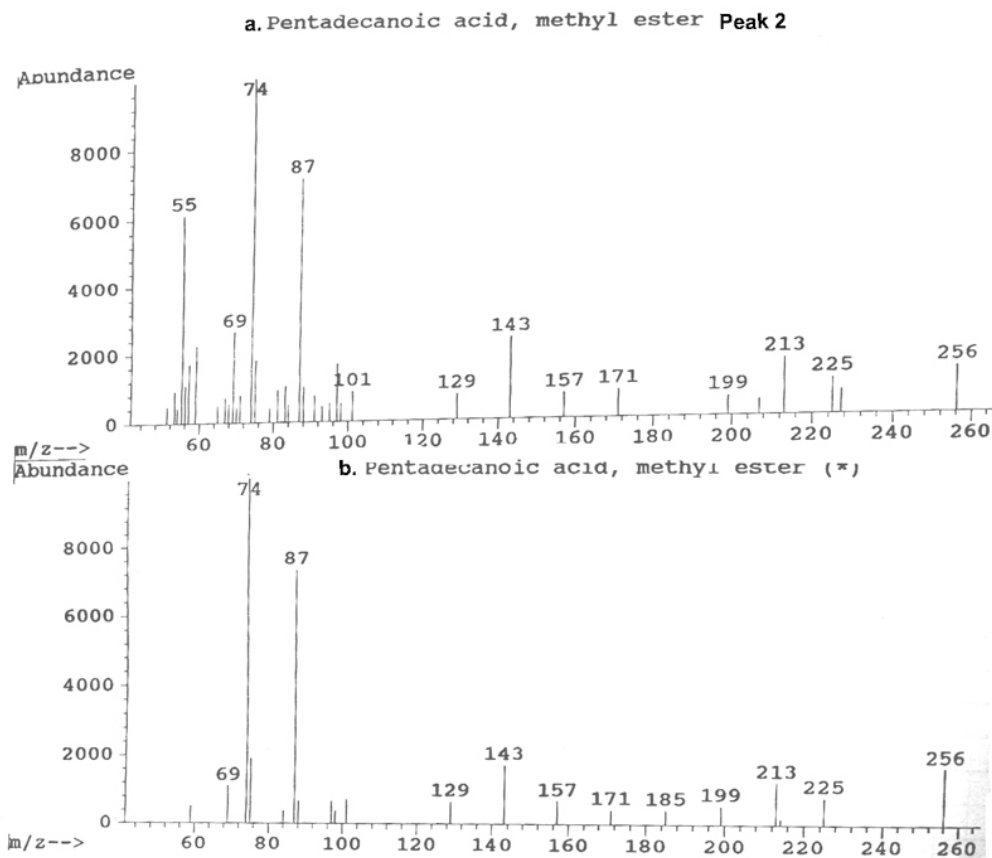


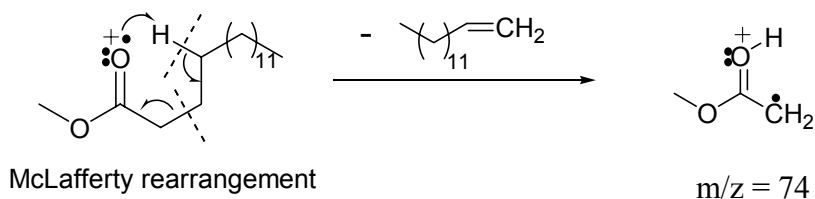
Figure 21. Extracted ion chromatogram of Linolenic acid (C18:3)

The peak assignments for the SF extract were made by using a HP Chem Station equipped with Wiley library of mass spectral data. For most of the compounds identified, the match quality between the mass spectra of the peak and the mass spectra of standard was greater than 90. Since the SF extracts were rich in fatty acid methyl esters, the mass spectral interpretation of a typical aliphatic ester, pentadecanoic acid methyl ester, is discussed below.



**Figure 22. Mass spectral data of Pentadecanoic acid methyl ester  
a. Analyte b. Standard from Wiley library**

The mass spectrum of aliphatic methyl esters typically shows a fragment at  $m/z$  74 which is due to the McLafferty rearrangement. The mass spectra of aliphatic



**Figure 23. McLafferty rearrangement**

methyl esters also show fragments at different m/z values due to the C-C bond cleavage, however they show a particularly strong signal due to the removal of fragment  $\text{CH}_2\text{CH}_2\text{COOCH}_3$  (m/z =87).

As mentioned earlier, the composition of cranberry seed oil has been studied R. Croteau<sup>8</sup> and I. Fagerson. The extracting solvent used in that method was isopropanol, isopropanol-chloroform, and chloroform. So their extracts also contained more polar lipids such as glycolipids and phospholipids in addition to neutral lipids. SFE was more selective as the SF extract contained only neutral lipids and also no clean up was necessary. The combined isopropanol –chloroform extracts contained lipids as well as non-lipids. The lipids were separated from the non-lipids by gel chromatography and were further separated on a silicic column into neutral lipids, glycolipids, and phospholipids. The extracts were then derivatized and the derivatized extracts were analyzed by GC-FID. The components of the extract were then identified by co-injection with authentic standards.

Table 5 shows the composition of the neutral<sup>8</sup> lipid extract (w/w) and the SF extract (w/w). The SF extracts were richer in fatty acid methyl ester as compared to the neutral lipid extract. The SF extracts were richer in fatty acids as compared to the neutral

**Table 5. Composition of neutral lipid extract<sup>8</sup> and SF extract**

	<b>Analyte identified</b>	<b>SFE (w/w)</b>	<b>Reference<sup>8</sup> (w/w)</b>
1	Tridecanoic acid, 12-methyl- (13:0)	0.1%	
2	Pentadecanoic acid (15:0)	0.01%	
4	Palmitic acid (16:0)	9 %	5%
6	Heptadecanoic acid (17:0)	0.02%	
12	Eicosanoic acid (20:0)	0.1%	
14	Docosanoic acid (22:0)	0.1%	
15	Tricosanoic acid (23:0)	0.01%	
16	Tetracosanoic acid (24:0)	0.04%	
17	Hexacosanoic acid (26:0)	0.03%	



	Analyte identified	SFE (w/w)	Reference (w/w)
7	Linoleic acid (18:2)	71 %	25%
8	Oleic acid (18:1)	13%	22%
9	Linolenic acid (18:3)	6%	22%
3	Palmitoleic acid (16:1)	0.07 %	
10	Eicosadienoic acid (20:2)	0.2%	
11	Eicosenoic acid (20:1)	0.3%	
5	Cyclopentanoic acid, 2-hexyl	0.05%	
13	4-Hexadecen-6-yne	0.1%	
18	Squalene	0.005%	3%
19	$\gamma$ -tocopherol, $\beta$ - tocopherol	0.02%	
20	$\beta$ - sitosterol	1.1%	3% (TMS)
21	Amyrin	0.02%	3.5% (TMS)
22	Stigmasterol		0.5% (TMS)
23	Campesterol		1% (TMS)
24	Hydrocarbons (C16, C18, C20, C22)		7%
25	Ursolic acid		8% (TMS)

Fatty acids were identified as their methyl esters

lipid extract. The SF extracts contained trace amounts of fatty acid methyl esters e.g. docosanoic acid methyl ester and eicosanoic acid methyl ester which were not identified in the neutral<sup>8</sup> lipid extract. Since the paper published by R. Croteau<sup>8</sup> and I. Fagerson has no chromatograms, it is not possible to know whether all the peaks in their GC-FID chromatograms were identified. The analytes in the extract were identified by comparing the retention times of the standard with the retention time of a standard. However, this method does not permit the unambiguous identification of an analyte because two different analytes can have similar retention time. In our study, the SF extracts were analyzed by GC-MS. GC-MS is a superior technique compared to GC-FID because the

peaks are identified by comparison of the mass spectrum of the peak to the mass spectrum of a standard from the Wiley library.

In the R. Croteau<sup>8</sup> and I. Fagerson study, the triperpenic alcohols and sterols were derivatized into their trimethylsilyl ether derivatives using bis-trimethylsilylacetamide. The isopropanol-chloroform<sup>8</sup> extract also contained higher amounts of sterols and triterpenic alcohols such as  $\beta$ -sitosterol and amyirin compared to the SF extract. This could be due to the high polarity of the extracting solvent and the increased volatility of the derivatized sterols and triterpenic compounds. In addition to those compounds, the isopropanol-chloroform extract also contained ursolic acid, a polar triterpenic acid, which was not extracted with pure CO<sub>2</sub>.

## 2.5 Conclusions

The yield of cranberry seed oil via Soxhlet extraction was 23.1% and via SFE was 21.4%. This result is similar to the lipid composition (23.3%) of cranberry seed oil obtained by R. Croteau and I. Fagerson<sup>7</sup>. The optimized SFE conditions for extracting fatty acids from cranberry seeds were: CO<sub>2</sub> pressure = 450 atm, extraction temperature = 45°C, CO<sub>2</sub> flow rate = 1 mL/min, and extraction time = 90 min. SFE showed better RSD, comparable recoveries and shorter extraction time as compared to the Soxhlet method. GC-MS analysis showed that the extracts contained mainly linoleic acid, which is an omega-6 acid, oleic acid, which is an omega-9 acid, linolenic acid, which is an omega-9 acid, and palmitic acid. The extracts also contained some other therapeutically useful omega-6 acids, omega-3 acids, omega-9 acids, phytosterols, tocopherols, pentacyclic triterpene alcohols, in minor quantities. The cranberry seed extracts via both CO<sub>2</sub> and hexane contained a higher concentration of beneficial unsaturated fatty acids as compared to saturated fatty acids. Thus, SFE seems to be a viable alternative to Soxhlet method for extraction of fatty acids from cranberry seeds.

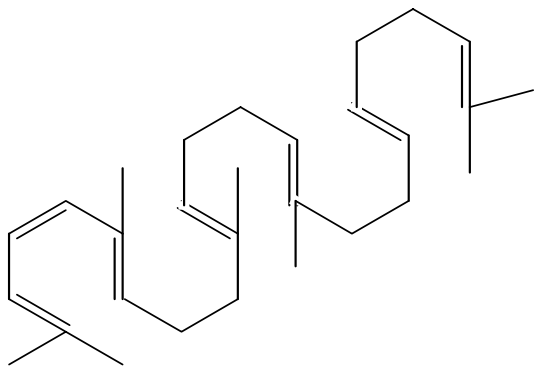
SFE was more selective as compared to the LSE with isopropanol, chloroform, and, isopropanol-chloroform. Glycolipids and phospholipids were found in the LS extract but were not extracted by SFE. The SF extracts were also cleaner than the LS extracts and did not require the various clean up procedures required by the latter extraction method. The SF extracts were richer in fatty acids whereas the isopropanol-chloroform combined extracts were richer in the more polar and high molecular weight lipids.

## References

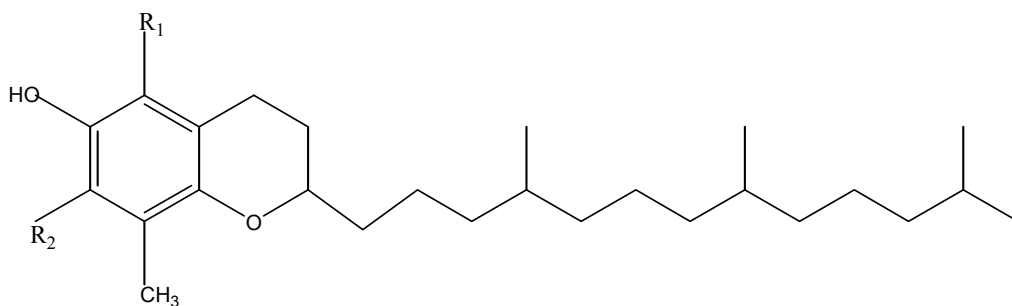
1. Wildman, E. *Handbook of Nutraceuticals and Functional foods*, CRC press, Florida, **2001**.
2. Block, G.; Patterson, B.; Subar, A. *Nutr. Cancer* **1992**, *18*, 1.
3. *AURI AG Innovation News* **1999**, *8*, 12.
4. Charlie Thompson, R.; Morris, S. *LCGC* **2001**, *19*, 1142.
5. Wagner, J. *Nutr. Outlook* **2001**, *4*, 27.
6. Sandler, R. *Cranberry Production : A Guide for Massachusetts*, University of Massachusetts, Massachusetts, **1997**.
7. Nawar, W. *International Conference and Exhibition on Nutraceuticals and Functional Foods*, September 13-17, Houston, Texas, **2000**.
8. Croteau, R.; Fagerson, I. *Phytochemistry* **1969**, *8*, 2219.
9. Prior, R.; Lazarus, S.; Hammerstone, J.; Muccitelli, H. *J. Agric. Food Chem.* **2001**, *49*, 1270.
10. Hakkinen, S.; Karenlampi, S.; Heinonen, M.; Mykkanan, H.; Ritta Torronen, A. *J. Agric. Food Chem.* **1999**, *47*, 2274.
11. Hakkinen, S.; Karenlampi, S.; Heinonen, M.; Mykkanan, H.; Ritta Torronen, A. *Food Res. Int.* **1999**, *32*, 345.
12. Chen, H.; Zuo, Y.; Deng, Y. *J. Chromatogr A* **2001**, *913*, 387.
13. Bilyk, A.; Sapers, G. *J. Agric. Food Chem.* **1986**, *34*, 585.
14. Bonilla, F.; Mayen, M.; Merida, J.; Medina, M. *Food Chem.* **1999**, *66*, 209.
15. Taylor, L. *Supercritical Fluid Extraction*, Wiley Inter-Science New York **1996**.
16. Tipstrisukond, N.; Fernando, L.; Clarke, A. *J. Agric. Food Chem.* **1998**, *46*, 4329.
17. Trela, B.; Rios, A.; Valcarcel, M. *J. Agric. Food Chem.* **1996**, *44*, 1253.
18. Gao, L.; Mazza, G. *J. Agric. Food Chem.* **1995**, *43*, 343.
19. Palma, M.; Pineiro, Z.; Barroso, C. *J. Chromatogr A* **2001**, *921*, 169.
20. Palma, M.; Taylor, L. *J. Agric. Food Chem.* **1999**, *47*, 5044.

21. Palma, M.; Taylor, L. *J. Chromatogr A* **1999**, *849*, 117.
22. Gomez, A.; Lopez, C.; Martinez de la Ossa, E. *Chem. Engrg. J.* **1996**, *61*, 227.
23. Yee, W.; Cho, Y.; Oh, S.; Park, W.; Cha, J.; Jung, J.; Choi, Y. *Food Sci. Biotechnol.* **2000**, *9*, 174.
24. Beveridge, T.; Li, T.; Drover, J. *J. Agri. Food Chem.*, **2002**, *50*, 744.
25. McDaniel, L.; Ashraf-Khorassani, M.; Taylor, L. *J. Supercrit. Fluids* **2001**, *19*, 275.
26. Ashraf-Khorassani, M.; Ude, M.; Doane-Weideman, T.; Tomczak, J.; Taylor, L. *J. Agri. Food Chem.* **2002**, *50*, 1822.
27. Coulston, A. *Am. J. Clin. Nutr.* **1999**, *70*, 512S.
28. Feldman, E. *J. Nutr.* **2002**, *132*, 1062S.
29. Gester, H. *Int. J. Vitam. Nutr. Res.* **1998**, *68*, 159.
30. Uauy, R.; Valenzuela, A. *Nutrition* **2000**, *16*, 680.
31. Stone, W. *Am. J. Clin. Nutr.* **2003**, *77*, 700.
32. Liu, M.; Wallmon, A.; Olsson-Mortlock, C.; Wallin, R.; Saldeen, T. *Biochem. Biophys. Res. Commun.* **1998**, *252*, 703.
33. Byer, T.; Perry, G. *Annu. Rev. Nutr.* **1992**, *12*, 139.
34. Siman, S.; Povey, A.; Ward, T.; Margison, G.; Sheffield, E. *Br. J. Cancer* **2000**, *83* 69.
35. Ashraf-Khorassani, M.; Ude, M.; Doane-Weideman, T.; Tomczak, J.; Taylor, L. *J. Agri. Food Chem.* **2002**, *50*, 1822.
36. Jelen, H.; Obuchowska, M.; Zawirska-Wojtasiak, R.; Wasowicz, E.; *J. Agri. Food Chem.* **2000**, *48*, 2360.

## Appendix



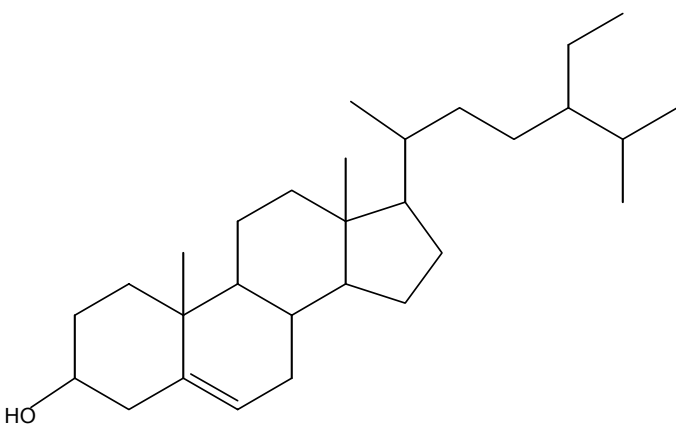
**Figure 24. Structure of Squalene (peak 18)**



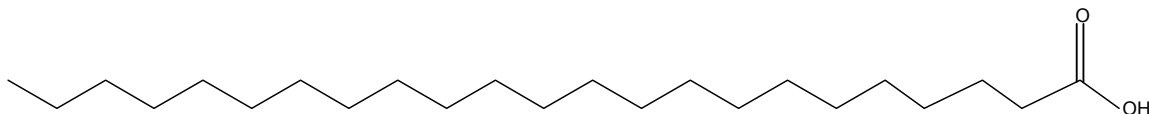
**Figure 25. Structure of  $\beta$ -tocopherol,  $\gamma$ -tocopherol (peak 19)**

$\beta$ -tocopherol : R<sub>1</sub> = CH<sub>3</sub>, R<sub>2</sub> = H

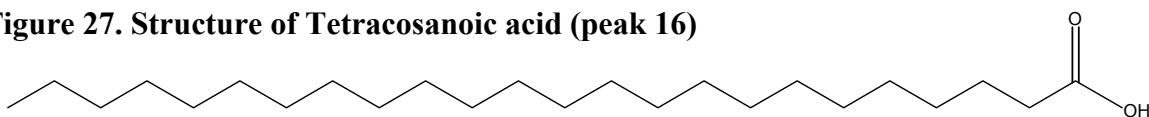
$\gamma$ -tocopherol : R<sub>1</sub> = H, R<sub>2</sub> = CH<sub>3</sub>



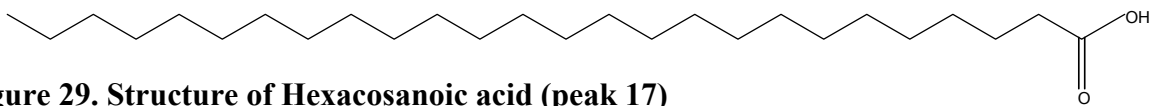
**Figure 26. Structure of  $\beta$ -sitosterol (peak 21)**



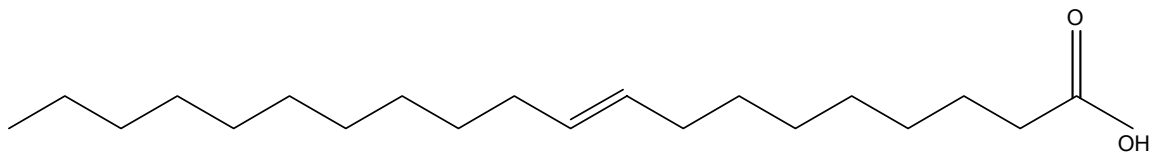
**Figure 27. Structure of Tetracosanoic acid (peak 16)**



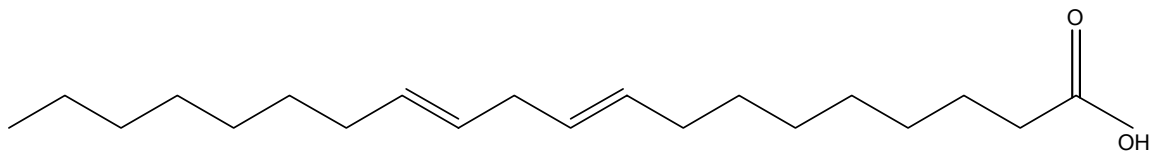
**Figure 28. Structure of Tricosanoic acid (peak 15)**



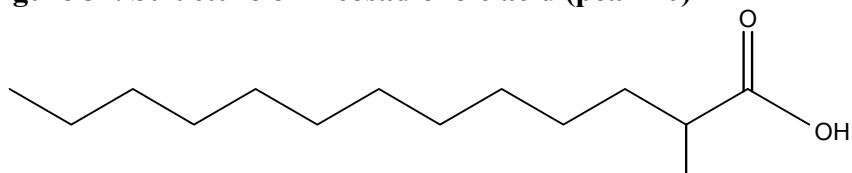
**Figure 29. Structure of Hexacosanoic acid (peak 17)**



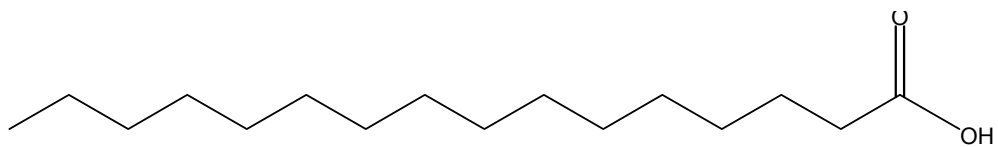
**Figure 30. Structure of Eicosenoic acid (peak 11)**



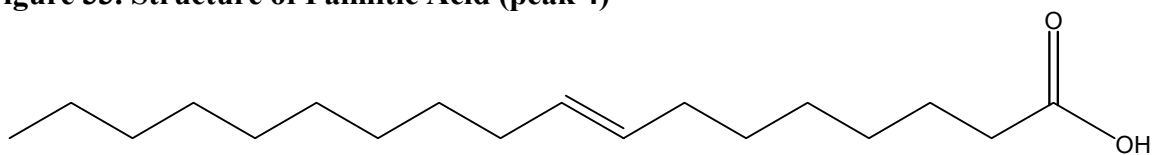
**Figure 31. Structure of Eicosadienoic acid (peak 10)**



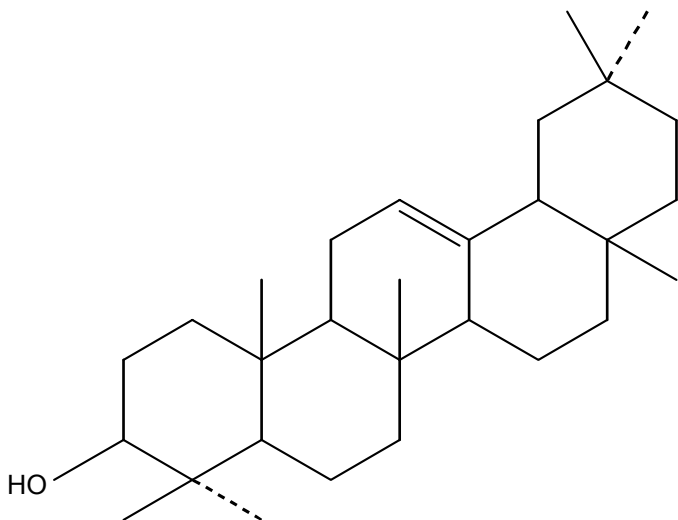
**Figure 32. Structure of Tridecanoic acid, 12-methyl (peak 1)**



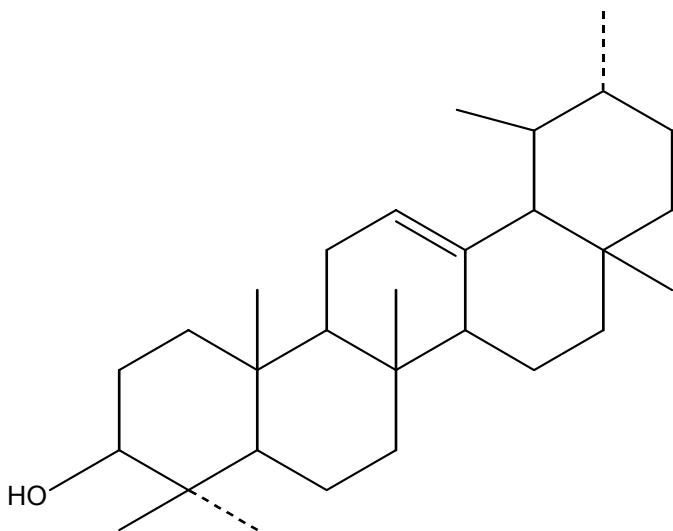
**Figure 33. Structure of Palmitic Acid (peak 4)**



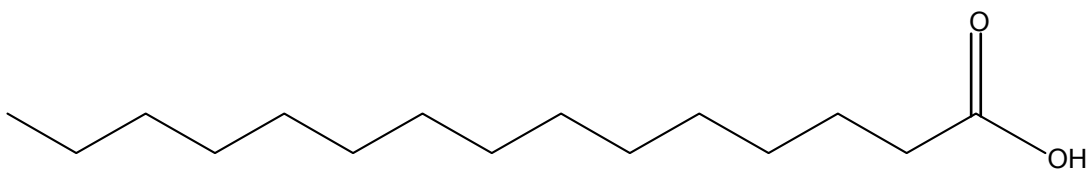
**Figure 34. Structure of Oleic acid (peak 8)**



**Figure 35. Structure of  $\alpha$ -Amyrin (peak 20)**

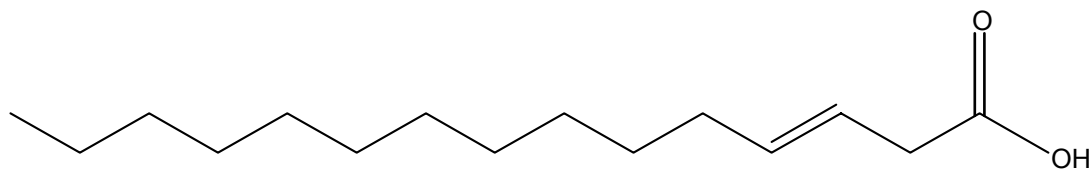


**Figure 36. Structure of  $\beta$ -amyrin (peak 20)**

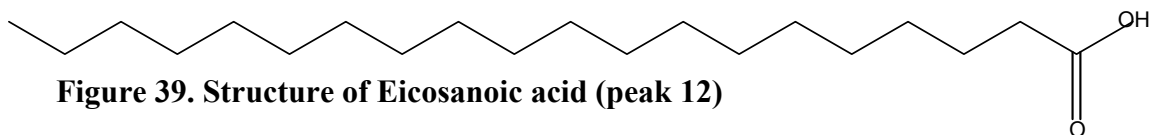


**Figure 37. Structure of Pentadecanoic acid (peak 2)**

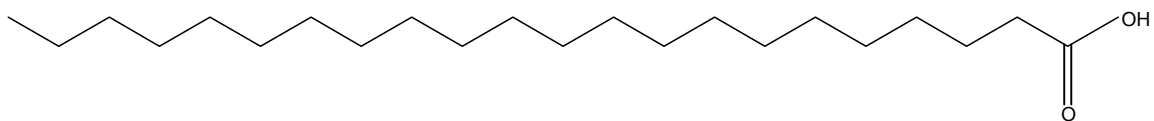




**Figure 38. Structure of Palmitoleic (peak 3)**



**Figure 39. Structure of Eicosanoic acid (peak 12)**



**Figure 40. Structure of Docosanoic acid (peak 4)**

a. Tridecanoic acid, 12-methyl-, methyl ester (Peak 1)

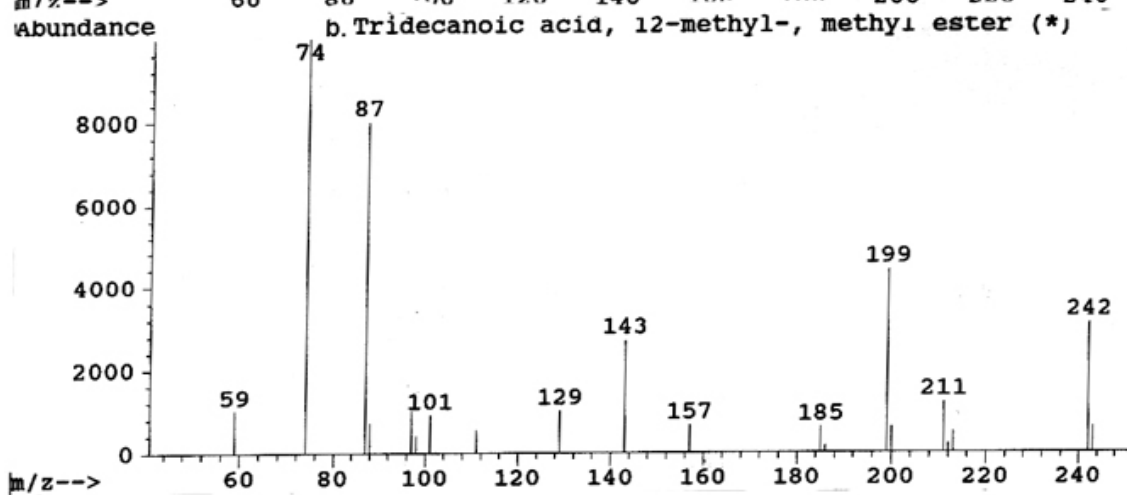
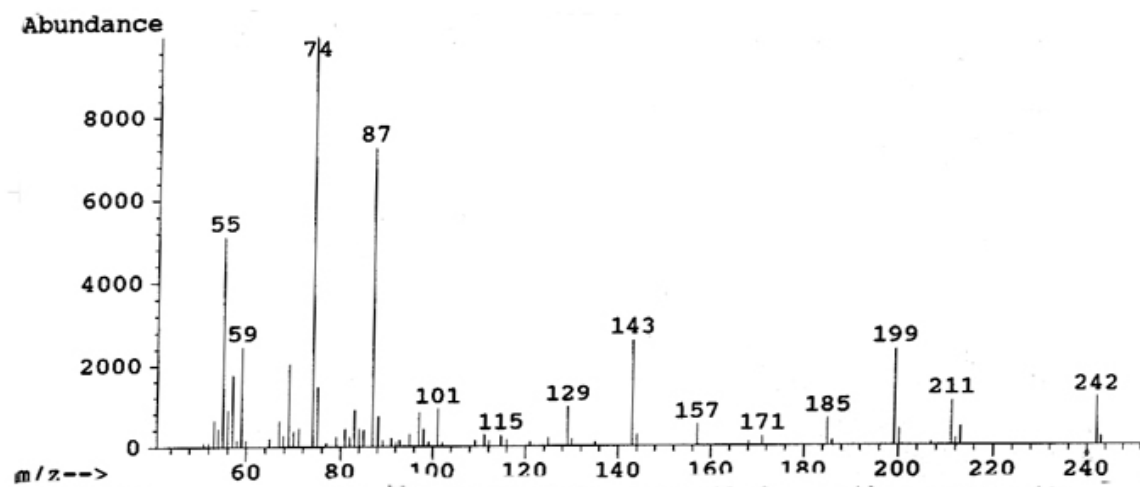


Figure 41. Mass spectral data for Tridecanoic acid, 12-methyl-, methyl ester  
a. Analyte b. Spectra from HP Chem Station Wiley library

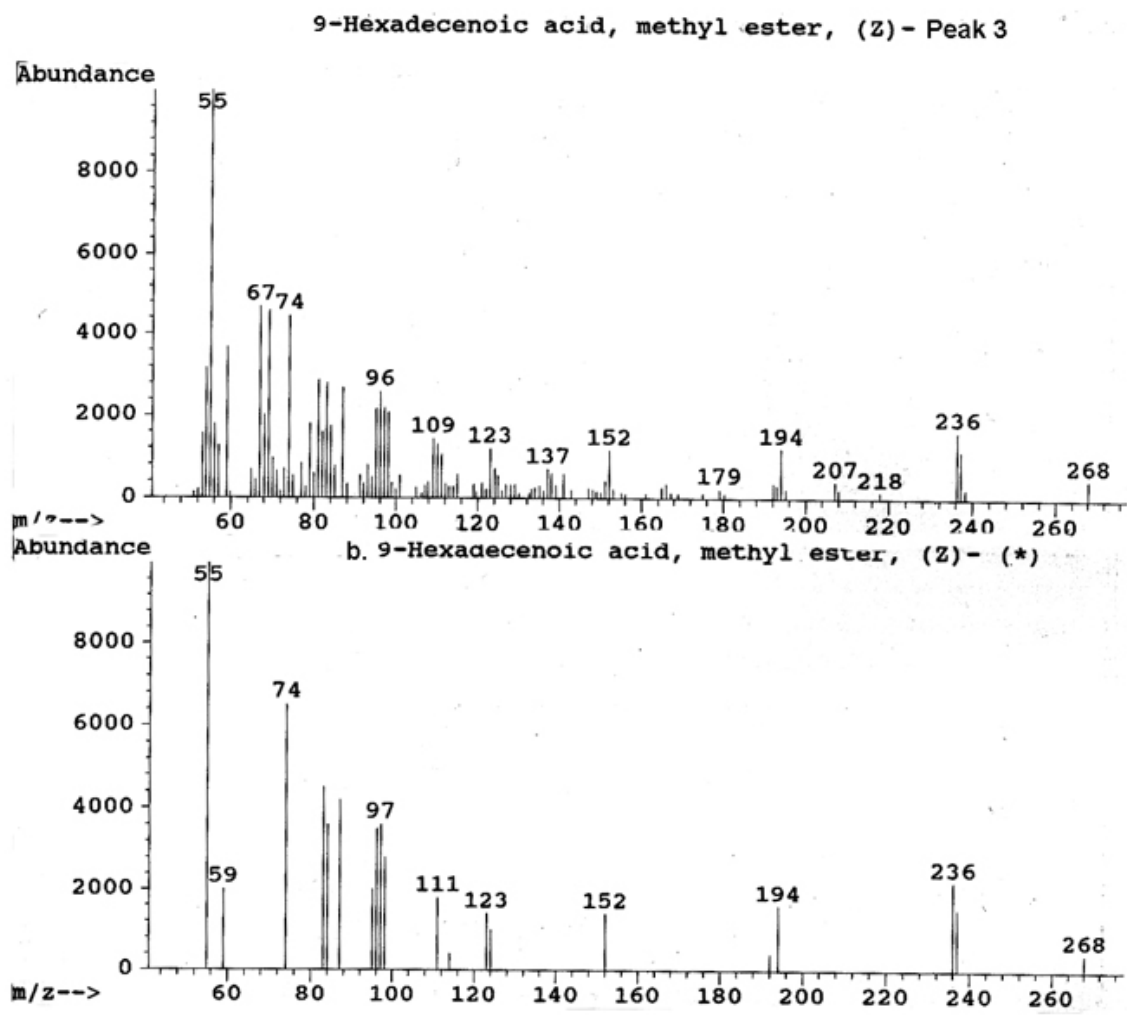
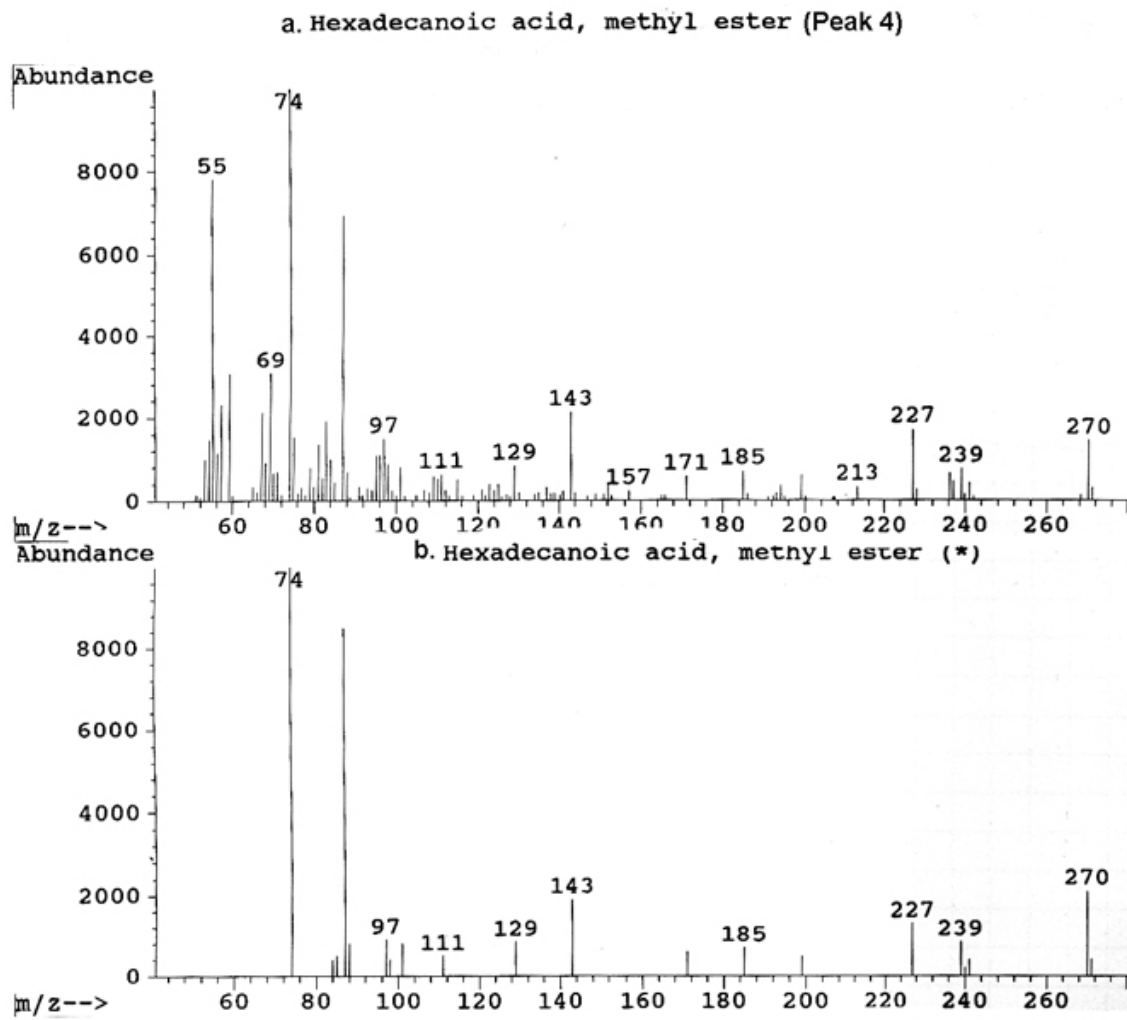
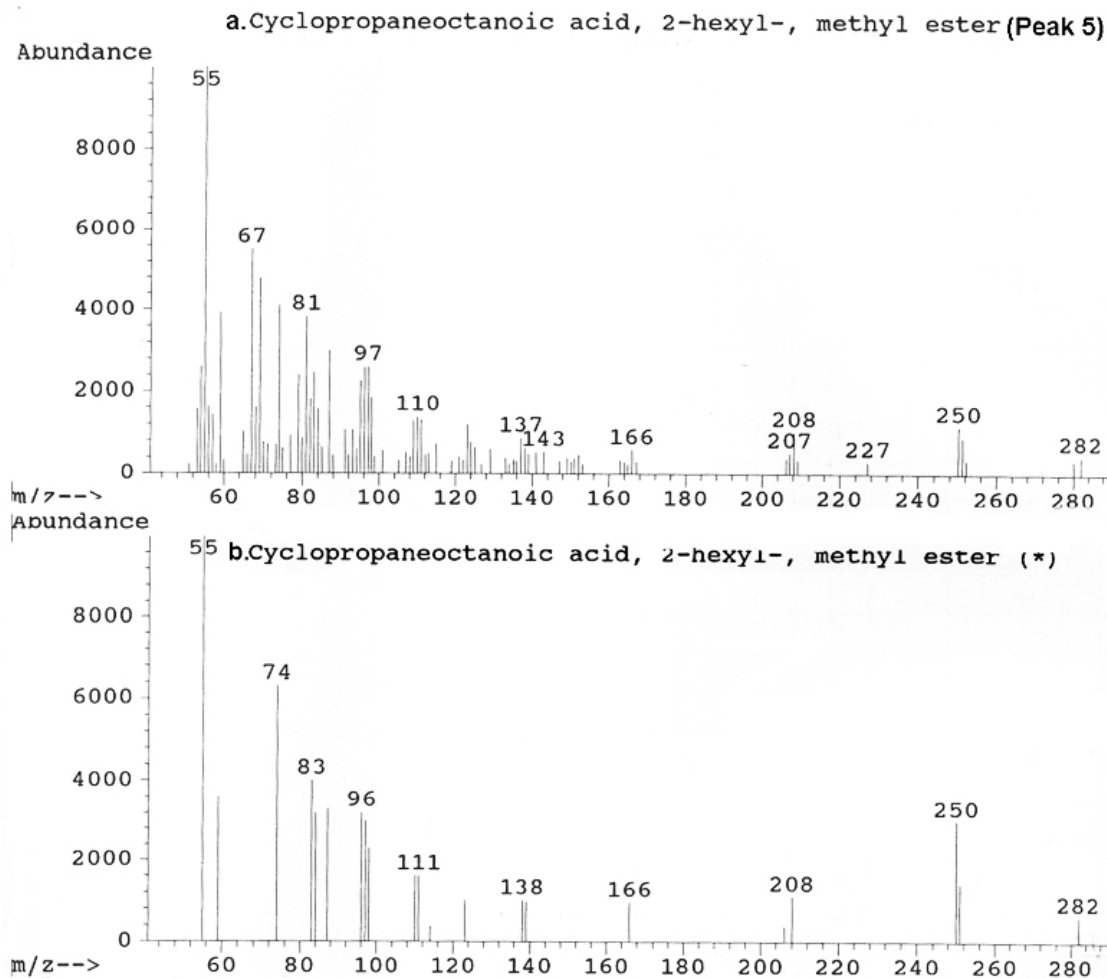


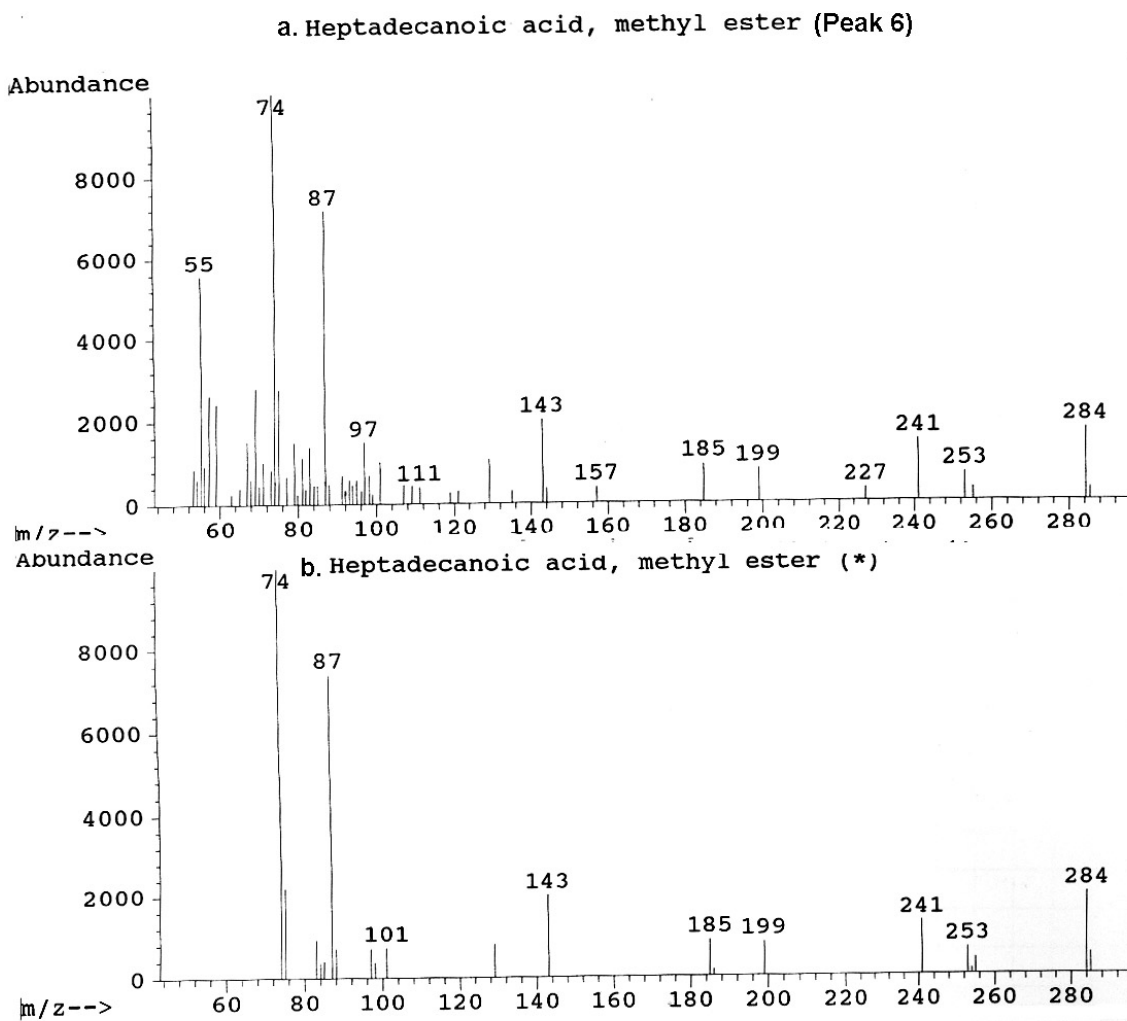
Figure 42. Mass spectral data for 9-Hexadecenoic acid methyl ester  
 a. Analyte b. Spectra from HP Chem Station Wiley library



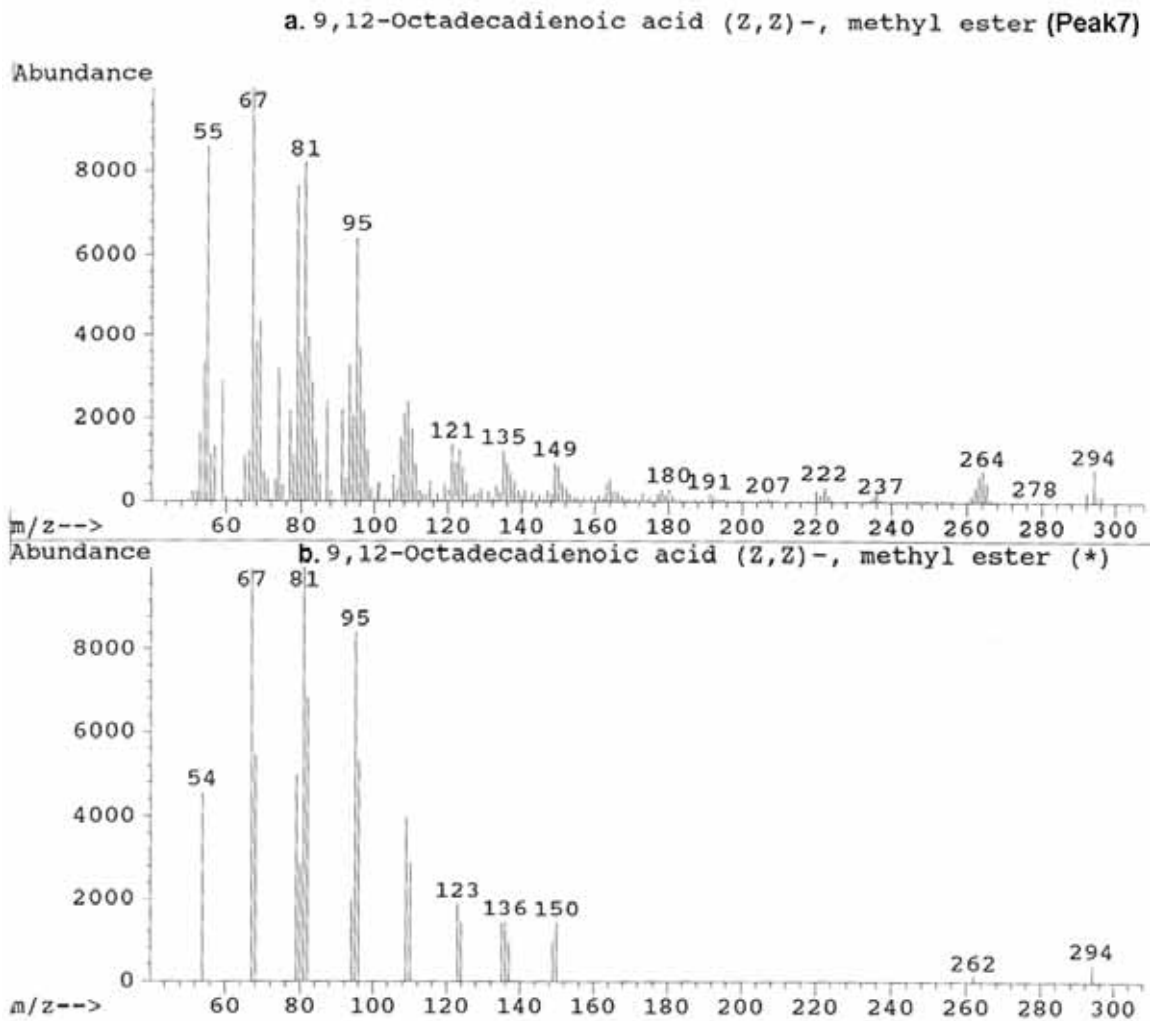
**Figure 43. Mass spectral data for Hexadecanoic acid methyl ester  
a. Analyte b. Spectra from HP Chem Station Wiley library**



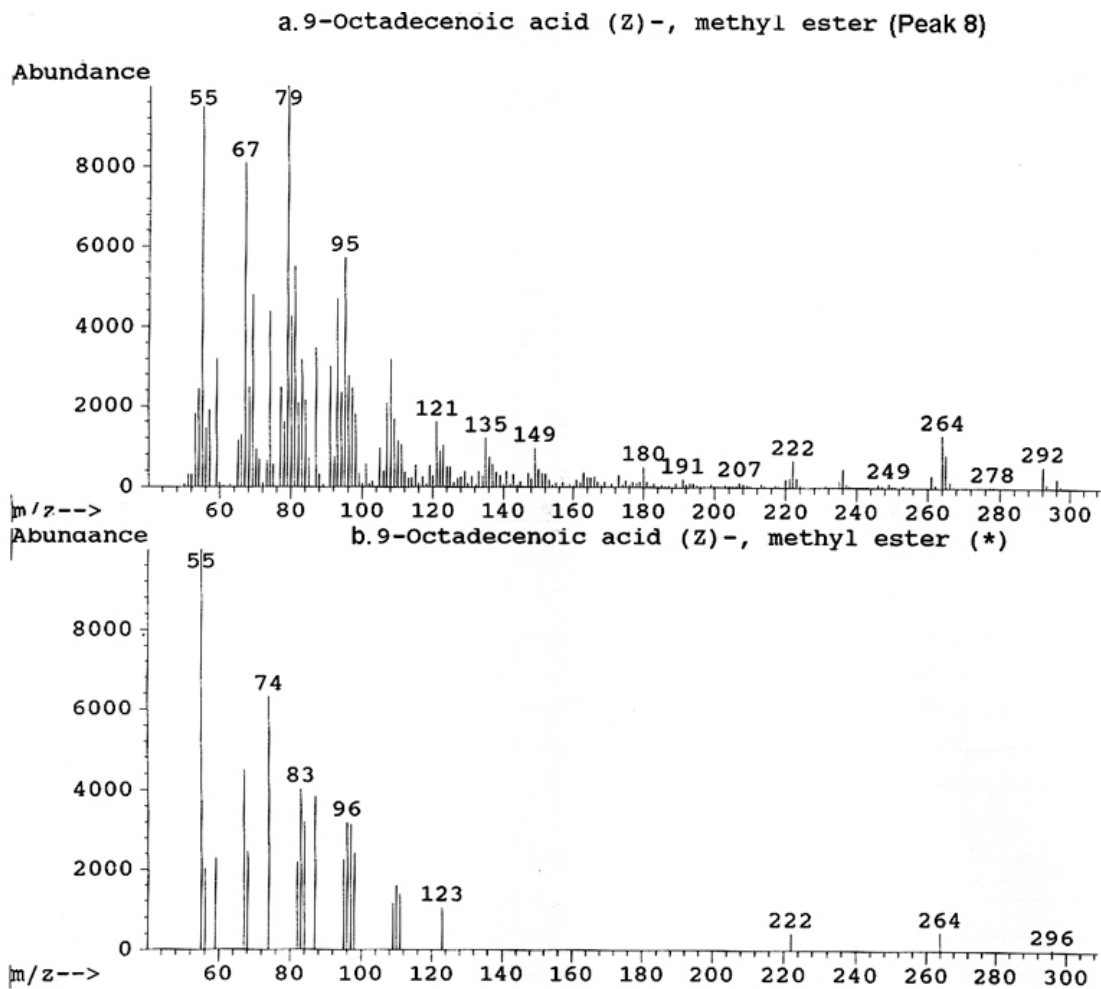
**Figure 44. Mass spectral data for Cyclopropaneoctanoic, 2-hexyl acid methyl ester  
a. Analyte b. Spectra from HP Chem Station Wiley library**



**Figure 45. Mass spectral data for Heptadecanoic acid methyl ester**  
**a. Analyte b. Spectra from HP Chem Station Wiley library**

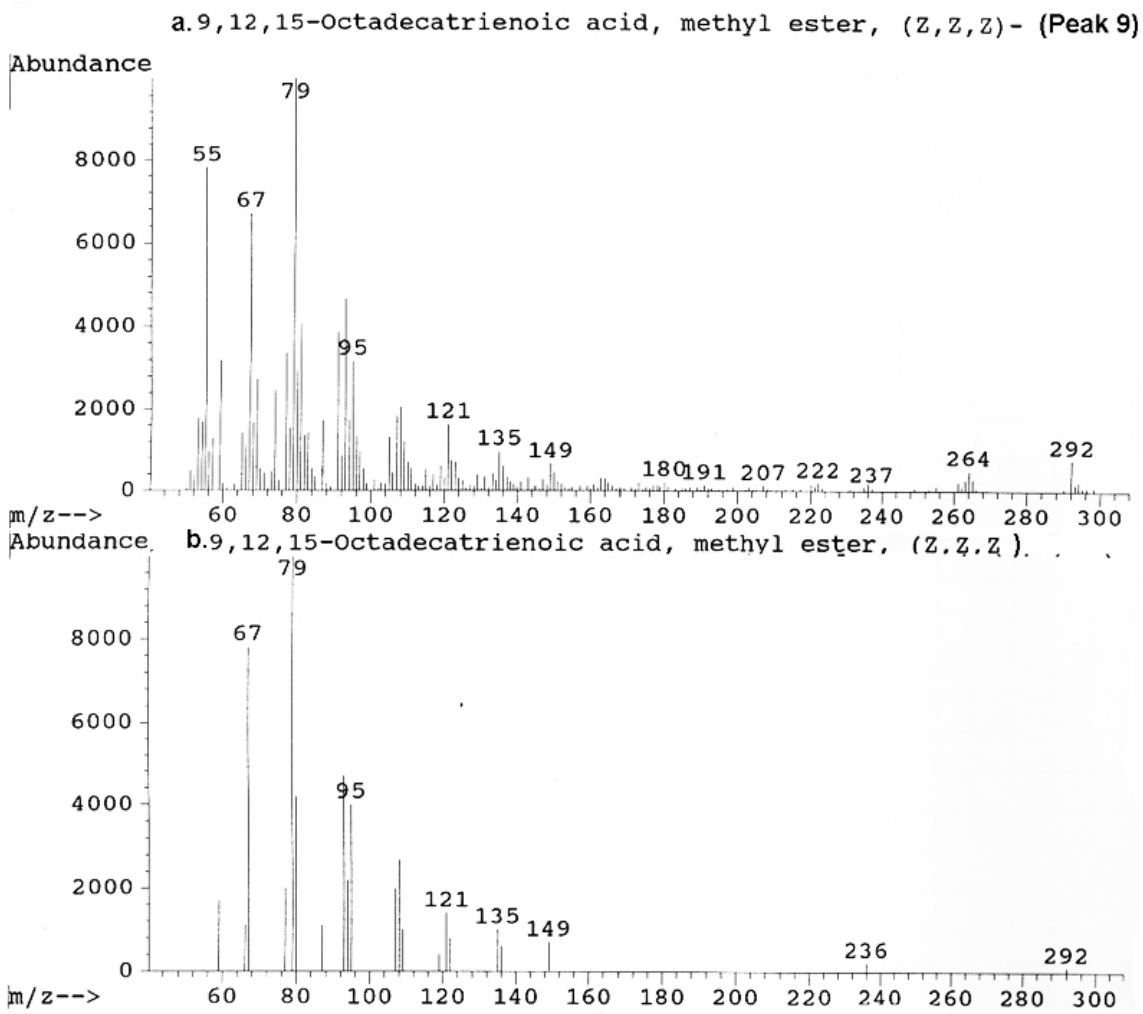


**Figure 46. Mass spectral data for 9,12 Octadecadienoic acid methyl ester  
a. Analyte b. Spectra from HP Chem Station Wiley library**

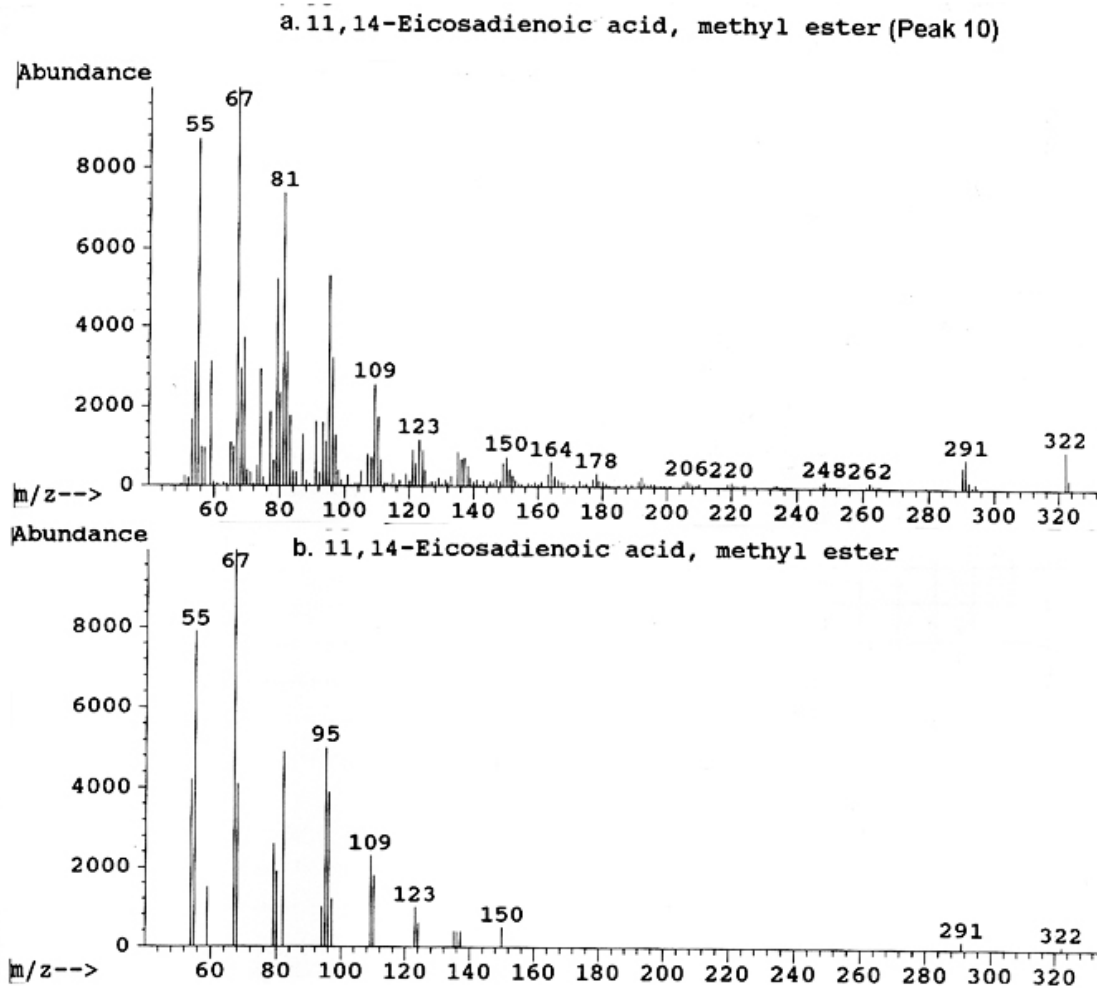


**Figure 47. Mass spectral data for 9-Octadecenoic acid methyl ester  
a. Analyte b. Spectra from HP Chem Station Wiley library**

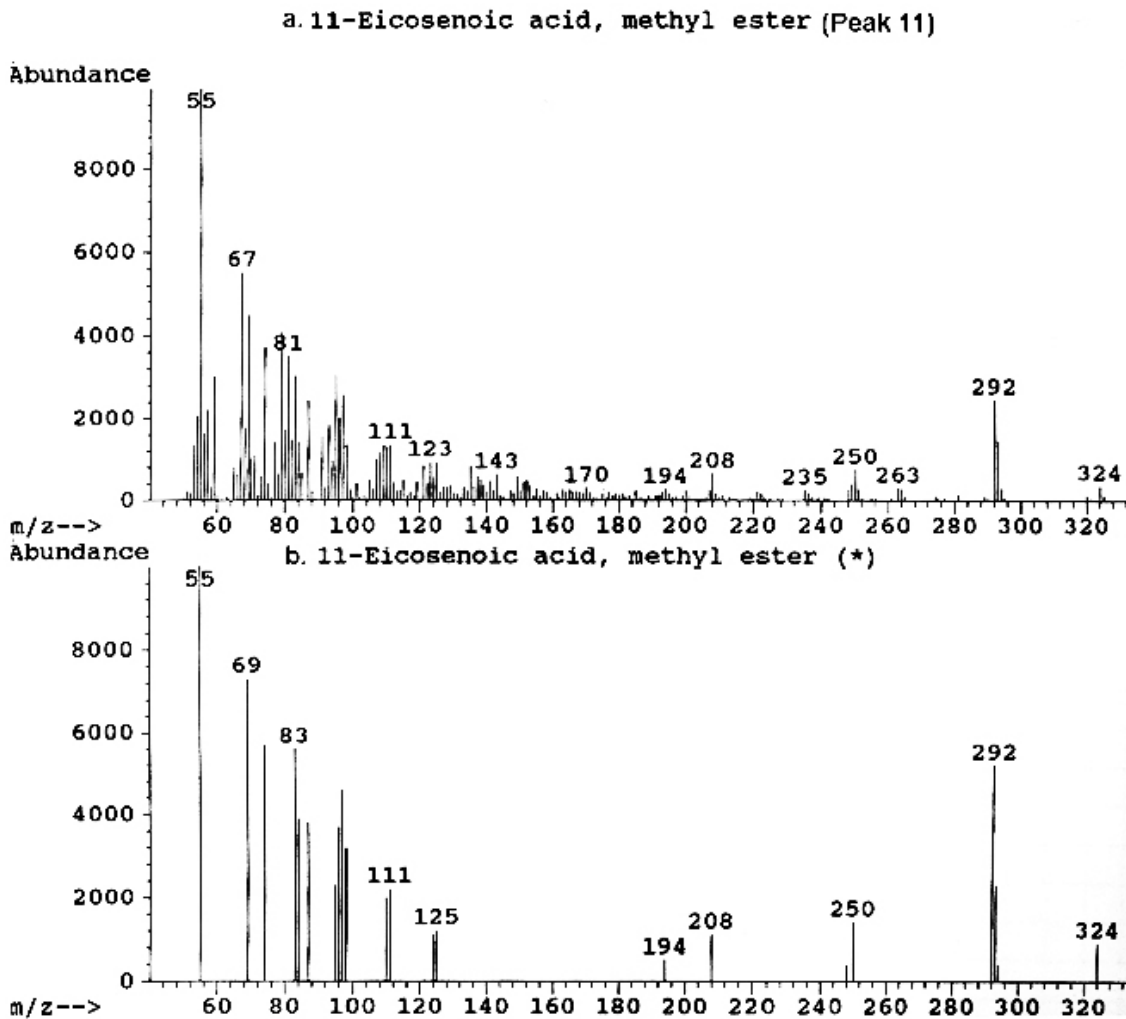




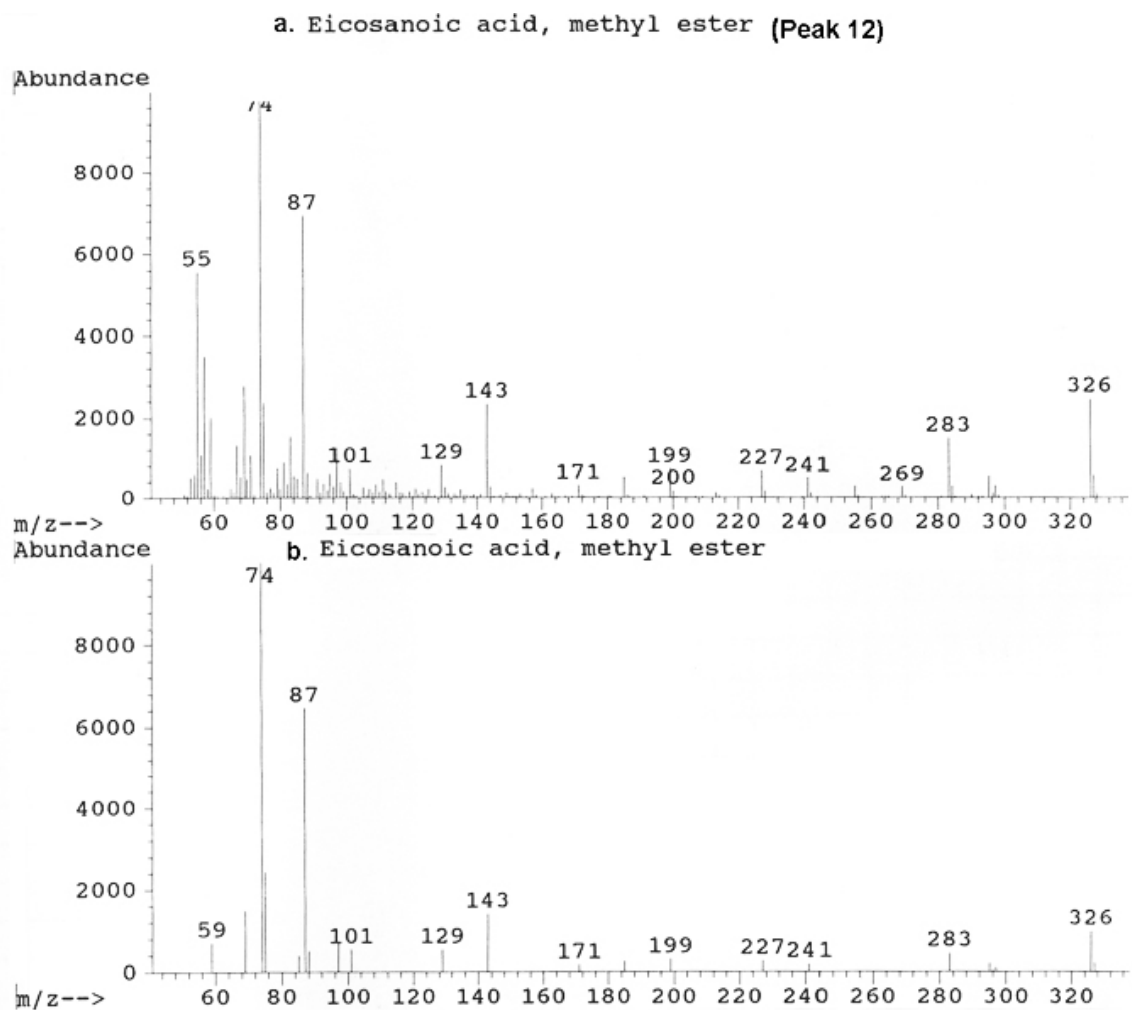
**Figure 48. Mass spectral data for 9,12,15-Octadecatrienoic acid methyl ester**  
**a. Analyte b. Spectra from HP Chem Station Wiley library**



**Figure 49. Mass spectral data for 11, 14- Eicosanoic acid methyl ester**  
**a. Analyte b. Spectra from HP Chem Station Wiley library**



**Figure 50. Mass spectral data for 11-Eicosenoic acid methyl ester**  
**a. Analyte b. Spectra from HP Chem Station Wiley library**



**Figure 51. Mass spectral data for Eicosanoic acid methyl ester**  
**a. Analyte b. Spectra from HP Chem Station Wiley library**

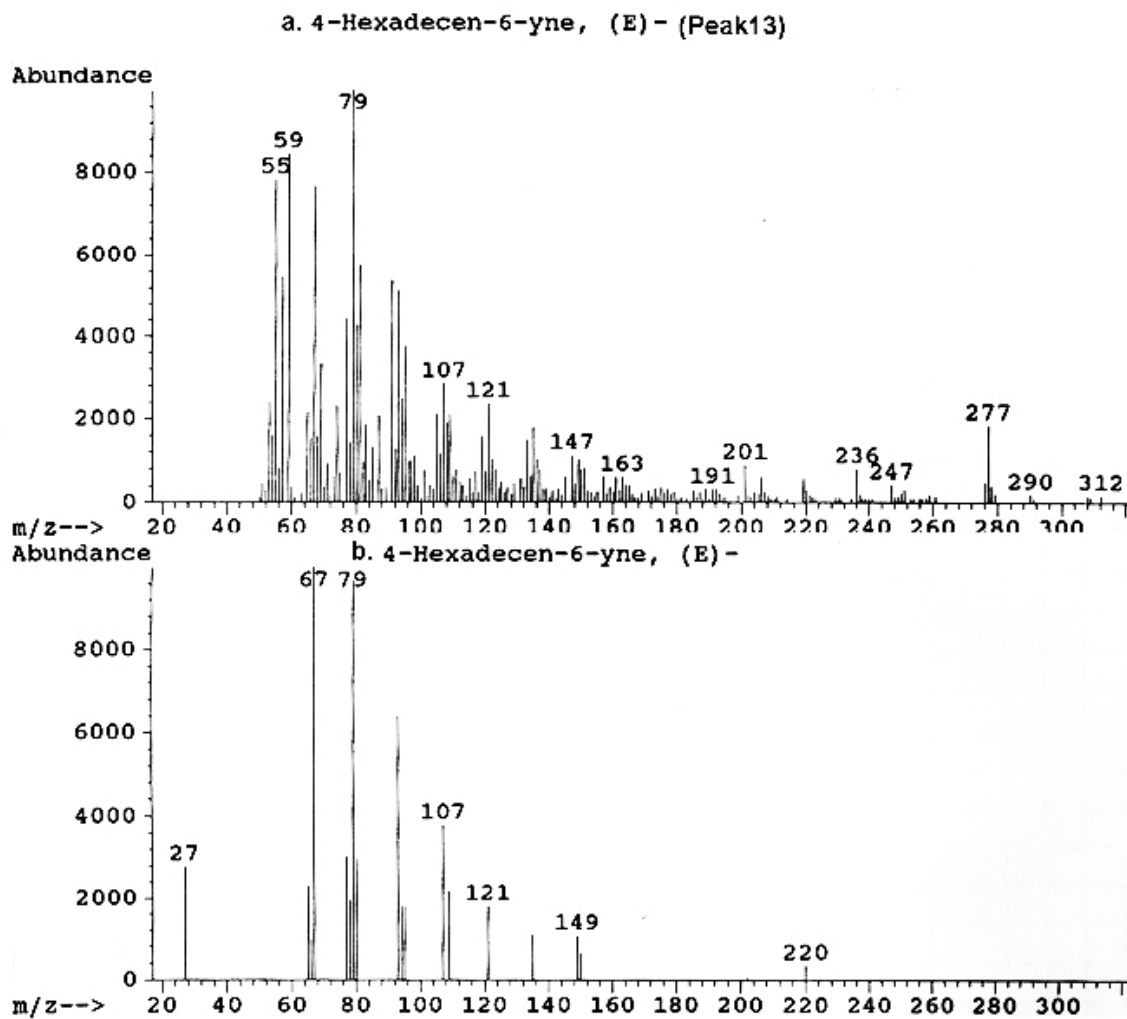


Figure 52. Mass spectral data for 4-Hexadecen-6-yne  
 a. Analyte b. Spectra from HP Chem Station Wiley library

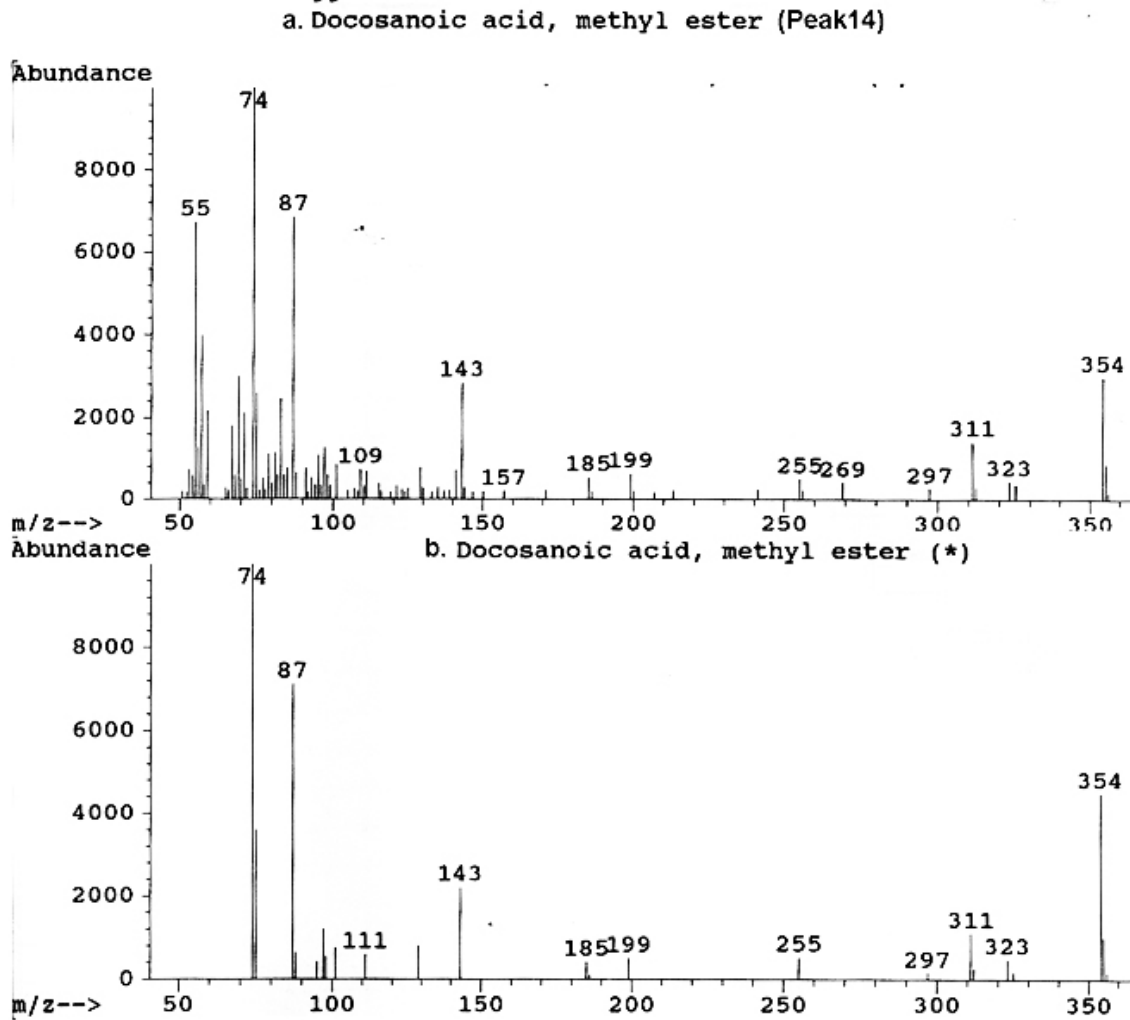


Figure 53. Mass spectral data for Docosanoic acid methyl ester  
a. Analyte b. Spectra from HP Chem Station Wiley library

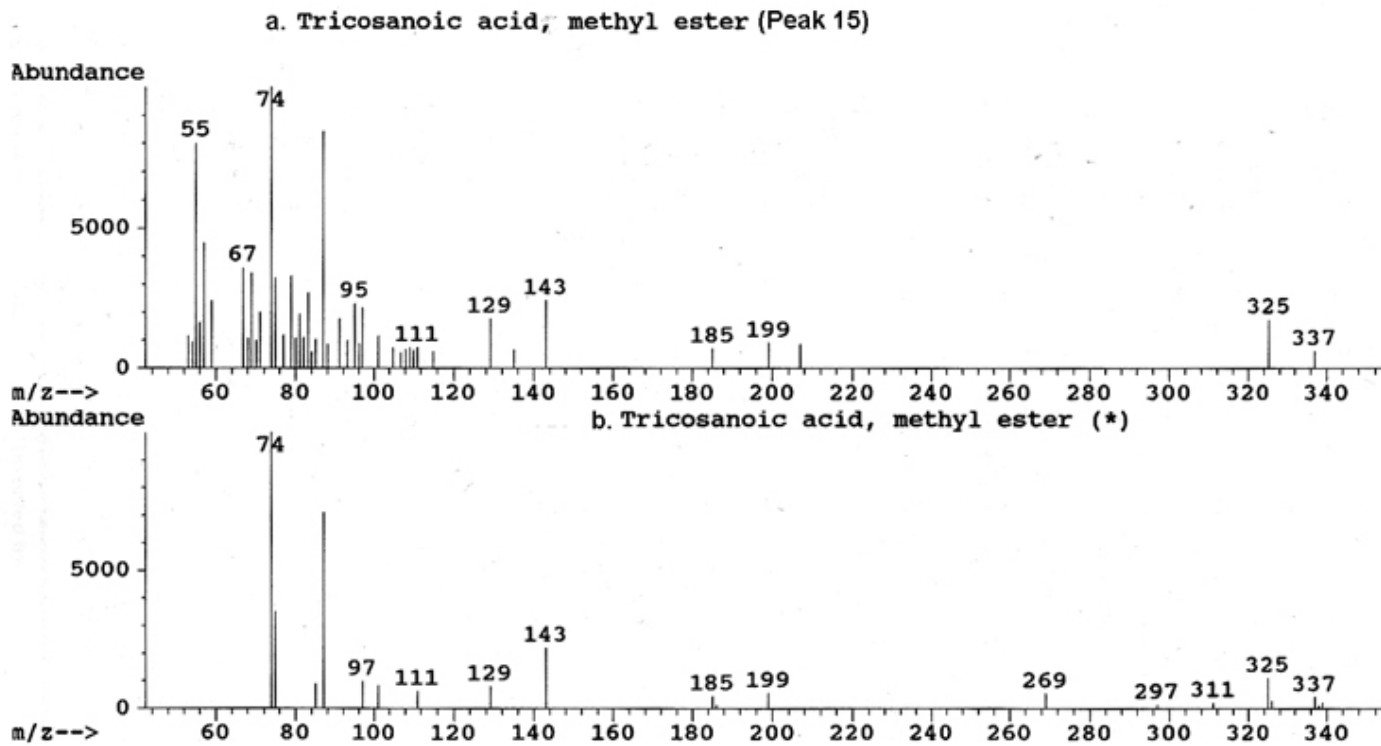
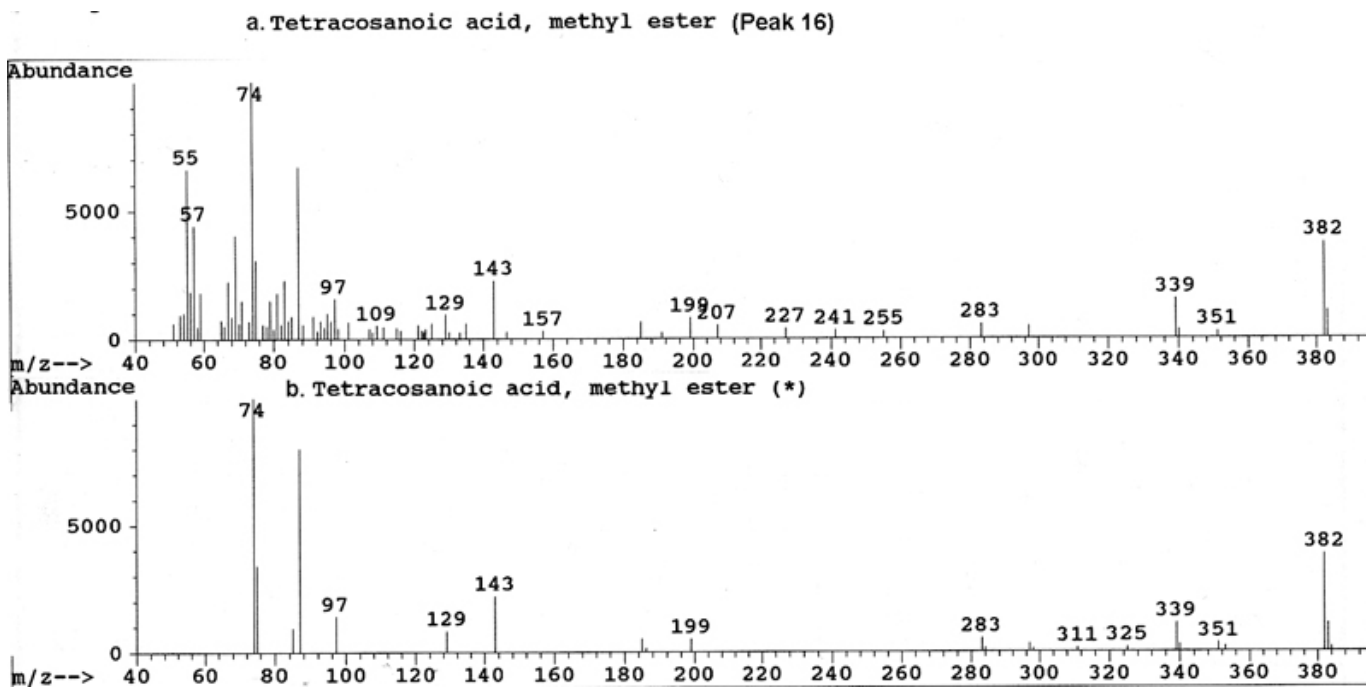
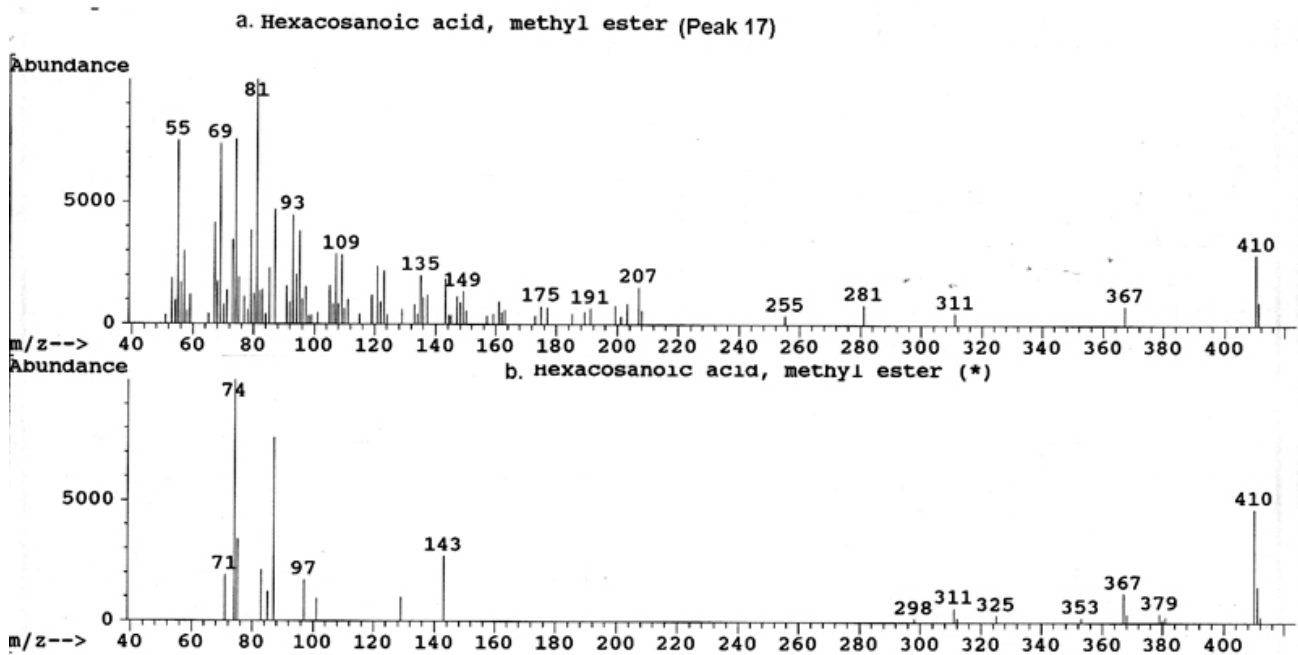


Figure 54. Mass spectral data for Tricosanoic acid methyl ester  
a. Analyte b. Spectra from HP Chem Station Wiley library

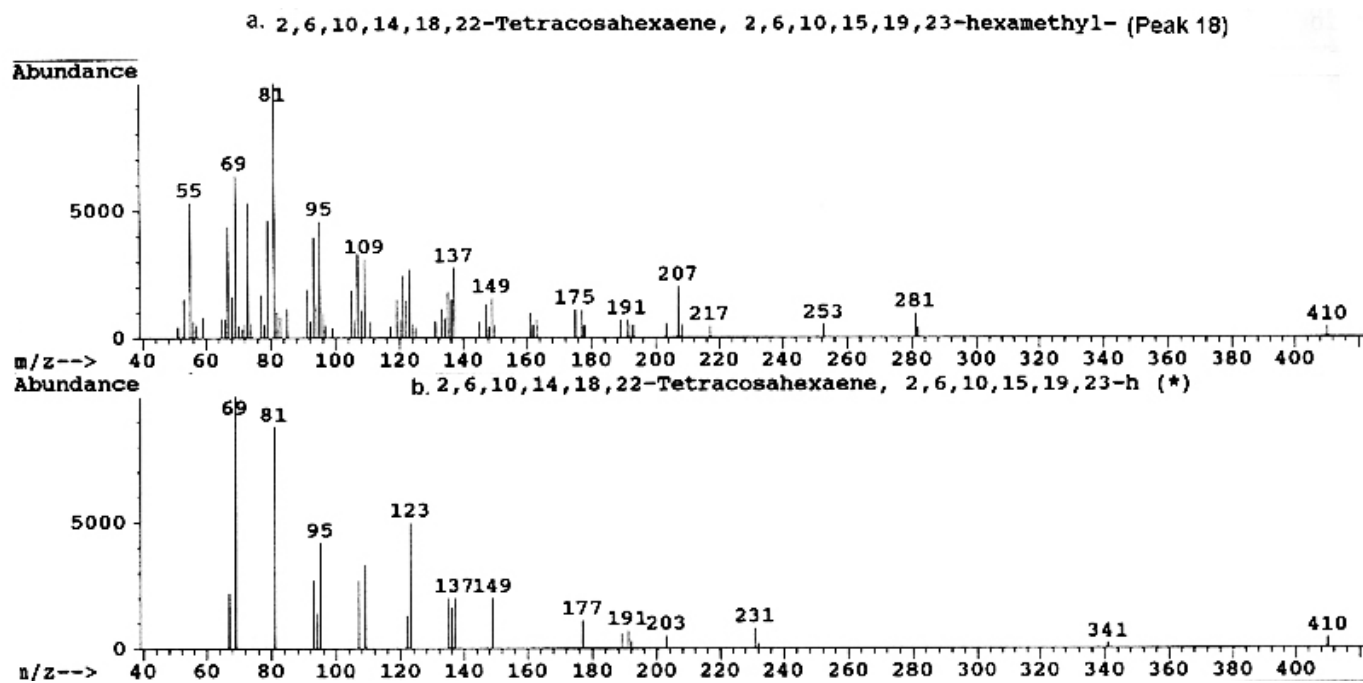


**Figure 55. Mass spectral data for Tetracosanoic acid methyl ester**  
a. Analyte b. Spectra from HP Chem Station Wiley library





**Figure 56. Mass spectral data for Hexacosanoic acid methyl ester  
 a. Analyte b. Spectra from HP Chem Station Wiley library**



**Figure 57. Mass spectral data for Squalene**  
**a. Analyte b. Spectra from HP Chem Station Wiley library**

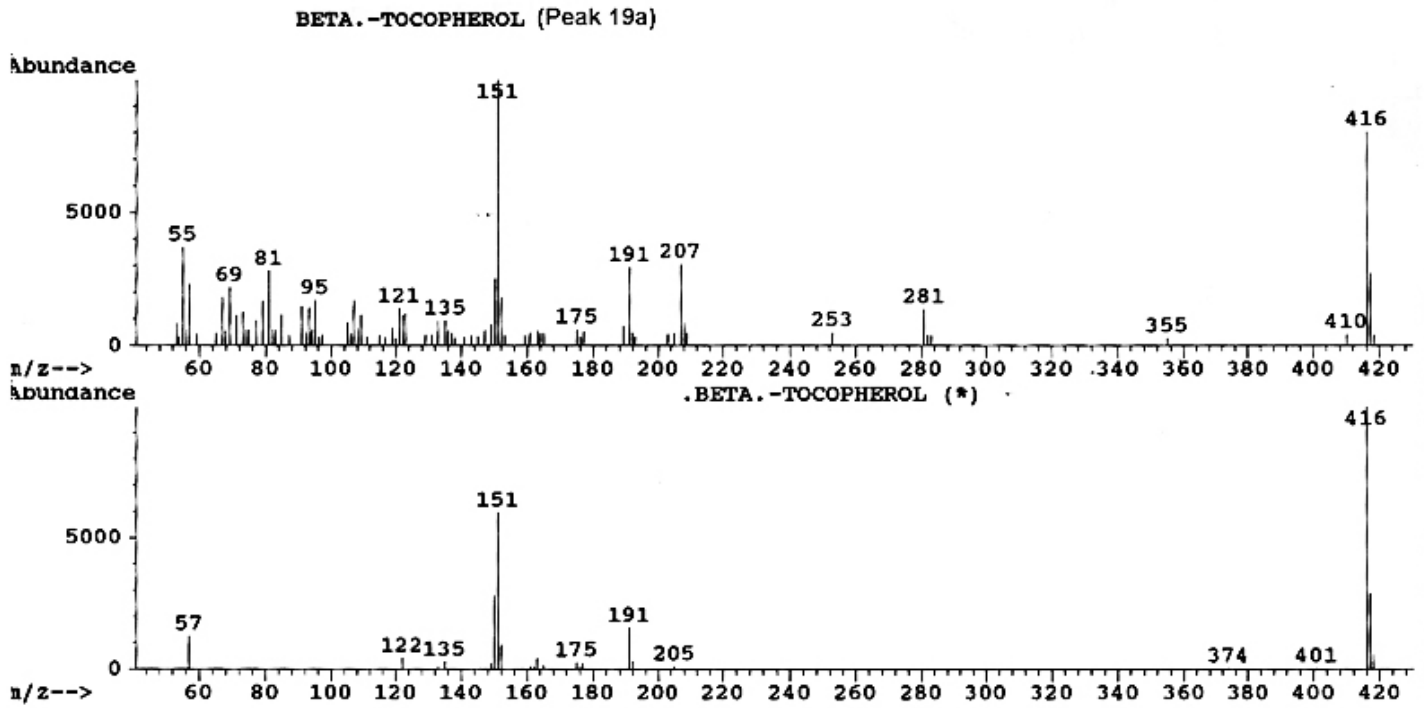


Figure 58a . Mass spectral data for  $\beta$ -tocopherol  
 a. Analyte b. Spectra from HP Chem Station Wiley library

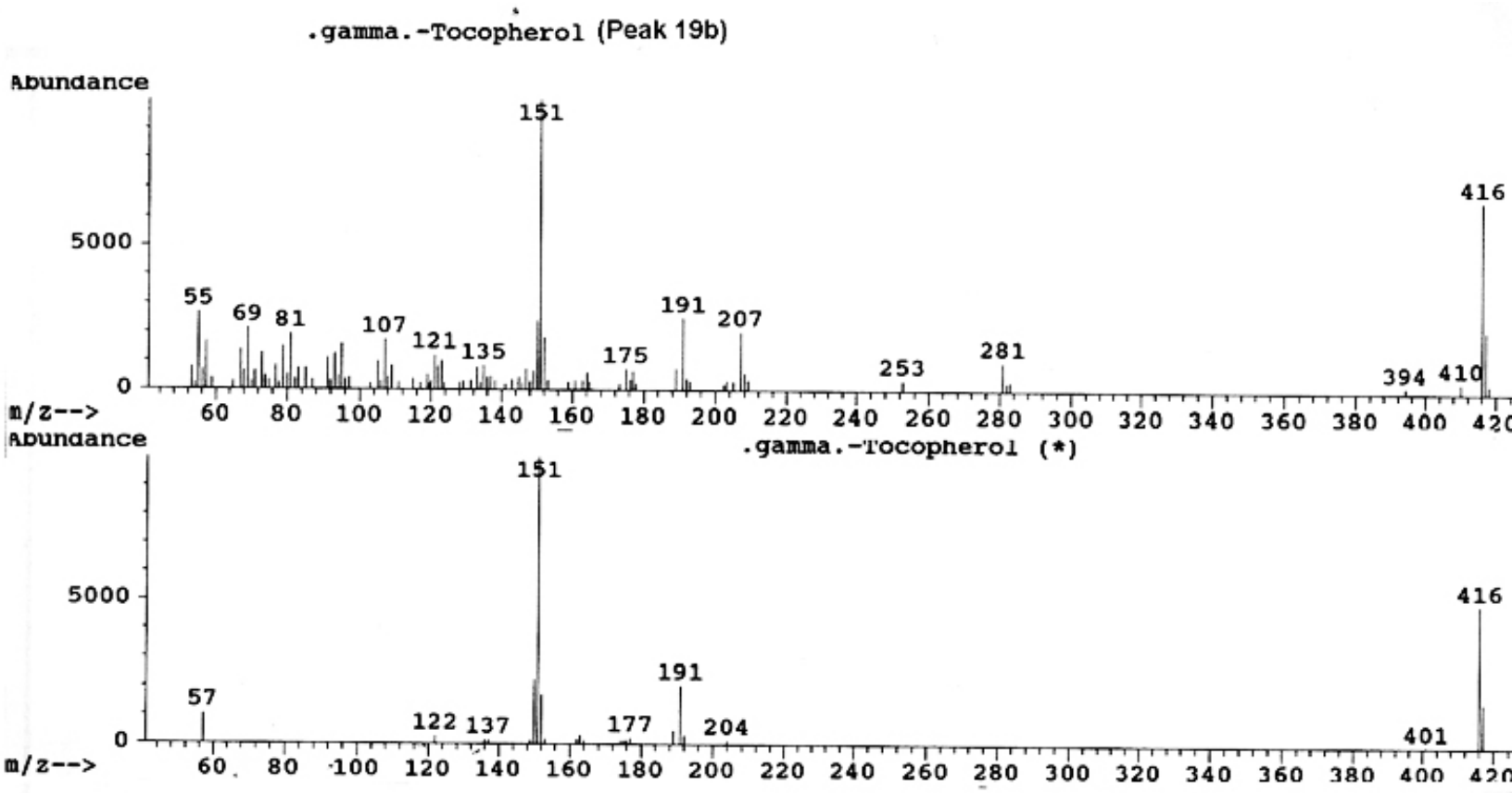


Figure 58b . Mass spectral data for  $\gamma$ -tocopherol  
 a. Analyte b. Spectra from HP Chem Station Wiley library

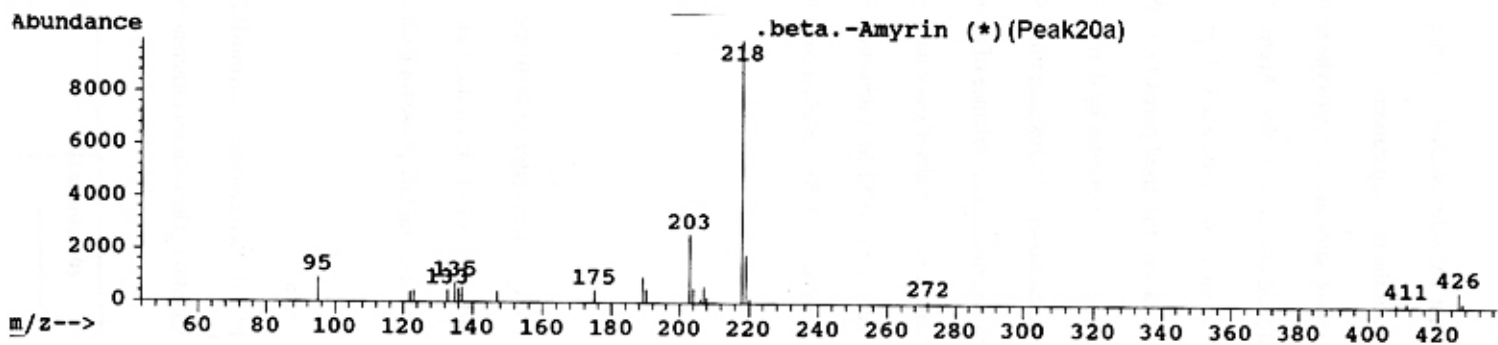


Figure 59a . Mass spectral data for  $\beta$ -amyrin from Wiley library

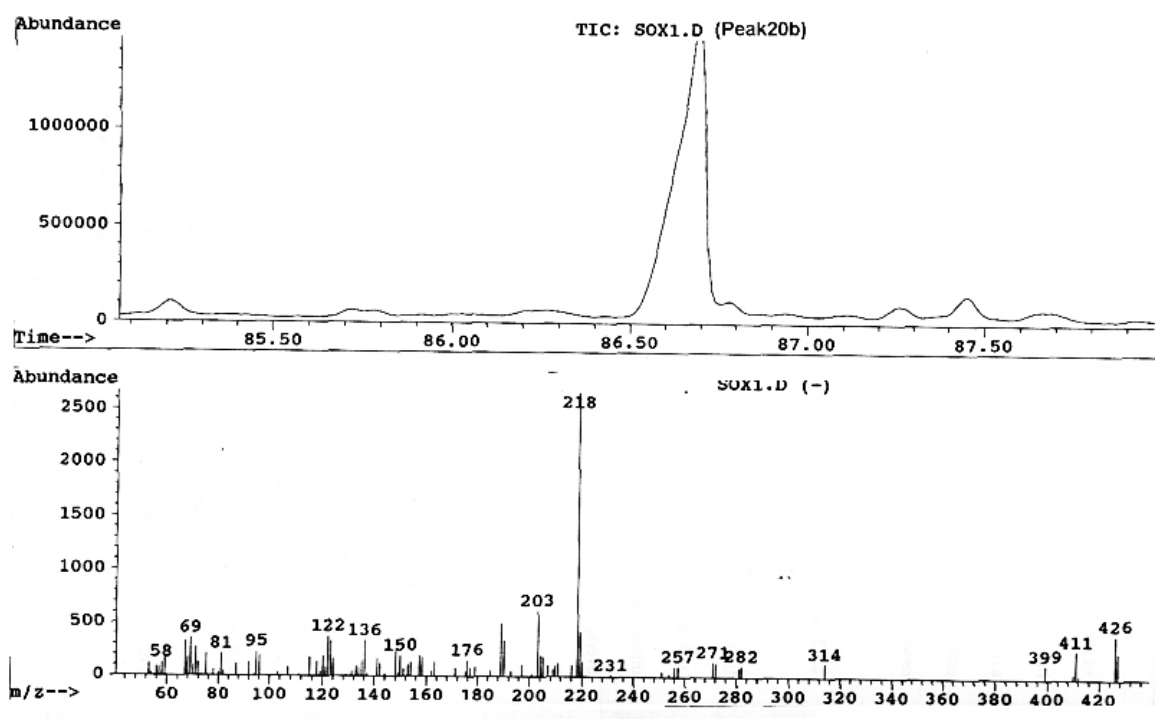


Figure 59b . Mass spectral data for  $\beta$ -amyrin

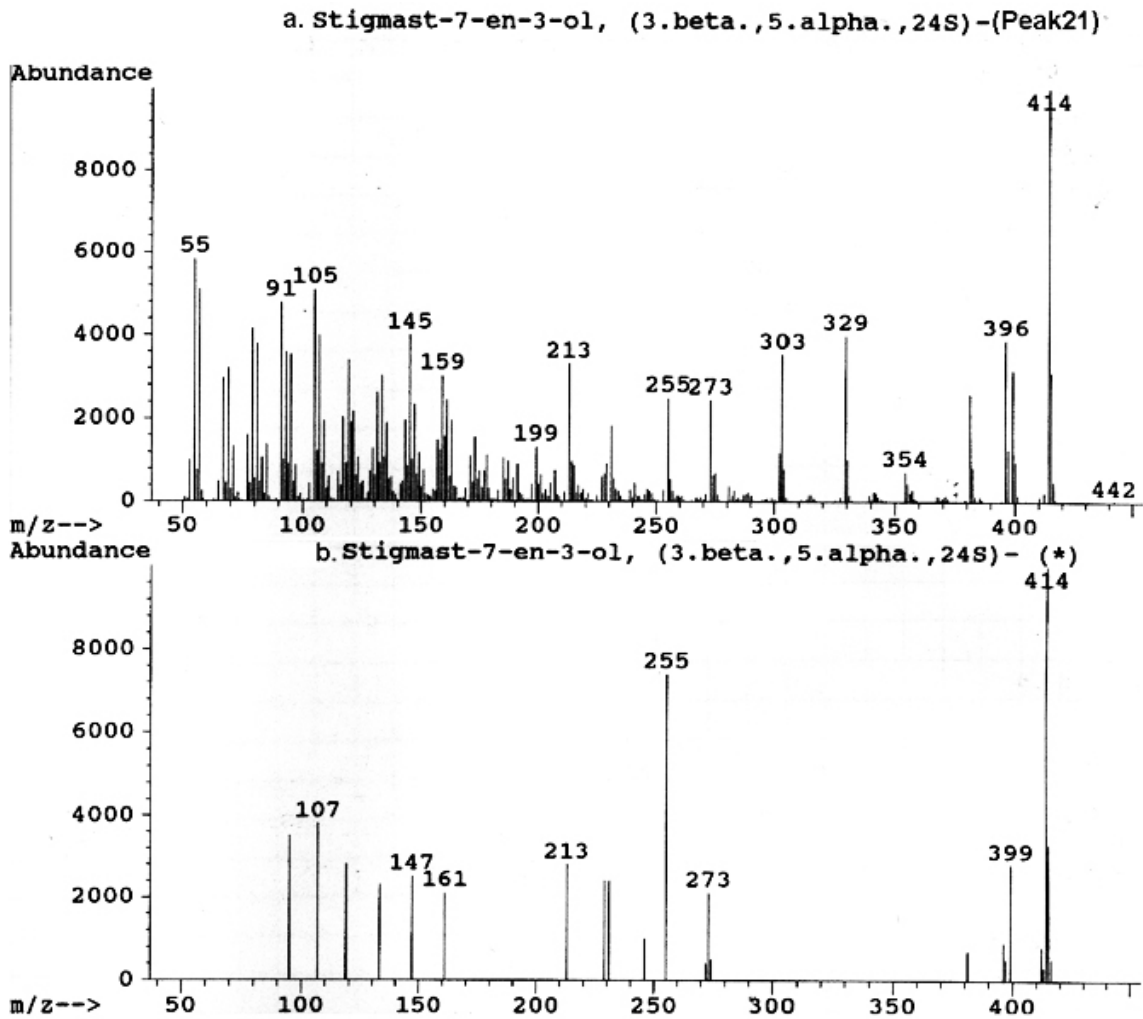
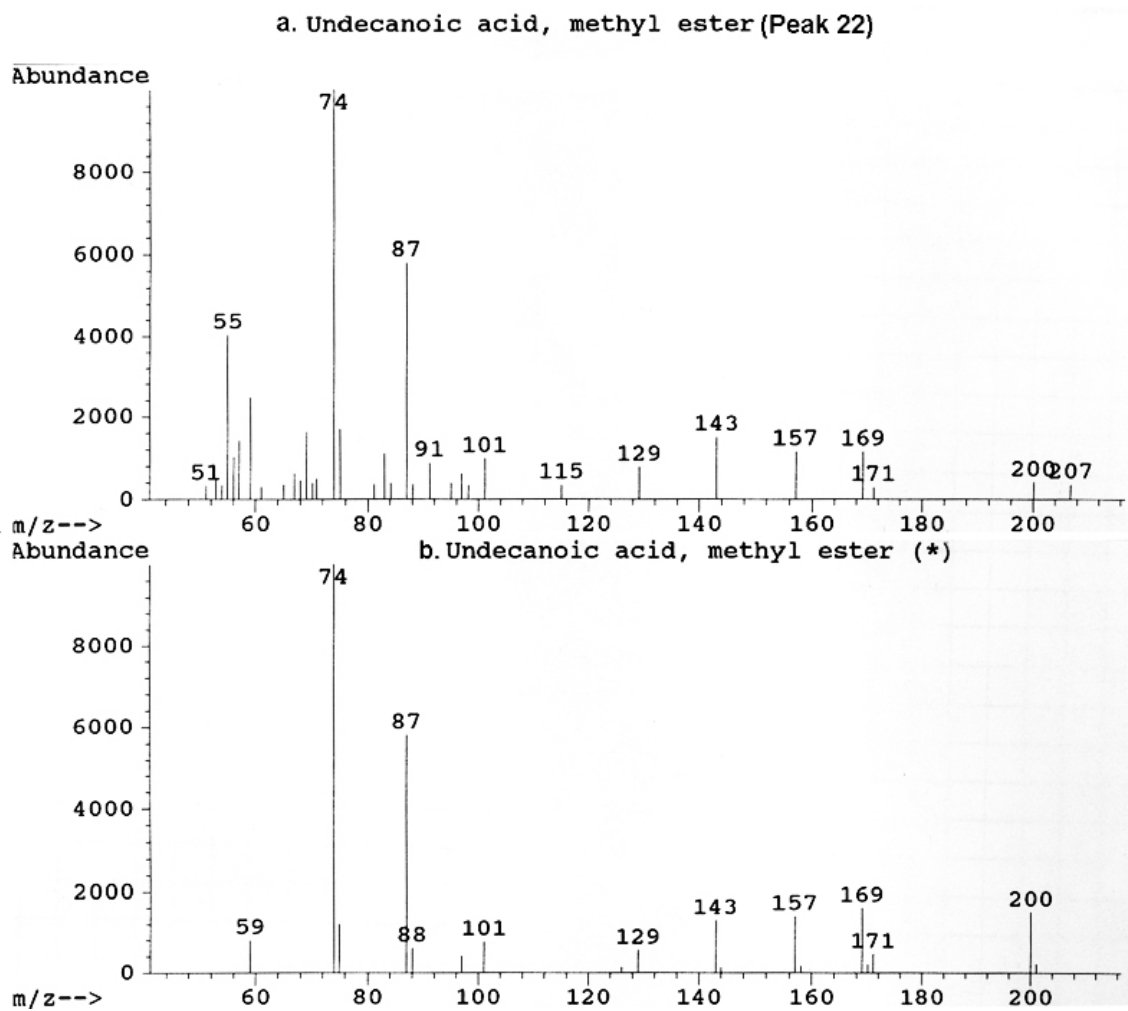


Figure 60. Mass spectral data for  $\beta$ -sitosterol  
 a. Analyte b. Spectra from HP Chem Station Wiley library



**Figure 61. Mass spectral data for Undecanoic acid methyl ester (Internal standard)**

**a. Analyte b. Spectra from HP Chem Station Wiley library**



## VITA

Mansi Pravin Bhagdeo was born in Thane, India on March 14, 1976. She received her BS degree in Chemistry from B.N. Bandodkar College of Science, India in June 1997. She then entered the Masters program (non-thesis) at the Institute of Science, India and received her masters degree in Analytical Chemistry in June 1999. She then came to US and joined Virginia Polytechnic Institute and State University in Fall 2000 and worked on the extraction of compounds from cranberry seeds using supercritical fluids. She interned at GlaxoSmithKline, RTP in the summer of 2002 and conducted research on the solubilities of pharmaceutical compounds in supercritical fluids using a phase monitor. She received her masters degree (thesis) in Analytical Chemistry from the Virginia Polytechnic Institute and State University in July 2004.