

Product: Point of Purchase

fig 125

The initial design concept for the point of purchase was a workstation. It was important to offer riders a place to set down their baggage, safely access their purses or wallets, continue to keep an eye on their children, and use the information they had gathered to complete the pass purchase transaction. Because some riders will skip using the information modules, that kind of orientation information also needed to be available at the purchase site. Picture 25 depicts "MindSpace," a project by the firm Design Continuum in collaboration with the furniture manufacturer Haworth, that explores the modern workspace. The encircling safety of the MindSpace's work area was a concept relevant to the point of purchase project. Commissioned for the New York MoMA, the show that this piece was a part of exhibited future office furniture concepts.

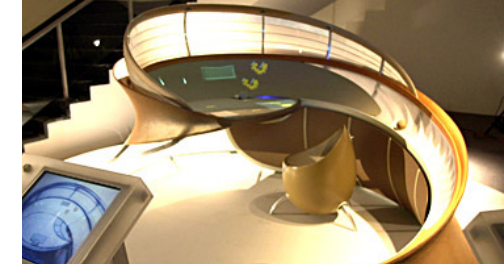

pic 25 - Haworth's "MindSpace"

Point of Purchase

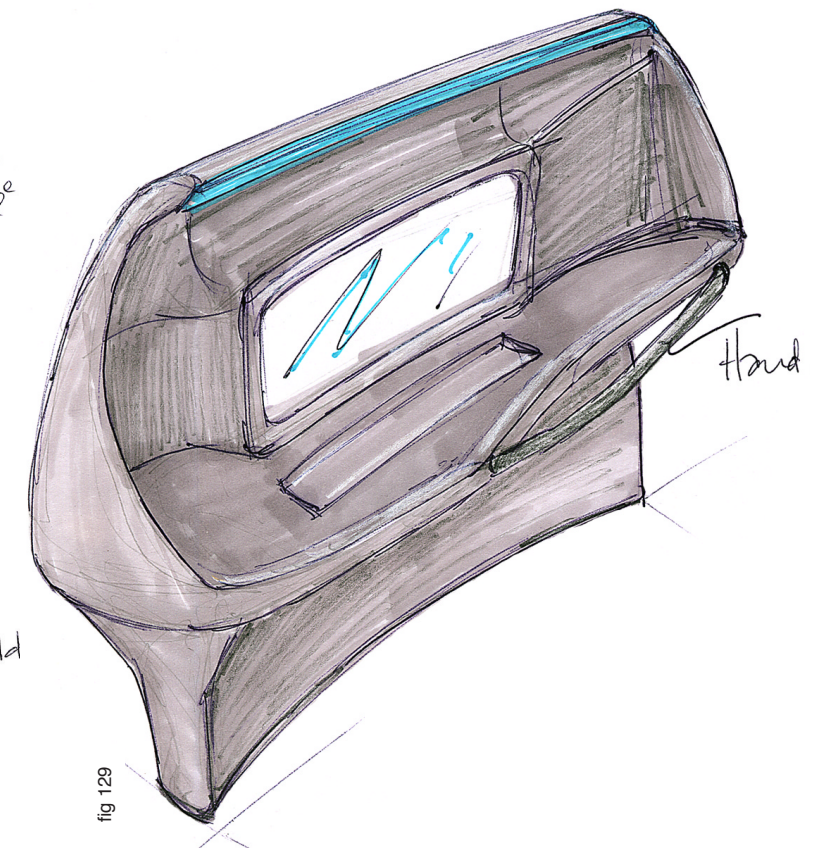
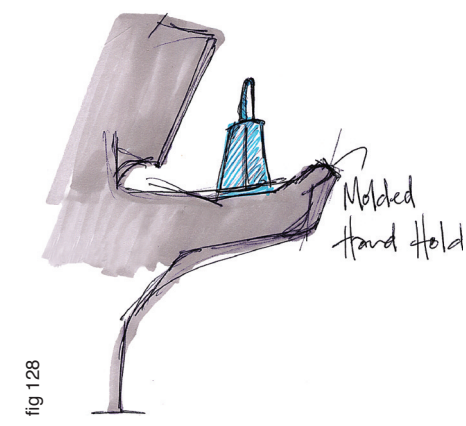
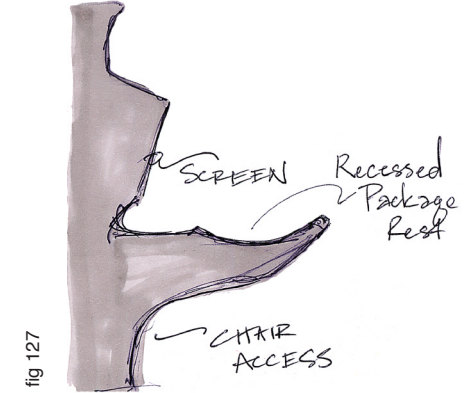
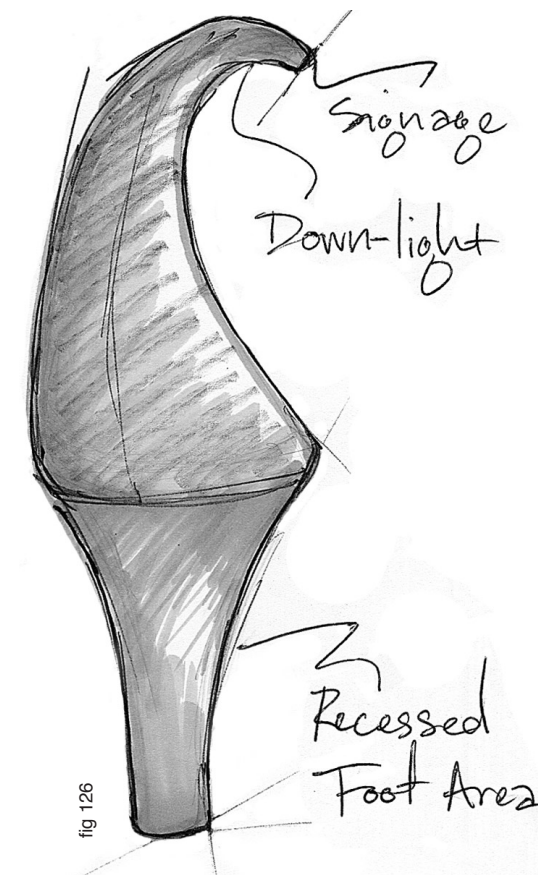





Another idea explored during concept development, was that of shielding the user from the station's other ongoing activities. Once again inspiration was found in examples of innovative office furniture. Furniture company Herman Miller's "Resolve" office system was created by designer Ayse Birsel, with the intention of creating flexible space that could be both public and private, open or closed. The concepts below explore these ideas with respect to the point of purchase. Singular and cluster concepts were explored for unit configuration, with a semi-translucent, curved plane of material separating the user from the rest of station traffic. This concept was passed over for two reasons: considered semi-translucent materials did not exhibit the durability that would be needed in such a public application, and both the cluster and single unit forms did not have forms that intuitively direct or manage traffic flow.

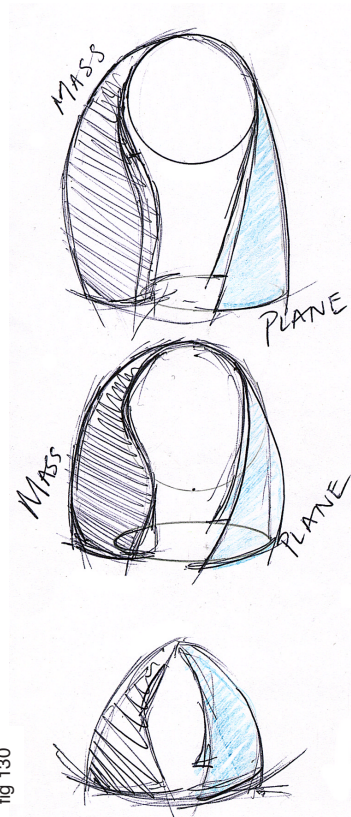

fig 130

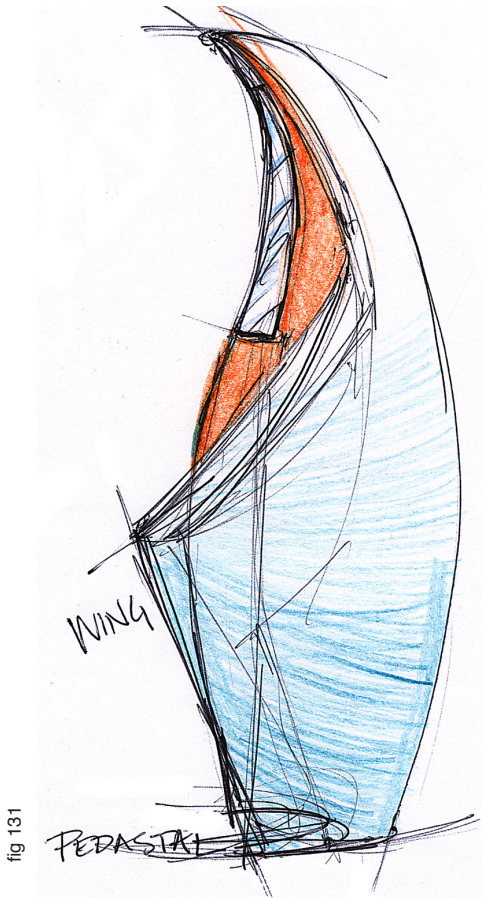

fig 131

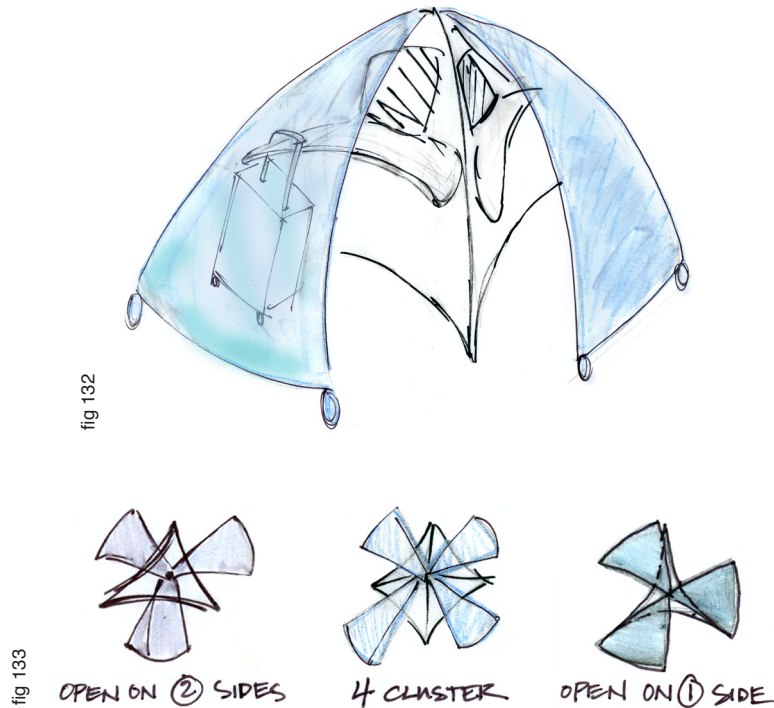

fig 132

fig 133

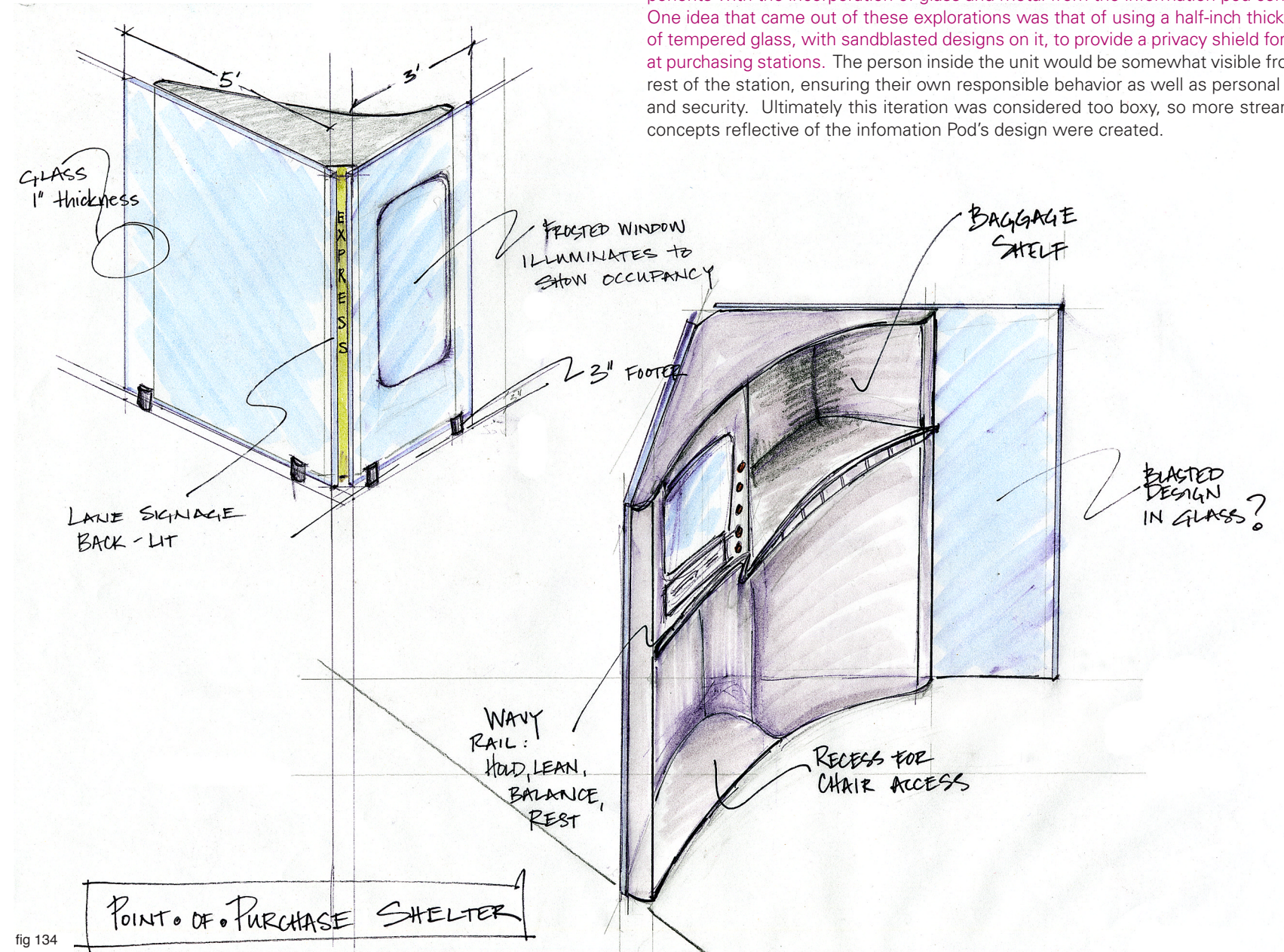

fig 134

The structural form used in these sketches was directly derived from forms explored in the floor plan studies. In these concepts the materials palette is unified across components with the incorporation of glass and metal from the information pod concepts. One idea that came out of these explorations was that of using a half-inch thick sheet of tempered glass, with sandblasted designs on it, to provide a privacy shield for users at purchasing stations. The person inside the unit would be somewhat visible from the rest of the station, ensuring their own responsible behavior as well as personal safety and security. Ultimately this iteration was considered too boxy, so more streamlined concepts reflective of the information Pod's design were created.



Final design concepts were generated using Cobalt 3D modeling software. The design continues to use blasted glass to shield the user during the purchase process, and incorporates the same touchscreen interface used for the information modules. By doing so the learning curve for users is lessened as they move from the planning and orientation phases to the purchasing phase of the entrance process. Each Metrorail station would have an average of 6 points of purchase, with at least one unit in each station offering a tactile computerized interface, which visually impaired users would locate by following a texture floor path. Adequate workspace is also provided to users so that they can access their belongings and not have to place packages and bags on the floor.

- 1
- 2
- 3
- 4
- 5
- 6
- 7

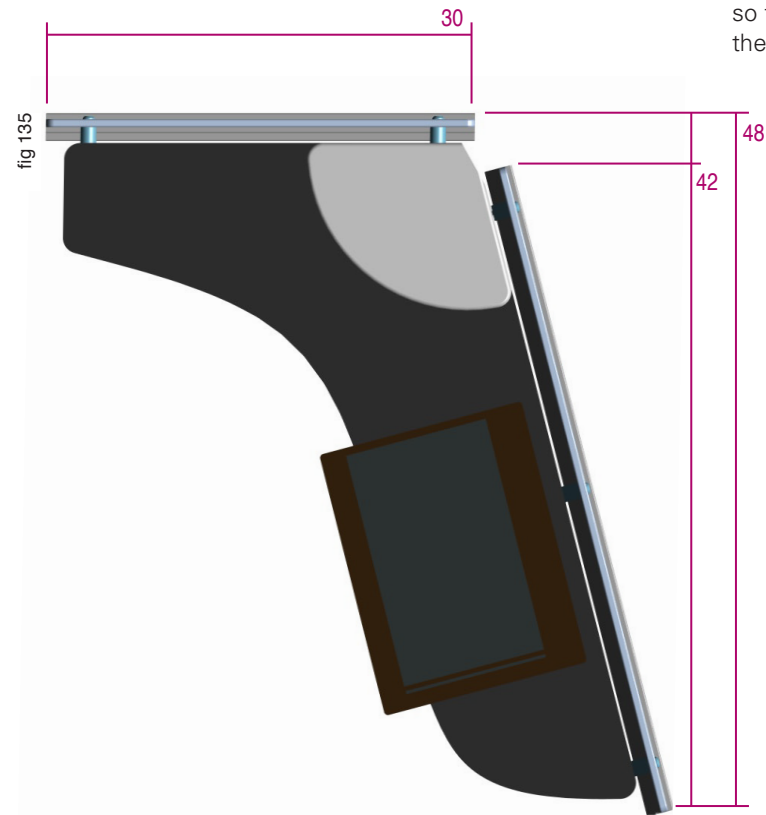

All measurements in inches.

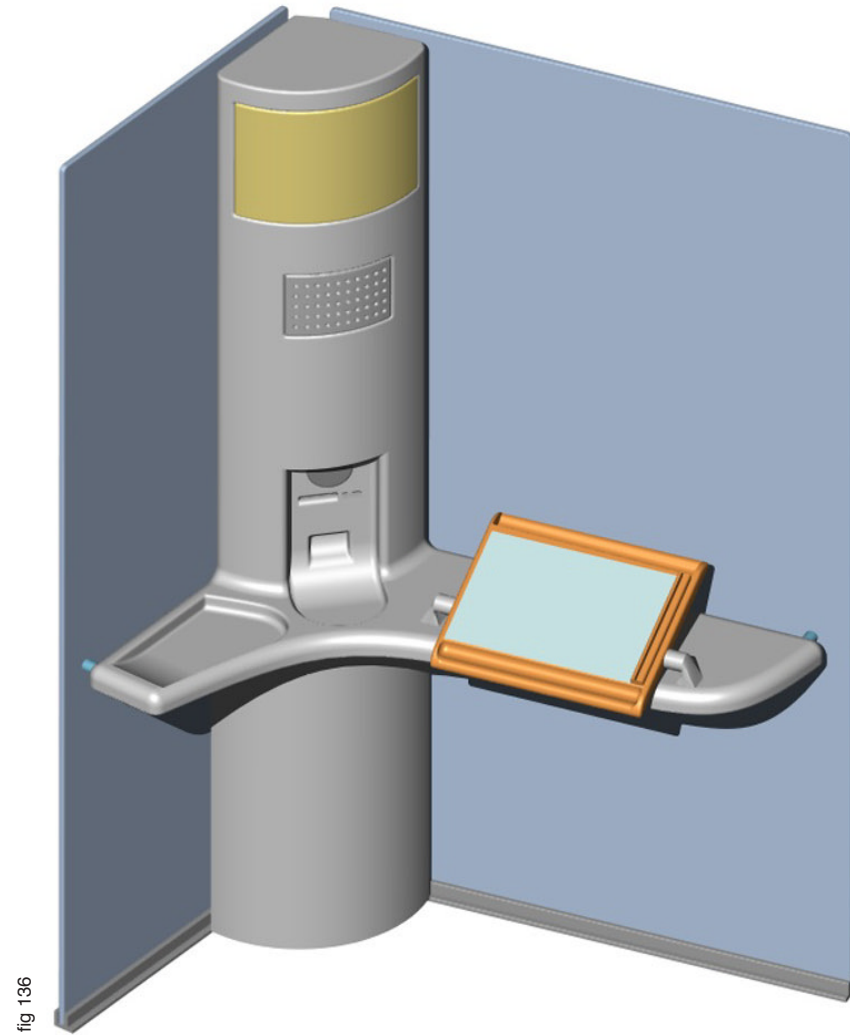

fig 136

A recessed area provides a place for items which may roll, and a lip against which articles may be braced, making one-handed operations and access easier. A recessed space underneath the work area makes the interface accessible for seated persons. The central support column houses a light, a speaker, money-handling equipment, and a SmarTrip card target. A card swipe strip is incorporated into the side of the screen frame for payment with debit and credit cards. By locating the money and farecard handling items at the height of the work surface, access for seated users is further enhanced. This entrance system concept utilizes the existing farecard types, magnetic and smartcard, in order to ease the transition to a new interface for both the staff and the ridership of Metrorail.

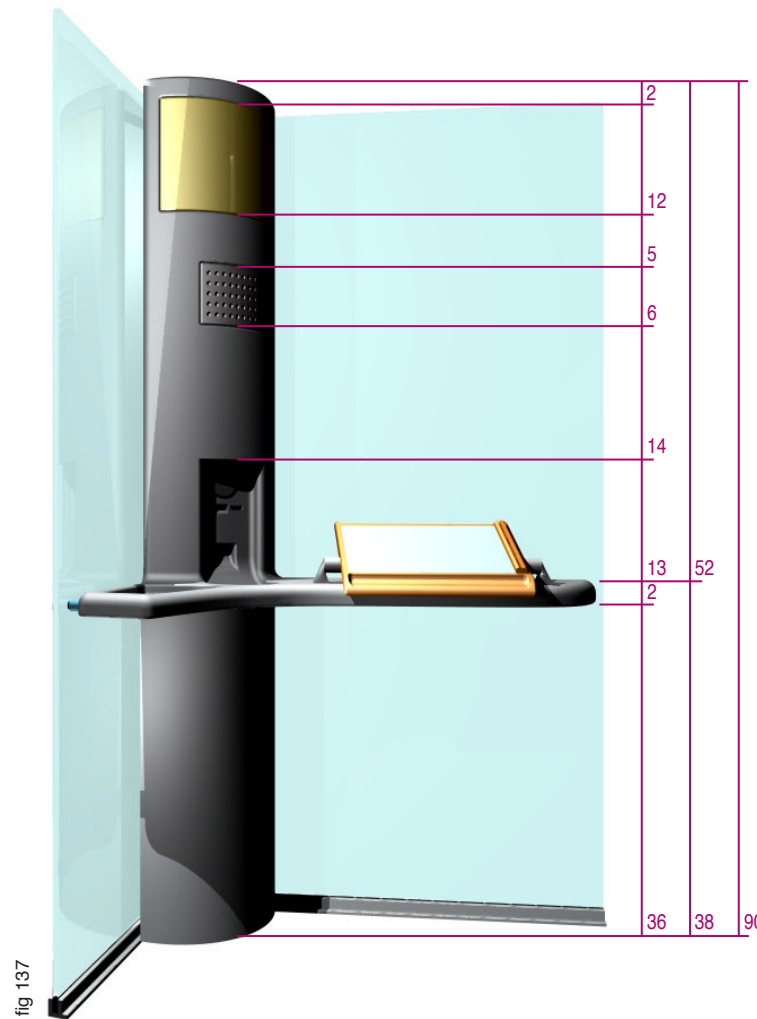

fig 137

All measurements in inches.

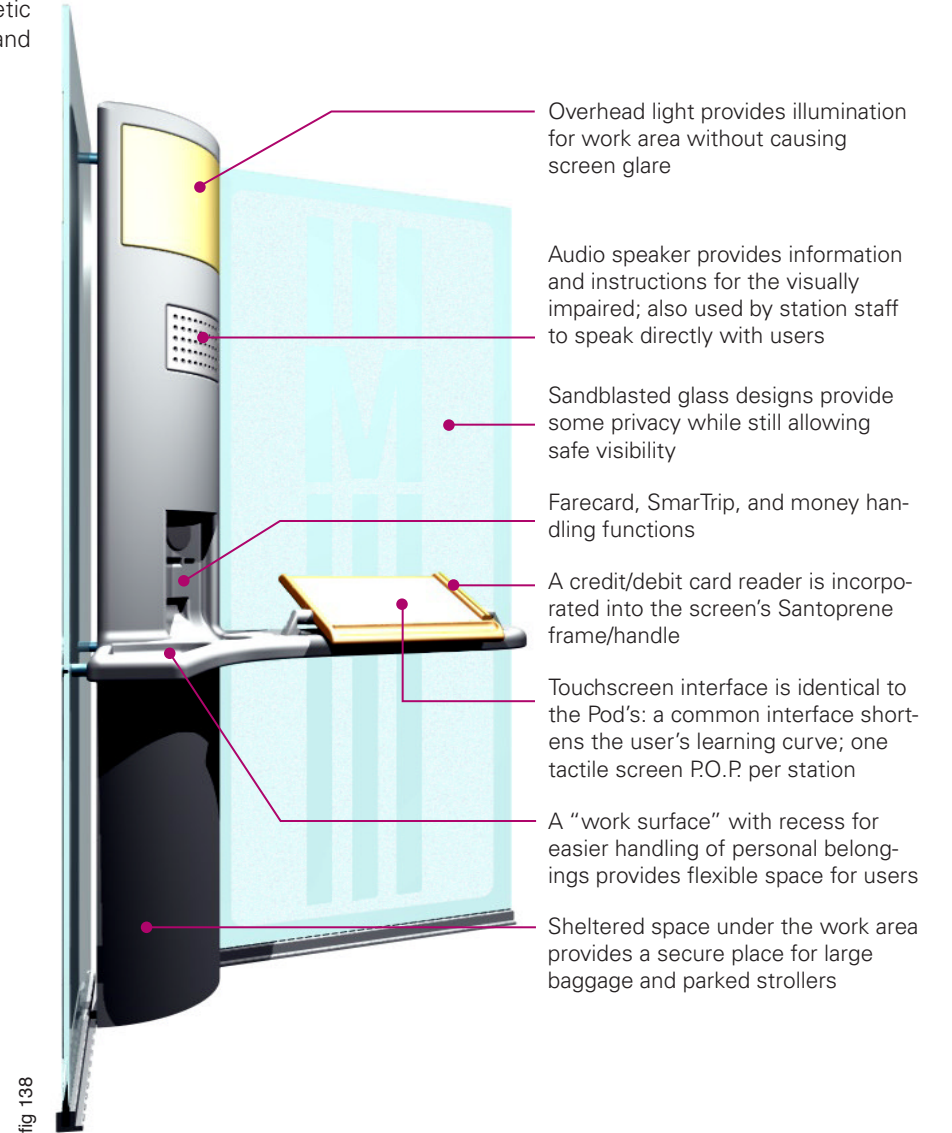

fig 138





fig 139

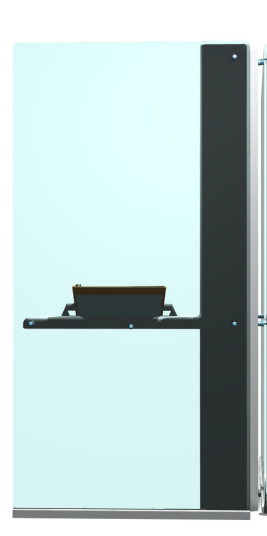
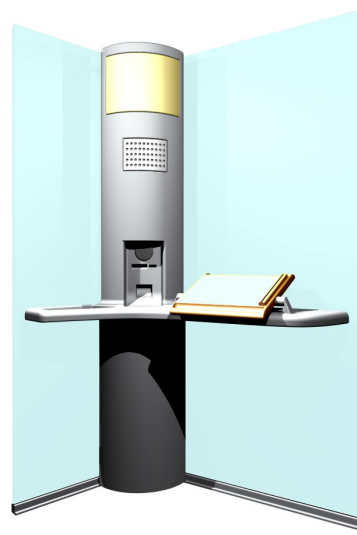

fig 140 - 148



fig 149 - photoshop rendering of Point of Purchase units in the Ballston station