

# An Architecture of the Body: The Garden Spa

Michelle H. Choe

Thesis submitted to the faculty of the Virginia Polytechnic Institute and  
State University in partial fulfillment of the requirements for the degree of

Master of Architecture in Architecture

H. Scott Gartner  
Timothy M. Frank  
William R. Green

May 8th, 2013  
Blacksburg, VA

Keywords: spa, bath, garden, body, curves, sensual

# An Architecture of the Body: The Garden Spa

Michelle H. Choe

## **ABSTRACT**

The Garden Spa explores the healing and sensual qualities of a space. It offers a place of relaxation for the body to be restored through an atmosphere of tranquility. The spa rooms are an intimate place of rest, and the garden is a place to wander through sculptural forms. Curvilinear forms are used to bring pleasure to the eye and touch, creating harmonies with the body.

## **ACKNOWLEDGEMENTS**

To all my committee members, faculty, friends, studio-mates, and family, I wouldn't be where I am today without you.

Thank You

"I am my body," - Gabriel Marcel  
 "but I am the space, where I am." - Moel Arnaud

## CONTENT

INTRODUCTION .....	01
THE SENSUAL .....	03
THE BODY .....	19
A PLACE .....	29
ITS ELEMENTS .....	33
HARMONY .....	61

## LIST OF FIGURES

BODY IN SHADOW .....	iv	FINAL SPA AXON LOWER LEVEL .....	36
CURVE SKETCHES .....	01	SECTION 01 .....	37
CONCEPT IN AXON .....	02	SECTION 02 .....	38
CURVE MODEL STUDIES (4) .....	03	EXTERIOR WALL DETAIL .....	39
STEAM ROOM .....	03	EXTERIOR ELEVATION .....	39
CAFE .....	04	INTERIOR ELEVATION .....	39
COMMUNAL BATH .....	04	SIDE ELEVATION CONCEPT .....	40
LIGHT STUDIES (4) .....	05	FRONT ELEVATION CONCEPT .....	40
LIGHT SKETCHES (4) .....	06	ENTRY LOBBY PLAN .....	41
FRAME STUDIES (4) .....	07	ENTRY LOBBY AXON .....	41
SPACE HOUSE .....	08	ENTRY LOBBY PERSPECTIVE .....	42
BUBBLE HOUSE .....	08	CHANGING ROOM PLAN .....	43
HOUSE OF THE CENTURY .....	08	CHANGING ROOM AXON .....	43
COLOR STUDIES (3) .....	09	COMMUNAL ROOM PERSPECTIVE .....	44
ORANGE AND BLUE MATRIX .....	10	COMMUNAL BATH PLAN .....	45
WAFFLE FRAME STUDIES (4) .....	11	COMMUNAL BATH AXON (2) .....	45
RIBBED STRUCTURE STUDIES (4) .....	12	COMMUNAL BATH STRUCTURE (3) .....	46
COMMUNAL BATH INTERIOR (4) .....	13	COMMUNAL BATH CONCEPT SKETCH (3) .....	47
STEAM ROOM INTERIOR (4) .....	14	COMMUNAL BATH PERSPECTIVE .....	48
SPA PLAN CONCEPT 01 .....	15	CAFE PLAN .....	49
SPA PLAN CONCEPT 02 .....	16	CAFE AXON .....	49
CAVE PERSPECTIVES .....	17	CAFE PERSPECTIVE (2) .....	50
BODY AND BUILDING 01 .....	18	SMALL PRIVATE SPA UNIT CONCEPT PLAN .....	51
THE BODY .....	19	SMALL PRIVATE SPA UNIT AXON .....	51
BODY PROPORTIONS .....	20	SMALL PRIVATE SPA UNIT FINAL PLAN .....	52
TACTILE SENSE .....	21	SMALL PRIVATE SPA UNIT EXTERIOR AXON (3) .....	52
BODY POSITIONS .....	22	SMALL PRIVATE SPA UNIT SECTIONAL PERSPECTIVE .....	53
BODY IN MOTION .....	23	SMALL PRIVATE SPA UNIT WALL DETAIL .....	54
BODY AND SURFACE 01 .....	25	SMALL PRIVATE SPA UNIT SECTION .....	54
BODY AND BUILDING 02 .....	26	STEAM ROOM MATERIAL STUDIES .....	55
BODY AND SURFACE 02 (2) .....	27	HOT BATH PRECAST PARTS .....	56
BODY AND SURFACE 02 (2) .....	28	LARGE PRIVATE SPA UNIT CONCEPT PLAN .....	57
WASHINGTON DC .....	29	LARGE PRIVATE SPA UNIT AXON .....	57
SITE PLAN 01 .....	30	MASSAGE ROOM AXON .....	58
SITE PLAN 02 .....	30	BATHROOMS, MECHANICAL ROOM, AND EXIT AXON .....	58
VIEW OF SITE .....	31	A GROVE OF TREES, A PLACE TO SIT AXON (2) .....	59
EAST VIEW .....	31	A GROVE OF TREES, A PLACE TO SIT PERSPECTIVE .....	60
SOUTH VIEW .....	32	BODY IN SEAT (2) .....	61
WEST VIEW .....	32	SMALL PRIVATE SPA UNIT HALLWAY PERSPECTIVE .....	62
SPHERE IN BOX (2) .....	33	SMALL PRIVATE SPA UNIT HOT BATH PERSPECTIVE .....	63
FINAL SPA AXON .....	33	SMALL PRIVATE SPA UNIT STEAM ROOM PERSPECTIVE .....	64
FINAL SPA PLAN .....	34	GARDEN PERSPECTIVE 01 .....	65
FINAL SPA AXON GROUND .....	35	GARDEN PERSPECTIVE 02 .....	66
		GARDEN PERSPECTIVE 03 .....	67

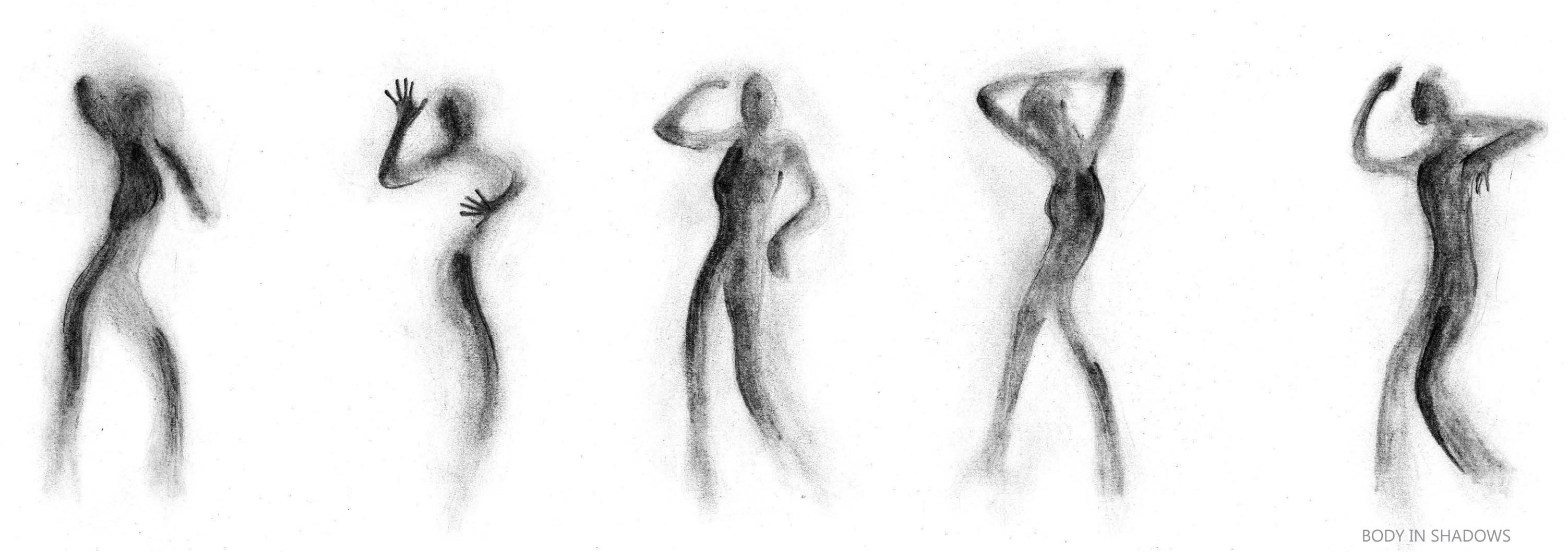

BODY IN SHADOWS

## INTRODUCTION

My primary interest during my graduate education has been in the investigation of curvilinear forms – the ways they are made, their meaning, and an understanding of my attraction towards them. What makes the curve more desirable than the straight line? What are my reasons for using them? And does it add value to the project? This has been a challenging subject that has forced me to go beyond standard means, to question what is acceptable, and to give myself limitations.

This thesis presents curvilinear forms within a rectilinear framework. This framework is used to define the boundary of the site and to organize the internal arrangement and construction of the building. Curvilinear forms are interposed between this rigid framework and the bodies of the inhabitants. Inside these curvilinear forms, the body is sheltered in intimate spaces that appeal to the sense of touch and sight. At a large scale, the curvilinear forms offer a pleasing visual counterpoint to the rectilinear frame of the enclosing walls.

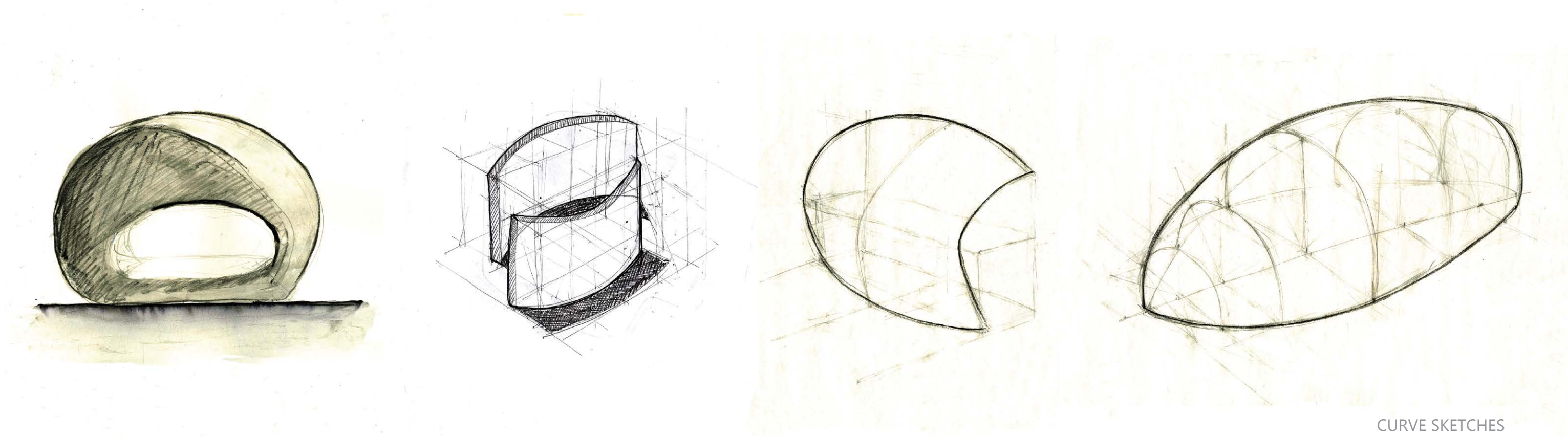

CURVE SKETCHES

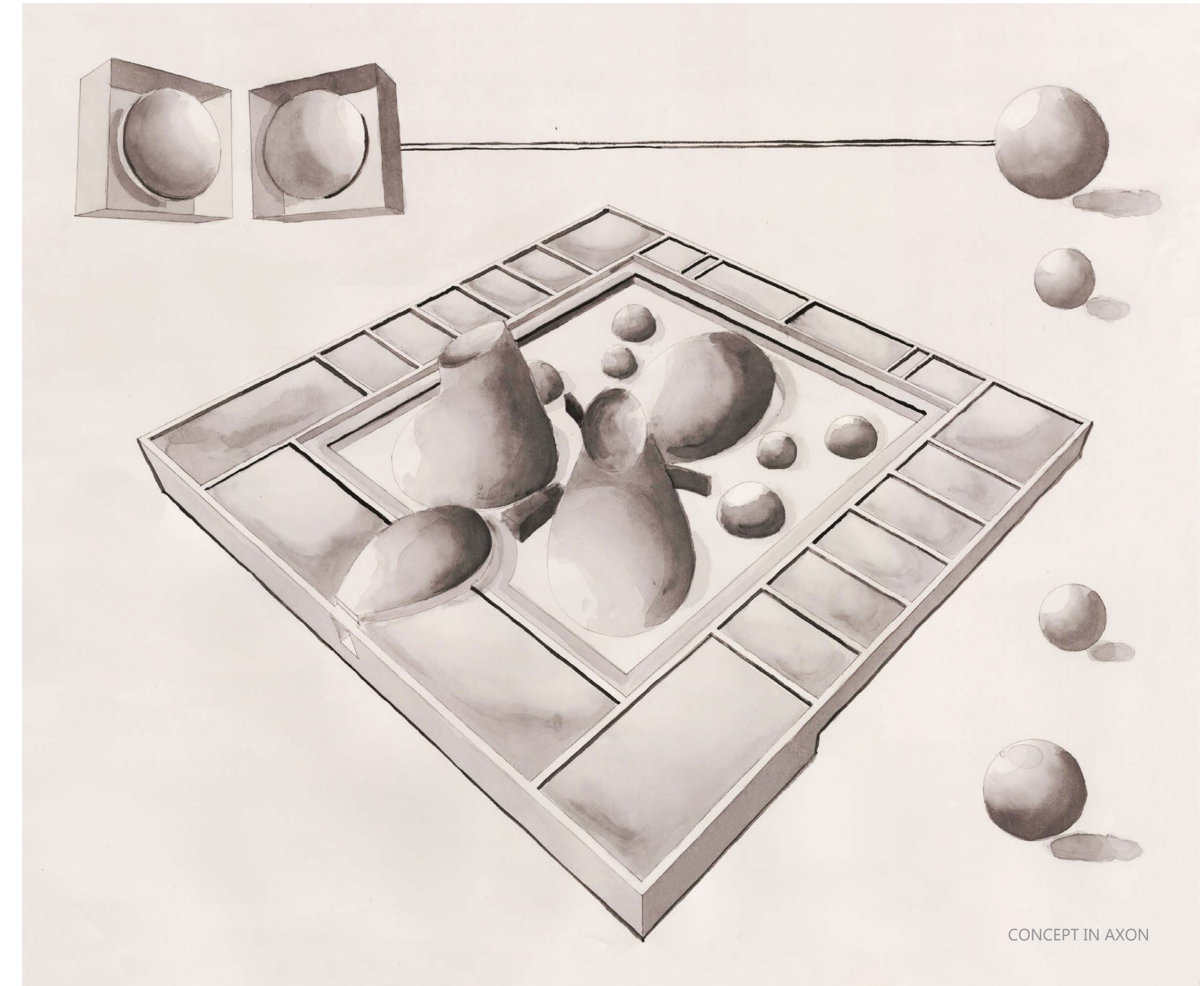

CONCEPT IN AXON

## THE SENSUAL

: stimuli originating from the body; wordly and materialistic; arousing or exciting the senses. (www.dictionary.com)

Architecture has the ability to affect us on an emotional level, evoking a positive or negative response. Curves are sensuous, erotic, and beautiful. Their round corners give a soft and inviting edge. The way in which light washes down a curved surface is completely different from the way it strikes a flat wall, and its bend and flow of surface present visual continuity. All of these create spatial sensations that connect with people and please them. The following images are studies in curvilinear form with consideration given to light, color, materiality, and surface.

"Architecture is given life and spirit by all the qualities that touch the human senses and the human soul: by light and color, sound and texture, by expansion and compression of space, by view and prospect. These might be considered literal qualities created by the manipulation of materials and space, but they can go beyond the literal to touch our soul. Architecture inside whispers of intimacy, of one's closeness to the enclosure it always makes."  
-Karen Franck, *Architecture from the Inside Out*

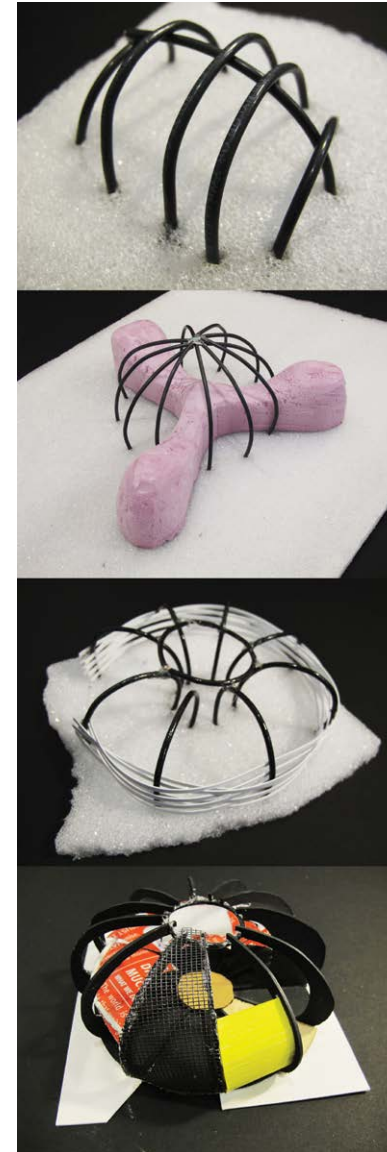

CURVE MODEL STUDIES

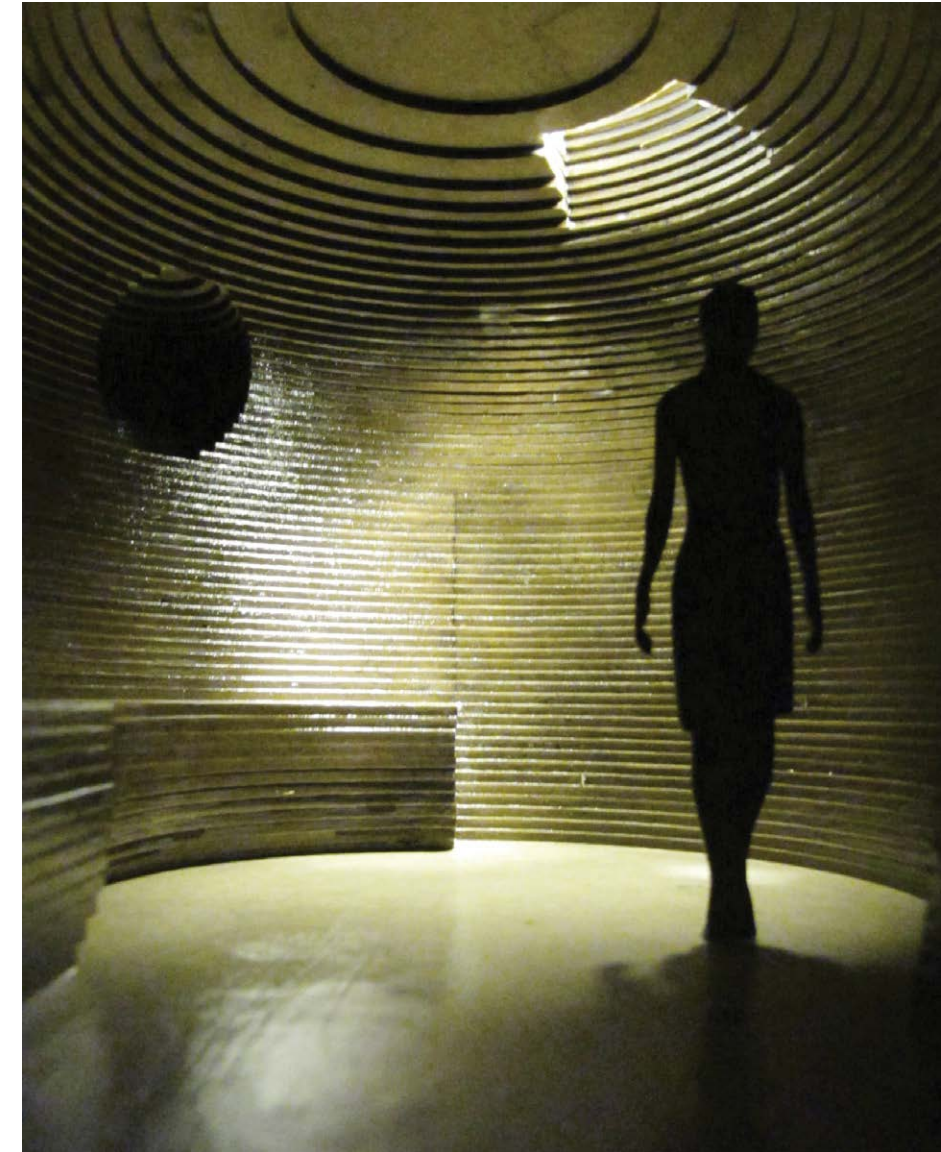

STEAM ROOM



CAFE



COMMUNAL BATH

LIGHT STUDIES



Filter - Light permeates through a series of repeating elements creating a pattern in the room.

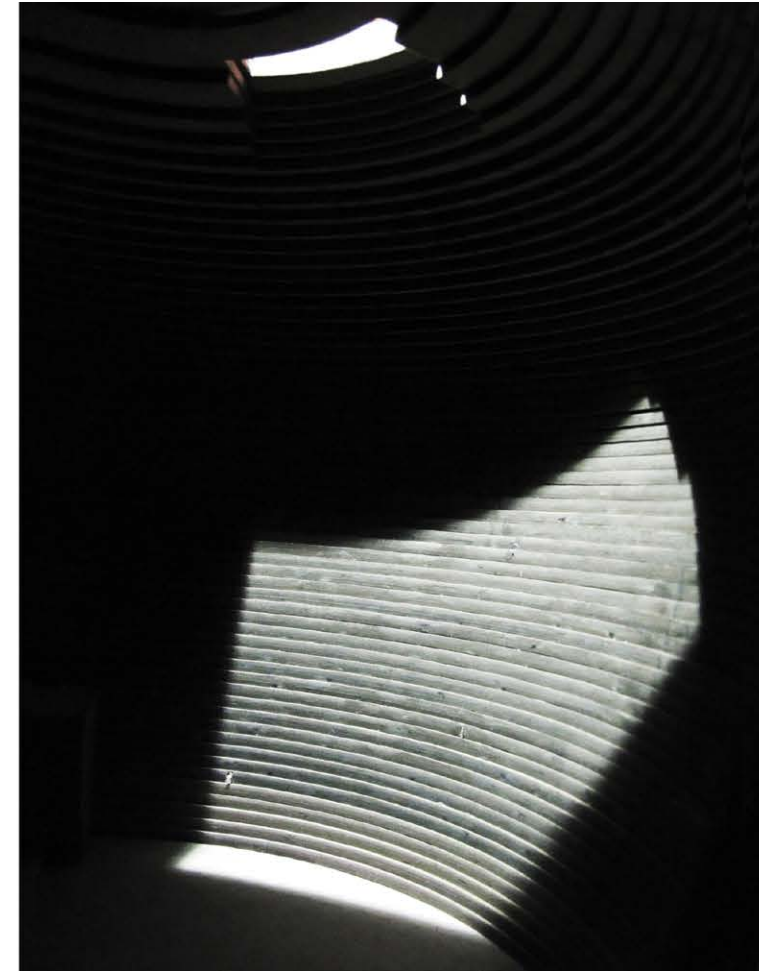

Edge - A crack of light in the ceiling floats down and illuminates the sloping surface.

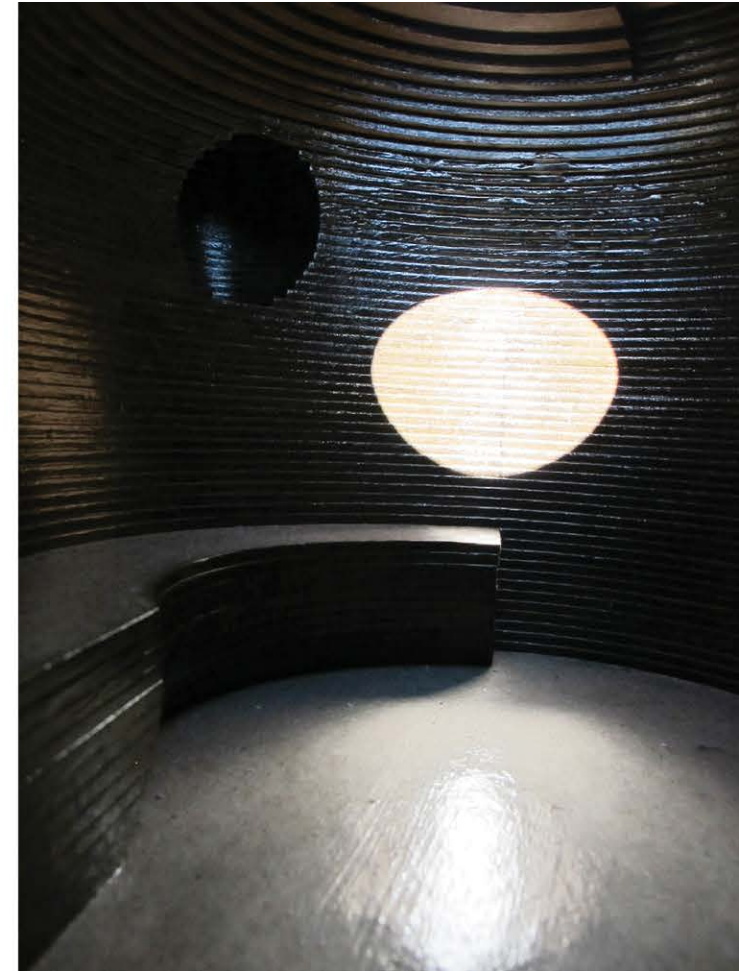

Spot - An oculus of light falls from above and creates a volume in the room.



LIGHT SKETCHES

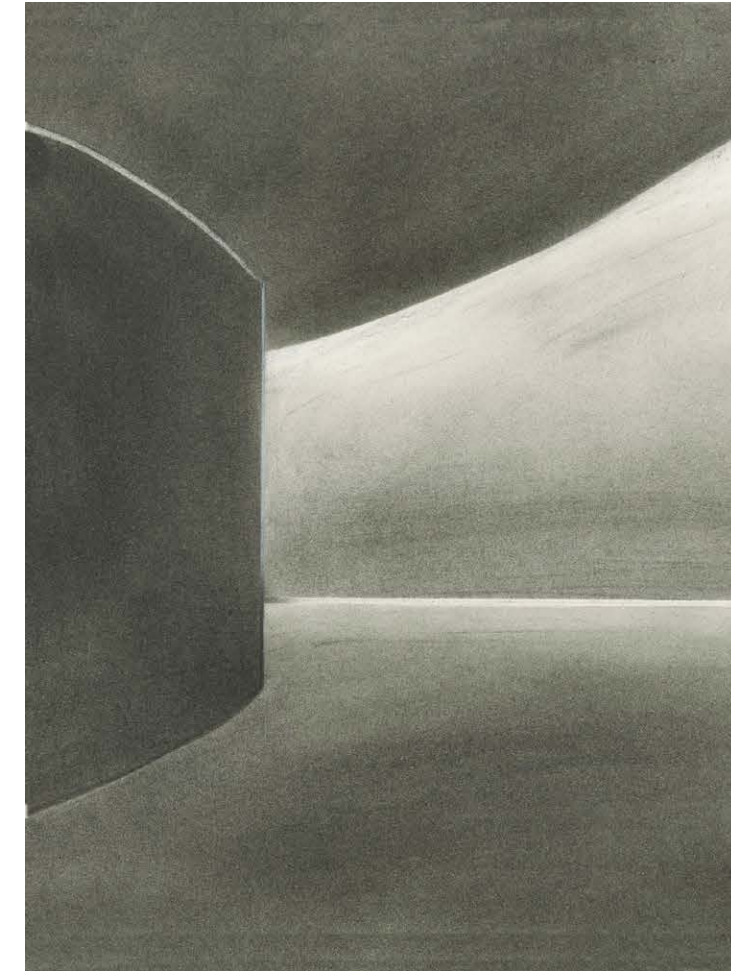

FRAME STUDIES

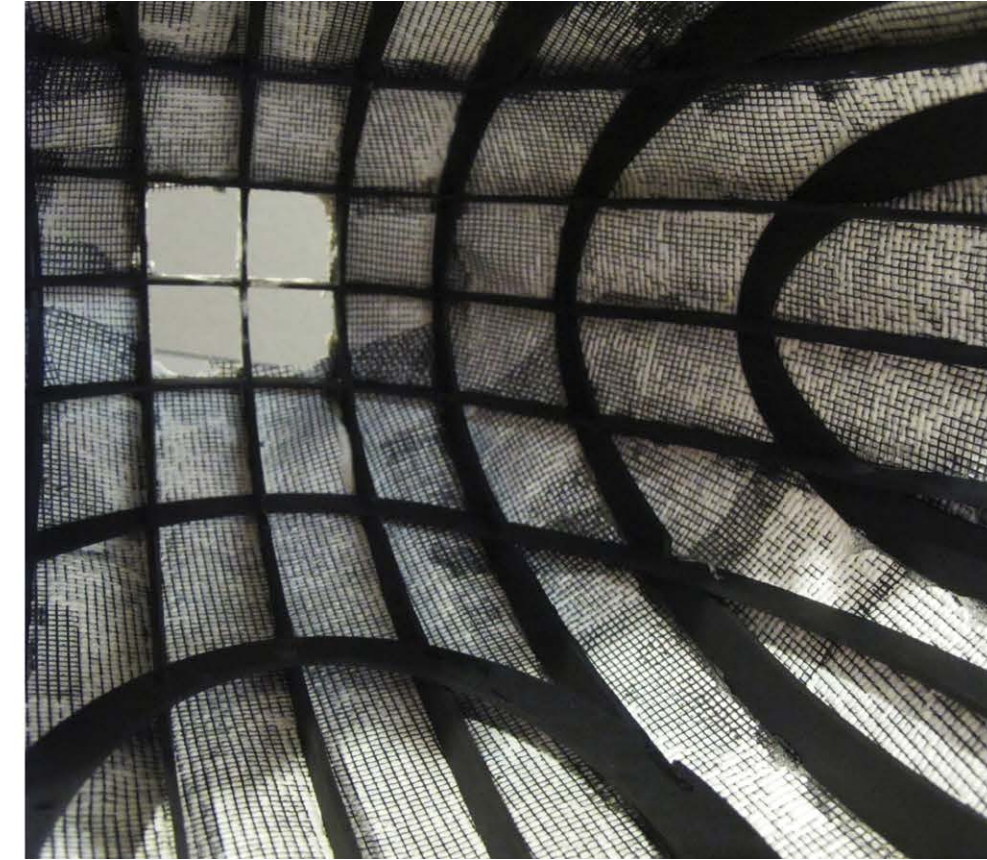
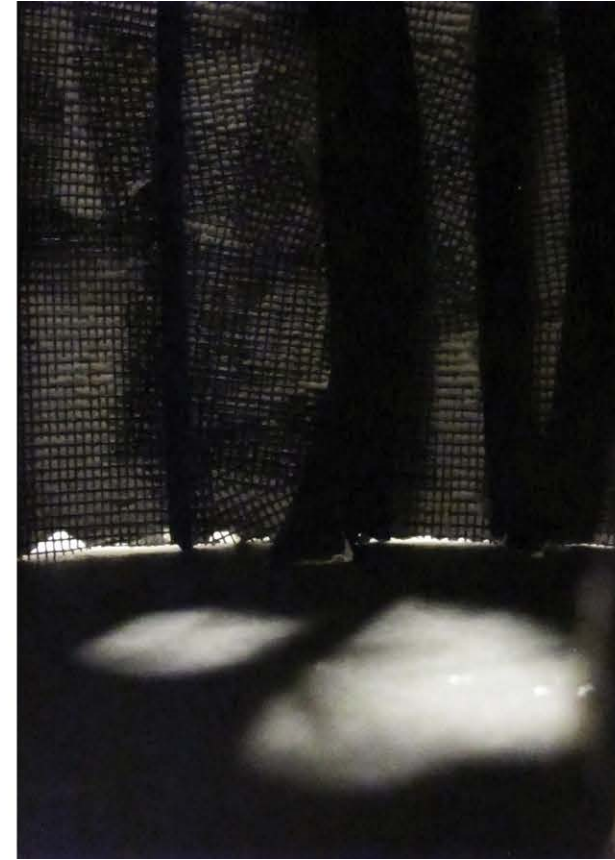

SPACE HOUSE



BUBBLE HOUSE

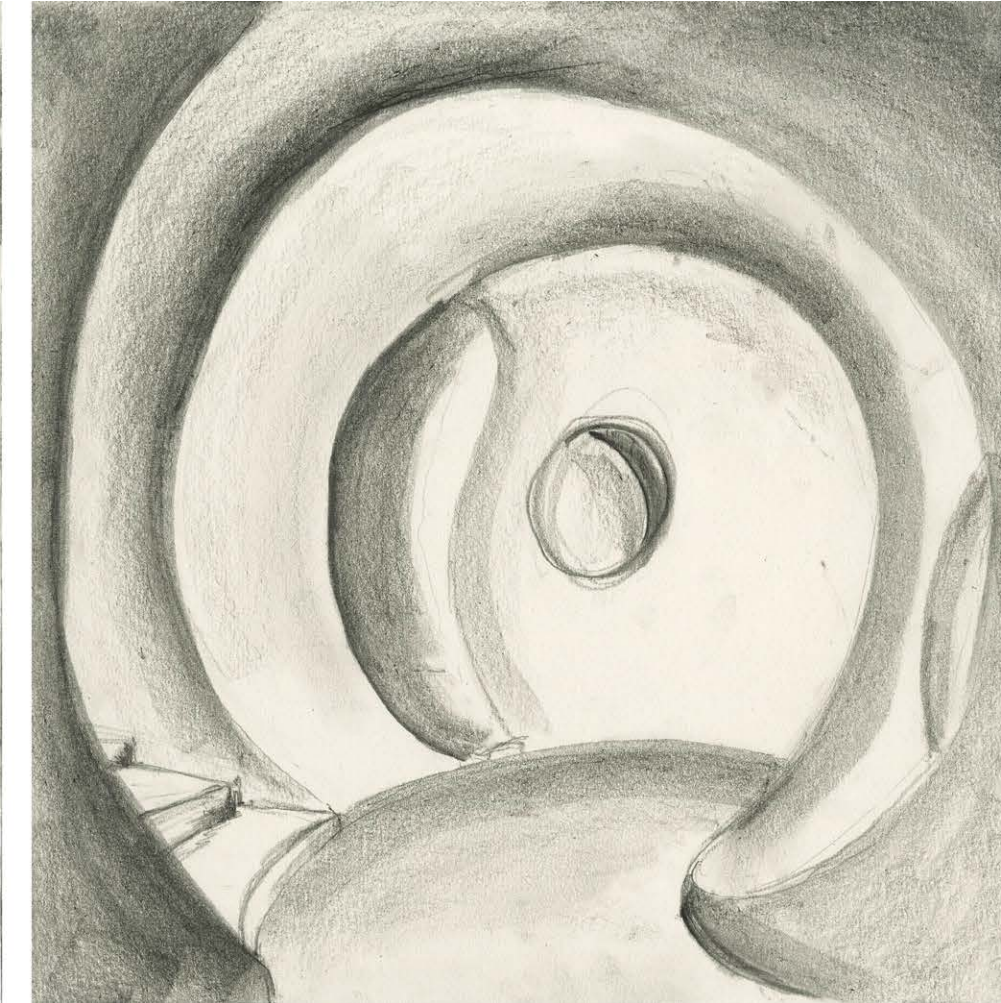

HOUSE OF THE CENTURY

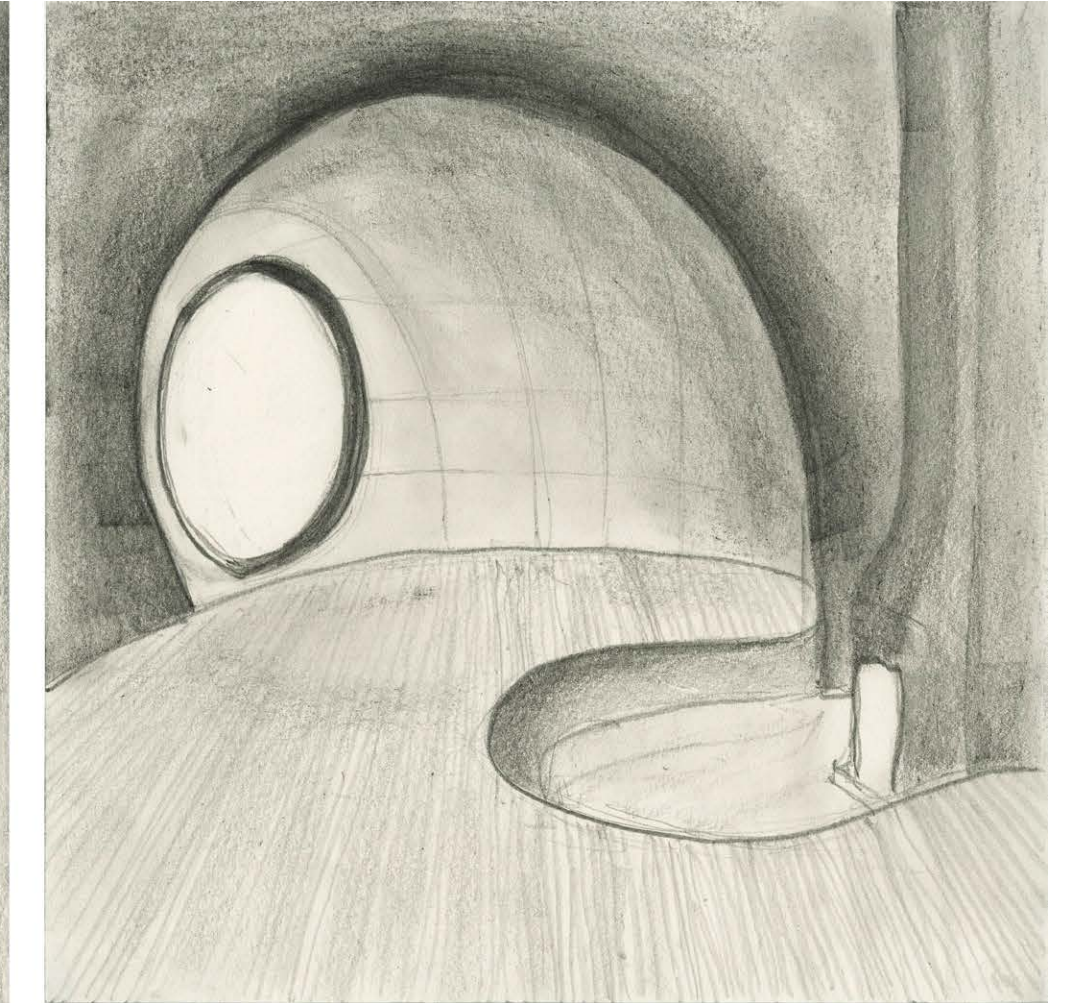

"Whether for economic reasons or lack of technical solutions, human beings have confined themselves to cubes full of dead ends and angles that impede our movement and break our harmony. The motion of our arms and legs through space traces circles similar to a circular field of vision. Conviviality is a circular phenomenon. The circle structures the way human life is carried out." -Antti Lovag, [www.archdaily.com/tag/antti-lovag/](http://www.archdaily.com/tag/antti-lovag/)

COLOR STUDIES

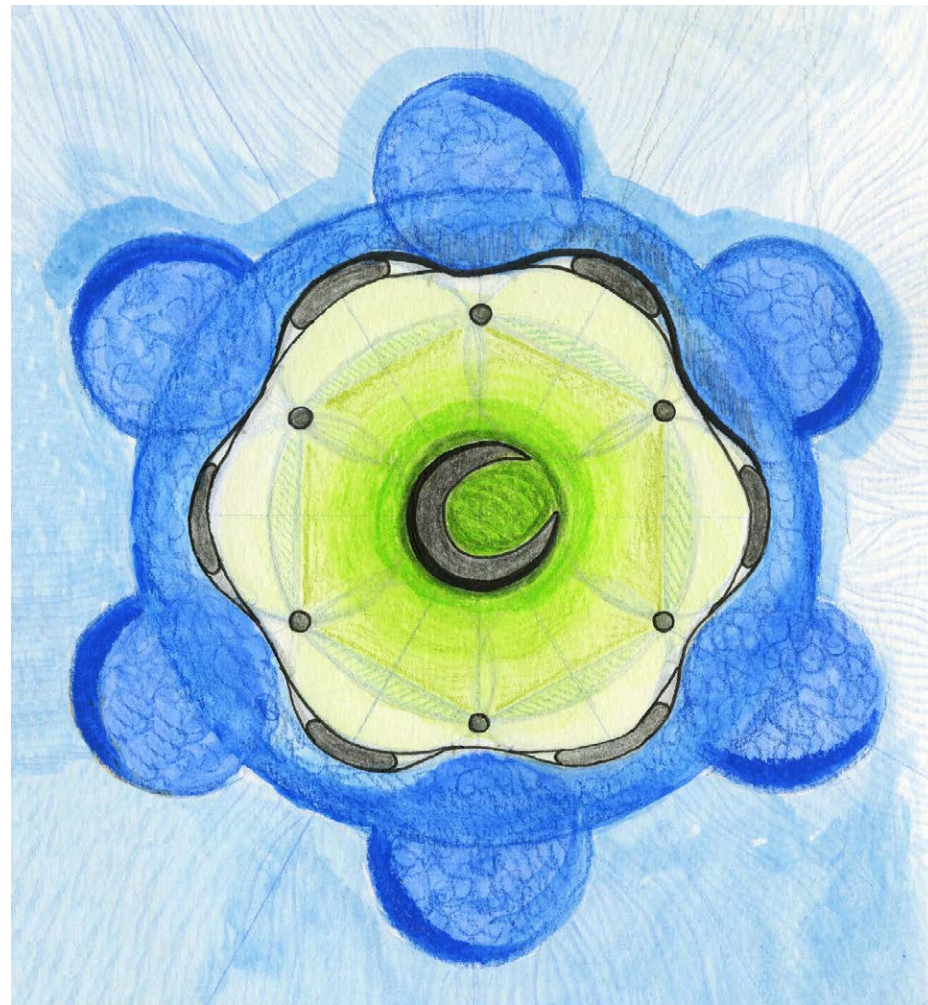
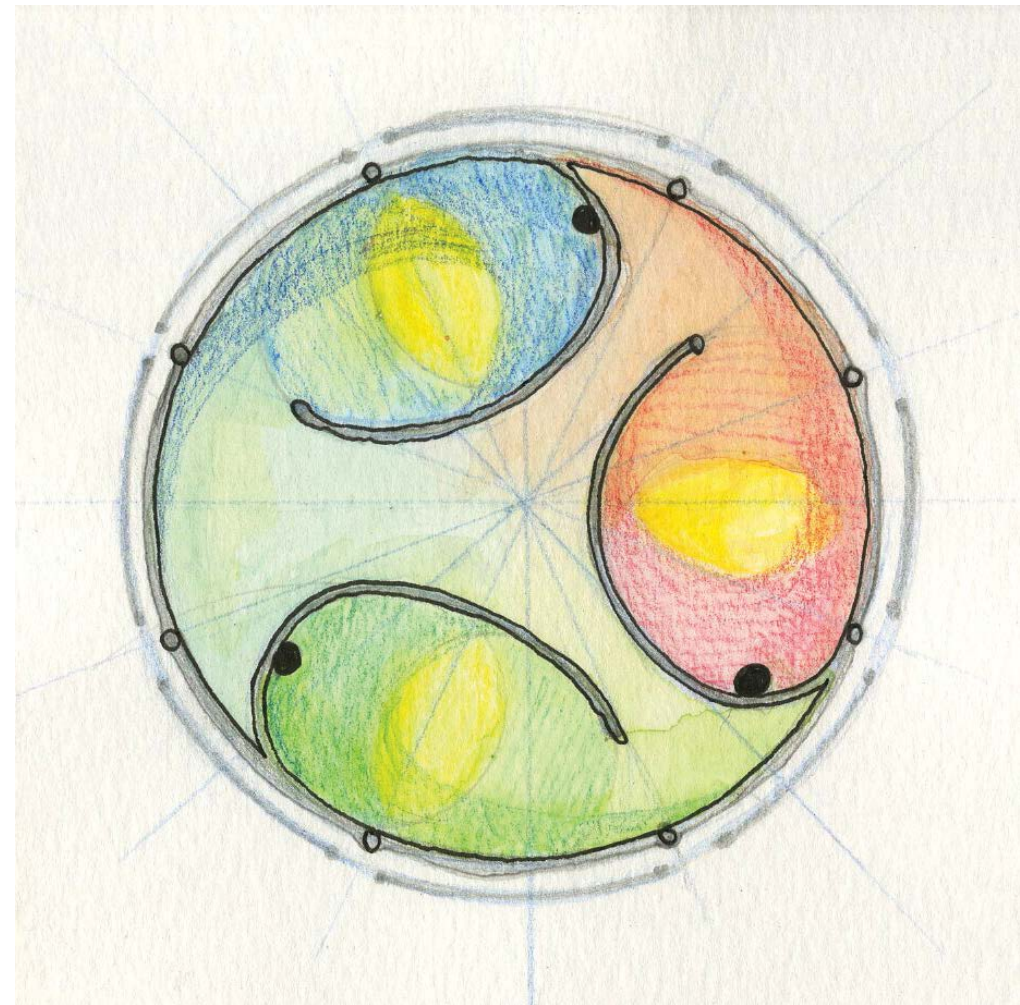
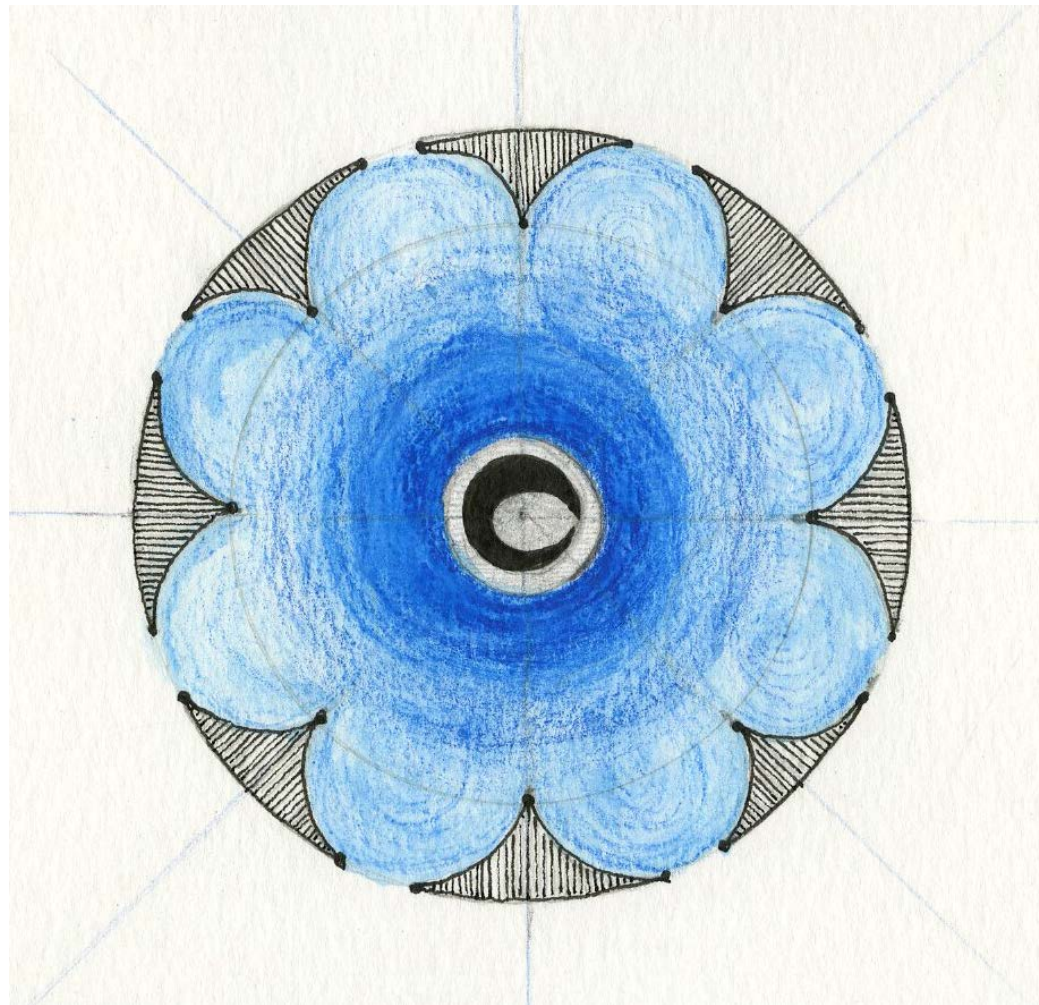

ORANGE AND BLUE MATRIX

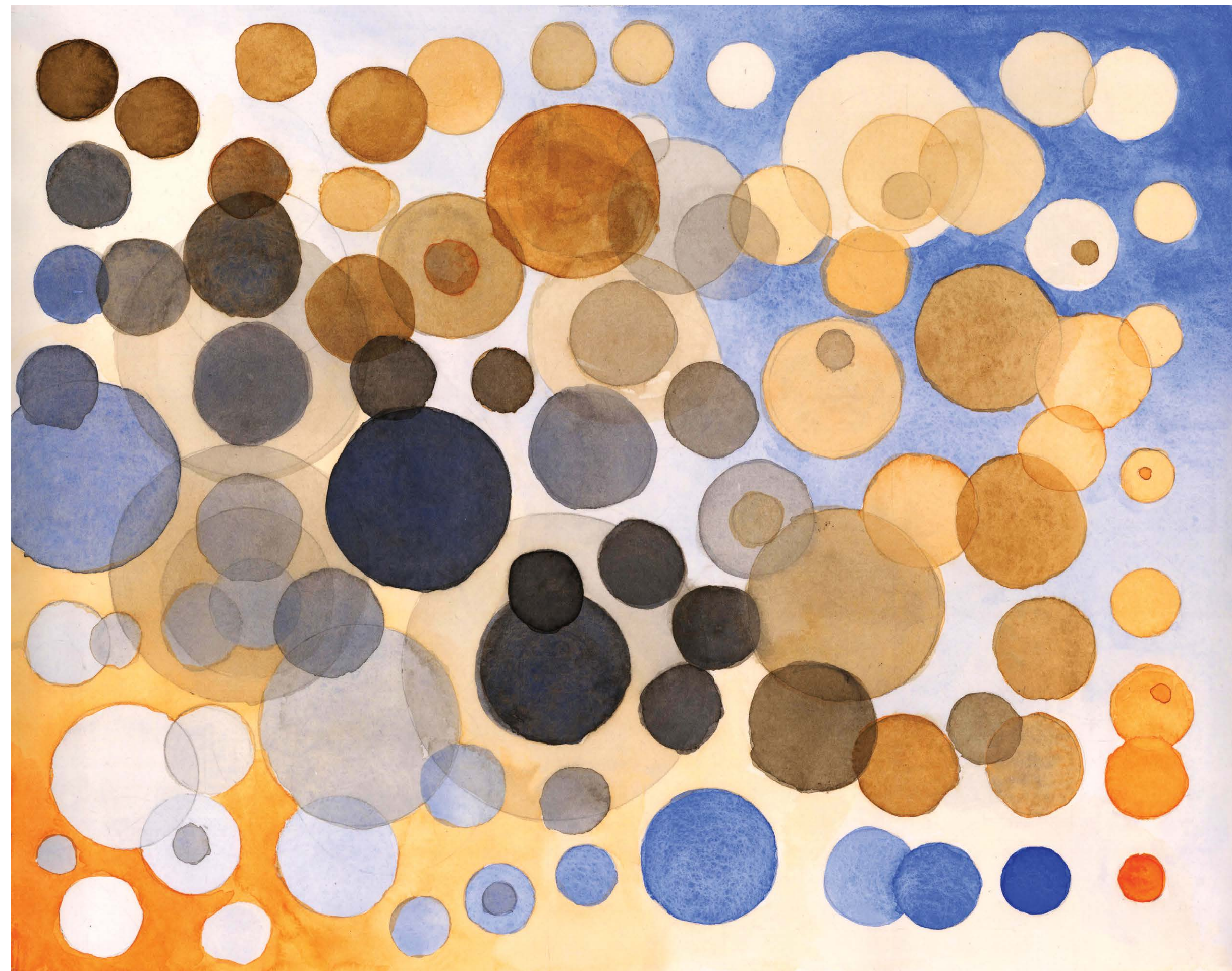



WAFFLE FRAME STUDIES

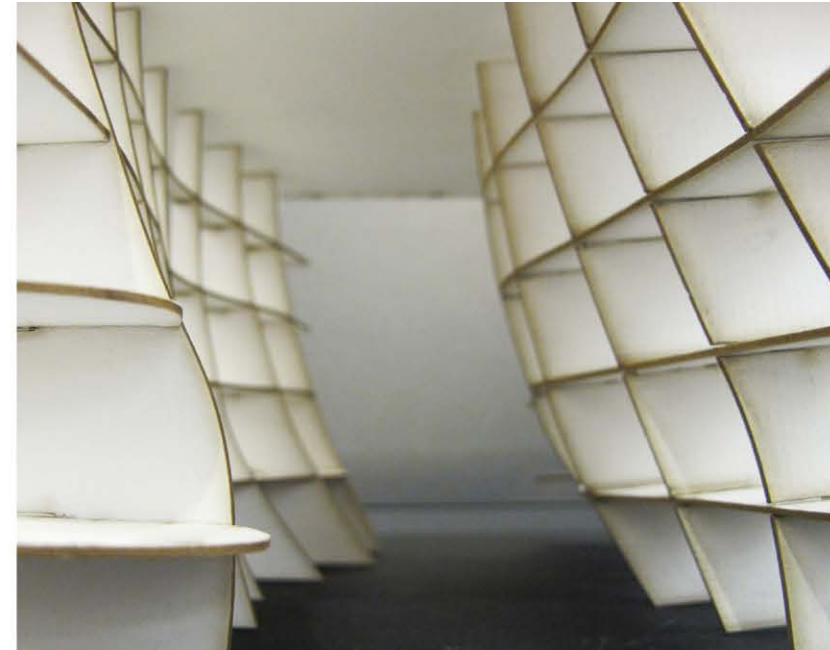
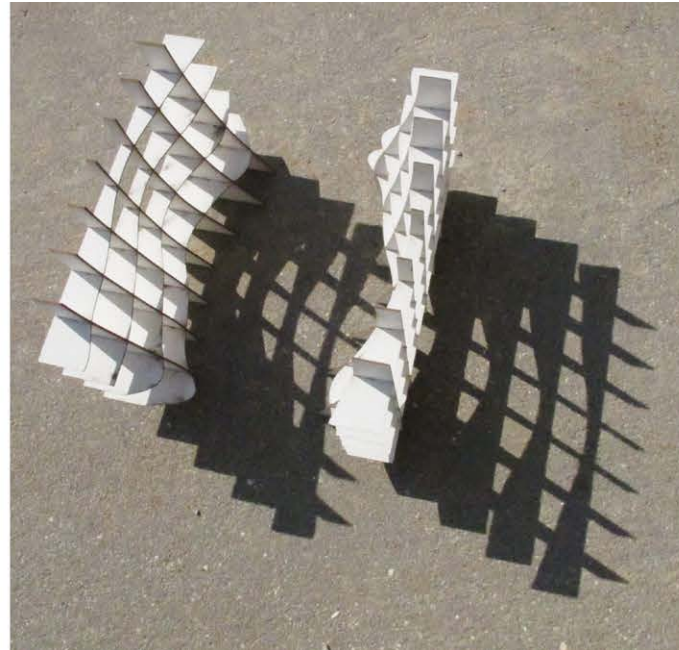
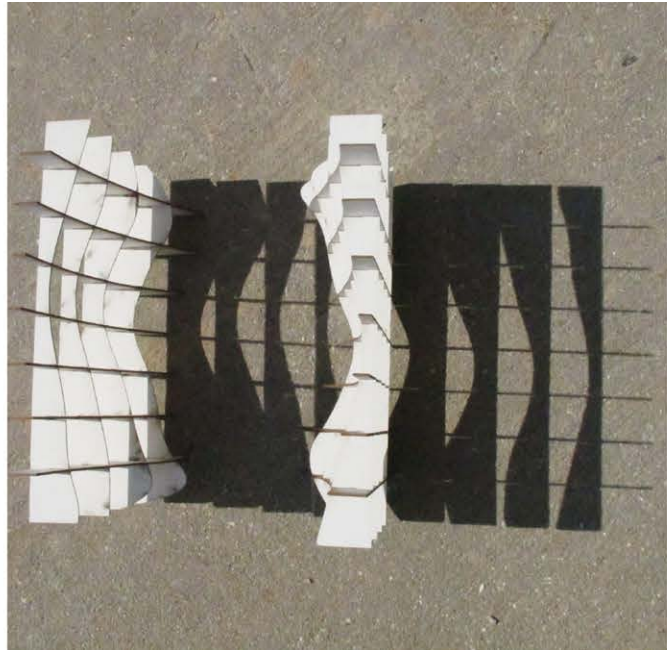
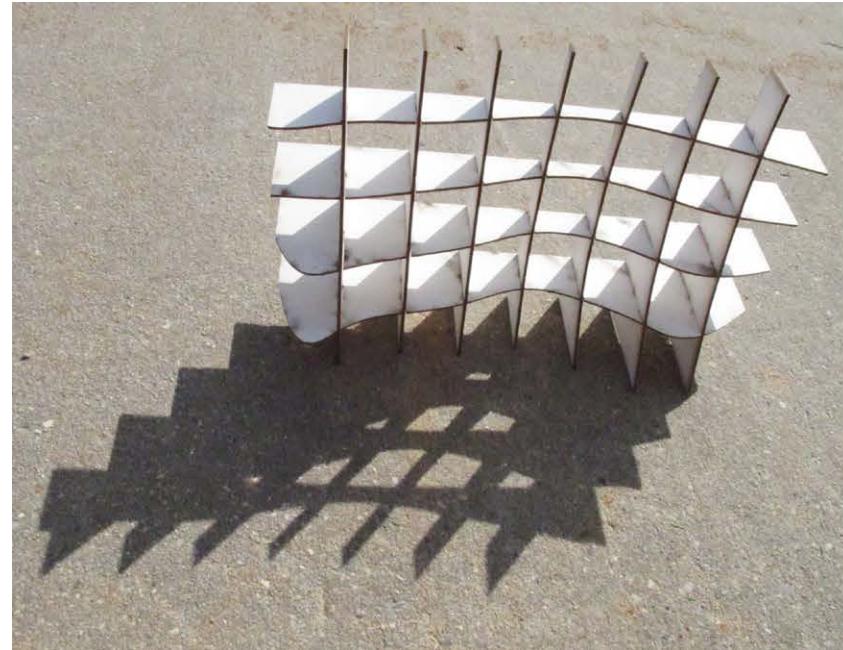

RIBBED STRUCTURE STUDIES

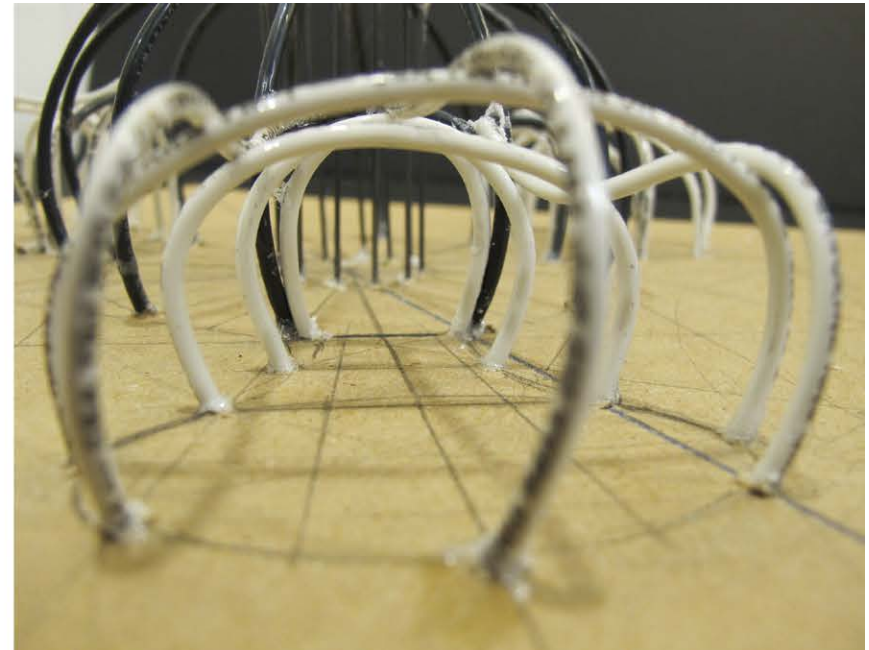
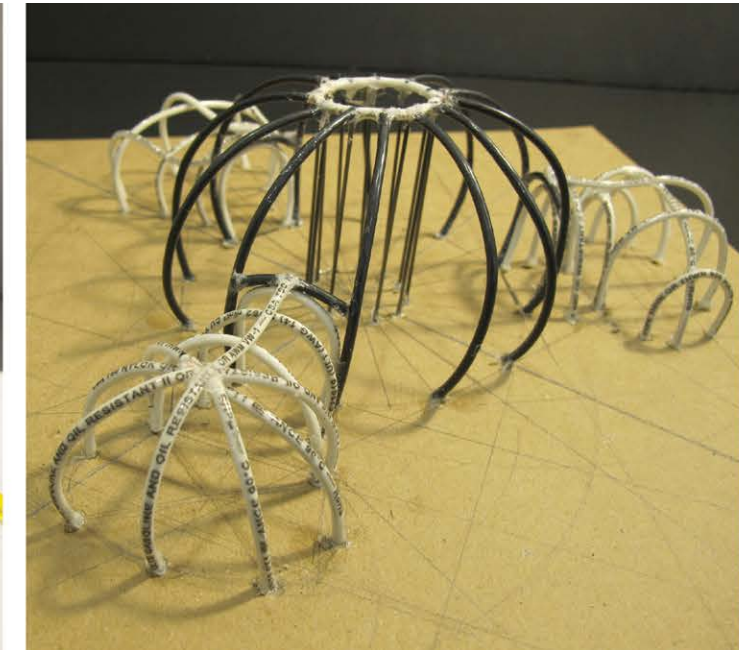
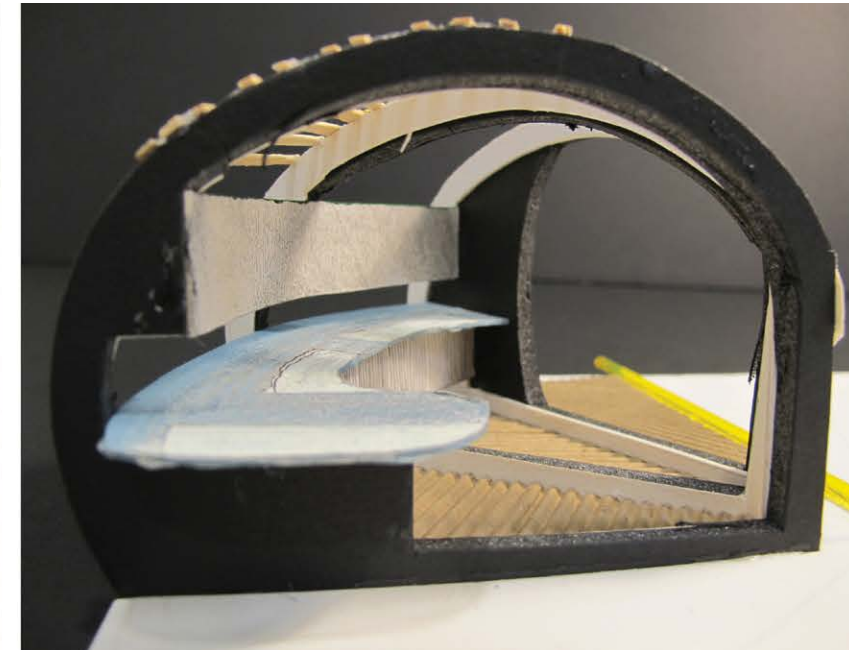

COMMUNAL BATH INTERIOR



STEAM ROOM INTERIOR

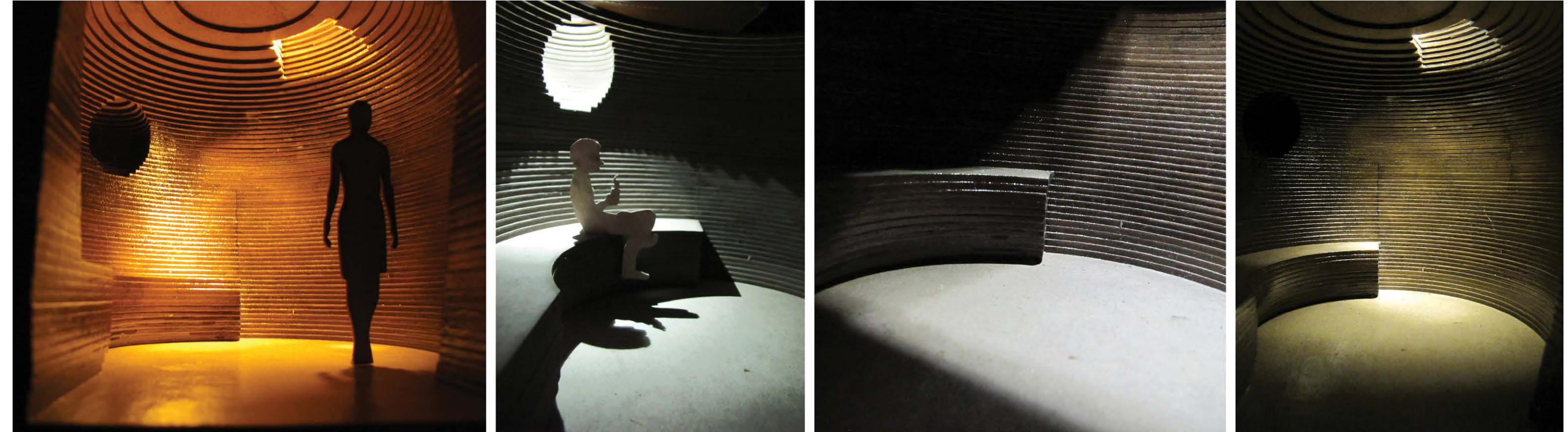

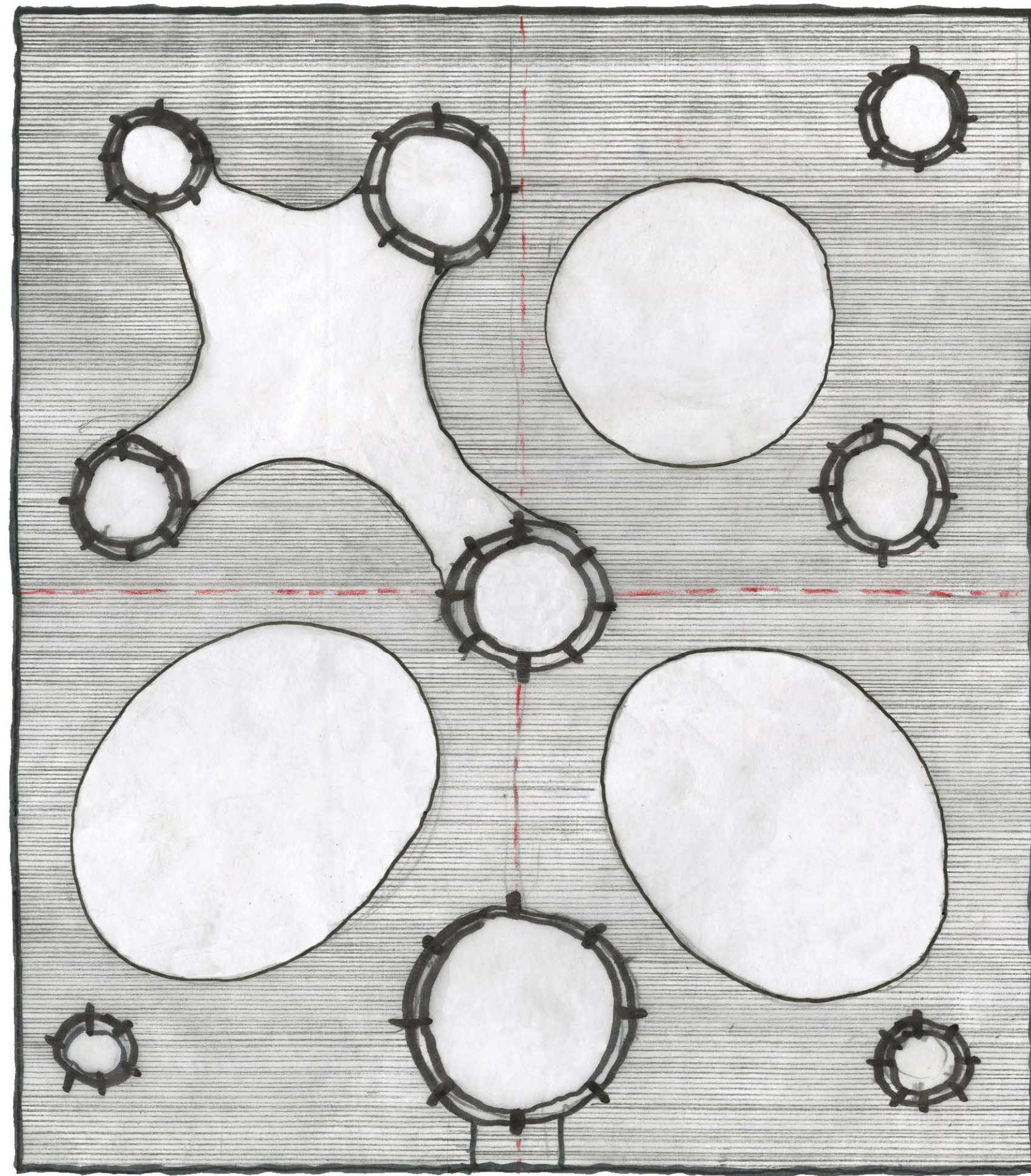

SPA PLAN CONCEPT 01

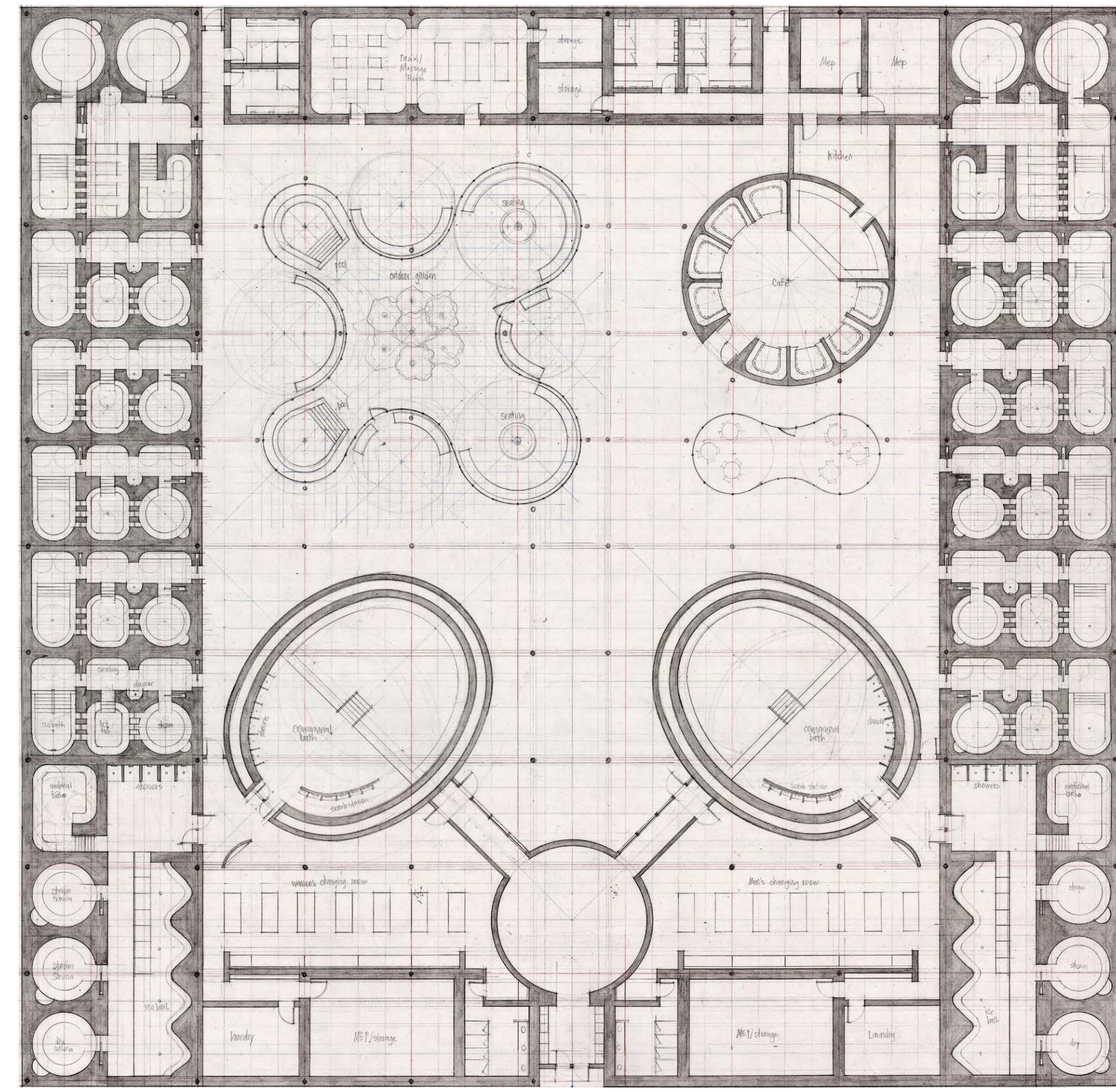

SPA PLAN CONCEPT 02

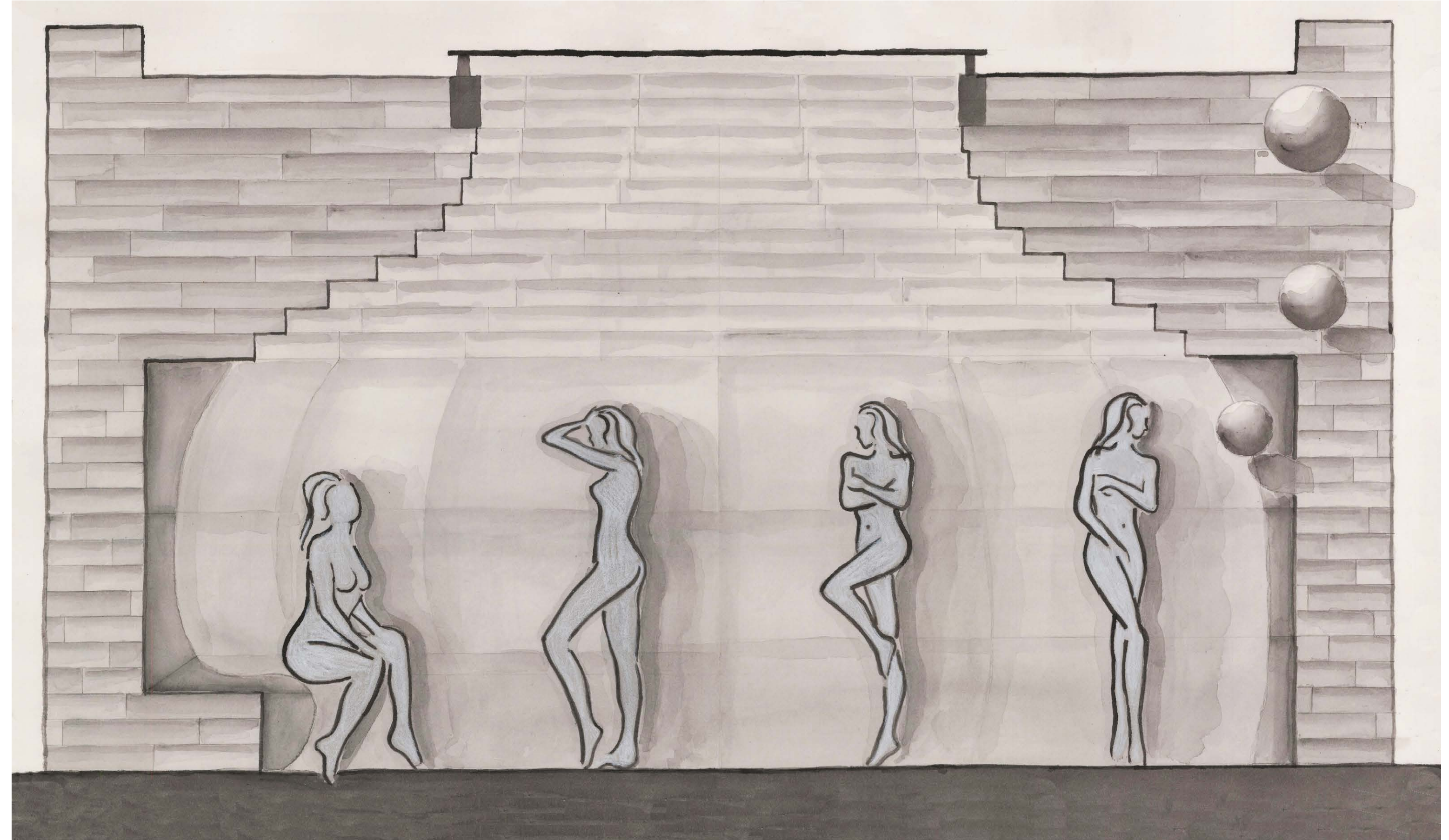
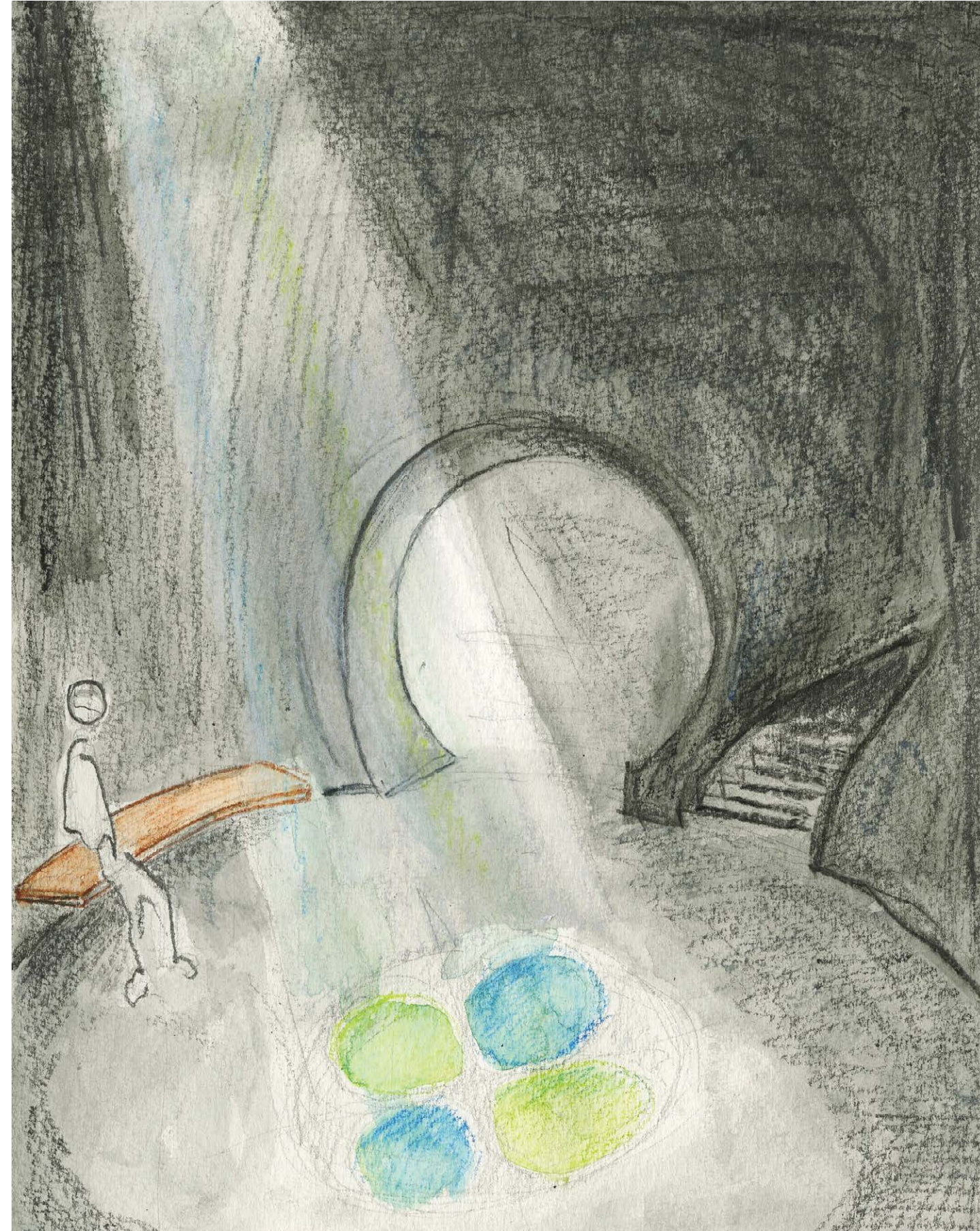

## THE BODY

: a study of the human form – its characteristics and the way in which it moves as a part and as a whole.

The naked body has a sensual beauty that should be celebrated. Its sculpted muscle, its flexibility of parts, and its soft and smooth skin are pleasing to see and feel. Our body, in its entirety, is made up of sinuous curves. The way our hands are shaped, to the way our hips rotate, to the motion of our torso when we engage in our surroundings, are all continuous. As the body touches a surface with its hands and feet, it becomes aware of its tactile sense. Surfaces are experienced through sitting, leaning, kneeling, and lying. If we experience the world first with our body, then design should attempt to actively respond to its patterns and activities that take place within a space. In responding to the body's positions and gestures, the space welcomes its presence. And the body, in turn, enjoys engaging with its surroundings.

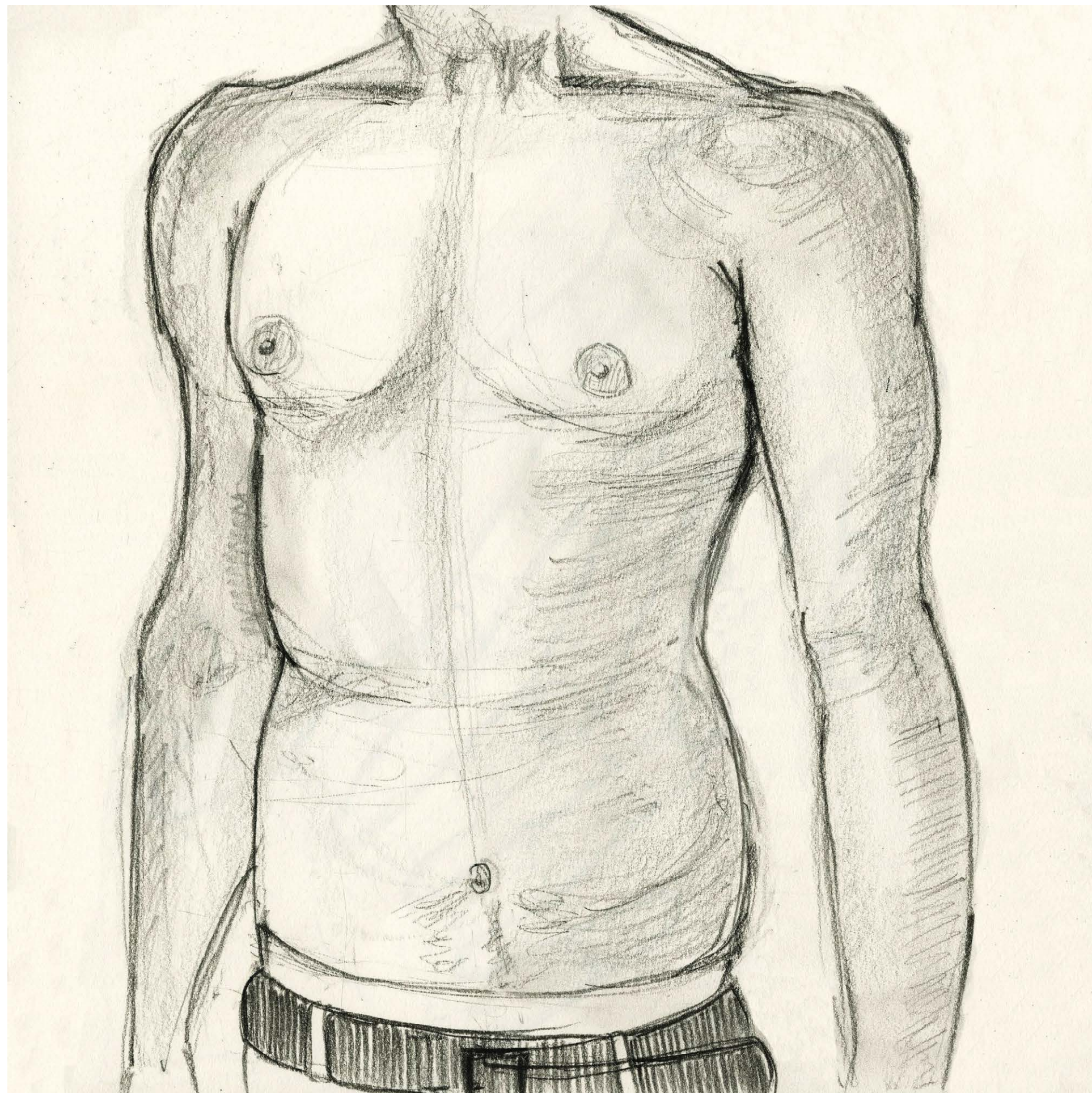

## BODY PROPORTIONS

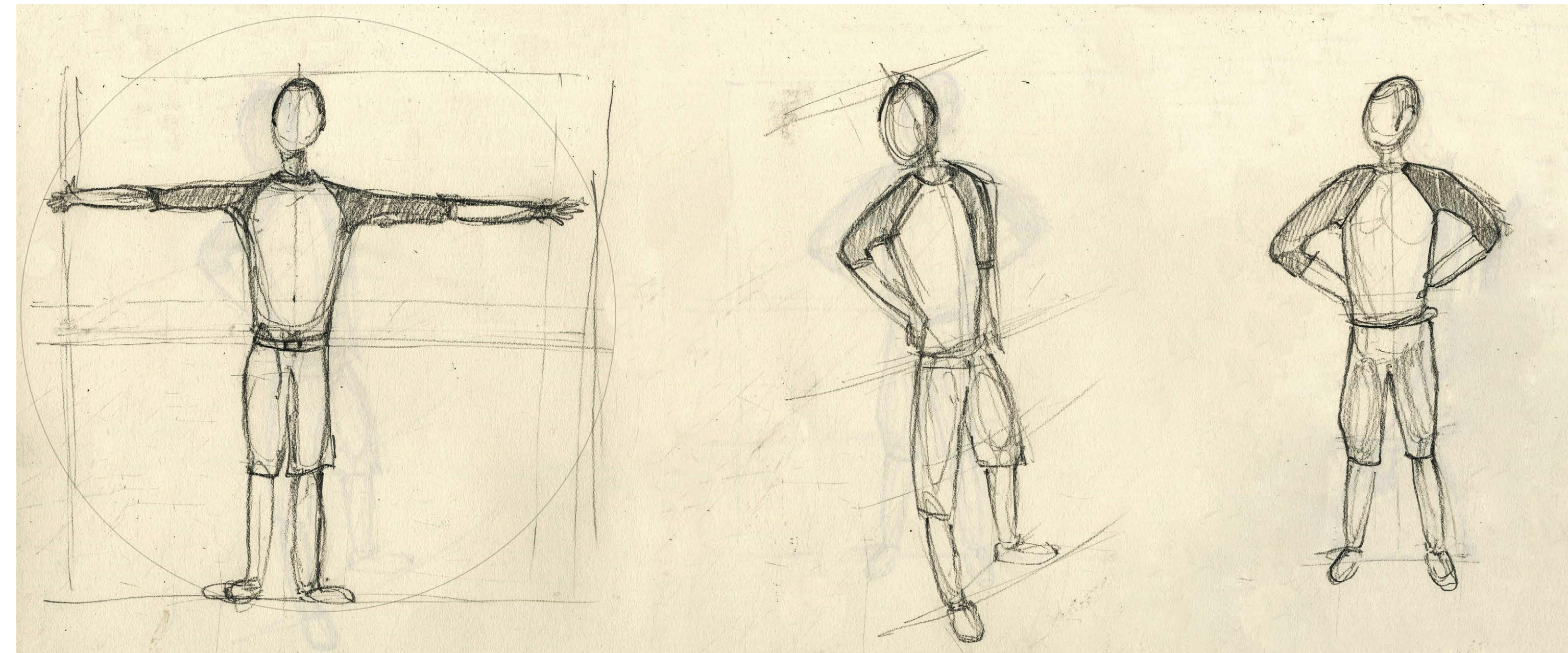

"We behold, touch, listen and measure the world with our entire bodily existence, and the experiential world becomes organised and articulated around the centre of the body." -Juhani Pallasmaa, *The Eyes of the Skin*

TACTILE SENSE

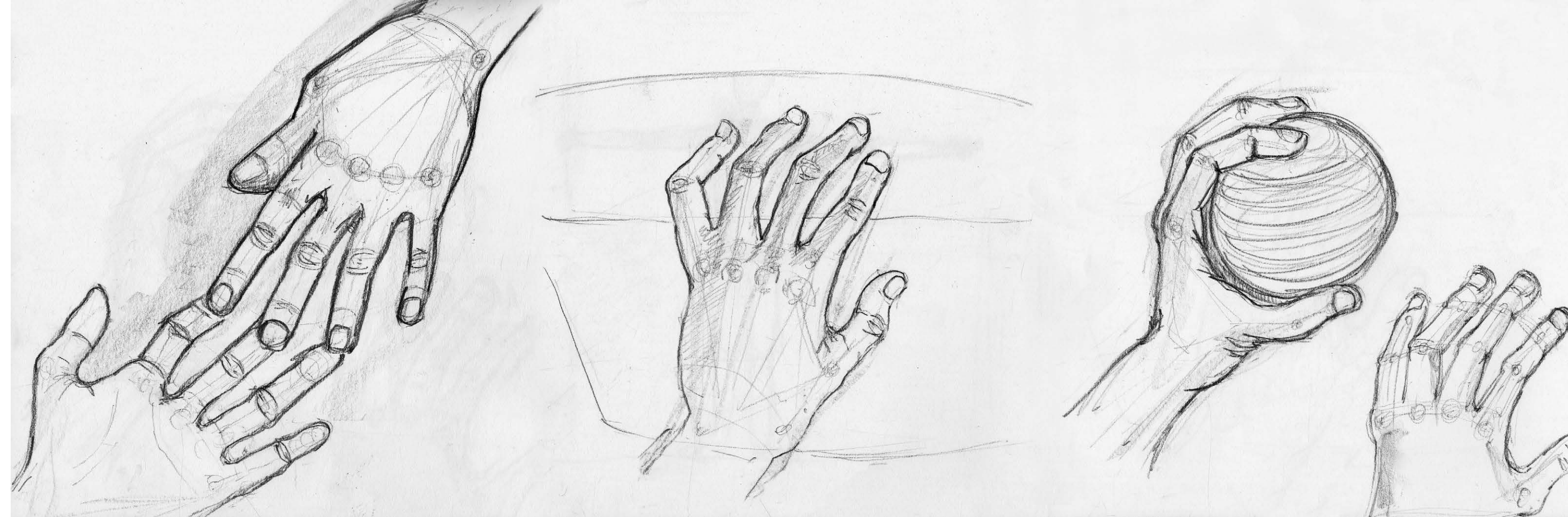

BODY POSITIONS

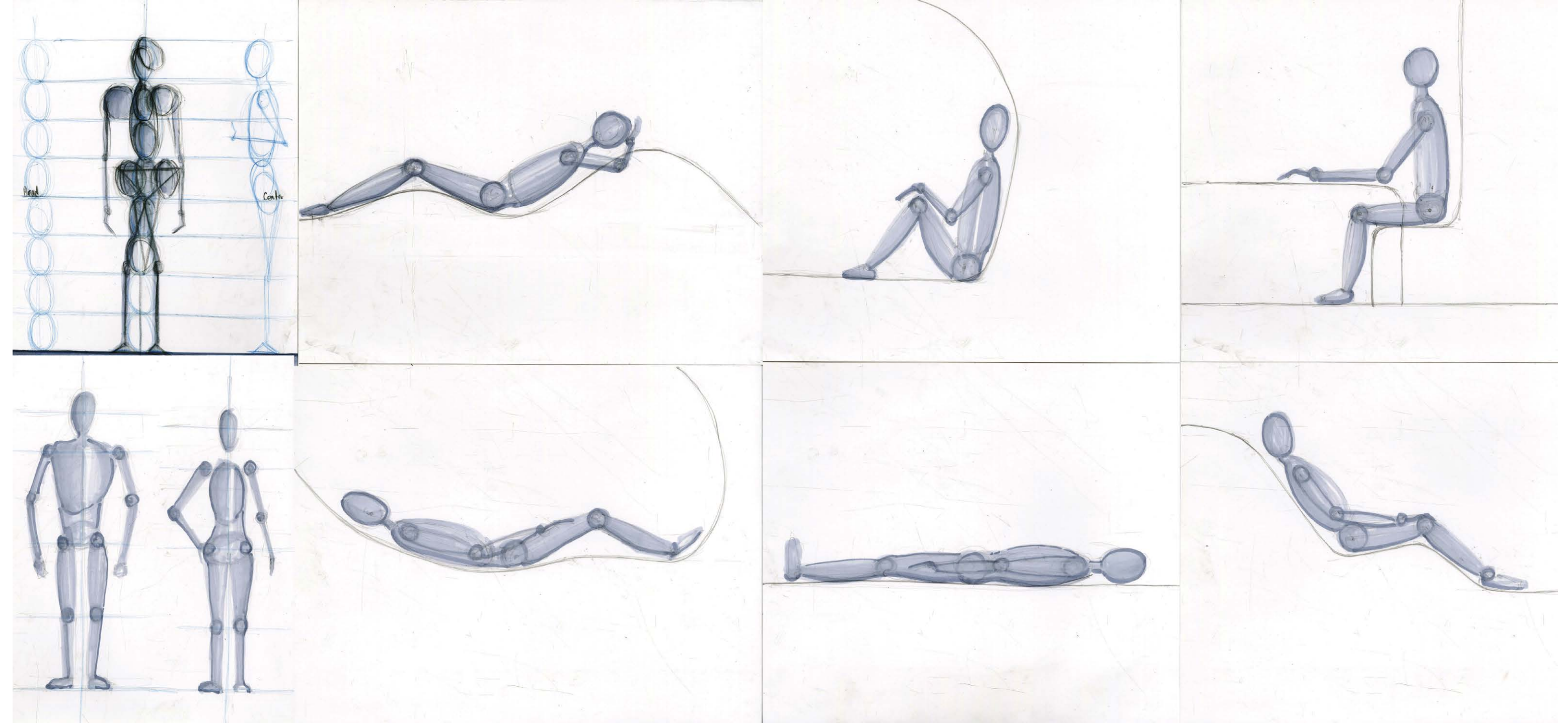

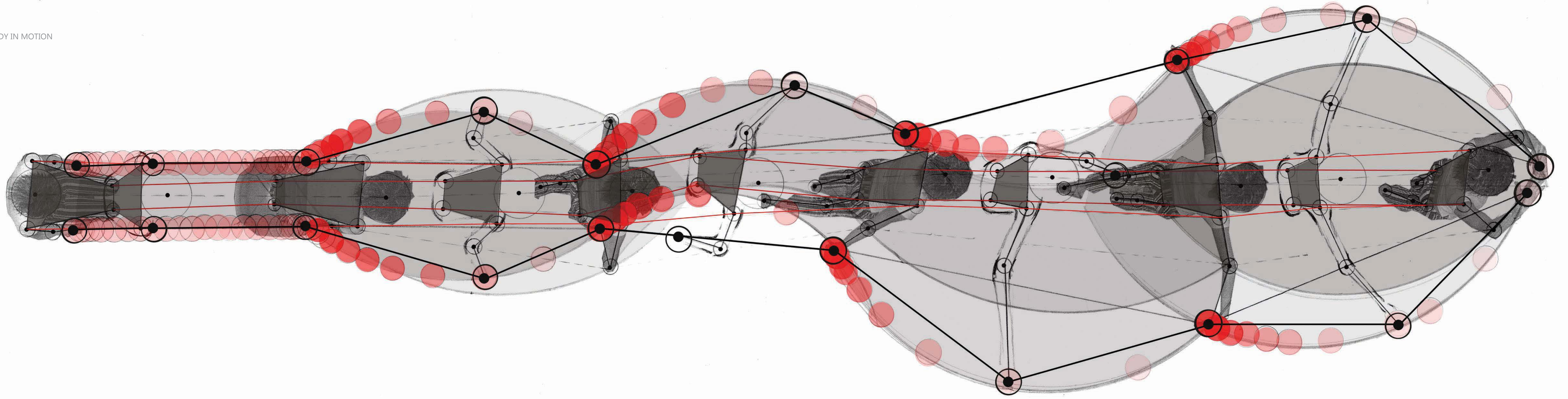

BODY AND SURFACE 01

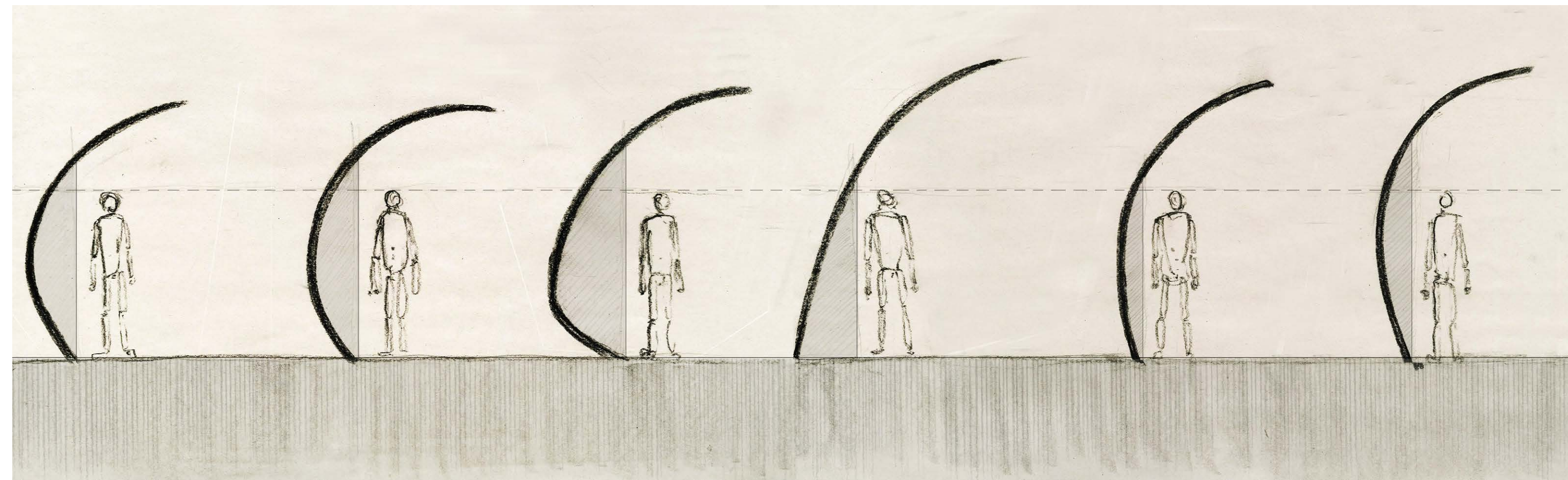

BODY AND BUILDING 02

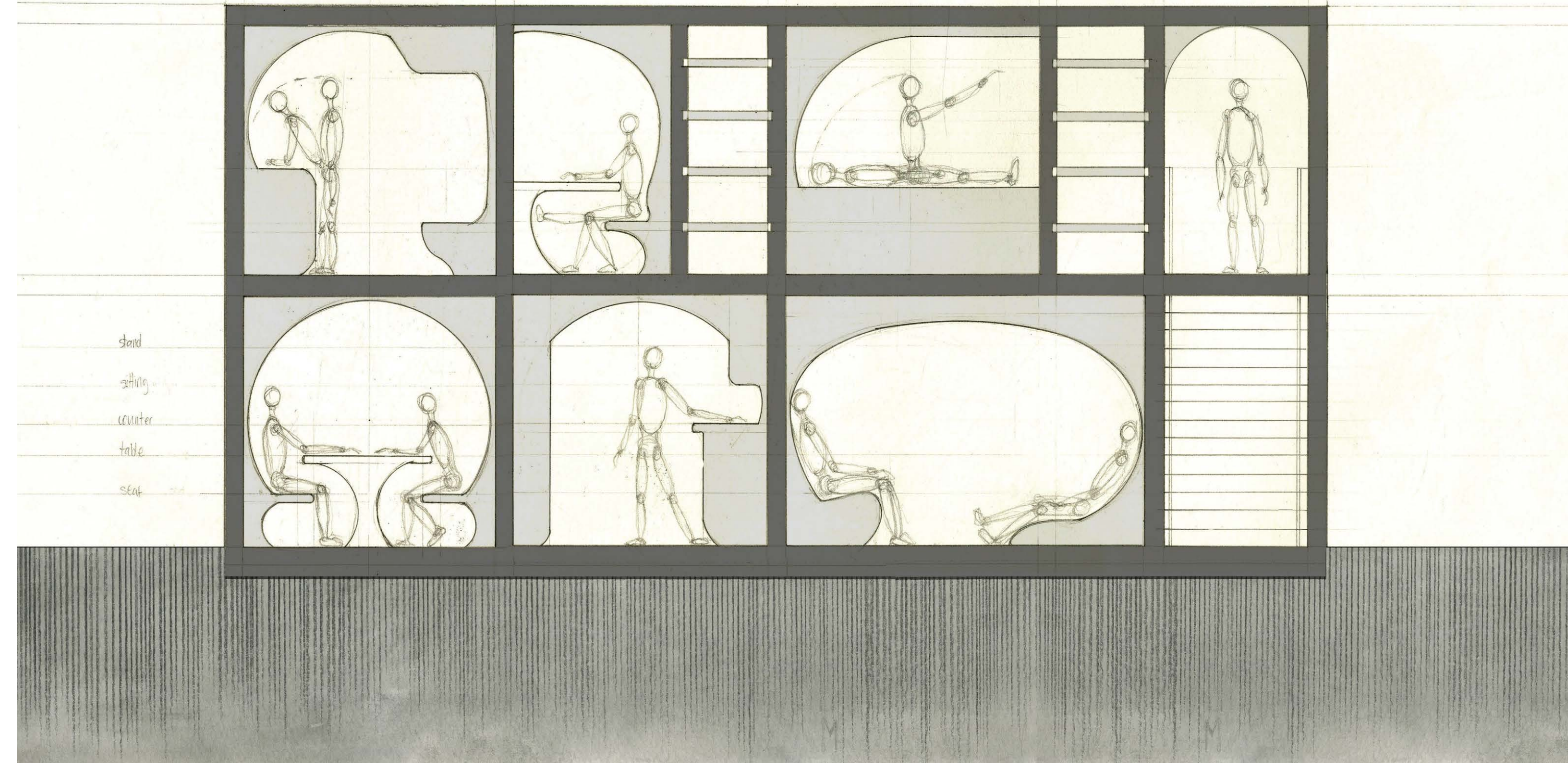



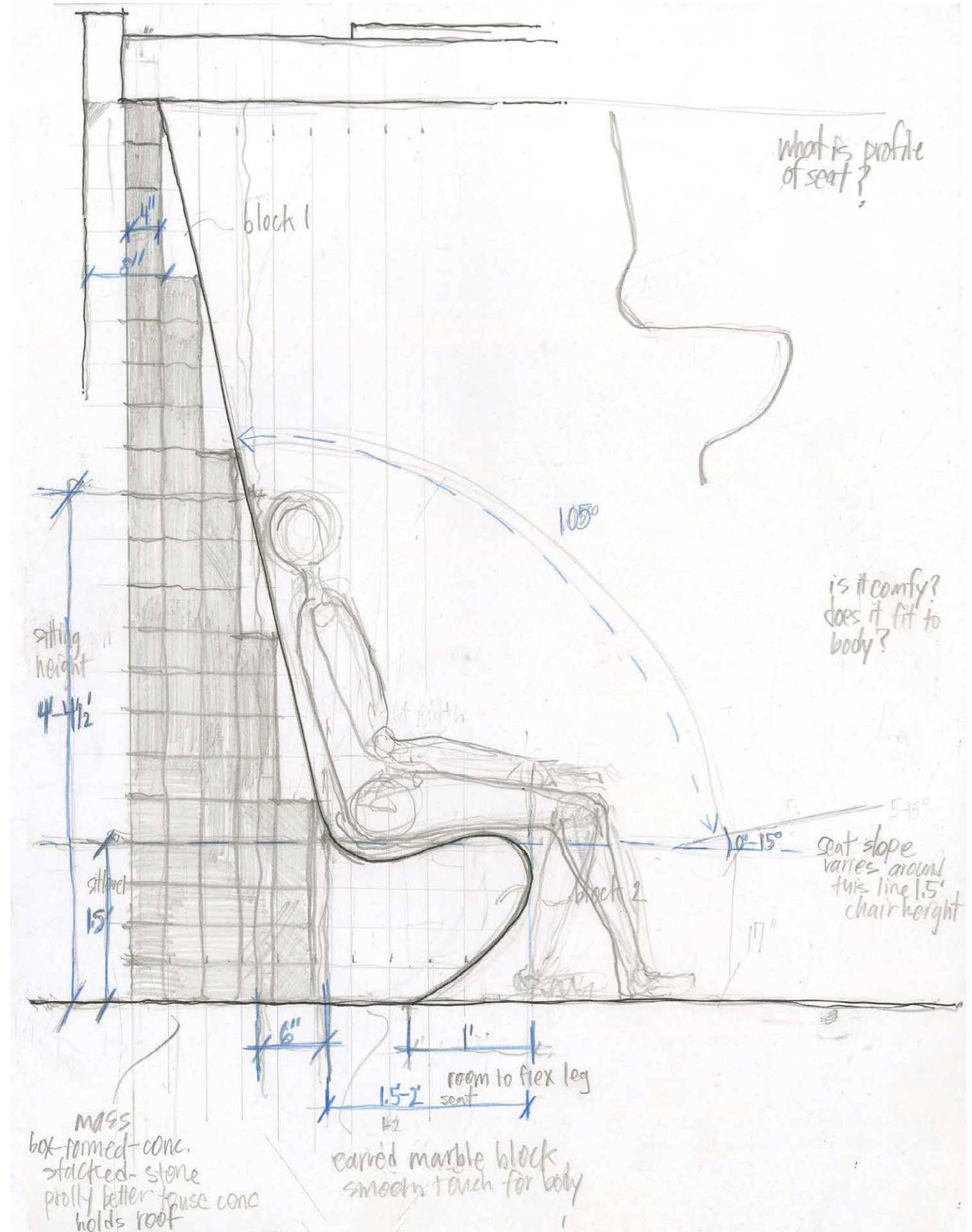
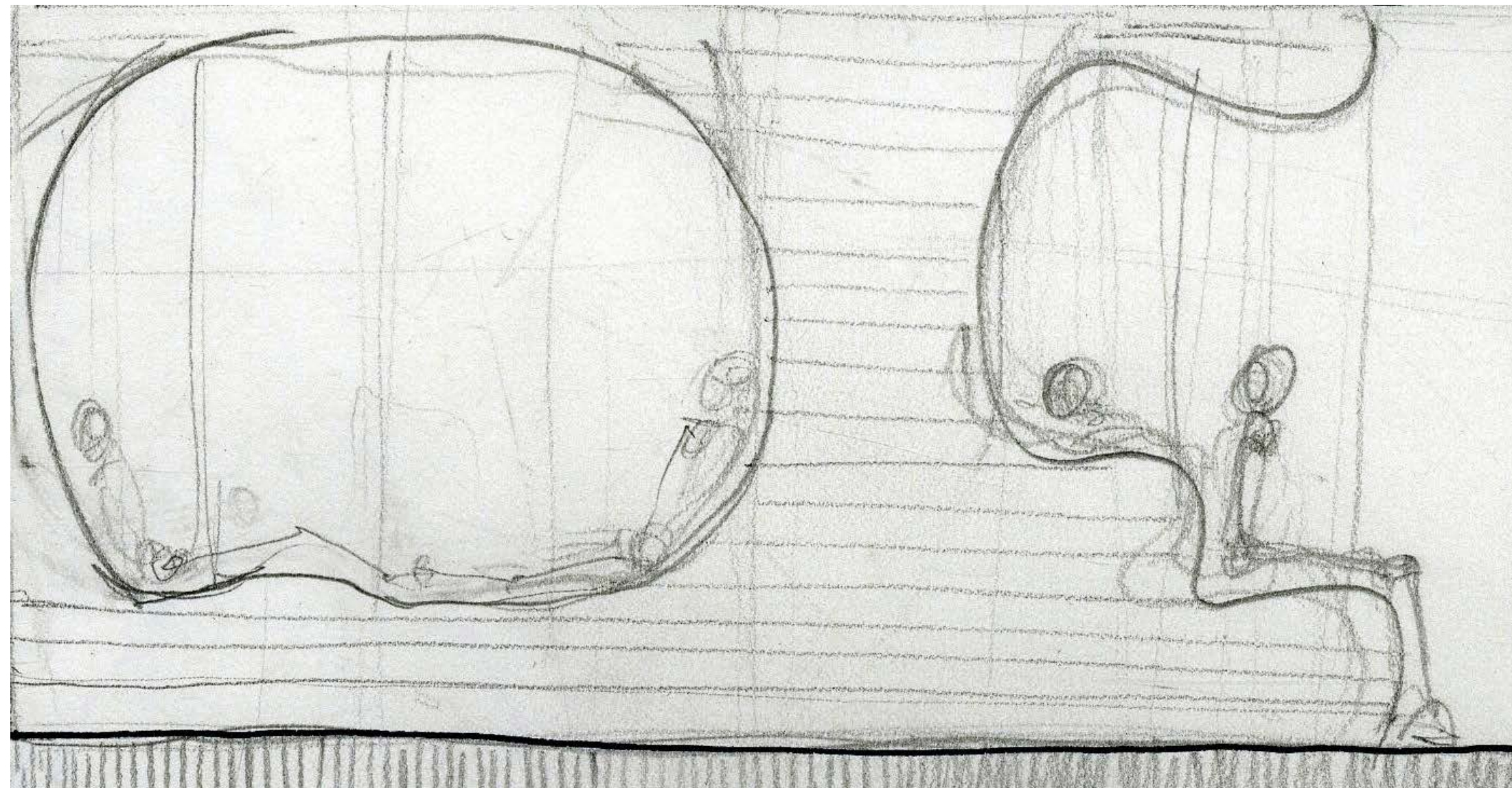
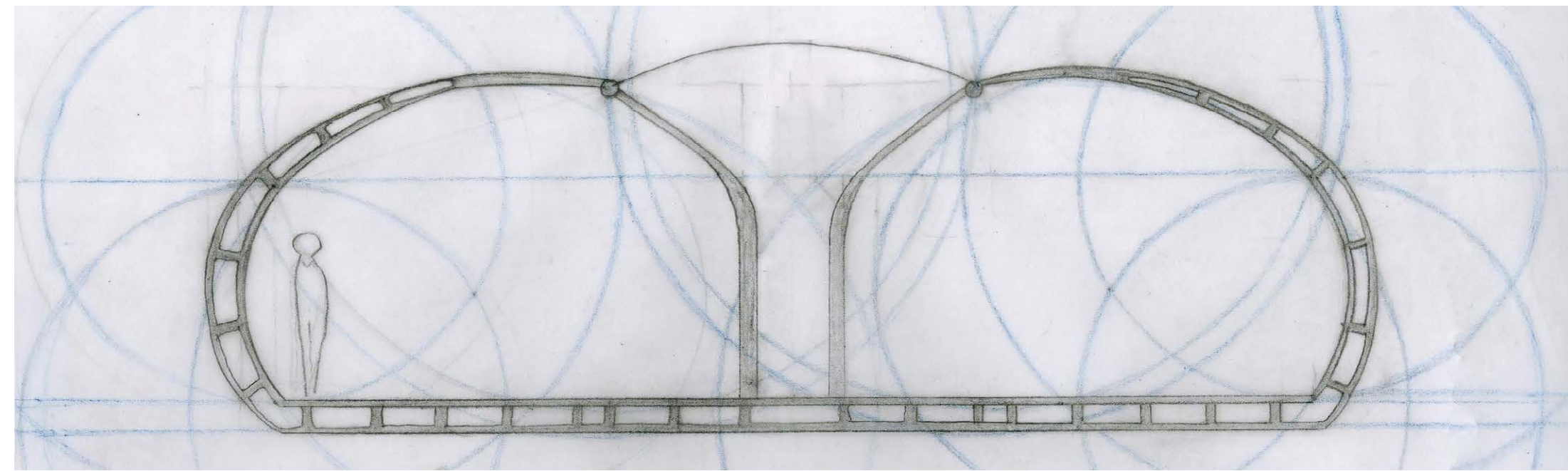

## A PLACE

The site is located in a growing neighborhood of Washington DC, a few blocks north of the Chinatown metro station, currently surrounded by construction. Within a busy urban context, the Garden Spa is a place of respite from the daily hustle of routine life. It offers a transcendent realm without sin or shame.

The Garden Spa has traditional elements of a bath house that separate communal bathing for men and women, but it also offers small and large private units that cater to the individual or a small group. Here, the body is restored through the rituals of bathing. The senses are enlightened with positive energy, and the soul is nourished, generating a place of tranquility.

"Why is it - in our need to control our modern lives - that we have forsaken the very things that enrich and express our biological essence? The spa experience encourages us to celebrate our senses and get back in touch with the sensuous. The empirical experience (all that one can potentially see, hear, touch, taste, and smell) drives the design of a spa. It is a substantial contribution to the sensuous experience." -Robert Henry, *Spa: The Sensuous Experience*

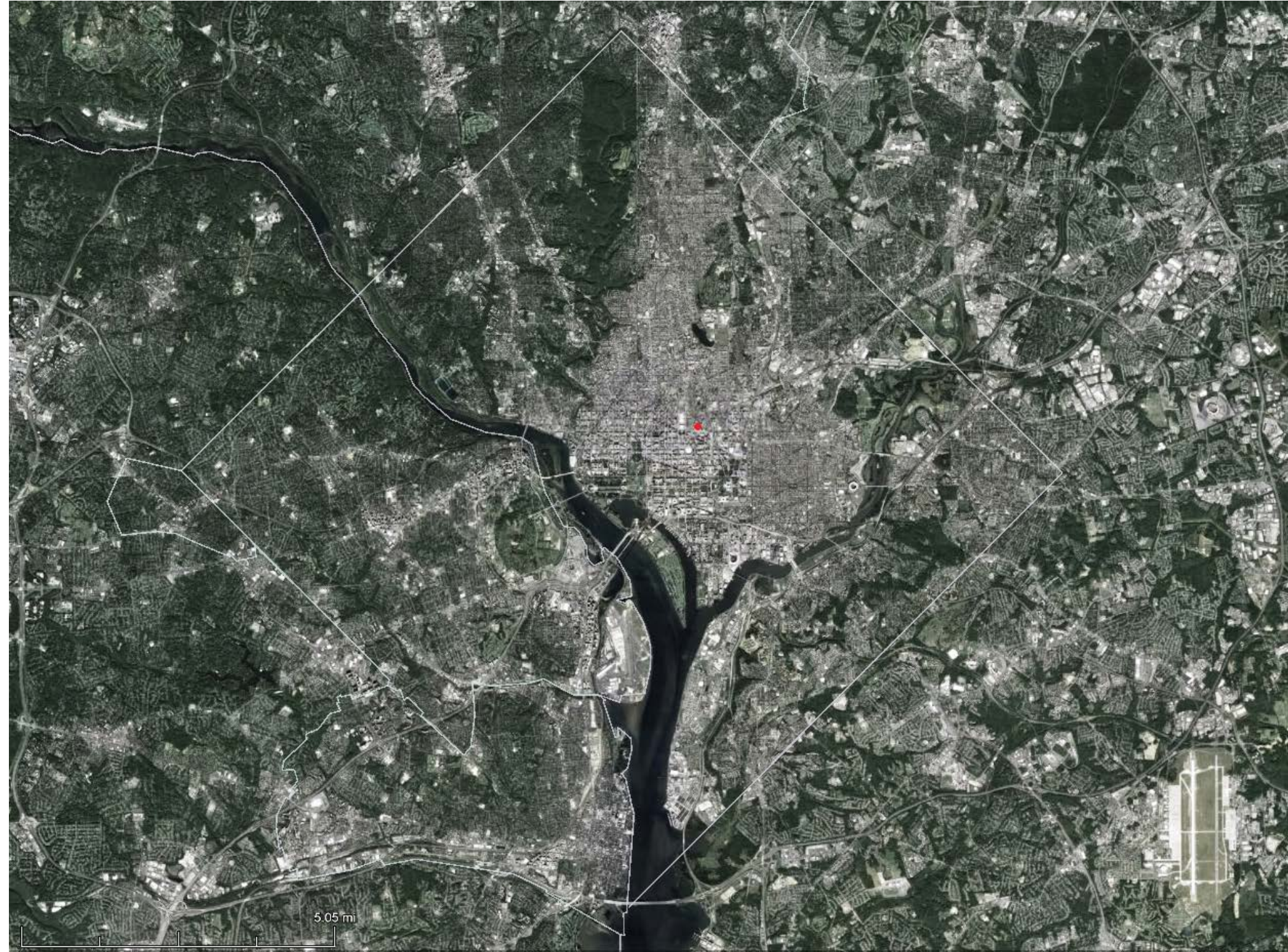

WASHINGTON DC, GOOGLE MAP OF SITE (PUBLIC DOMAIN)

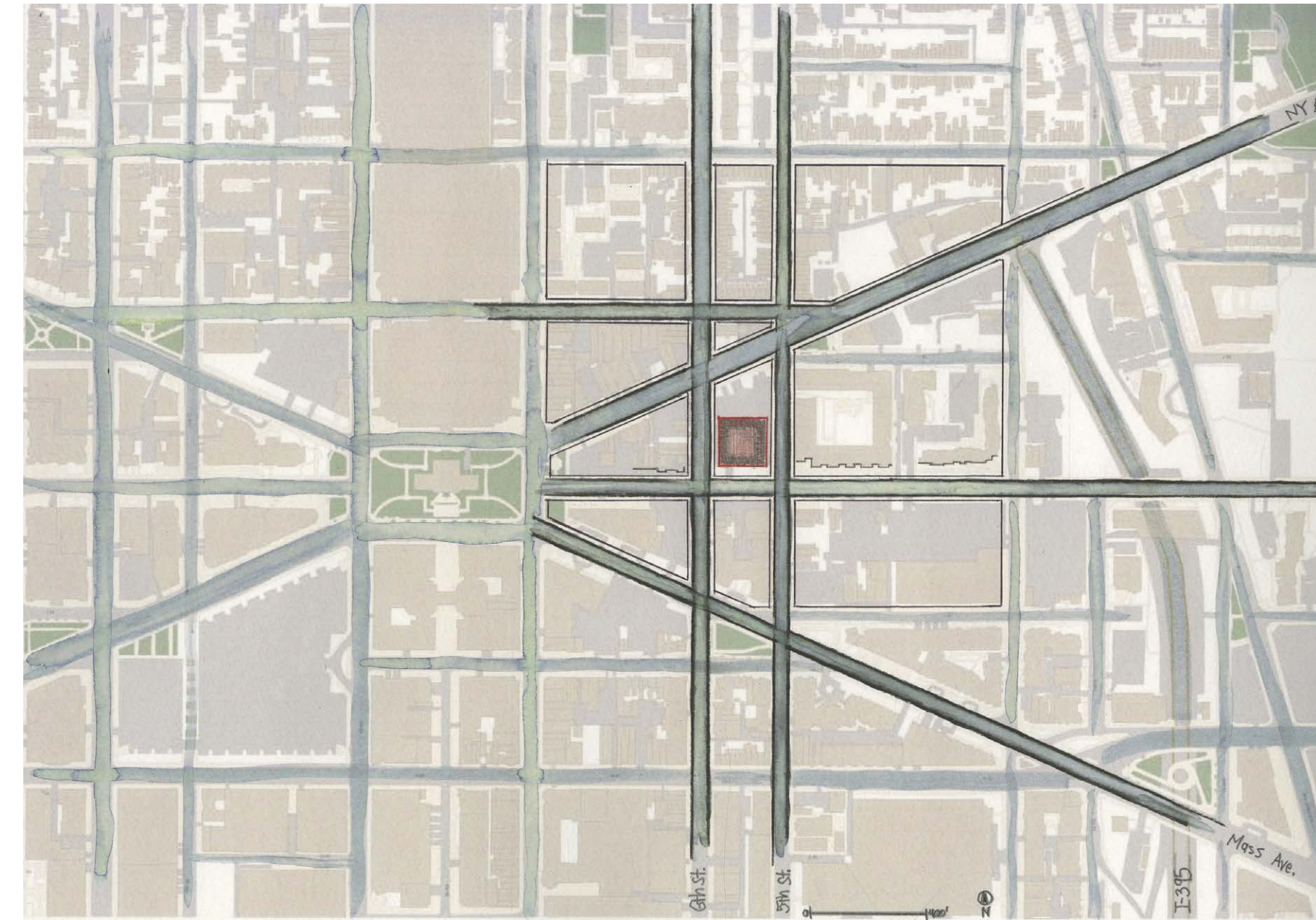

SITE PLAN 01, GIS MAP OF SITE (PUBLIC DOMAIN)

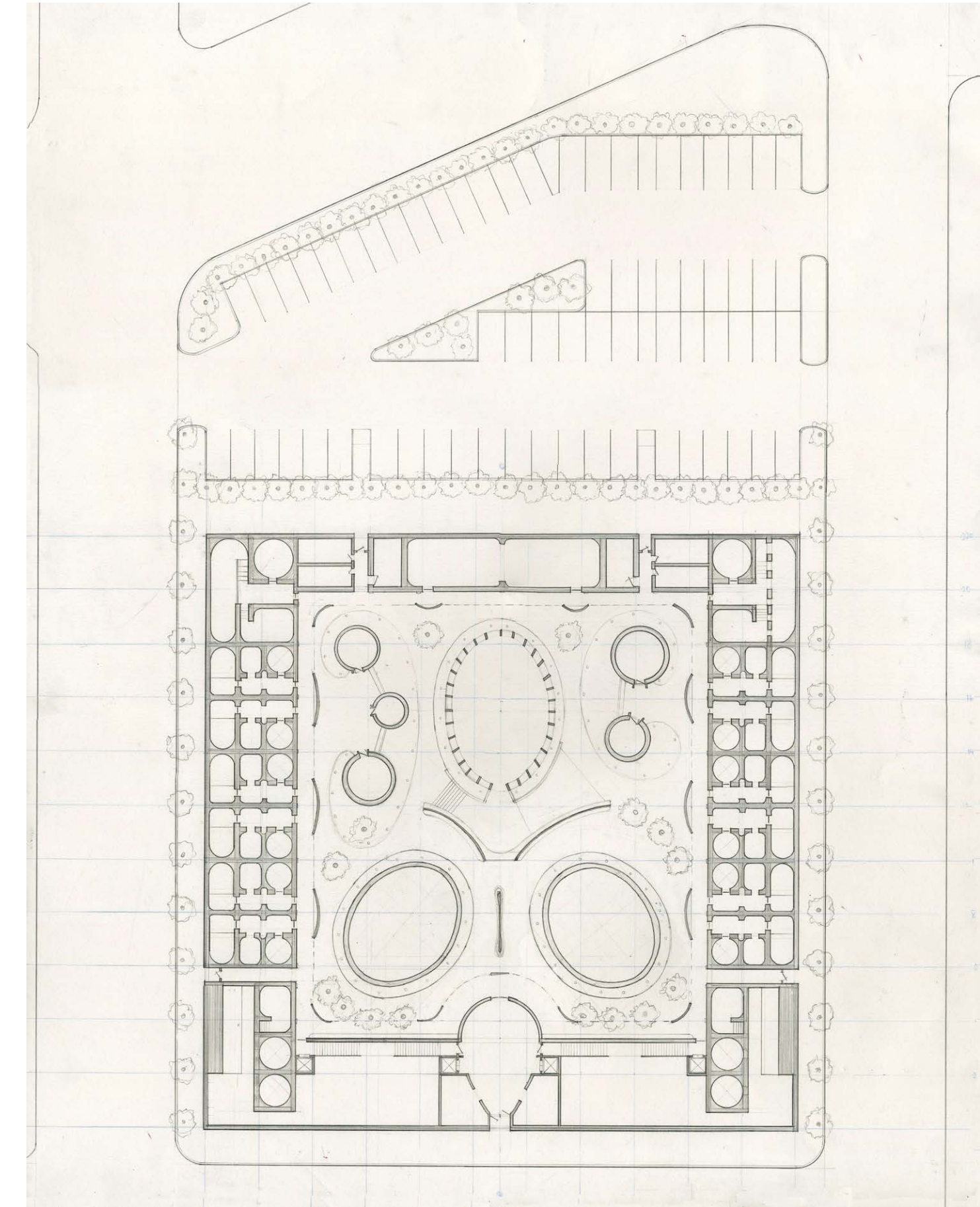

SITE PLAN 02

VIEW OF SITE



SOUTH VIEW



EAST VIEW



WEST VIEW



## ITS ELEMENTS

The program consists of two major parts: a thick perimeter wall that forms the boundary and a central courtyard garden that opens to the sky.

The architecture starts with a rectilinear concrete structure, which is the primary method of construction. Within this rigid framework, a curved surface resides. The rectilinear structure occurs at two scales – large and small. The large structure includes the entire perimeter wall, which defines the boundary for four sculptural forms – the entry lobby, two communal baths, and the café. These forms, contained within the central garden, are large in scale and continuous in form, providing a visual marvel for the visitor who strolls through. Surrounded by water and viewed as free-standing masses, these curvilinear forms are constructed with a framework of horizontal and vertical ribs.

Within each private unit, a series of secondary curved surfaces attaches to the structural concrete walls. Each of these rooms is constructed through either a panelized wall system of precast or a series of wood ribs arrayed in a radial pattern. The main activity within this space is sitting, so with consideration to the body's naked form, these intimate rooms emphasize smoothness of surface, inviting closer contact. The body presses against the curvature of the wall to mold itself a space, a perfect cove.

### SPHERE IN BOX

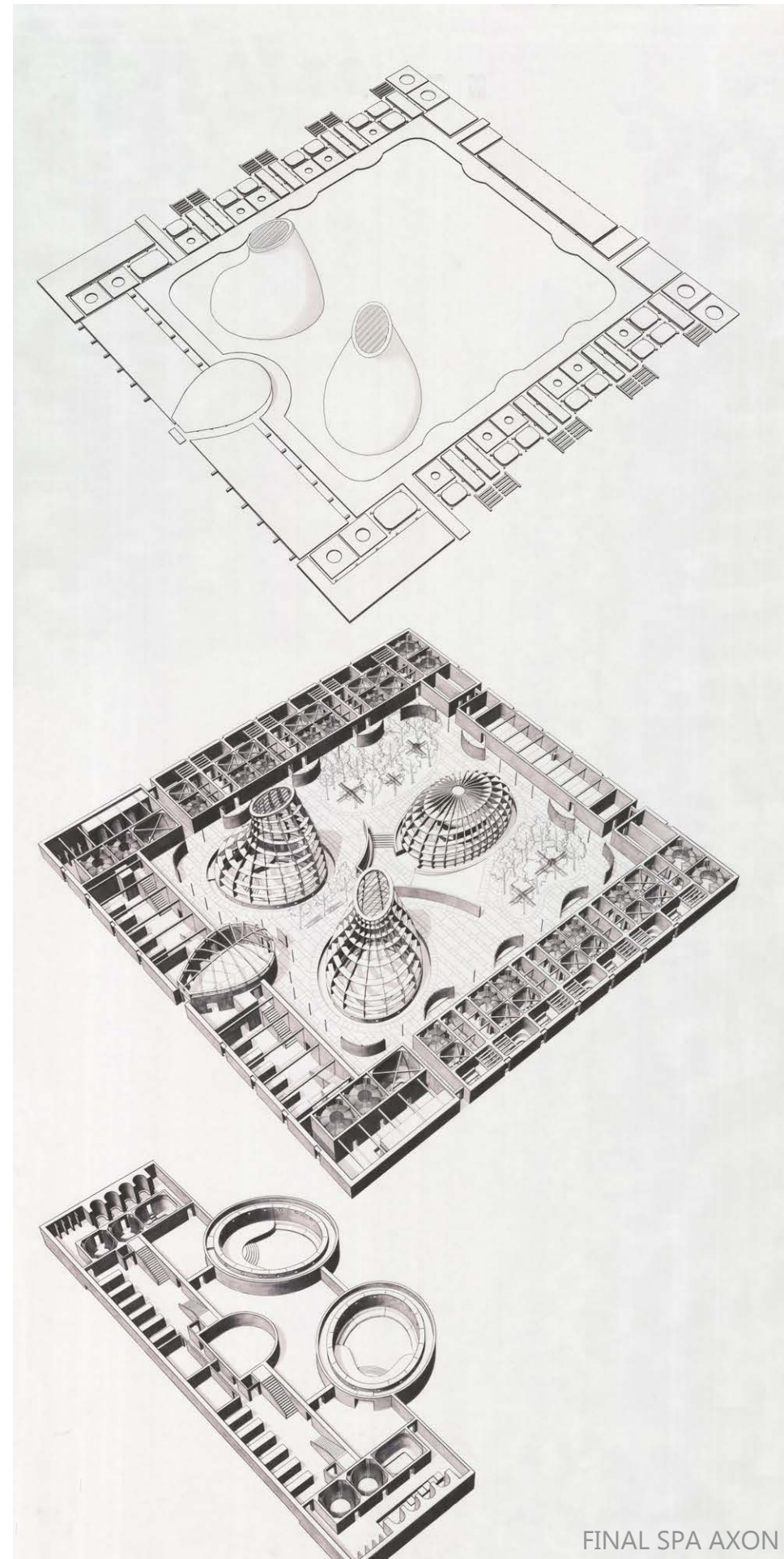
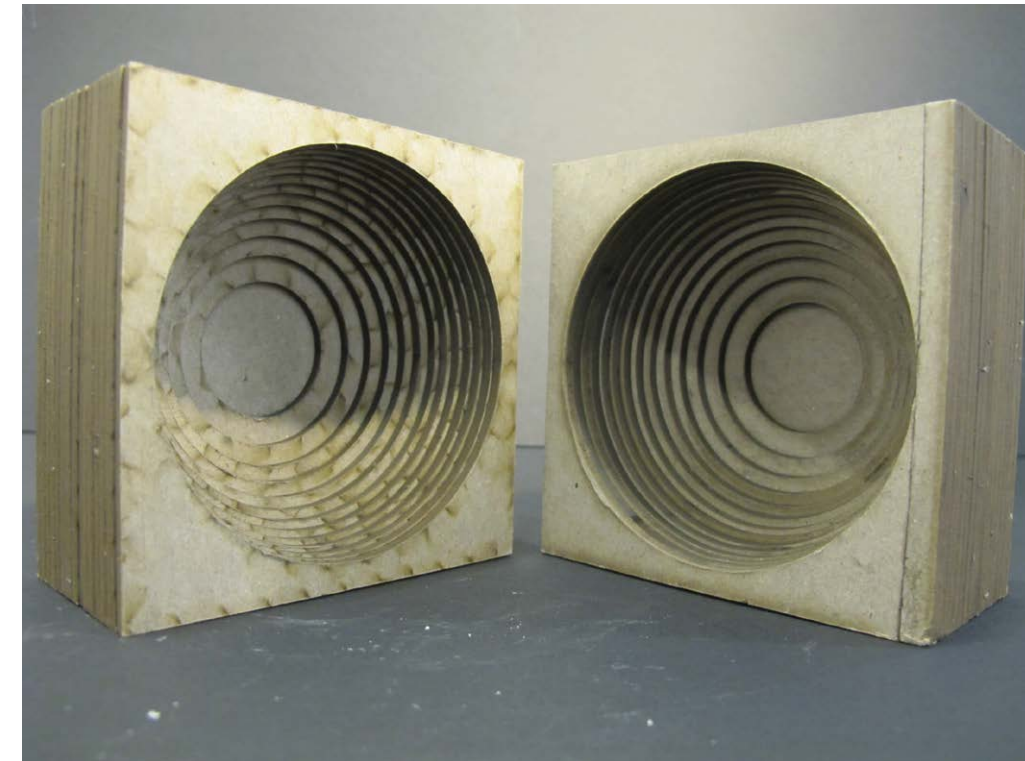

FINAL SPA AXON

### FINAL SPA PLAN

ENTRANCE LOBBY .....	01
WAITING ROOM .....	02
CHANGING ROOM .....	03
COMMUNAL BATH .....	04
COMMUNAL ROOMS .....	05
SMALL PRIVATE SPA UNIT .....	06
LARGE PRIVATE SPA UNIT .....	07
BATHROOMS .....	08
MECHANICAL ROOM .....	09
MASSAGE ROOM .....	10
CAFE .....	11
CAFE PATIO .....	12
A GROVE OF TREES, A PLACE TO SIT .....	13
EXIT .....	14

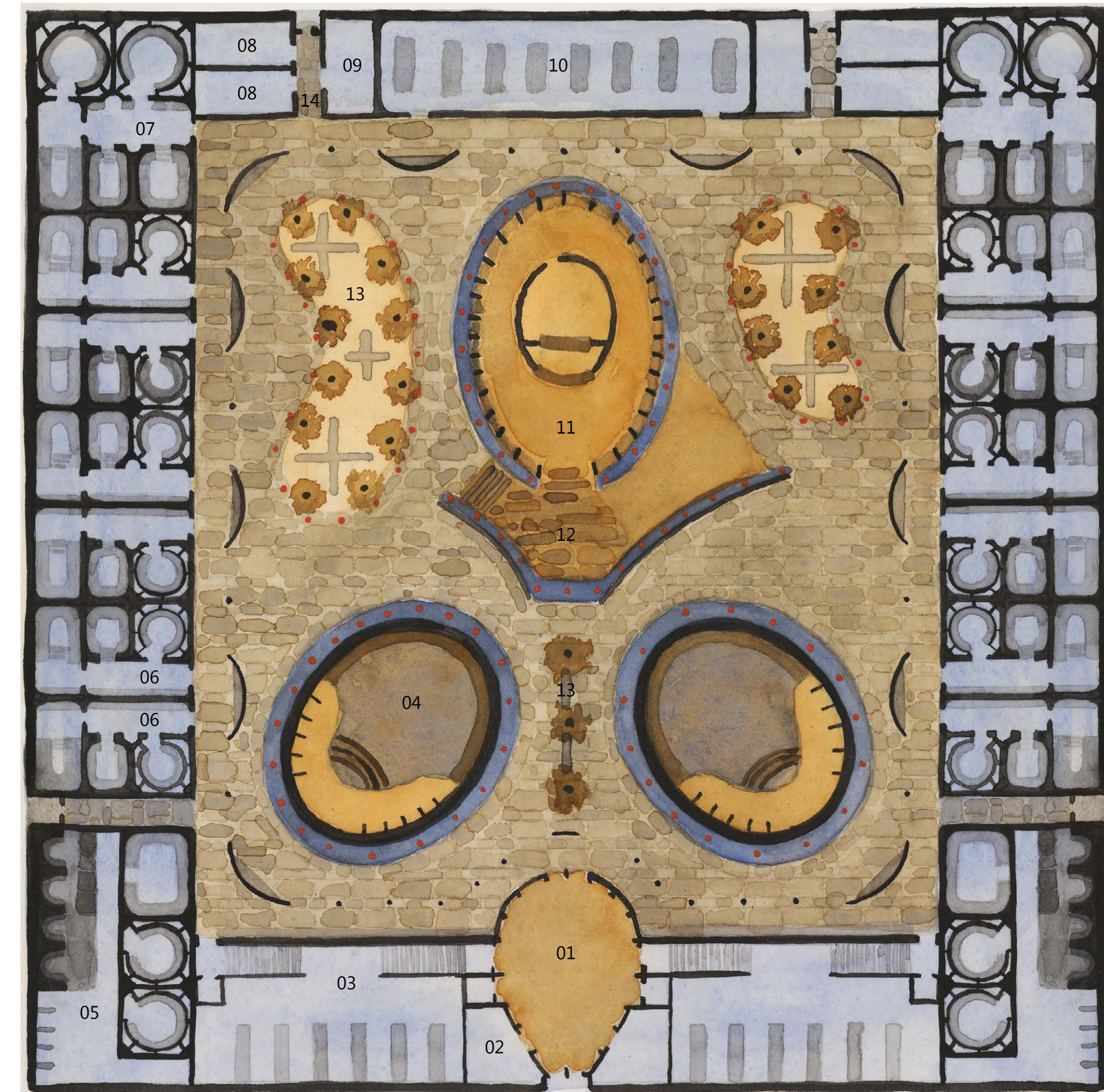

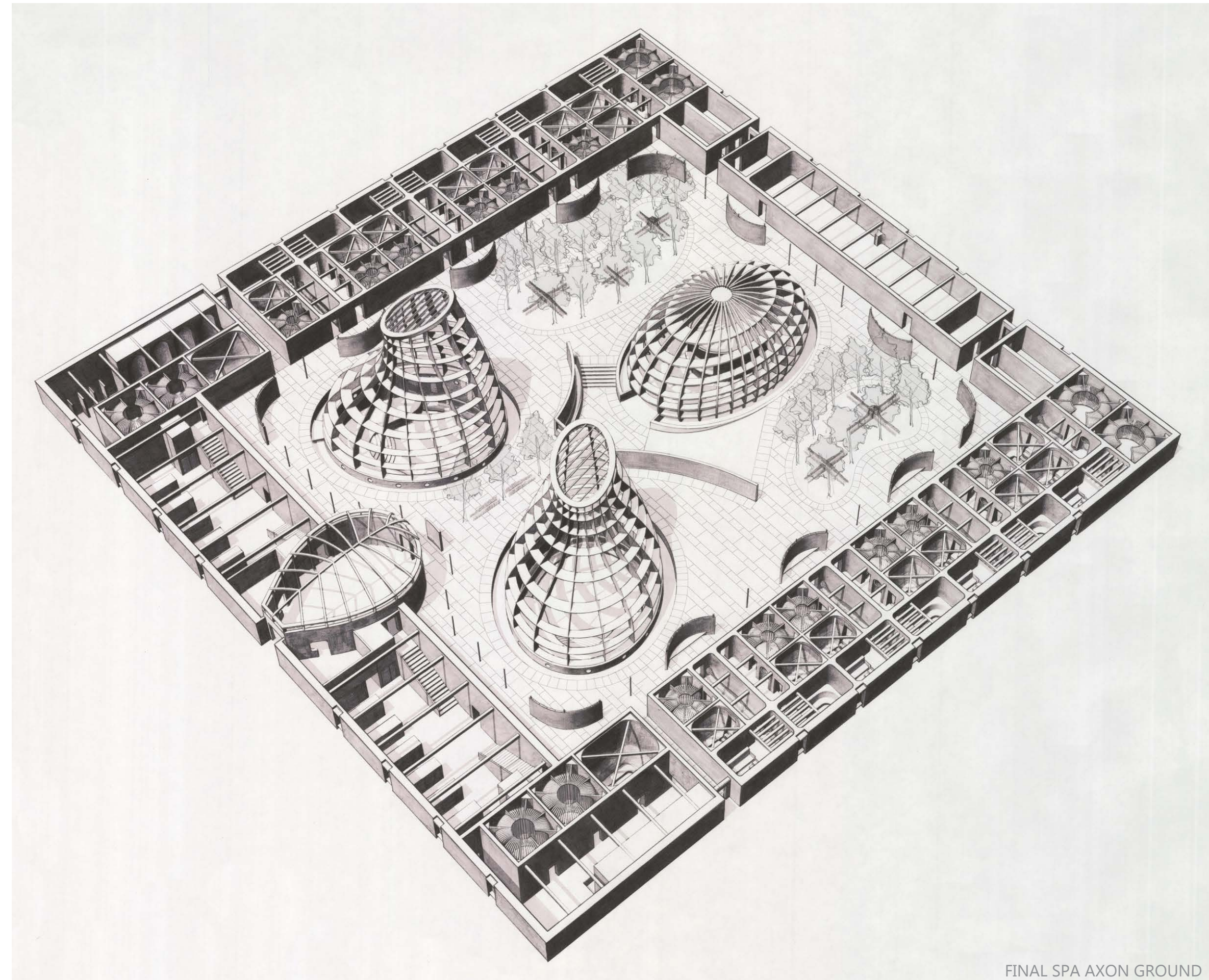

FINAL SPA AXON GROUND

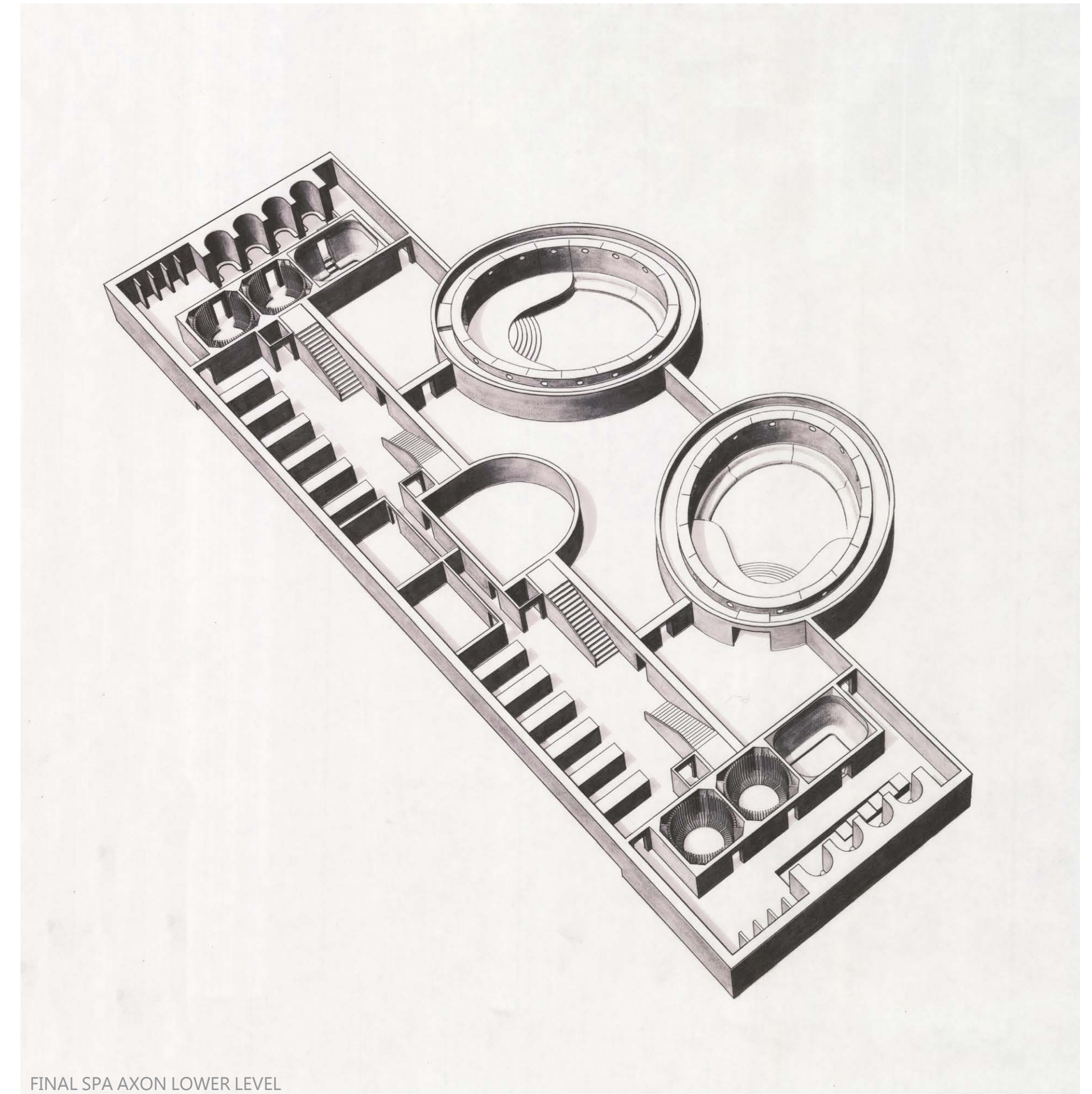

FINAL SPA AXON LOWER LEVEL

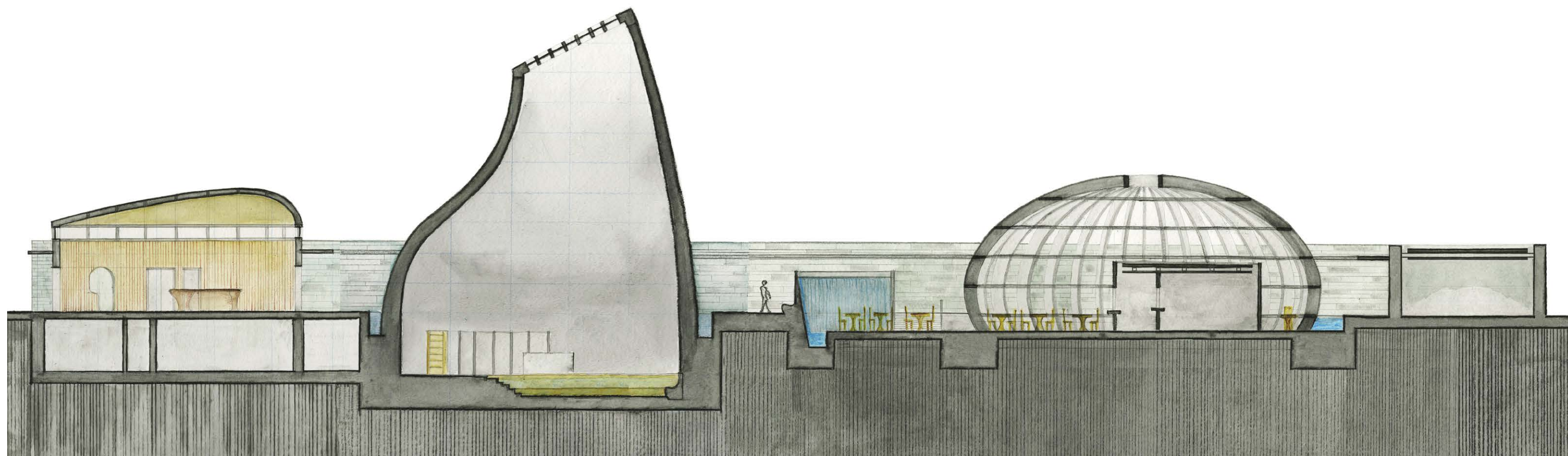

SECTION 01

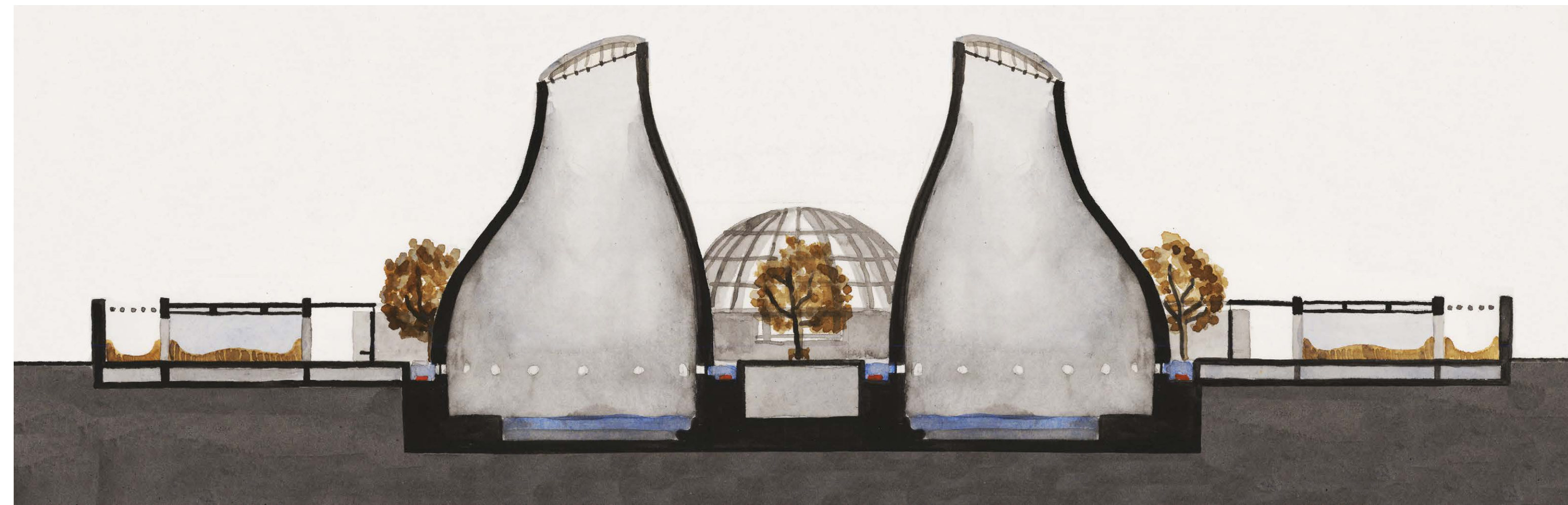

SECTION 02

The thick perimeter wall initiates the organization of the site. The exterior walls, lined with stone, act as a fortress and enclose all of the program within the boundary. No windows are present, preventing visibility of interior activities from the street. The wall, however, interacts with the public by providing coves, every 20', allowing the passerby to sit and rest before strolling along. Light enters these spaces from an edge, spot, or filtered condition of the roof.

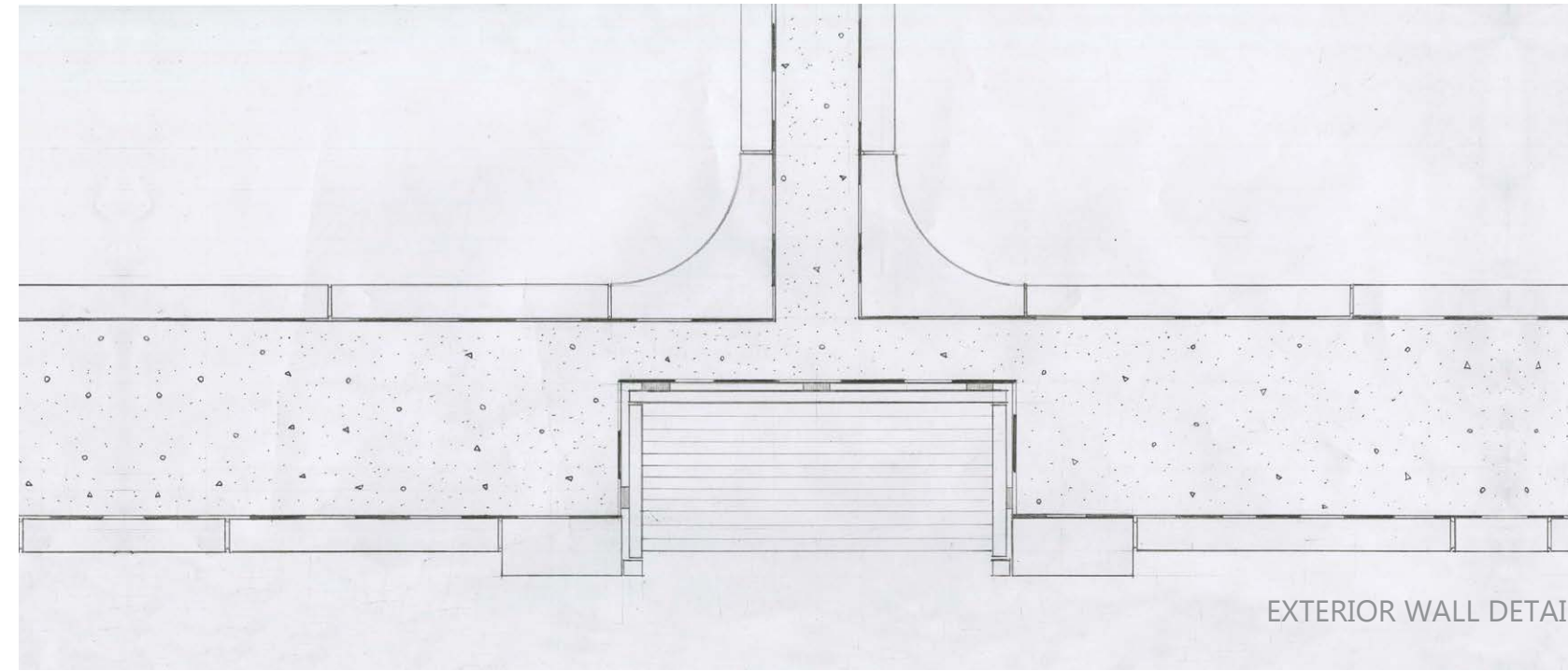

EXTERIOR WALL DETAIL



EXTERIOR ELEVATION



INTERIOR ELEVATION

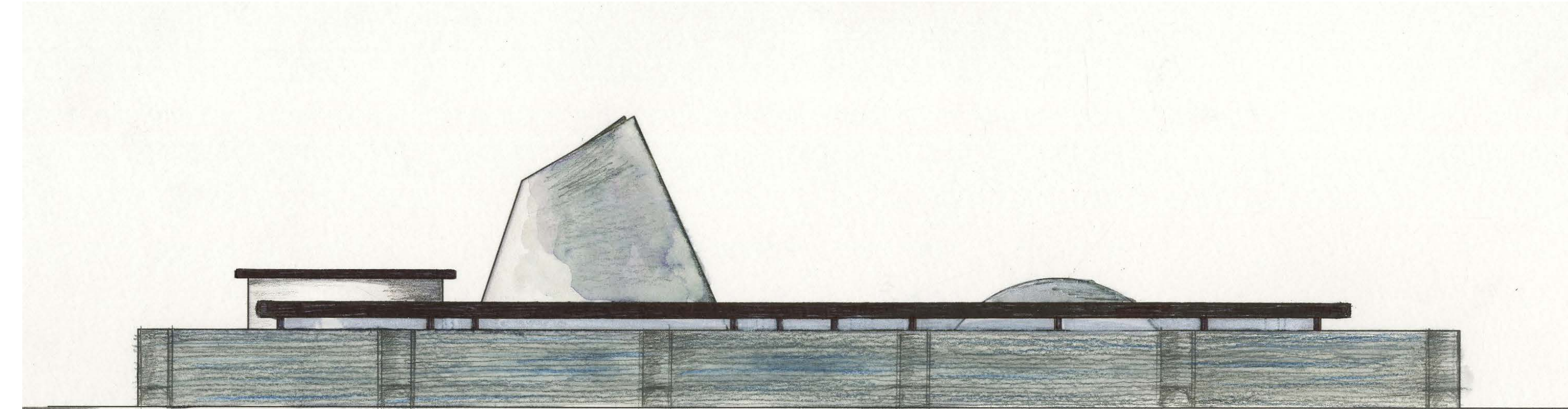

SIDE ELEVATION CONCEPT

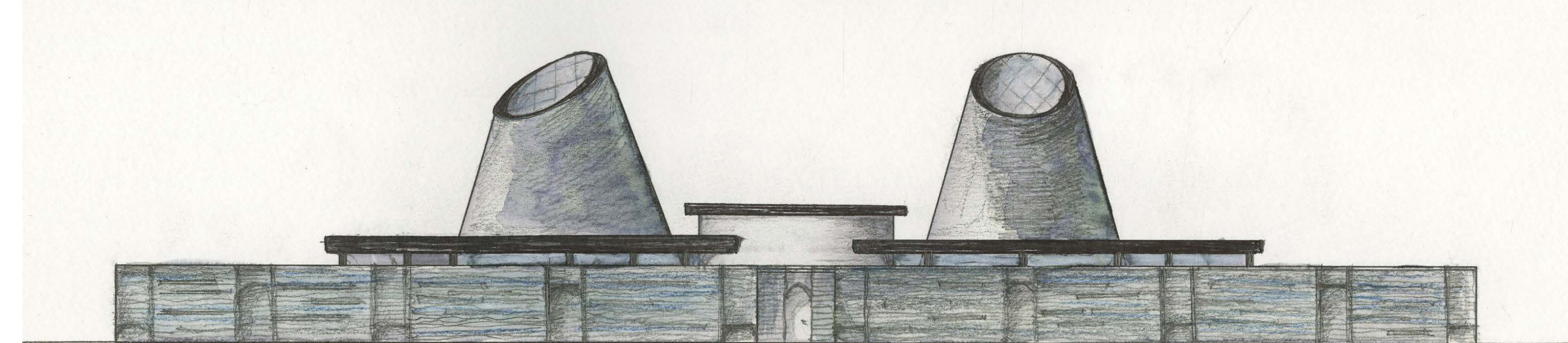

FRONT ELEVATION CONCEPT

ENTRY LOBBY PLAN

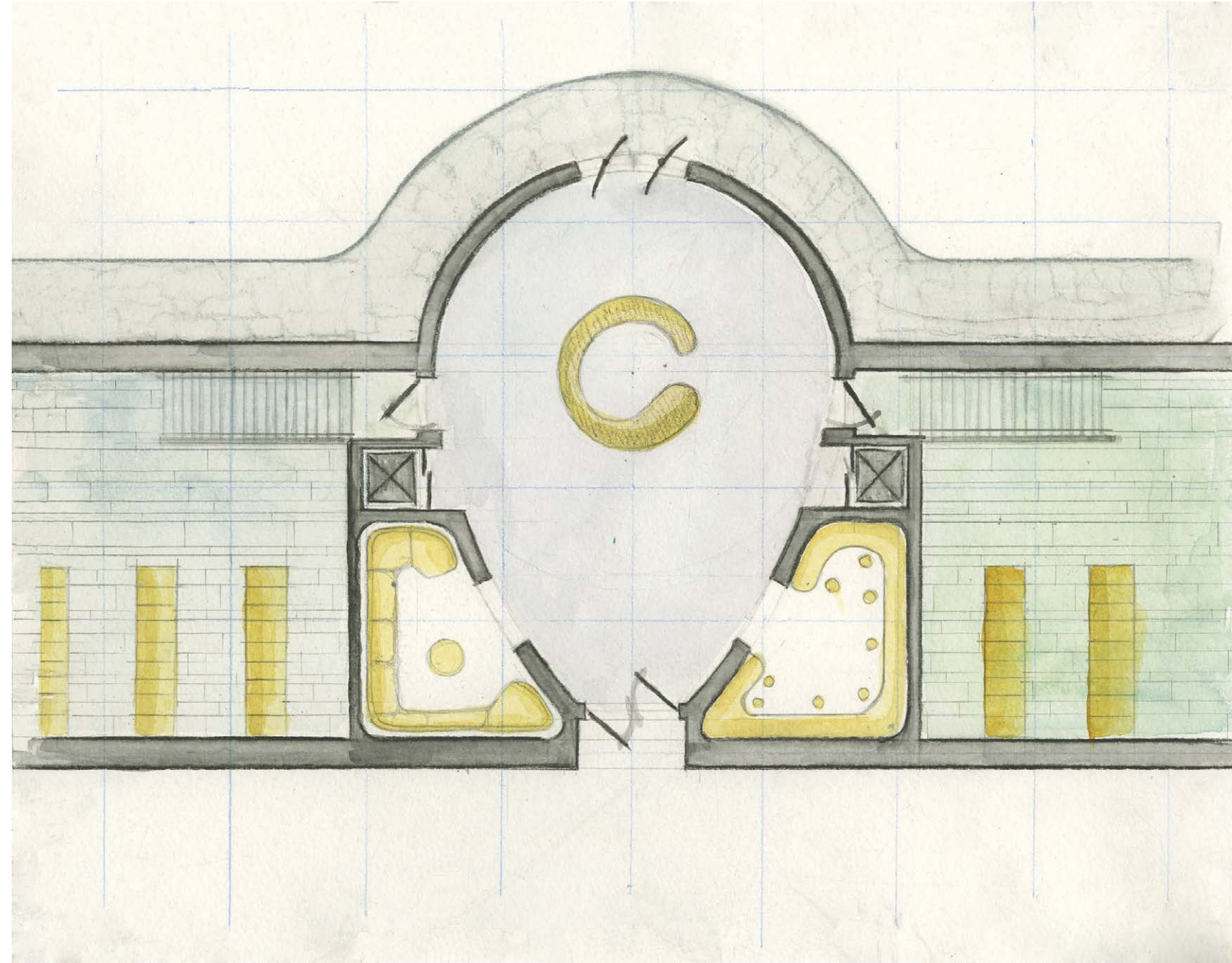

ENTRY LOBBY AXON

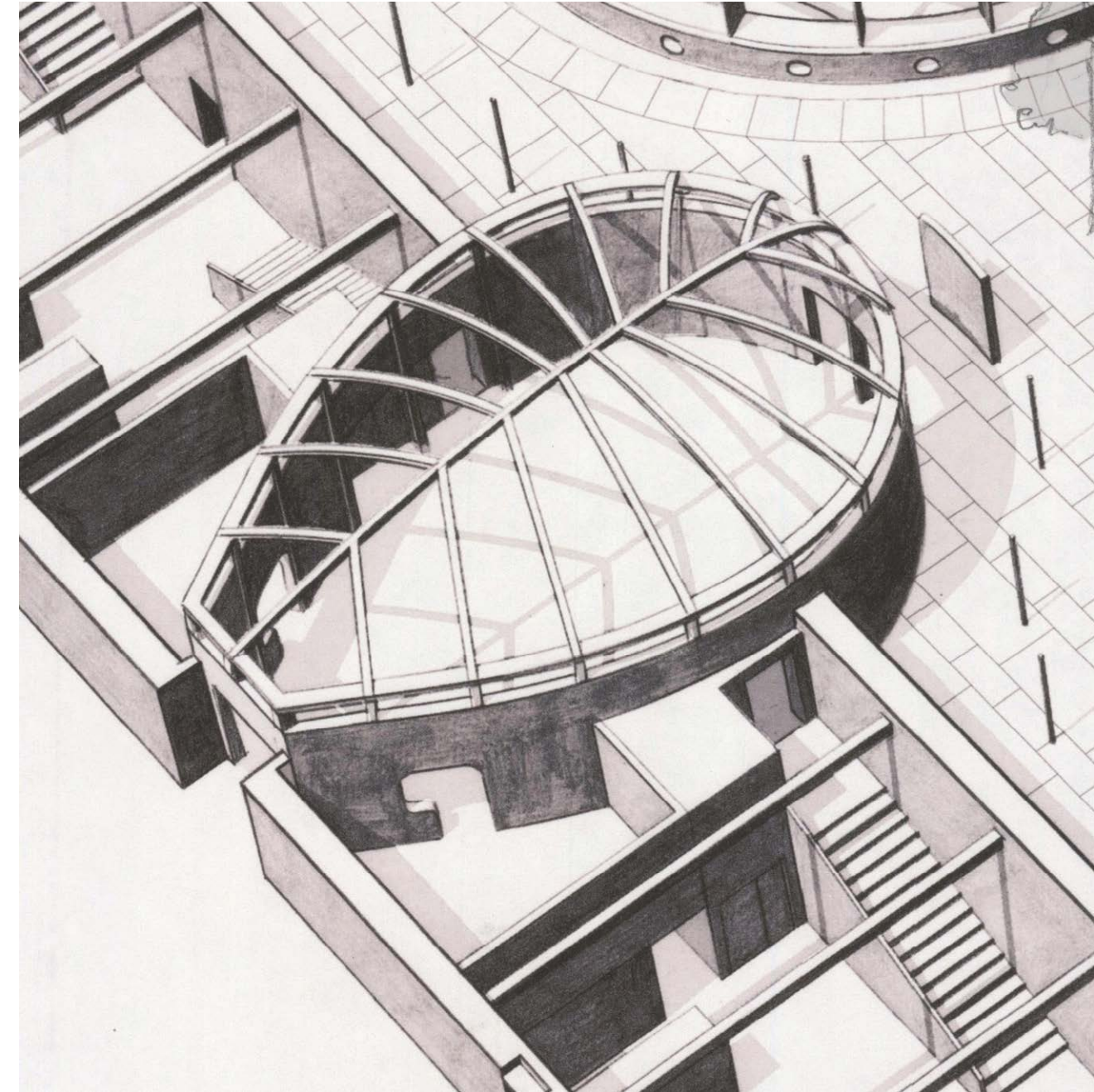

The entry lobby is nested within the perimeter wall, but its roof, constructed like a wooden boat hull, rises above the wall to declare its presence. Light filters through the clerestory windows. From the lobby, the visitor has access to the changing rooms, the courtyard garden, or the waiting rooms.

ENTRY LOBBY PERSPECTIVE





CHANGING ROOM PLAN

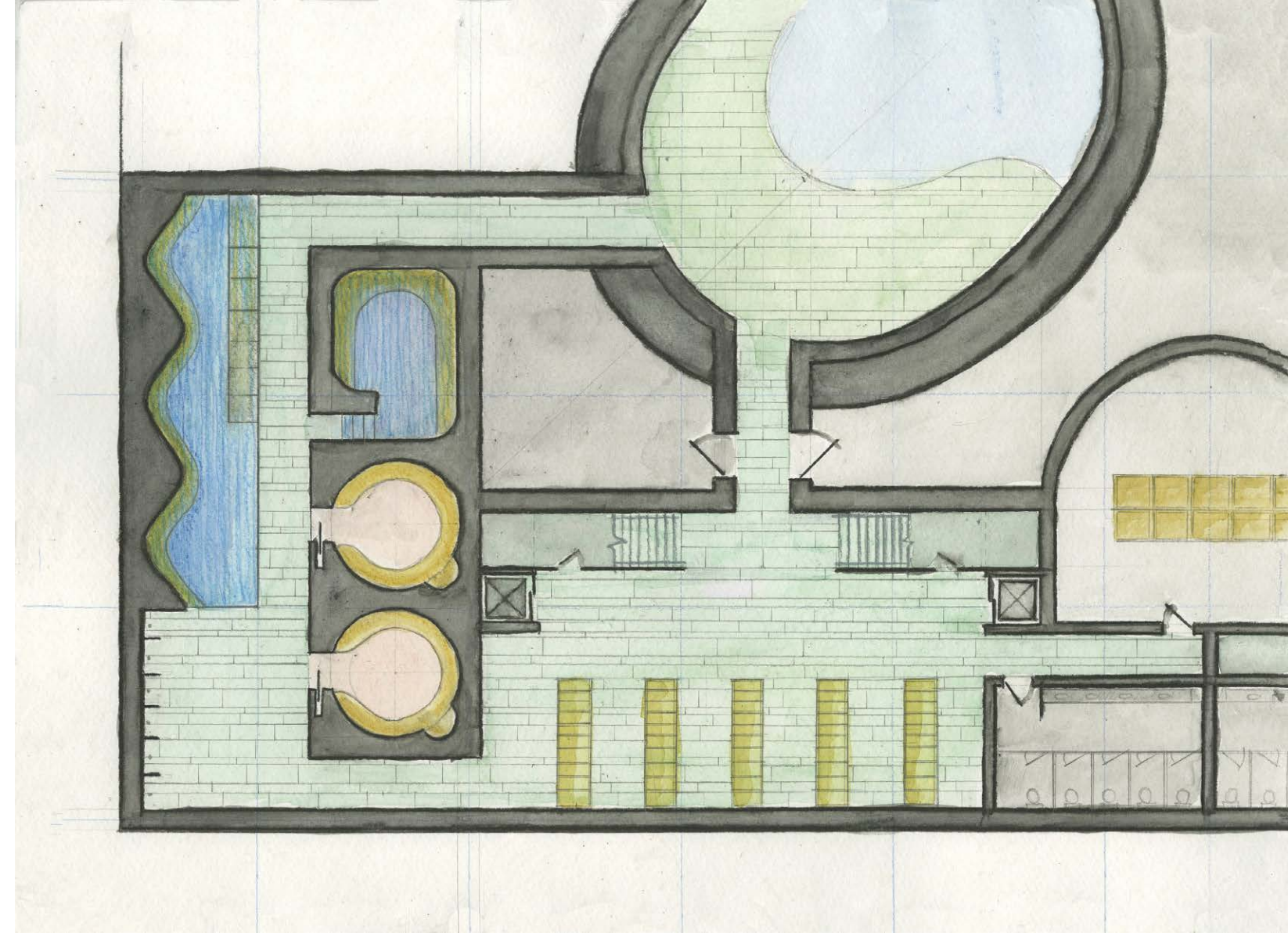

CHANGING ROOM AXON

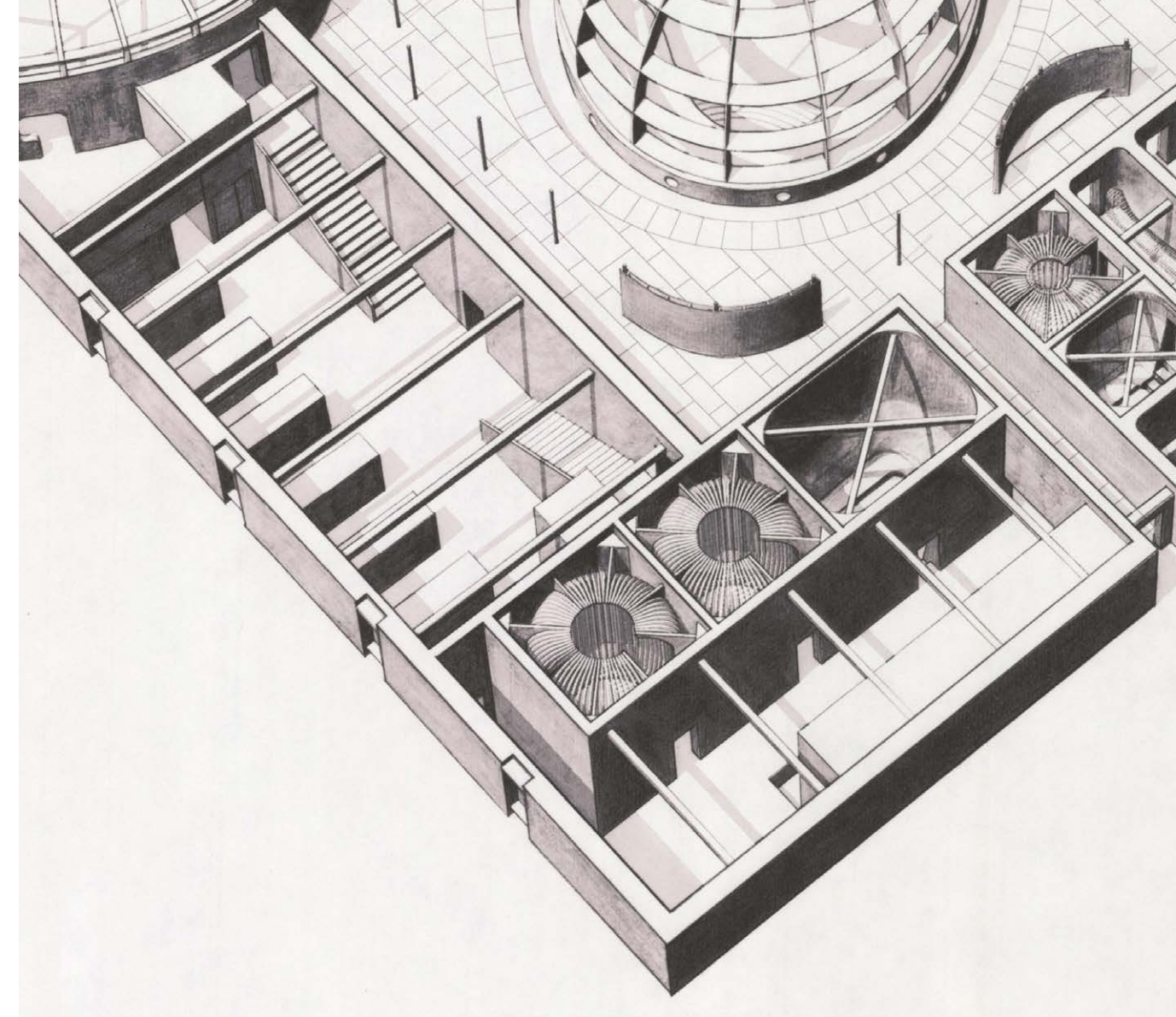

COMMUNAL ROOM PERSPECTIVE

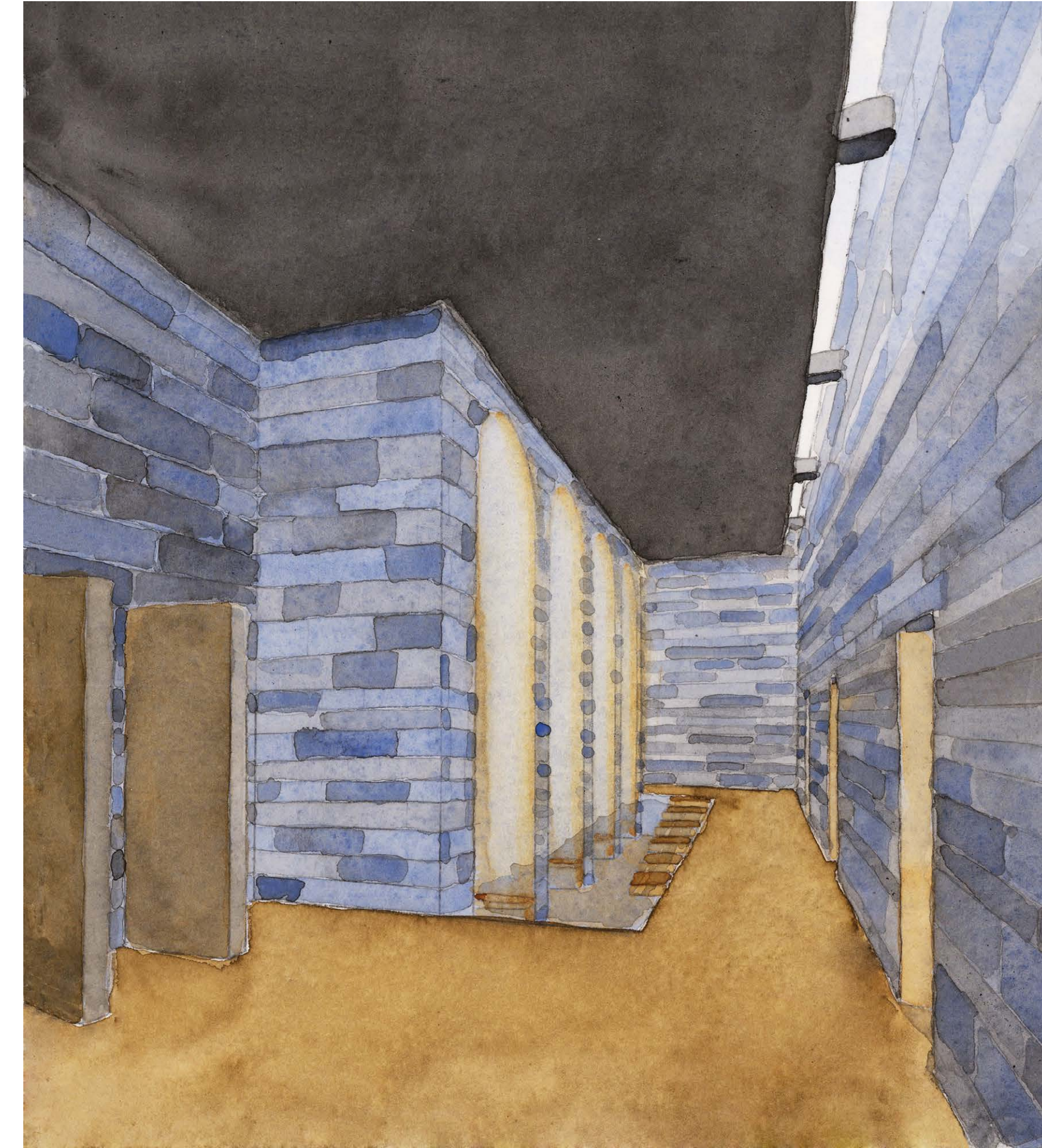

COMMUNAL BATH PLAN

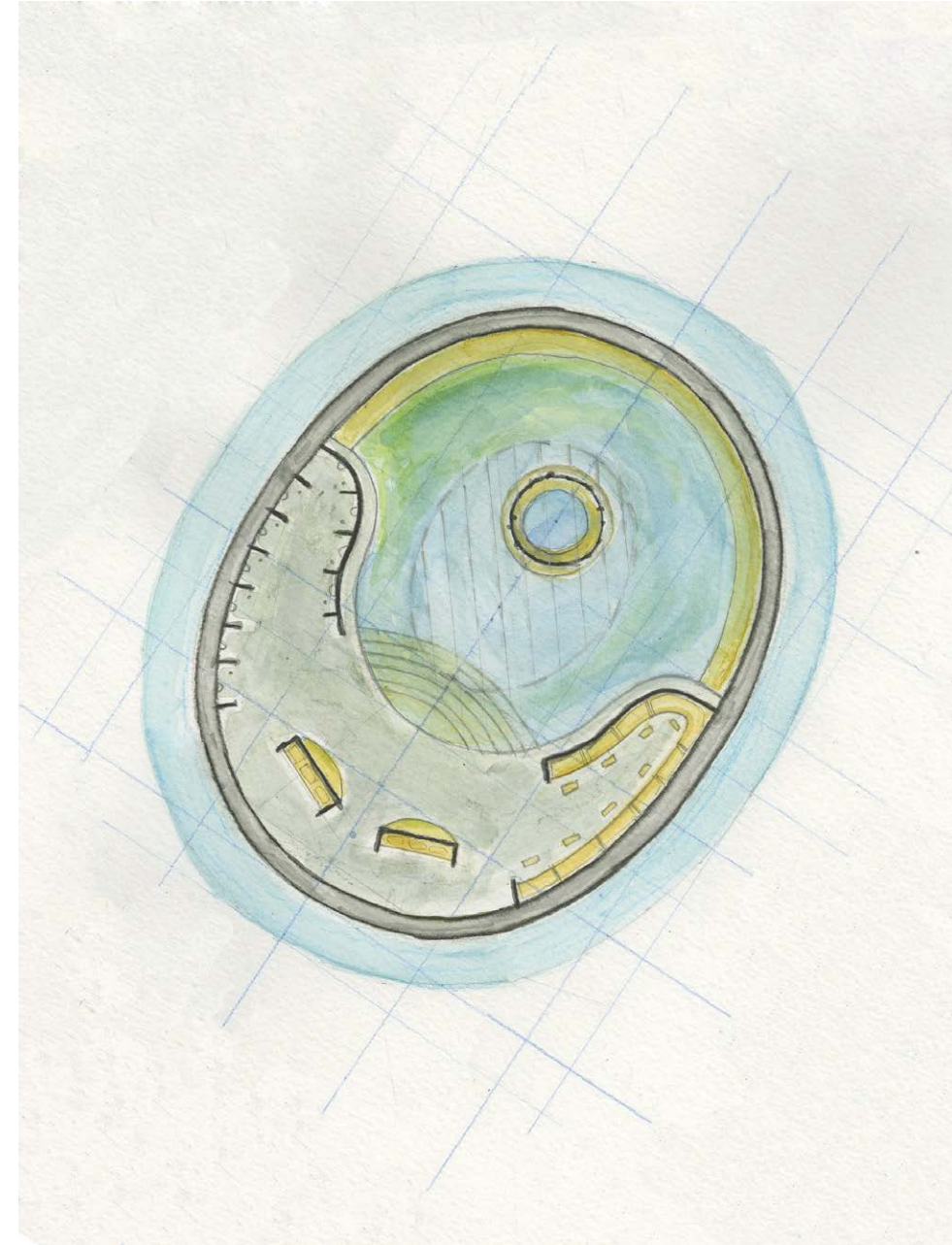

COMMUNAL BATH AXON

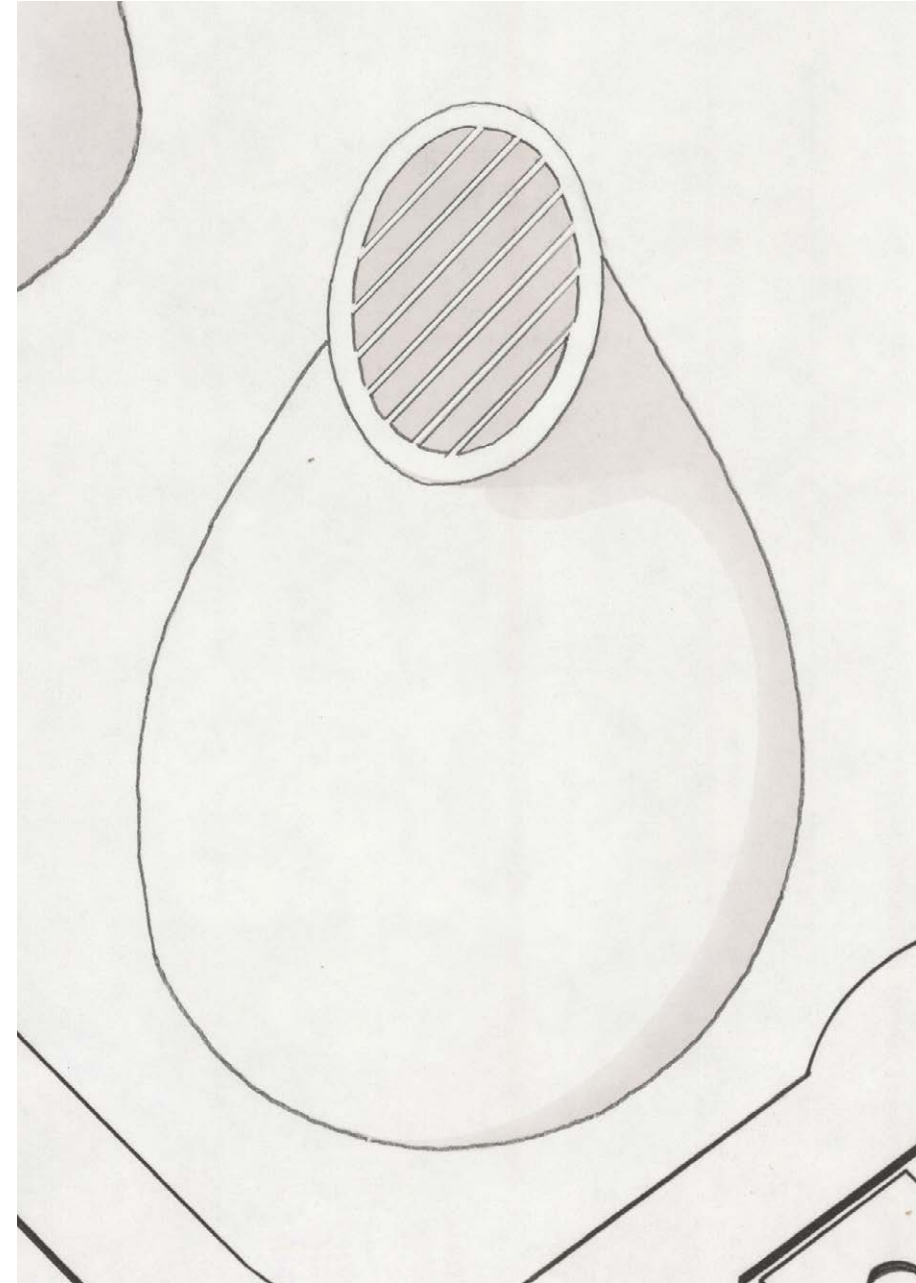
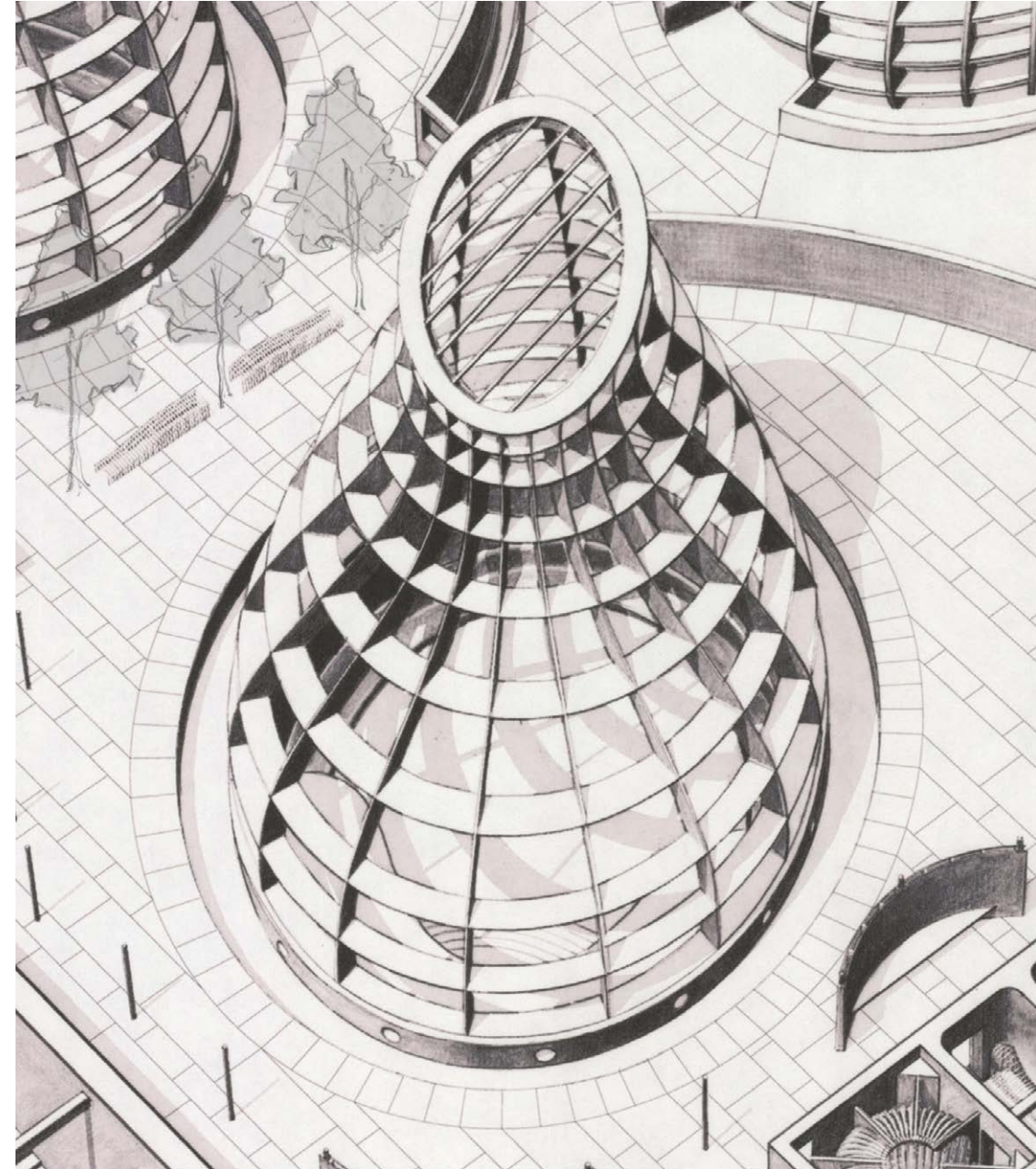

COMMUNAL BATH STRUCTURE



"Volume is defined as soft, flexible surface of curves rather than as a fixed set of rigid points." -Greg Lynn, *Animate Form*

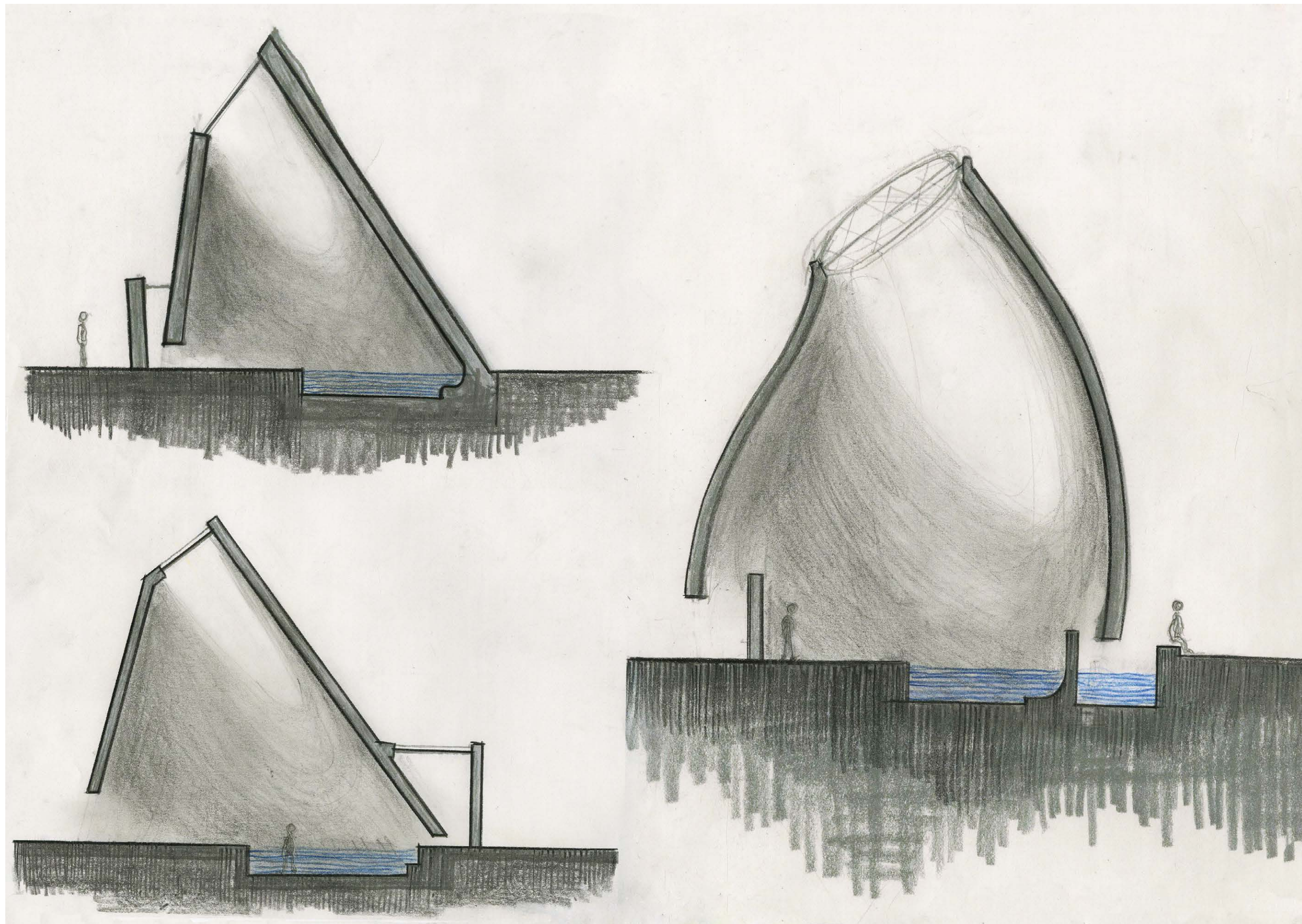

COMMUNAL BATH  
CONCEPT SKETCH



COMMUNAL BATH  
PERSPECTIVE

CAFE PLAN

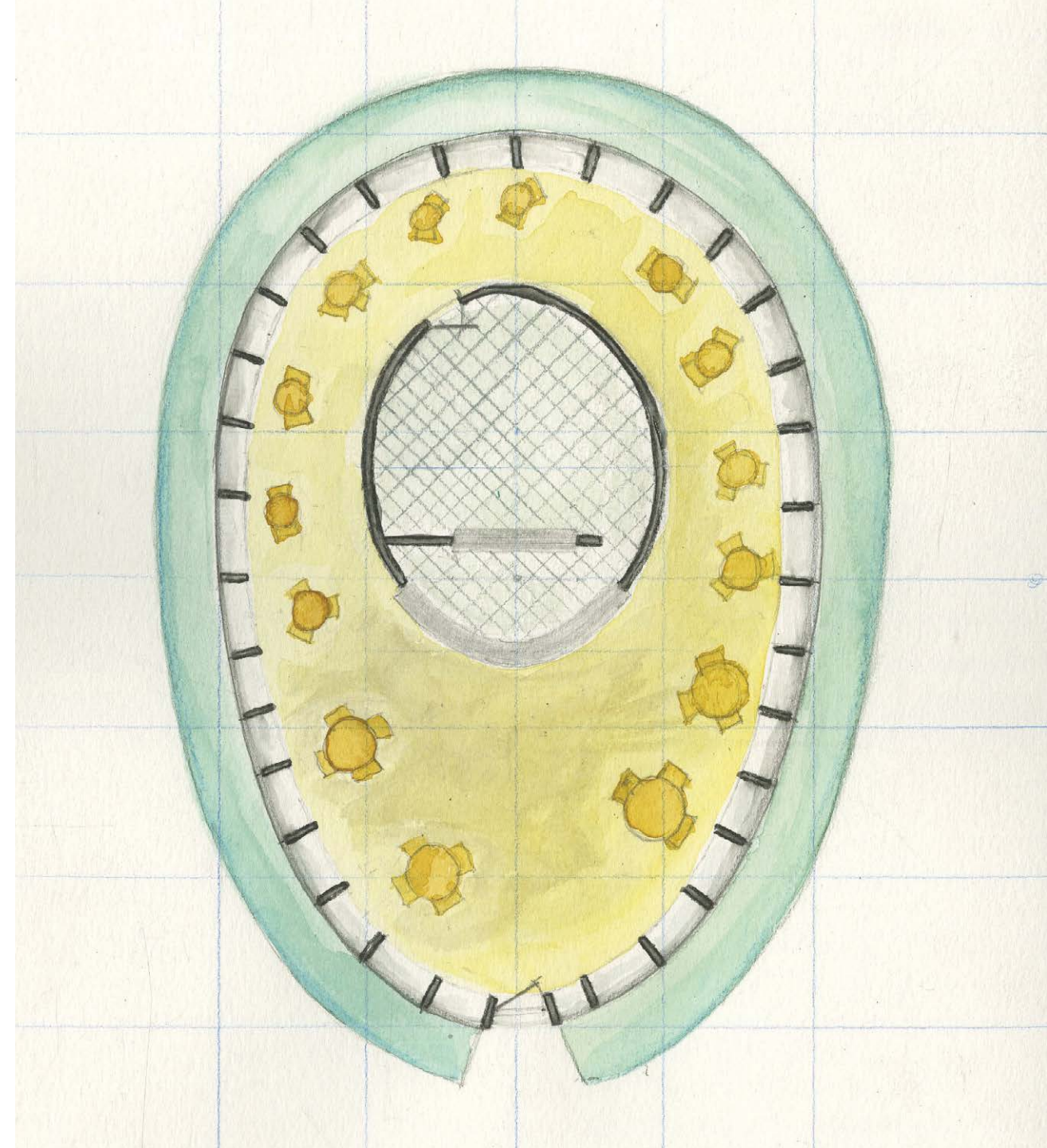

CAFE AXON

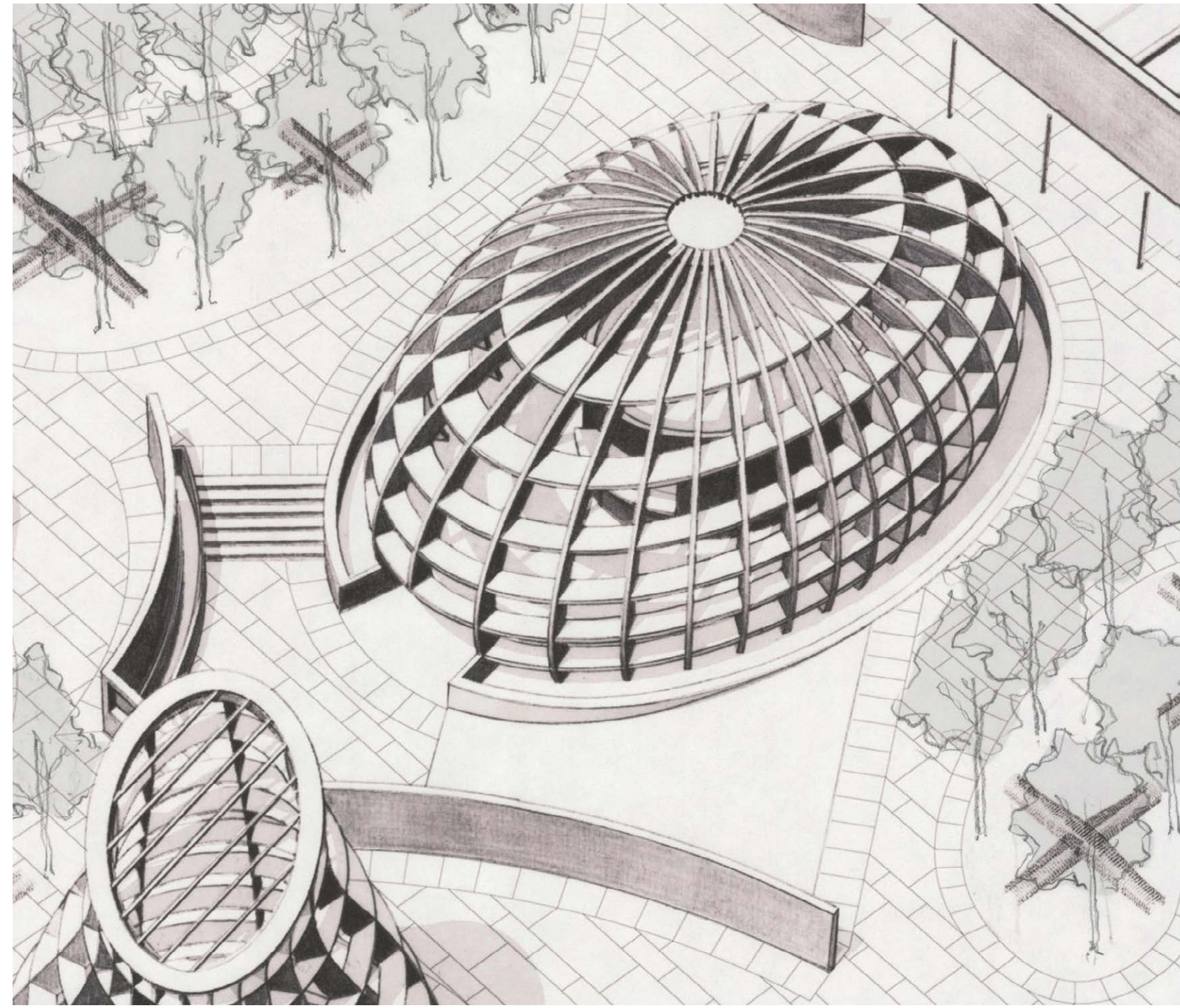

CAFE PERSPECTIVE



SMALL PRIVATE SPA UNIT CONCEPT PLAN

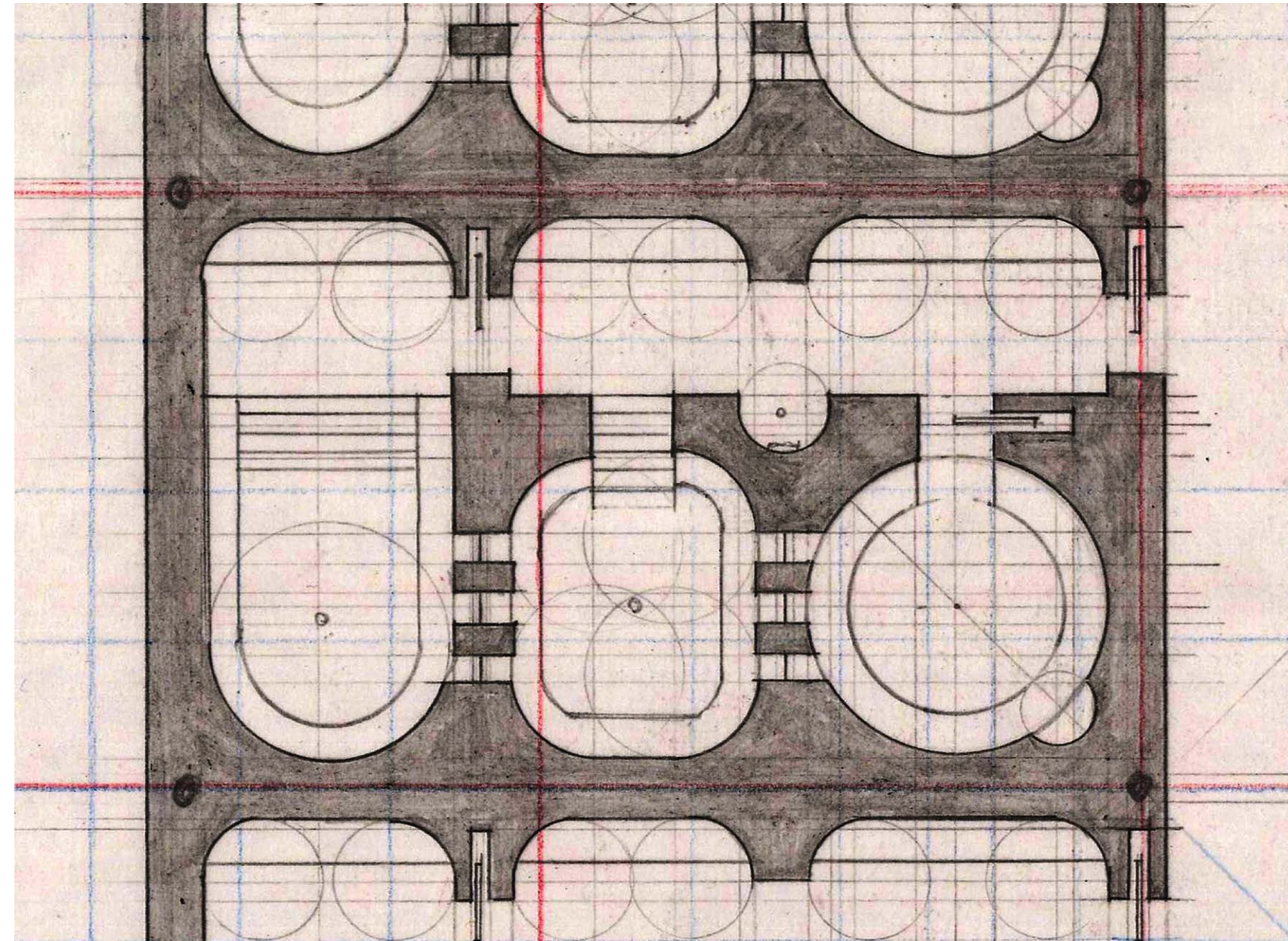

SMALL PRIVATE SPA UNIT AXON

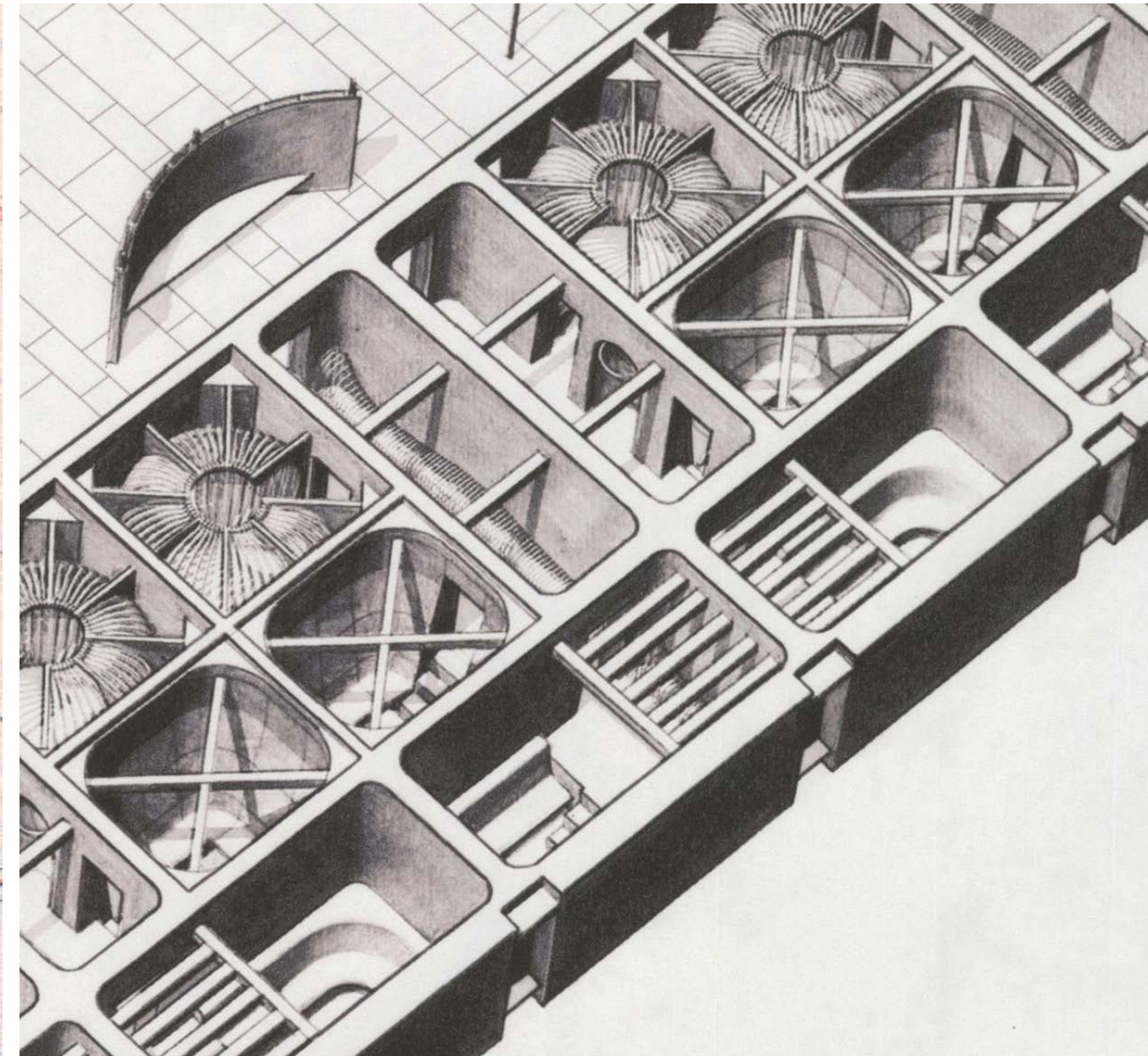

The dark hallway is lined with sinuous benches as light peers through from an edge condition. The floor and benches are heated from underneath. The wall contains a cove with a shower ring. The steam room is built out of a series of wood profiles, arranged in a radial pattern, creating a spherical space within the square framework. The profile of the seat, the wall, and the ceiling is one continuous element. Together, the space wraps the body in warmth. Light falls from a spot in the roof. Heat and interior lighting radiate from the edge of the room, from the void space between the concrete frame and the spherical surface. The hot bath is constructed out of a series of precast panels integrating the seat and the wall. The walls slope upward and outward at a slight angle towards an edge light condition. The roof, held away from the edges, shines a glimmer of light down a sloping surface. The ceiling is lined with wood ribs that give an element of warmth as steam rises from the hot bath. The ice bath is located outdoors. The outdoor hallway is also lined with a sinuous heated bench and offers a filtered light condition from the repetition in wood beam elements above. The ice bath, lined with precast seating is open to the sky.

SMALL PRIVATE SPA UNIT FINAL PLAN

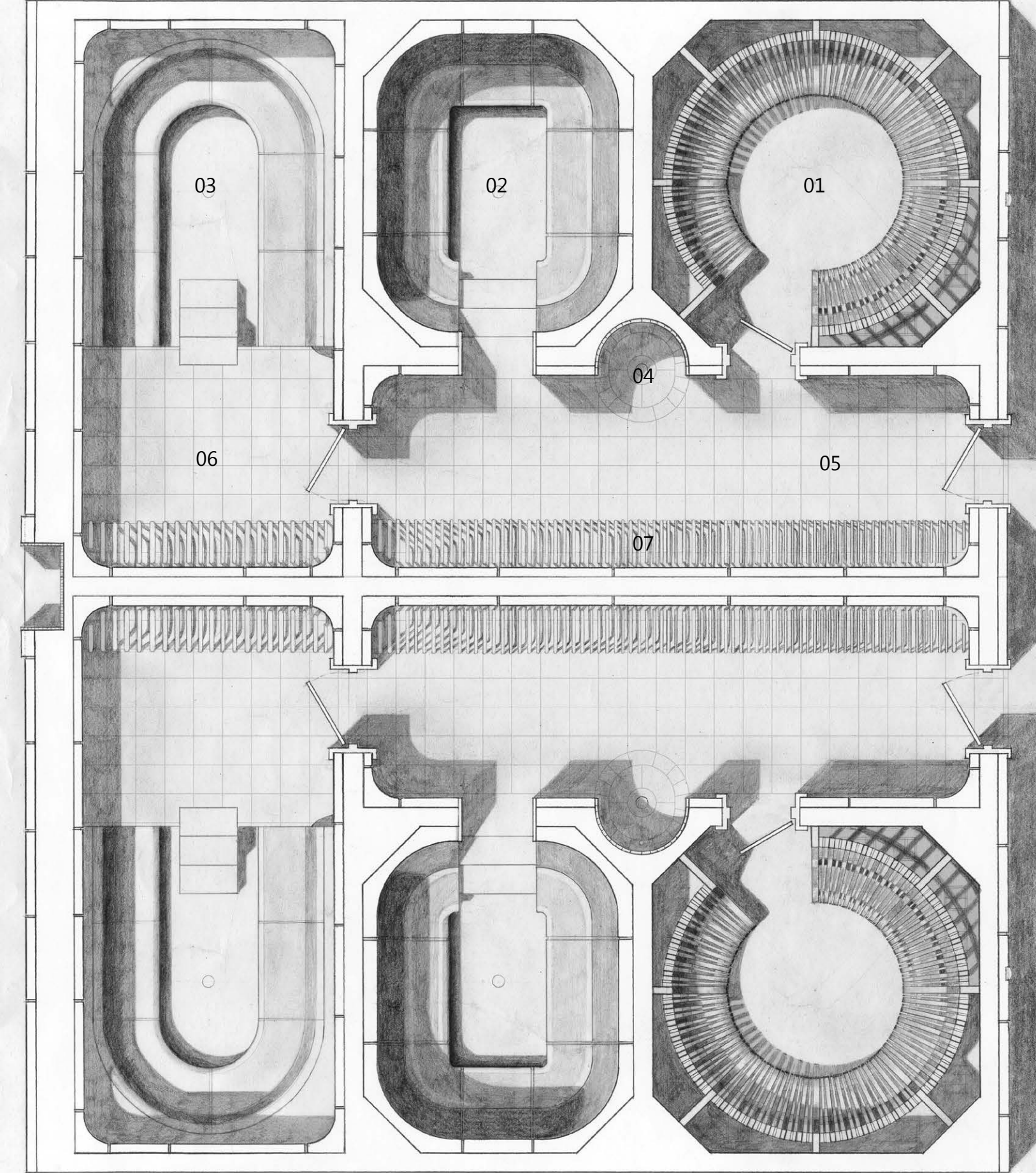

SMALL PRIVATE SPA UNIT EXTERIOR AXON

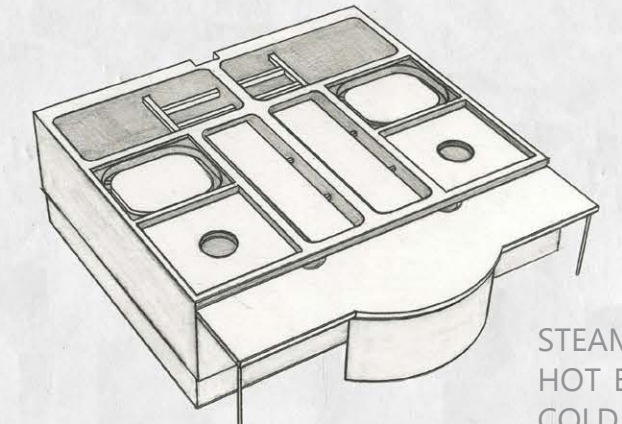
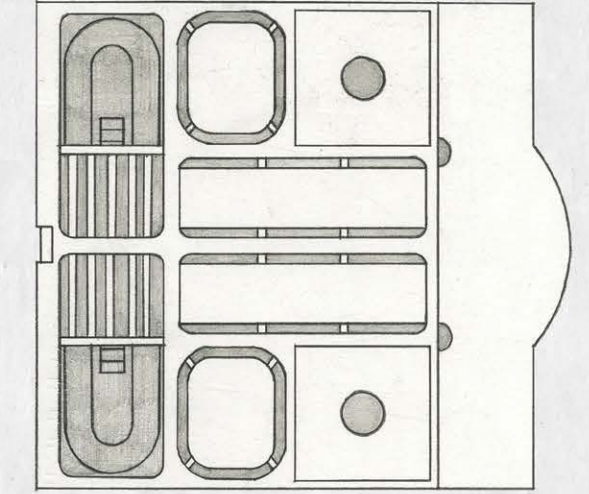

- STEAM ROOM . . . . . 01
- HOT BATH . . . . . 02
- COLD BATH . . . . . 03
- SHOWER . . . . . 04
- INDOOR HALLWAY . . . . . 05
- OUTDOOR HALLWAY . . . . . 06
- SINUOUS BENCH . . . . . 07
- COVERED WALKWAY . . . . . 08
- COVE SEATING . . . . . 09

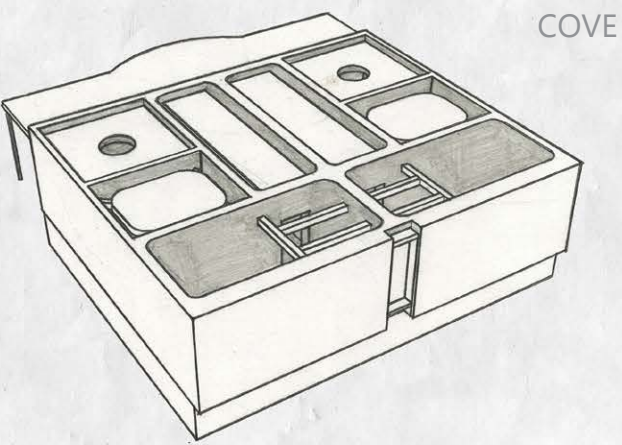

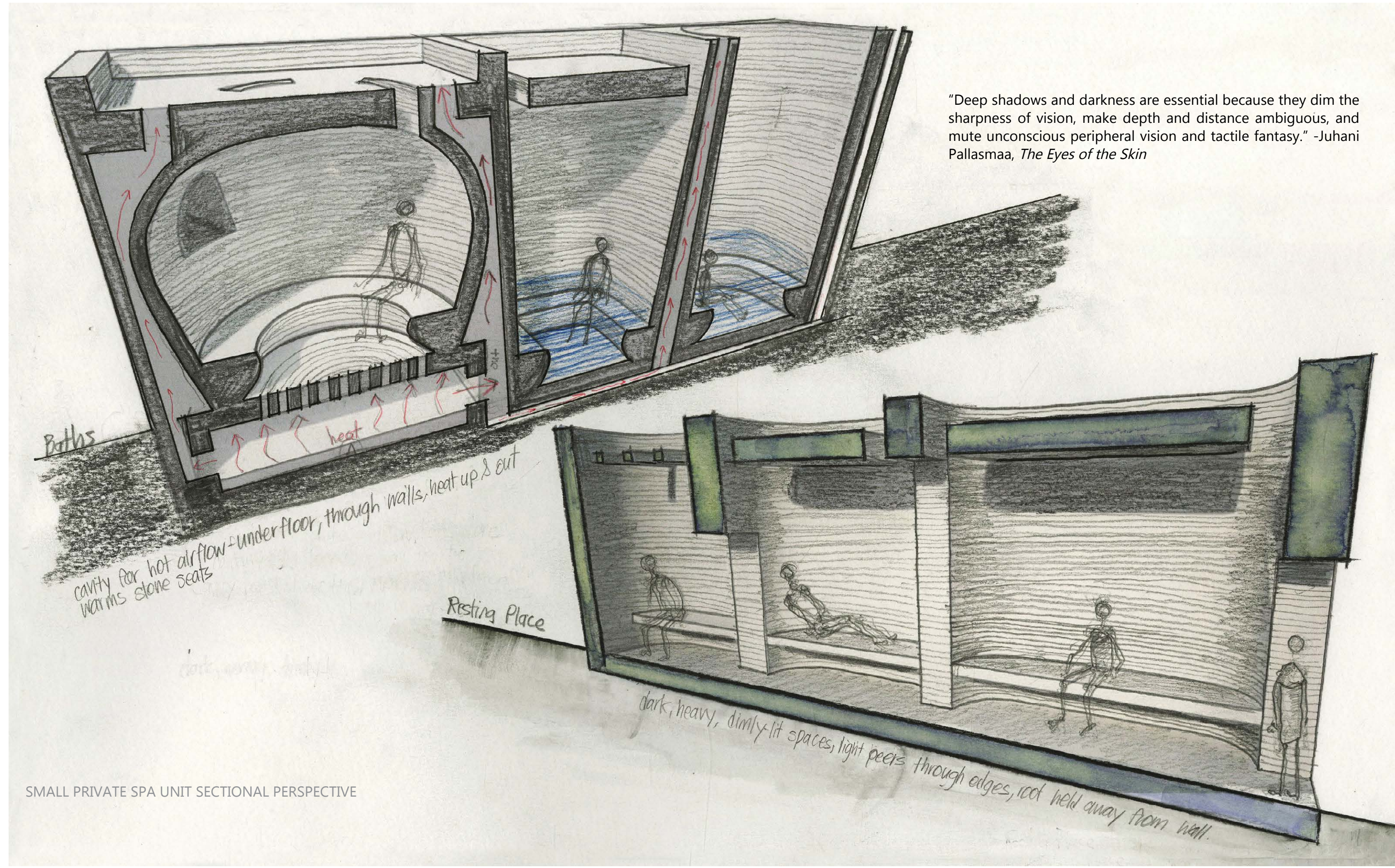

"Deep shadows and darkness are essential because they dim the sharpness of vision, make depth and distance ambiguous, and mute unconscious peripheral vision and tactile fantasy." -Juhani Pallasmaa, *The Eyes of the Skin*

SMALL PRIVATE SPA UNIT SECTIONAL PERSPECTIVE

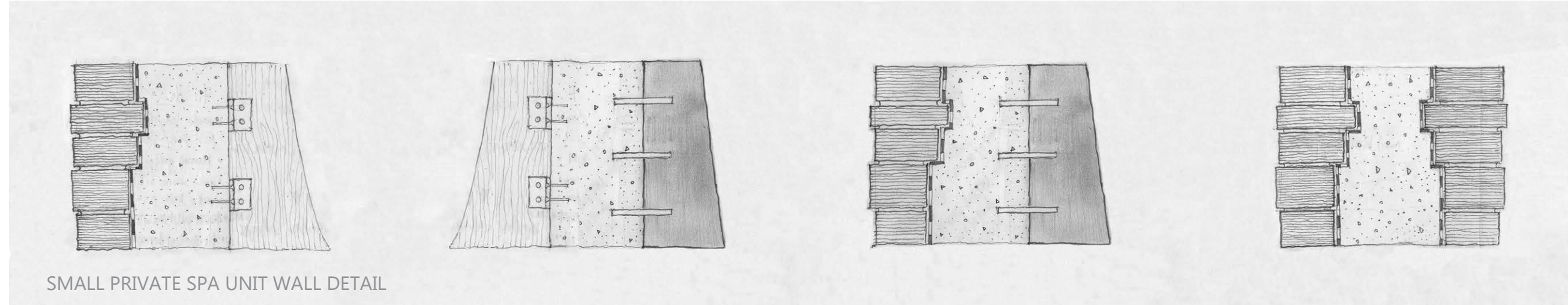

SMALL PRIVATE SPA UNIT WALL DETAIL

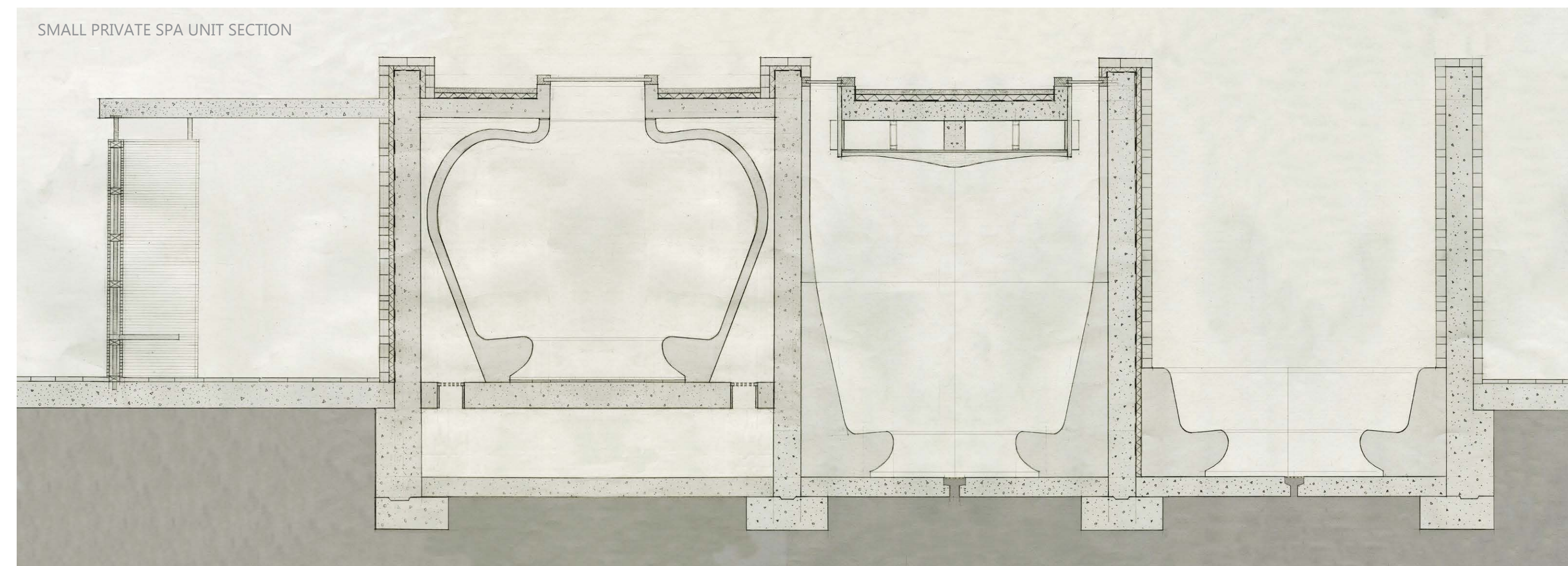

SMALL PRIVATE SPA UNIT SECTION

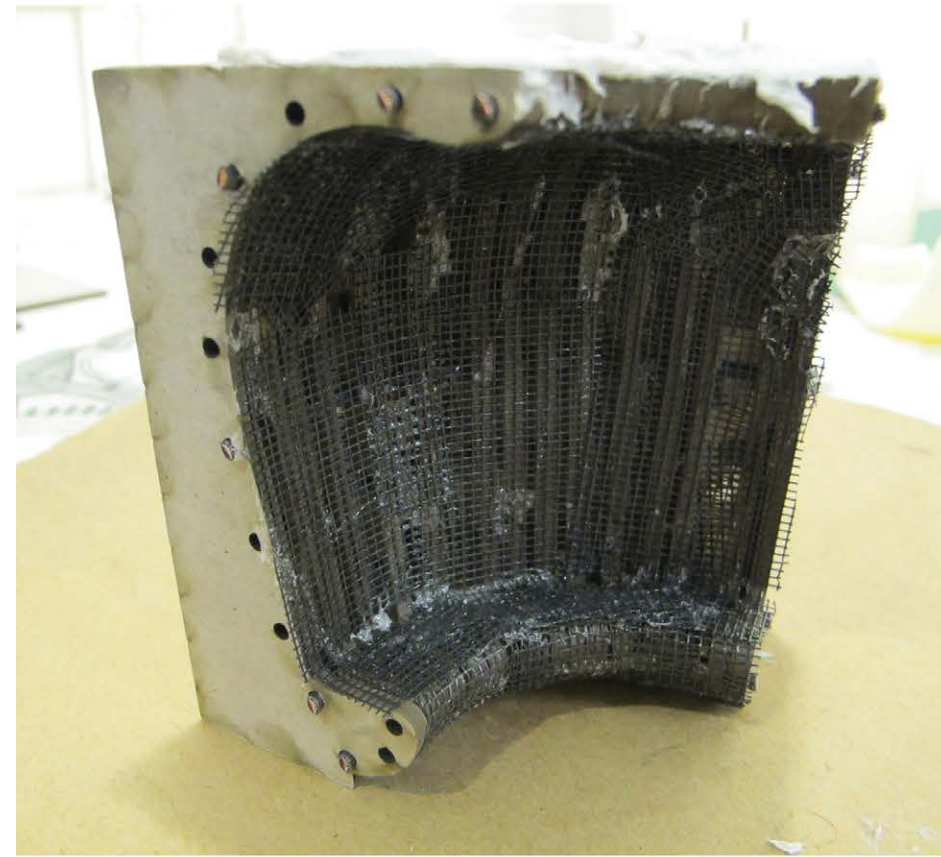

STEAM ROOM MATERIAL STUDIES

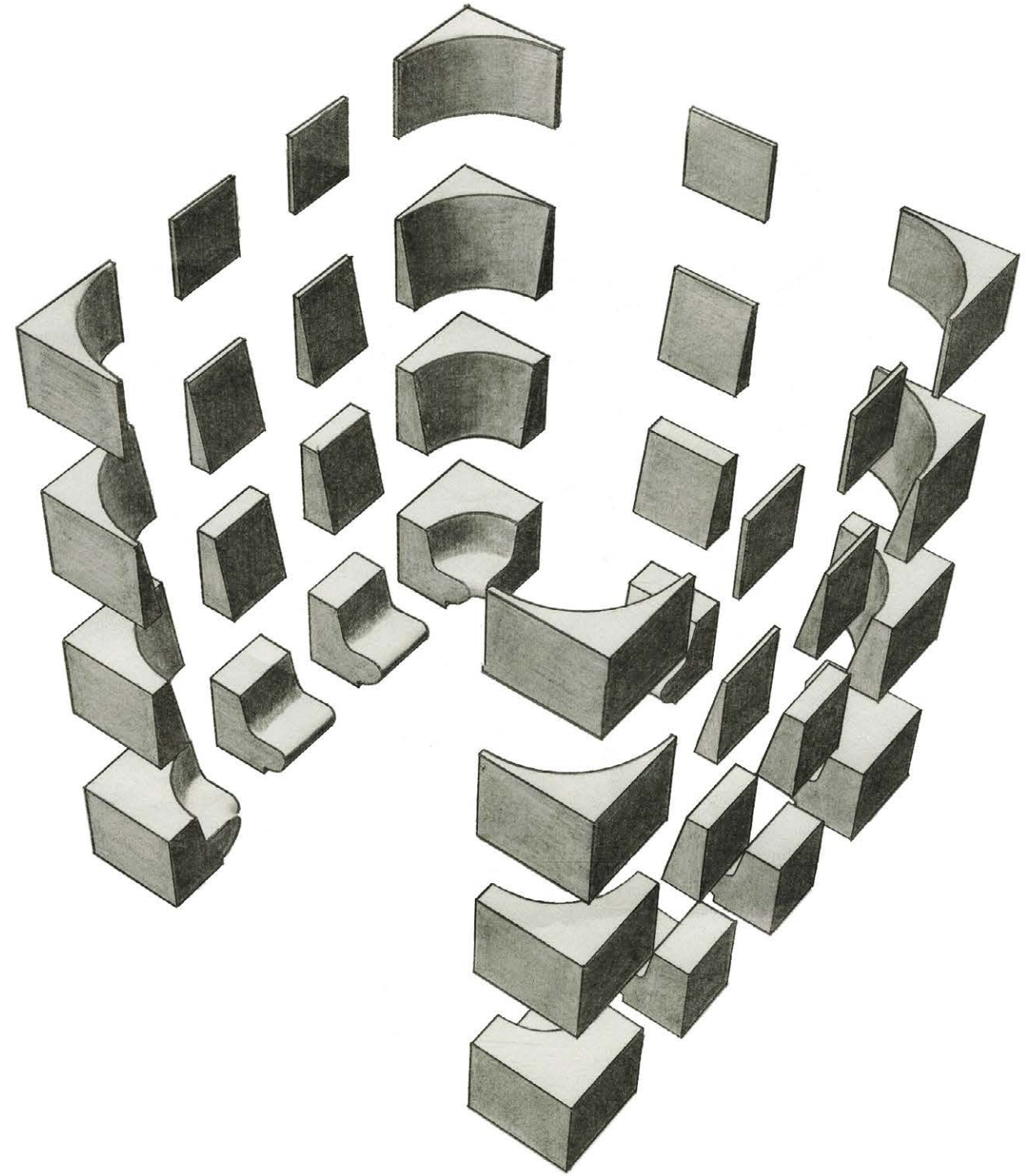
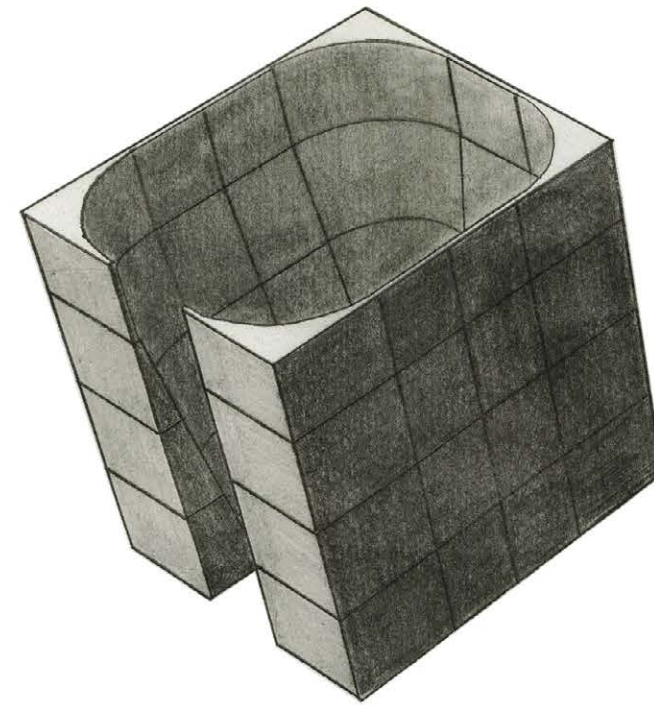
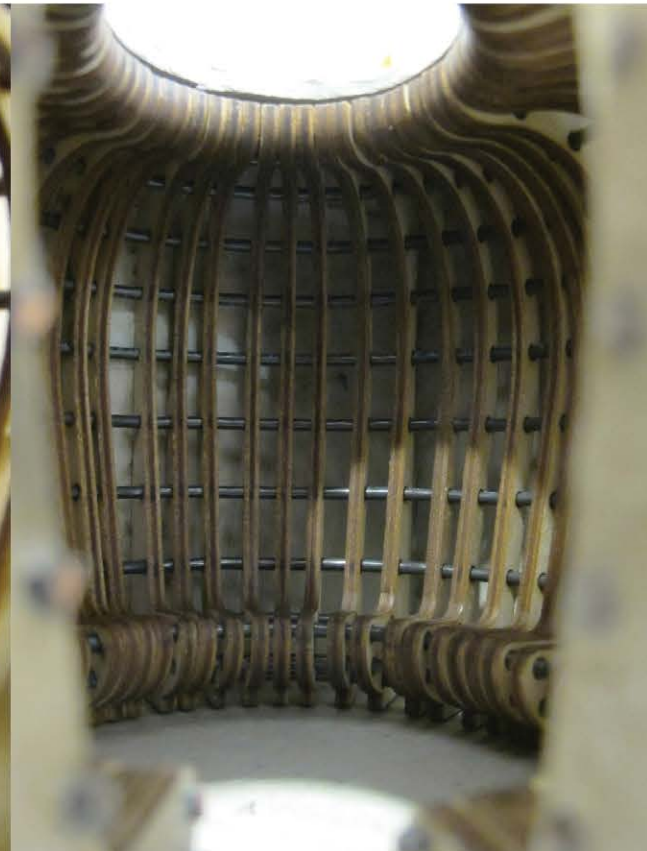

HOT BATH PRECAST PARTS

LARGE PRIVATE SPA UNIT CONCEPT PLAN

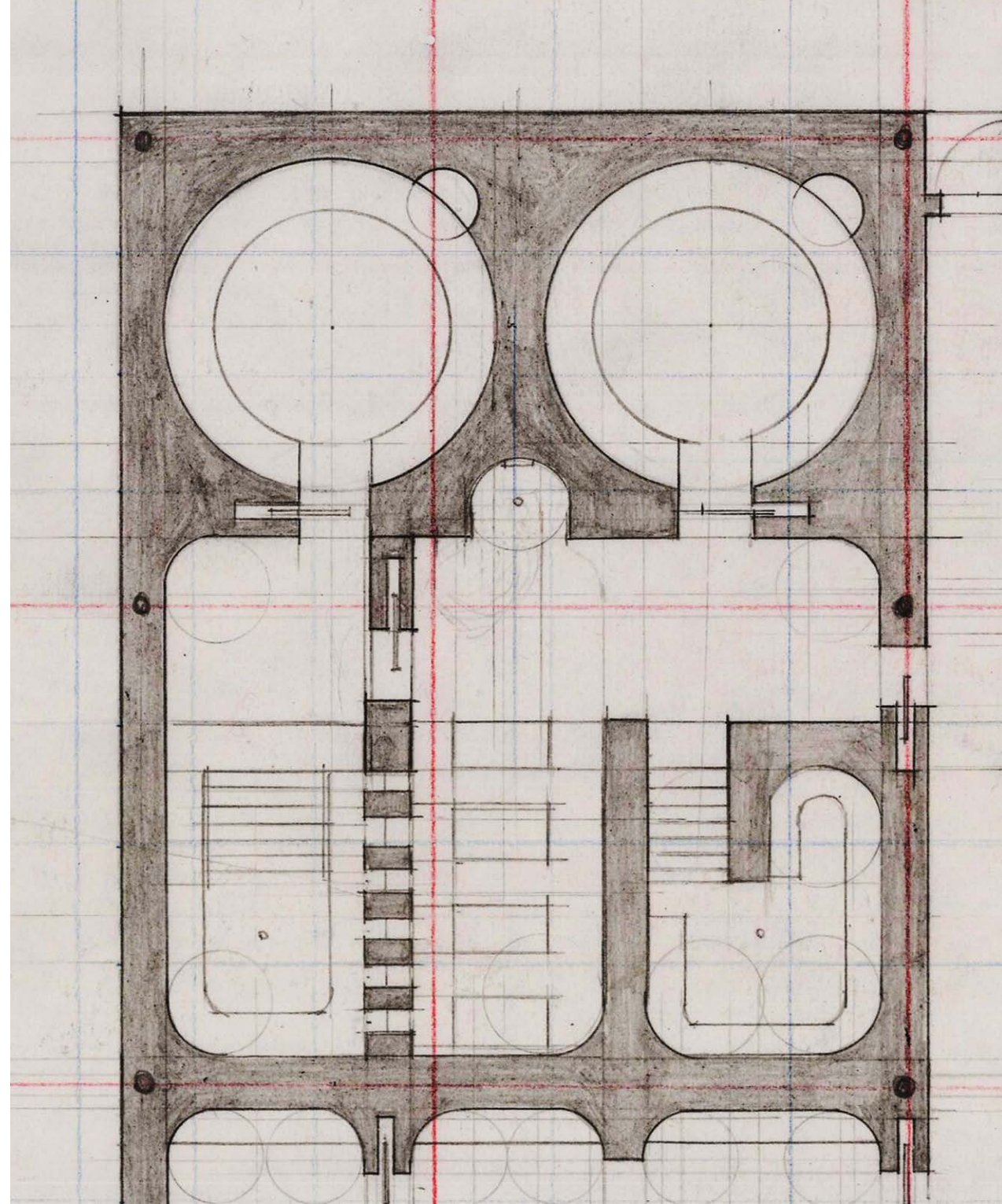

LARGE PRIVATE SPA UNIT AXON

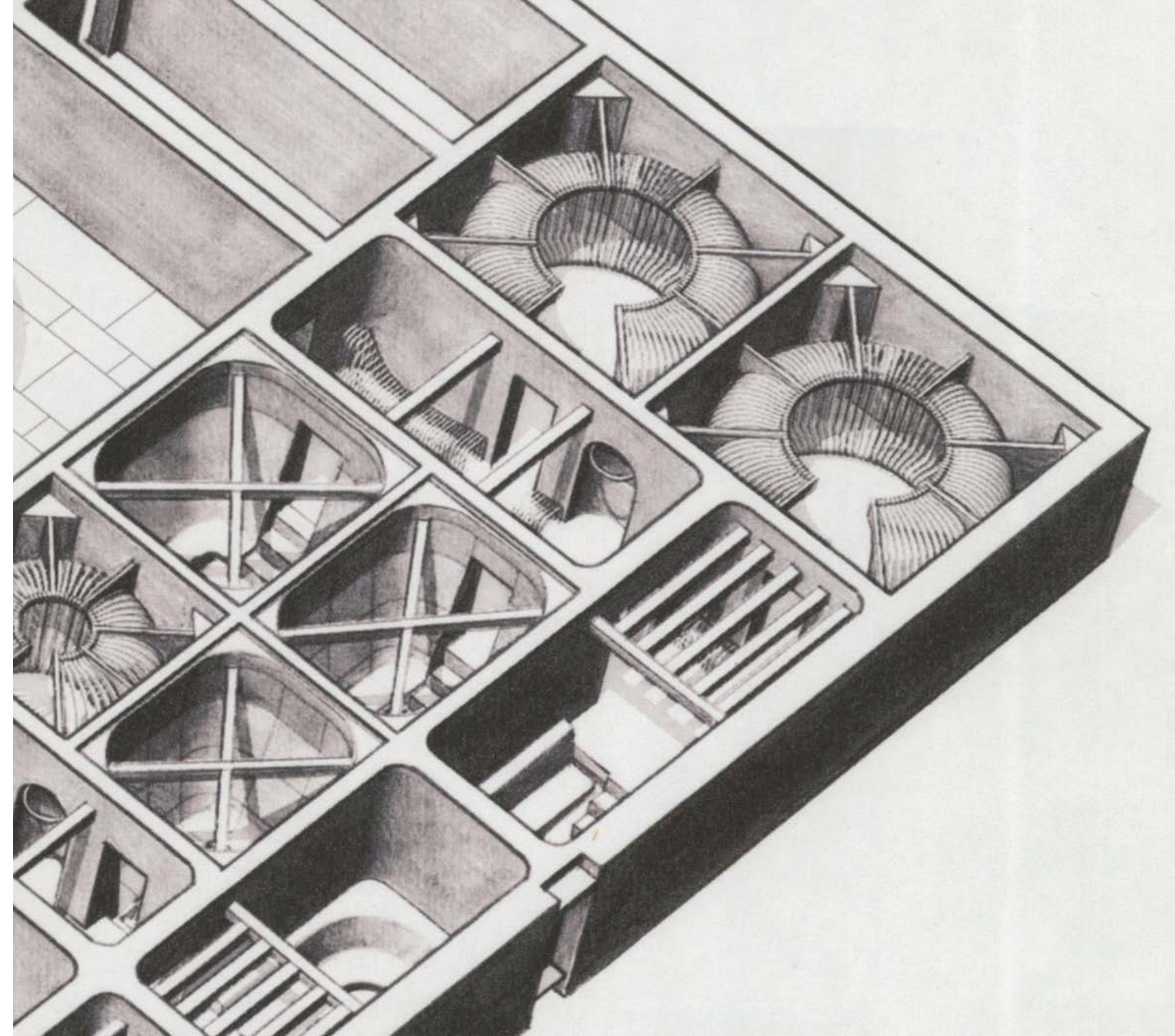

MESSAGE ROOM AXON

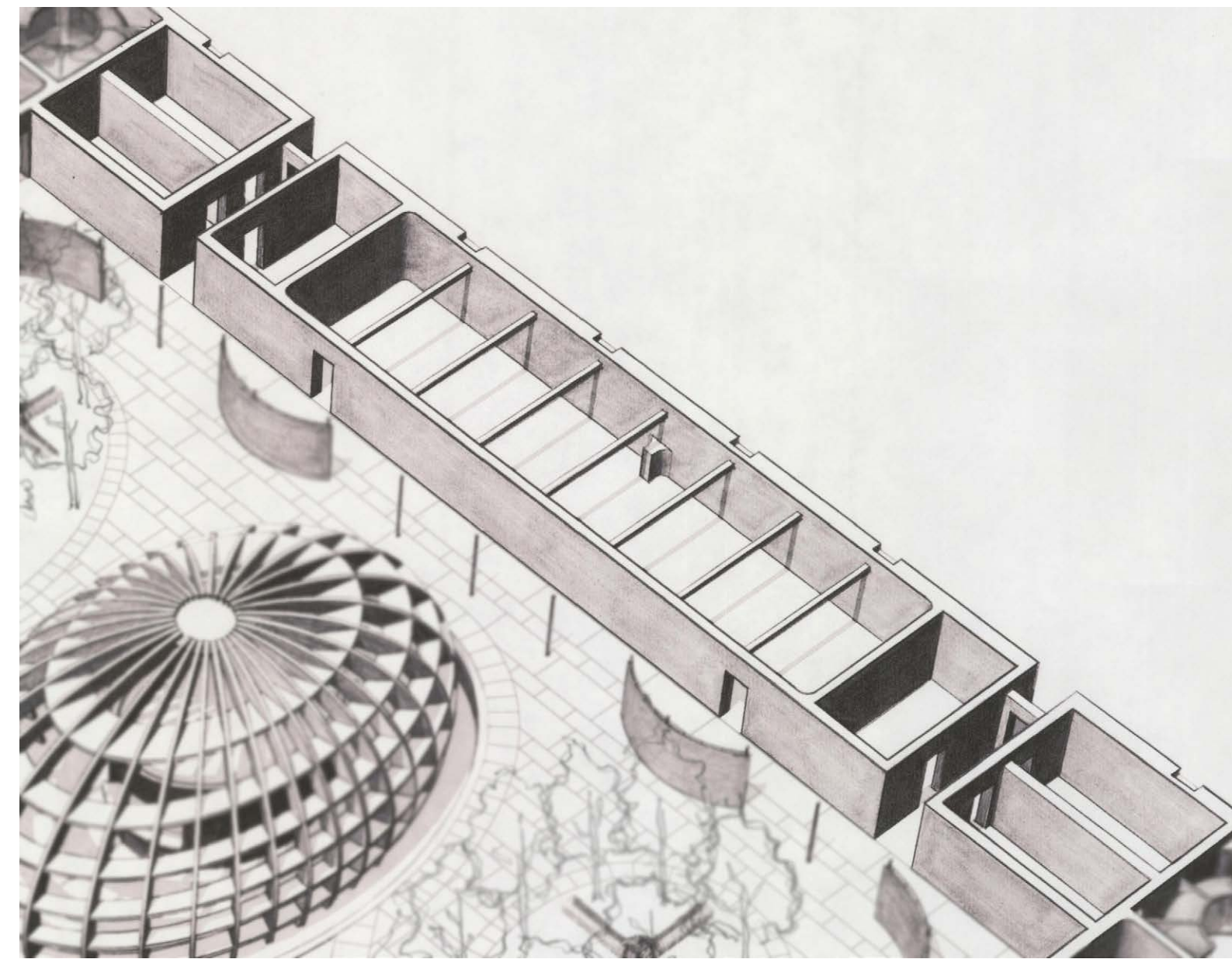

BATHROOMS, MECHANICAL ROOM, AND EXIT AXON

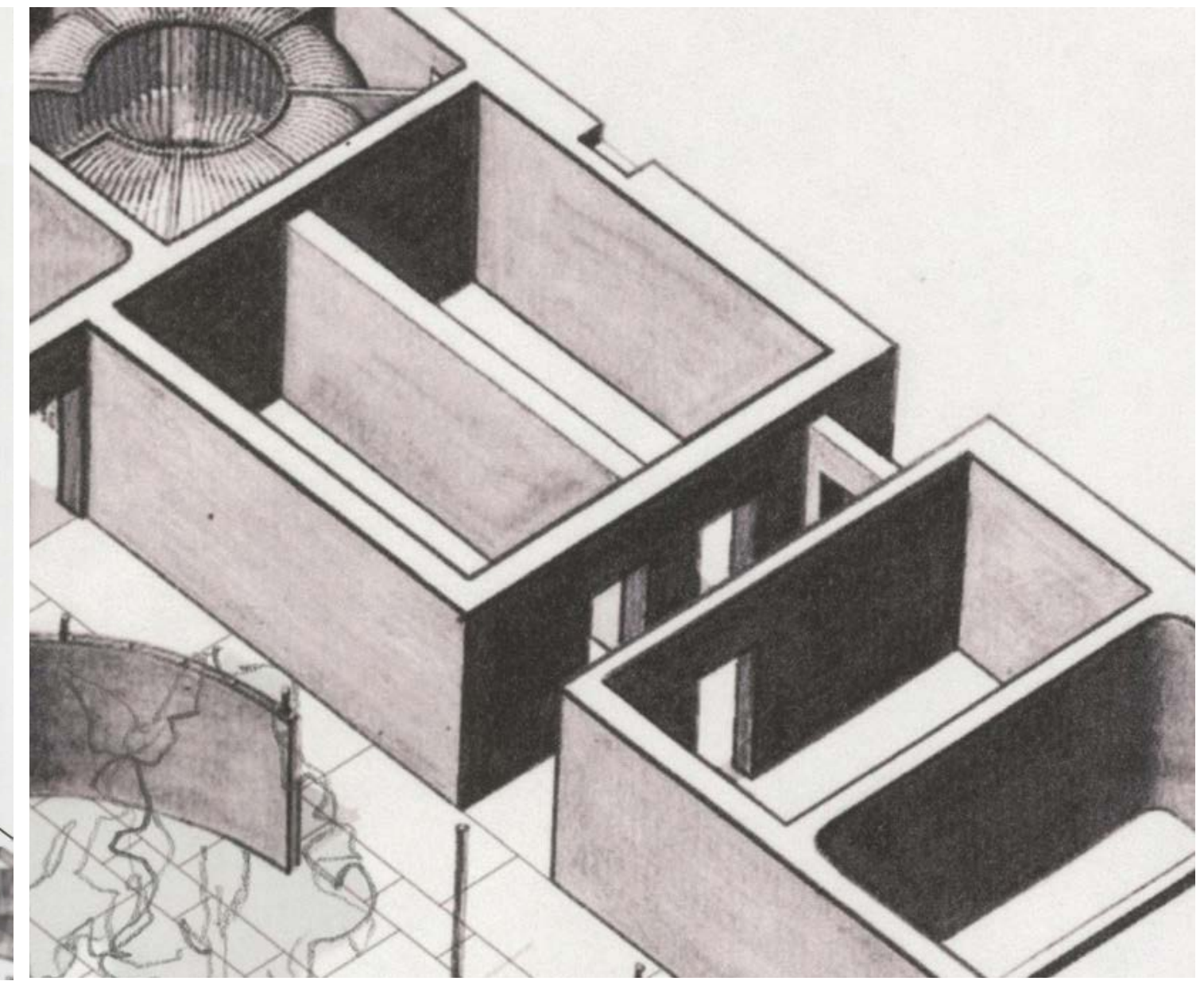



A GROVE OF TREES, A PLACE TO SIT AXON

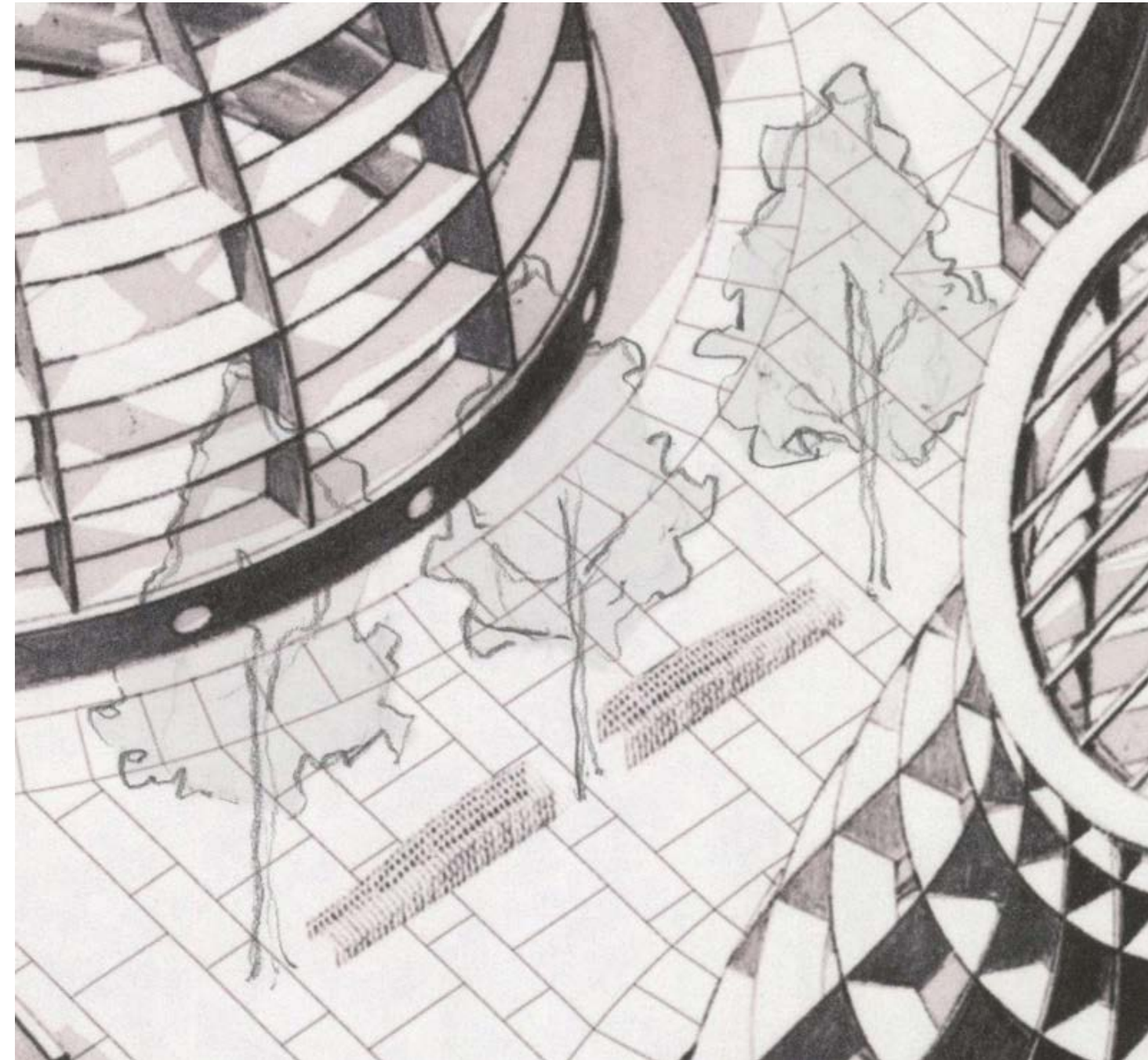
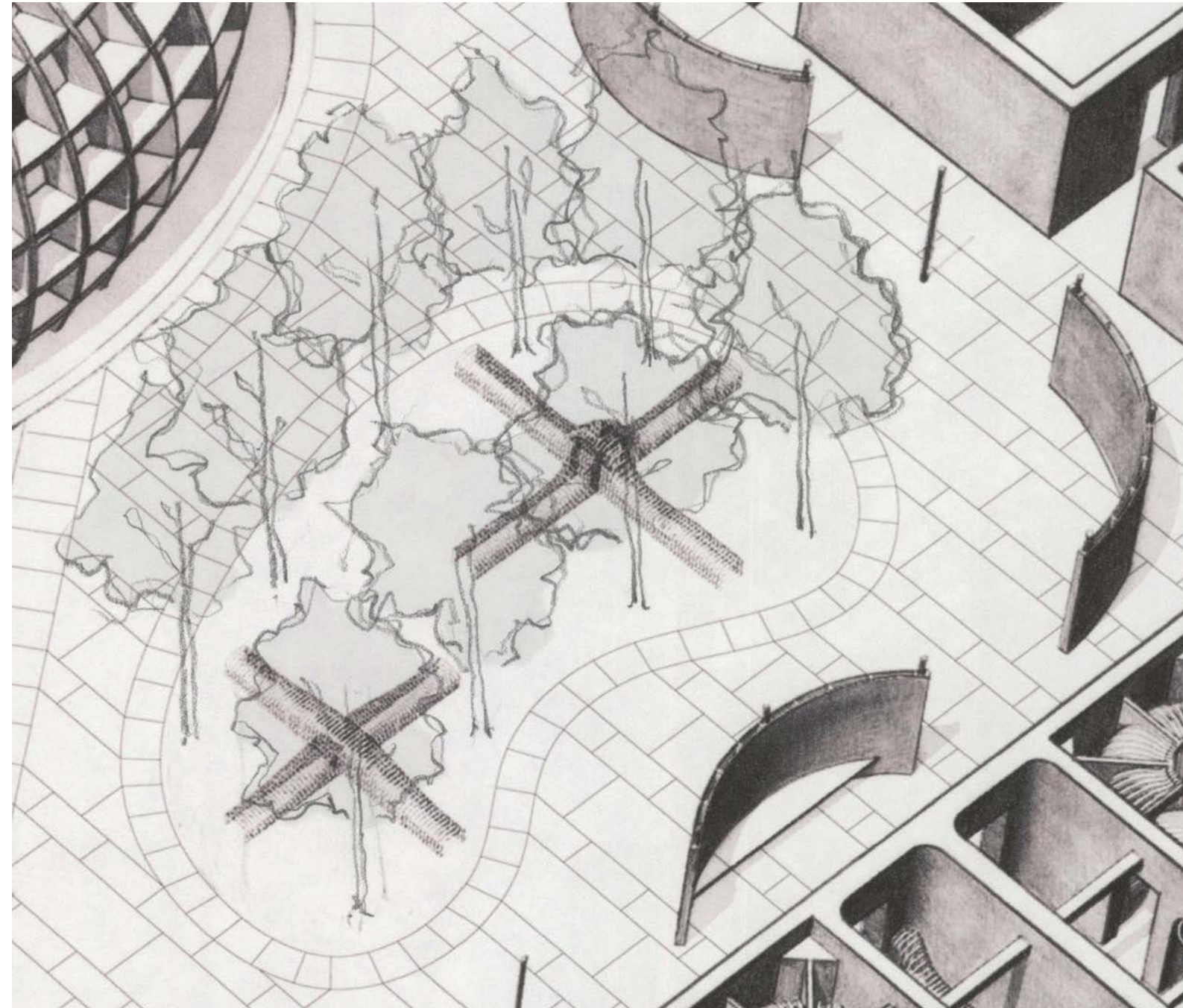

A GROVE OF TREES,  
A PLACE TO SIT  
PERSPECTIVE





BODY IN SEAT



SMALL PRIVATE SPA UNIT  
HALLWAY PERSPECTIVE

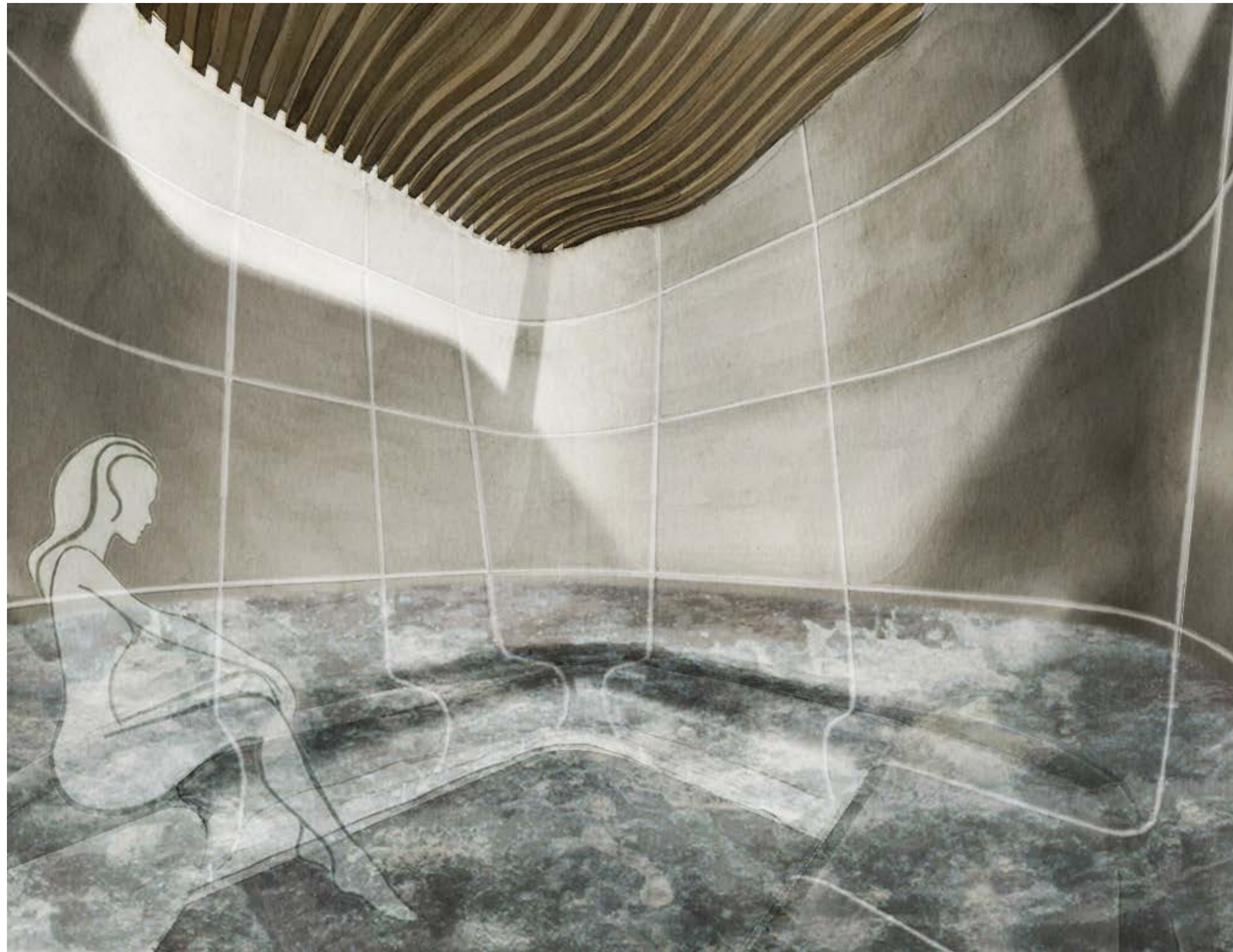

SMALL PRIVATE SPA UNIT  
HOT BATH PERSPECTIVE



SMALL PRIVATE SPA UNIT  
STEAM ROOM PERSPECTIVE



GARDEN PERSPECTIVE 01



GARDEN PERSPECTIVE 02



### Work Referenced

Bloomer, Kent C.; Moore, Charles W. *Body, Memory, and Architecture*. New Haven and London: Yale University Press, 1977. Print.

Franck, Karen A.; Lepori, R. Bianca. *Architecture from the Inside Out*. Great Britain: Wiley-Academy, 2007. Print.

Henry, Robert D.; Taylor, Julie D. *Spa: The Sensuous Experience*. Australia: The Images Publishing Group Pty Ltd, 2005. Print.

Kim, Jong Jin. *Bodyscape*. Korea: Damdi and Designer, 2007. Print.

Kovac, Tom. *Architectural Monographs No 50*. Great Britain: Academy Editions, 1998. Print.

Lynn, Greg. *Animate Form*. New York: Princeton Architectural Press, 1999. Print.

Pallasma, Juhani. *The Eyes of the Skin: Architecture and the Senses*. Great Britain: Wiley-Academy, 2005. Print.

Sveiven, Megan. *AD Classics: Palais Bulles / Antti Lovag*. Arch Daily, 2011. Web. 8 September 2012. < <http://www.archdaily.com/tag/antti-lovag/>>.

"sensual." *Dictionary.com Unabridged*. Random House, Inc. 27 May. 2013. <<http://dictionary.reference.com/browse/sensual>>.

WASHINGTON DC (MAP ON PAGE 29) GOOGLE MAP OF SITE (PUBLIC DOMAIN)

SITE PLAN 01 (MAP ON PAGE 30) GIS MAP OF SITE (PUBLIC DOMAIN)