

# From Screen Patterns Toward Domical Form

Mohammed Alamodi

Thesis submitted to the faculty of the Virginia Polytechnic Institute and State University in partial fulfillment of the requirements for the degree of  
Master of Architecture in Architecture

Steven R. Thompson

Howard S. Gartner

Hans C. Rott

Dec 11, 2013  
Blacksburg, VA

Keywords: pattern, screen, dome, shell, shading

# From Screen Patterns Toward Domical Form

Mohammed Alamodi

## ABSTRACT

This thesis aims at creating a dome fabricated from pattern and studying some of the forms of patterns that focus on organistic pattern.

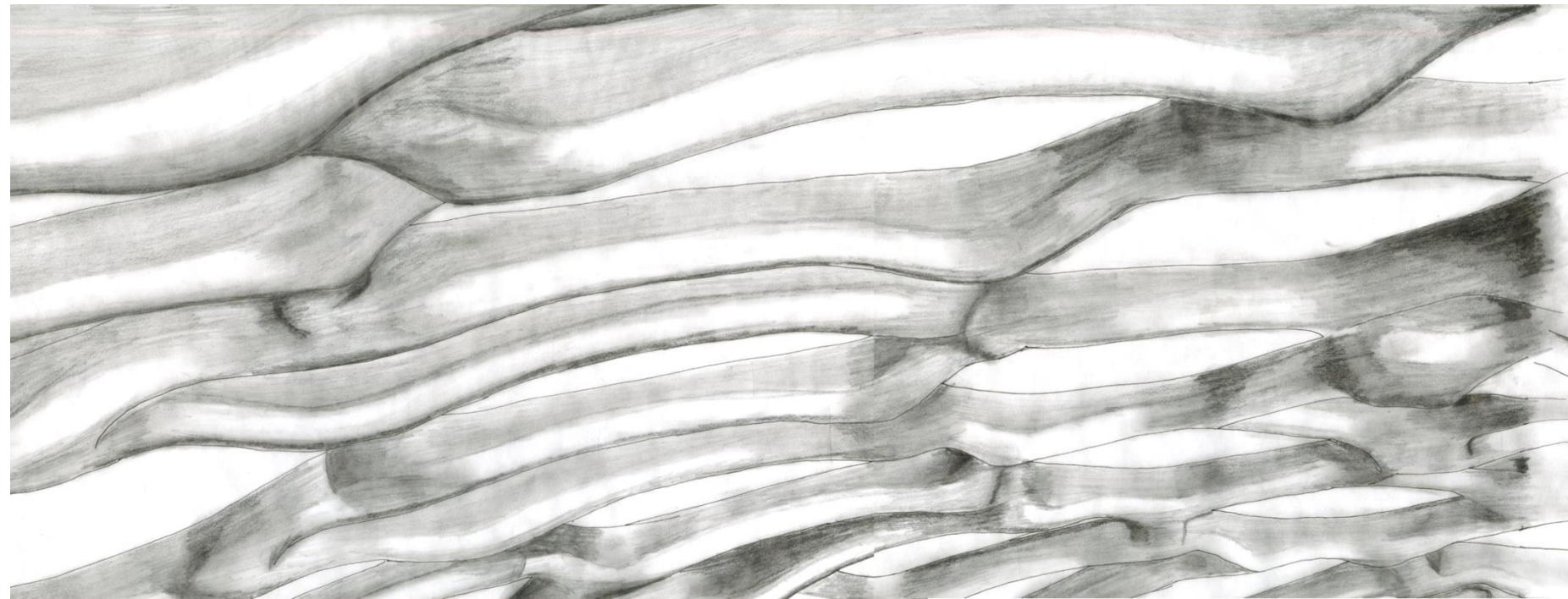

# ACKNOWLEDGEMENTS

Without the presence, love, and support of my family, friends, and my professors, this thesis could not have been made possible.

To my family, thanks for every thing.

To my committee: Steven Thompson, Howard Gartner, and Hans Rott, thanks all for your patience and critique of my work.

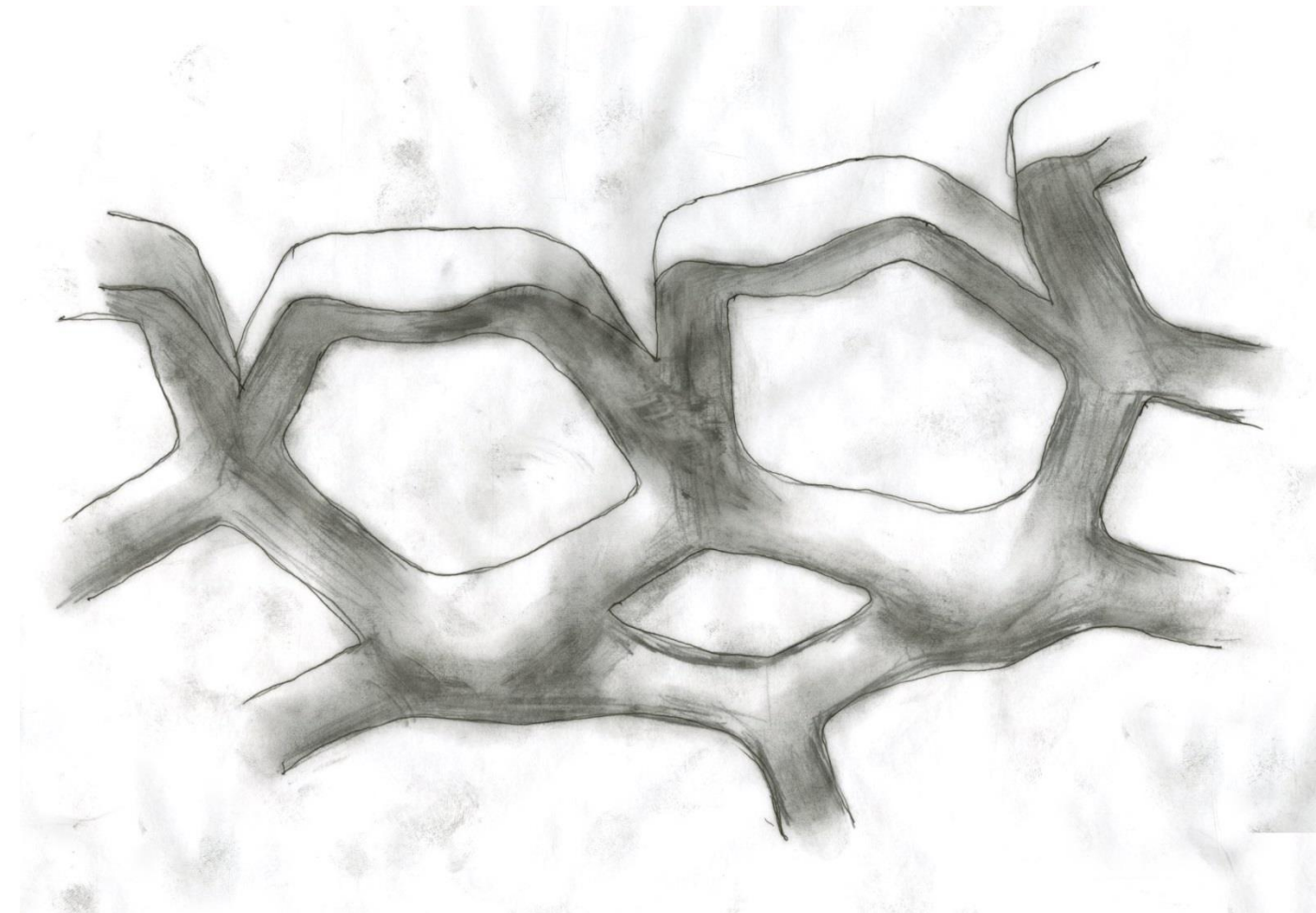

Title	I
Abstract	II
Acknowledgements	III
Contents	IV
Screen Patterns	1
Organistic Patterns	6
Domical Form and Pattern	11
Domical Shape Sections	13
Plans of Domical Shape	15
Section Load Diagram	19
Foundation	23
Structure	24
Details of Joints	25
Preliminary Studies	29
Sketches	30

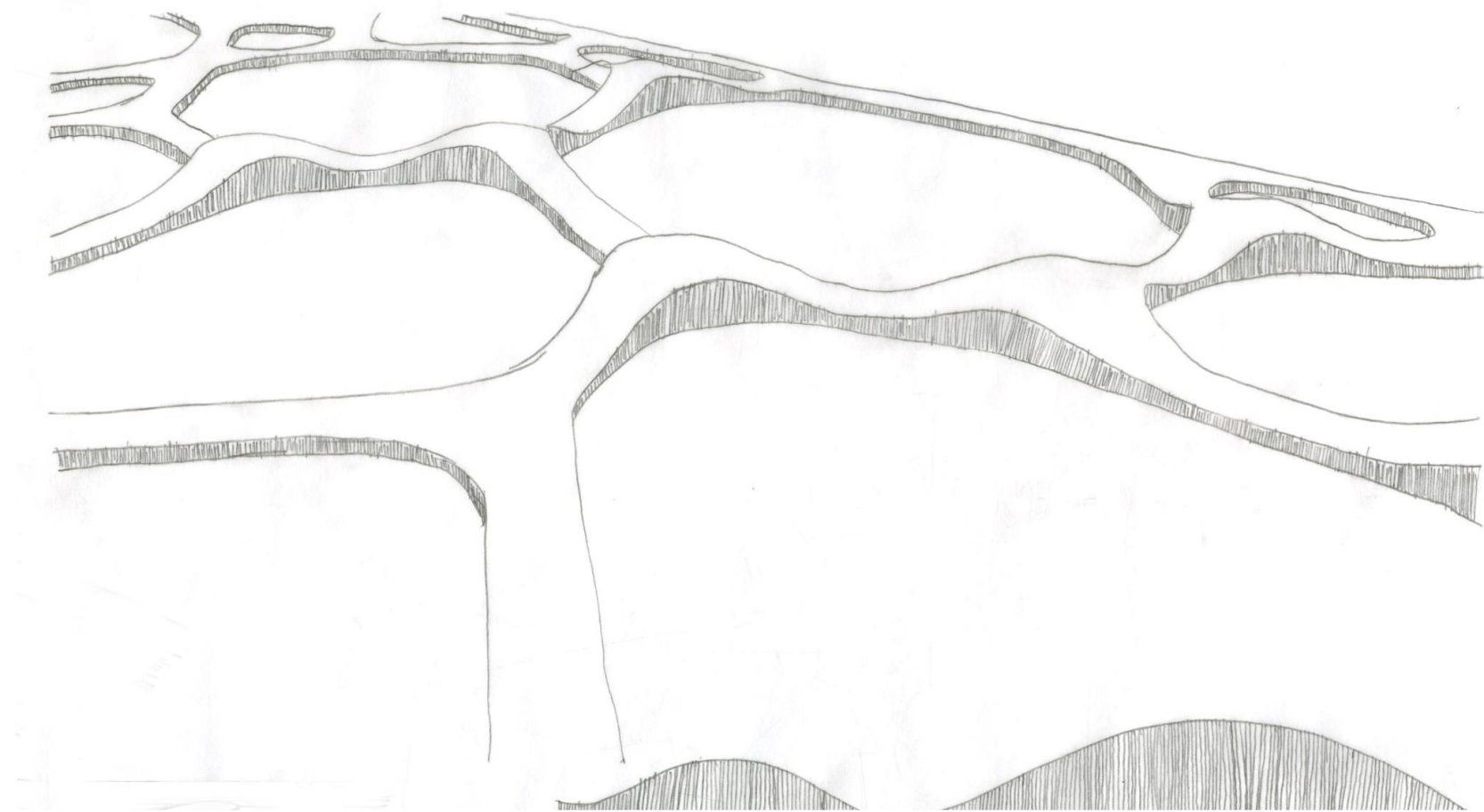

# CONTENTS



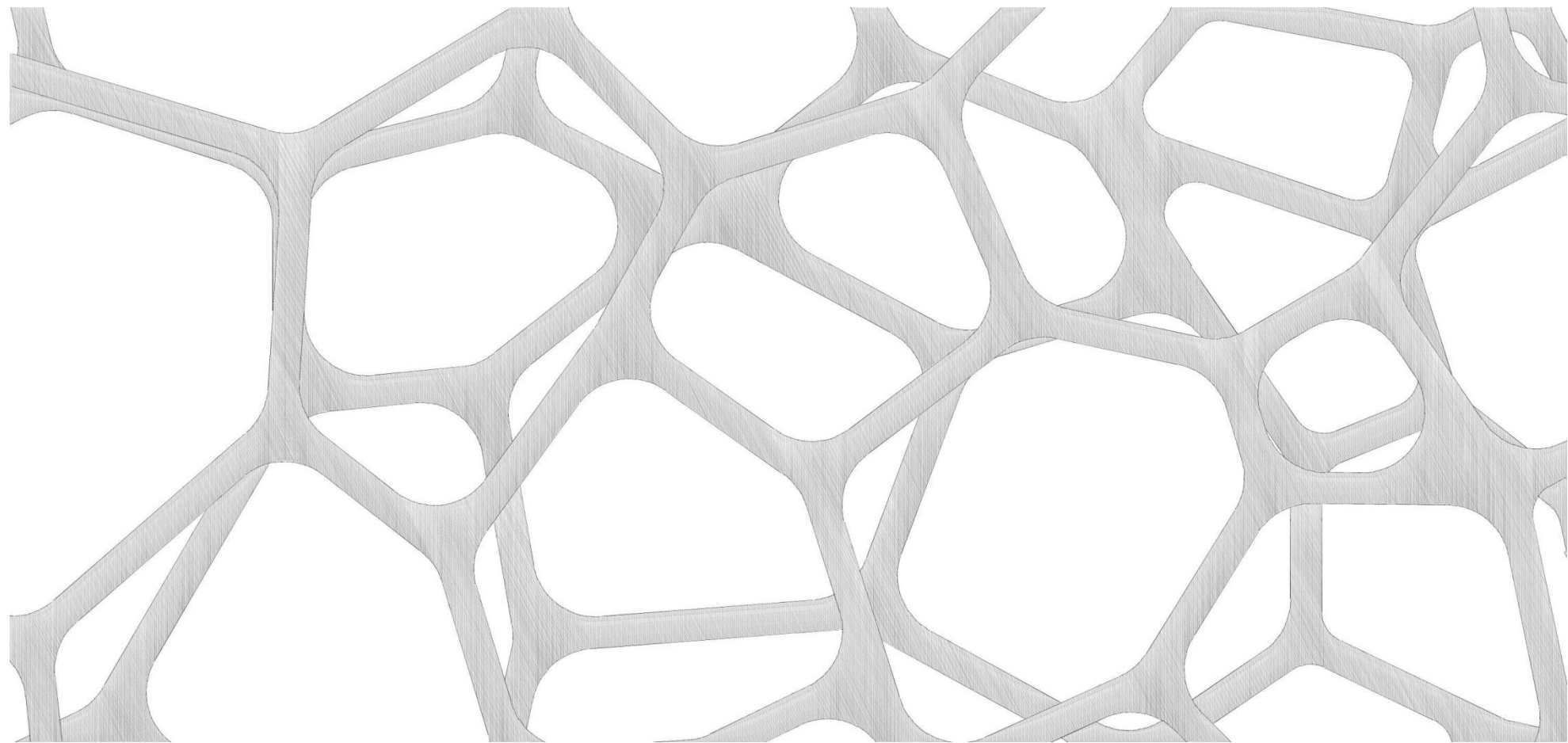

# SCREEN PATTERNS

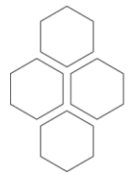

Layer 1

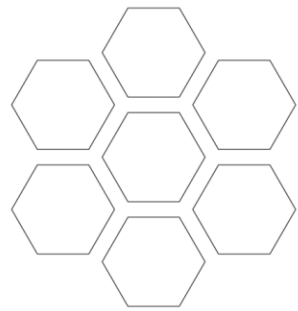

Layer 2

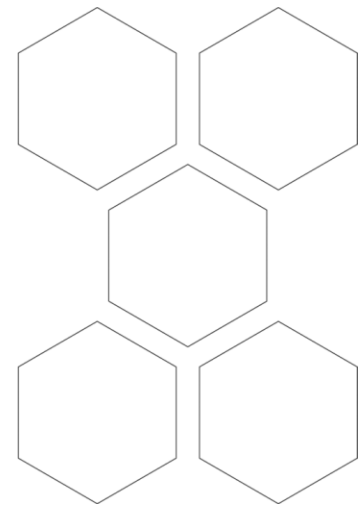

Layer 3

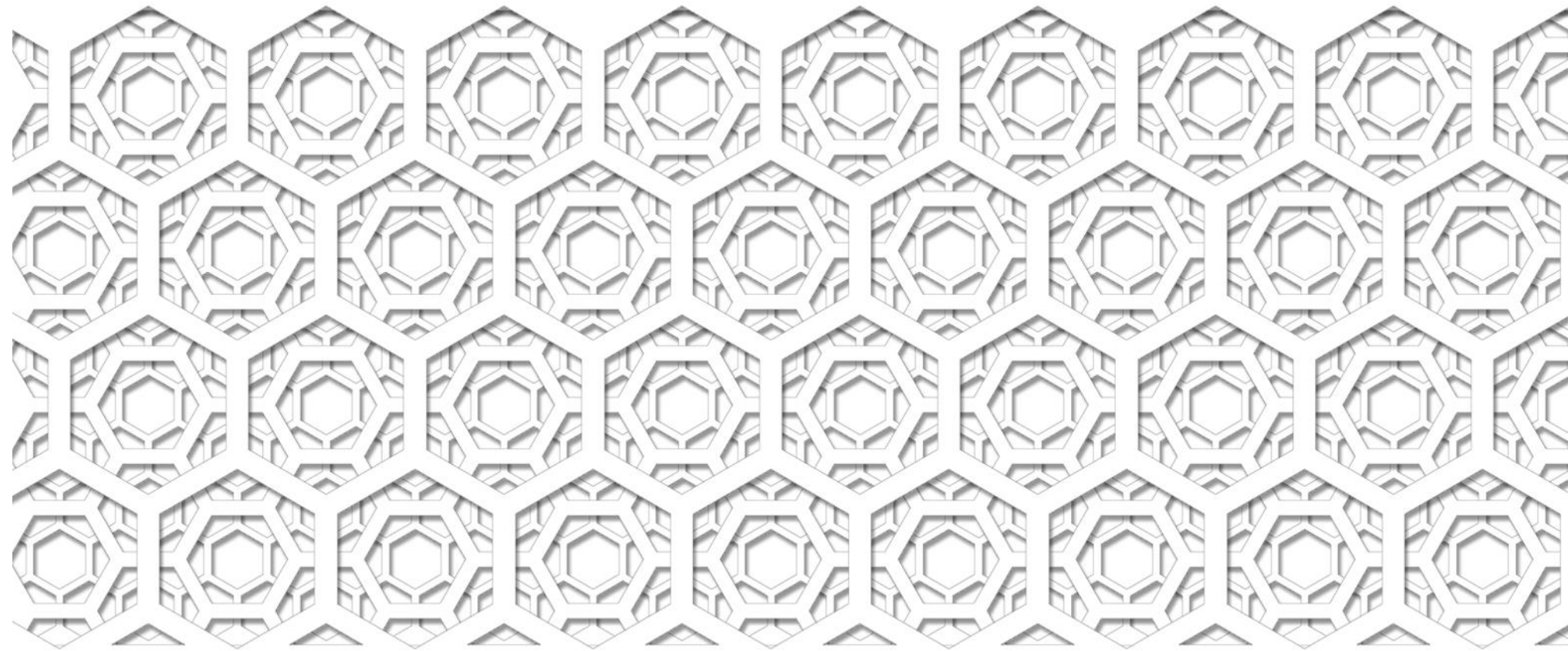

Layer 1+2+3

## SCREEN PATTERN

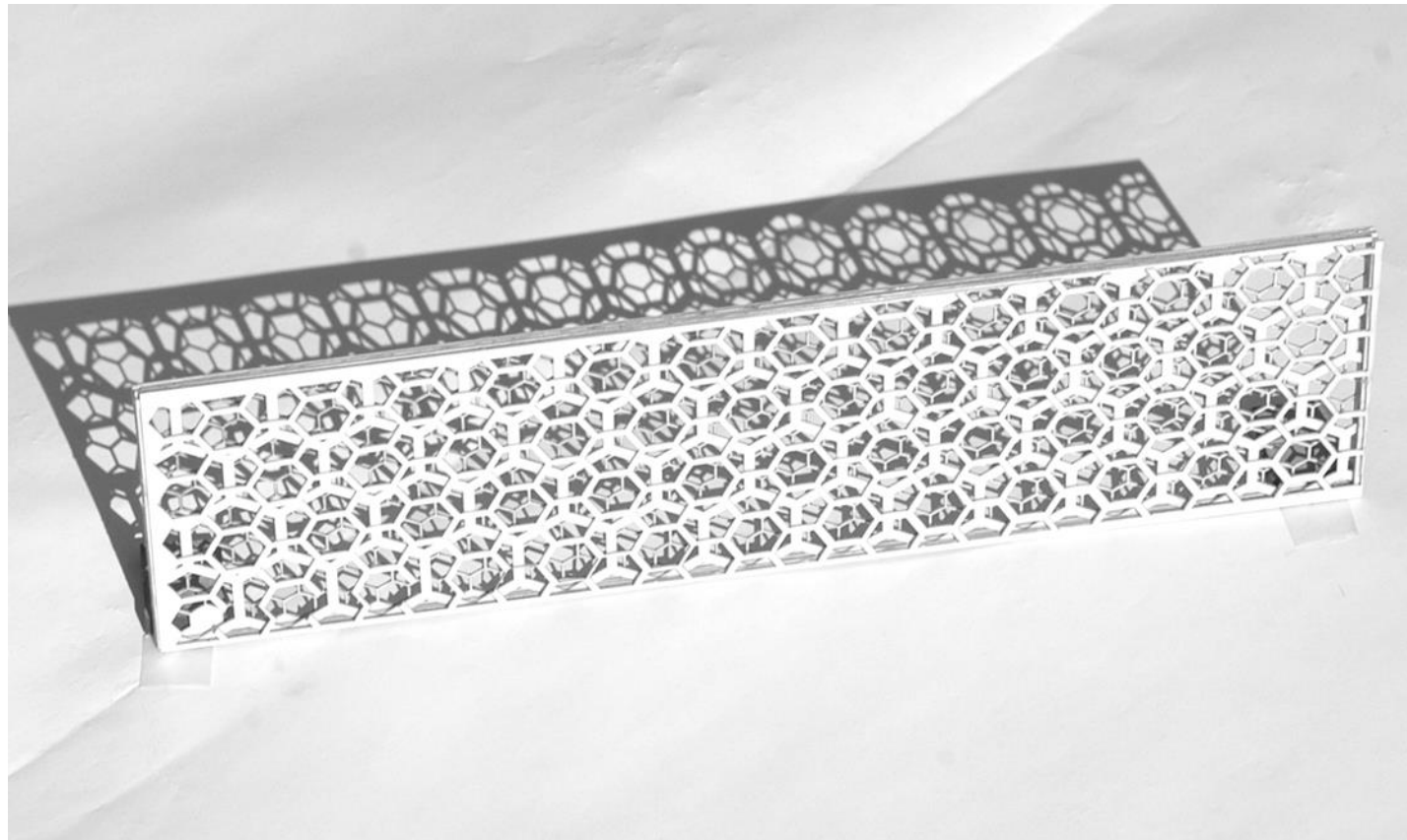

Model of screen

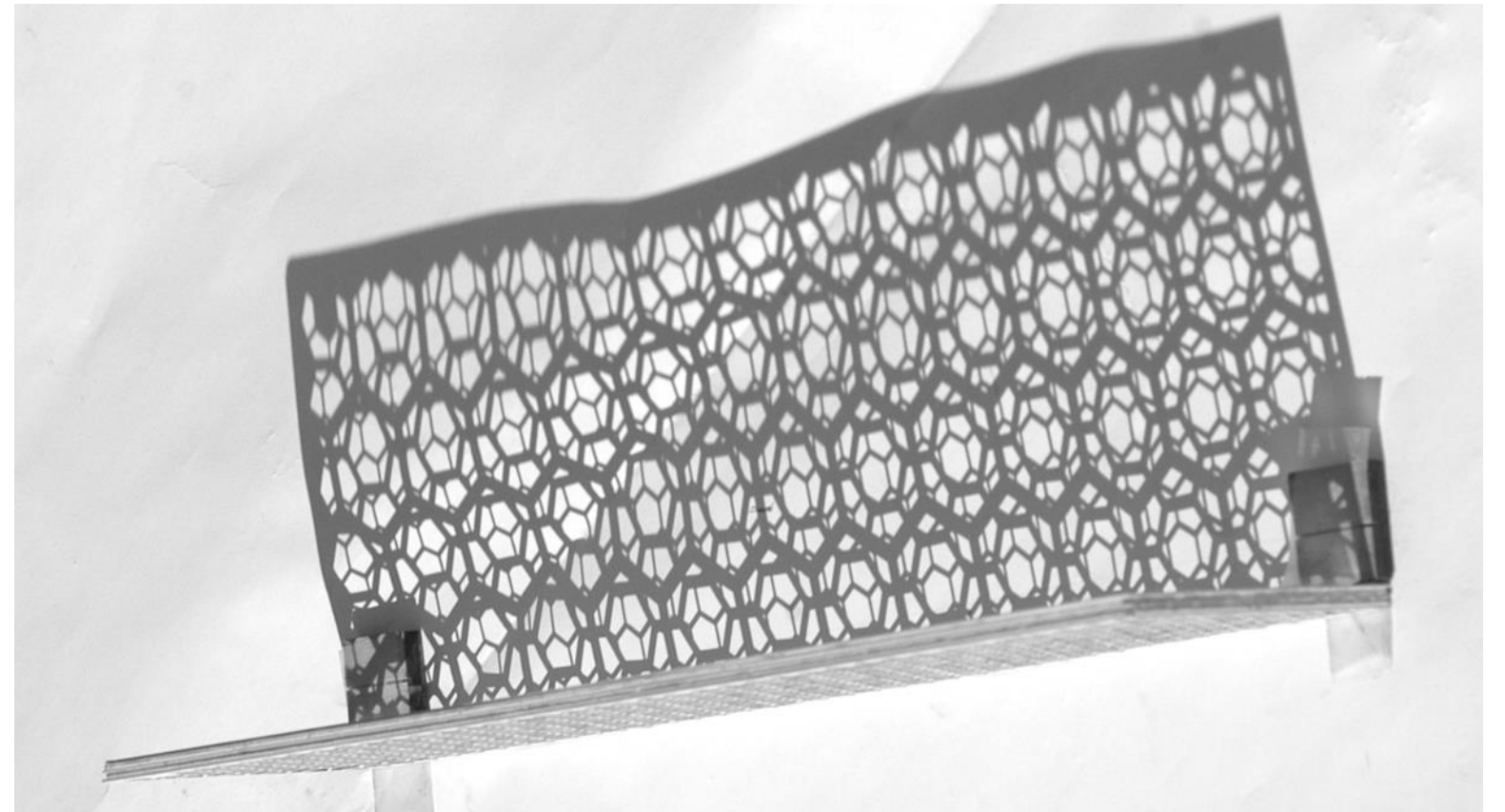

Effect of shade

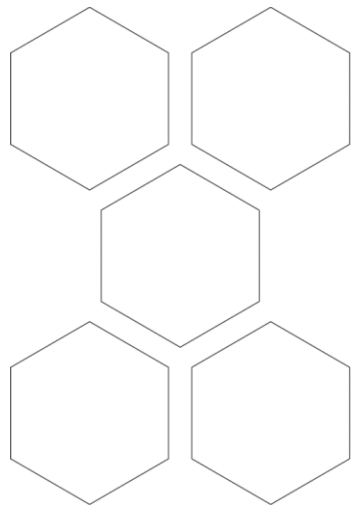

Layer 1

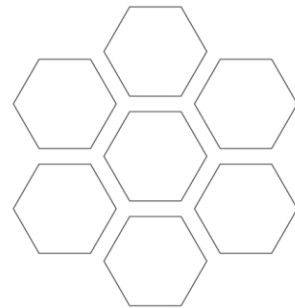

Layer 2

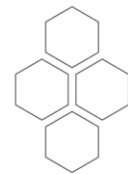

Layer 3

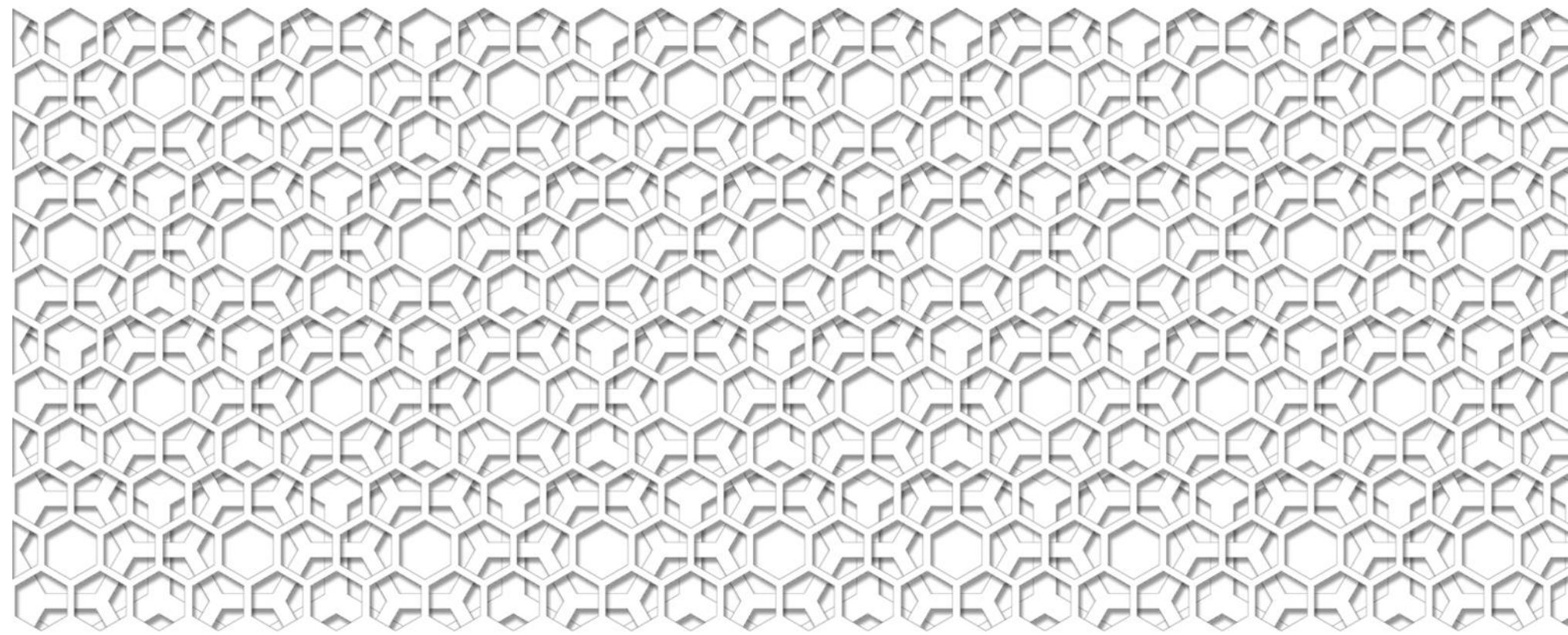

Layer 1+2+3

## SCREEN PATTERN

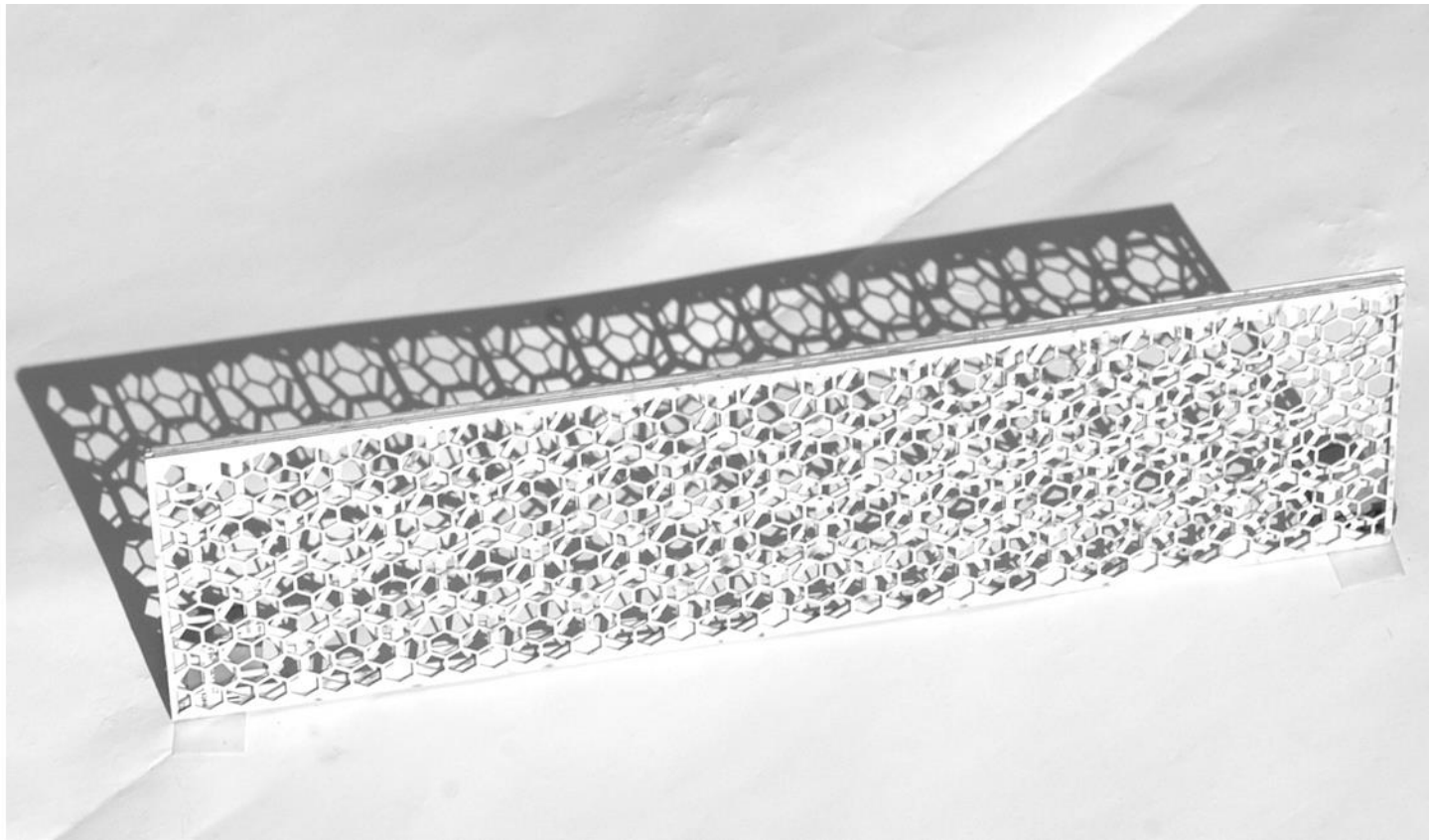

Model of screen

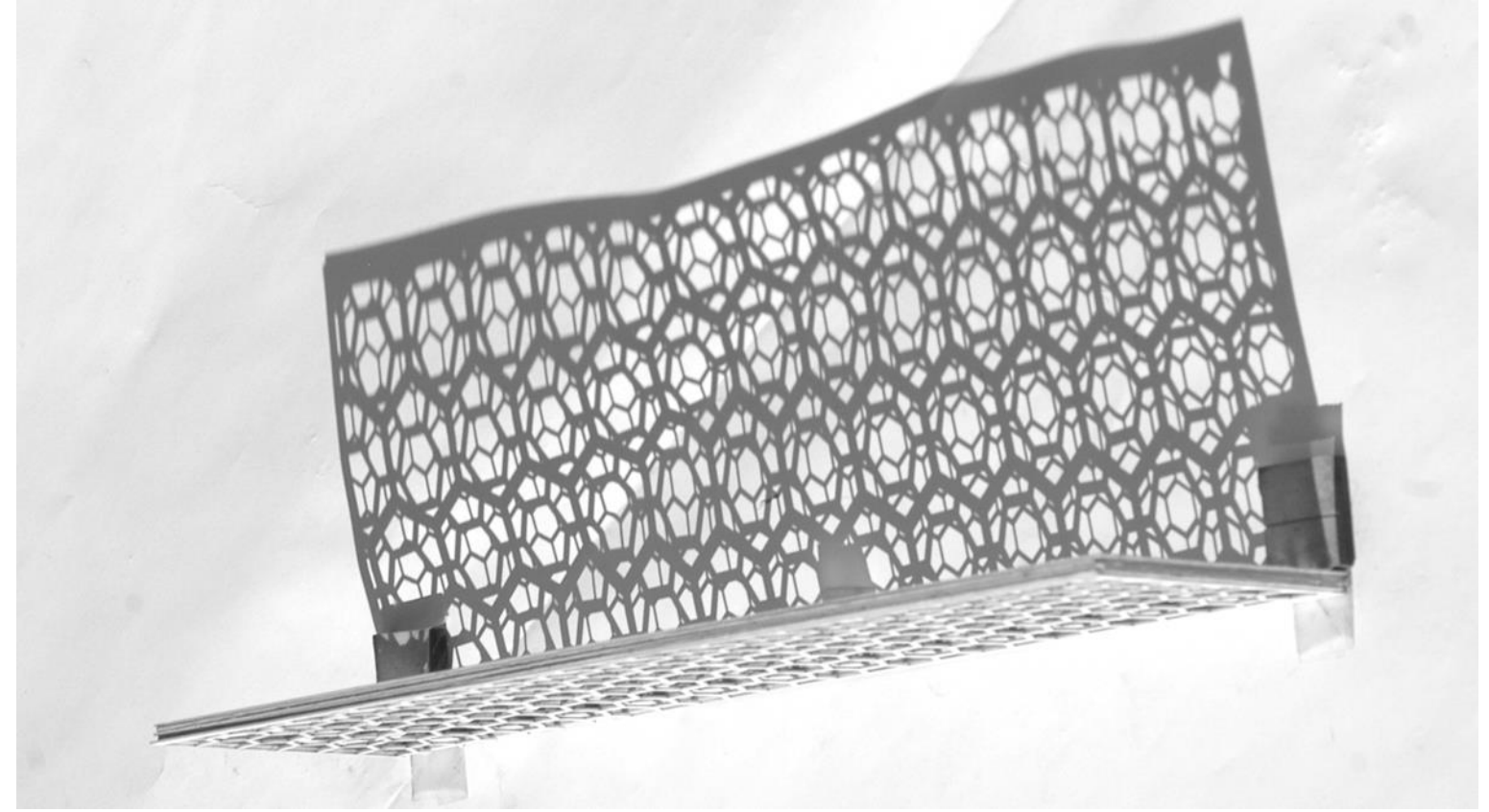

Effect of shade



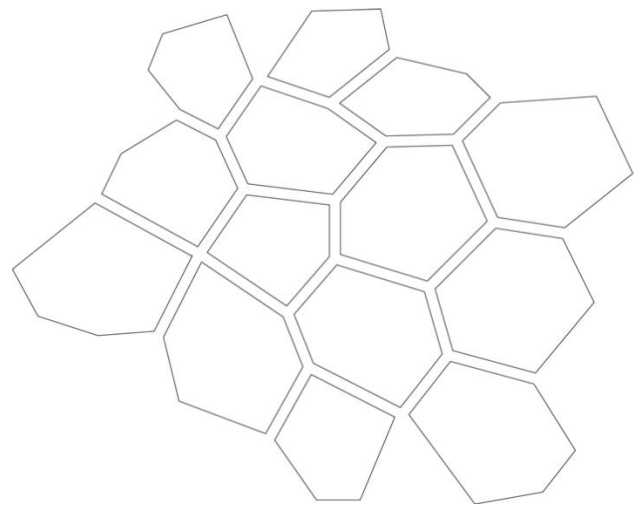

Sharp corners

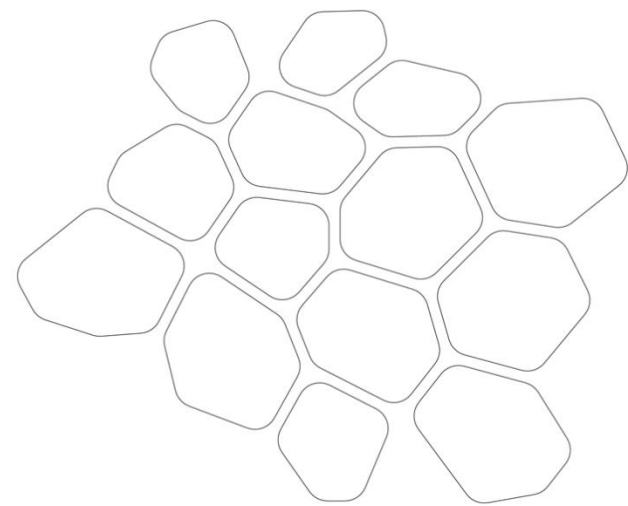

Smooth corners

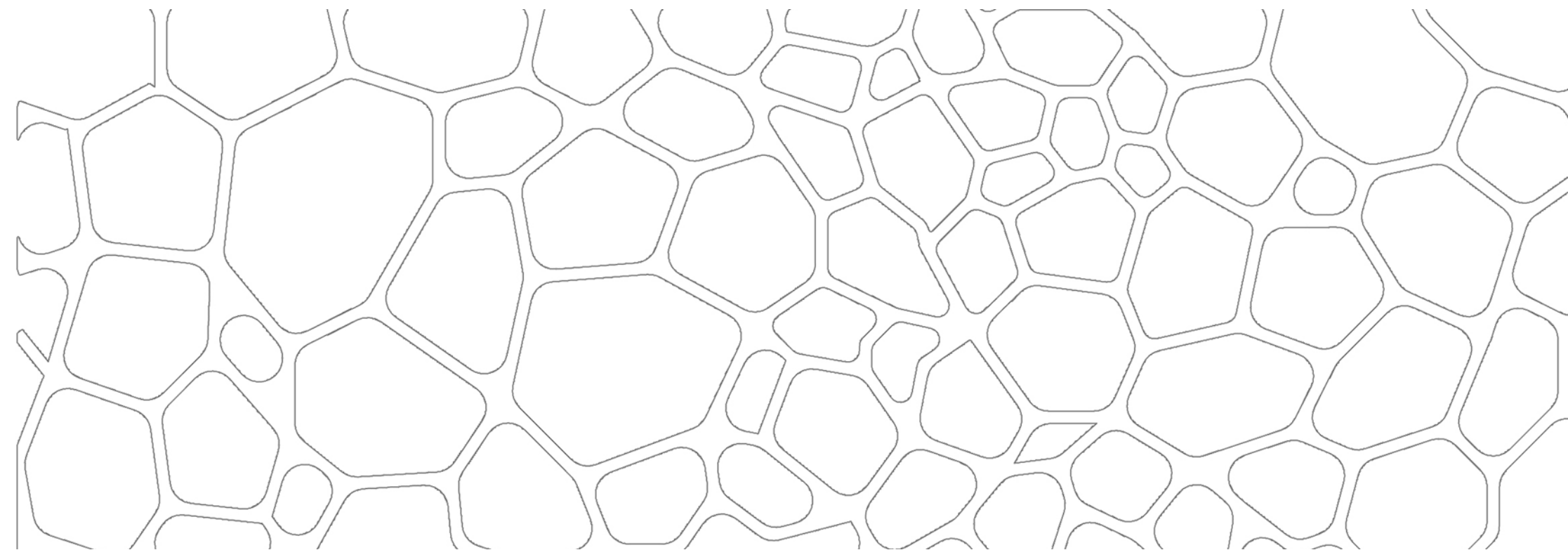
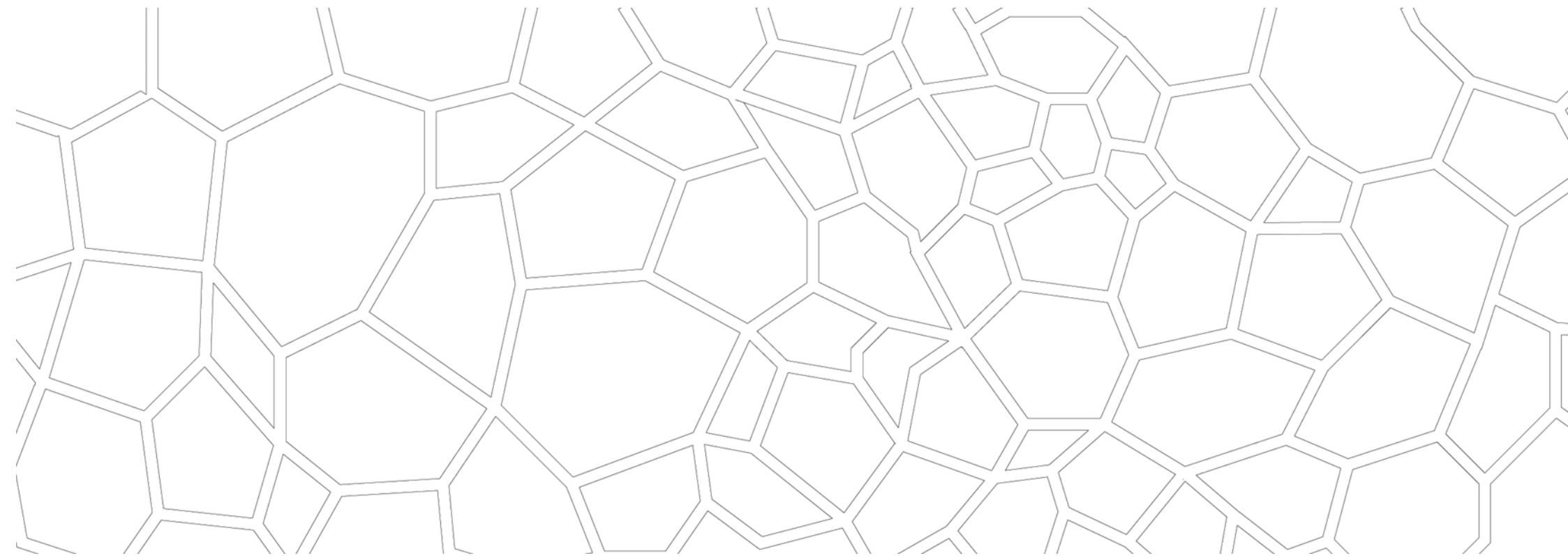

## ORGANISTIC PATTERNS

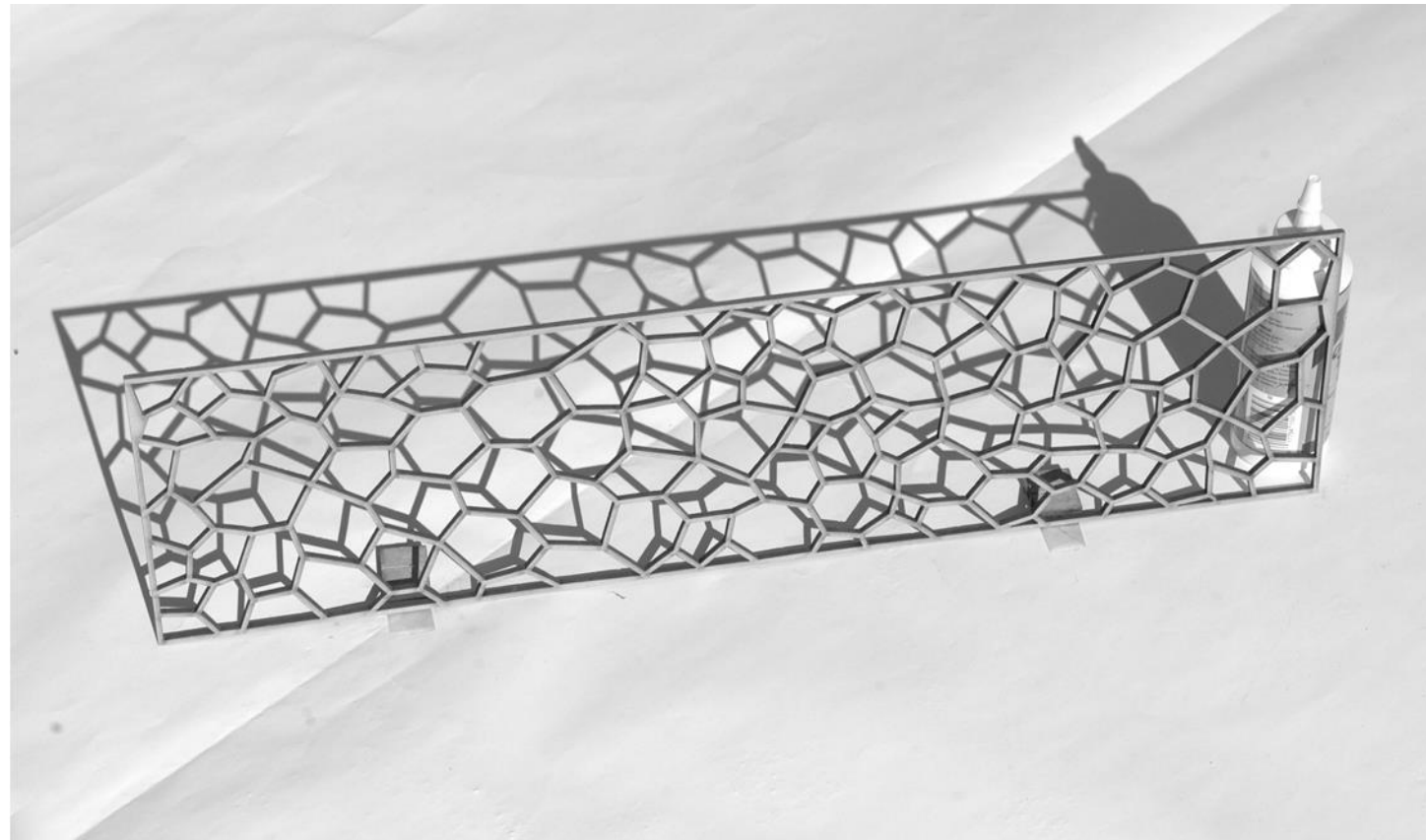

Model of screen

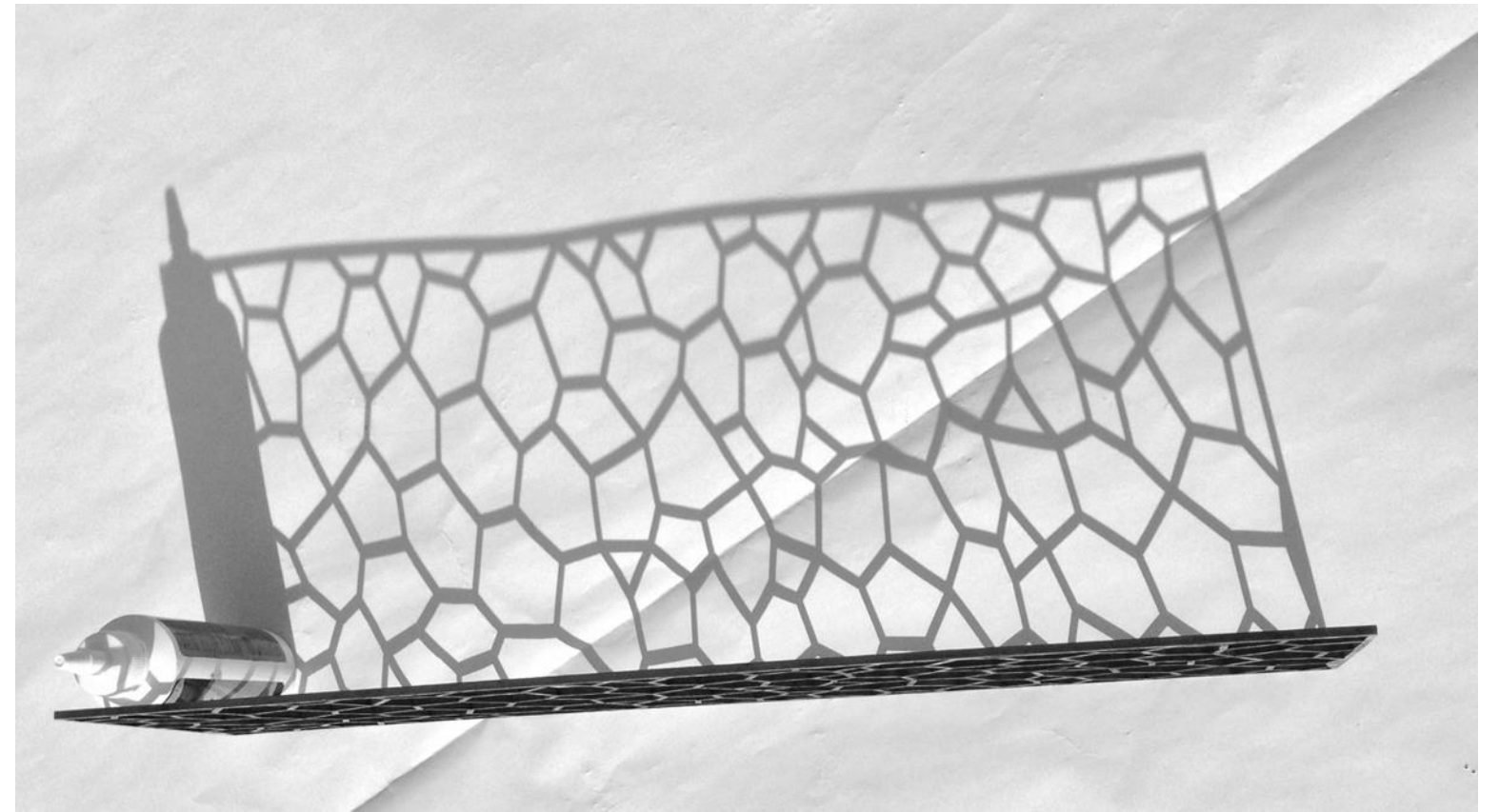

Effect of shade

## SCREEN WITH SHARP CORNERS

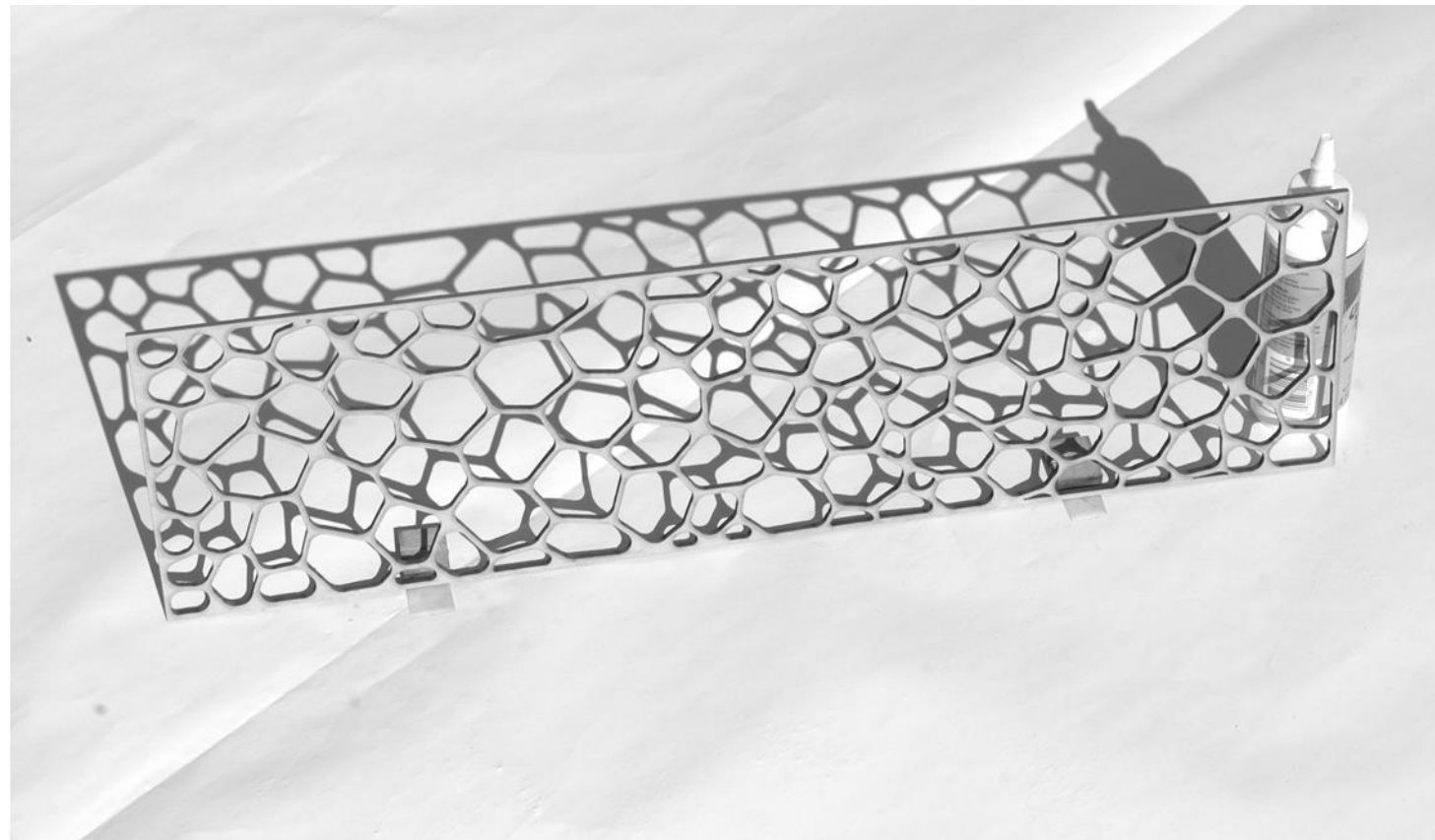

Model of screen

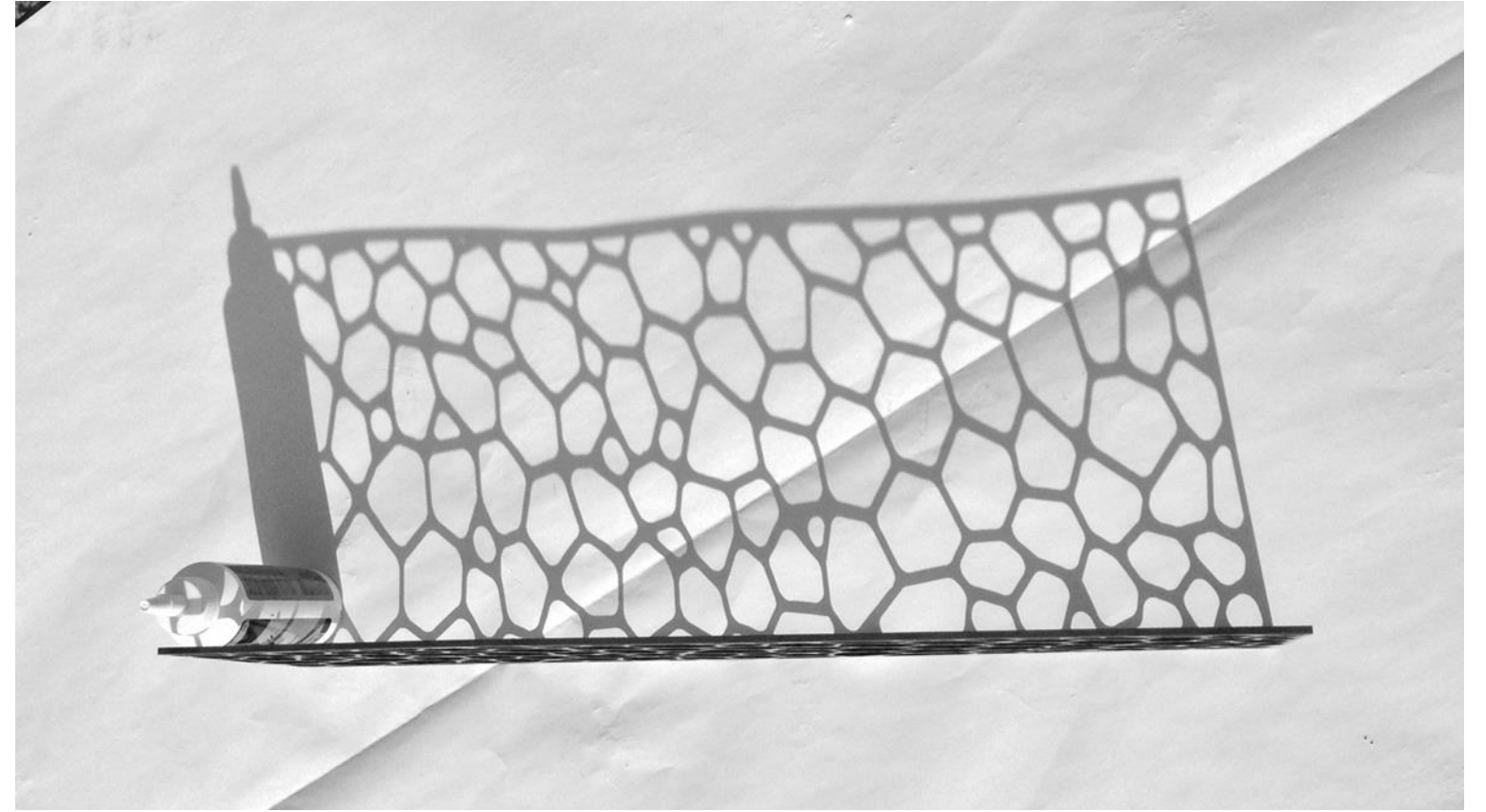

Effect of shade

## SCREEN WITH SOFT CORNERS



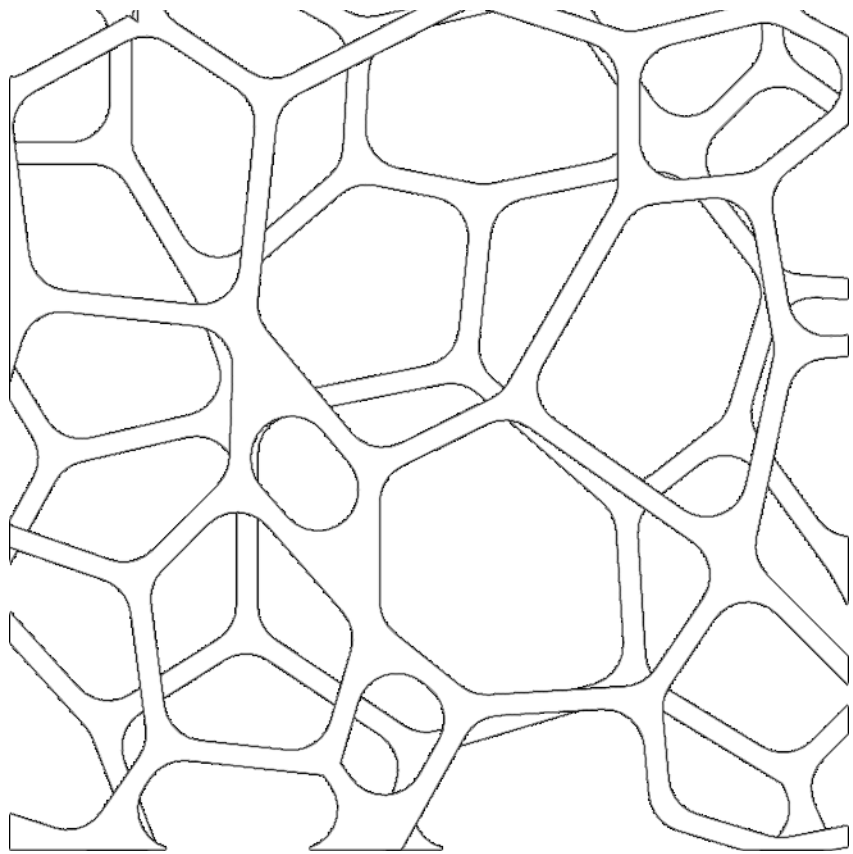
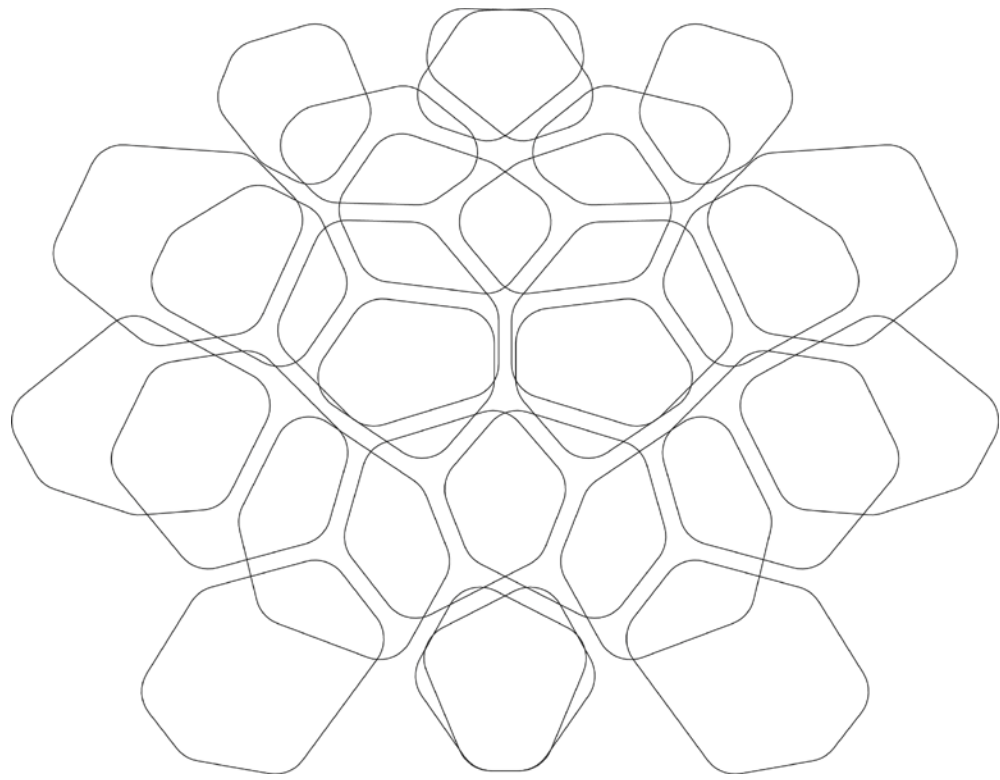

Multiple layers of soft corners





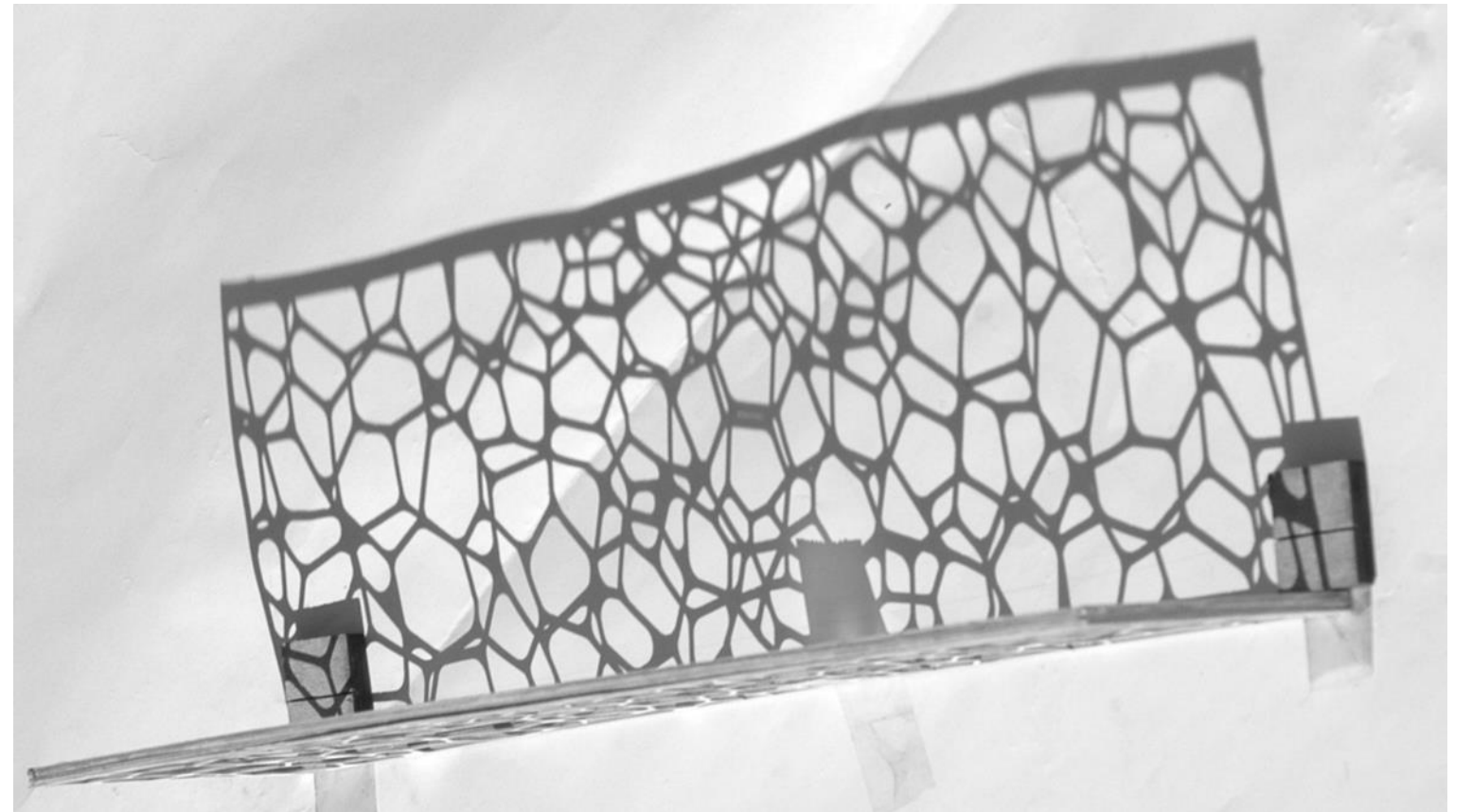
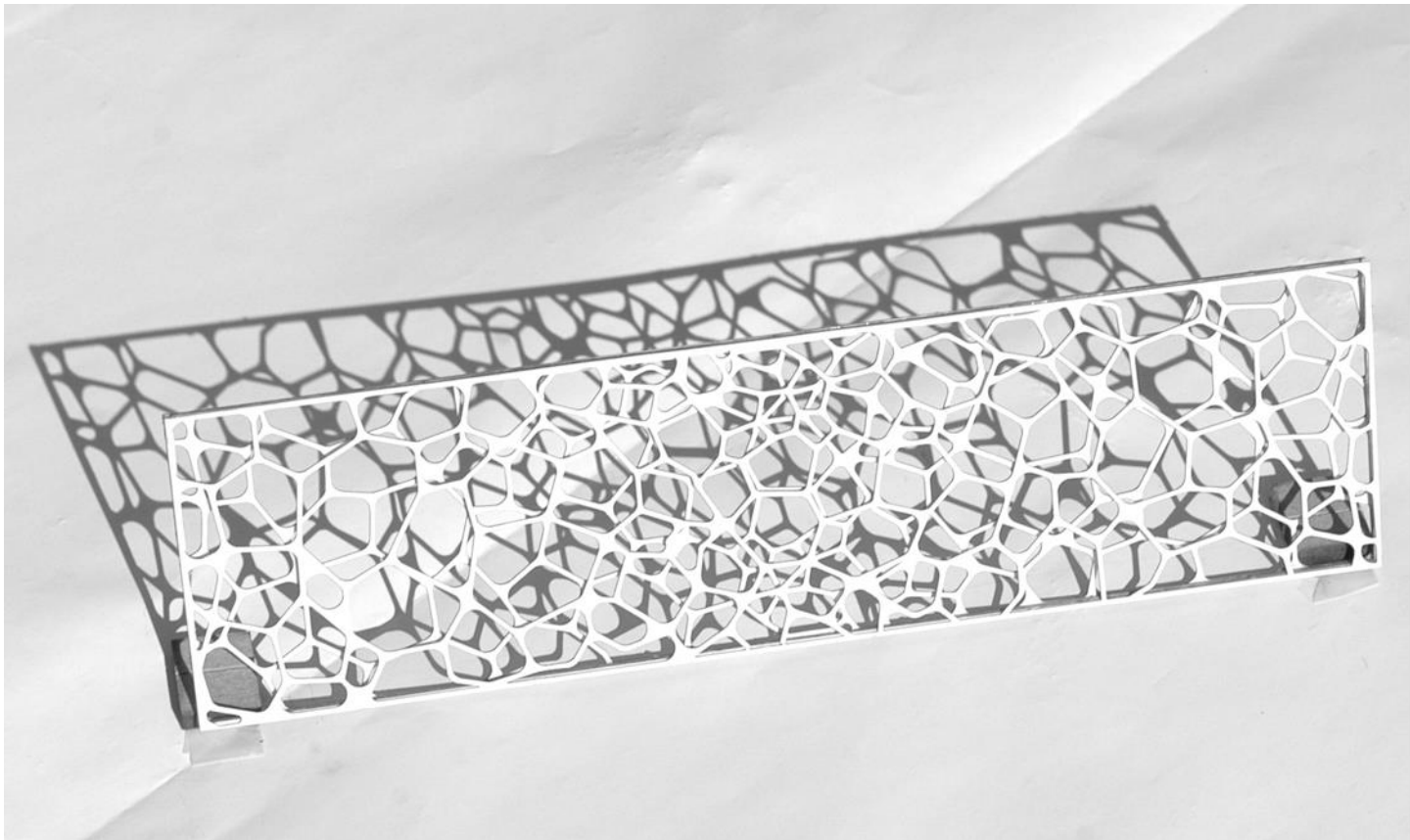
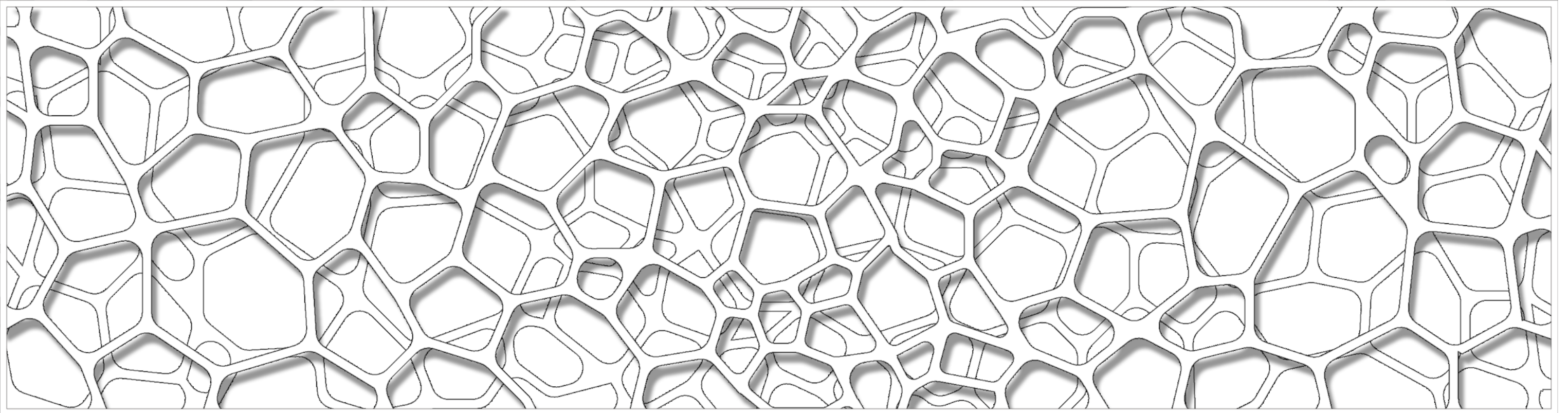

Multiple layers of soft corners



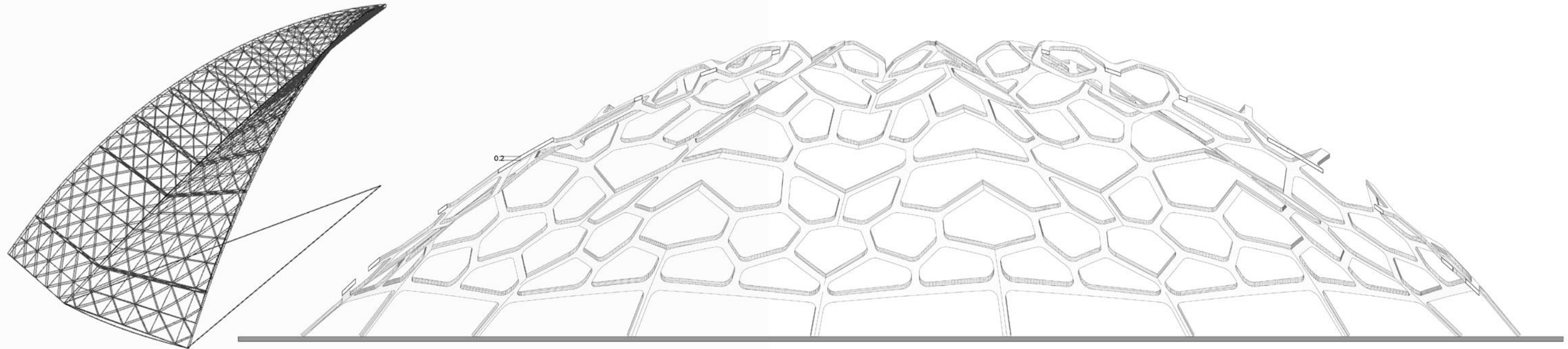

Constant thicknesses with rotation around an axis

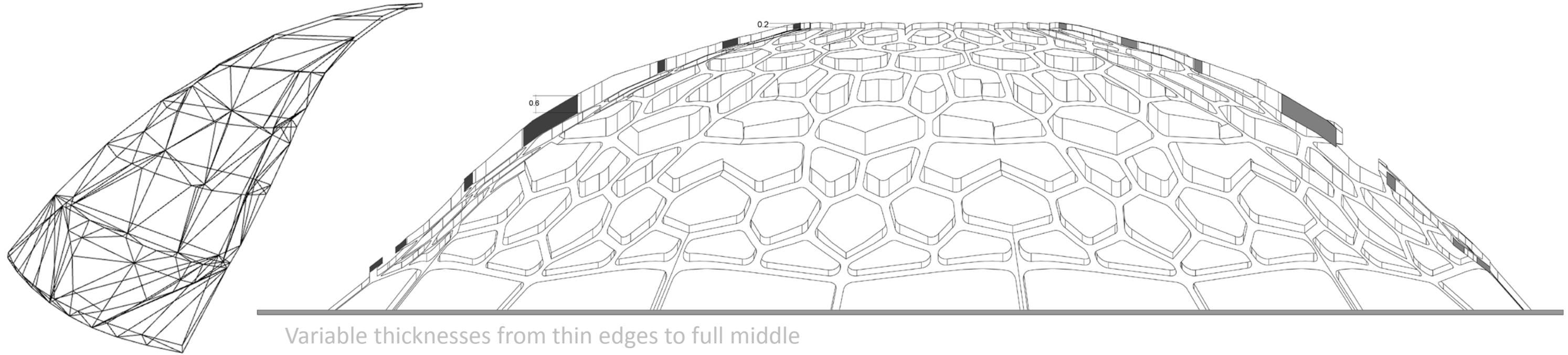

Variable thicknesses from thin edges to full middle

## DOMICAL FORM AND PATTERN

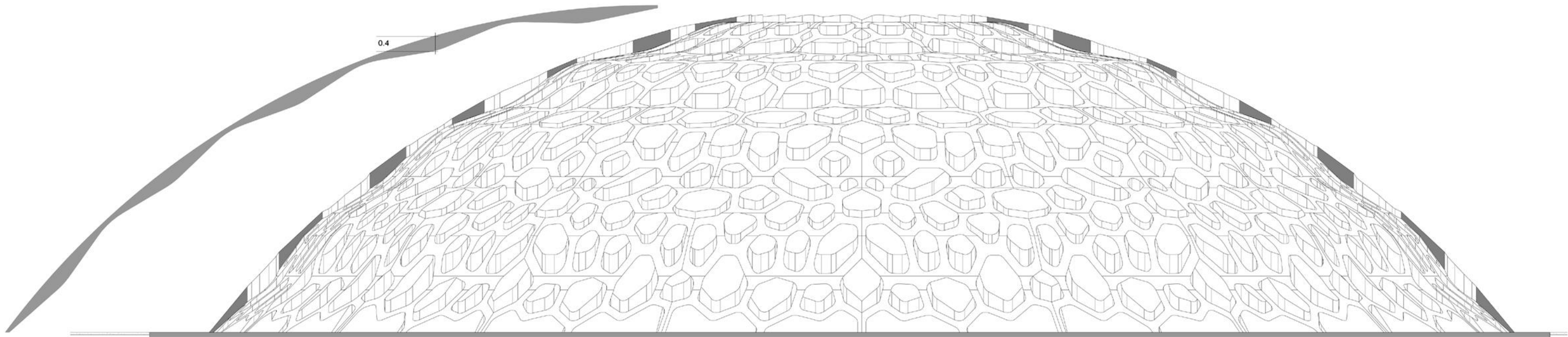

Full thicknesses at intersections

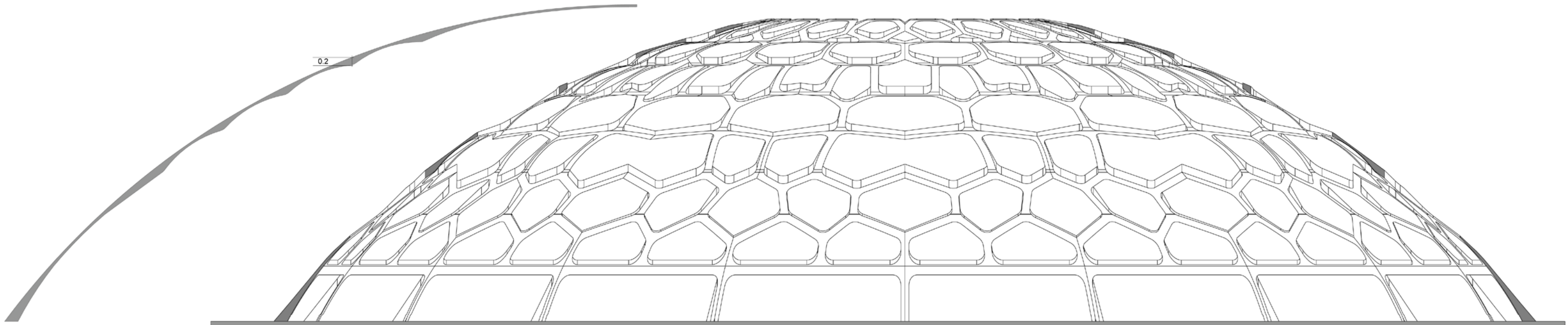

Full thinness at intersections

## DOMICAL FORM AND PATTERN



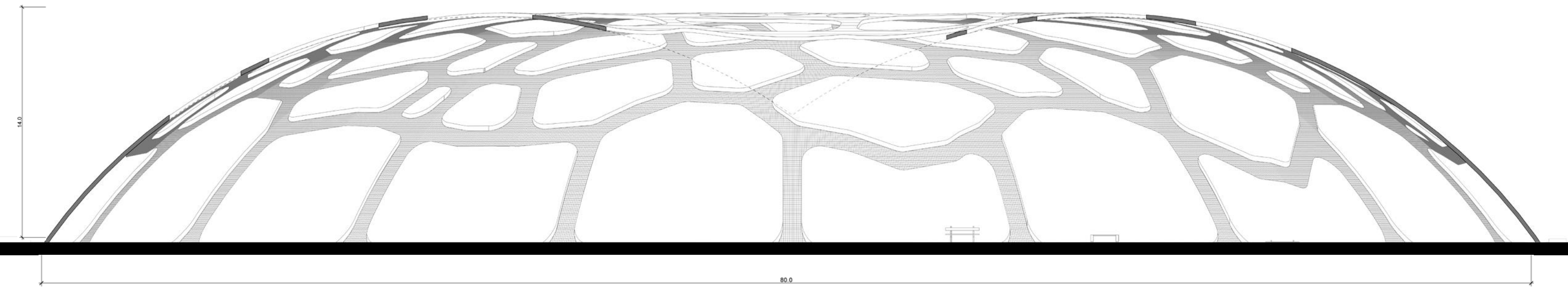

Flat pattern in domical shape (non structural)

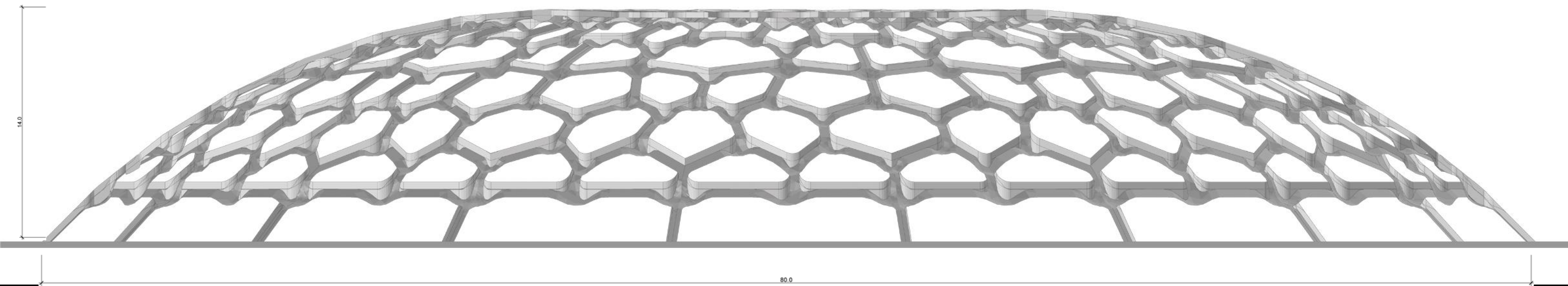

Rectilinear shaped members in domical shape (becoming structure)

## DOMICAL SHAPE SECTIONS

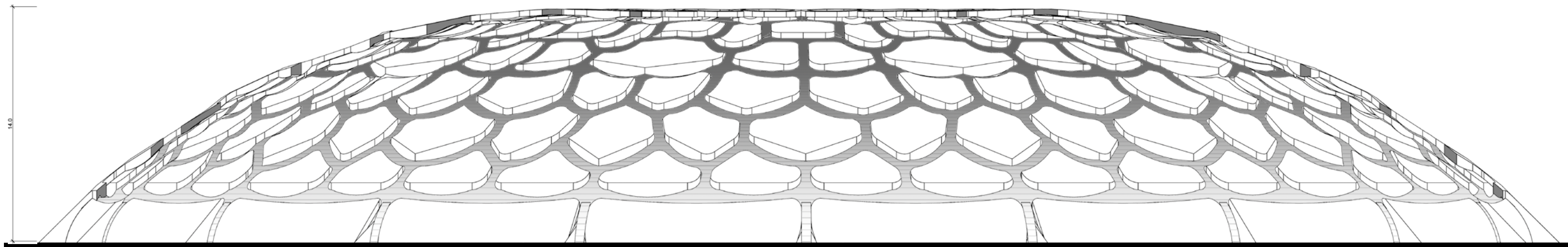

Rectilinear members in domical shape

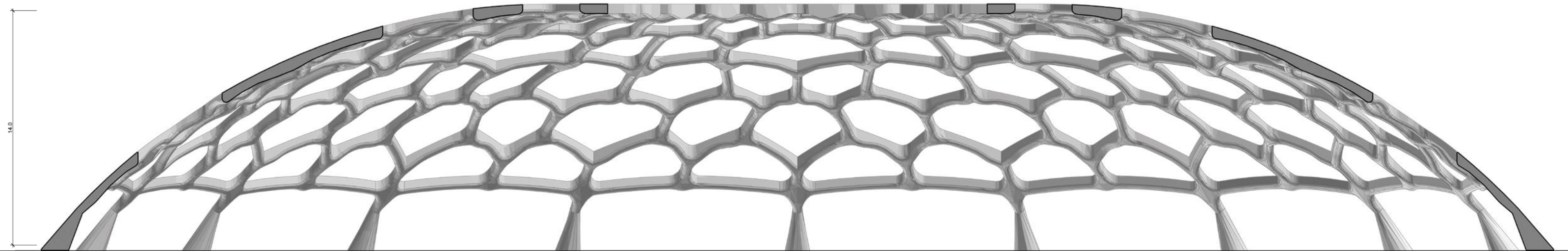

Softened rectilinear members

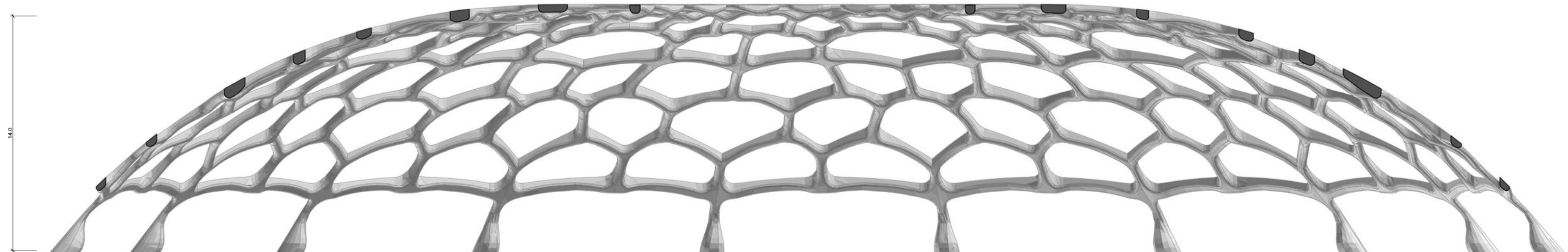

Smooth members



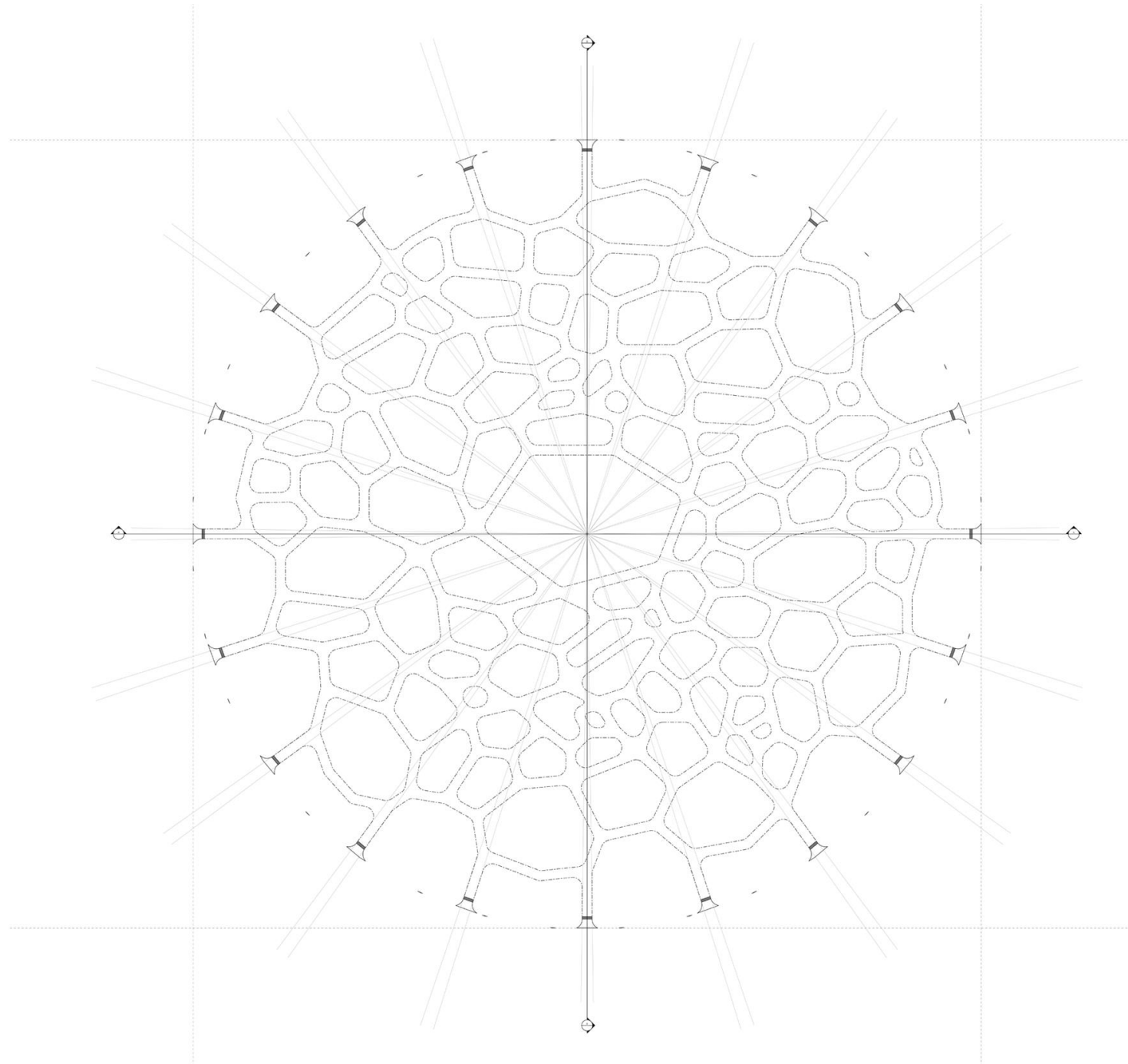

Plan of Dome with random organic patterns

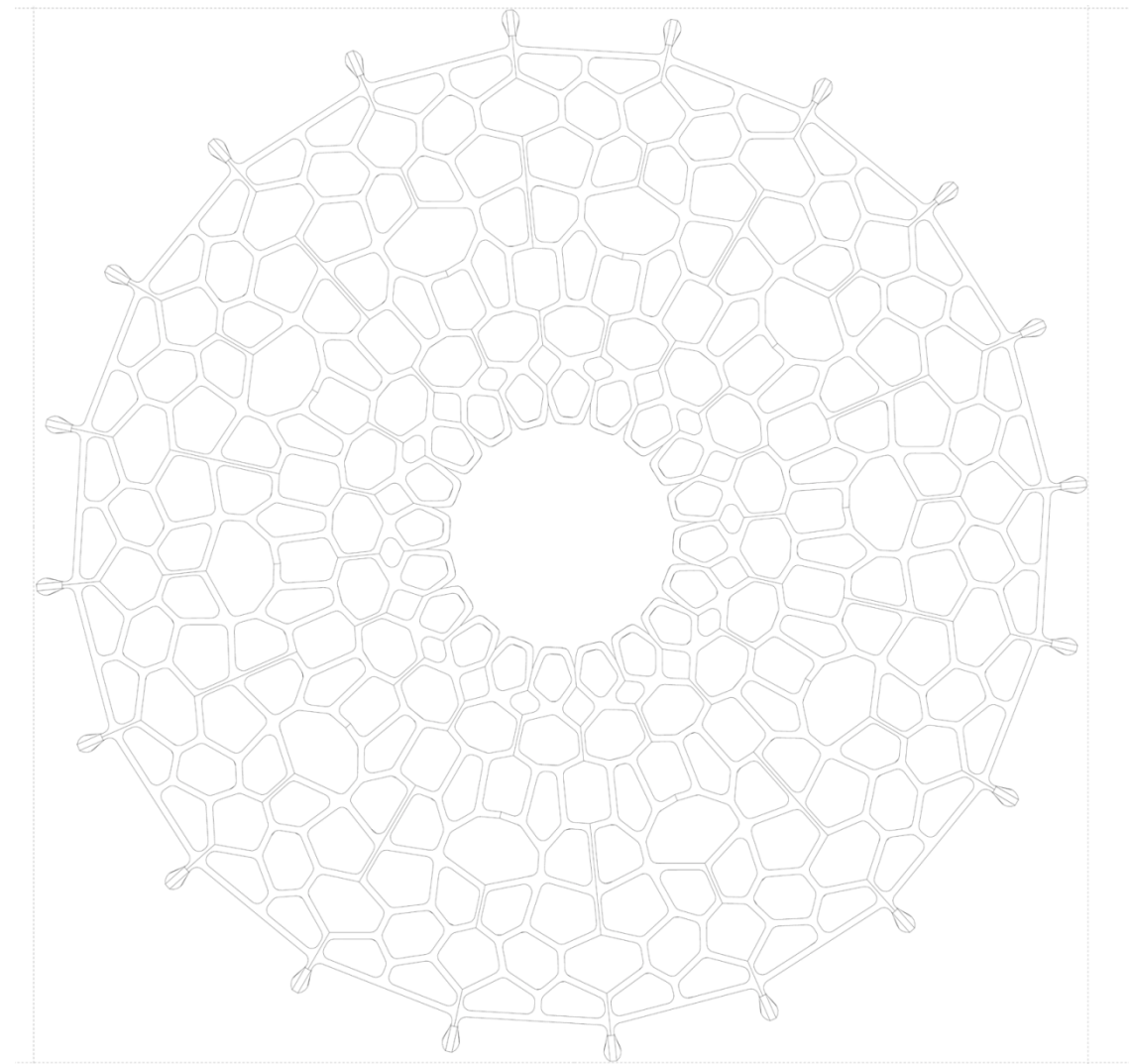

Plan of Dome with irregular patterns becoming structural and material

## PLANS OF DOMICAL SHAPE



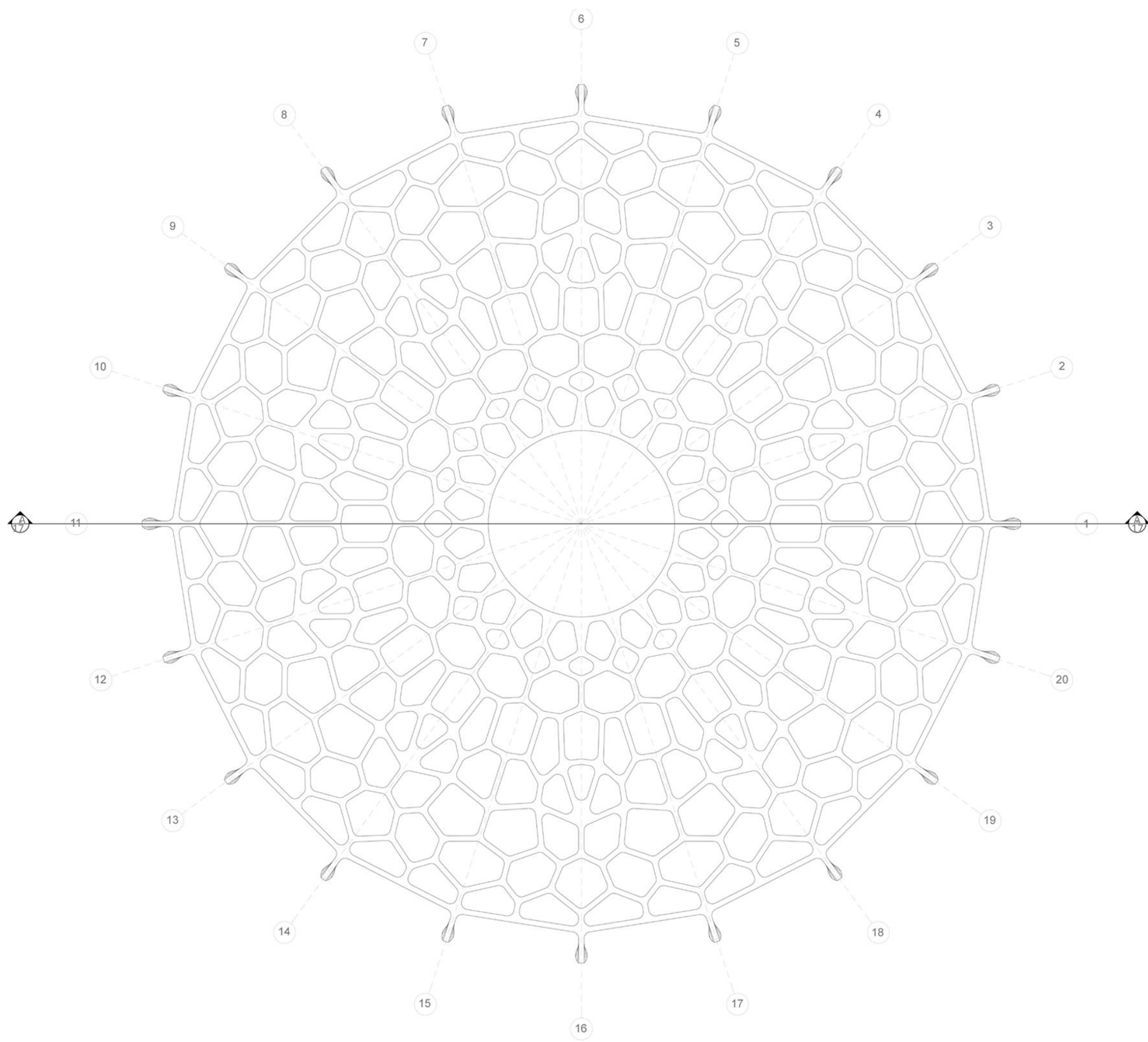

Plan of Dome as structure in Pre-Cast concrete

11 10 9 8 7 6 5 4 3 2 1

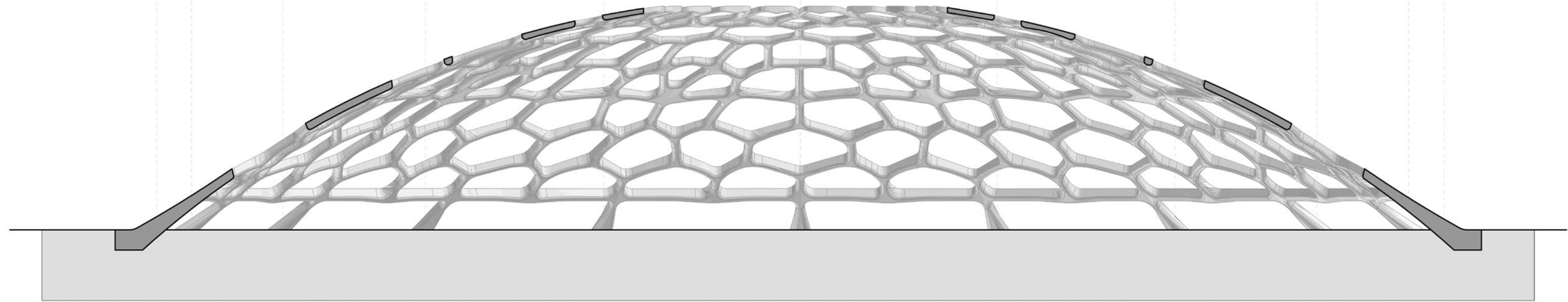

SECTION A-A

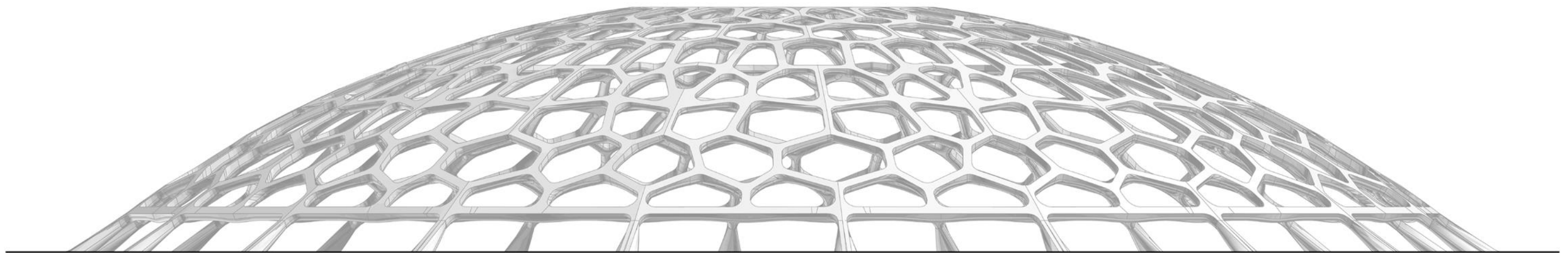

ELEVATION





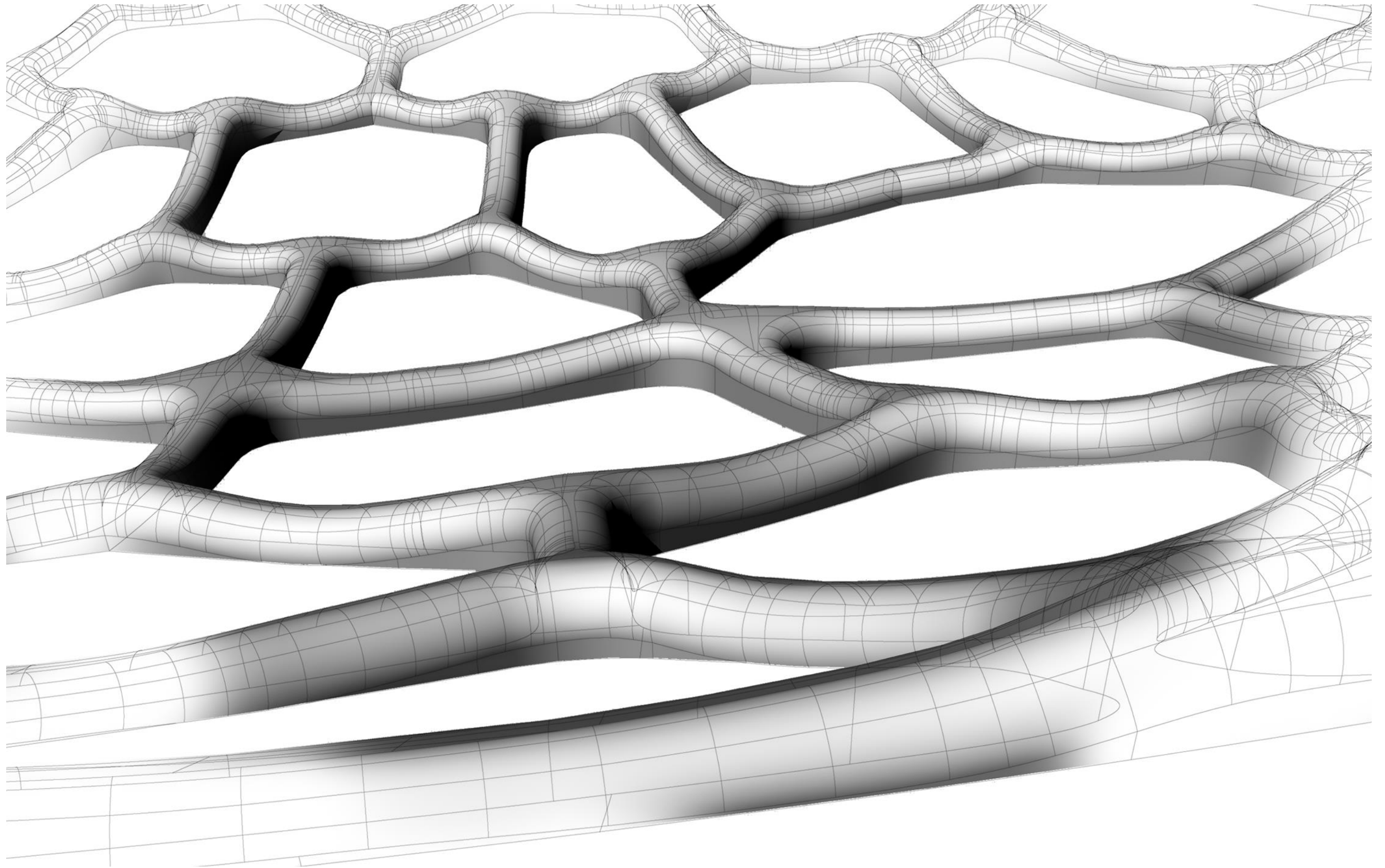
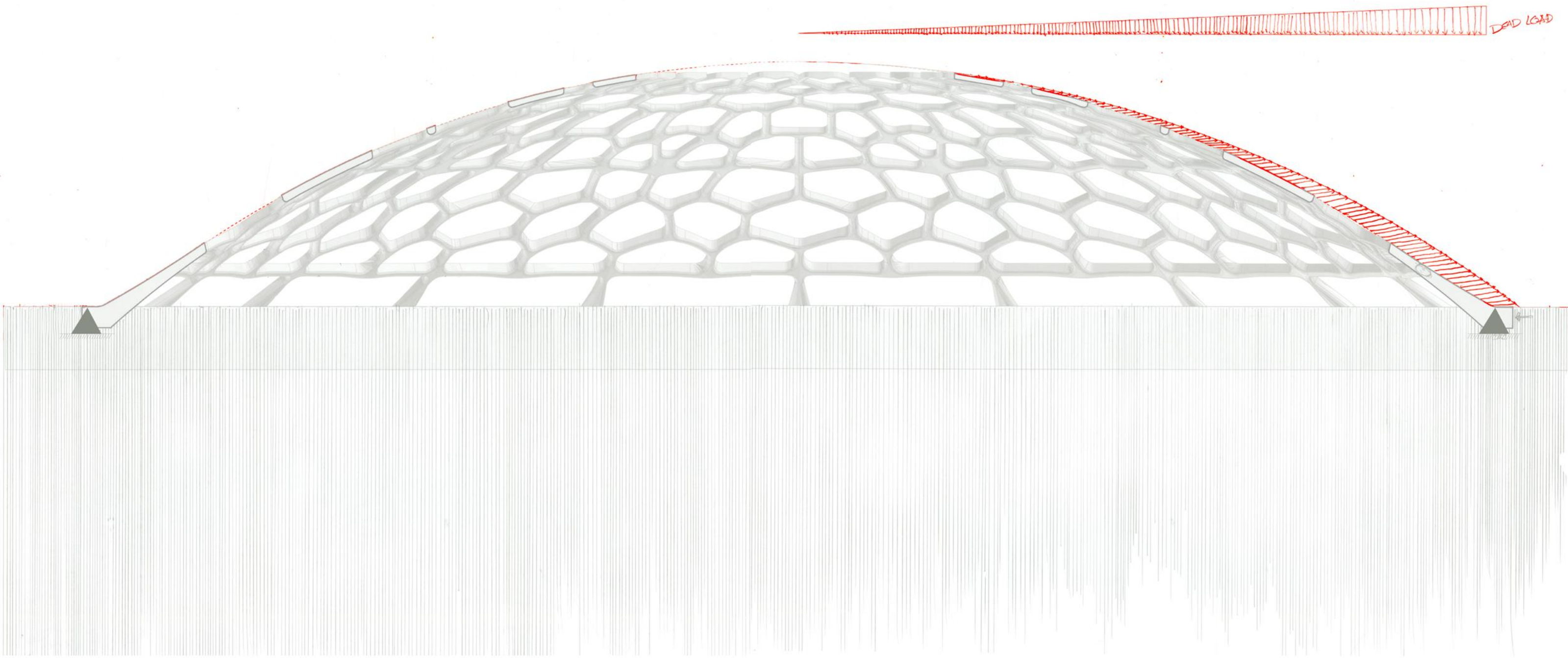
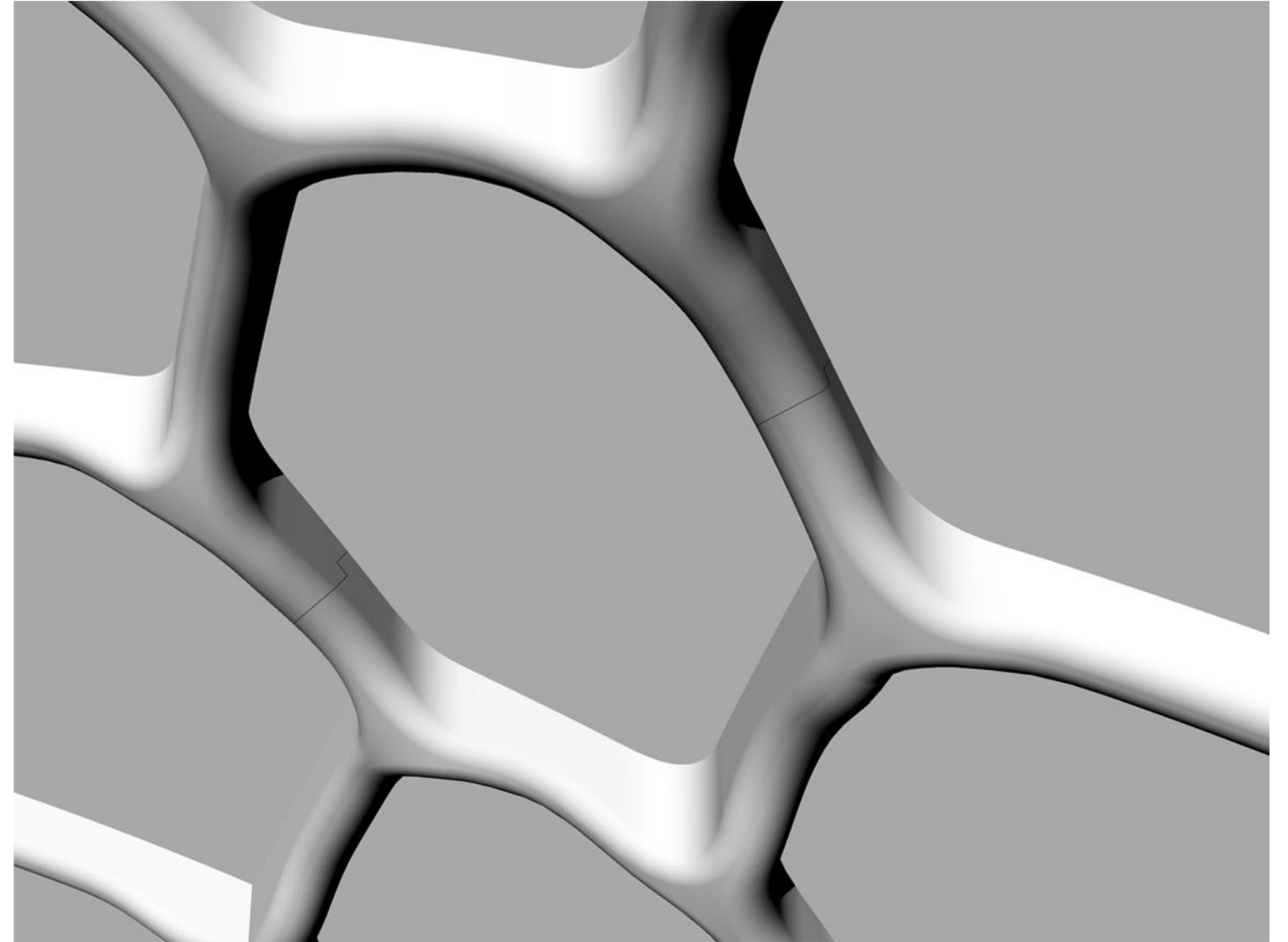
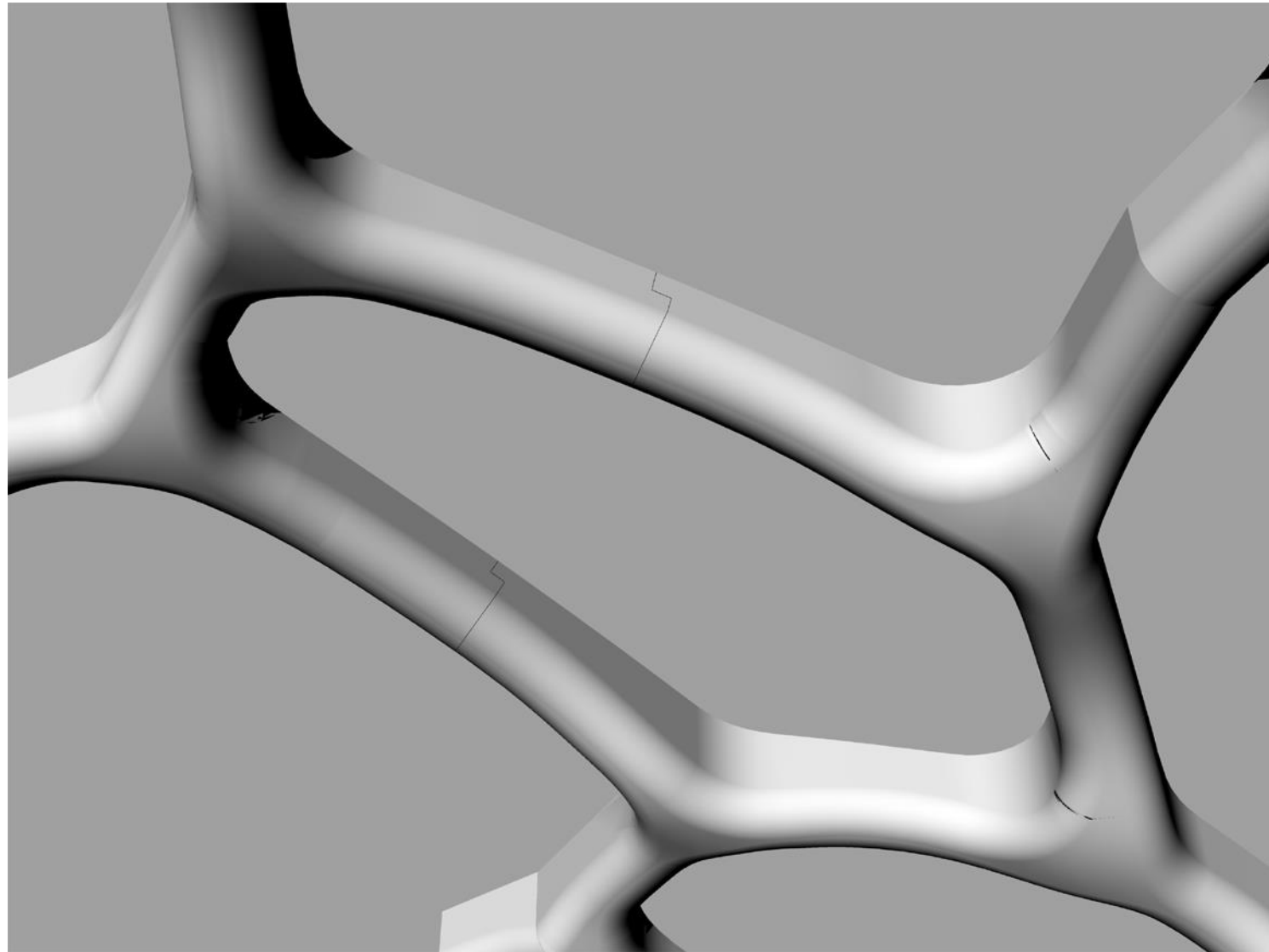

DIAGRAM OF BEAM THICKNESS



Section Load Diagram



Joining of Pre-Cast beams



Sections in mutable points

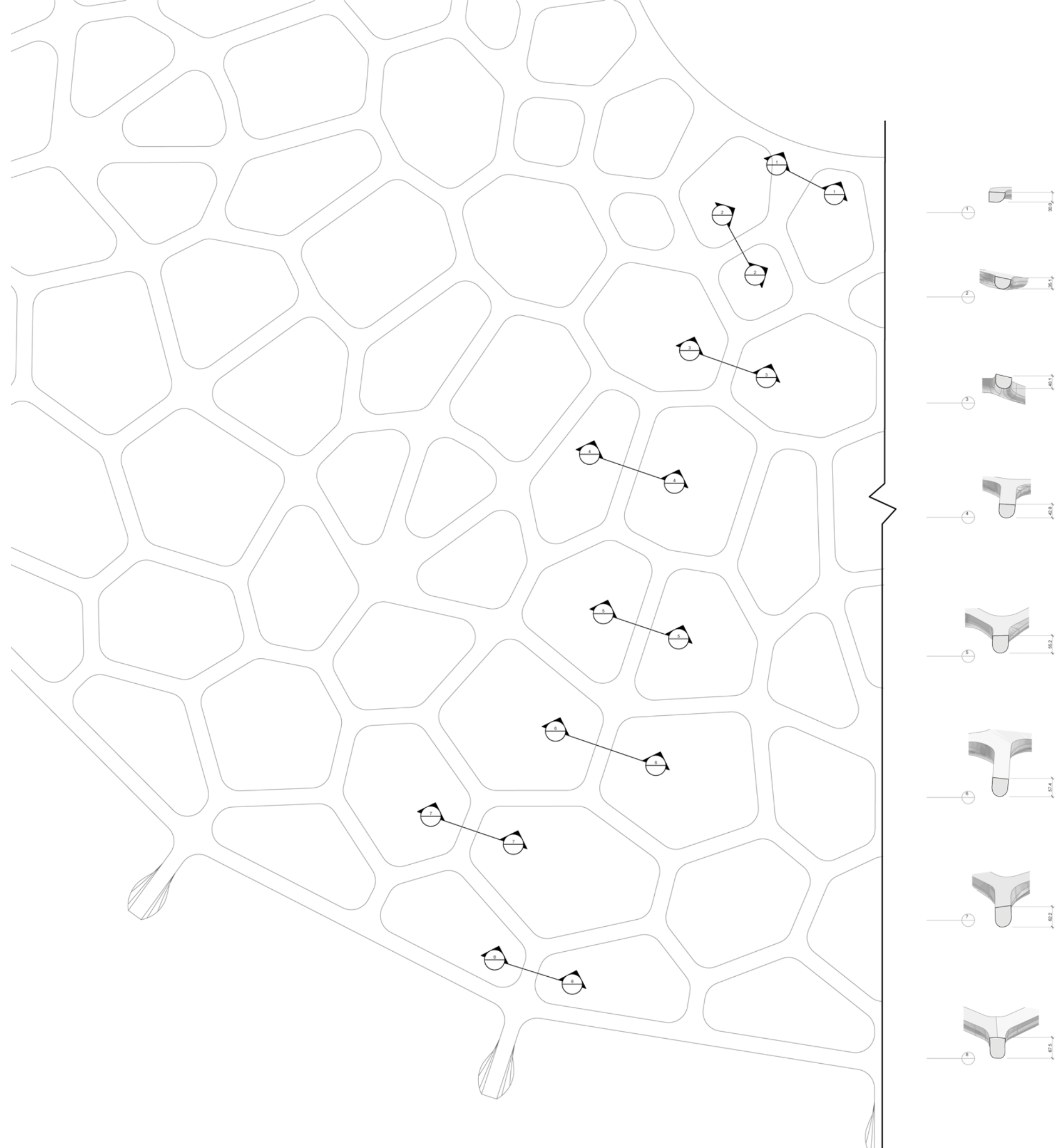

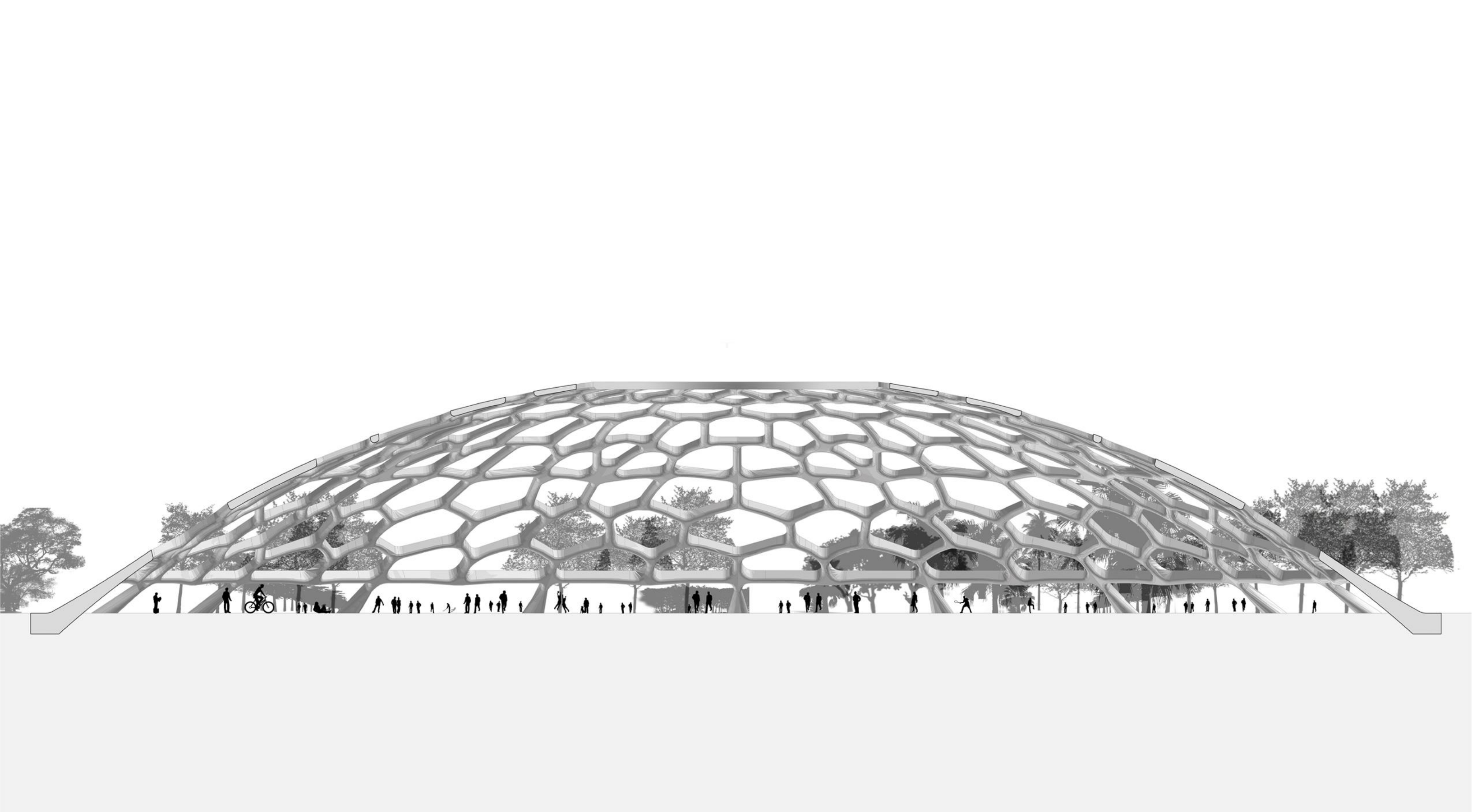

Section of Domical Form structure

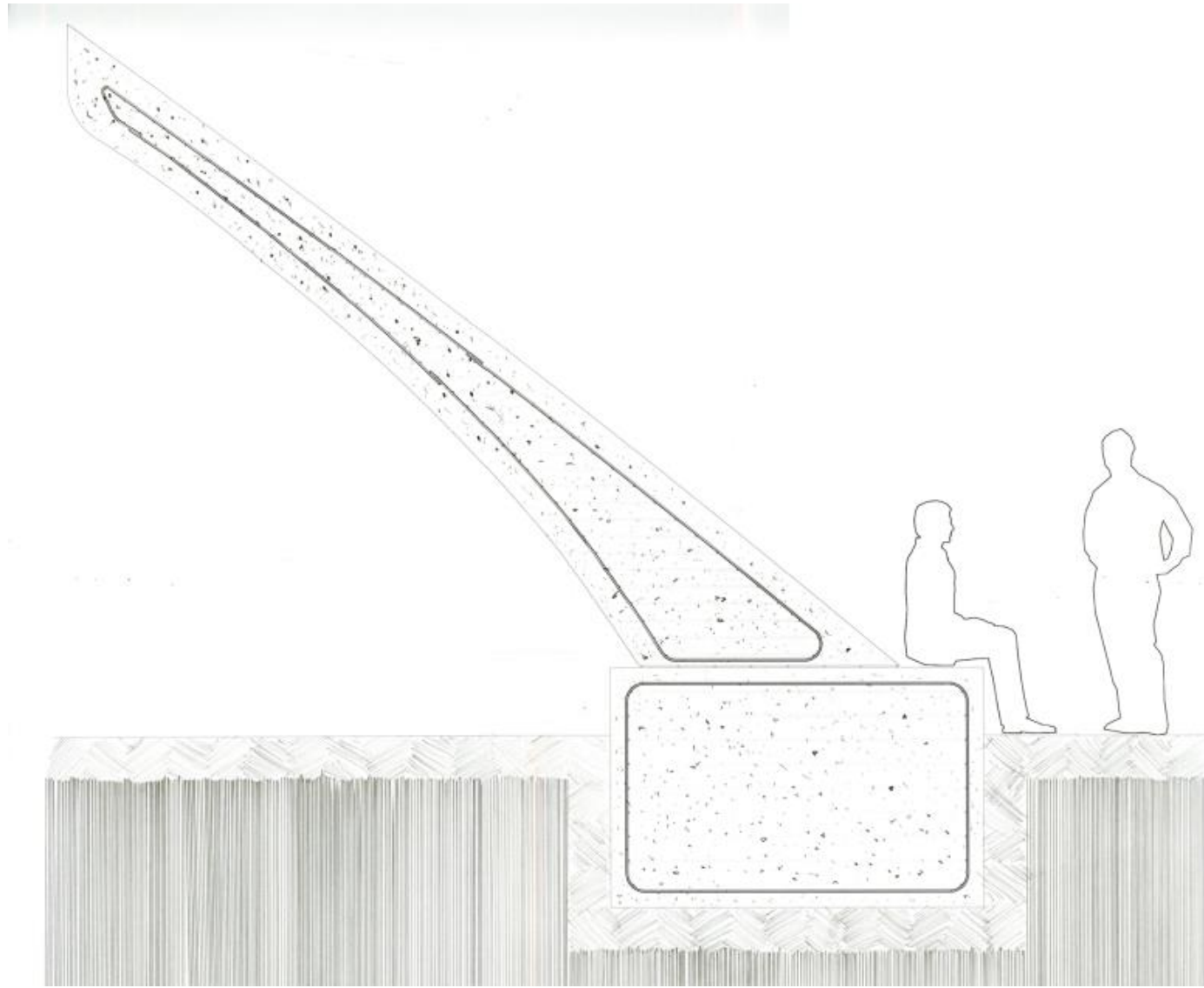

Cast-in-place concrete



Cast-in-place foundation with pre-cast beams

## FOUNDATION

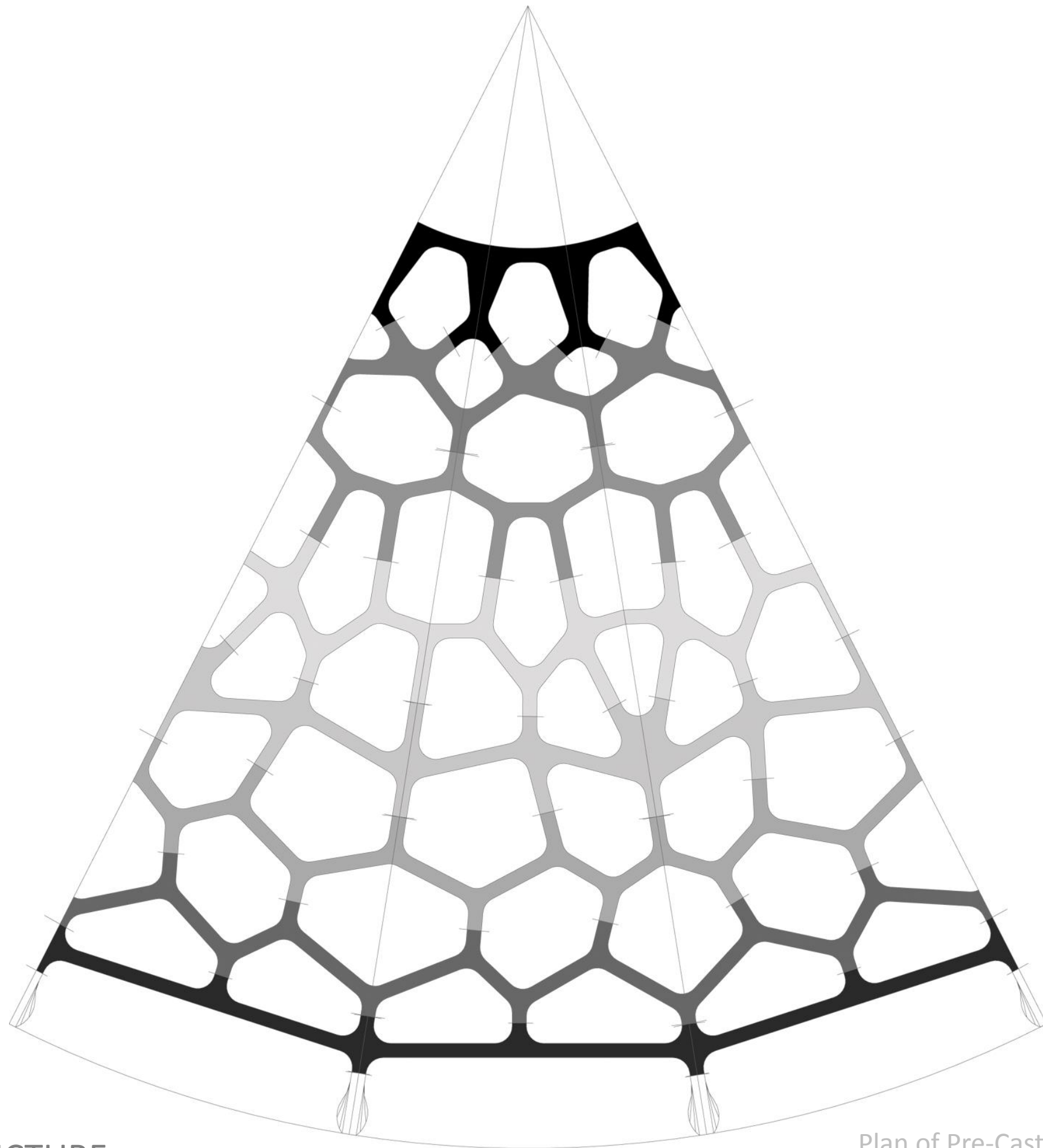

STRUCTURE

Plan of Pre-Cast beams

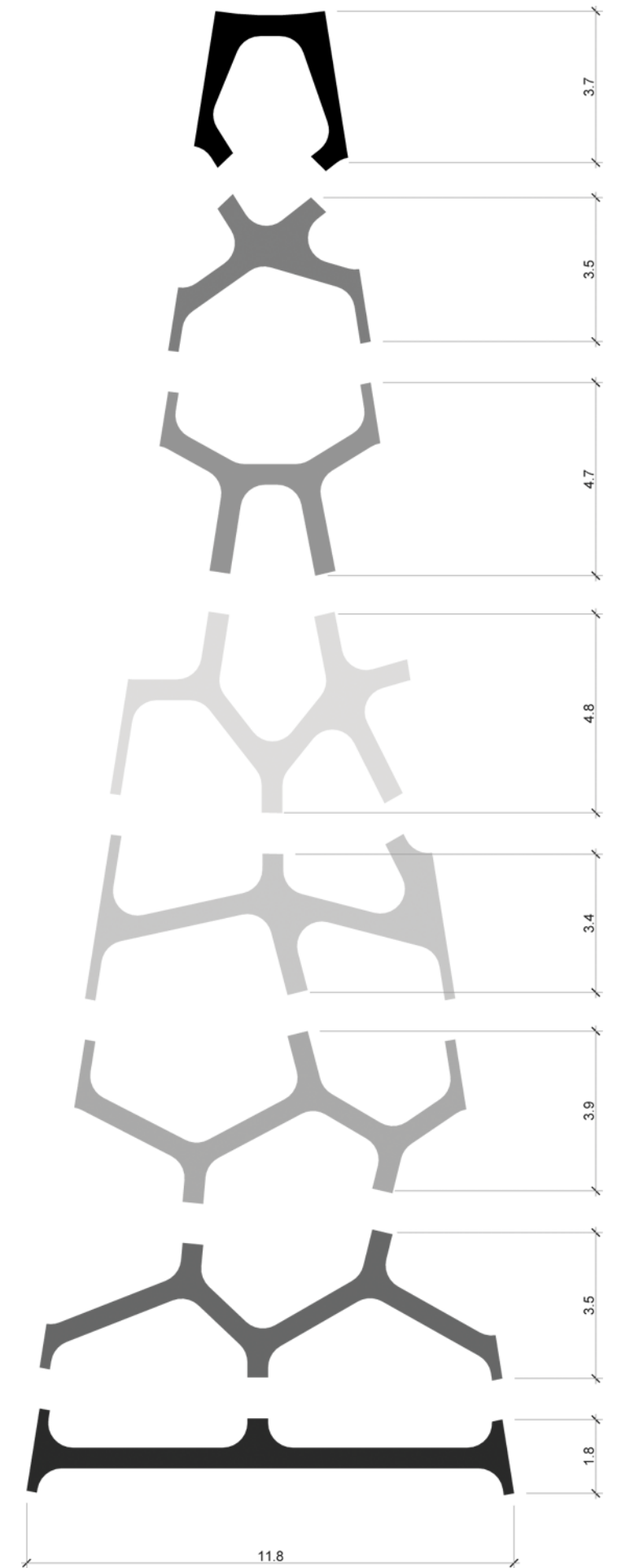



Section

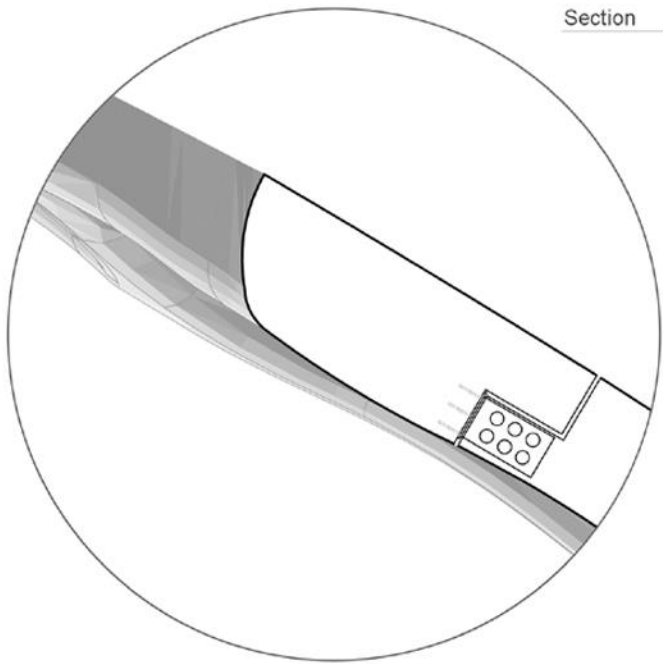

Section

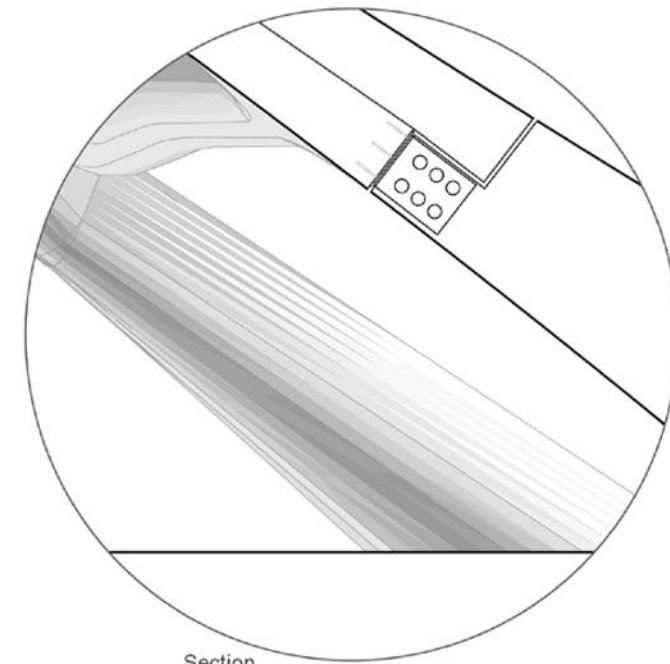

Plan

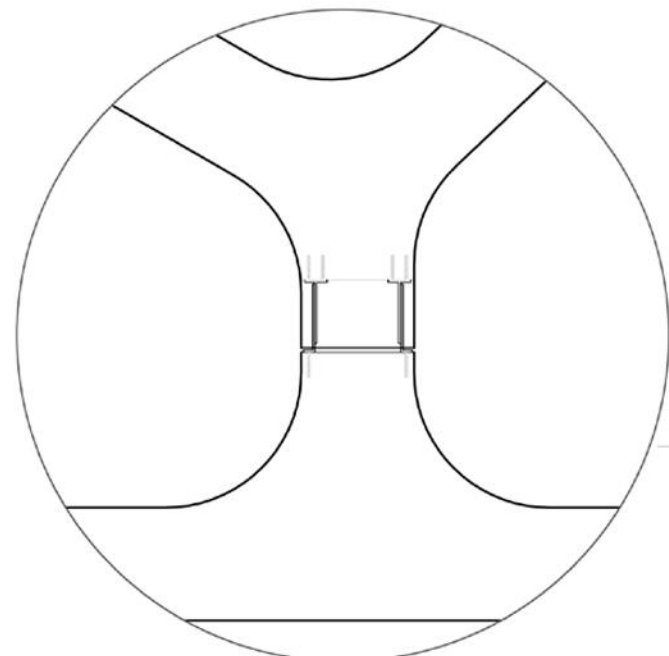

Axonometry

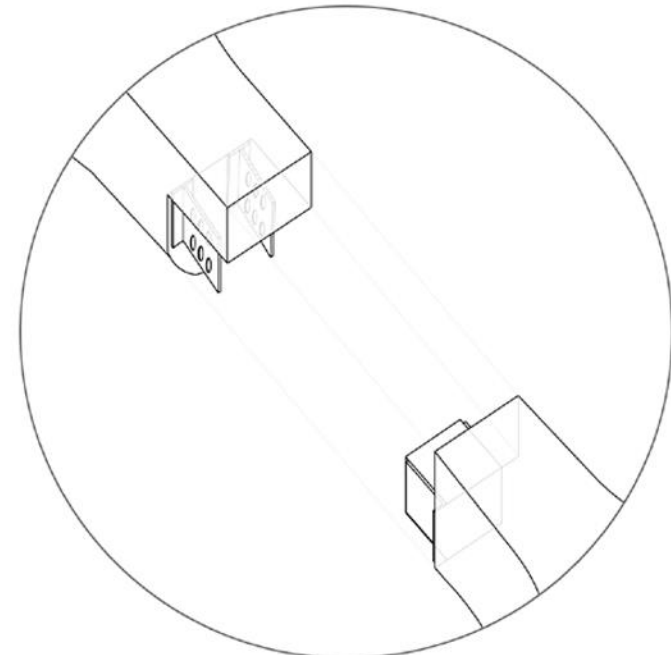

Axonometry

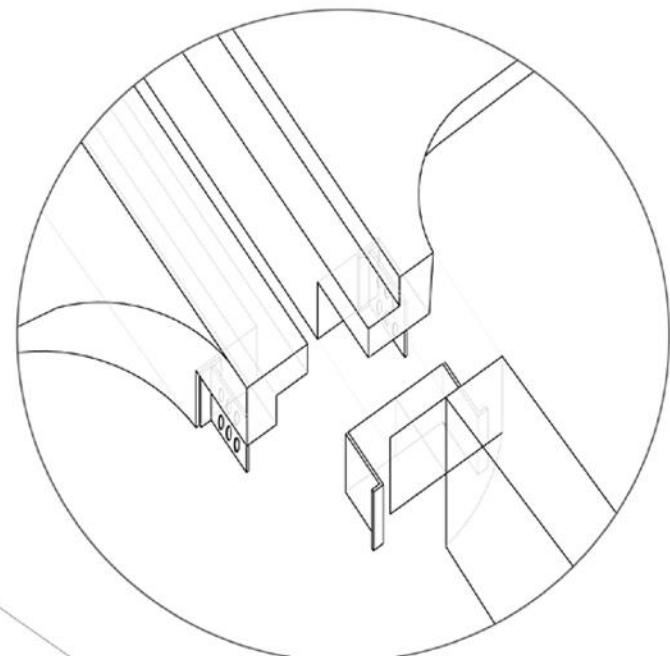

Plan

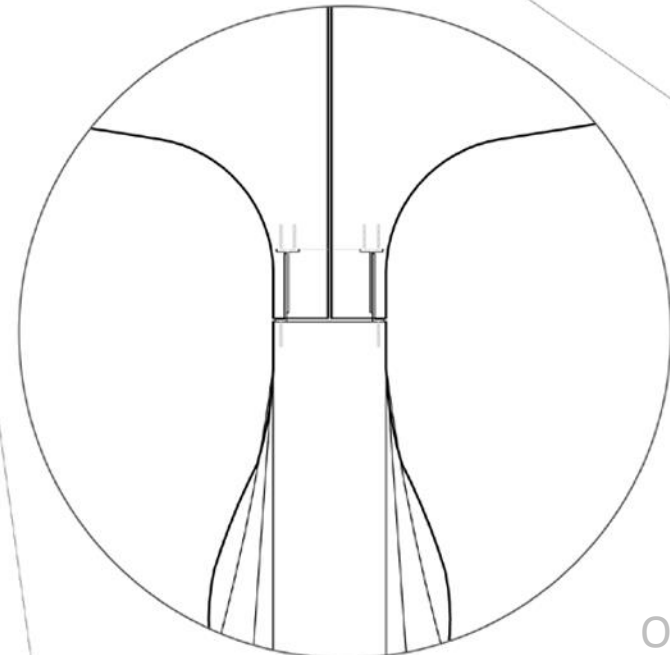

# DETAILS OF JOINTS

Overlapping the beams with the column and weld it.





1

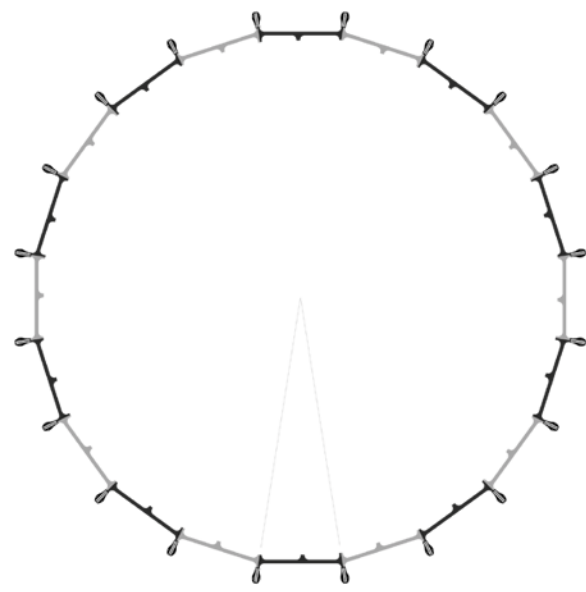

2

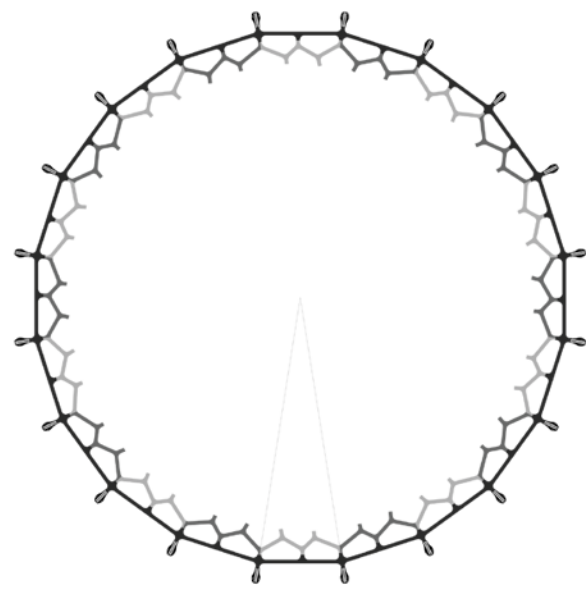

3

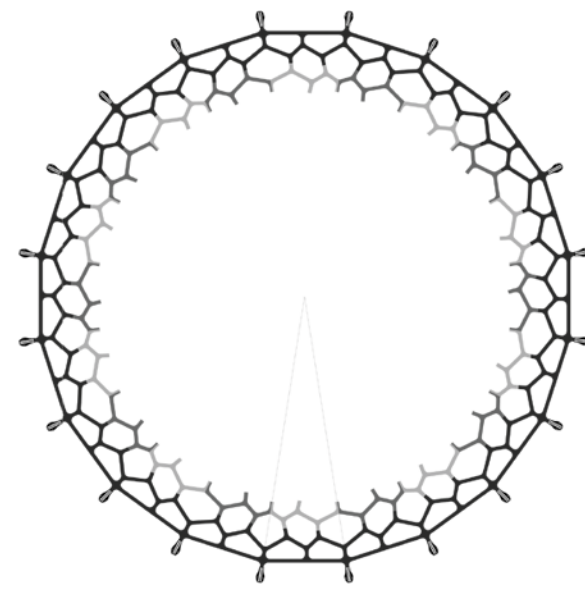

4

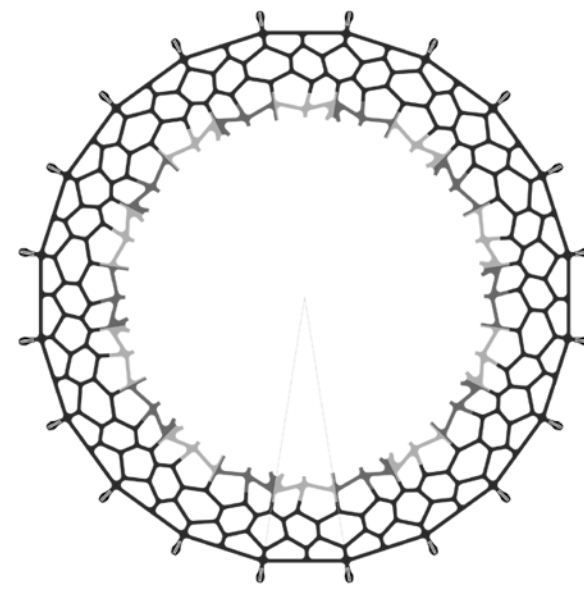

5

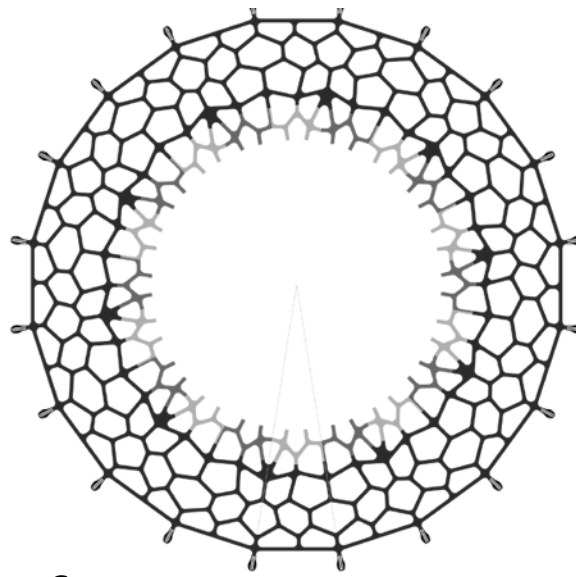

6

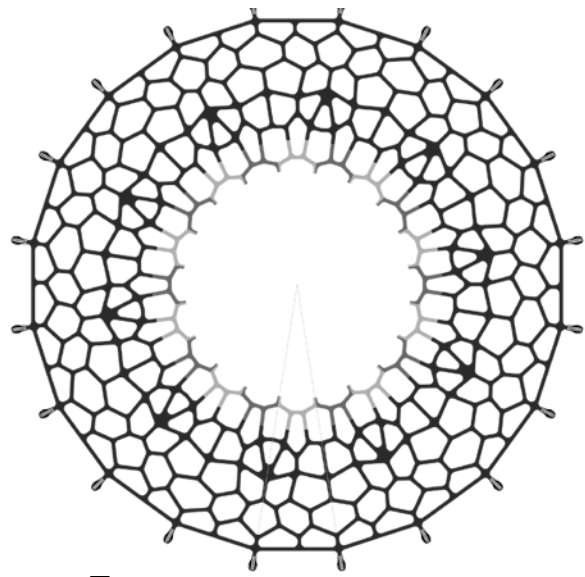

7

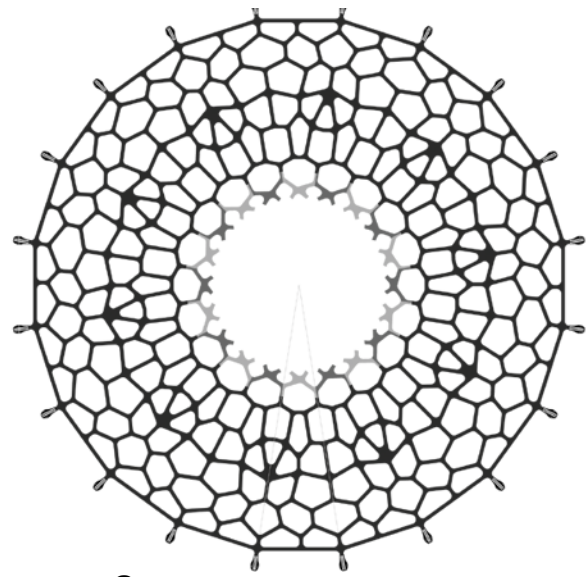

8

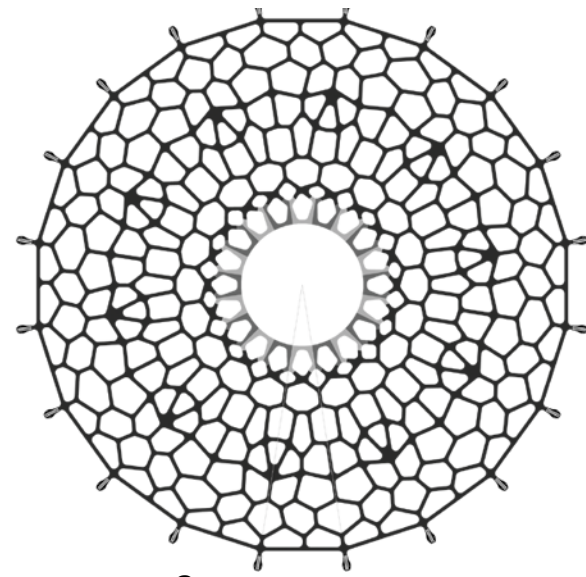

9

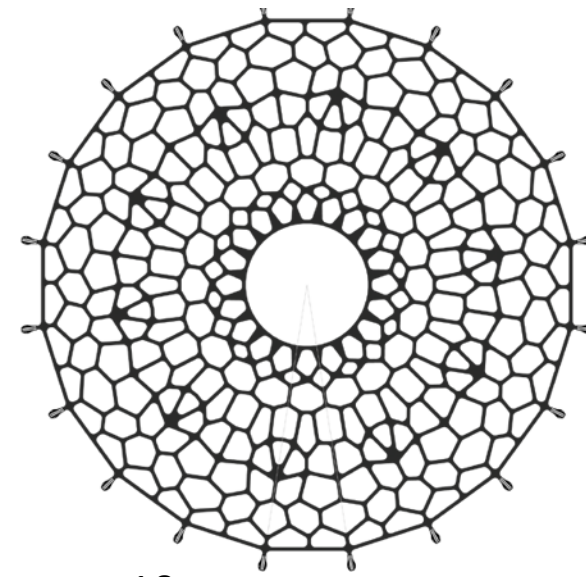

10

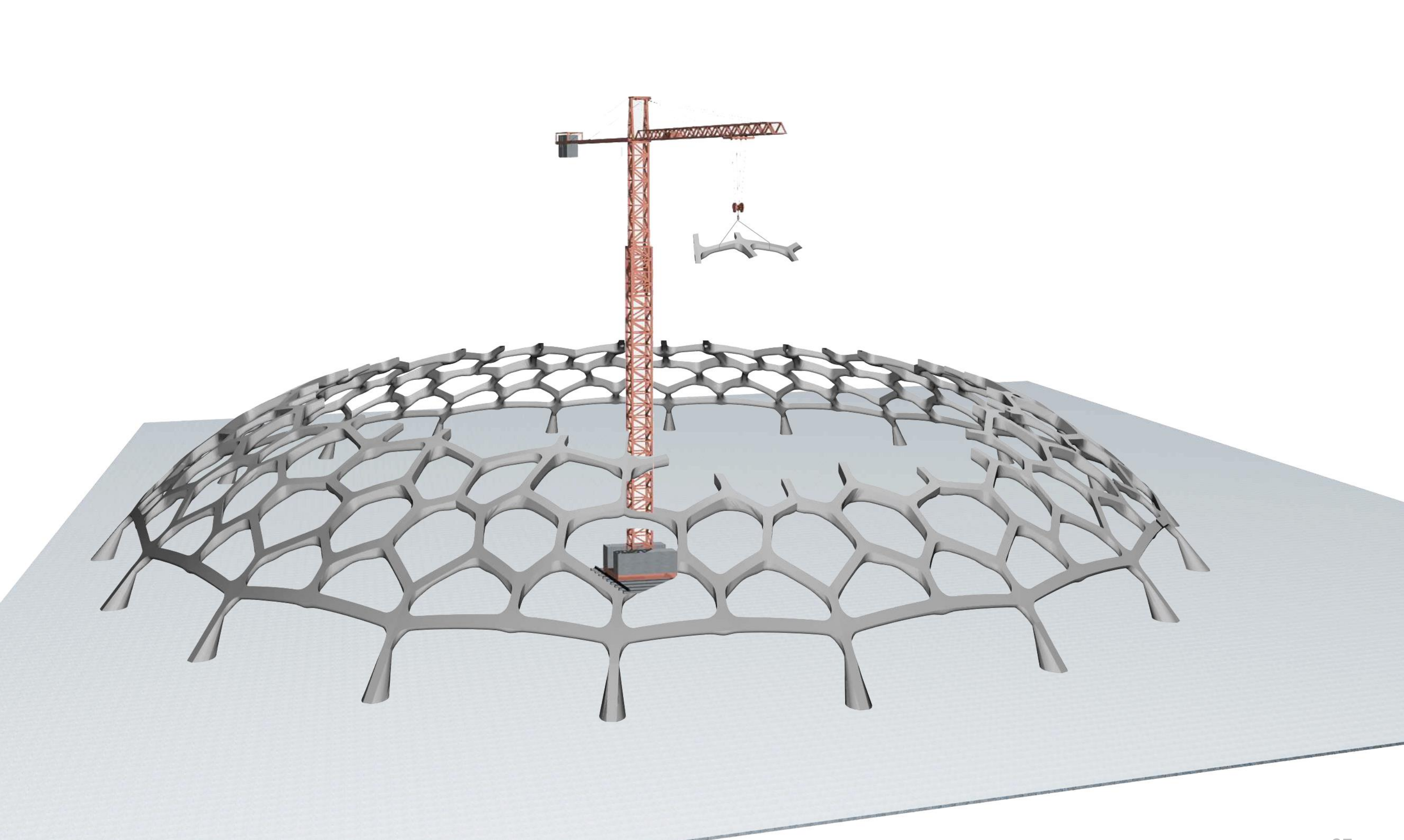

Dome under construction



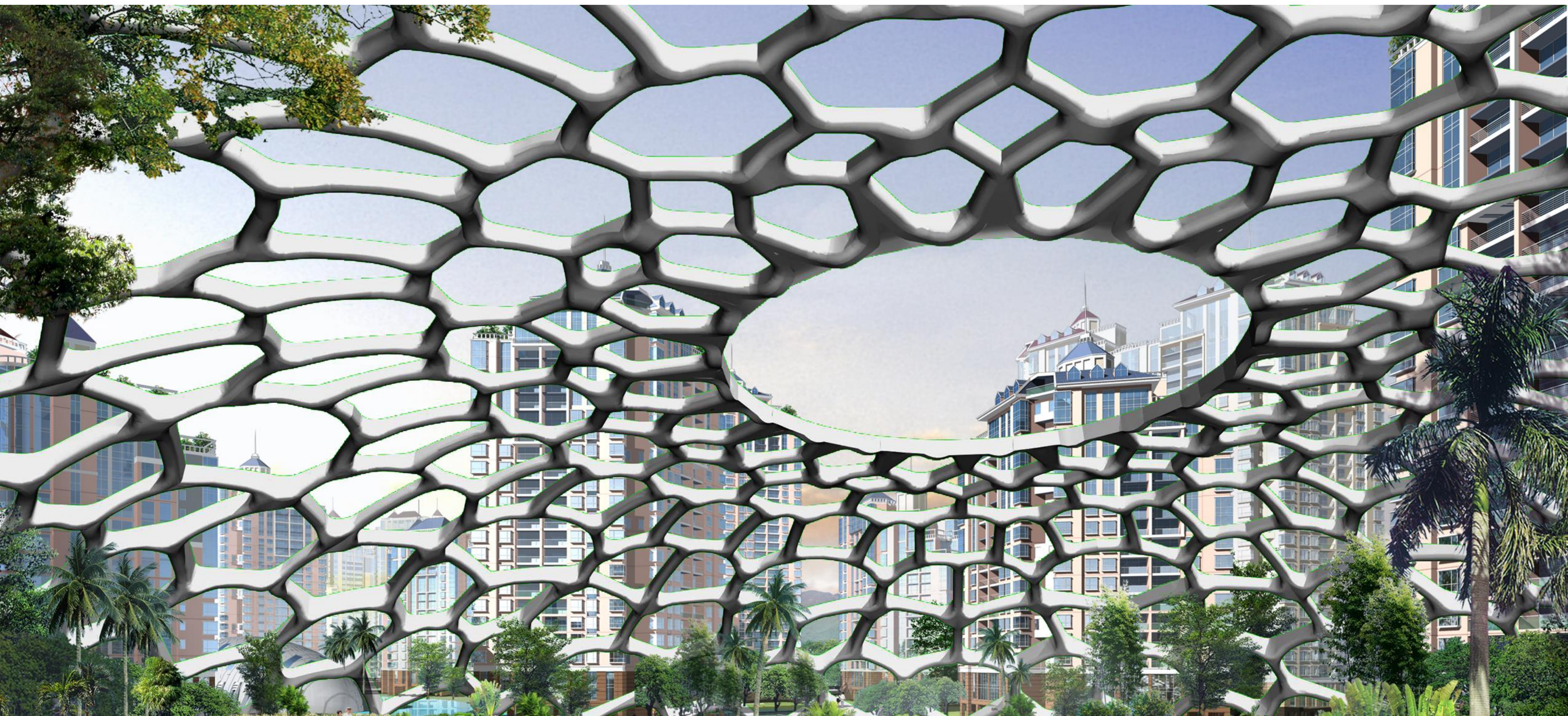



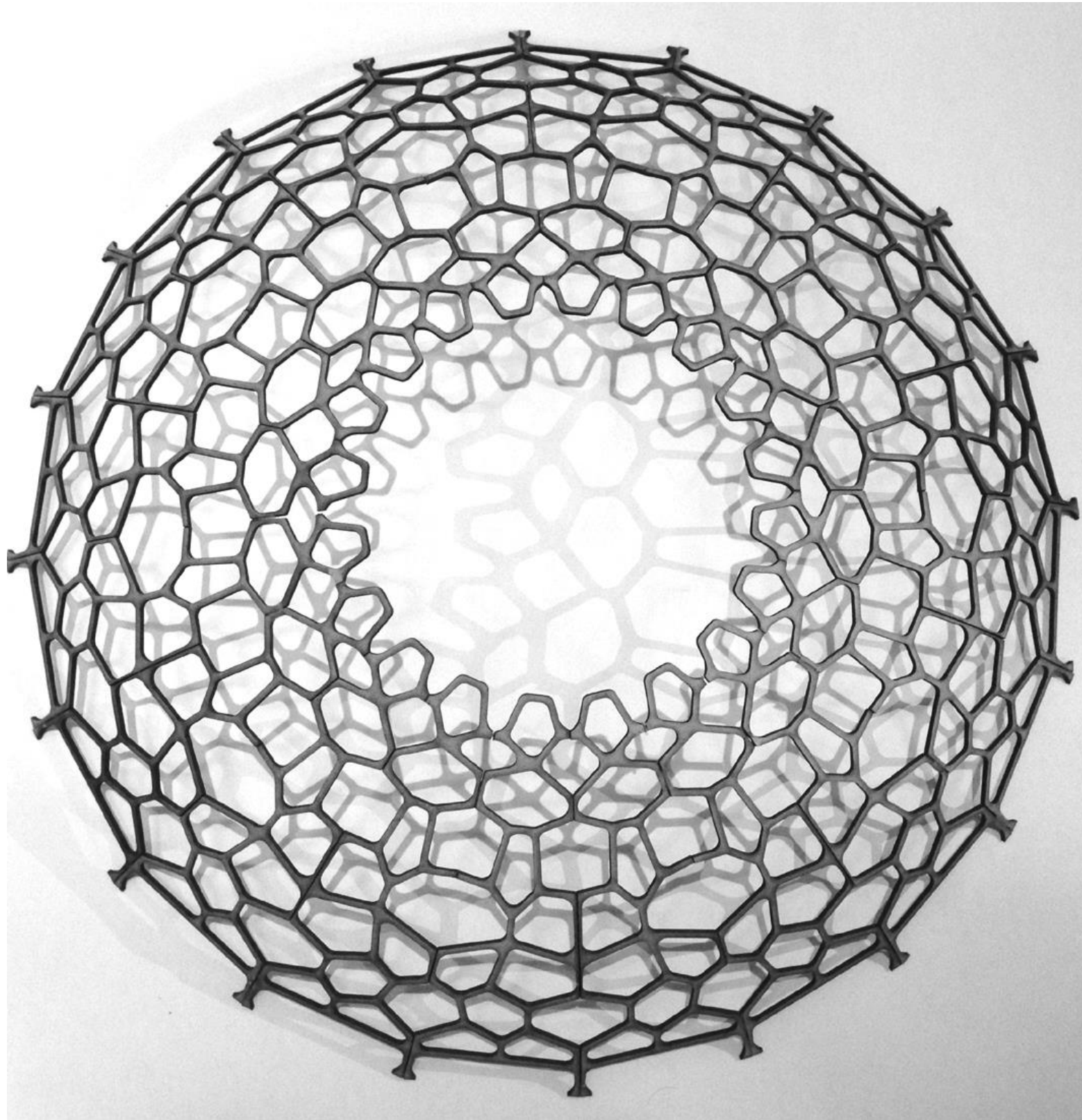

Site plan cardboard model

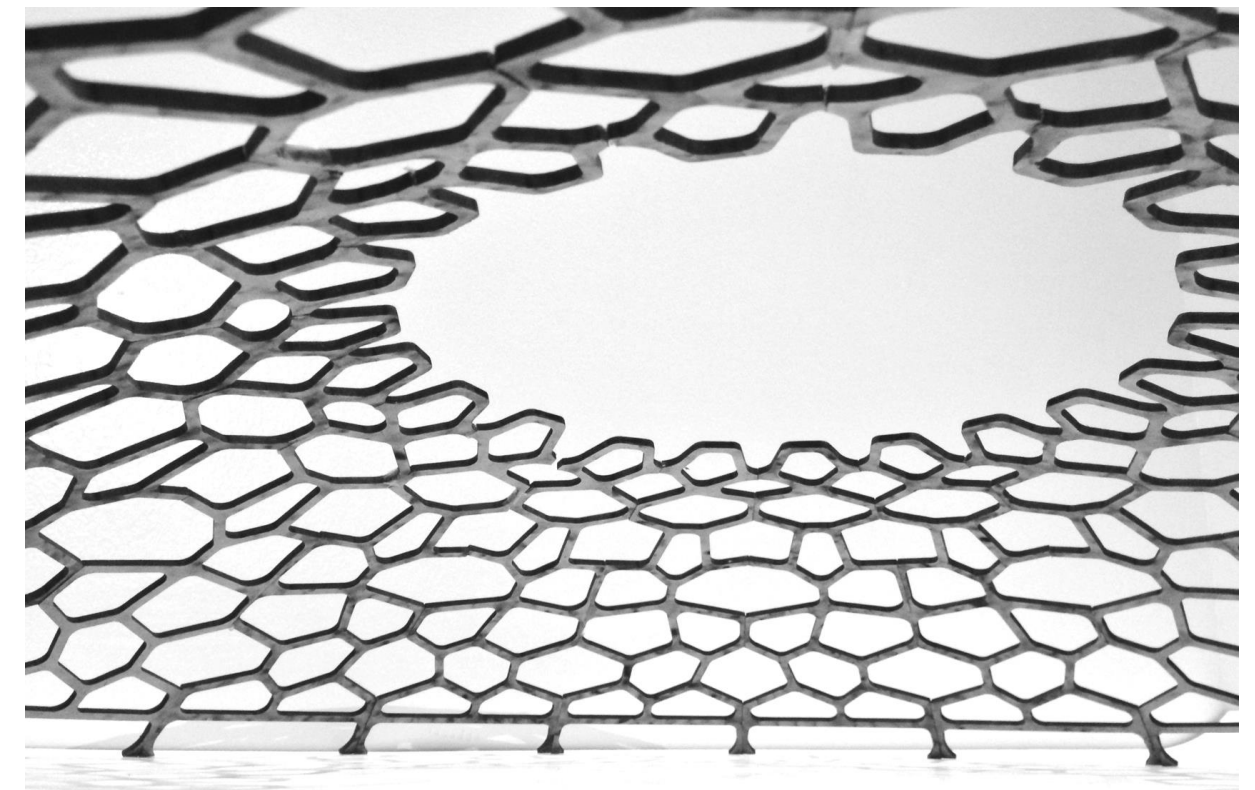
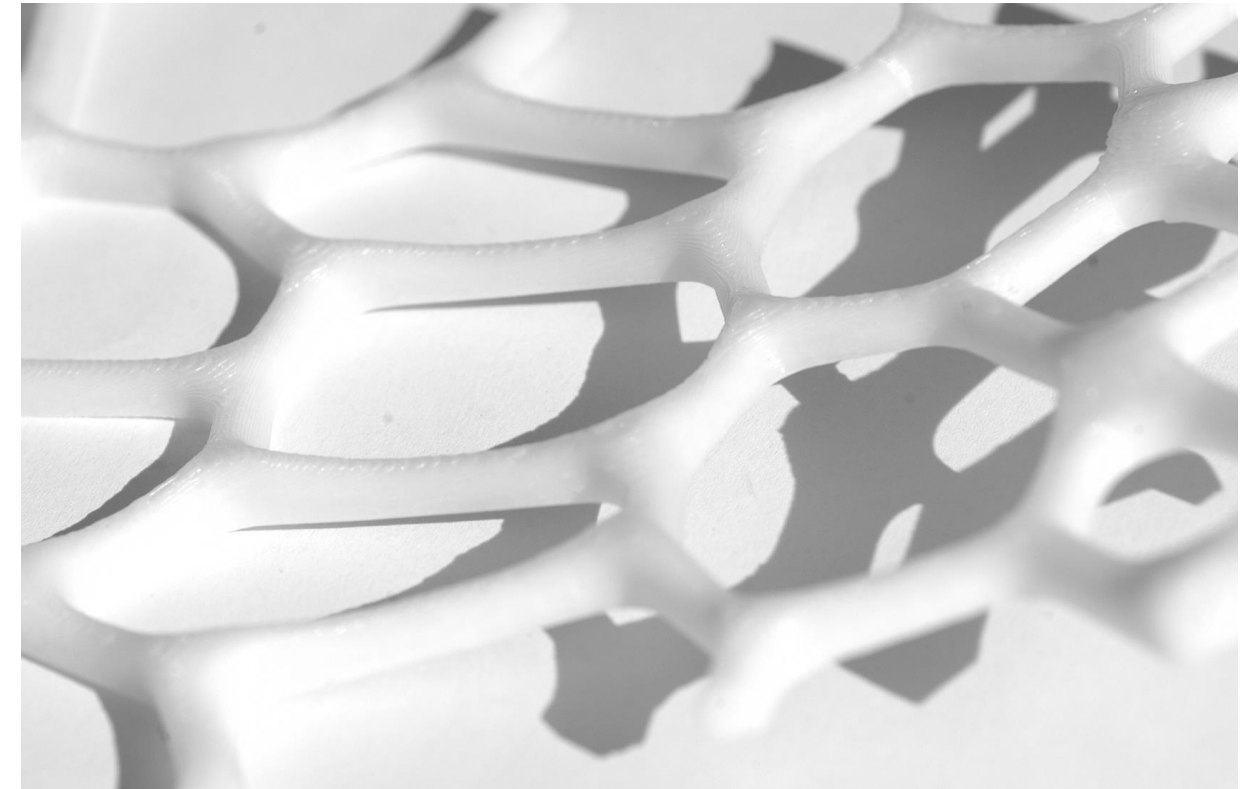

View of model from within

## PRELIMINARY STUDIES

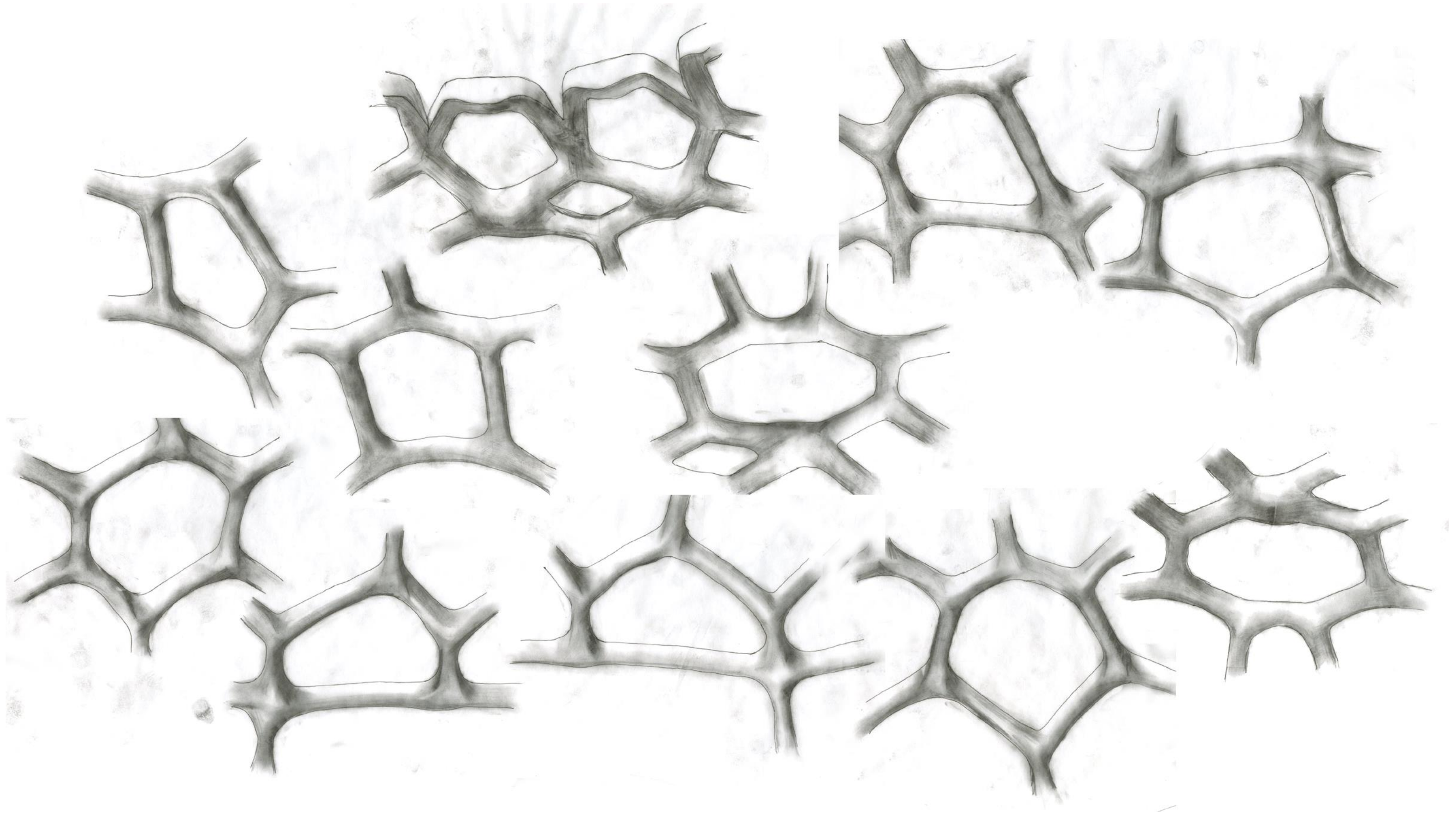

Organiditic Patterns

SKETCHES



