

Bridge Challenge Design Brief: Alternate Activity (2 points)

Introduction

This design challenge involves two problems: a *computer bridge* and the construction of a card stock truss bridge (*bridge model*). Both problems are based on the West Point Bridge Builder, which was developed by Stephen Ressler, a Civil Engineer, for educational purposes.

Engineering Design Problem 1: Computer Bridge Challenge

Your challenge is to design the least expensive “Single Span Truss (24 meters)” bridge that will support a 20-kiloton dynamic load. The constraints are specified in the software. Your bridge may be a through, deck, pony or combination truss (above and below the roadbed).

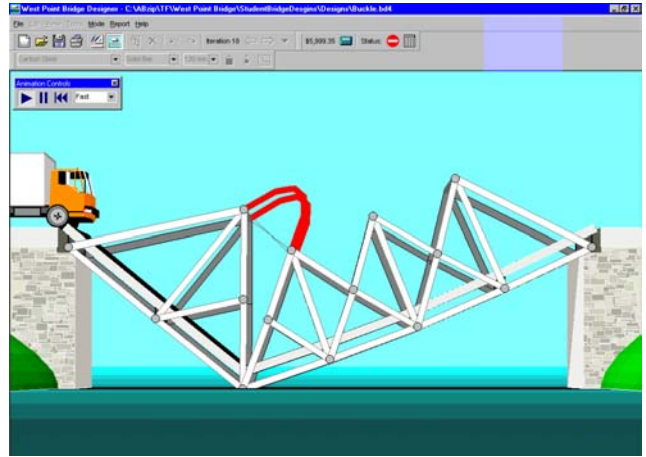

Through truss.



Pony truss.



Deck truss.

Truss bridges are grouped into three general categories, based on their deck location. If the deck is located at the level of the bottom chord, the bridge is a **through truss**. A **pony truss** looks just like a through truss, except it is not as high and has no lateral bracing between the top chords. If the deck is located at the level of the top chord, the bridge is called a **deck truss**.

Instructions: You must use the version of the software (WPBD 4.11) that is posted on Blackboard. **Download the software (*BridgeSoftwareInstall*) and *RequiredDesignFile* from Blackboard. Follow all software installation instructions on the following pages.** Your team does **not** necessarily need to meet face to face for the Computer Bridge. That is, you can share designs (.bd4 files) via email with other members, improving on designs or giving each other feedback on designs. Your team is **not** allowed to do any of the following:

1. Load sample designs or templates that are in the software (remember, you are on the honor code). You will learn more by discovering what factors contribute to a lower cost bridge.
2. Consult other teams or any other human source. This is a discovery design brief.
3. “Google” a solution.

Assessment: This *computer bridge* counts .5 of the total 2 points for the *Bridge Challenge Design Brief*. A team score of \$3,100 or under receives the full .5 points. A team score of over \$3,100 receives no credit.

Deliverable: At the end of this assignment, your team will submit to your instructor a print out of its final and lowest score bridge design (see the last page of this document for what you need to submit to your instructor).

Due date for all deliverables: W/R (11/10 and 11/11).

Note: Materials and requirements for the bridge model will be distributed to your team this M/T (11/1 and 11/2).

Software Installation Instructions

After downloading the *BridgeSoftwareInstall* and *RequiredDesignFile*, follow all the instructions below:

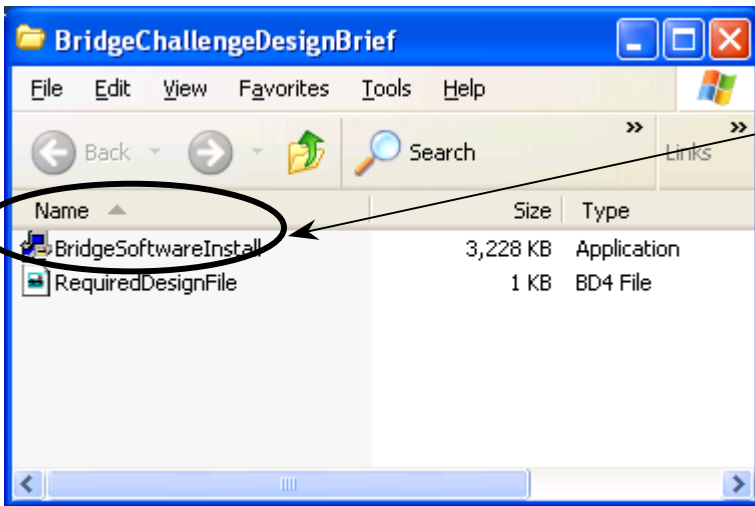

Install the software by clicking BridgeSoftwareInstall.

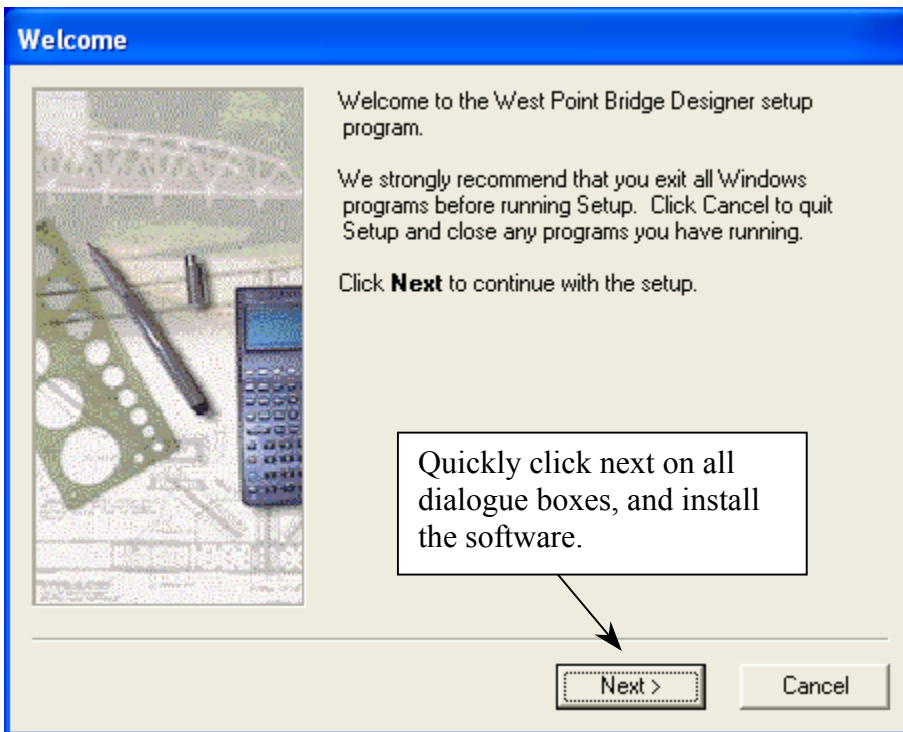

Quickly click next on all dialogue boxes, and install the software.

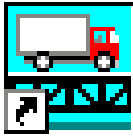

Launch the computer bridge shortcut that is placed on your desktop.

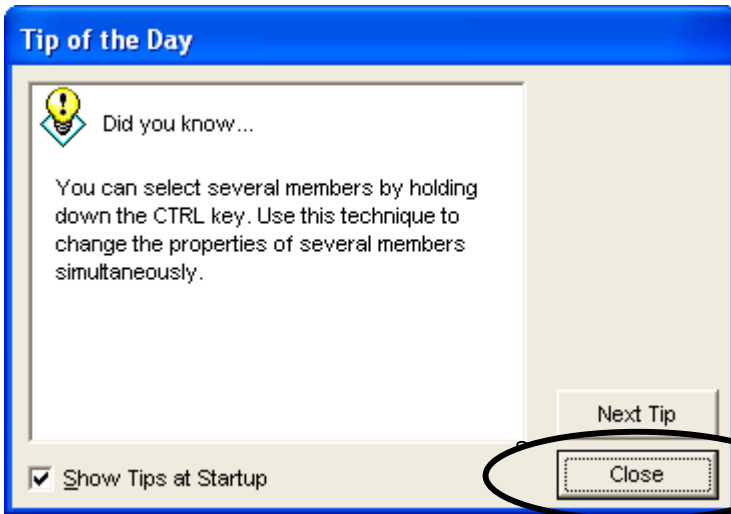

Skip the tips

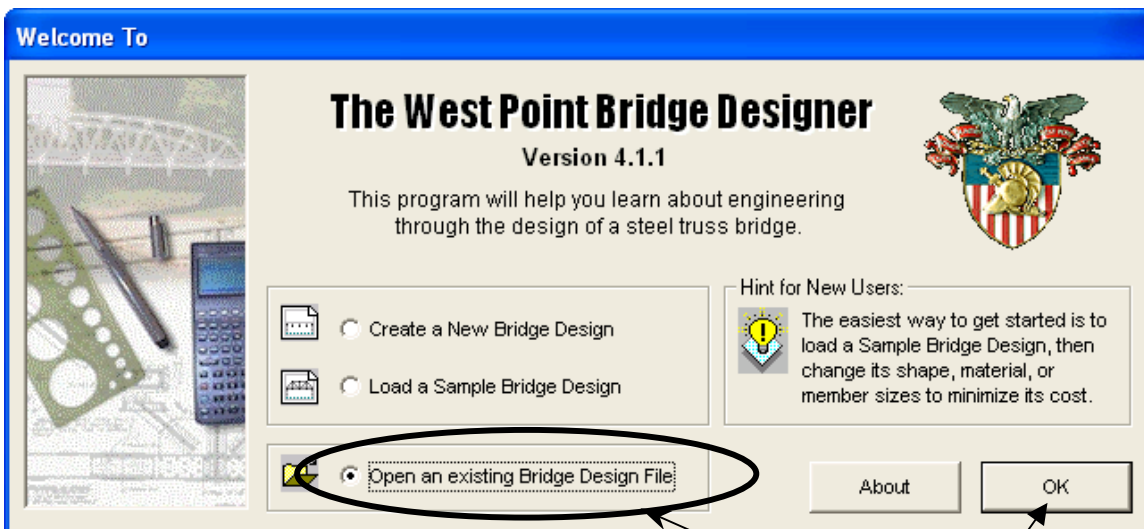

Select this and ok.

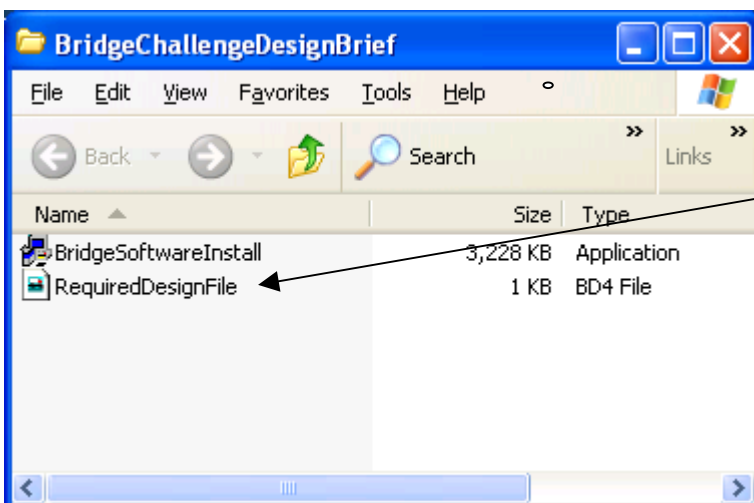

Navigate to and open the *RequiredDesignFile* that you downloaded previously from Blackboard. **Note:** You probably cannot launch this file directly.

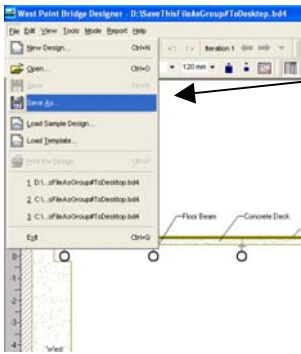

Save the RequiredDesignFile, renaming it your last name.

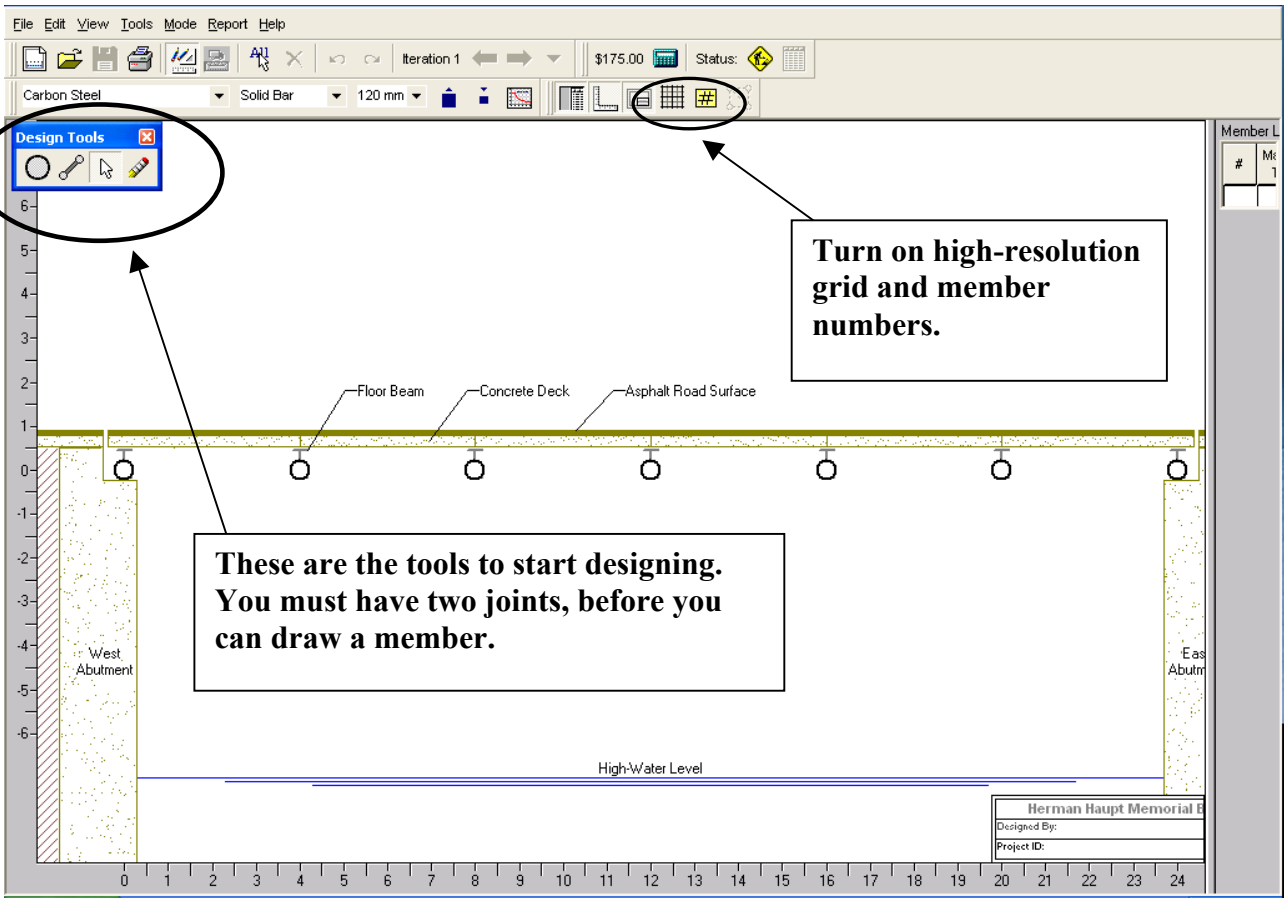

Turn on high-resolution grid and member numbers.

These are the tools to start designing. You must have two joints, before you can draw a member.

Herman Haupt Memorial B	
Designed By:	
Project ID:	

Member L	#	Mt
		1

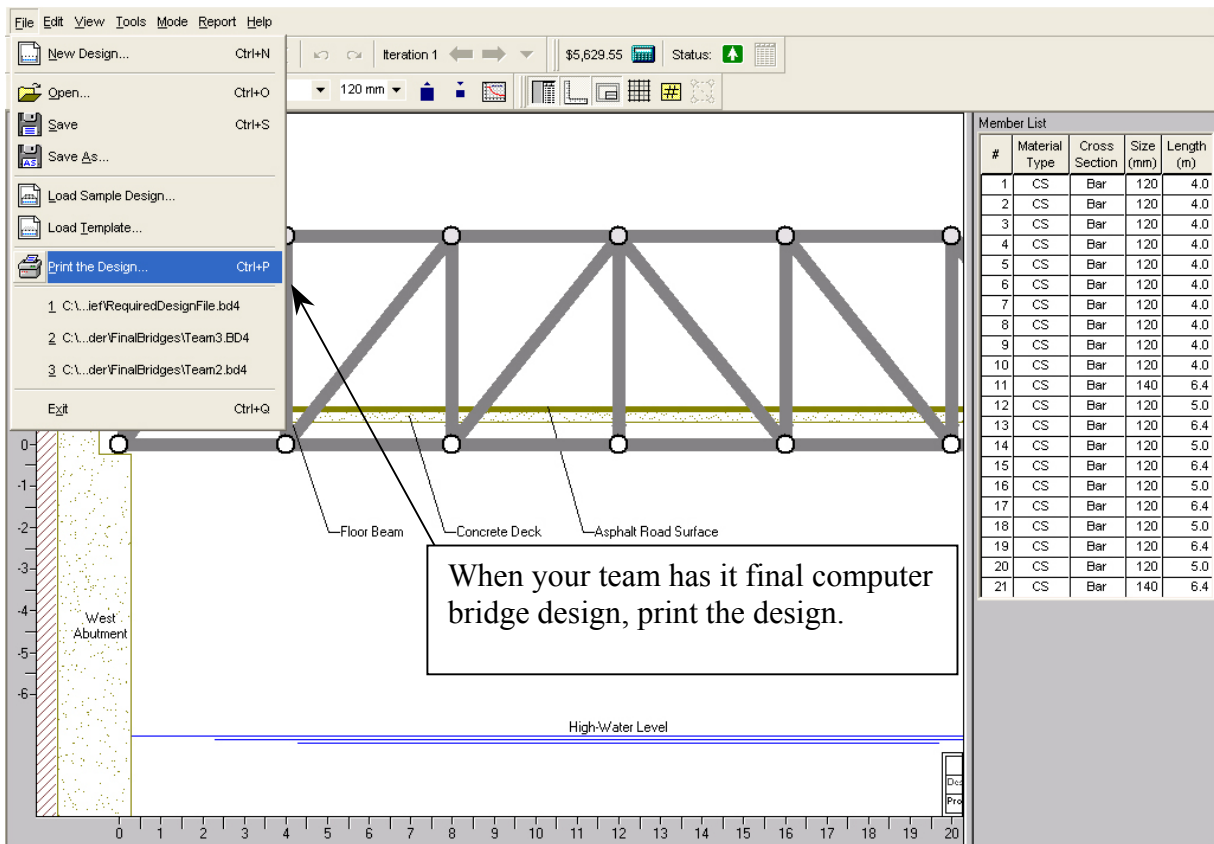

An **example print** of what your team must submit on W/R (11/10 and 11/11) is on the next page.

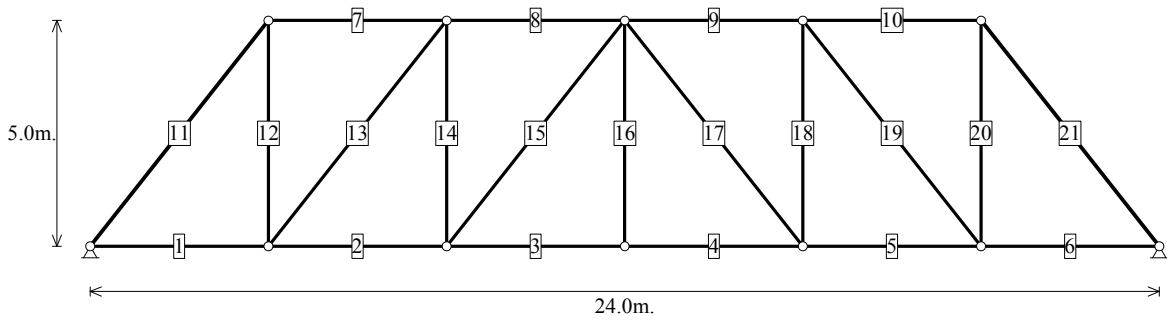

TRUSS MEMBERS							
#	Member Size (millimeters)	Matl	Length (meters)	#	Member Size (millimeters)	Matl	Length (meters)
1	120 x 120	CS	4.00	12	120 x 120	CS	5.00
2	120 x 120	CS	4.00	13	120 x 120	CS	6.40
3	120 x 120	CS	4.00	14	120 x 120	CS	5.00
4	120 x 120	CS	4.00	15	120 x 120	CS	6.40
5	120 x 120	CS	4.00	16	120 x 120	CS	5.00
6	120 x 120	CS	4.00	17	120 x 120	CS	6.40
7	120 x 120	CS	4.00	18	120 x 120	CS	5.00
8	120 x 120	CS	4.00	19	120 x 120	CS	6.40
9	120 x 120	CS	4.00	20	120 x 120	CS	5.00
10	120 x 120	CS	4.00	21	140 x 140	CS	6.40
11	140 x 140	CS	6.40				

NOTES:

- (1) All member sizes in millimeters.
- (2) All member lengths in meters.
- (3) CS = Carbon Steel
HSS = High-Strength Steel
Q&TS = Quenched & Tempered Steel

Herman Haupt Memorial Bridge
Main Truss Elevation

\$5,629.55	10-26-2004	#1
------------	------------	----

Designed By:
Project ID: *Howe Through Truss*

Bridge Challenge Design Brief: Alternate Activity (2 points)

Introduction

Once your team has obtained \$3,100 or less with the Computer Bridge, your team is ready to start on card stock bridge model. This problem will require face-to-face meetings for the construction. In addition, it will require some organization by your team, if the assignment is to be completed in a time efficient manner. **Note:** *If your team has not obtained at least \$3,100 with the computer bridge after 1 hour and 45 minutes, then you need to start on the bridge model. Come back to the computer bridge as time allows.*



Engineering Design Problem 2: Bridge Model Challenge

Your challenge is to design the lightest “Single Span Deck Truss (24 meters)” bridge that will span 58 cm and safely support a 4.6-kilogram static load. The deck bridge model must be made entirely of the cover stock paper provided. To test that your deck bridge model is successful, you will progressively load it with textbooks.

Instructions: You must use only the materials provided. Your team is **only** allowed to use the following resources, which are on Blackboard:

1. Construction steps and design requirements (below).
2. Files for custom members

You are **not** allowed to do any of the following:

3. Consult other teams or any other human source. This is a discovery design brief.
4. “Google” a solution.

Assessment: The Bridge Challenge is worth 2 points; successful completion of all requirements results in 2 points.

Item	Deliverable	Criteria	Points
Computer Bridge	Printout of design (see computer bridge design brief.)	Scores \$3,100 or less	0.5
Load test photo	Printout of digital photo with textbooks loaded on bridge.	Bridge supports the 4.6 kg load. (Failure to deliver the print is -.25)	0.25
Bridge Model	Actual Model	Have a bridge or don't have a bridge	1.25

Submission Instructions: On the due date, submit the following “stapled together” in one team packet: top page is a printout of the computer bridge design with each team member’s first and last name; 2nd page is the digital photo print out of the team’s model bridge under load. In addition, bring in your bridge model for check off.

Due date for all deliverables: W/R (11/10 and 11/11).

Agenda

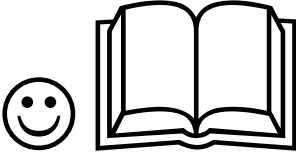
Item	Individual ☺ or Team Meeting ☺☺☺☺
Computer Bridge	Either ☺ or ☺☺☺☺
Study this design brief document for full understanding, before starting construction. You will avoid construction mistakes, if you fully understand the instructions before starting.	
Problem formulation (Download from Blackboard and print)	☺ (Complete and bring to your team meeting)
Bridge Model design	☺ and then negotiate on a final design ☺☺☺☺
Bridge Construction	☺☺☺☺
Load Test	☺☺☺☺
Written Reflection (See last page of this document)	☺ (Do this after the assignment, but do not turn it in)
Deliverables on due date	☺☺☺☺

Engineering Design Problem 2: A Card Stock Bridge Model

Your team will make one bridge model. You are only allowed to use the card stock provided in your kit. The bridge will have a scale of 1 cm = .4 m.(drawn size = actual size). This makes 1 meter from the computer model or real life size equal 2.5 cm on your drawing or scaled bridge. Therefore, your scaled bridge must be 60 cm. **The floor beams must measure 9 cm in length, like shown in the instructions below.** Make sure your design allows room at each end of the bridge, so it can be spanned between two tables for testing purposes (see instructions below). The two tabletops will be spaced 58 cm apart. This allows for a 1 cm overlap on each end of the bridge. The bridge will be loaded at joints C(C'), D(D'), and E(E'), with approximately 4.6 kilograms of textbooks. All members must be either single tubes or double bars. You are not allowed to glue members directly on top of one another (veneering). Gusset plates are not allowed to touch one another (see Example B, next page). Tubes must remain hollow. All members must be either single tubes or double bars. In addition, your bridge must have **seven** joints at the roadbed, which are spaced every 10 cm, just like on your grid paper. Additional joints can be added to the roadbed. Do **not** simply mimic the bridge presented in the construction steps.

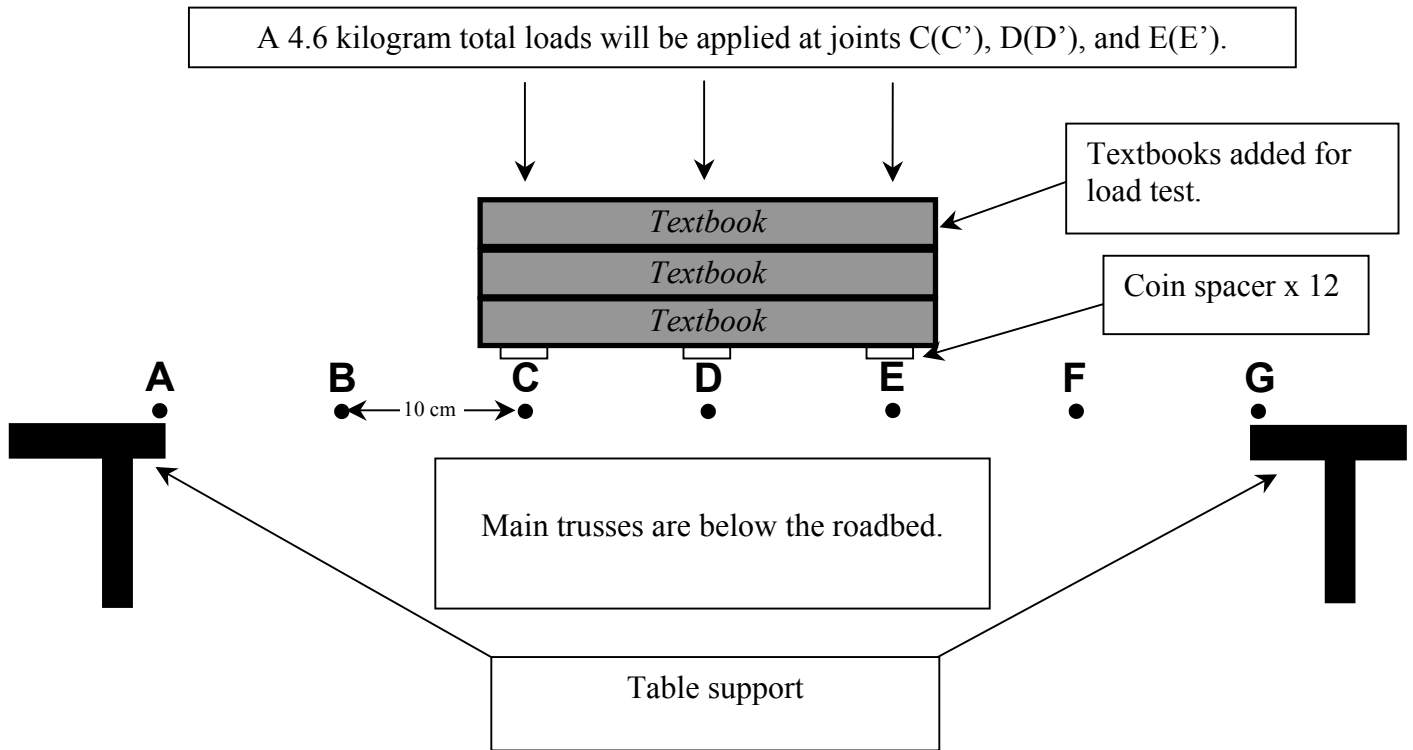

Connections NOT



Allowed

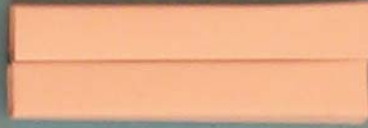

No Tubes On Top of Tubes



No Bars Directly to Tubes
(There is some overlap at joints)



No Bars On Top of Bars



No Gusset Plates
On Top of Gusset Plates



Example B

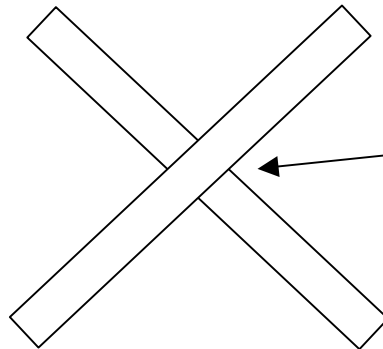

Members may cross one another.

Part Names for a Truss Bridge

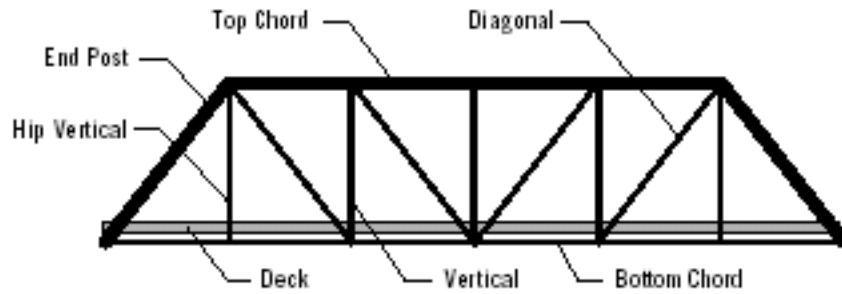

Component parts of a typical truss bridge - Elevation View

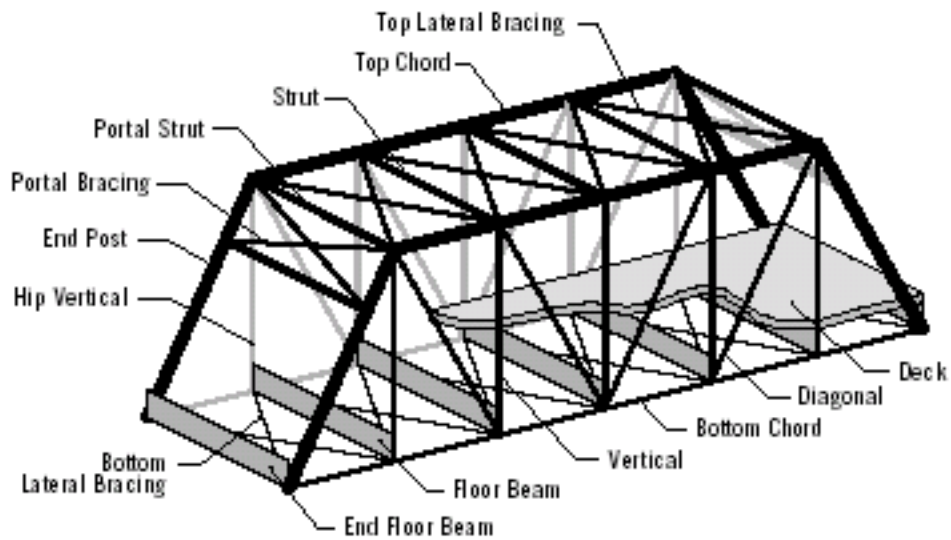

This is a through truss, but you will design and construct a deck truss.

Truss Model Construction Steps (make sure you follow these steps to insure success). Read through all steps before starting construction.

The following describes how to make a truss bridge using the layout grid and the materials in your kit. You will need to make two main trusses and the members that connect the two main trusses.

These instructions not only include deck truss construction techniques, but also how to make your truss in a time efficient way.

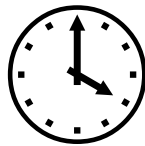

Make sure you make note of the items that can save you time.

Terminology for Truss Bridge Construction

Truss – one side of a bridge.

Deck Truss – when the truss system is below the roadbed.

Member – either a double-bar or tube that goes from one joint to another.

Joint – the location where members are connected.

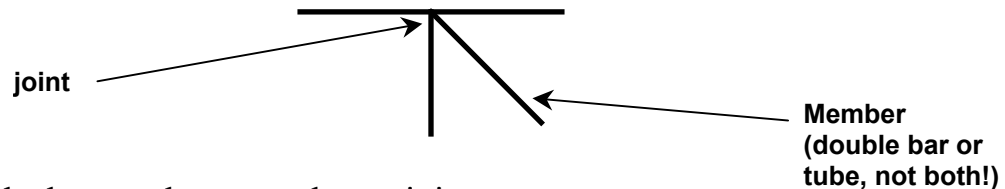

Gusset Plate – holds the members together at joints.

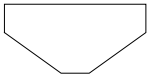

Bar – a solid or single strip of paper (3, 4, 5, or 6 mm in width).

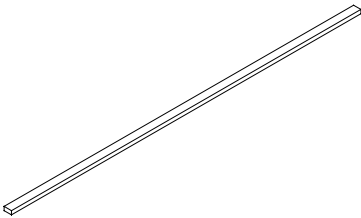

Tube – a hollow square member (7 mm square or 9 mm square). Has both compressive and tensile strength.

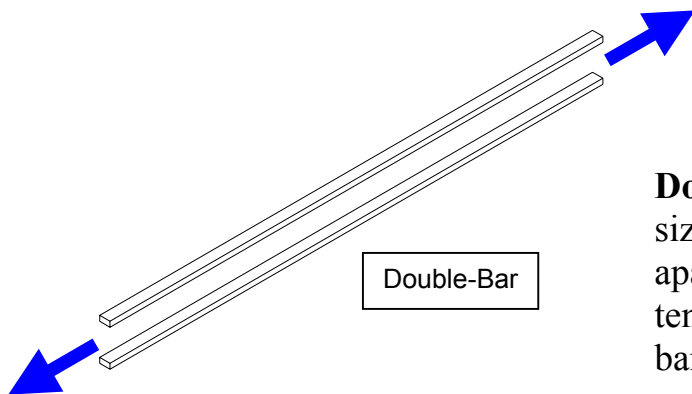
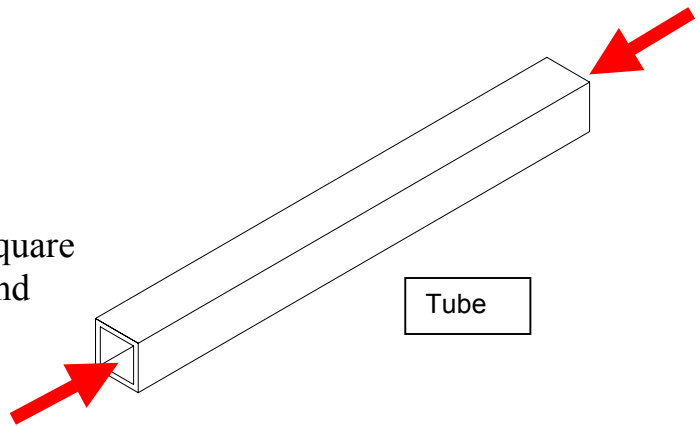

Double Bar – two bars that are the same size (e.g., 6 mm), and are spaced (held apart) by tubes. Efficient for members in tension. When made of card stock, double-bars have little or no compressive value.

Gusset-Bar Assembly – a set of single bars and gusset plates. You need two to make one main truss. Construct one each in the upper and lower grid. You need 4 for the total bridge.

Example Only: **This is a through truss, but you must construct a deck truss.**

Gusset-Bar Assembly
(from Upper Grid, see your grid paper) **Note:** no tubes.

One this is assembled; it is carefully glued on top of the tubes in the lower grid.

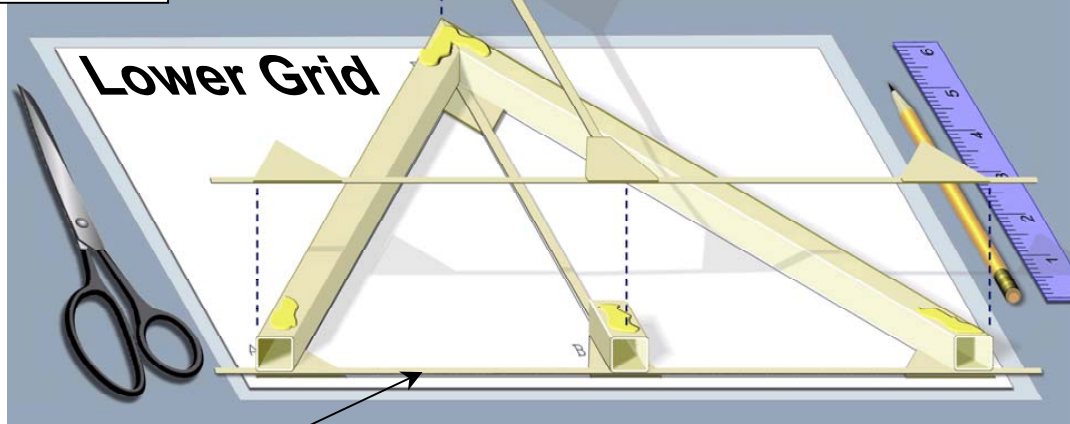

Gusset-Bar Assembly
(Constructed in Lower Grid, see your grid paper)
Tubes are glued on top of this assembly.

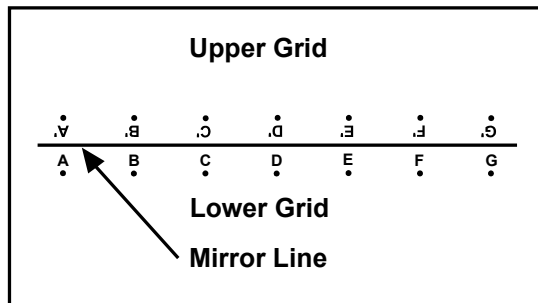

The truss or one side of a bridge can be thought of as **two gusset-bar assemblies** with **tube members** in between. The upper grid assembly folds over the mirror line on top of the lower grid, once tubes have been placed in the lower grid.

Bridge Construction Inventory

Obtain or purchase the construction materials not included (items with an * below). Some of these items may be in your MacGyver box.

Materials

Qty	Item	Function	Mass
12	3 mm x 24.5 cm card stock strips	Double bar members	
12	4 mm x 24.5 cm card stock strips	Double bar members	
12**	5 mm x 24.5 cm card stock strips	Double bar members	
12**	6 mm x 24.5 cm card stock strips	Double bar members	
24	7 x 7 x mm x 22 cm square tubes	Tube members	9 g
24	9 x 9 x mm x 22 cm square tubes	Tube members	
3	8-1/2 x 11 card stock sheets	Custom or needed members/gusset plates	
1	Example 7mm tube	Instructional purposes, but you can also use it on your bridge.	
1	Example 9 mm tube	Instructional purposes, but you can also use it on your bridge.	
66	45 x 30 mm gusset plates	Connect members at joints	
1	Elmer's Glue*	Make connections permanent	
1	Rubber Cement*	***Make tubes (do NOT use this with gusset plate connections: it will not be strong enough!!!)***	

** Your team's envelope will have either 5 or 6 mm bars, but not both

Note: Qty of Tube, Bar, and Gusset Plate stock included may vary slightly from envelope to envelope.

Note: All of the above members are made of one type of material: 80 lb., uncoated cover stock paper, which is .012 inches thick (.305 mm). Cover stock is thicker than same weight in card stock. However, the terms cover and card stock are used interchangeably in these documents. The both refer to cover stock.

Construction Tools (Necessary)

Qty	Item	Function
1	600 x 420 mm Layout grid	Accurate layout of two main trusses and floor beam assembly
1	Foam core board	Hold pins stationary.
2	Scissors*	"Gang Cut" members and gussets
1	Straight edge*	Lay out of design
1	Overhead transparency	Gusset plate templates
1	Fine marker	Outline gusset plates onto the overhead transparency
2	Rolls of Wax Paper	Prevent truss members from adhering to the drawing grid
1	Roll of Masking Tape or transparent tape*	Tape layout grid to the foam core board. Hold down wax paper. Tape coins to joints during testing.
100	Stick pins	Hold gusset plates during construction

Construction Tools (Helpful)

Qty	Item	Function
1	Metric Rule*	Measurement*
1	180° Protractor*	Lay out angles
1	Clip board(s)*	Crease scores on tubes (see page 21 for type of clip board)

Load Test Equipment (secure these items)

Qty	Item	Function
12	Quarter dollars	Transfer textbook load to the joints at C(C'), D(D'), E(E')
2	Tables with straight sides	Span the bridge between during testing.
1	Assorted textbooks	To apply a load to your finished bridge.
1	Digital camera	Take a photo of the bridge during test load.

* Obtain or purchase (some of these items are probably in the MacGyver Boxes).

*****Team members should each take responsibility for helping gather up the needed material.*****

Sample tests of members made of the 80 lb. cover stock

T = tension and C = compression

Test #	Cross Section (CM) (single bars)	Length (cm)	Trial 1	Trial 2	Trial 3	Trial 4	Mean	Weight of Bucket and sand	Tensile/Compressive Strength (Newtons)
T1	3.0	20	879.6	822.9	780.3	652.6	783.8594	7.69	21.38
T2	3.5	20	851.3	865.4	794.5	837.1	837.0625	8.21	22.83
T3	4.0	20	1021.5	936.4	993.1	993.1	986.0313	9.67	26.89
T4	5.0	20	1319.4	1276.9	1333.6	1135.0	1266.234	12.42	34.53
T5	5.5	20	1418.8	1418.8	1305.3	1461.3	1401.016	13.74	38.21
T6	6.5	20	1631.6	1645.8	1702.5	1688.3	1667.031	16.35	45.46
T7	7.0	20	1844.4	1730.9	1986.3	1787.6	1837.281	18.02	50.11
T8	8.0	20	2213.3	2156.5	2099.8	2156.5	2156.5	21.16	58.81
C1	6.0	15	1645.75	1816	1475.5		1645.75	16.14	44.88
C2	8.0	15	2014.63	1901.13	1957.88		1957.875	19.21	53.39
C3	10.0	15	2610.5	2667.25	2043		2440.25	23.94	66.55
C4	6.0	10	2043	2525.38	1816		2128.125	20.88	58.04
C5	8.0	10	1589	2525.38	1589		1901.125	18.65	51.85
C6	10.0	10	2582.13	1929.5	2270		2260.542	22.18	61.65
C7	6.0	5	1730.88	2411.88	1702.5		1948.417	19.11	53.14
C8	8.0	5	2497	2156.5	2099.75		2251.083	22.08	61.39
C9	10.0	5	2752.38	2979.38	2411.88		2714.542	26.63	74.03

1. **Choose roadbed tube size:** The roadbed must be made entirely of either 7 mm square tubes or 9 mm square tubes.

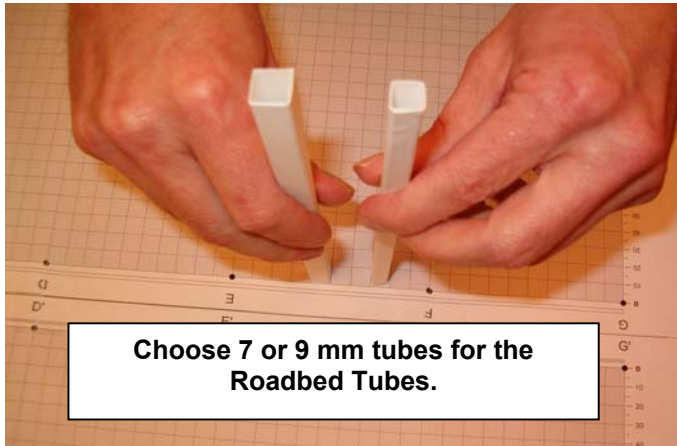

The roadbed must be of all tubes. It will take six pieces of cut tube stock to span the required 60 cm.

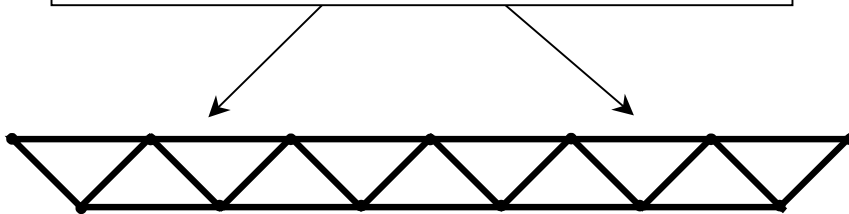

Note: It may be easier for the overall construction to use 9 mm tubes for the roadbed tubes, then use the 7mm tubes for floor beams and struts (the members that are perpendicular to the two main trusses, connecting them). This is also important to consider, due to the amount of materials you have.

2. **Truss Design:** Mark all joint locations and connect them with lines. Make a mirror image of this on the other half of the graph paper (upper grid). Label all joints with letters. Since A through G and A' through G' are already marked, start with H through H' serially progressing. **You must have joints at A through G.** You are allowed to add joints to the roadbed (e.g. between A and B).

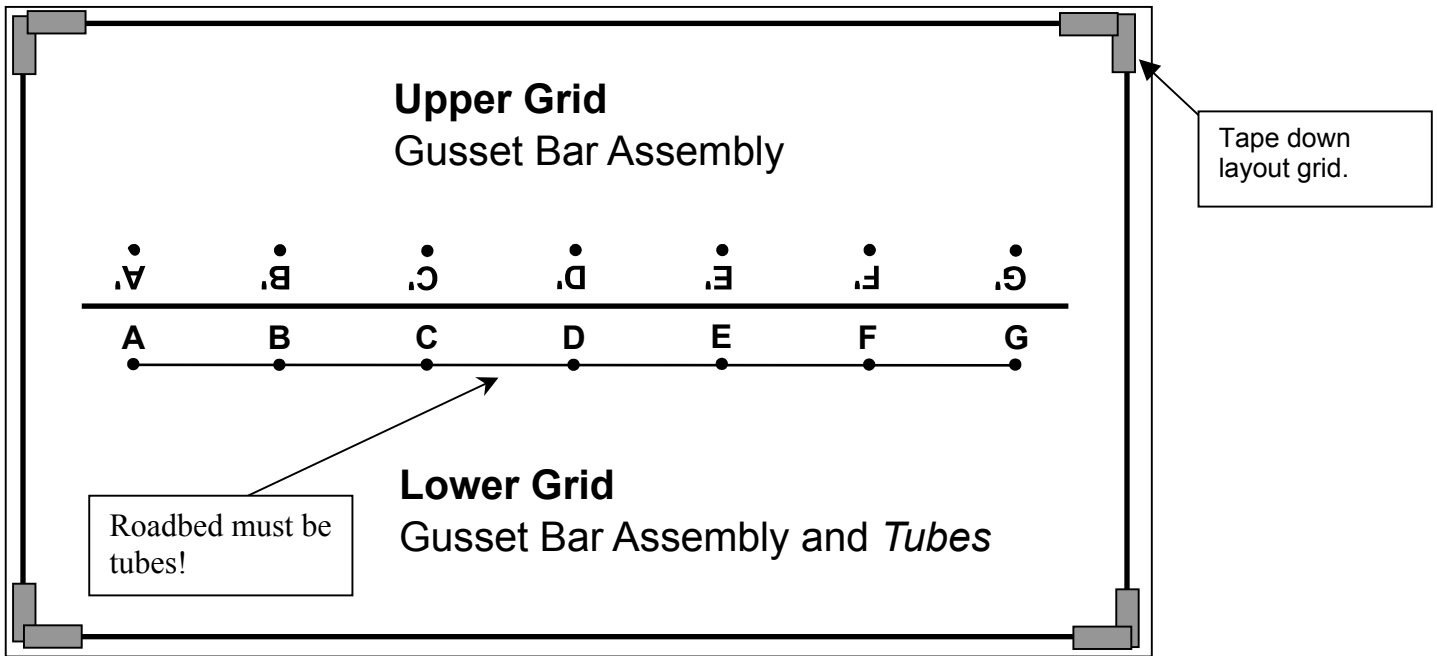

The roadbed, consisting of members AB, BC, CD, DE, EF, and FG, must be tubes!!!! Tape the layout grid to your foam core board.

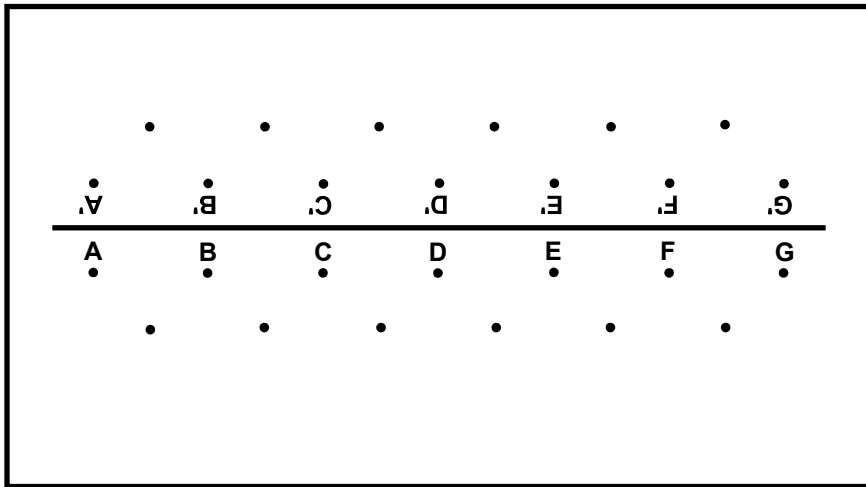

Choose joint locations. Make sure you create a mirror image in the upper grid. **This is just an example.** Design your truss on the grid area in a way you think will result in the most efficient truss. You can have as many triangles or connecting squares as you like.

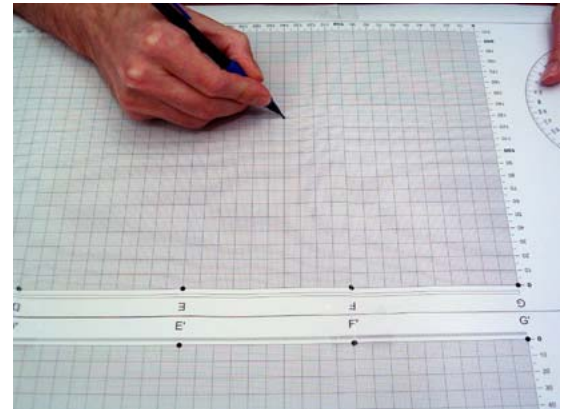

Mark joint locations in upper and lower grid.

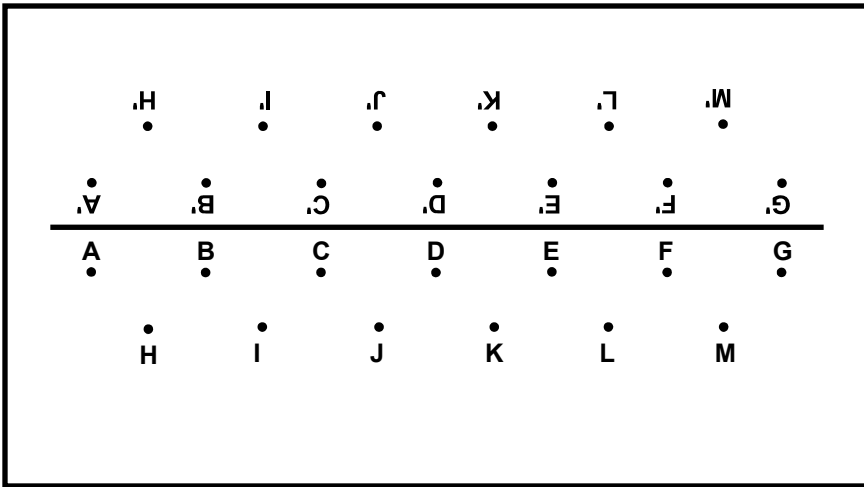

Label all joints: This will help you not get confused later on.

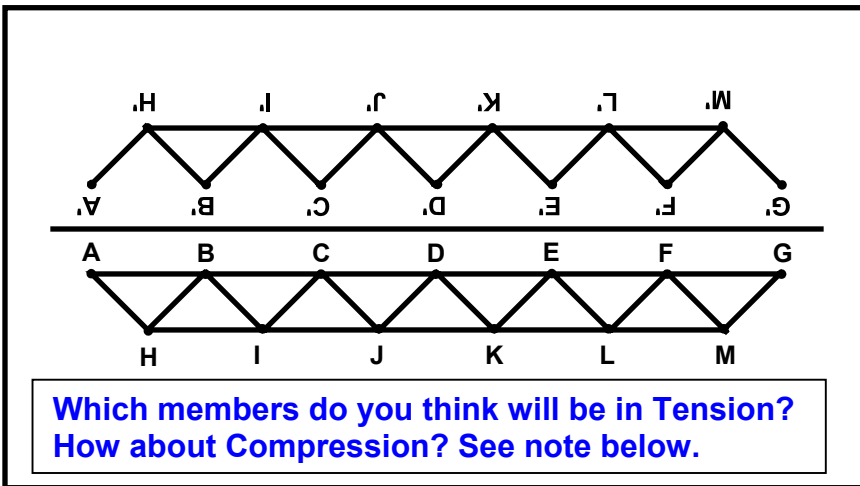
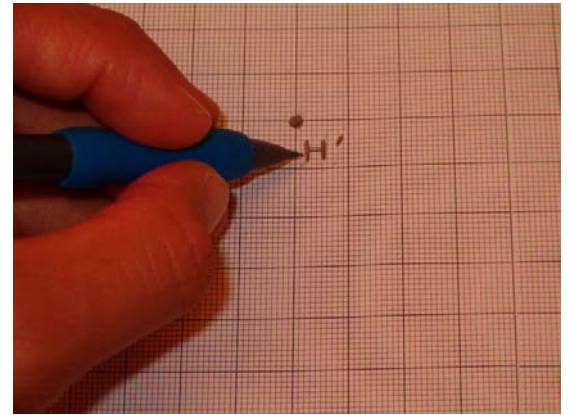

Draw Member Lines

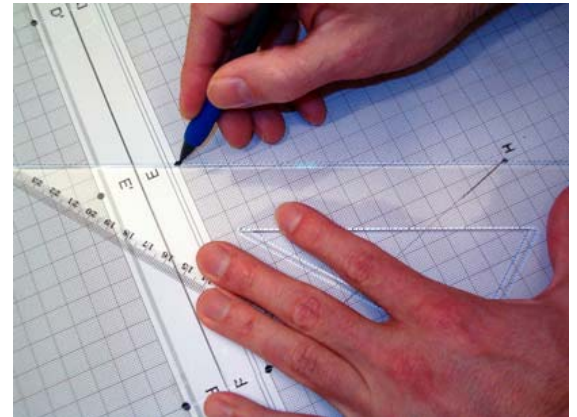

Use a straight edge to indicate where members will be placed.

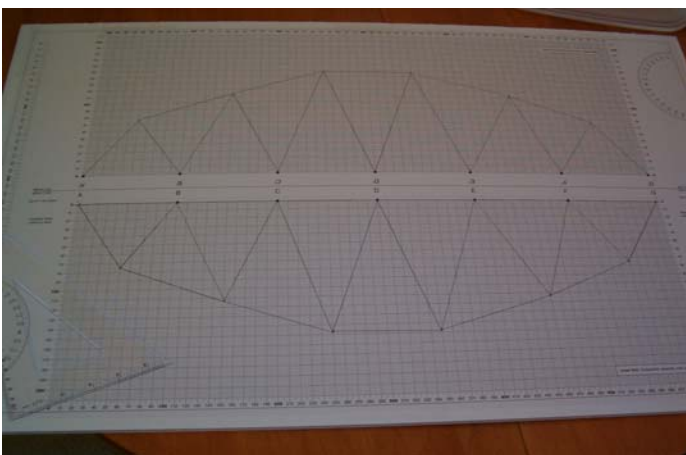

Member line example

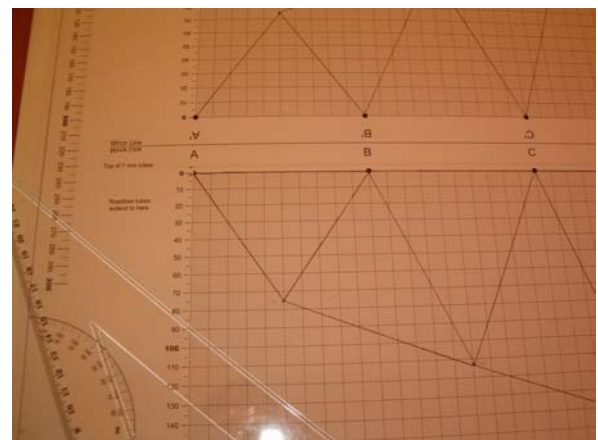

Member line example close up.

Important: Label member lines that you think will be in tension when under load with a (T), and members that you think will be in compression with a (C). Choose double-bars for T's and tubes for C's.

3. **Gusset Plate Design:** Measure along each member line from the joint location at least 20 mm, marking a point. Then, connect each point with a line for all gusset plates. **Important: Do this only for unique joints!!! The end gusset plates should be drawn approximately 30 mm in, since you are only drawing in from the joint.**

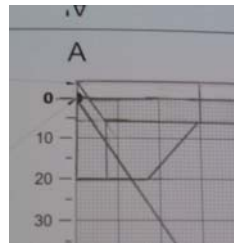

End Gusset Plate

1. Measure and mark point

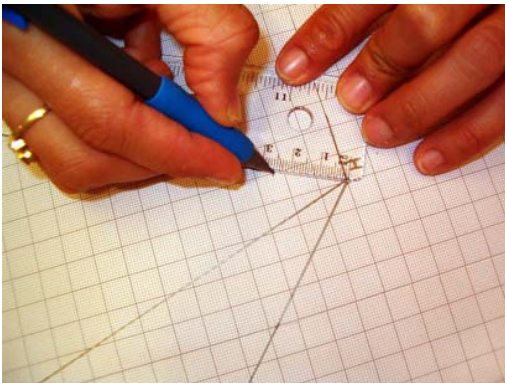

2. Gusset plates look more realistic, if they are designed to run perpendicularly across a member.

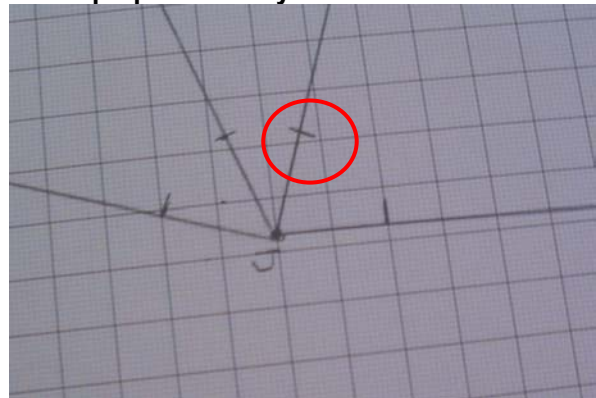

3. Connect points to make gusset plate design

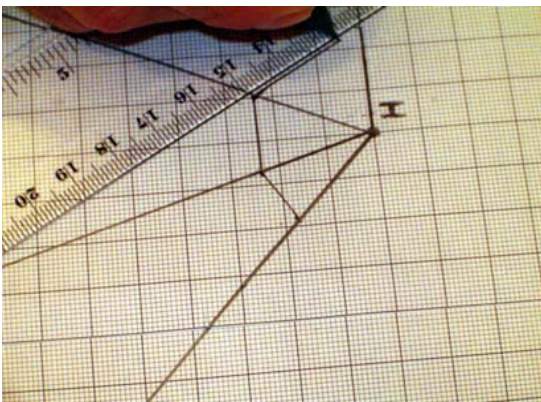

Only draw unique gusset plates (🕒 saver).

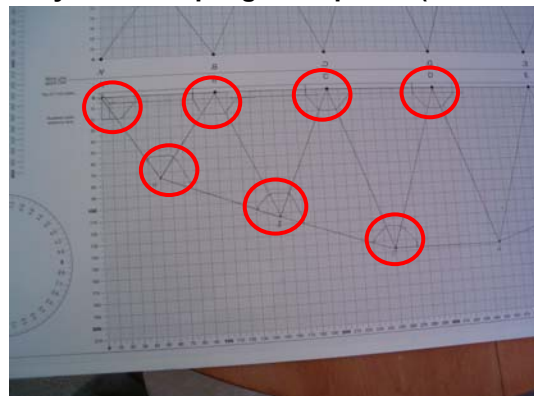

Depending on the symmetry in your design, you will have more or less unique joints. How many unique joints are in this truss design? **Are you able to see that it only has three?**

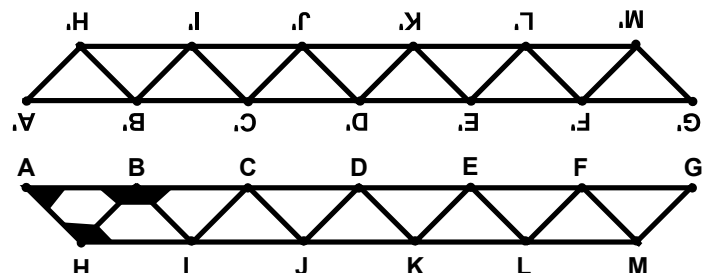
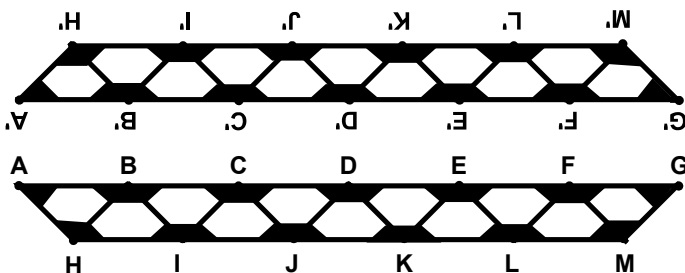

Note: You only need **templates** for one side of the truss. In addition, if your truss design is symmetrical, this reduces the number of gusset **templates** needed.

4. **Gusset Plate Template:** Lay the transparency paper (clear plastic) on top of each unique gusset plate, marking over the gusset plate shape with the marker.

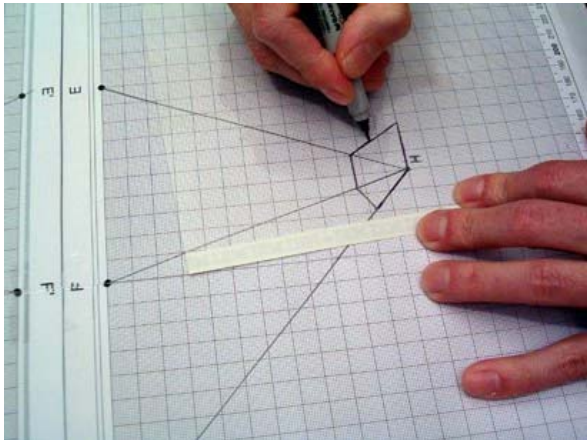

1. Use the marker and transparency paper to make Gusset plate templates for unique gussets.

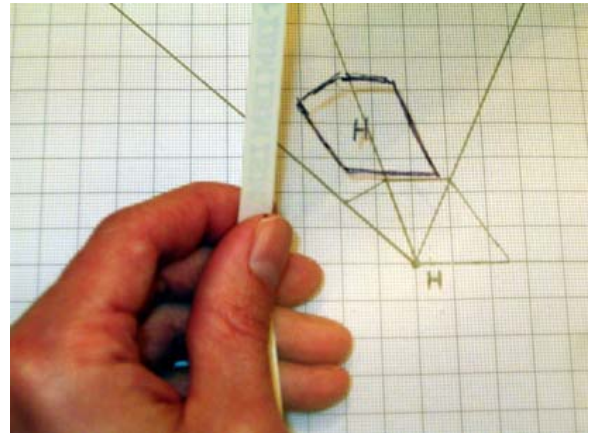

Example gusset plate template.

Schedule of gusset plates needed (🕒 time saver)

Identical Gusset Plates	Qty
A, G, A', G' x two main trusses	8

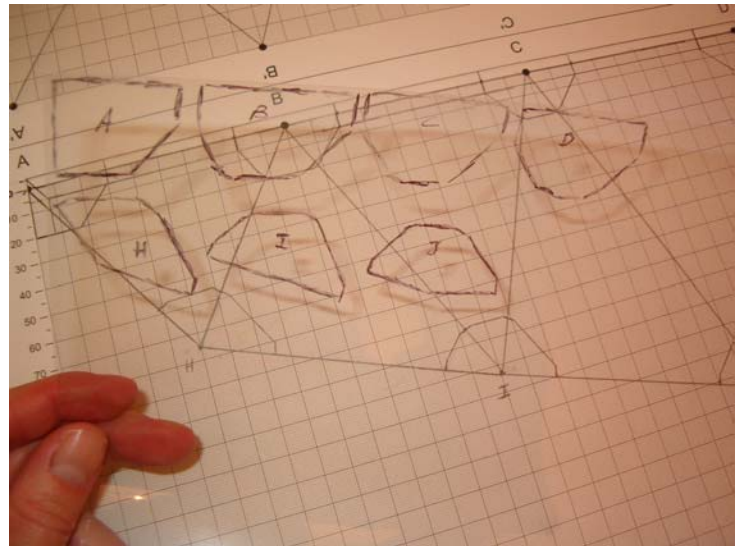

Later on you will need more gussets for the floor beams.

5. **Cut Out All Gusset Plates:** Calculate how many gusset plates are necessary. For example, joint A will need 4 gusset plates (it is identical to A'), and (if your truss bridge is vertically symmetrical) joint H' will be identical, so you will need 8. Therefore, stack four tabs on top of each other and cut them out. It is not suggested to gang more than 4 sheets at once. You must hold them securely when cutting, or each plate will not be identical.

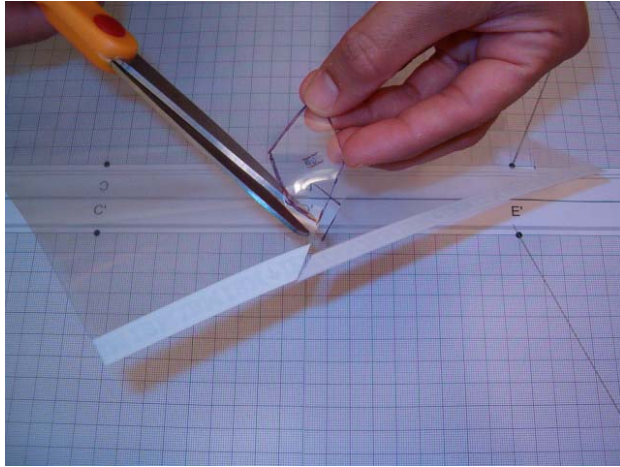

1. Cut out Gusset Template

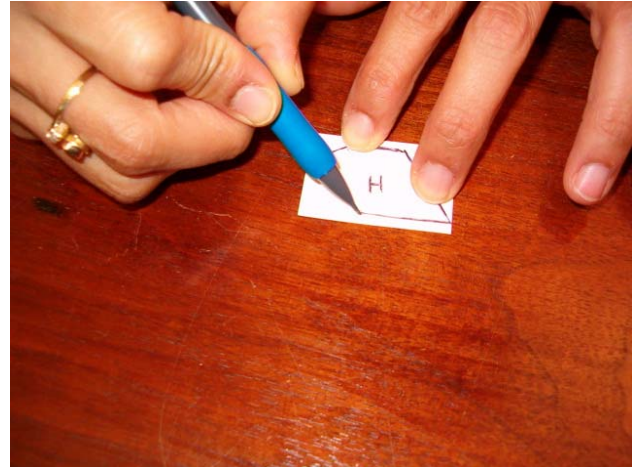

2. Trace around it on a piece of gusset stock.

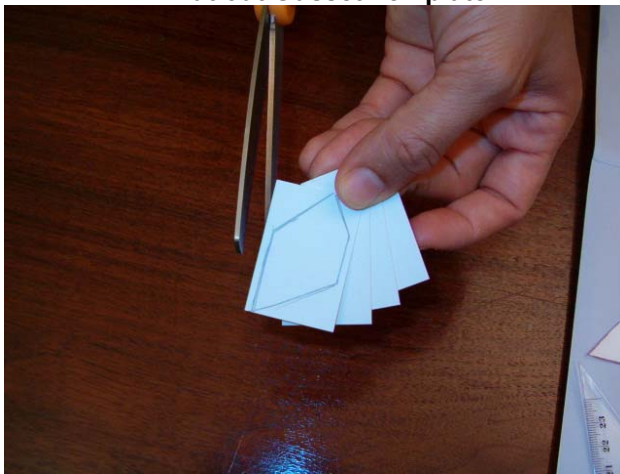

3. Once you determine how many you need of that gusset design, lay the lined gusset stock on top of several pieces. This will allow you to make several at one time. This is sometimes referred to as “gang cutting (🕒saver).”



4. Hold firmly while cutting out. Do not stack more than 4 on top of each other at once.

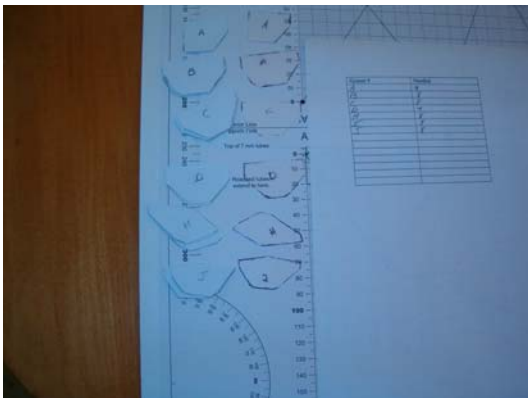

Example of gusset plates when cut.

Warning: it is time to place the wax paper on top of your truss design.

6. **Pin All Gusset Plates:** Each gusset plate must have 2 holding pins. Make sure holding pins will not interfere with where your strips (bars) or tubes need to be glued. Use something to push the pin in, such as coin, if it is uncomfortable for your fingers. **Have you placed wax paper on top of your grid? Use the masking tape or transparent tape to hold down the wax paper—you don't need a lot of tape.**

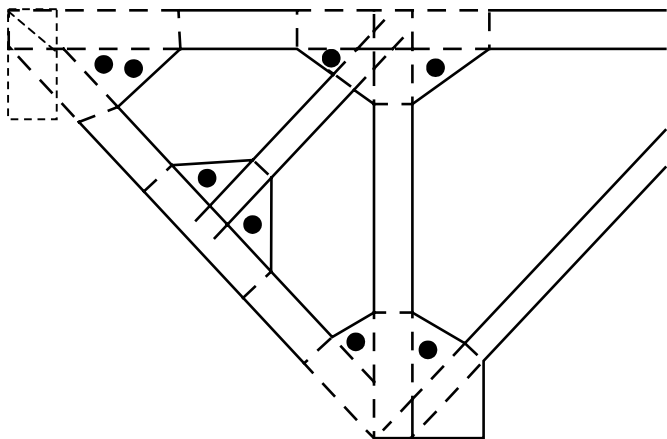
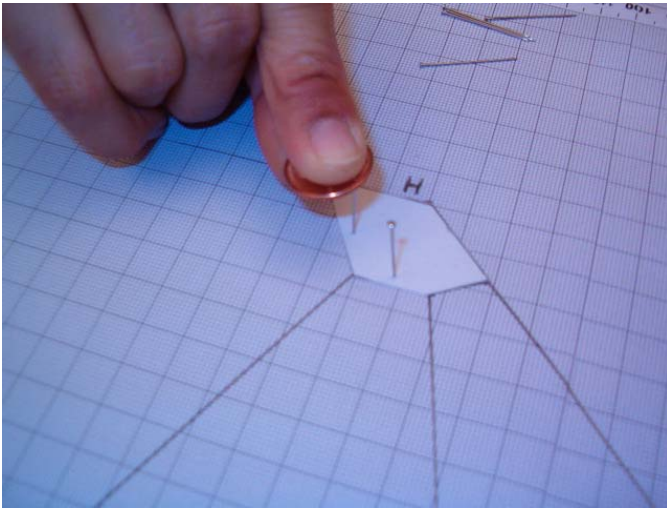

Make sure you pin (●) the gusset plates, so the pins will not be in the way of the members you have planned.

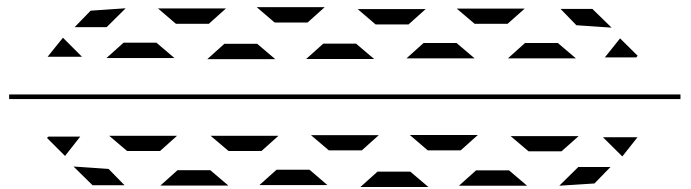

An example of what all gusset plates might look like when pinned to the upper and lower grid.

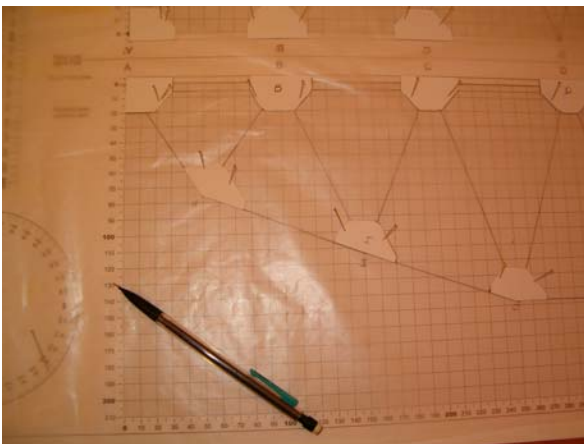

Example of pinned gusset plates.

7. **Cut All Bars:** Measure length of bars needed and then mark a cut line. How many identical bars do you have. Stack bars on top of each other like you did with the gusset plates. Make sure you cut angles so there is no overlap (see next page).

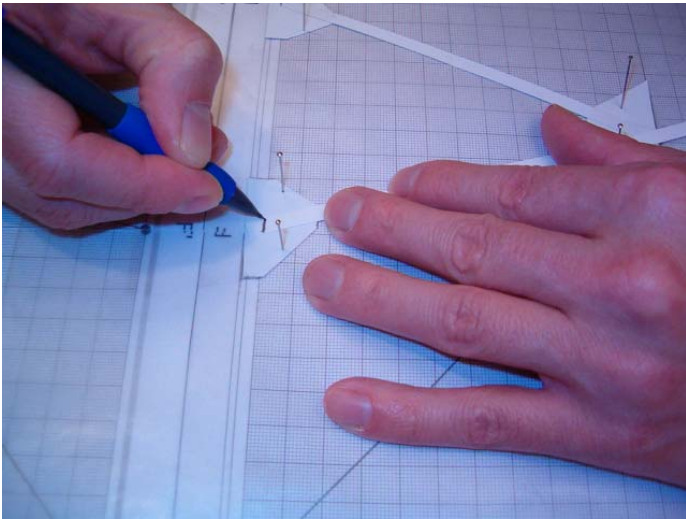

1. Line off (mark) bars, then ...

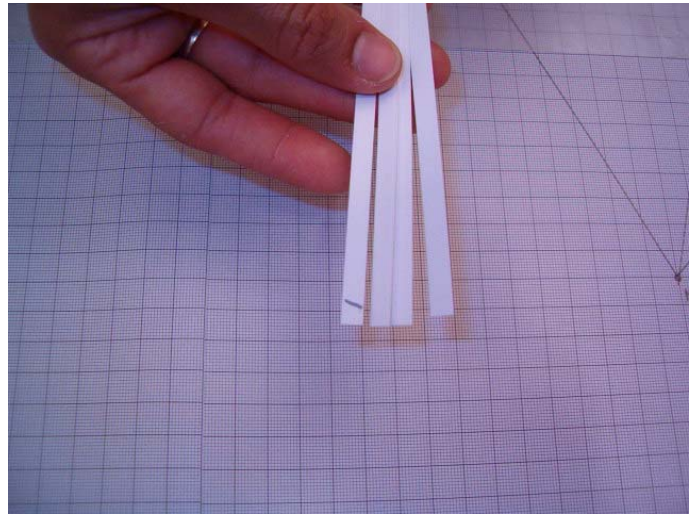

2. Stack identical bars on top of each other (🕒 saver).

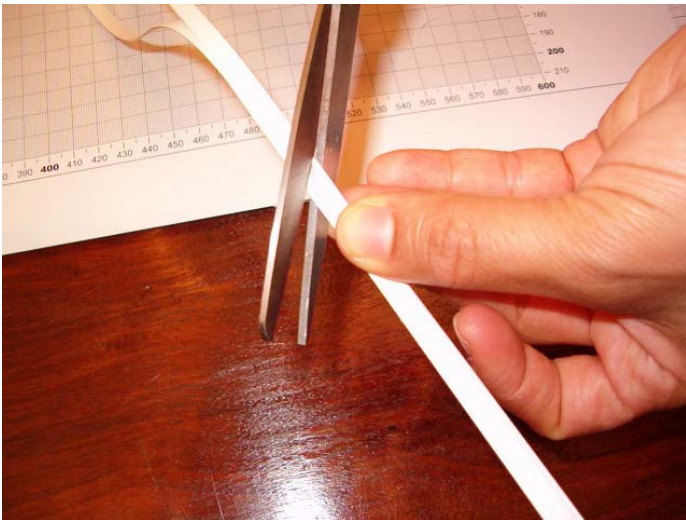

3. Cut identical bars at the same time.

Make schedule of bars needed

Identical bar members	Qty
AH = A'H' = GM = G'M' x 2 trusses	8

4. A schedule of members will make it easier for you to mass-produce needed members all at once.

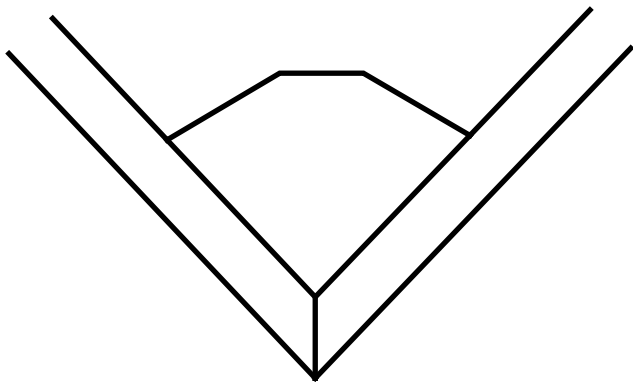

Bars should be cut so they meet like this.

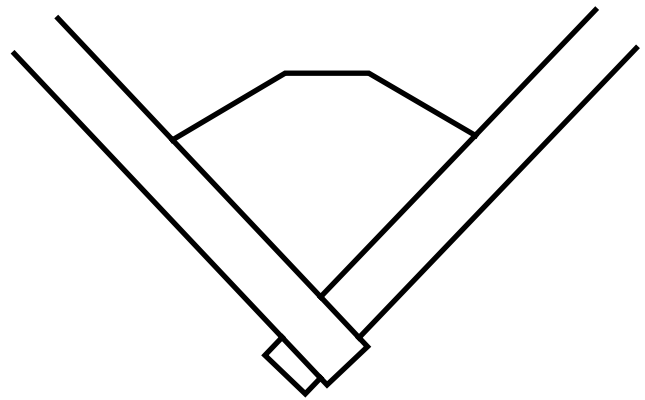

Do **not** overlap bars.

Custom Members: If you want to print a custom member or run out of something (e.g. gusset plates), some different templates are on Blackboard.

Three pieces of cover stock are provided in your construction kit for this purpose. Before printing on the good cover stock paper, print a proof and check that the print is the needed size.

8. **Glue All Bars:** Glue the bars to the gusset plates on both sides of the mirror line. Make sure that you pull snug before the glue sets.

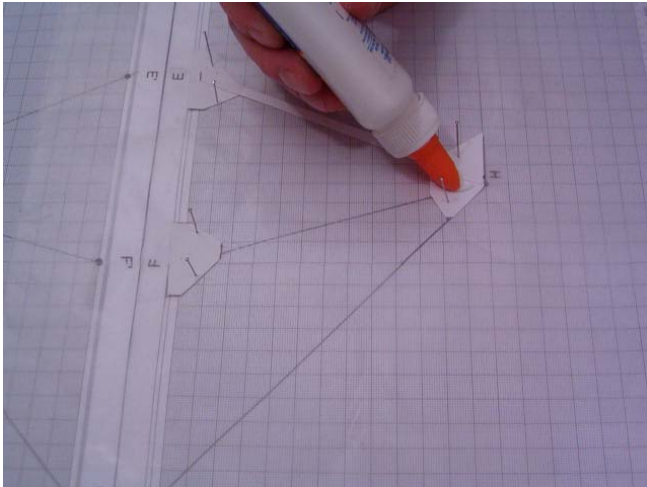

1. Apply a thin layer of glue where each bar will attach to the gusset plates. Do not use too much glue. **Construction Tip:** Only open your glue nozzle just a little.

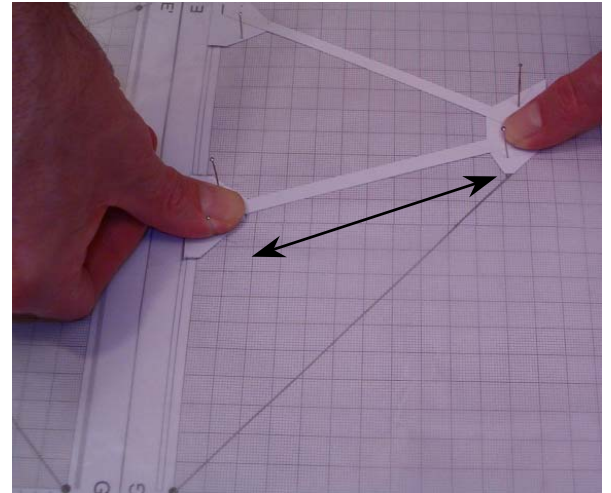

2. Pull out "slack" in the bar, before you press down.

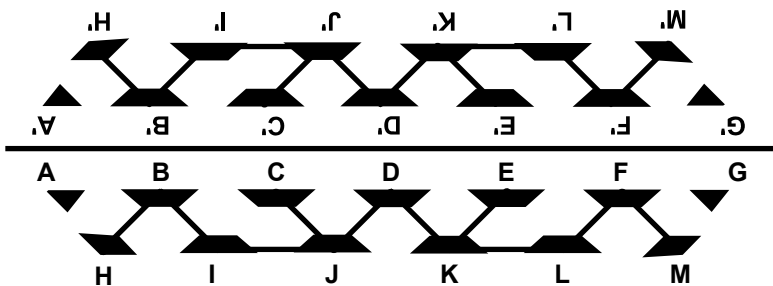

This is purely an example of what your grid area might look like at this point.

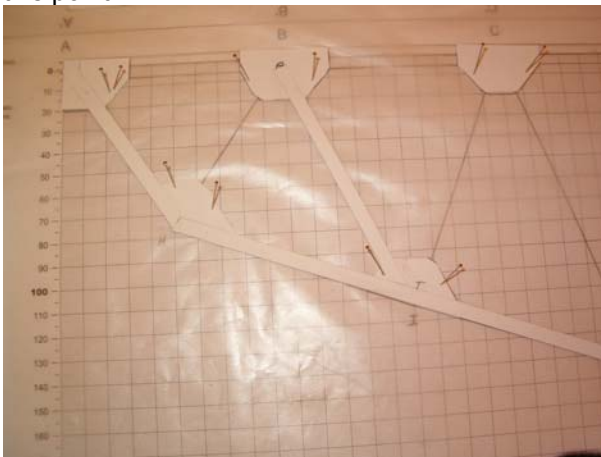

Close-up photo of a gusset-bar assembly.

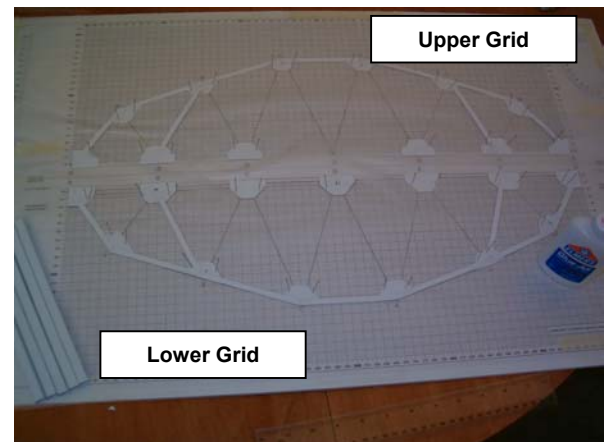

Example gusset bar assemblies (upper and lower grid)

Construct tube stock (practice on some scrap paper, before using your good stock.)



1. Place each score under the clip on a clip board.



2. Pull section back and continue this process with the rest of the tube creases.



3. You can also crease on the corner of a sharp object, such as a table.



4. Crease all scores with more pressure to make easier to work with.

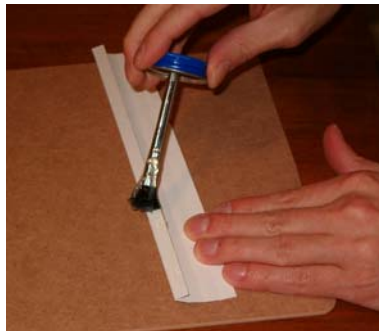

5. Open tube and apply a layer of **rubber cement** to the glue flap. **The glue flap is slightly narrower than the other section of the tubes.**

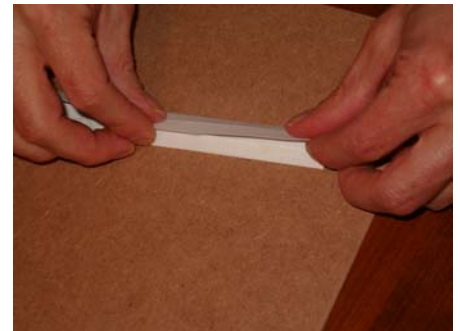

6. Once rubber cement has tacked up for approximately 90 seconds, fold the glue flap under (see below).

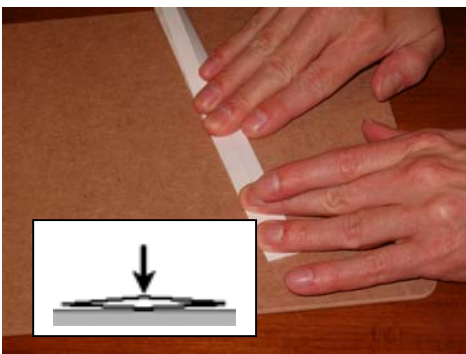

7. Flatten tube down with a good amount of pressure along the tube's entire length.



8. Square tube back up.

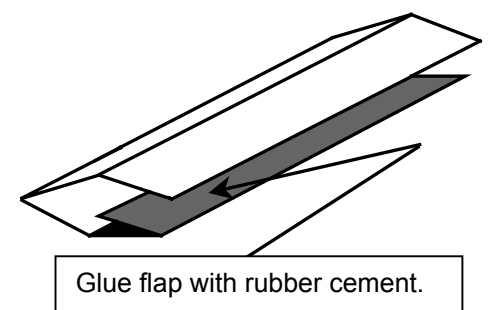

Tube Illustration

Don't forget to make floor beams and struts at the same time you make the other tube stock (see next page).

Warning: Only use rubber cement to make tubes; it is ideal for this. However, do **NOT** use rubber cement to connect members to gusset plates.

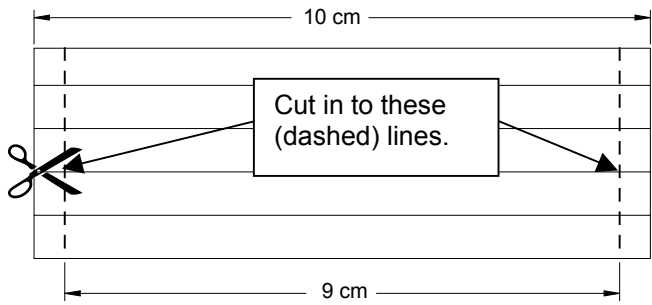

Note: to make your floor beams and struts, use 7mm tubes. Cut these to 10 cm. Draw lines parallel to the ends, 5 mm in from the ends. Cut from the ends to these lines (dashed lines in the illustration to the left), then glue up with rubber cement. You need 1 floor beam or strut for each joint in the lower grid.

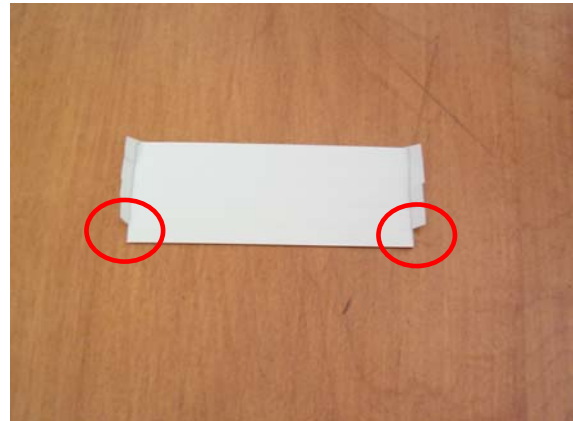

Cut away one outer glue flap, so only four remain on each end.

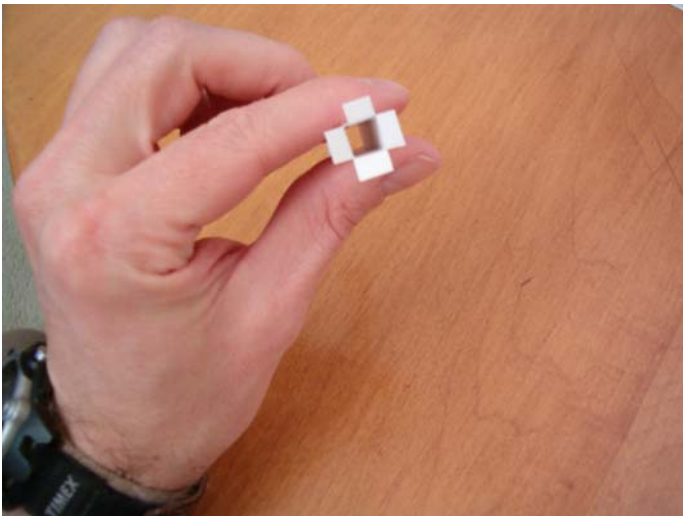

Example of floor beam or strut, once assembled.

9. **Line and Cut All Tubes:** Tubes must be carefully flattened to cut. Carefully make the tube square again. You only need tubes on the lower grid. See next 2 pages for cutting angles on tube ends.

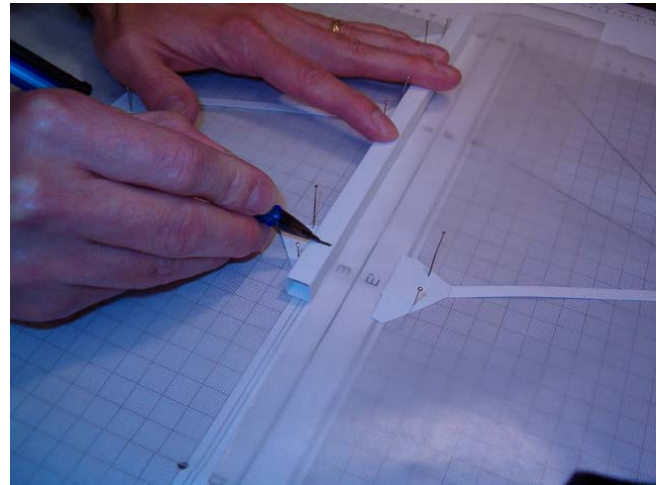
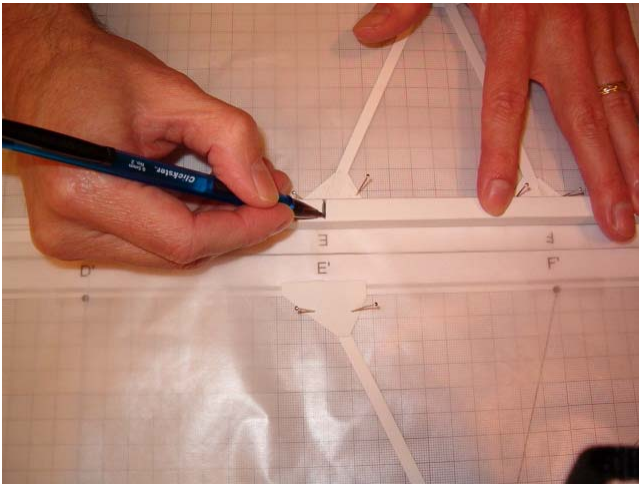

1. Mark tube. The roadbed will need three tubes to span the 60 centimeters.

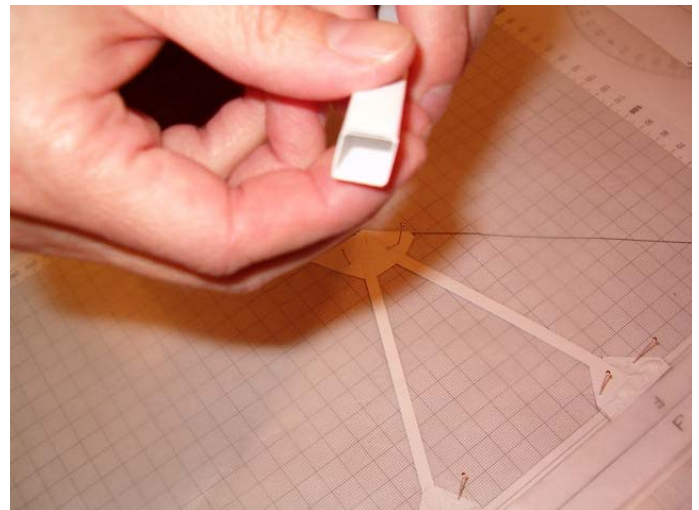

2. Carefully press the tube flat to cut.

3. Square the tube back up after cutting.



Note: Once you cut one tube, you can use it as a template to line off other identical tubes (🕒 time saver).

Roadbed tubes can span two joint locations.

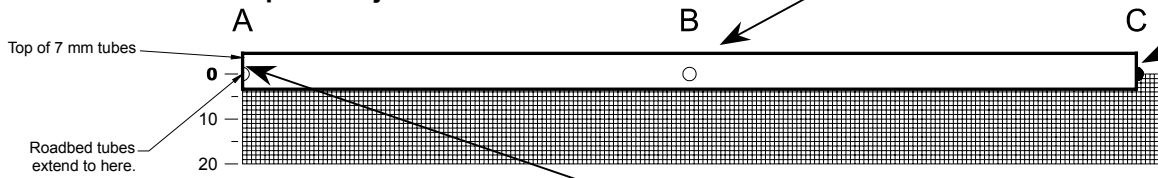

No need to cut tubes here.

Cut straight (90 degrees) for roadbed tubes. Butt roadbed tubes together at this joint.

Top of 7 mm tubes
Roadbed tubes extend to here.

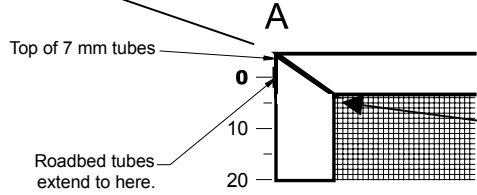

Reinforce end tubes with a short vertical tube.

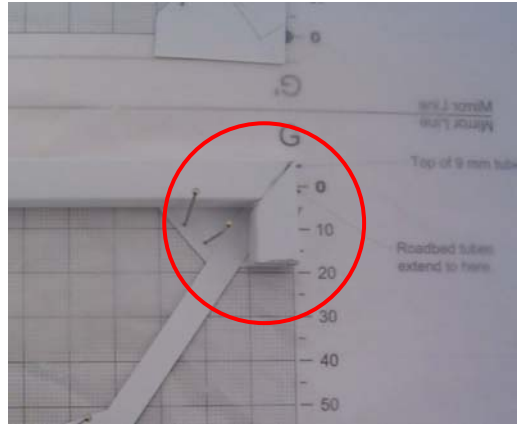
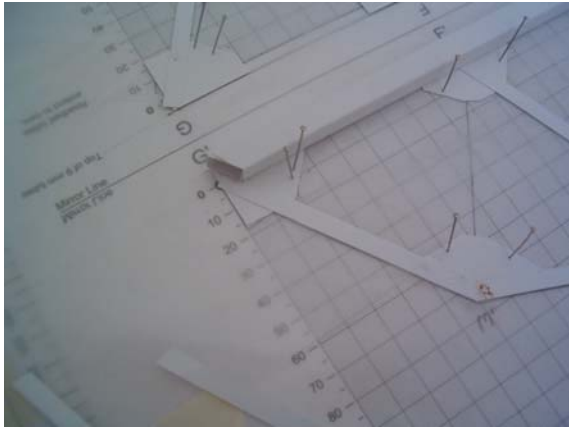

Cutting angles on the ends of tubes is easy once you get the idea. Line off the angle on opposite sides, then make three cuts as illustrated below.

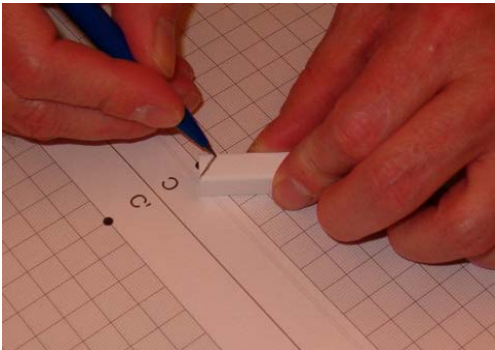

1. Line angle

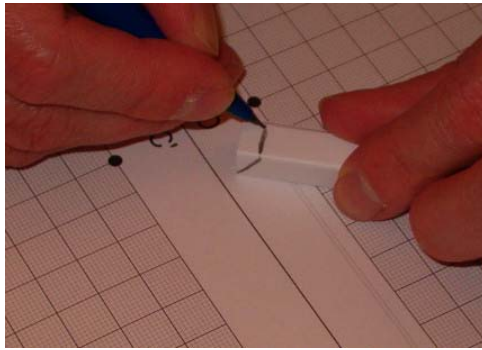

2. Rotate tube away from you 90° and line across straight across.

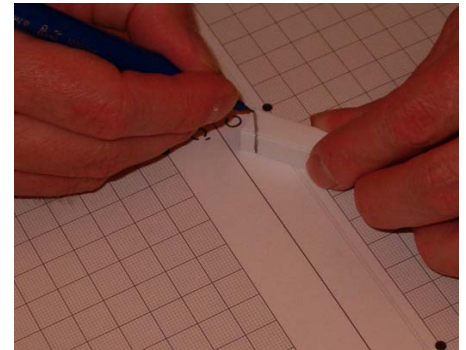

3. Rotate 90° again and draw to opposite corner.

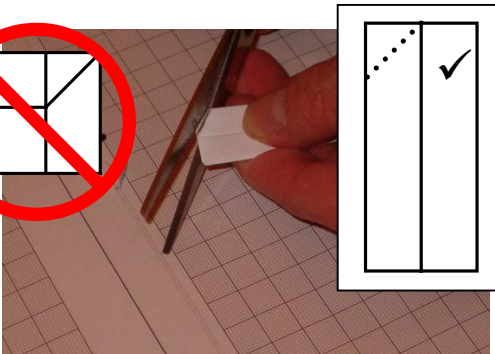
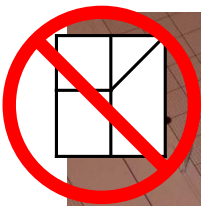

4. Cut the angle toward the crease of the tube.

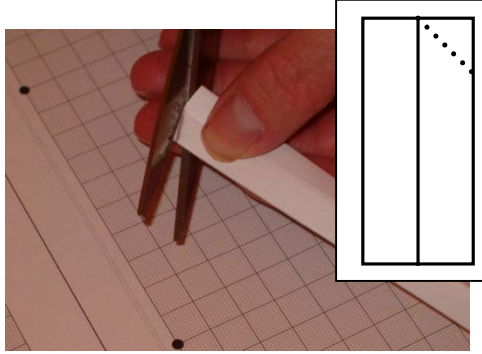

5. Open tube and fold the other way. Cut this angle.

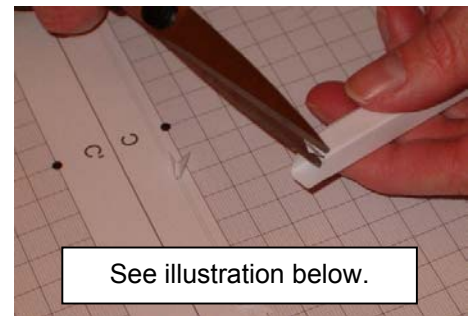

6. Snip out or **fold in** the excess triangle that is on the straight side that is shorter in length.



7. Finished product.

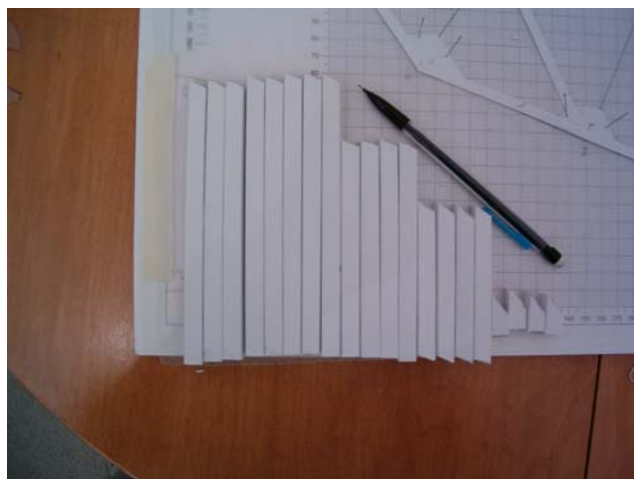
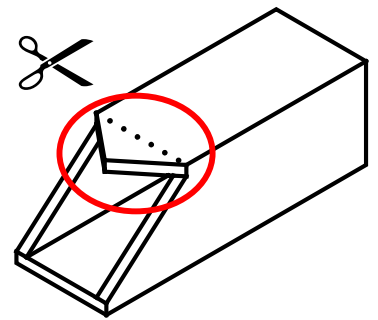
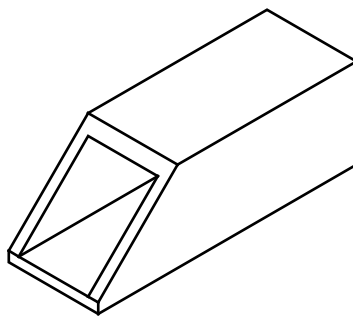

Example of ready tube members.

Remember that you need two bars for every doubled bar member, but only one tube for every tube member.

10. **Glue All tubes:** Glue all tubes on lower grid.

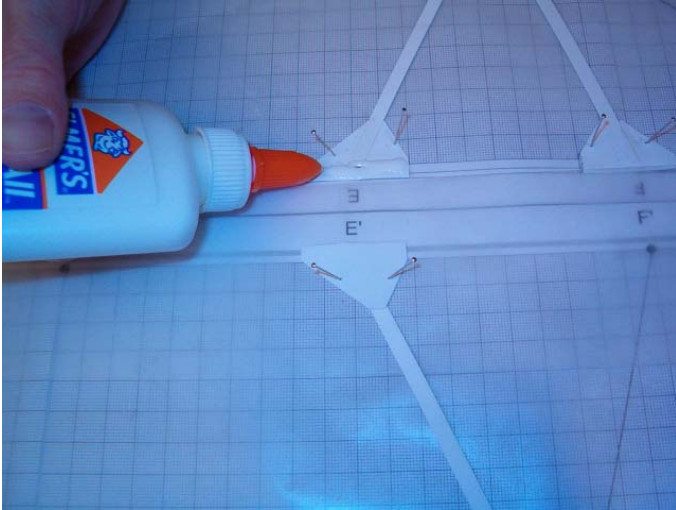

1. Apply glue to the gusset plate everywhere the tube will make contact with it.

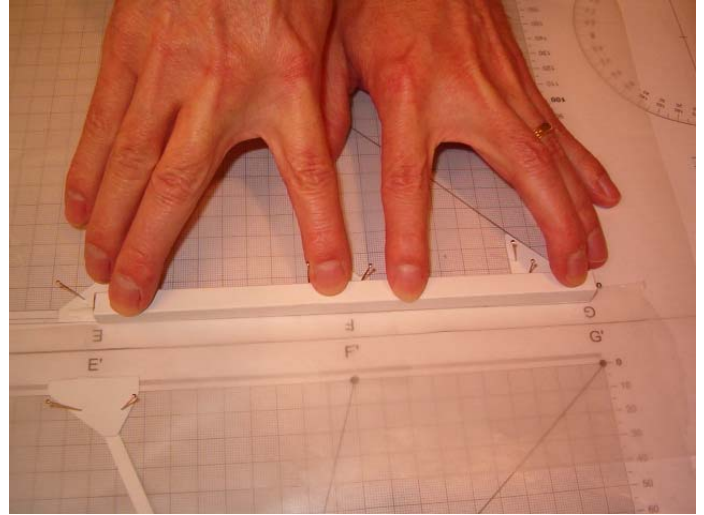

2. Apply light pressure down on the tube at the gusset plate locations for at least 30 seconds. Member is repositionable for the first few seconds.

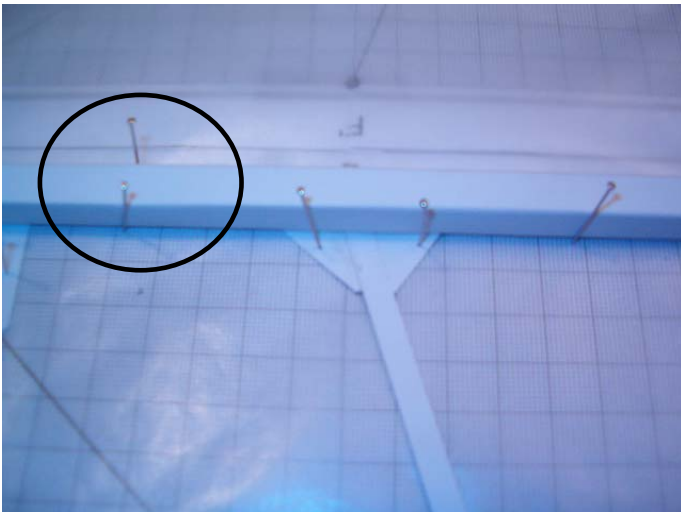

3. Use pin to square up tube for the next step.

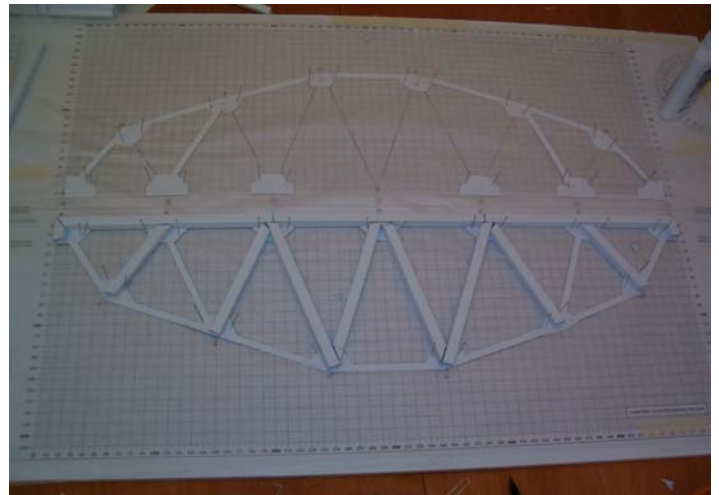

Note that tubes only go in the lower grid.

11. **Assemble Sides:** Remove all holding pins. Carefully peel up the upper gusset-bar assembly. Glue the assembly from the top grid on top of the bottom grid (i.e., the one with tubes). Do this one section at a time, making sure the bars do not become overly slack. Work from the vertical centerline of the truss out (\leftrightarrow).

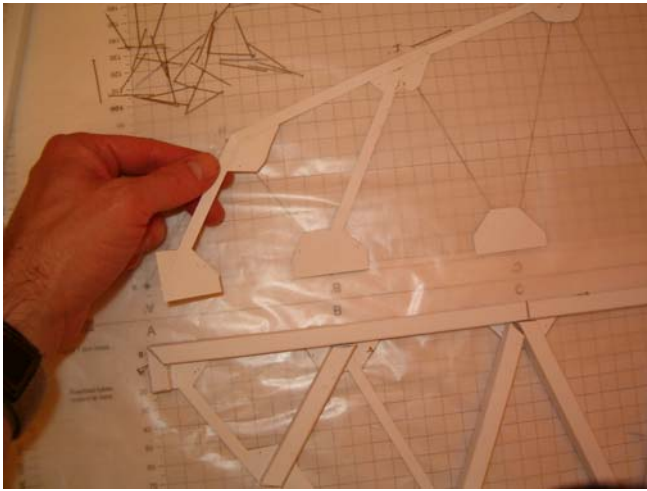

1. Carefully peel up gusset-bar assembly from the upper grid.

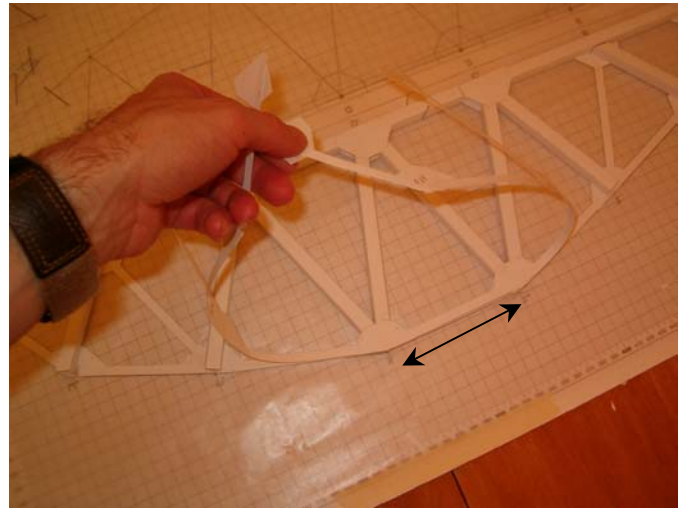

2. Work from center line out, one section at a time. Make sure that the bars do not become overly slack. Pull out \leftrightarrow as glue sets.

12. **Double check glue joints:** Make sure you all gusset plates have been glued. It is easy to overlook one.
13. **Repeat** the above process for the 2nd main truss. You should have already cut the members and gussets, if you did the schedule of members correctly.
14. **Finish up the Bridge:** Draw layout lines in the lower grid for the roadbed tubes from the two main trusses. These roadbed tubes from each of the main trusses should be parallel and 9 cm apart.

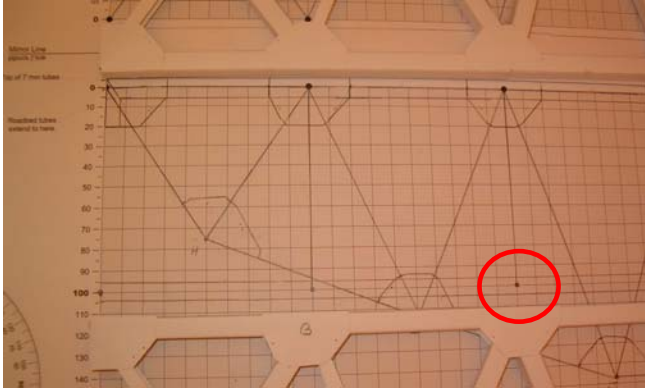

1. Layout roadbed tubes and joint locations for the floor beams.

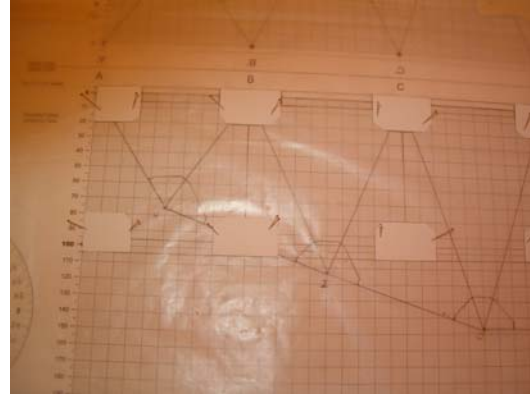

2. Make gussets for the floor beams. **Make sure you remember the wax paper.**

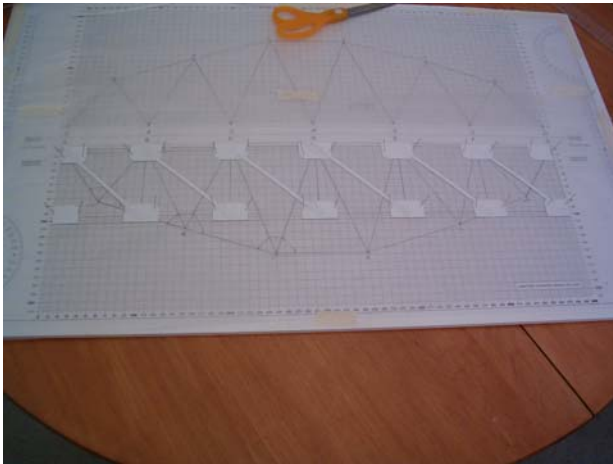

3. Layout lateral bracing bars. Don't over design these in this case, because lateral bracing is primarily for cross loads created by the wind. There won't be much wind in your dormitory.

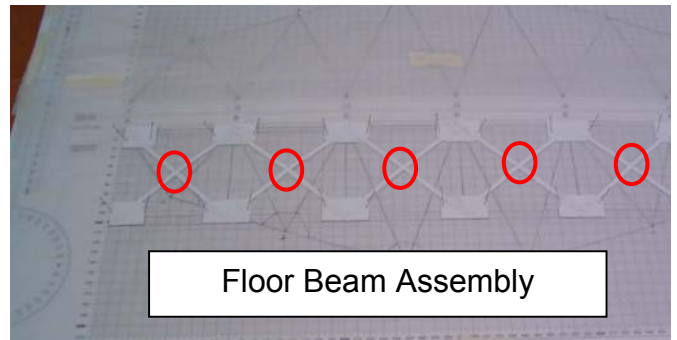

4. Layout lateral bracing bars in the other direction. Remember to put a dab of glue at the crossovers.

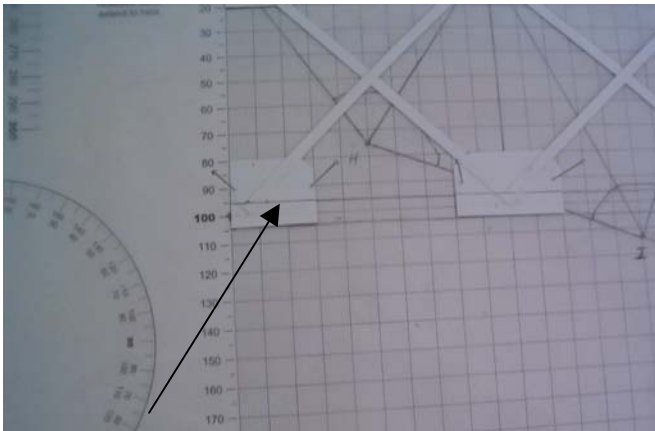

5. Draw lines across the gusset plates that are even with the inner edges of the roadbed tubes.

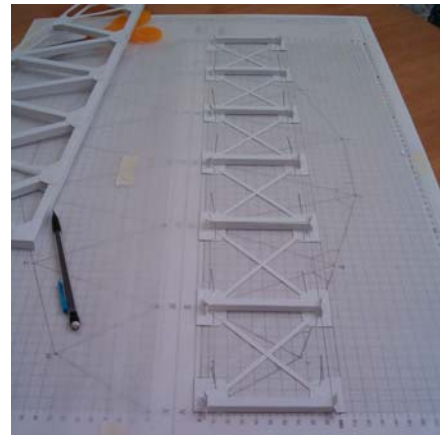

6. Precisely glue floor beams to the gusset plates so that the floor beam ends align with your lines from step 5.

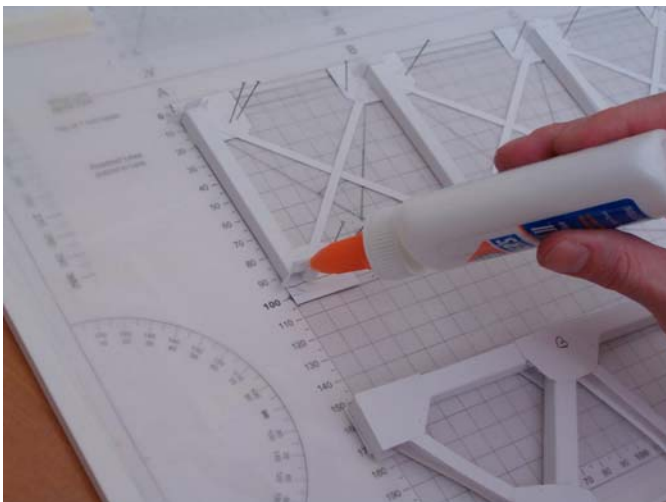

7. Apply glue to the floor beam glue flaps and the gusset plates for one side of the bridge.

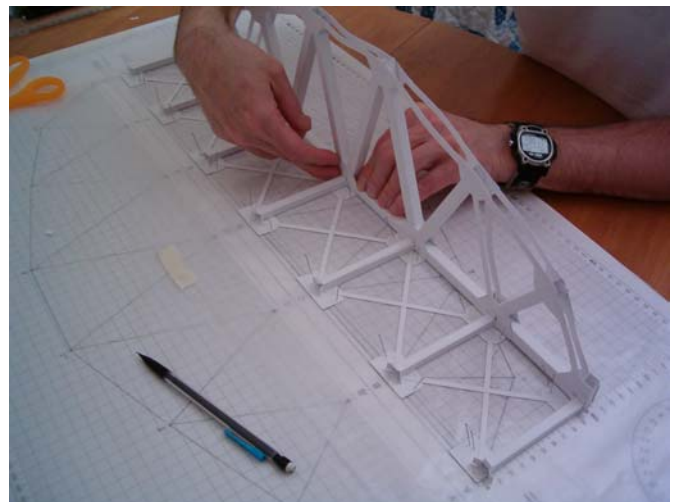

8. Press down at each joint location for several seconds and make sure that you push in towards the glue flaps on the ends of the floor beams. **Also, press these glue flaps briefly, so that they adhere to the main truss. Make sure you are holding the main truss at a right angle to the floor beams.**

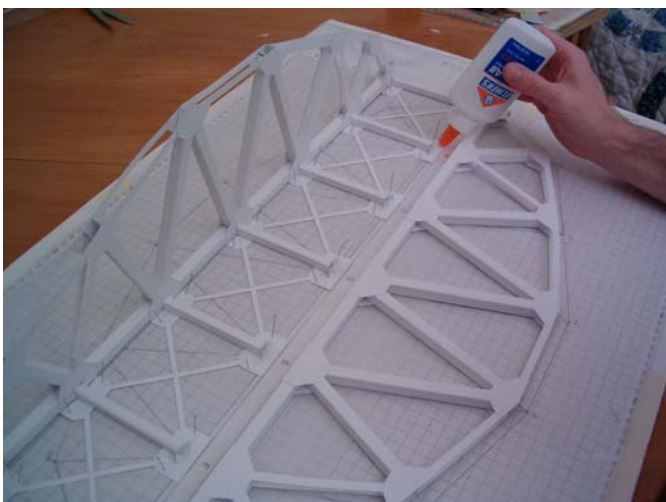

9. Apply glue to the other side of the bridge.

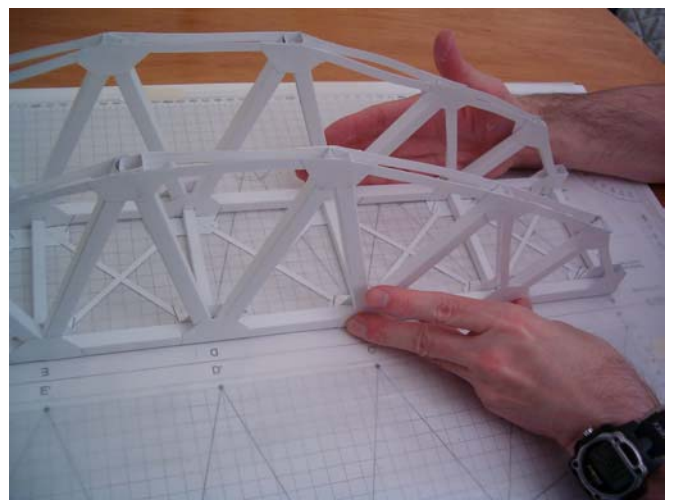

10. Glue the other main truss.

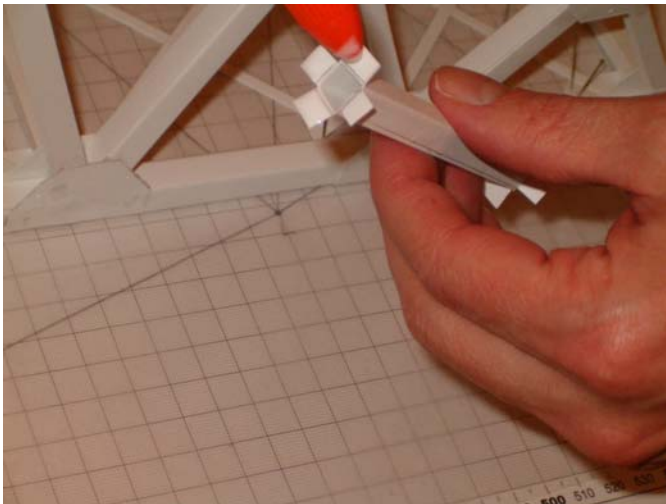

11. Apply glue to the glue flaps for the struts.

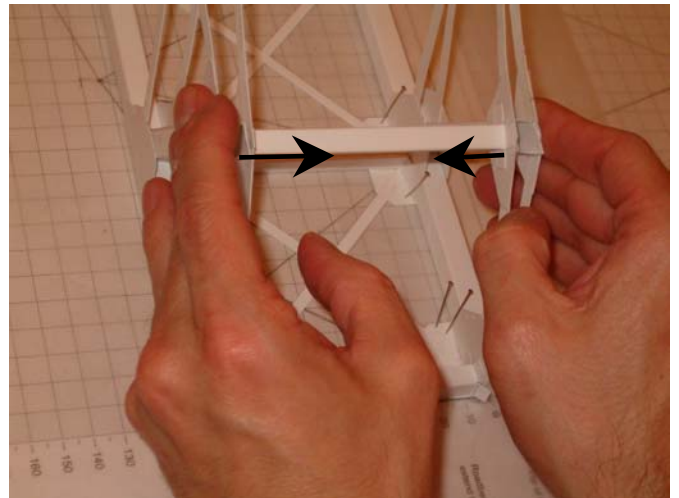

12. Glue the strut into place. Hold for at least 30 seconds with light pressure. Press on each individual glue flap during this time.

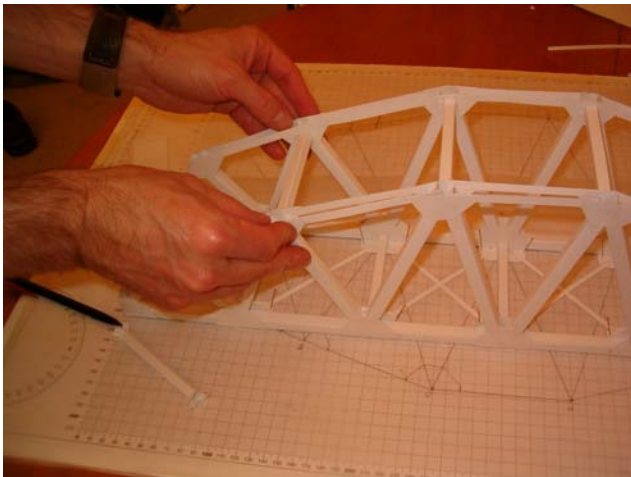

13. Glue the remaining struts.

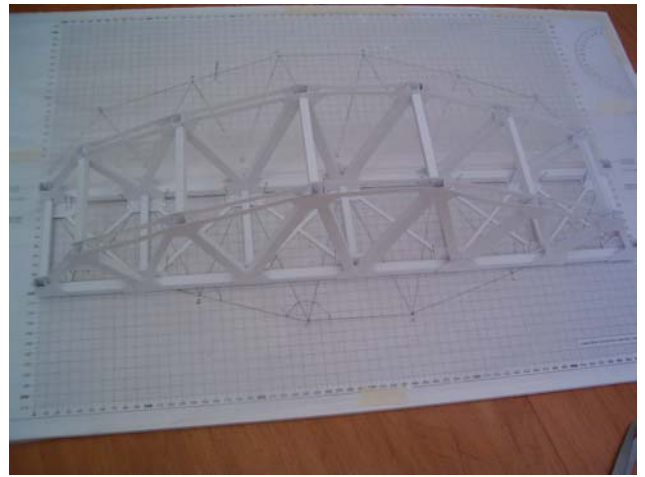

14. Congratulations on finishing your bridge. Let it dry over night, before load testing it.

Load Test Your Bridge Design



1. Tape six sets of two-quarter dollars together tightly. Then tape these to joints C, D, and E, as well as C', D', and E'. **Loads should only be applied at joints.**

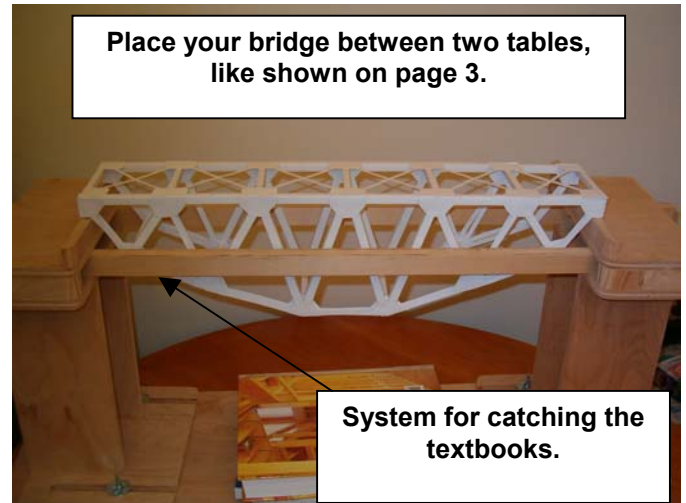

Place your bridge between two tables, like shown on page 3.

System for catching the textbooks.

2. Span your bridge between two tabletops. You need to devise some type of system to catch the textbooks, in case your bridge fails. Otherwise, if it fails, the textbooks will crush the bridge. Two team members can stand on either side of the bridge, while another loads it. There is still a risk that someone might drop the textbooks.

Items for load test	Mass (kg)
1074 Chemistry text* + Student Solutions*	3.008
1084 Chem Lab Text*	1.050
ENGE 1024: Concepts in Engineering*	0.539
total	4.597

Other Items	Mass (kg)
ENGE 1024: Alice Programming Text	0.766
1114 Linear Algebra	0.624
100 sheets 20 lb. Ink jet paper	0.497
total	1.887

***Carefully and slowly load these 4 textbooks onto the bridge. Once you have loaded the bridge, take a digital photo and make a print to turn into your instructor.**

Optional: Continue to load the bridge until it fails. Note the mass at failure. Find access to an electronic scale or triple beam balance. Take the mass of your bridge. Calculate your efficiency factor.

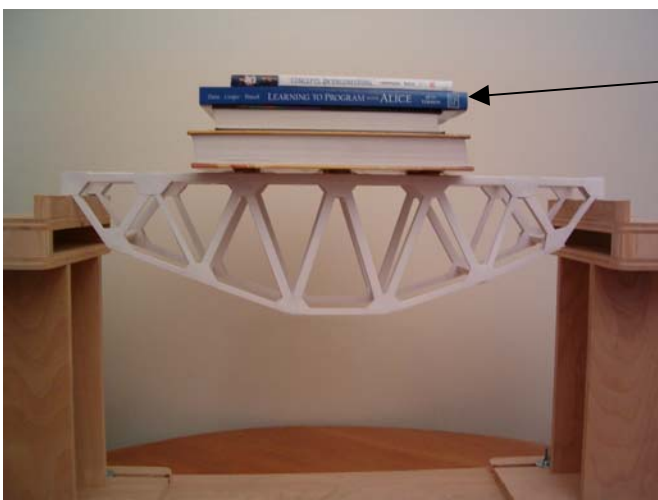

1. Example load test. See table above for actual texts to load.

Make sure textbook titles are clear in the photo.



2. When you take the photo, make sure the binder titles on the text are visible in the photo.

Individual 😊 Written Reflection (optional, but recommended)

Instructions: After completing the other requirements for the *Bridge Challenge*, write a reflection of your experience in the bridge challenge. In the reflection, discuss what you learned. You may want to address some of the following questions in your reflection:

What is the relationship between tensile strength and cross sectional (see below) area of a member?

What is the relationship between tensile strength and length of a member?

What is the relationship between compressive strength and cross sectional (see below) area of a member?

What is the relationship between compressive strength and length of a member?

Do you think any of the members were designed as the wrong type (e.g., a double-bar should have been a tube)?

If your bridge supported the 4.6 kg load, then is there anywhere you think the bridge model is over designed?

Why is the factor of safety important with structures?

How are the members with *Computer Bridge* alike and different from the Card Stock Members?

Why is card stock a more realistic modeling material for a model bridge than balsa wood (hint: balsa wood bridges typically fail at the joint)?

What math, science, and engineering principles go into a bridge design?

How did you and your team apply the engineering design process to the two problems?

In what ways did your team work together effectively, and in what ways did they not work together well?

Did your team adequately explore alternatives at critical design decisions?

Is the load applied equally at C,D, and E, or do some joints receive more forces than others?

What is the difference between a static and dynamic load?

Why do the “load test results” in the software show some members in both compression and tension?



Cross-sections for hollow members.

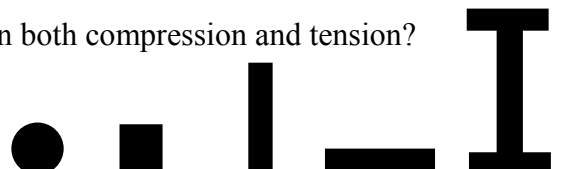

Cross-sections for solid members.

Note: Some graphics on page 1, 11, and 14 were created by Stephen Ressler.