

Motor Cover (piece 1 of 2)

Plastic

1:1

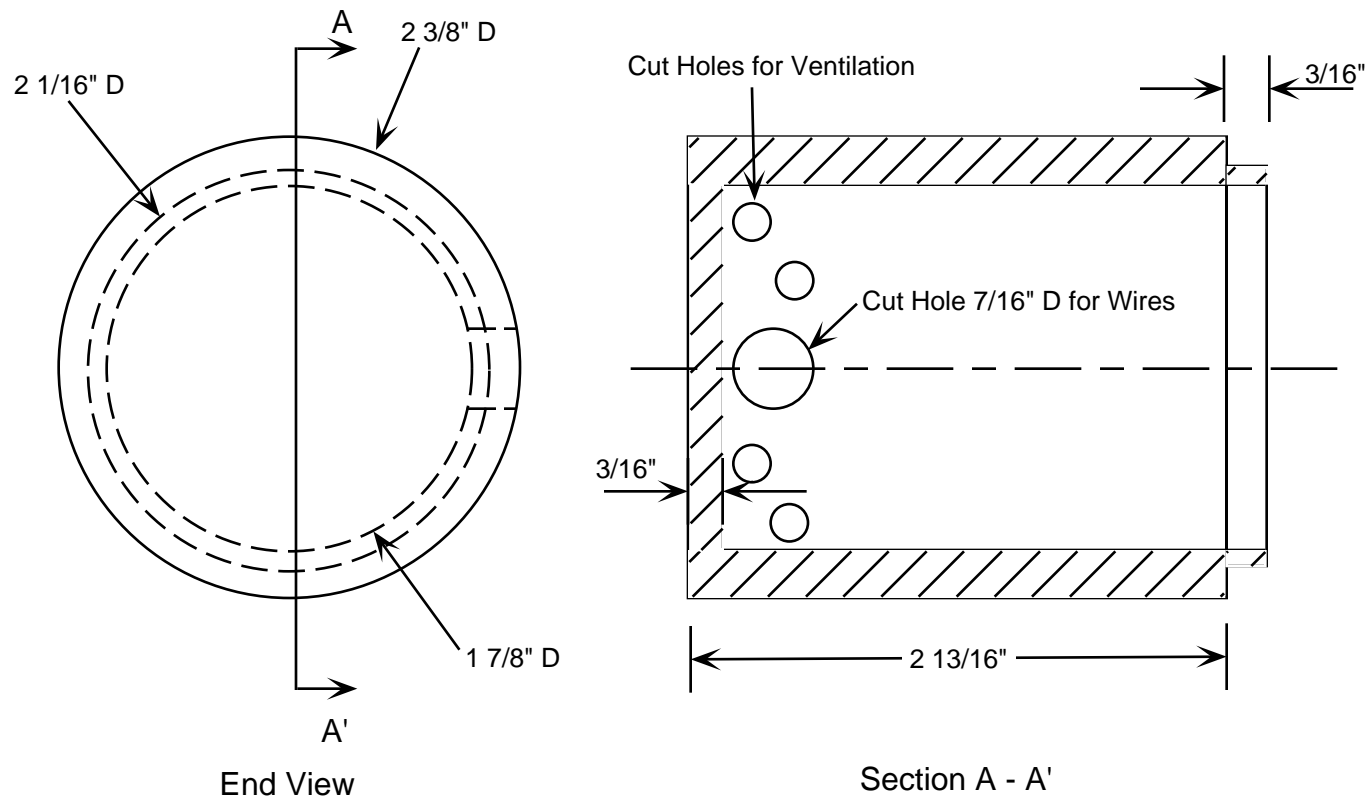

Figure A-26. Motor cover (piece 1 of 2).