

26. Book Hill Park is the highest area in Georgetown. Standing on Wisconsin Avenue you can see the historic stone retaining wall holding back the hill.



27. The Georgetown Library now stands on the original site of the Georgetown Reservoir. A fire in 2007 claimed most of the stacks and it is currently being rebuilt.

28. There are still remnants of the reservoir, like the iron fence with its trident posts at the bottom of Book Hill Park.

29. This composition is a panoramic view from the top of Book Hill Park looking down Wisconsin Avenue.

30. A plaque is displayed at the entrance of Book Hill Park.

31. The historic stone wall built by Montgomery Miegs still stands today.



27.



28.



30.

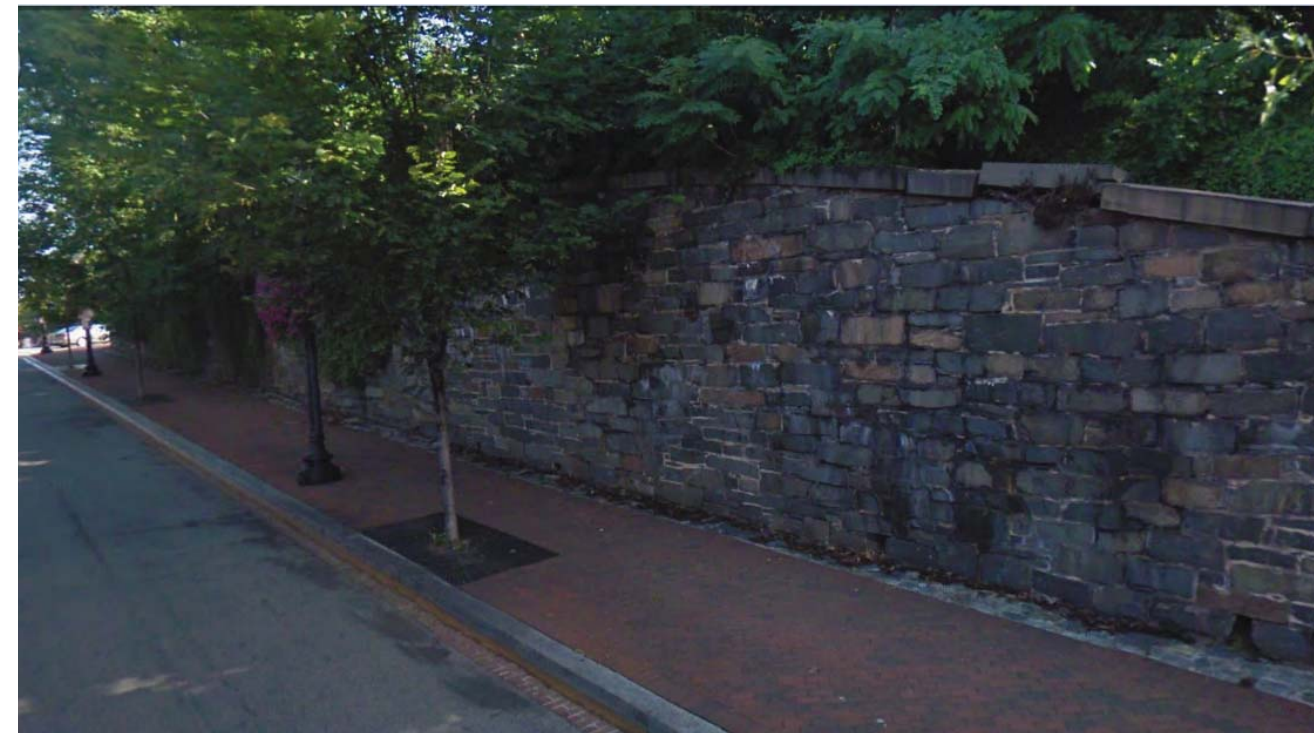

31.



29.

32. The Baist maps are real estate maps that assess property lines, building materials, and supply lines. This Baist map from 1913 show the placement of the Georgetown Reservoir.

33. In 1945, the Baist map shows the Georgetown Library in the place of the reservoir.

34. Existing Site Model from above

35. Existing Site Model from Wisconsin Avenue.

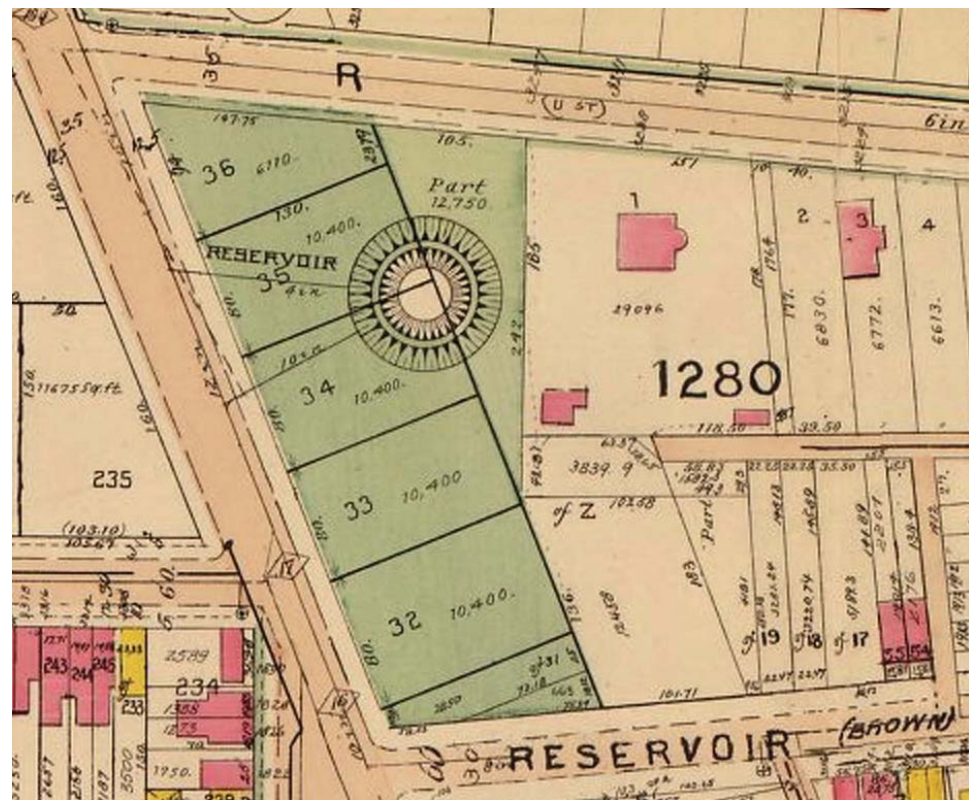

32.



33.



34.



35.

surrounding
 inset bed

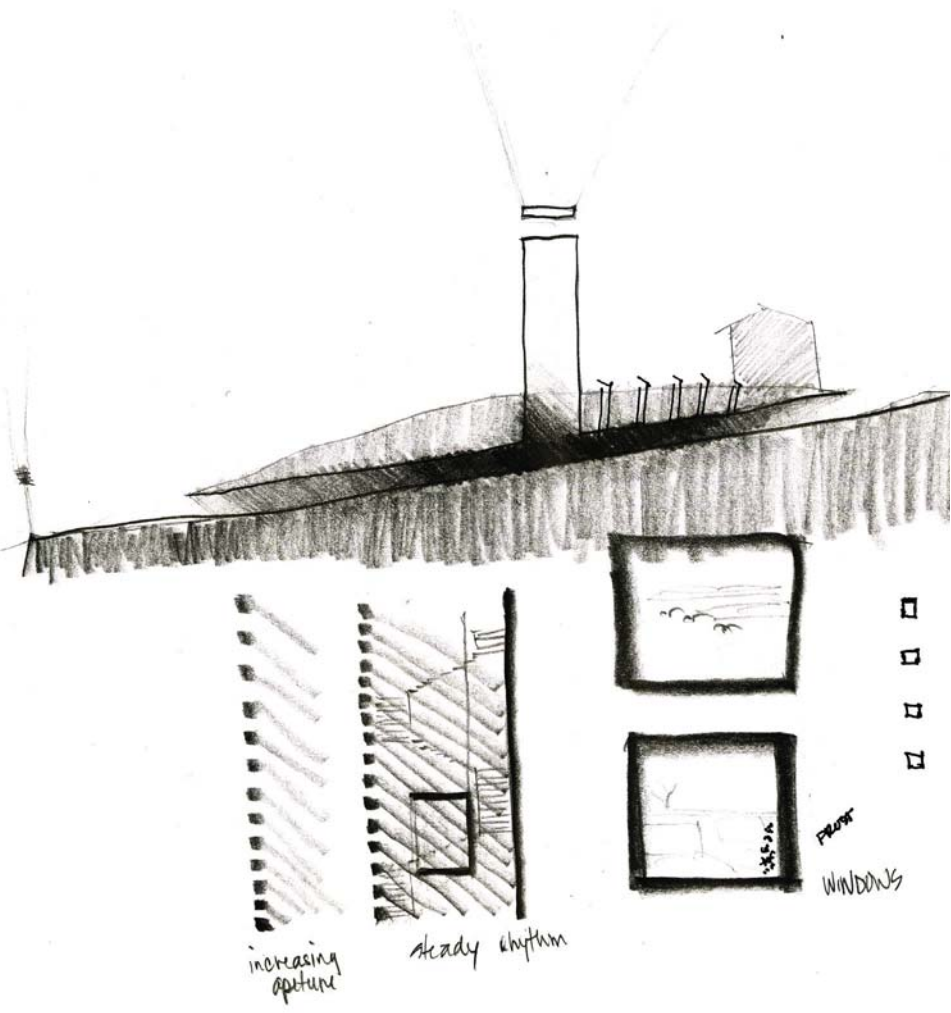

MEMORY: Guggenheim Museum
 Anish Kapoor

- fragmented story
- gives the viewer a series of views that allows them to draw from their memory the object as a whole

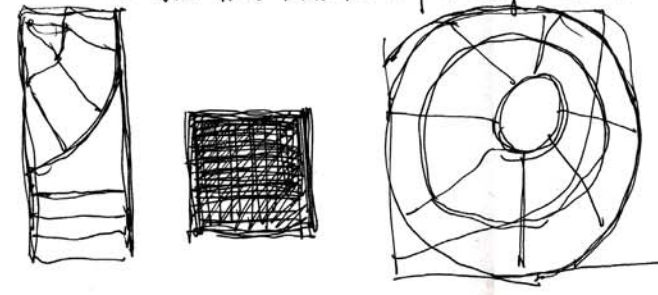

one-ten feet

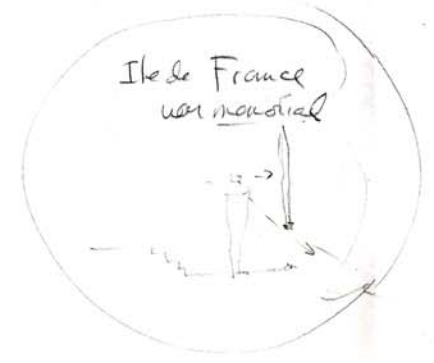

just the water

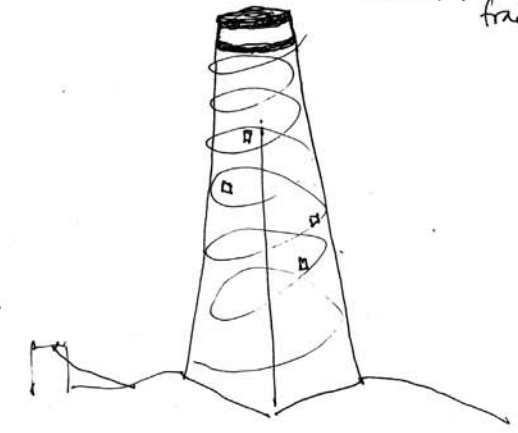
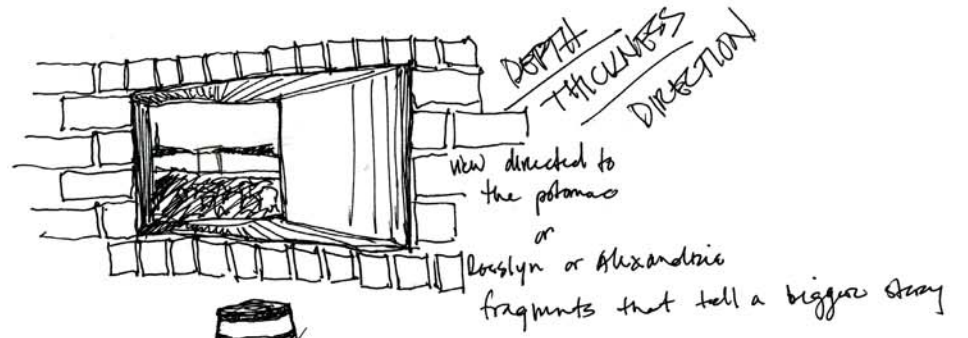

central views
 FLASH FILM. focus cinematically - story
 glimpses - story

types of glass
 magnify
 glowing
 translucent
 "near their memory"

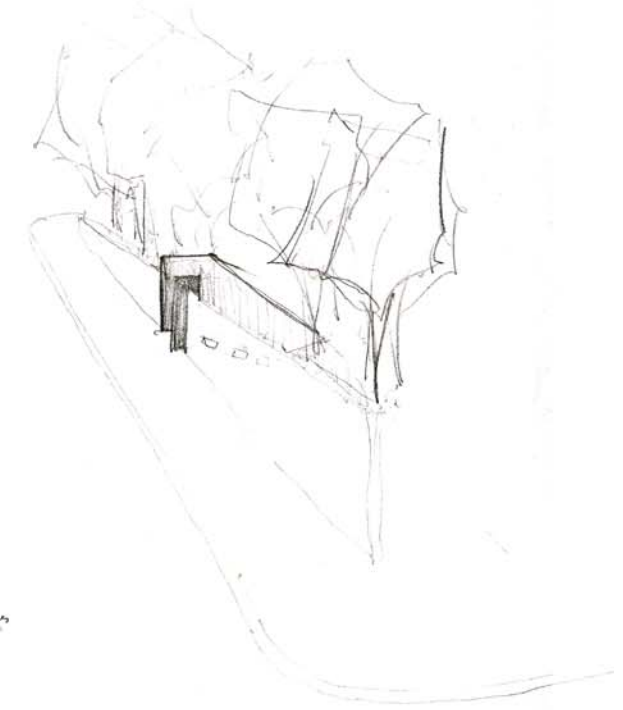

ROLL: My early sketches show ideas behind the entrance and the viewing platforms.

36. This is a small study model exploring methods on how to span the openings of the tower.

37. The model shows a rigid platform held by steel members and the masonry walls would be tied together with tension rods.

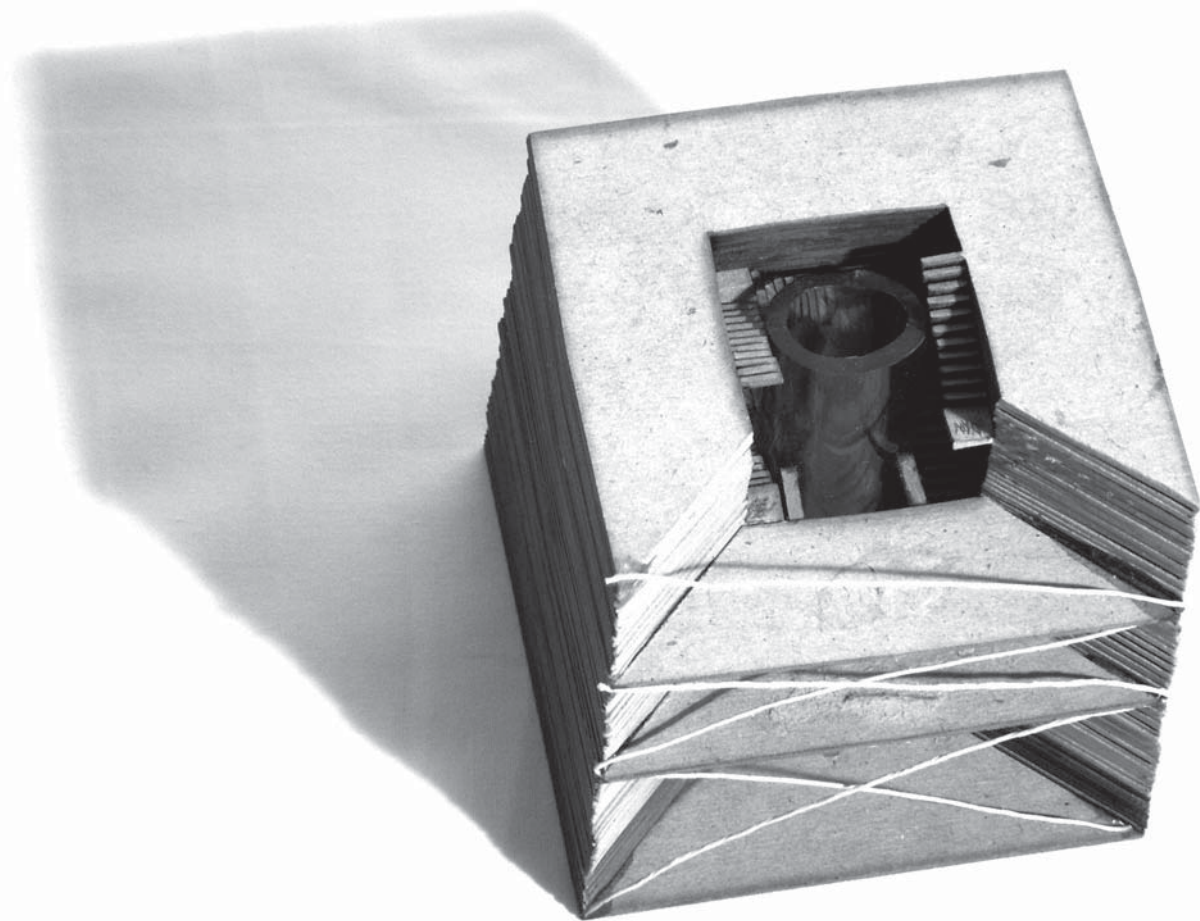

36.

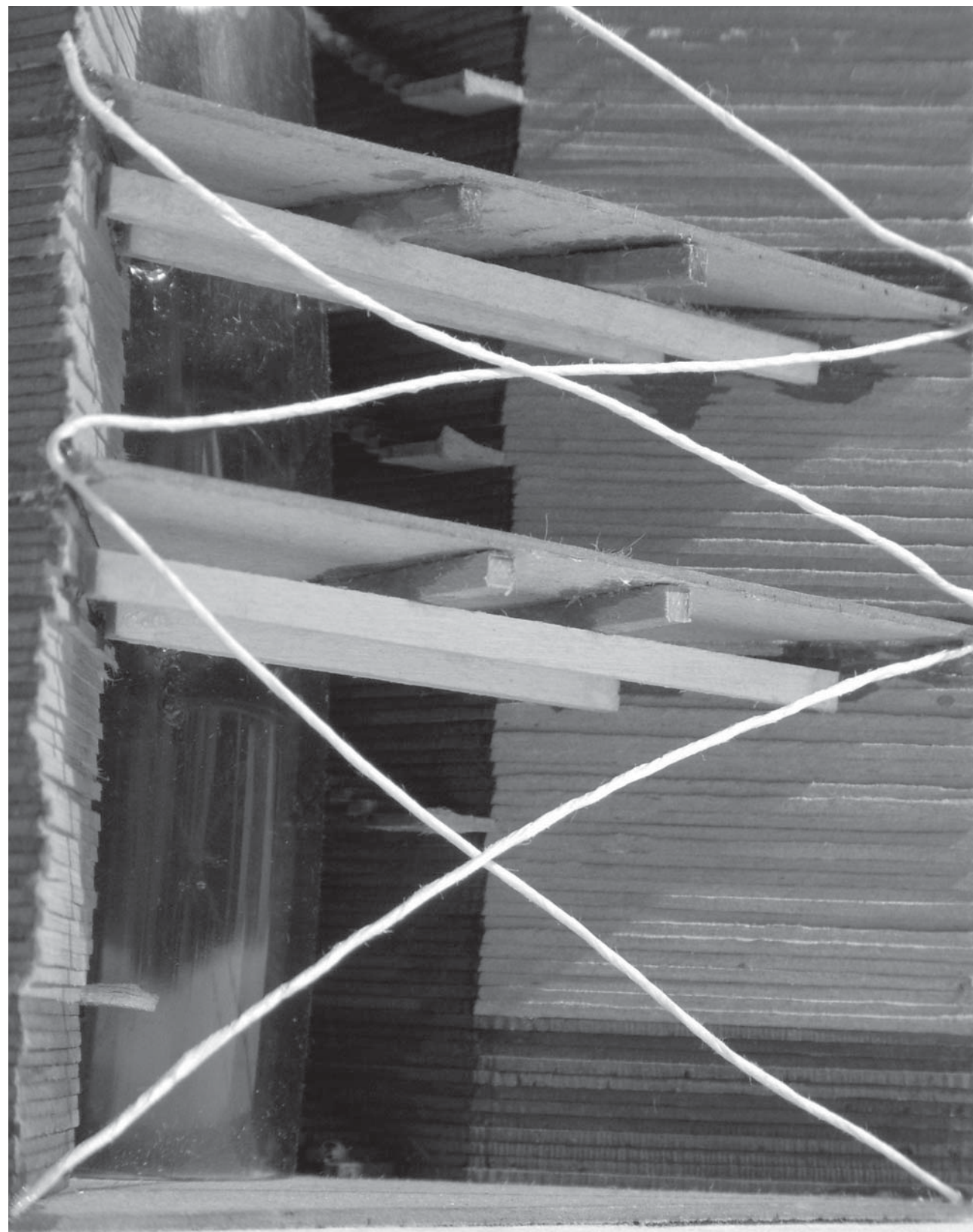

37.

land aqueduct: concepts

transition between two elementary slopes
 resembles the fluid transition of water
 aqueduct provide steady pressure to DC & VA

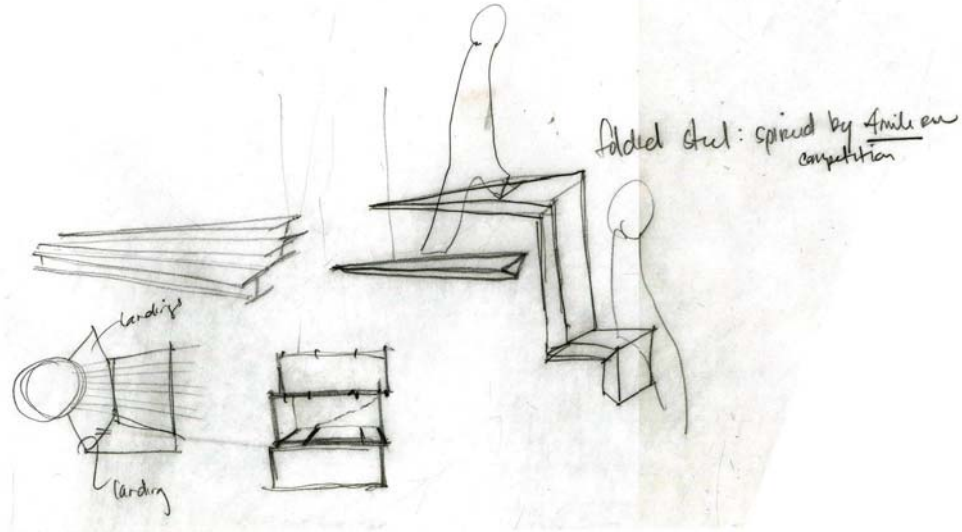

elevator stays stationary
 services on bottom floor

view platforms gradually turn to the water
 follows path of aqueduct (down Wisconsin → P St.)

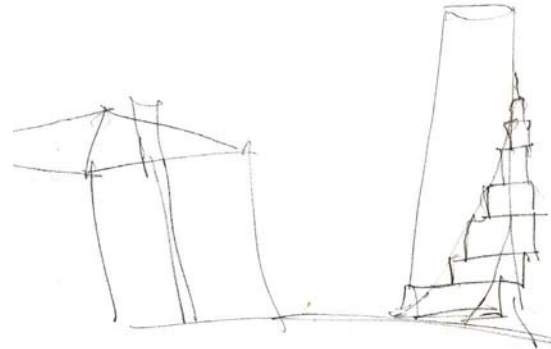

STEEL

leave tunnels as \cap it is
 site specific
 use corbel as a signifier, an
 element that ties everything
 viewing platforms structure in steel

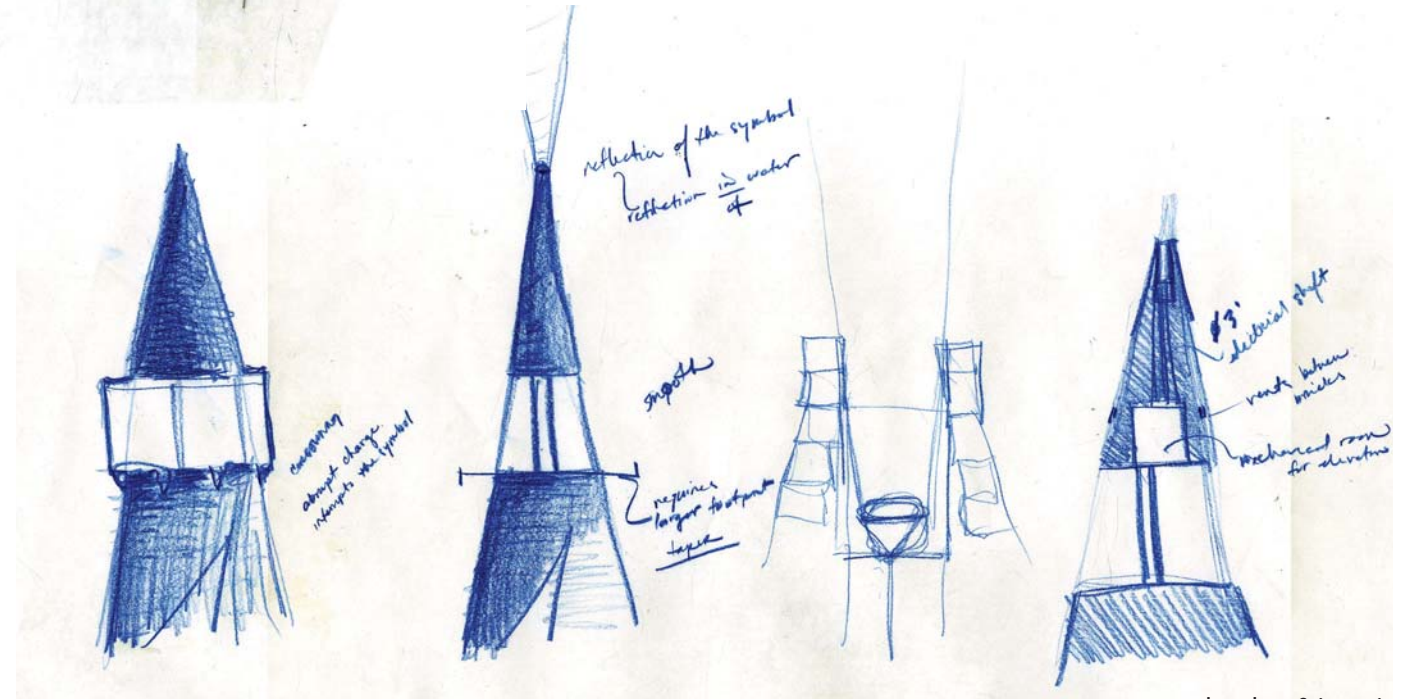
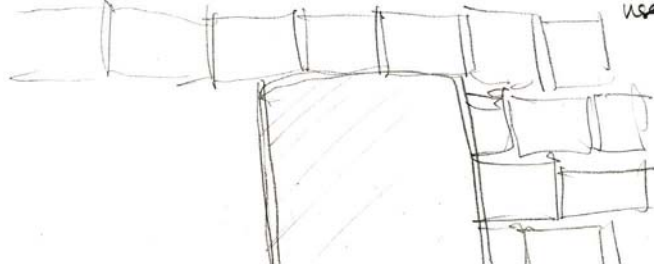

sketches & iterations 50

ROLL: The sketches above are explorations into the transitional stairs.

I struggled with how to end the tower and it was helpful to draw out some scenarios as to how it would appear.

As a figure of forgotten waters, the tower symbolizes the steady flow of the water that was provided long ago by the reservoir. The concept for the tower is a steady transitional movement. The shape of the tower transforms from a square at the base to a circular viewing platform at the top. At the base it was necessary to have a shape that symbolized a rooted foundation. The foundation goes down even further sitting on piles that stand on solid bedrock. At the top, the circulation of people took precedence and so the shape was influenced by their movement.

Visitors enter from the highest point on Wisconsin Avenue through a corten steel tunnel. The tunnel slowly ramps down to a main chamber where the visitor can either take the stairs 333 feet up to the observatory deck or take the elevator. The elevator is forced to move by the water pressure provided by two water pumps. The two pumps, one at the top and the other just below the main chamber, draw their water from the well at the bottom of the tower. Visitors taking the stairs will pass the viewing platforms that slowly transition from north to south following the path that the aqueduct pipelines took down Georgetown.

When the visitors arrive at the observatory deck they immediately see that they are surrounded by the city. To aid the visitor in positioning themselves, double columns are located at the cardinal coordinates. The southern view from the top of the tower extends down Georgetown and past the Potomac River in to Virginia.

At night the top of the tower is extended to the sky continuing the silhouette of the tower.

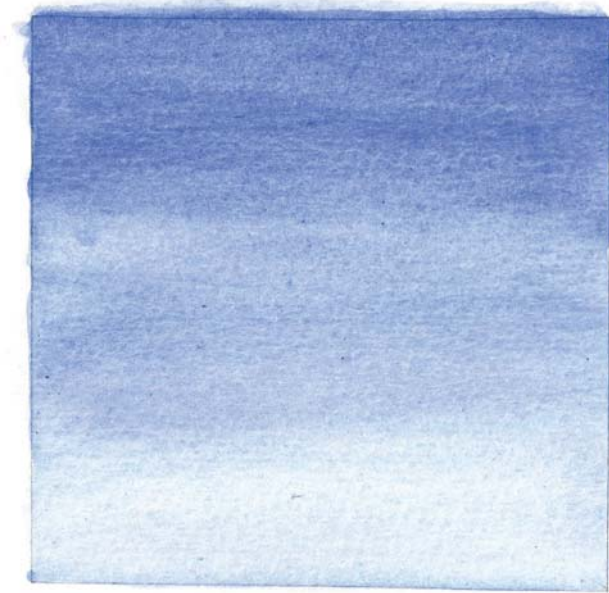

38. The Orvieto well was one case study that influenced the tower design greatly. In Orvieto access to the water was through a double helix stair case. I interpreted this idea into my design by having one set of stair for going up and another to go down, thereby eliminating traffic.

39. This photograph shows the view looking up the well.

40. When visiting New York City in 2010, I saw this exhibit by Anish Kapoor in the Guggenheim Museum. His exhibit explored the idea of memory. How does one remember something? As you enter the exhibit there is this massive sculpture that hardly fits the room. You are only allowed to see peices of the whole. You are forced to put together this object with these small views. In the end you see the back of the whole sculpture.

41. In my design for the tower I struggled with how to take the visitor along the same path as the aqueduct water lines. After seeing this exhibit, it inspired me to open up the tower and give the visitor views of the path slowly and discreetly. The intent was to symbolize the steady and even flow of the water, while revealing the city.



38.



39.



40.



41.

- 1. Entrance tunnel and wall openings
- 2. Exit tunnel
- 3. Book Hill Park entrance
- 4. Terrace
- 5. Georgetown Library
- 6. Foundation walls
- 7. Infill
- 8. Cistern

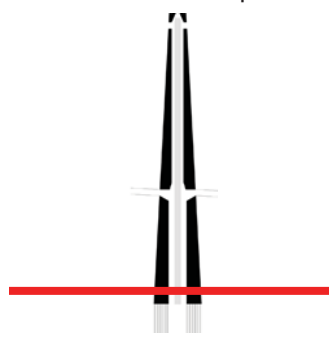
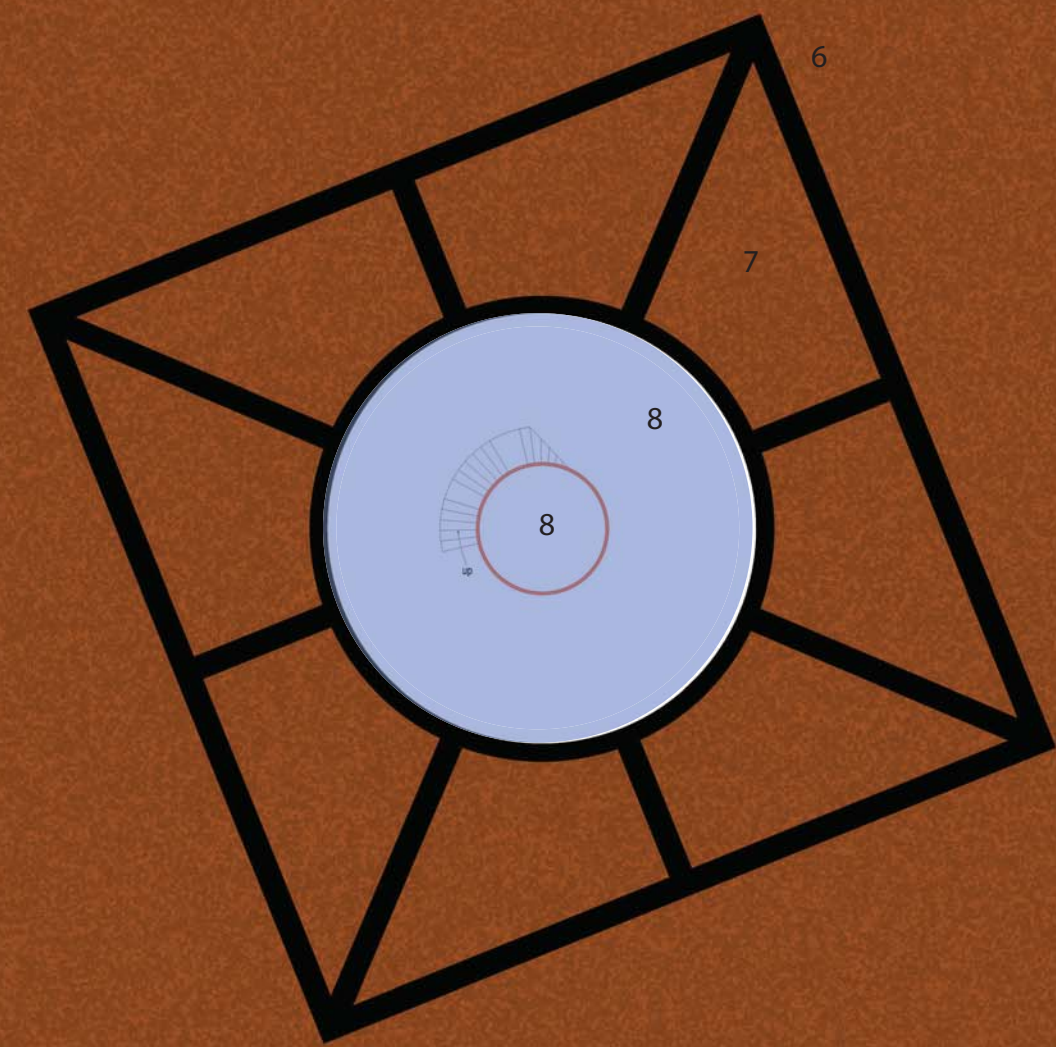
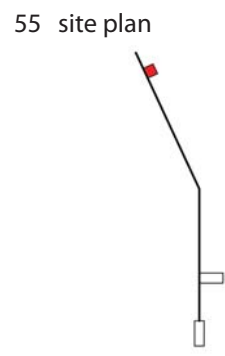

56 | OBSERVATION TOWER

- 1. Entrance tunnel
- 2. Elevator
- 3. Storage room
- 4. Restroom
- 5. Access hatch to maintenance area
- 6. Metal grate floor
- 7. Exit tunnel

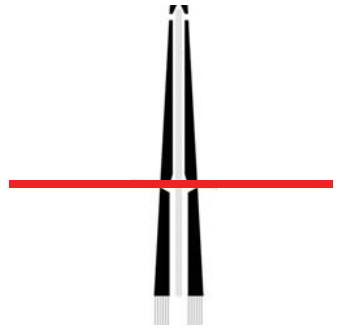
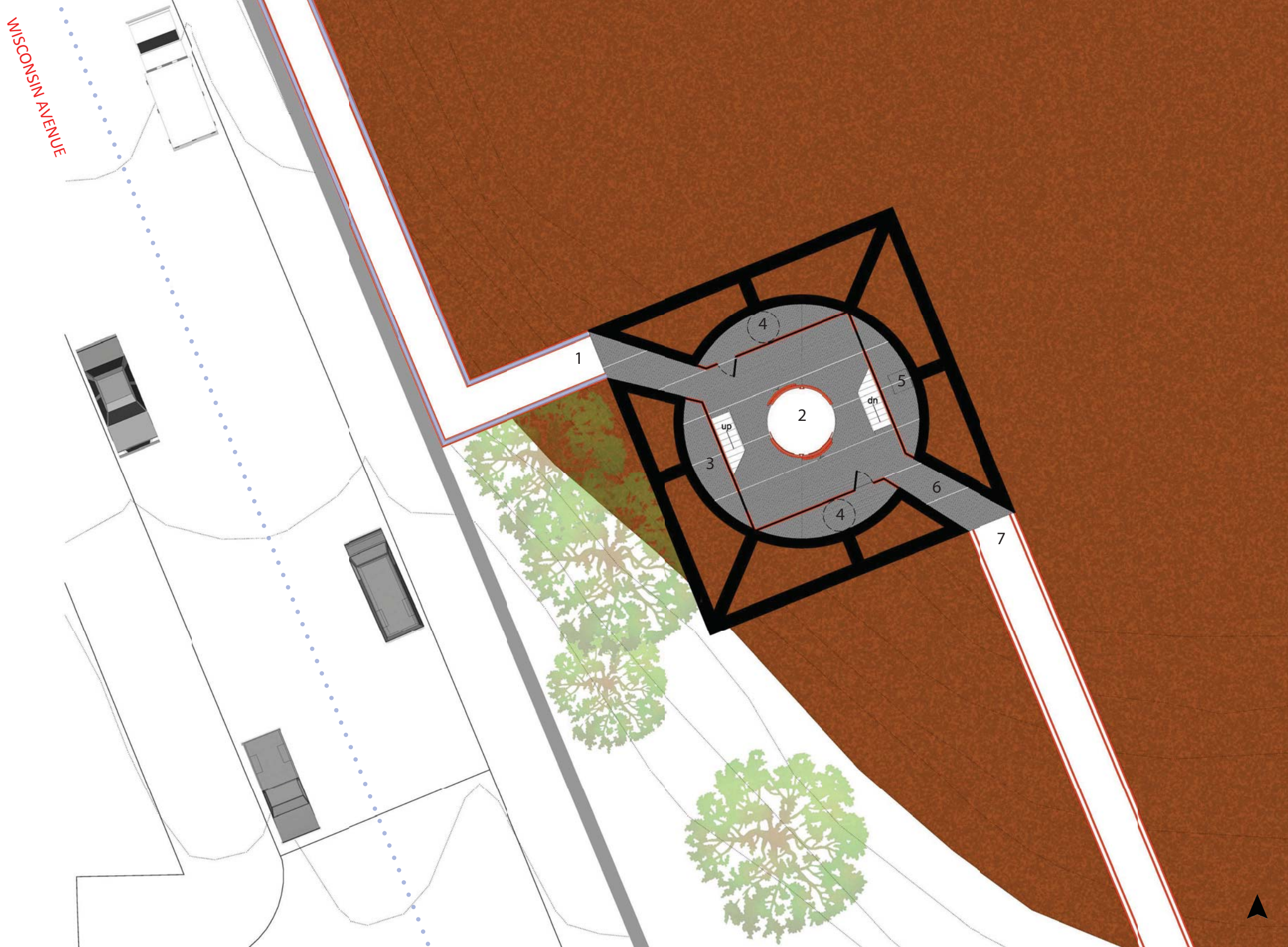
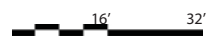

- 1. Elevator
- 2. Benches

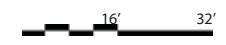

WISCONSIN AVENUE

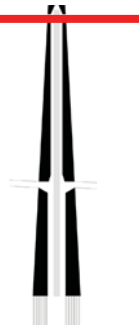
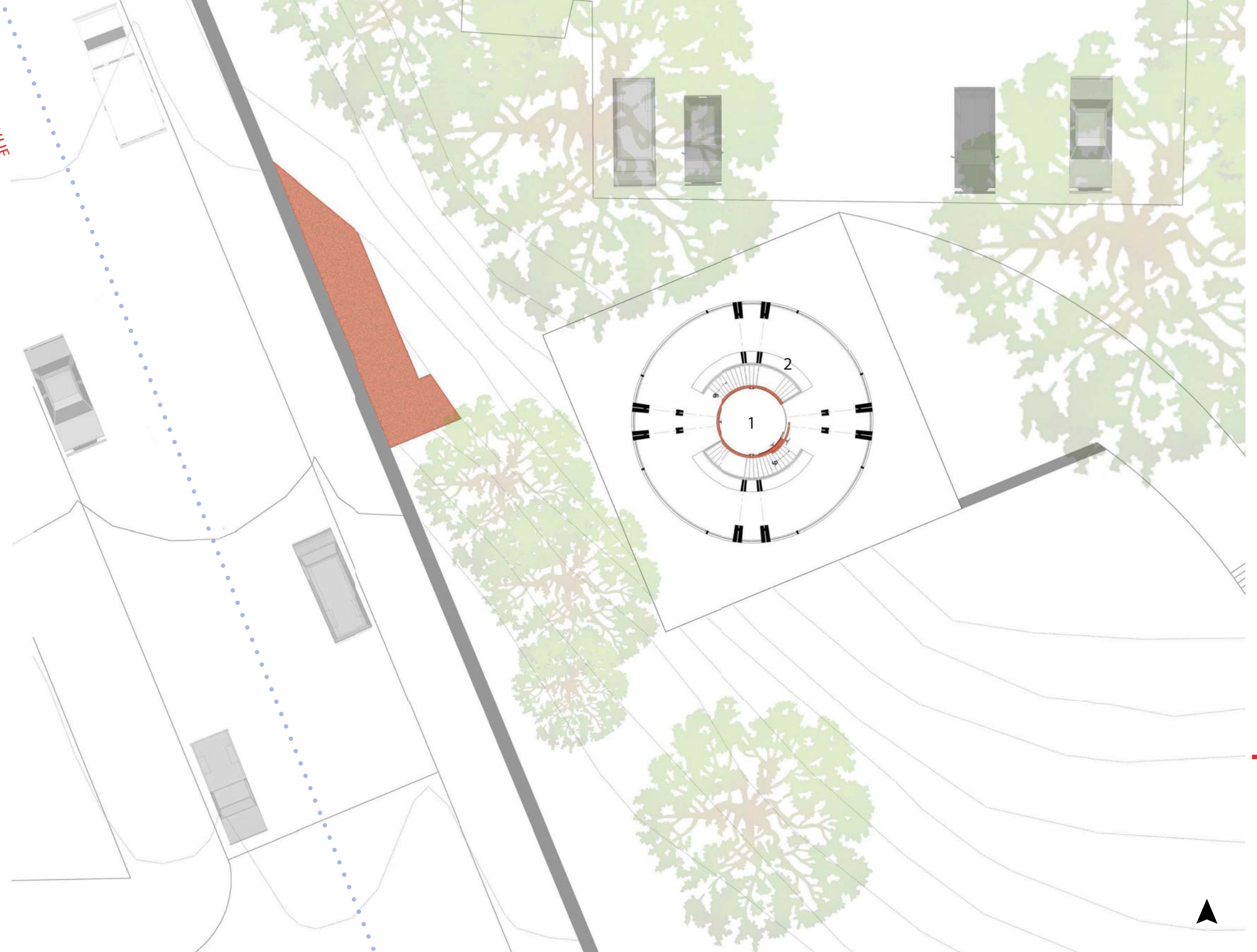

WISCONSIN AVENUE

- 1. Light
- 2. Access hatch to below

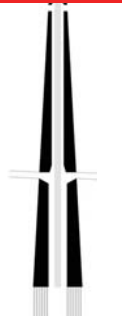
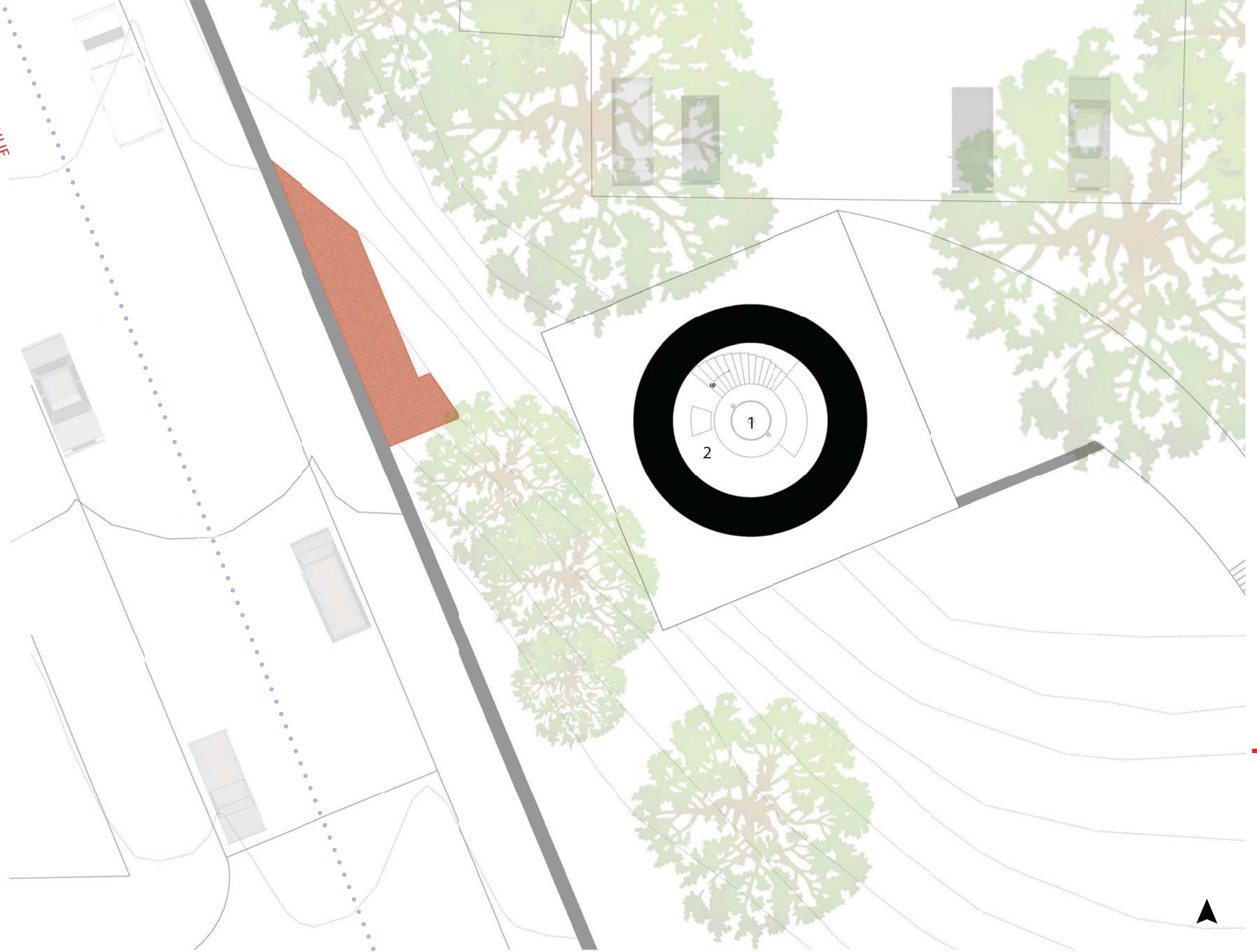
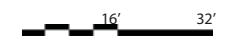

42. Study model of openings within the historic retaining wall.

43. From the street the entrance to the tower is a bent corten steel tunnel. Gutters along the path allow rain water run-off to be collected in the well. Select stones are removed from the retaining wall to show the depth of the wall and to reveal the tunnel behind.

44. The darkness of the tunnel sets the stage for the dramatic views that the tower provides, but total darkness is disorienting. By removing select stones from the wall, light enters the tunnel and lights the path into the main chamber.



42.

63



43.

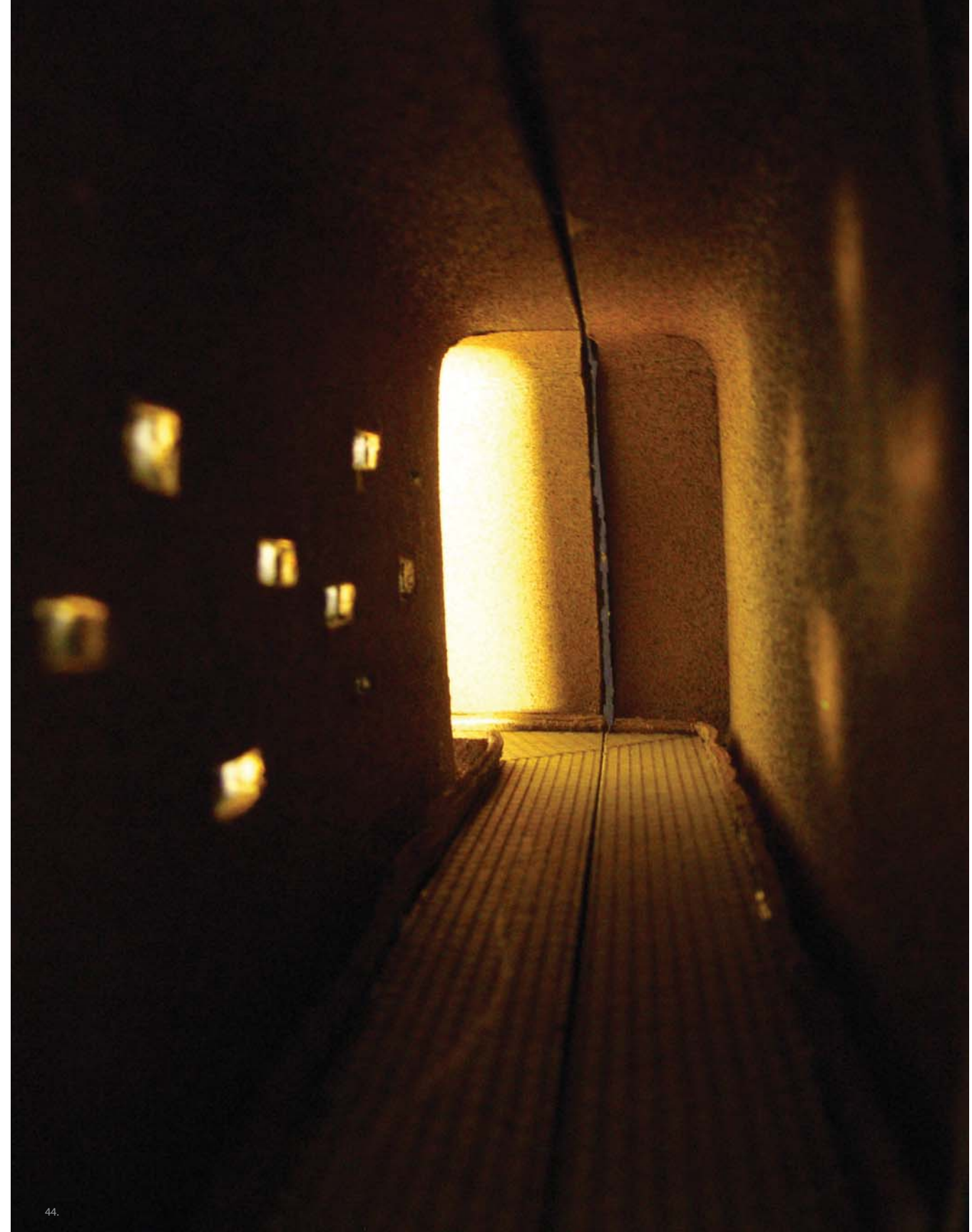

44.

65 model north side

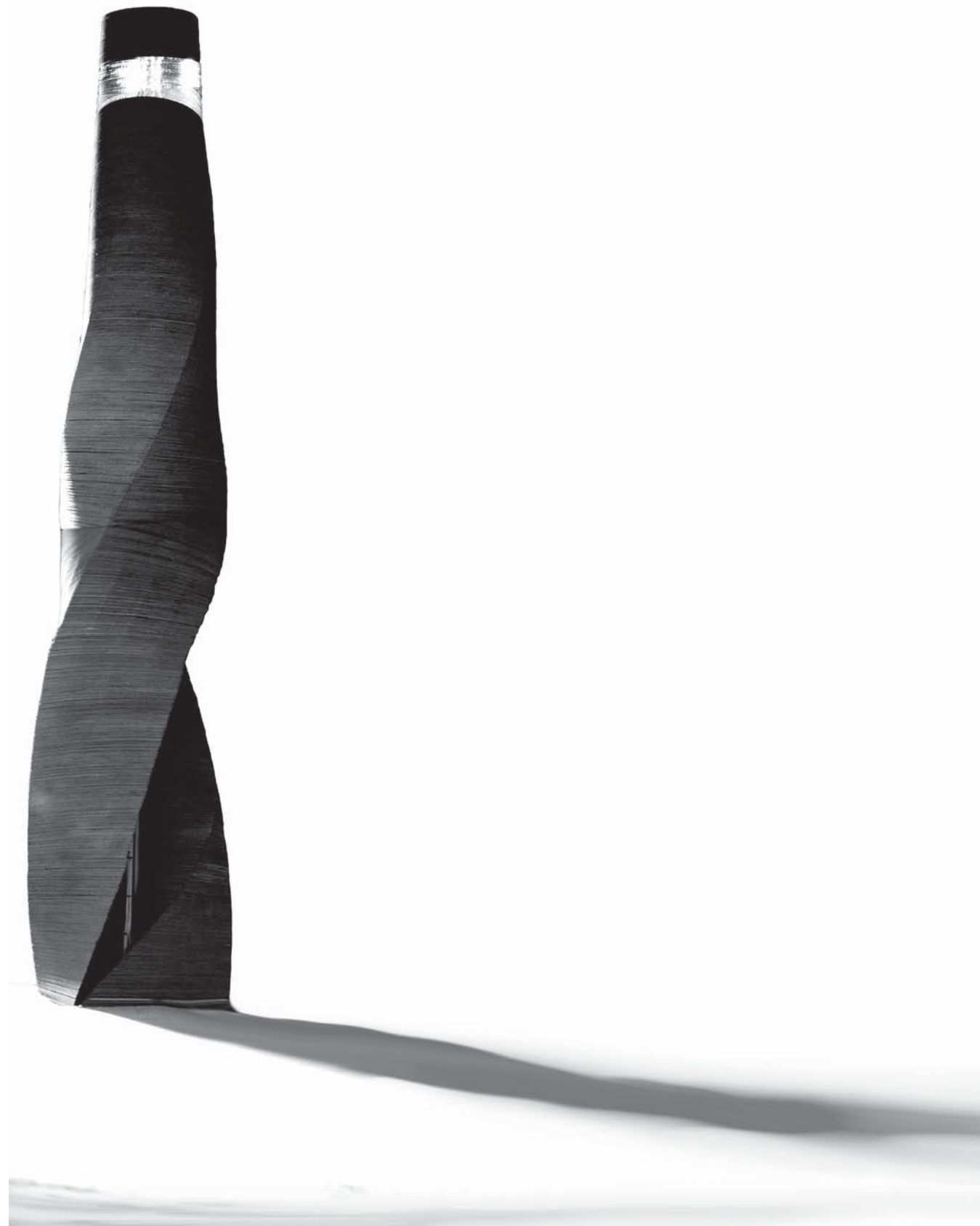

model west side 66

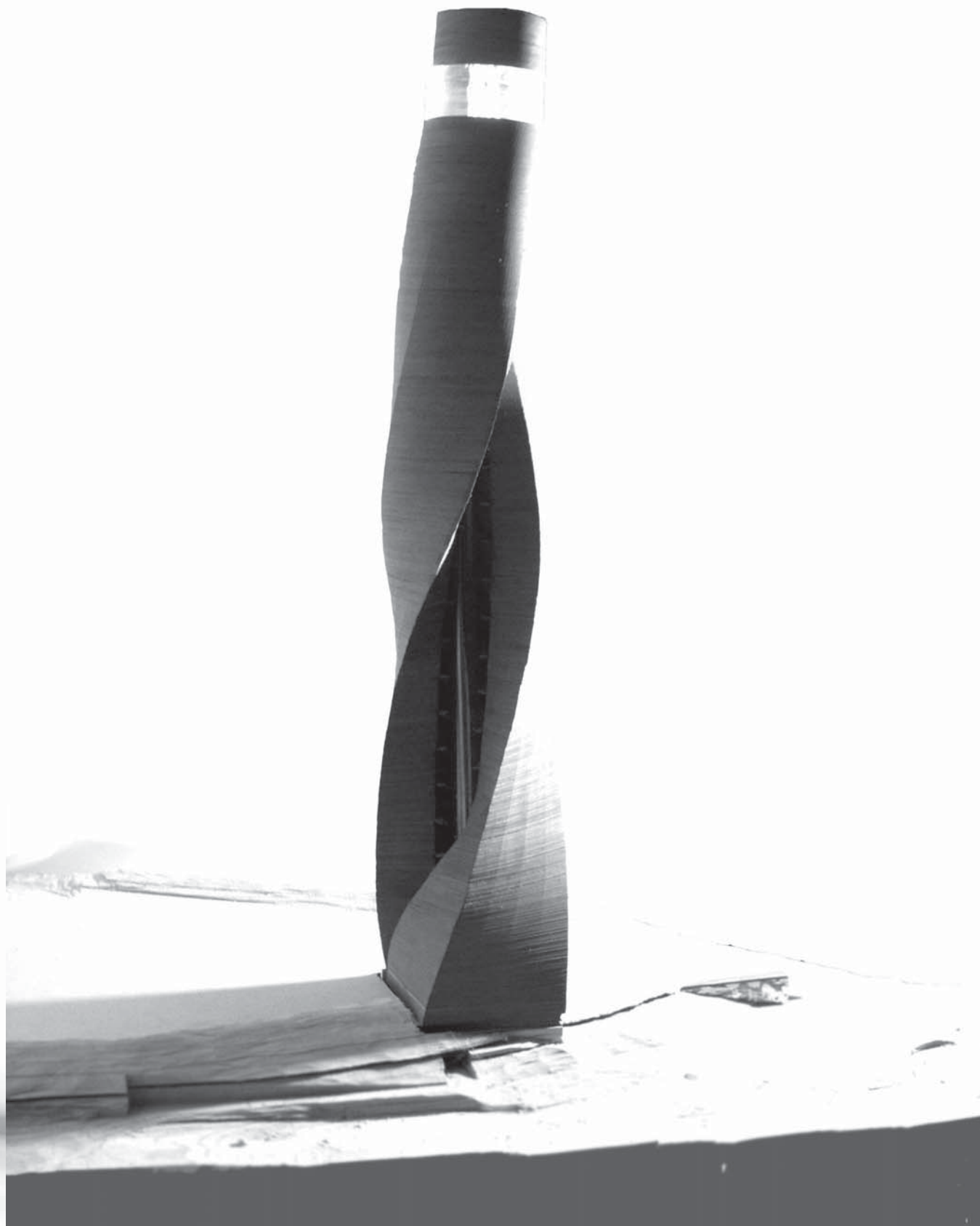

67 model south side

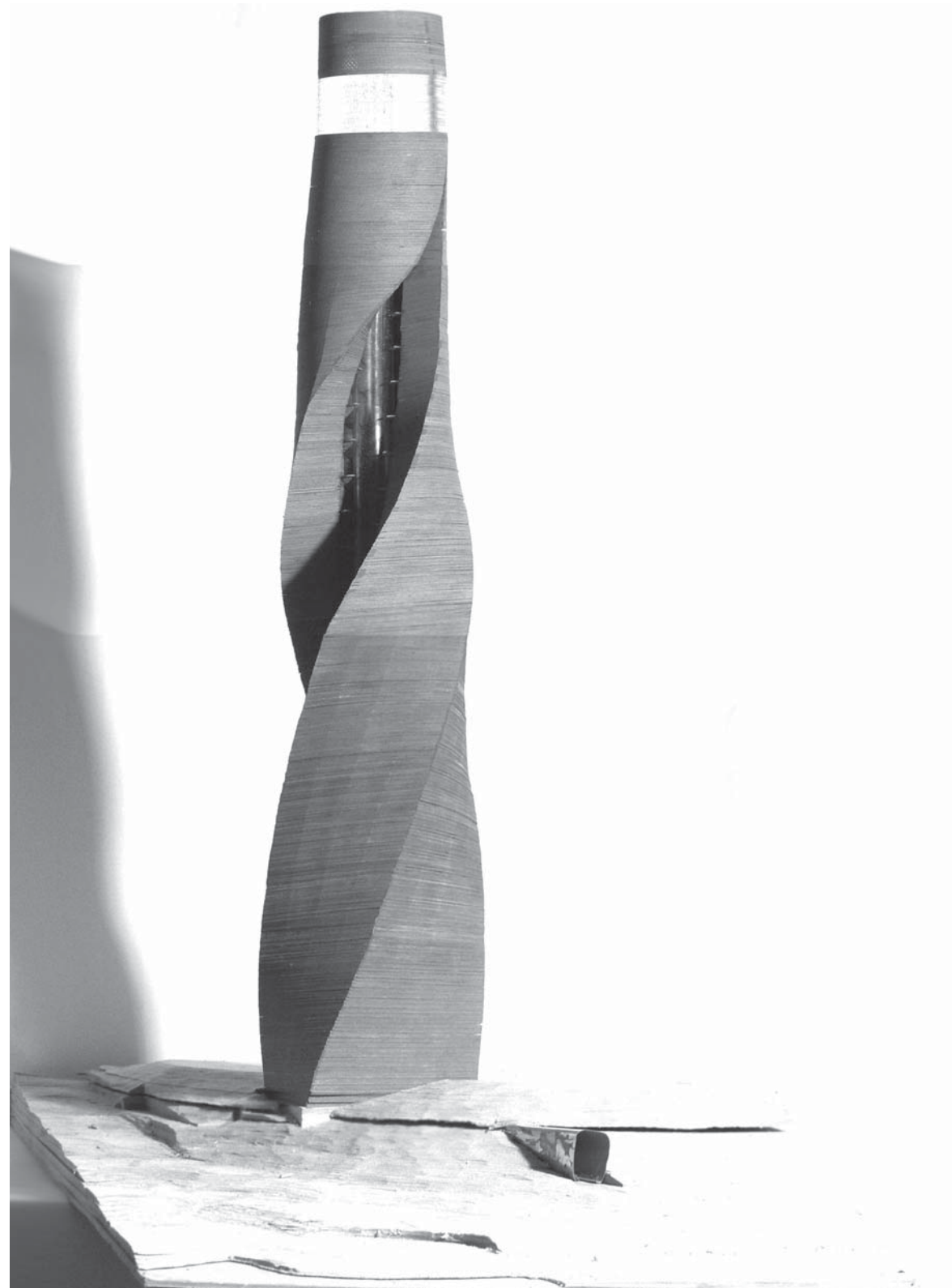

model east side 68

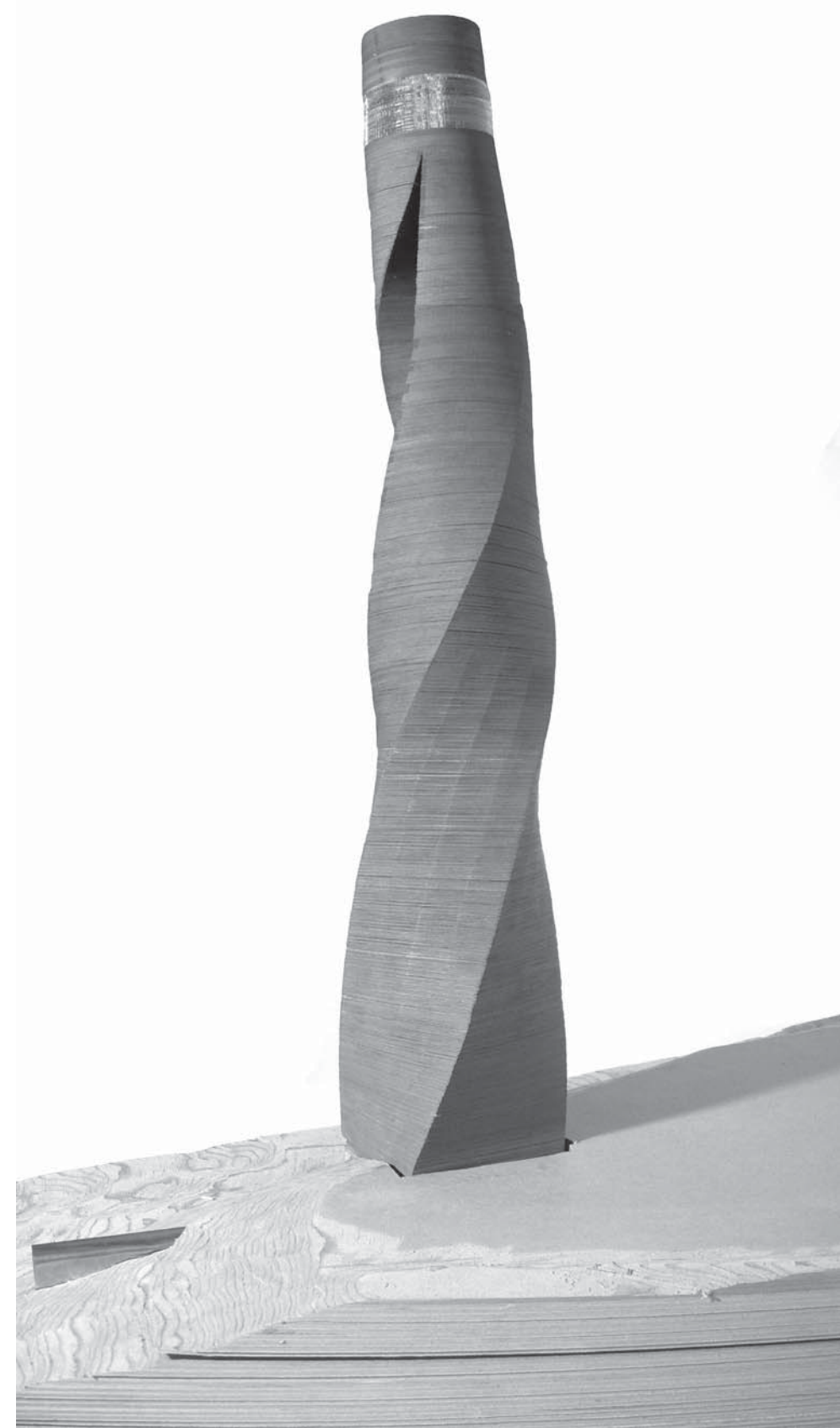

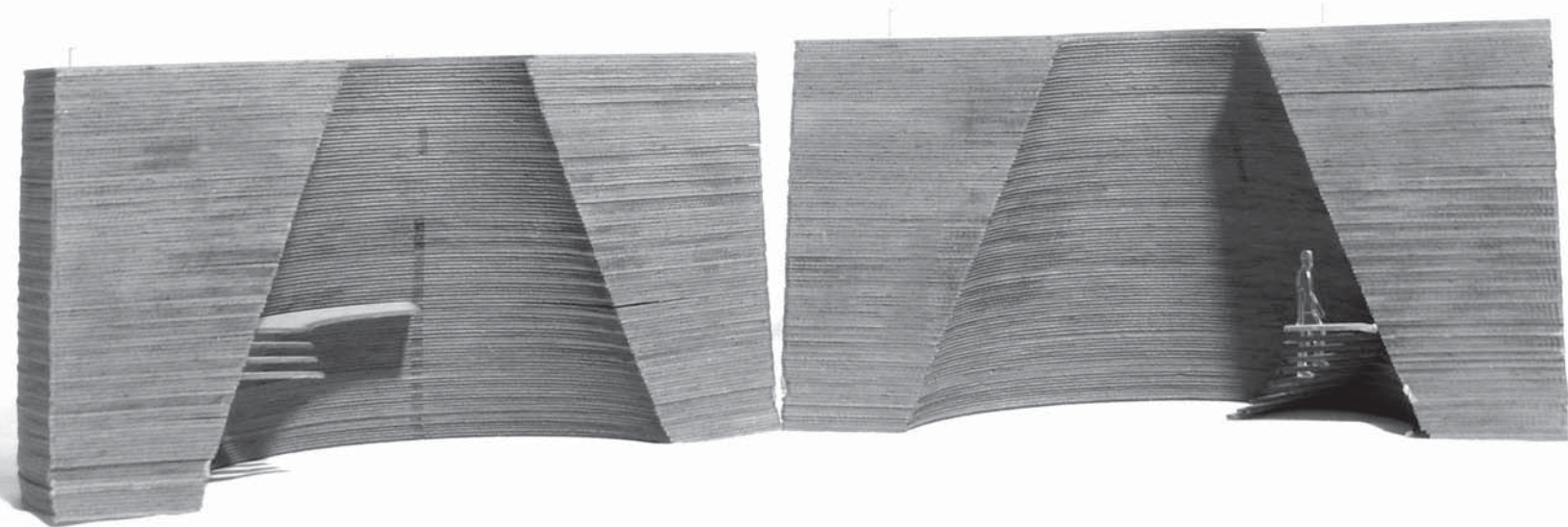

69 oculus

Most of the tower is made of thick masonry walls. Because the intent of the tower was to symbolize an even flow, when a change occurs it was necessary to transition the walls. I choose to corbell the bricks evenly to allow a steady transformation.

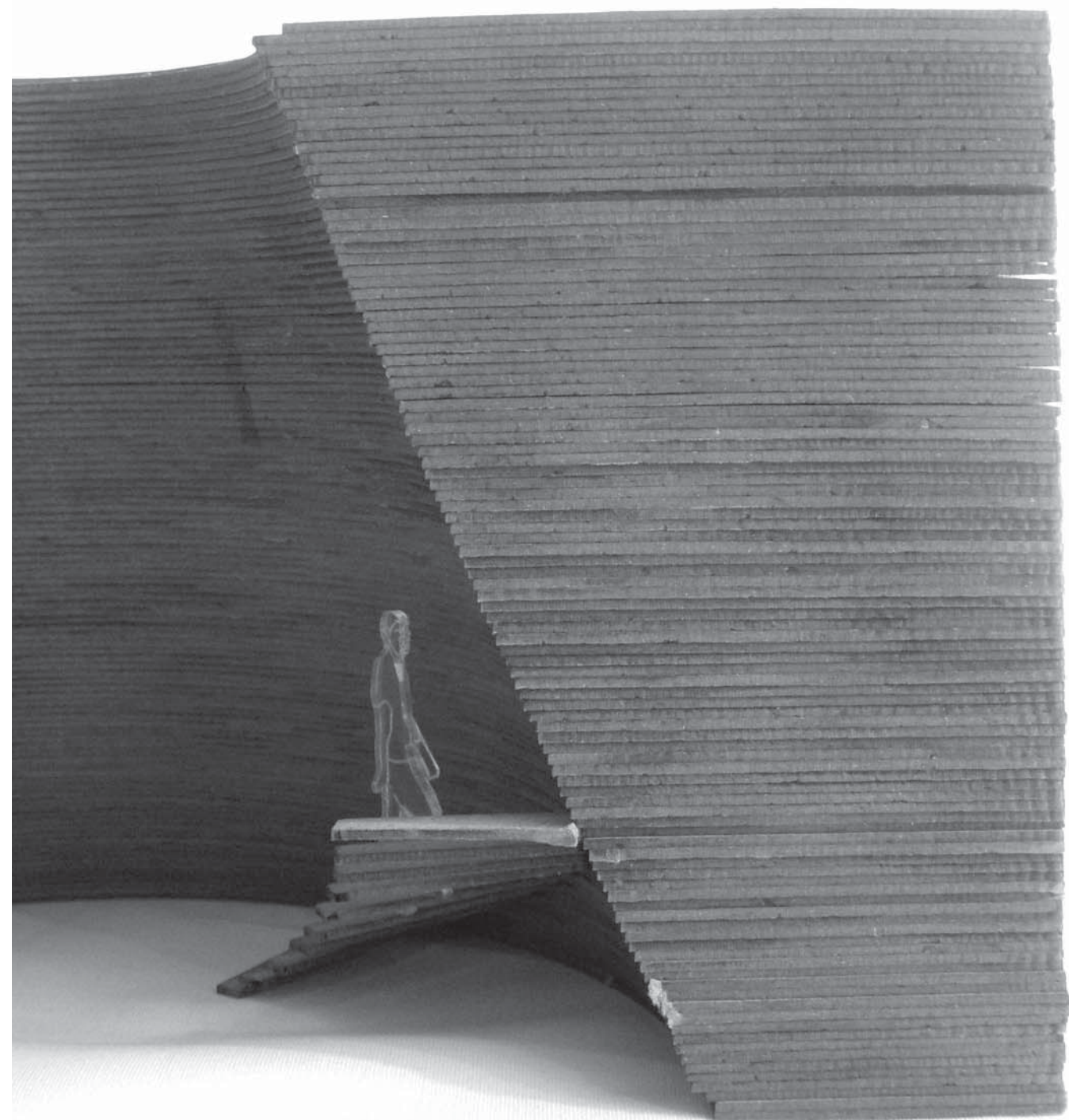

observation tower 70

71 oculus

View up into the oculus opening.

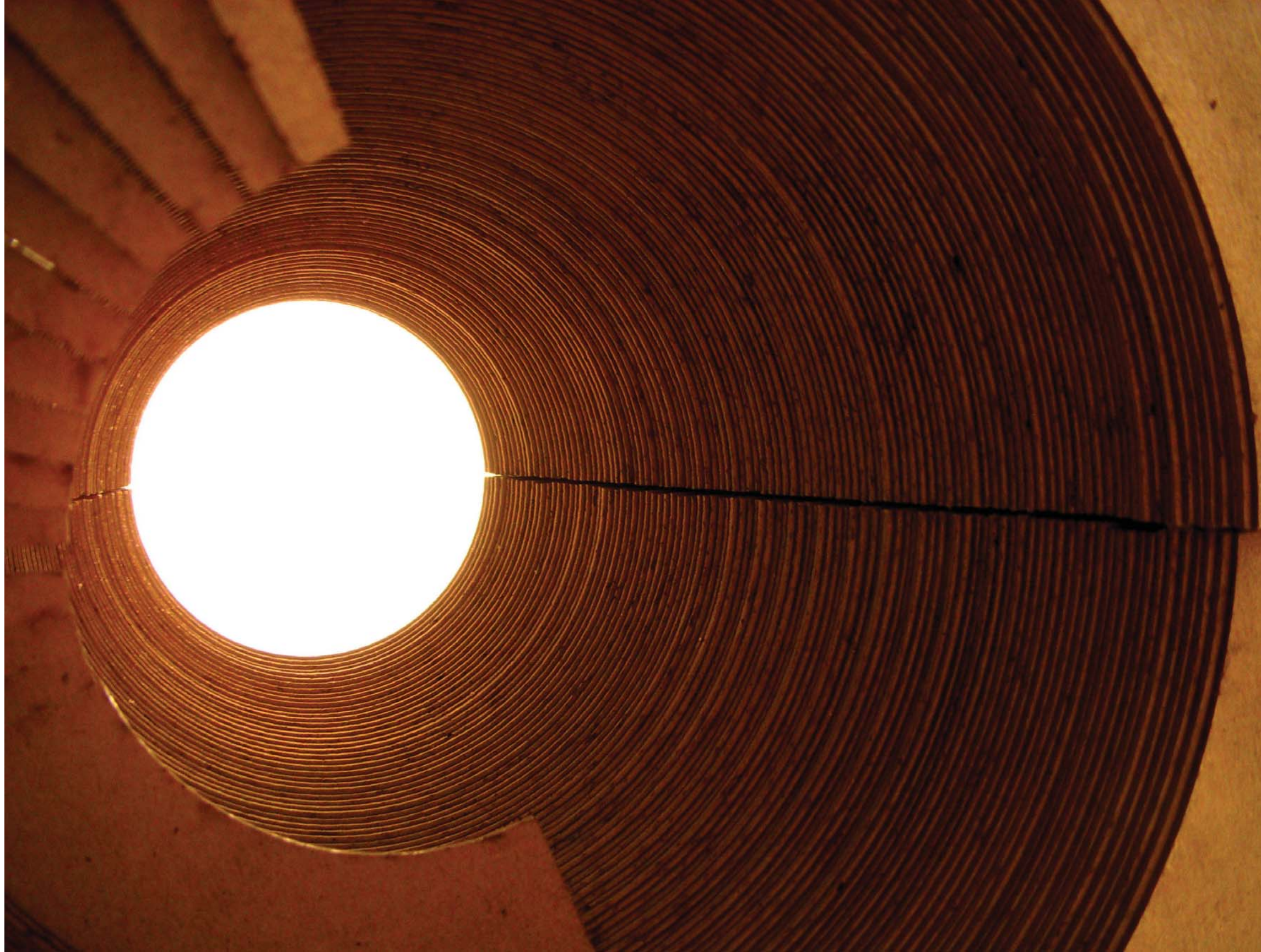

observation tower 72

DESIGN

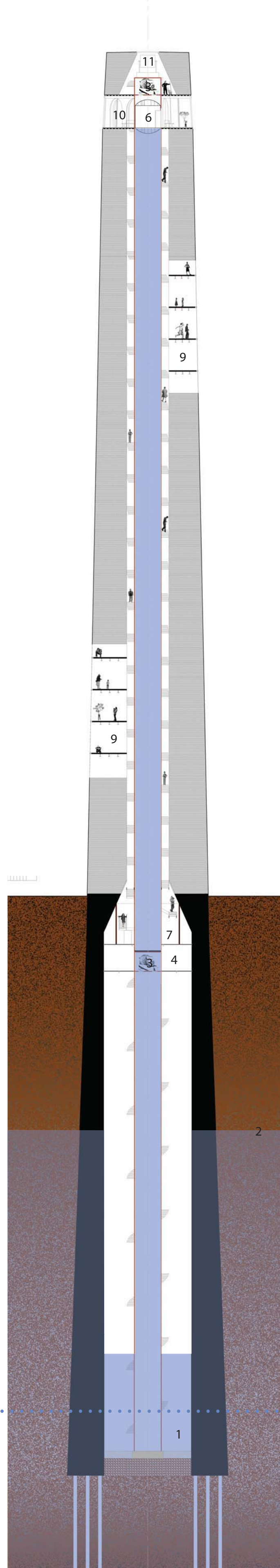
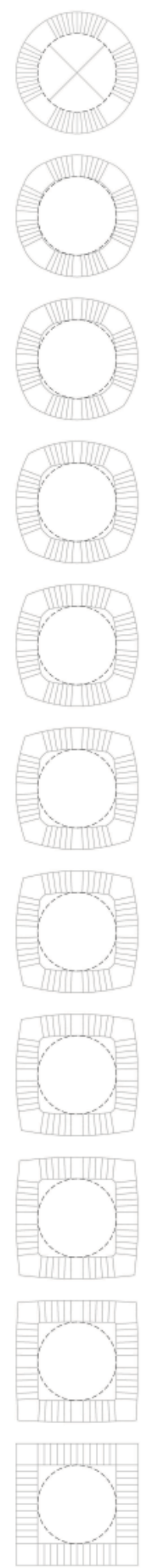
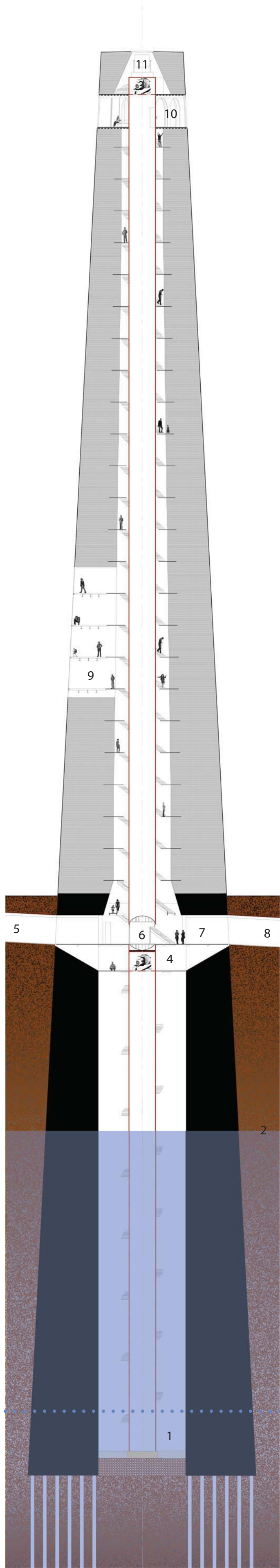

OBSERVATION TOWER

- 1. Well
- 2. Water table
- 3. Pump
- 4. Maintenance area
- 5. Entrance
- 6. Elevator
- 7. Main chamber
- 8. Exit
- 9. Viewing platforms
- 10. Observatory deck
- 11. Oculus
- 12. Stair transition
- 13. Water line of the Potomac River

73 overall section diagonal

13

overall section lateral 74

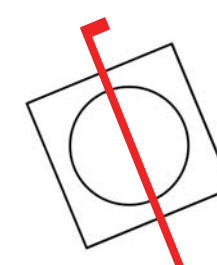
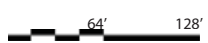
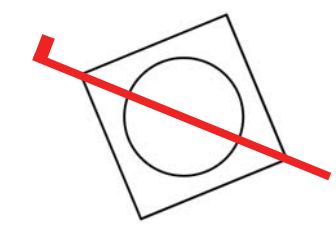

- 1. Well
- 2. Piles
- 3. Water table
(the water table rises the further in land)
- 4. Water Line from Potomac River

75 well section diagonal

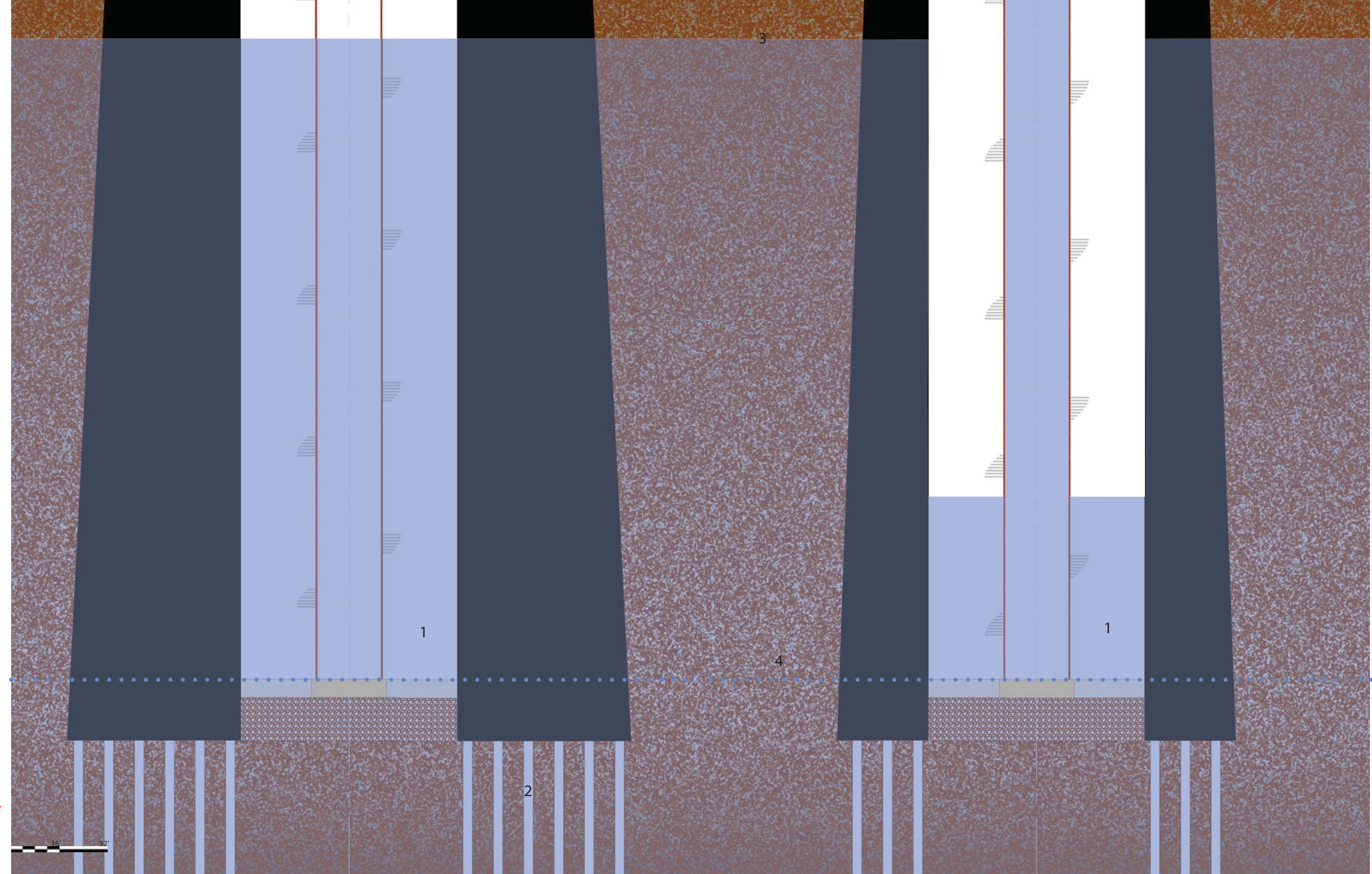
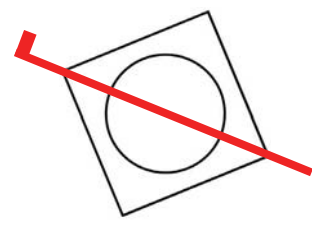

16' 32'

well section 76 lateral

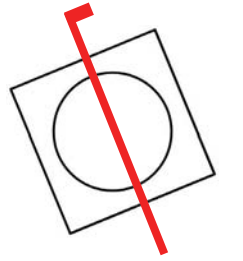

OBSERVATION TOWER

- 1. Entrance
- 2. Elevator
- 3. Pump
- 4. Maintenance area
- 5. Exit
- 6. Storage

77 main chamber section
diagonal

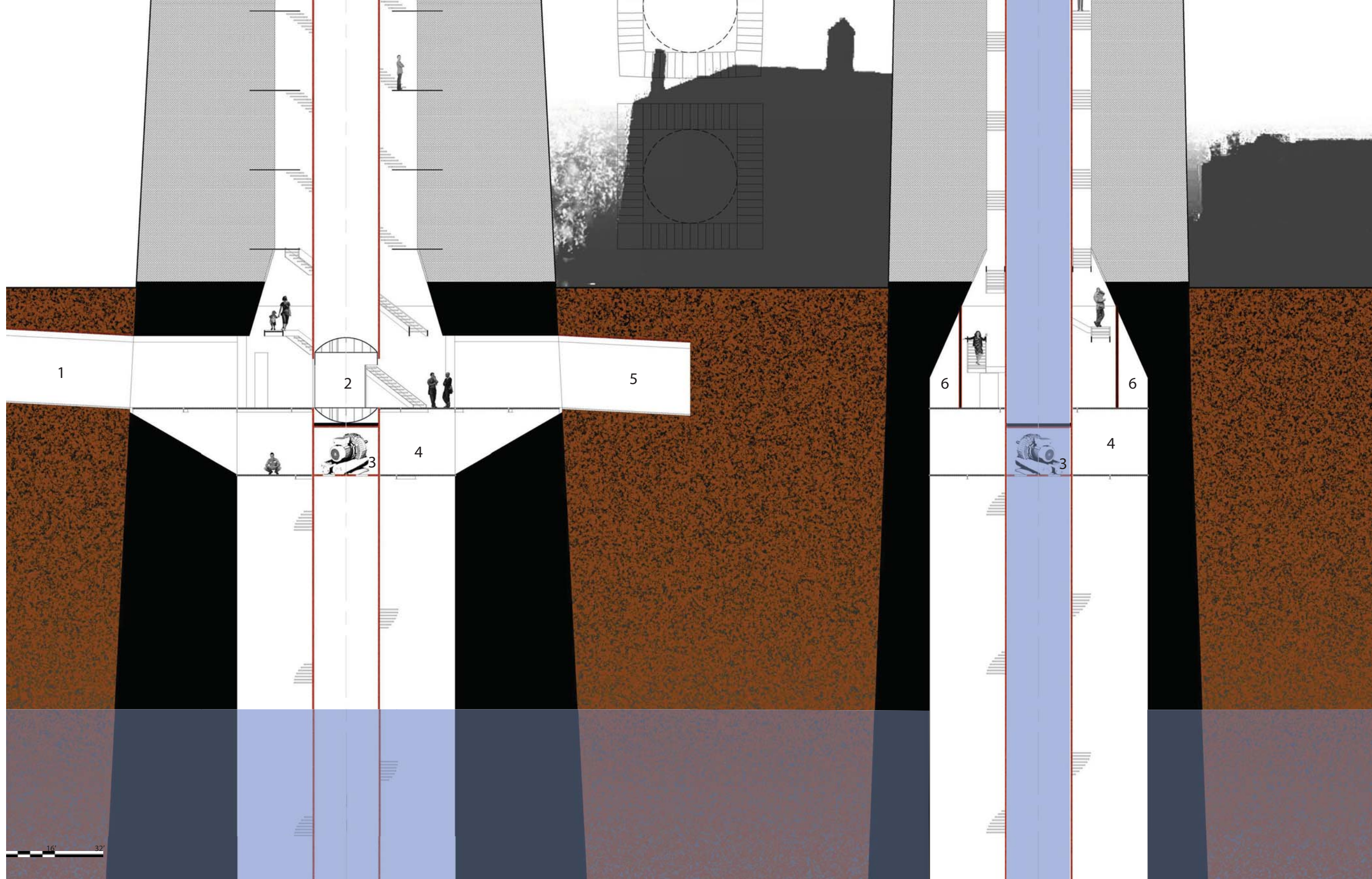
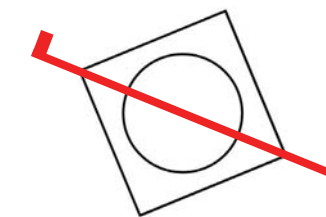

main chamber section 78
lateral

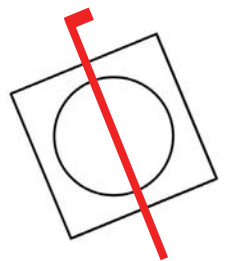

- 1. Viewing platforms
- 2. Landings

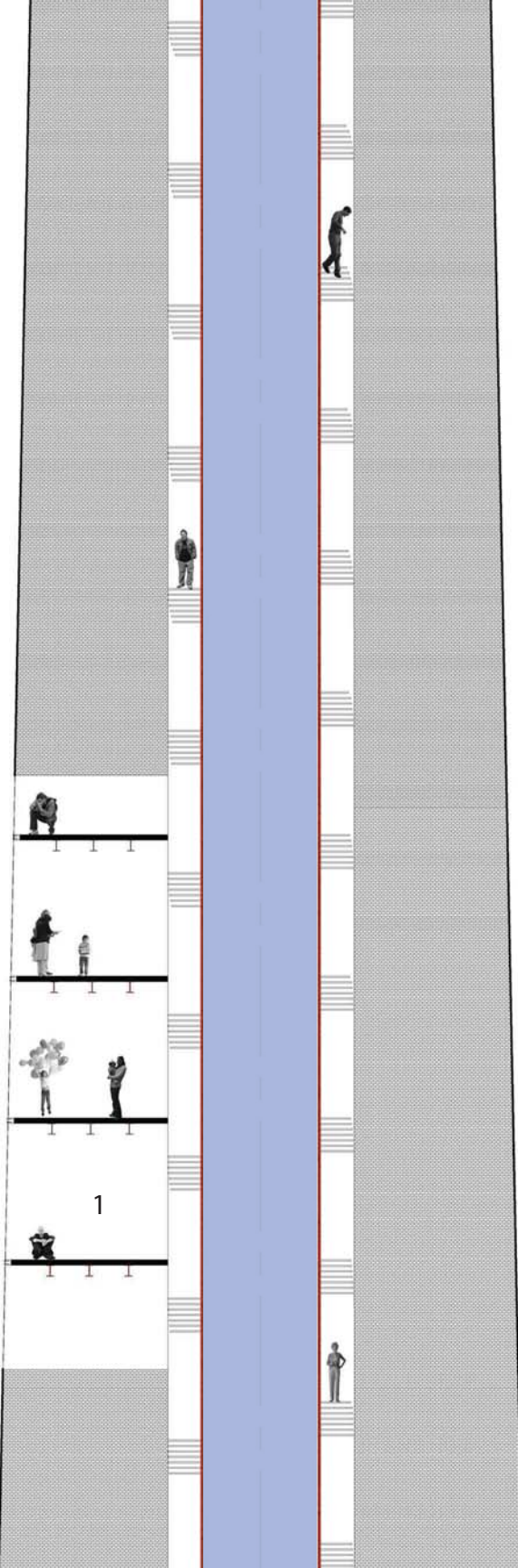
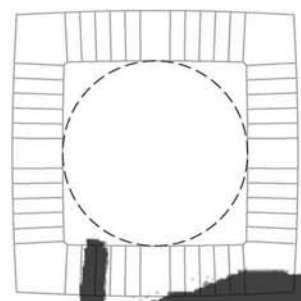
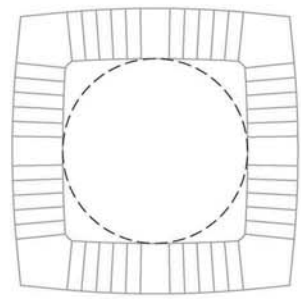
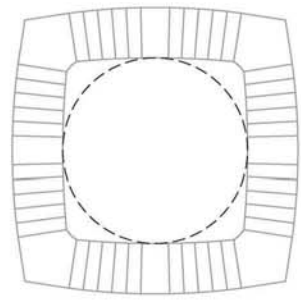
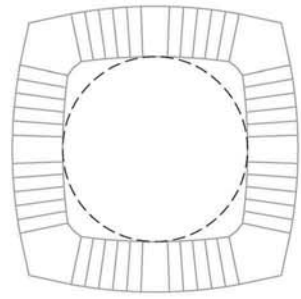
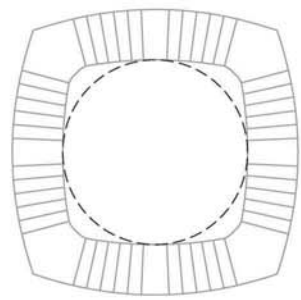
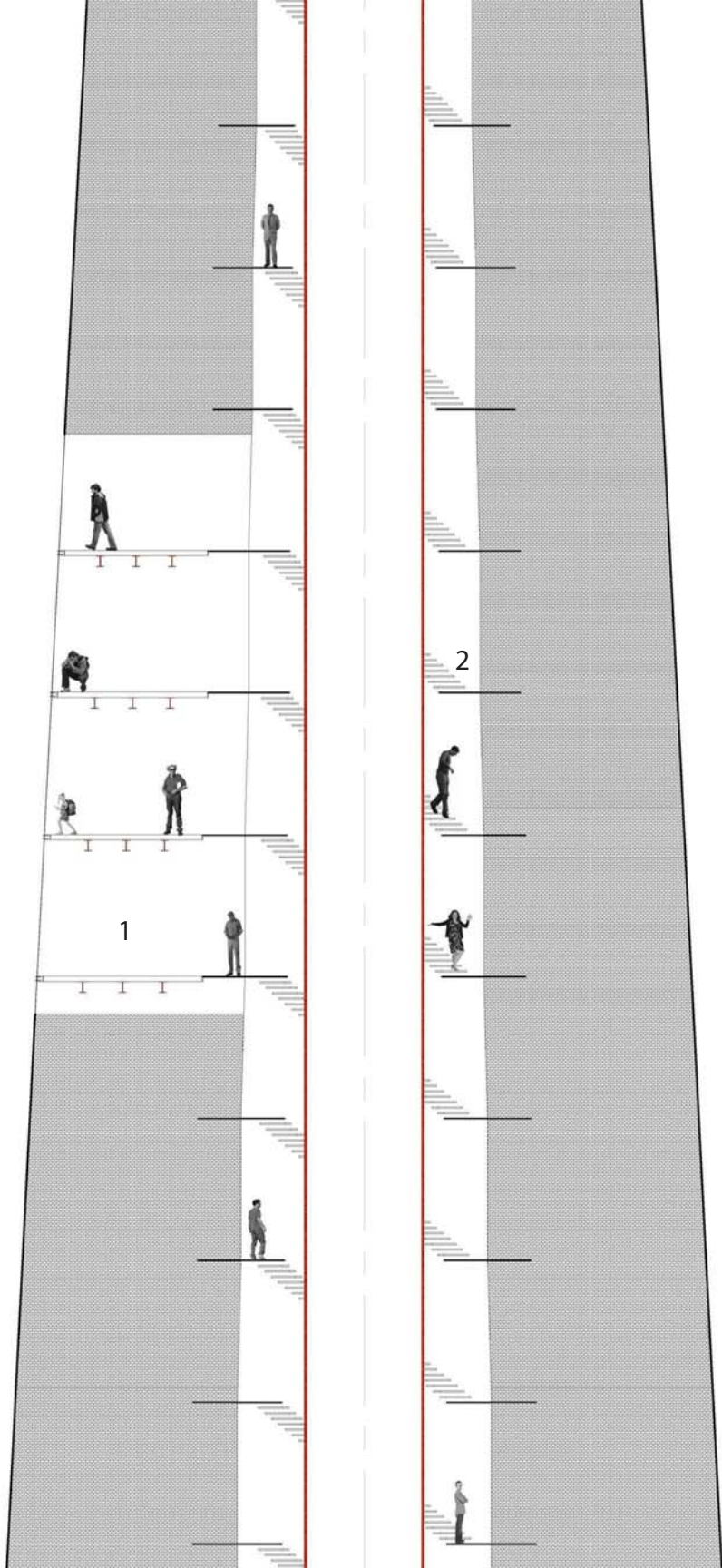

79 viewing platforms section diagonal

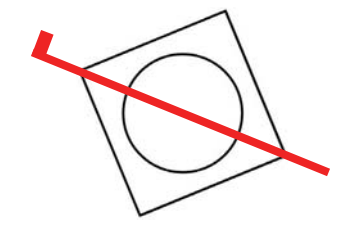

16' 32'

viewing platform section 80 lateral

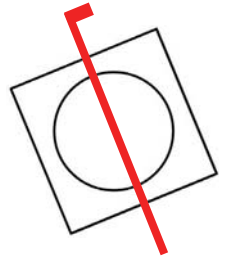

- 1. Elevator
- 2. Observatory deck
- 3. Pump
- 4. Oculus
- 5. Opening

81 observatory section diagonal

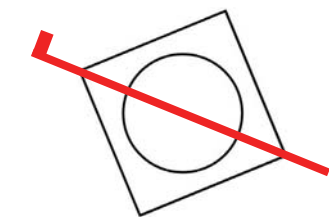

16' 32'

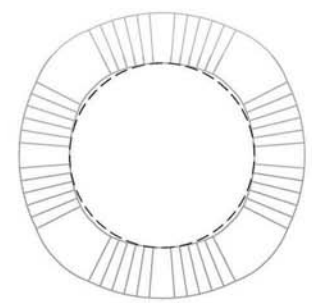
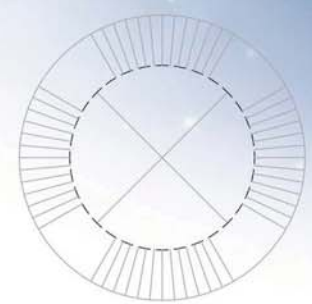
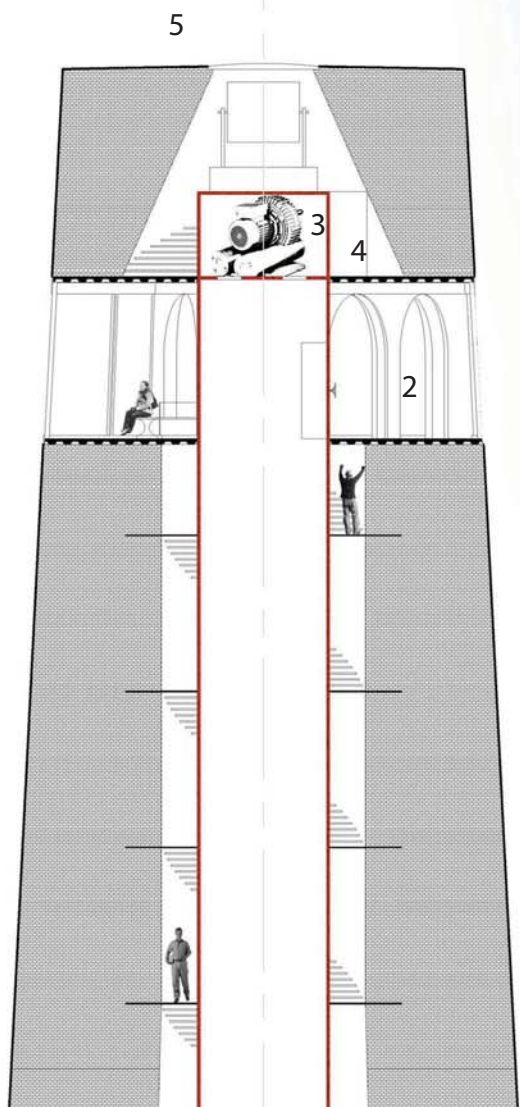

observatory section 82 lateral

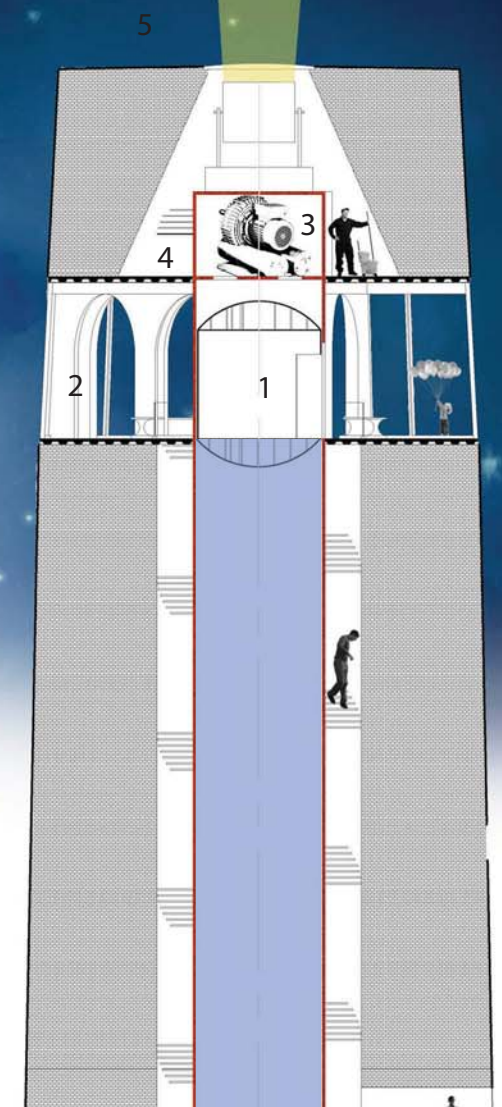
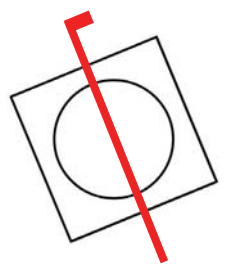

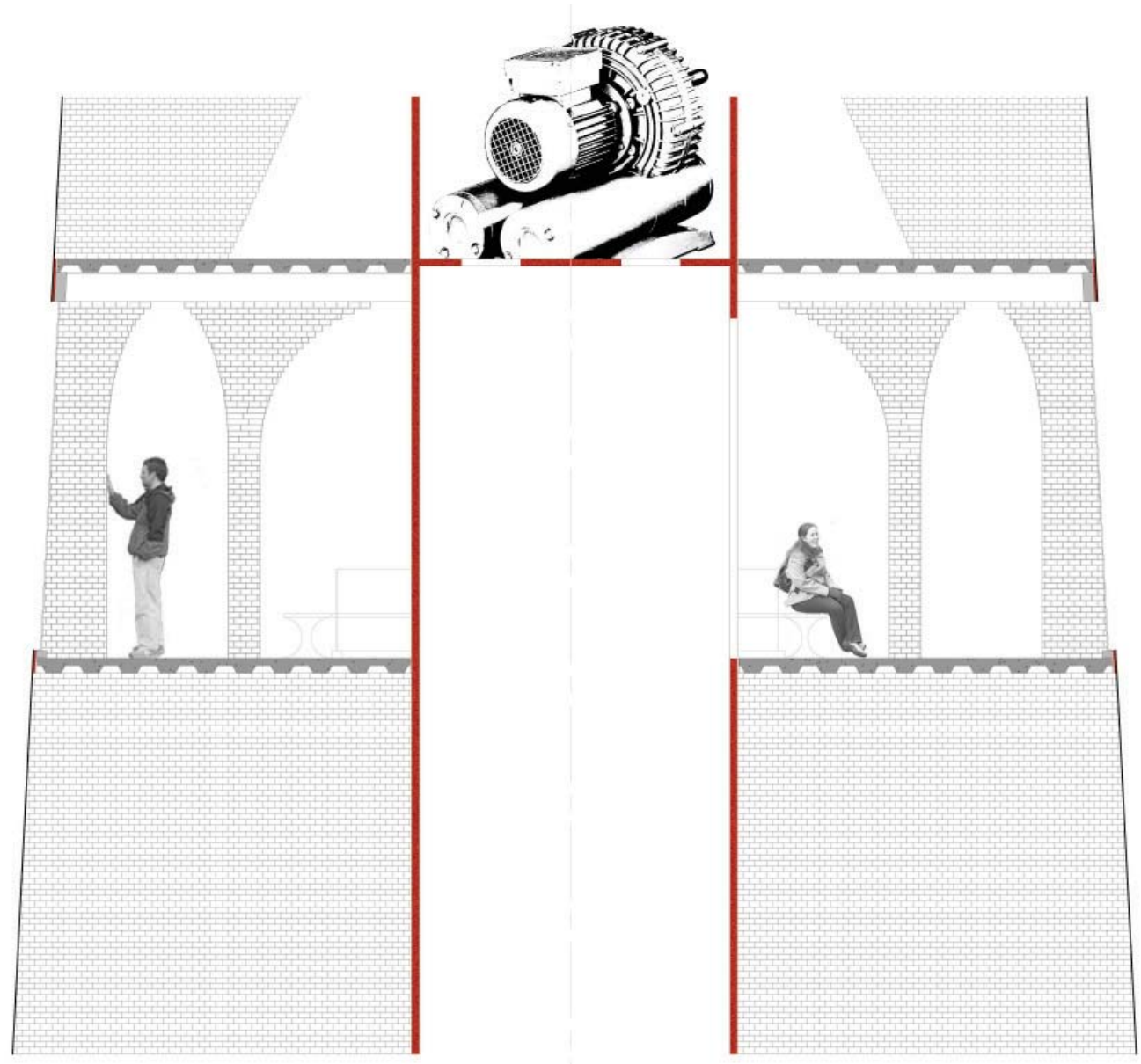

83 oculus section 1

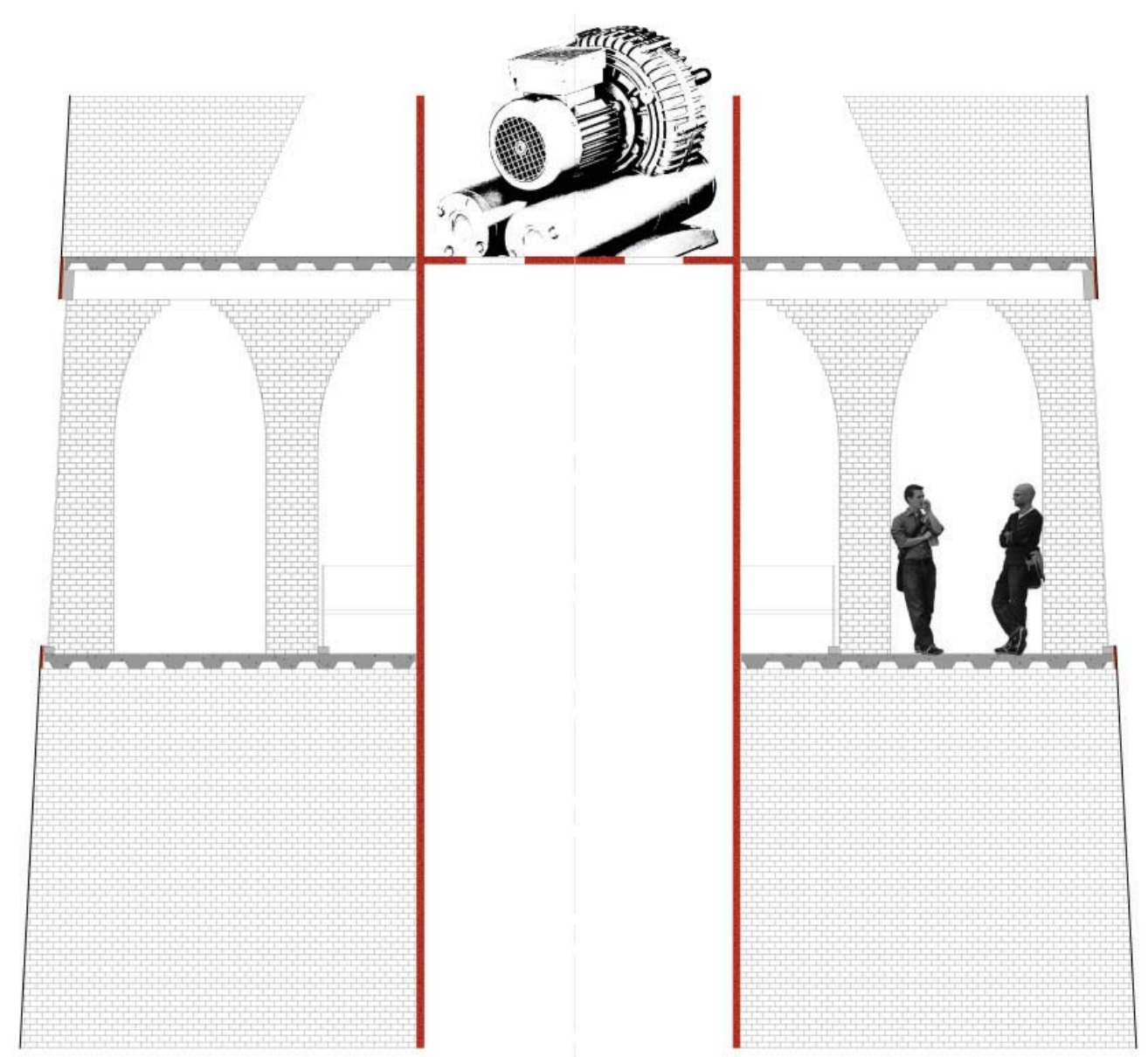
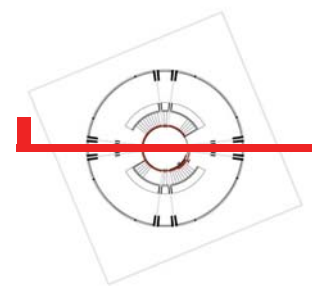

oculus section 2 84

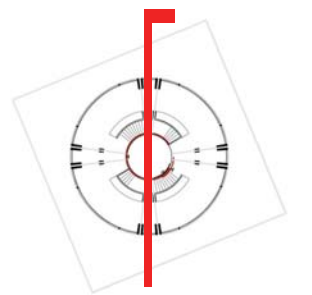

45. Plan of elevator

46. Panoramic view from the observatory deck

47. The elevator system is comprised of two pumps that work together to raise and drop the water pressure within the elevator shaft. The shaft runs the height of the building and also supports the stair cases.

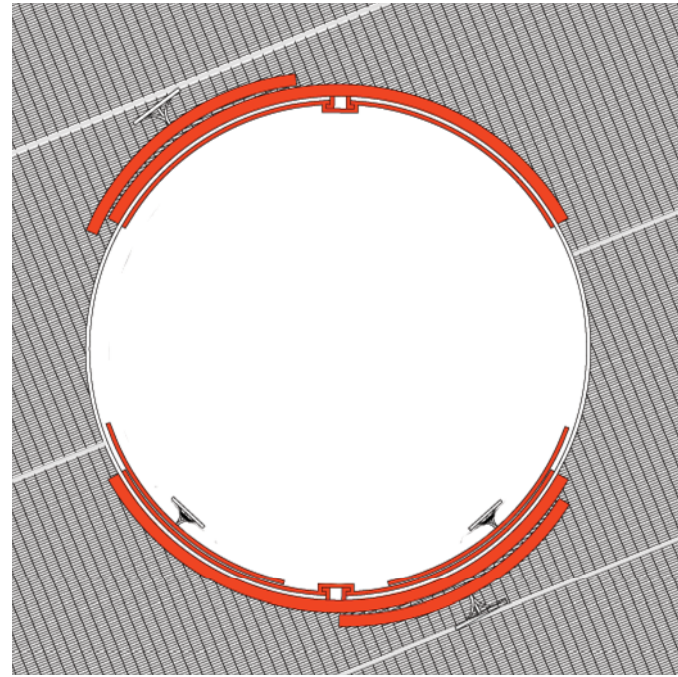

45.

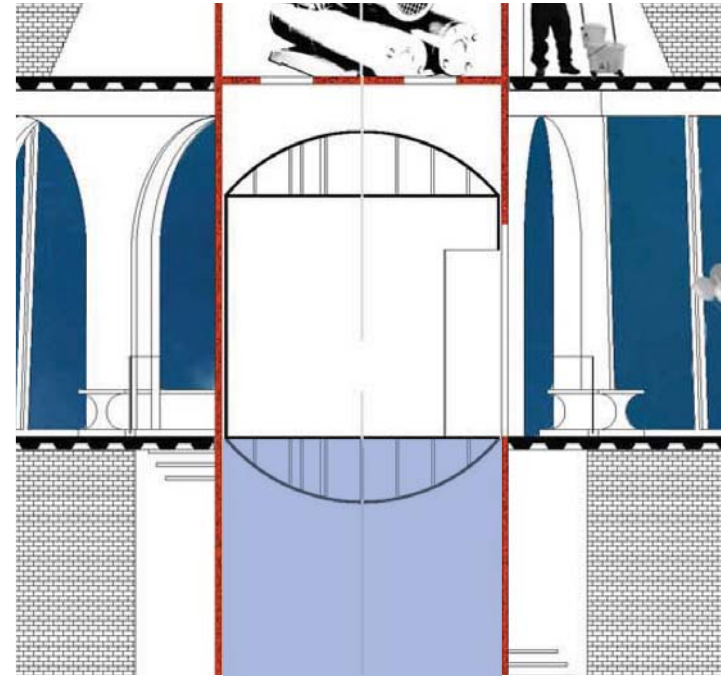

47.

85 elevator

elevator 86



46.