

This stone historic stone bridge carries Wisconsin Avenue over the Chesapeake & Ohio Canal and tow path.





48.

48. Although the Chesapeake & Ohio Canal is no longer used as a transportation route, the National Parks Service take visitors on a ride through several locks.

49. The barges were pulled by donkeys through the locks. In this image you can see the historic stone bridge beyond.

50. The existing site condition at the canal is a parking lot. The building adjacent to the site is a utilities substation.

51. This photograph taken from the tow path across the canal, shows the difference in grade between either side of the canal.



49.



50.



51.

52. According to the Baist map from 1929, the site was at one time used as a fertilizer warehouse. This is consistent with the industrial nature of Georgetown during that time period.

53. In 1931, the site dramatically changed to a bakery.

54. Existing site model from above

55. Existing site model from Wisconsin Avenue.

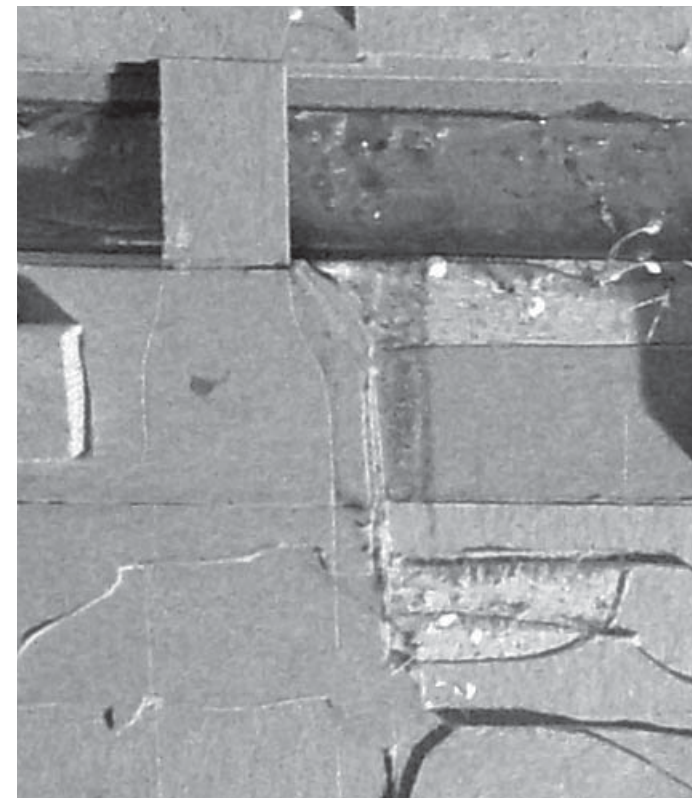
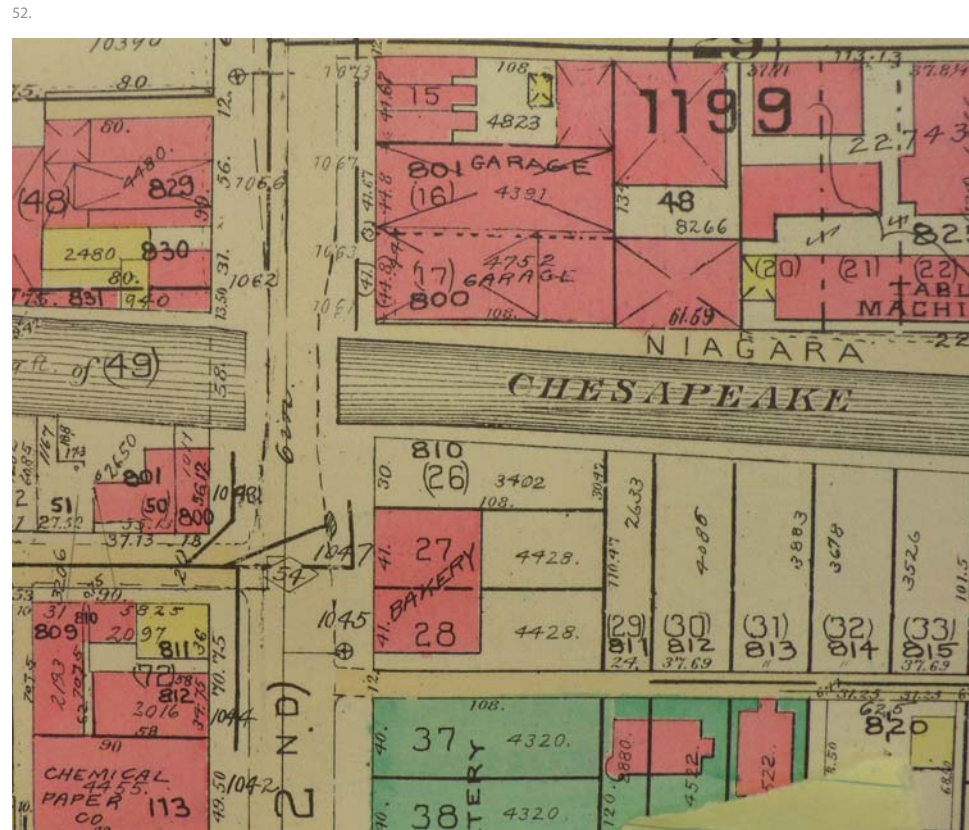
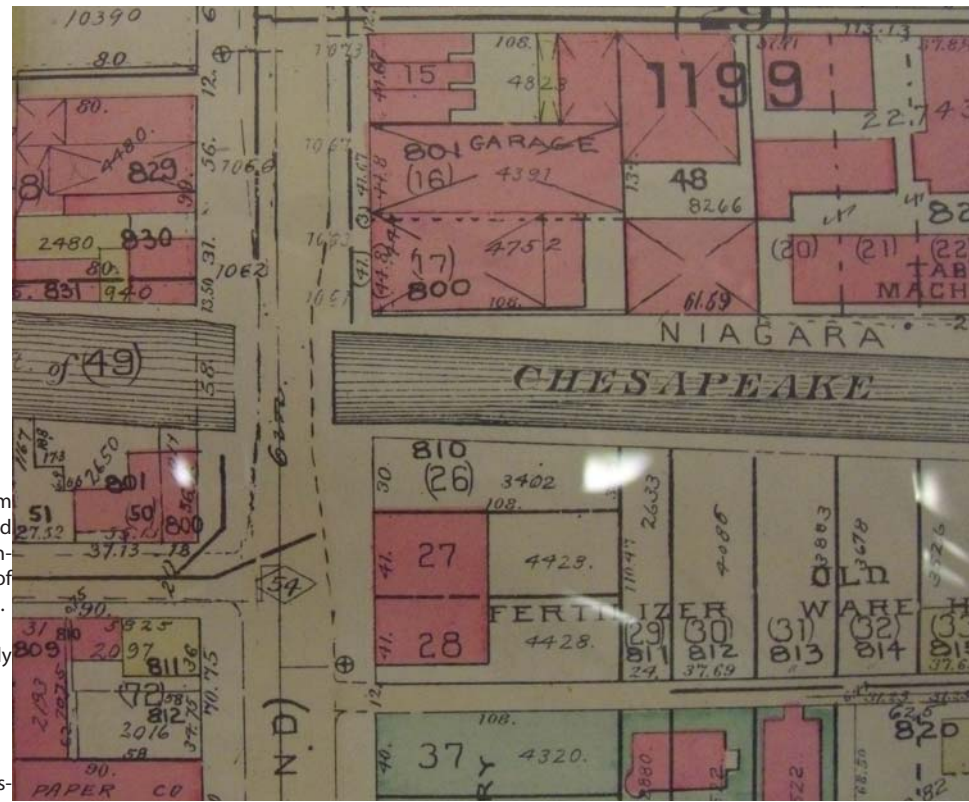

54.

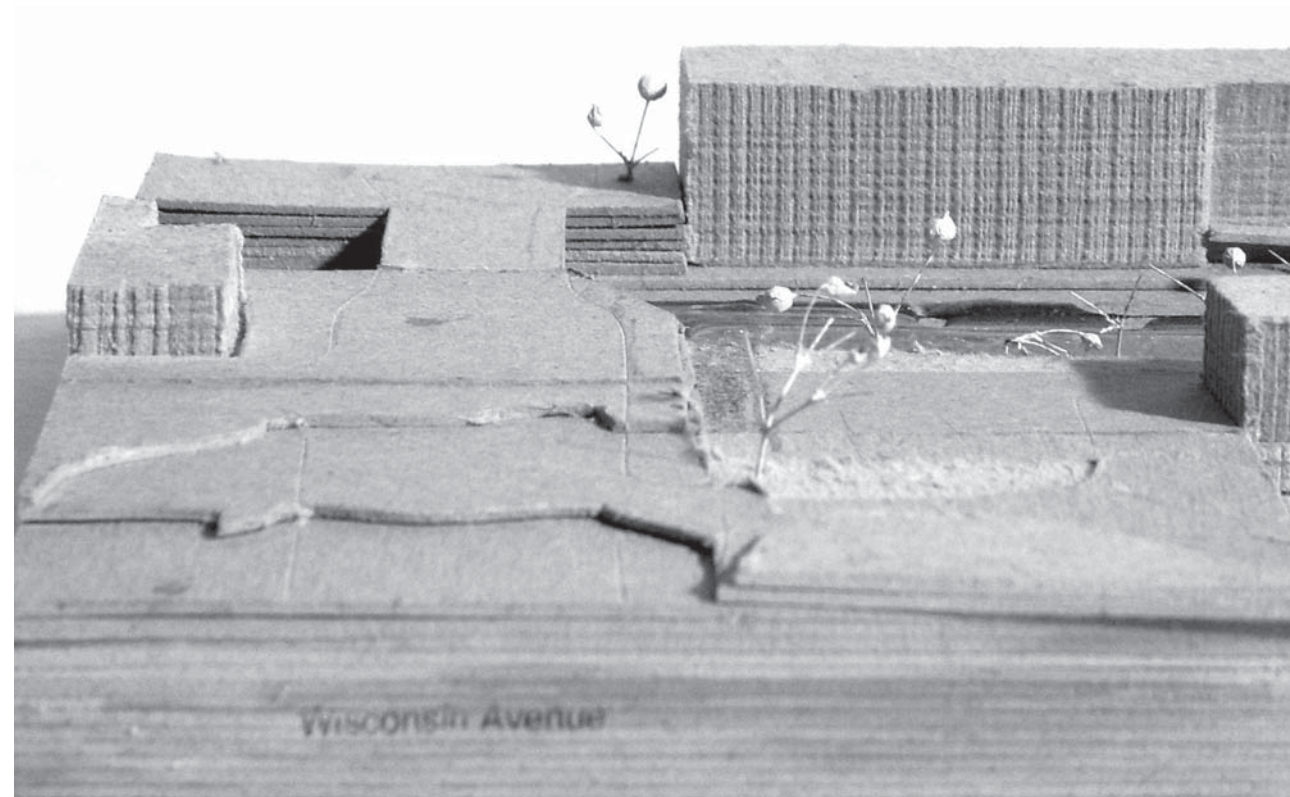

55.

MUSEUM

NEW BRIDGE

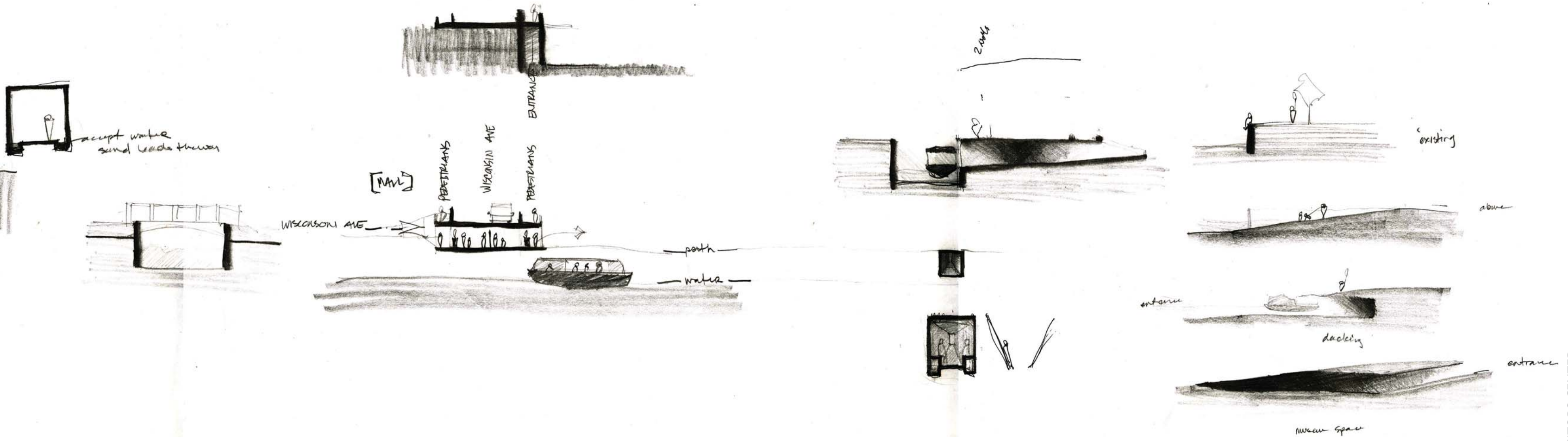

ROLL: The sketches above show the series of iterations I explored. The connection between the canal and the visitors were important.

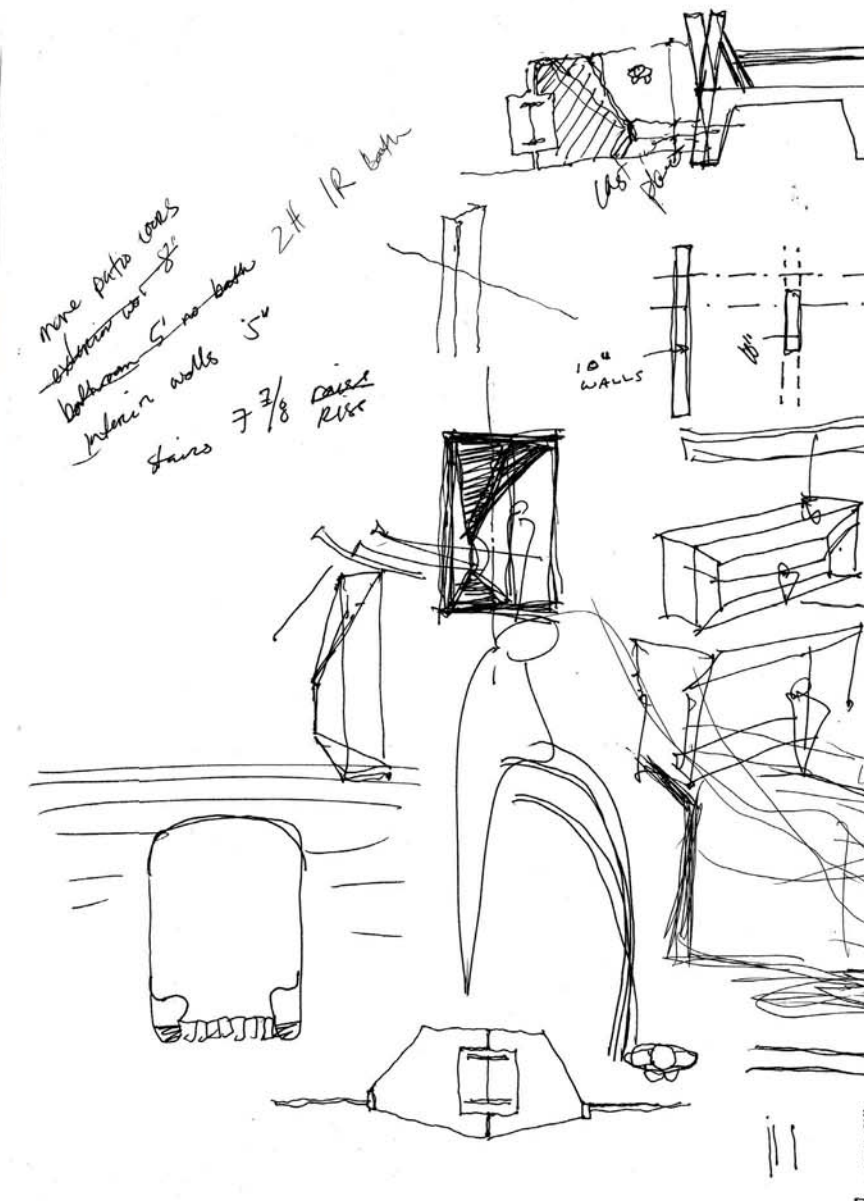
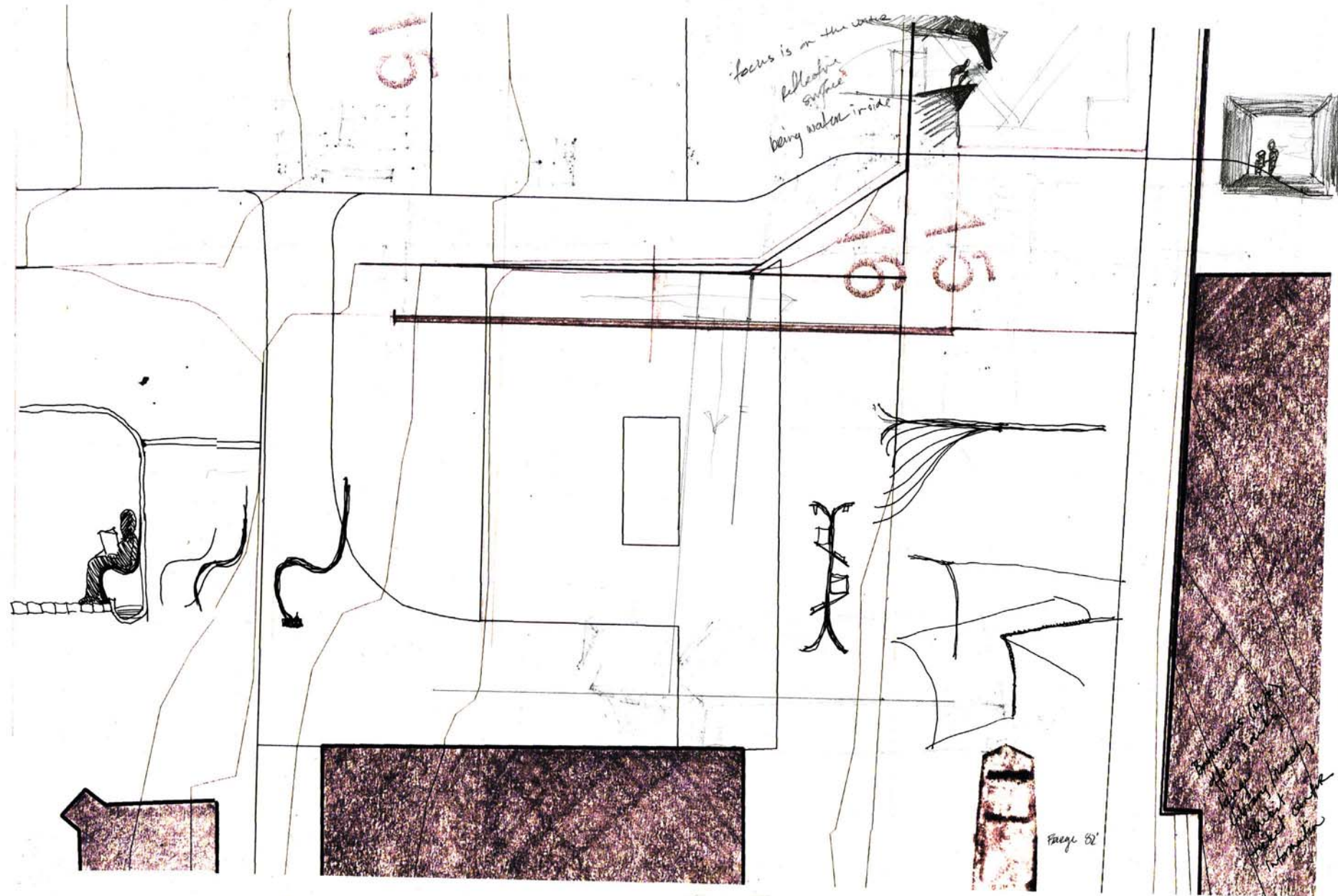
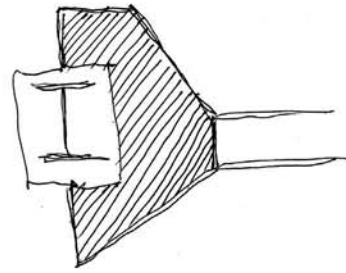
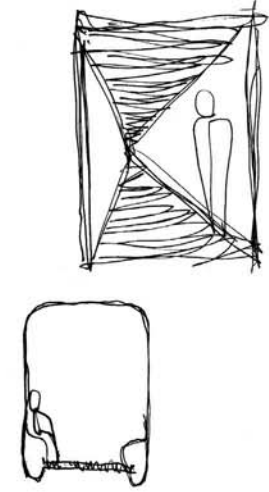

ROLL: Similar to the tower, I explored the idea of a tunnel entrance. Here I was looking at new ways to bend the corten steel.

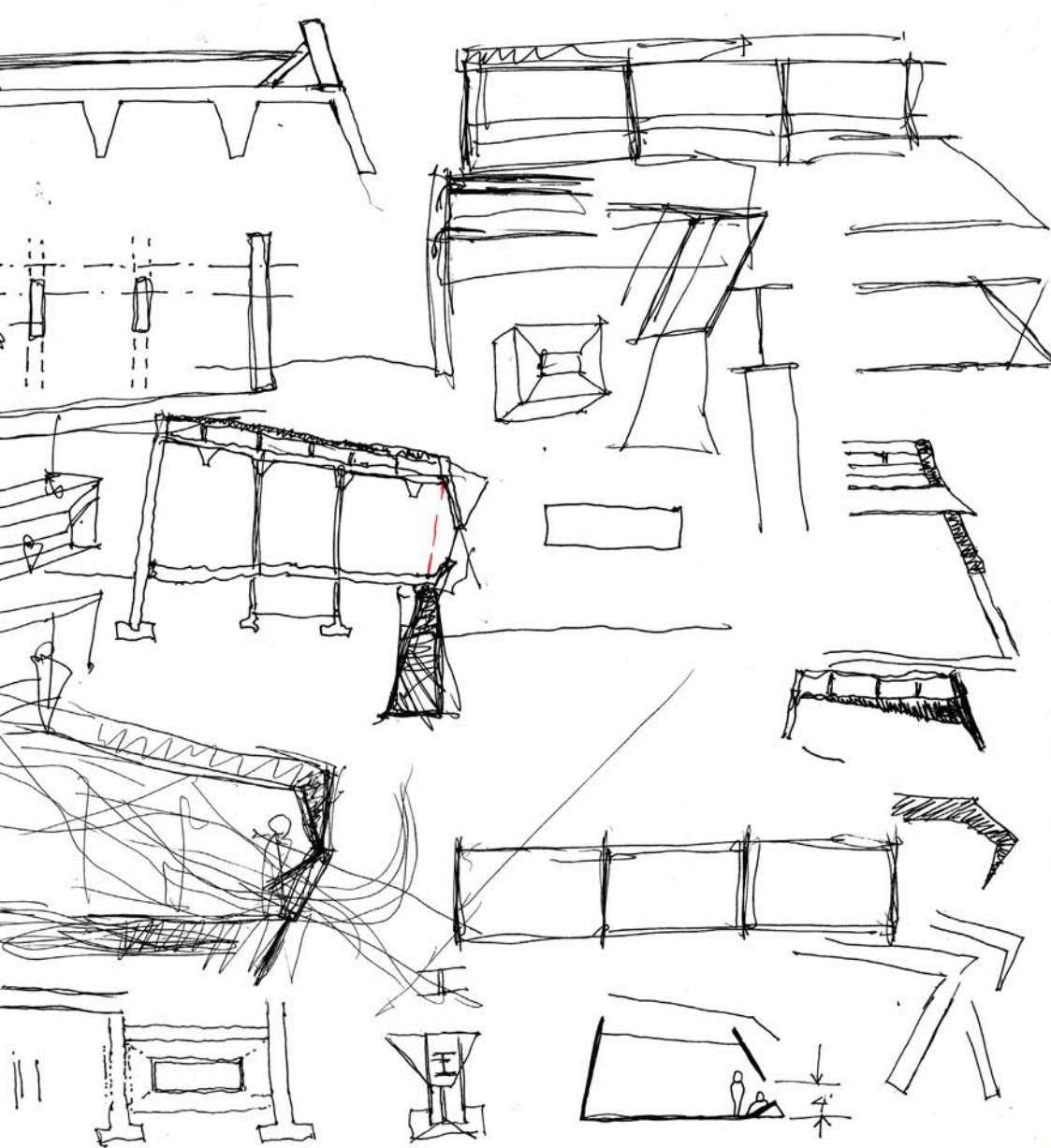

99 sketches & iterations

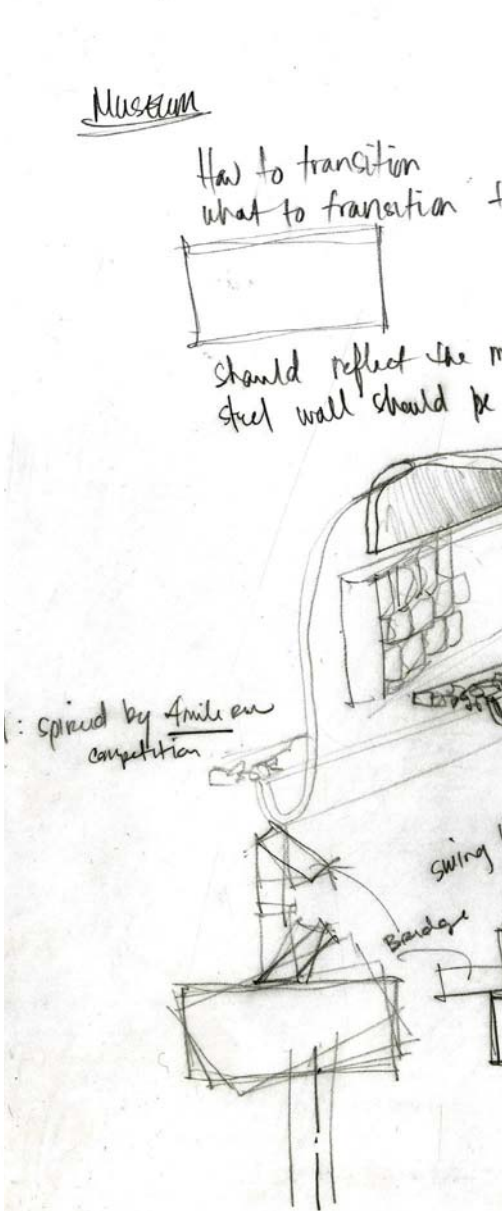
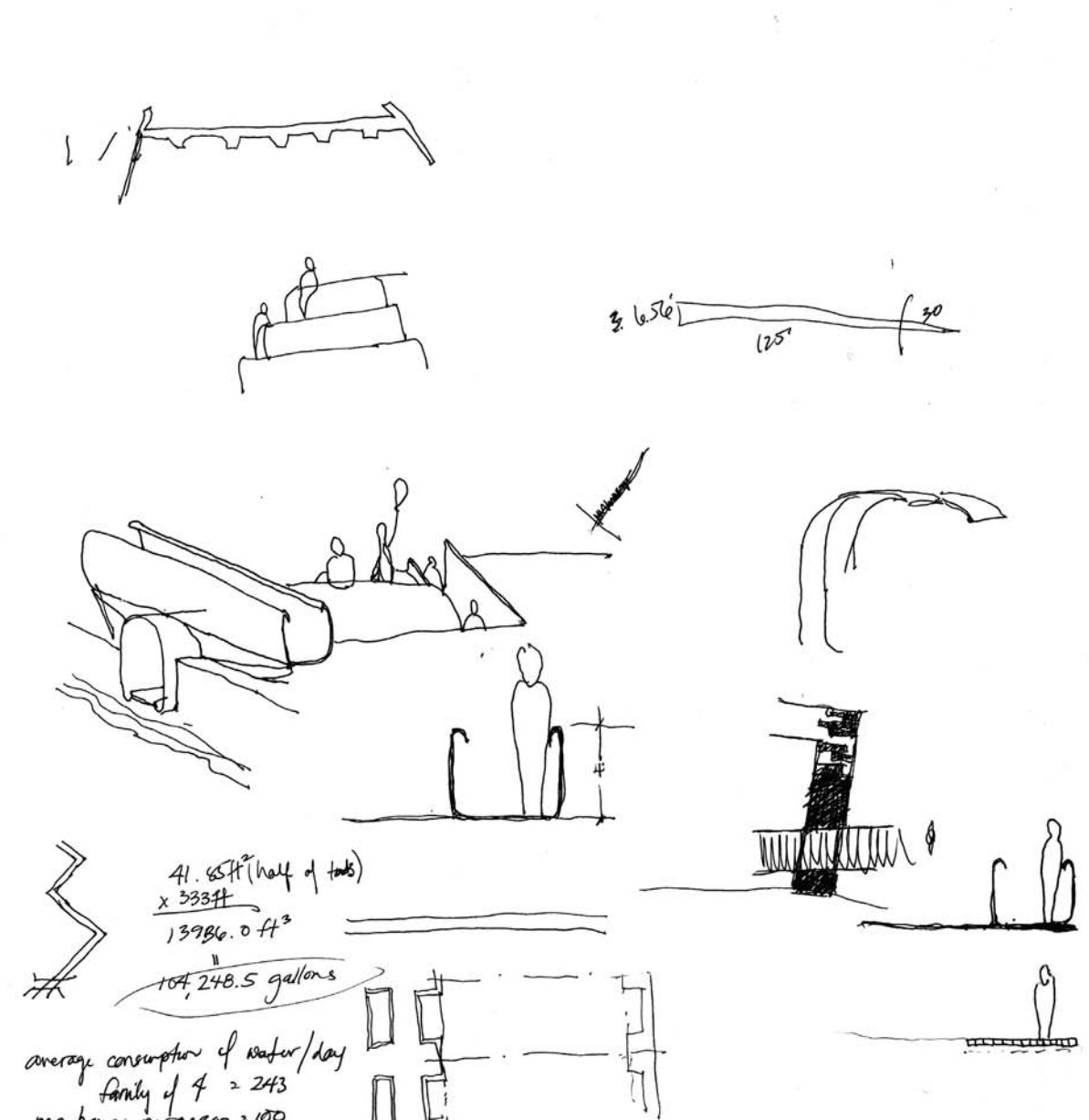
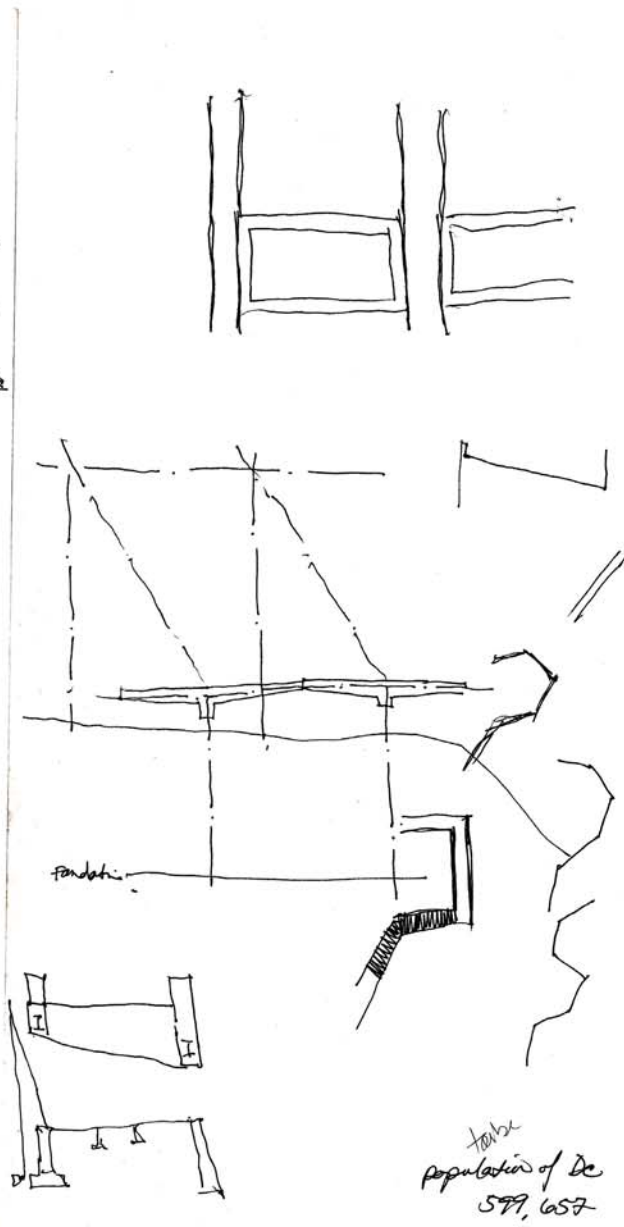

ROLL: The flow at the canal is highly controlled. The drawings shown here are studies in angular spaces.

USEFUL

How to transition
what to transition to

Should reflect the movement of water at this site
steel wall should be site specific.

by Amie en
petition

swing like tubes

keelwood saath
symbolize the water level changes

viewing deck / park

enter at the middle level (middle bly in scheme)

basement

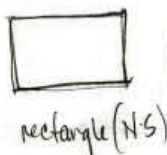

rectangle (N/S)

oval

barge

dock

smooth rail so that
the rope that pulls
the barge can move over it
smoothly.

BRIDGE

bank children

plan

hard rail

PARK

MAIN FLOOR

BASEMENT

70°



4'

6'

10'

6'

8'

23' = 46

$8 \times 12 = 96$
 $60 \times 11460 = 16 \text{ steps}$

office space
ticket sales
store
exhibit space
reading room
library
bathrooms

Reading rooms — framed viewing rooms

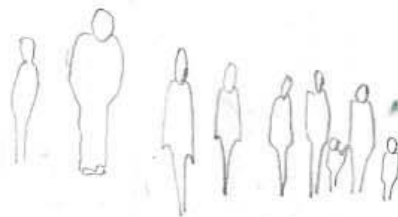

VISITORS CENTER

ROLL: In this portion of the roll I began to think about stacked floors, symbolic of the controlled waters of the canal.

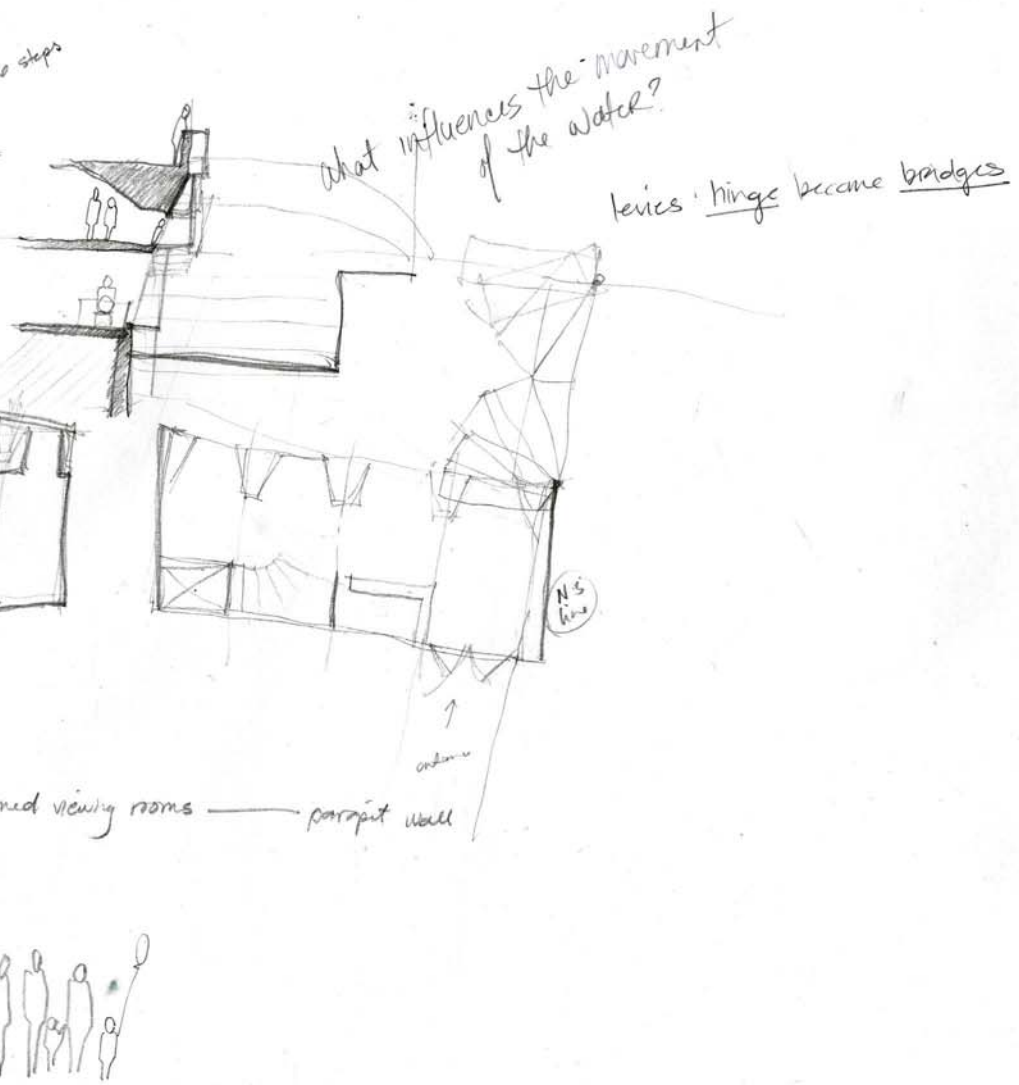

ROLL: The final concept involved controlled views and staggered floors. Above you can see the evolution of this idea.

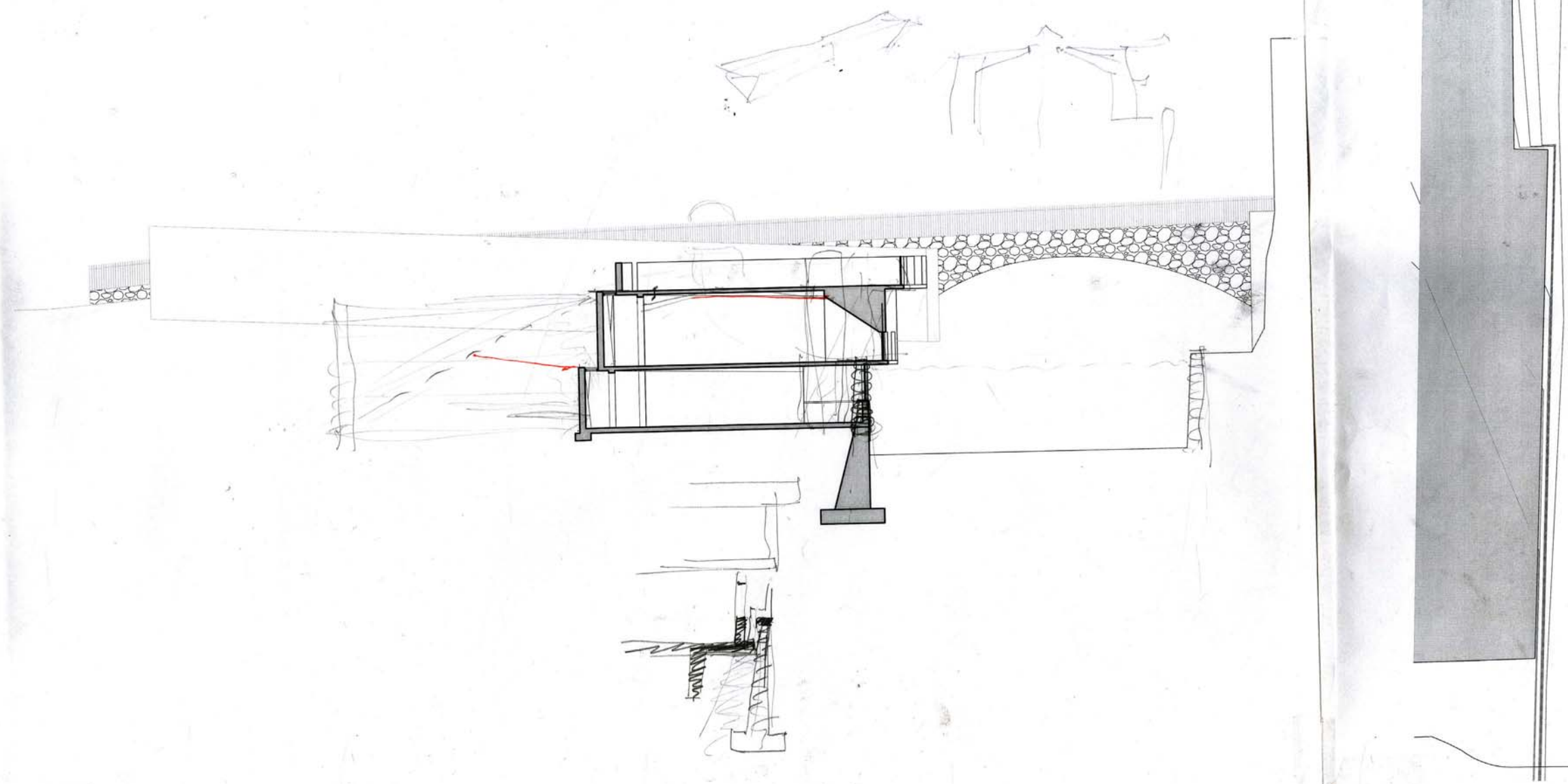

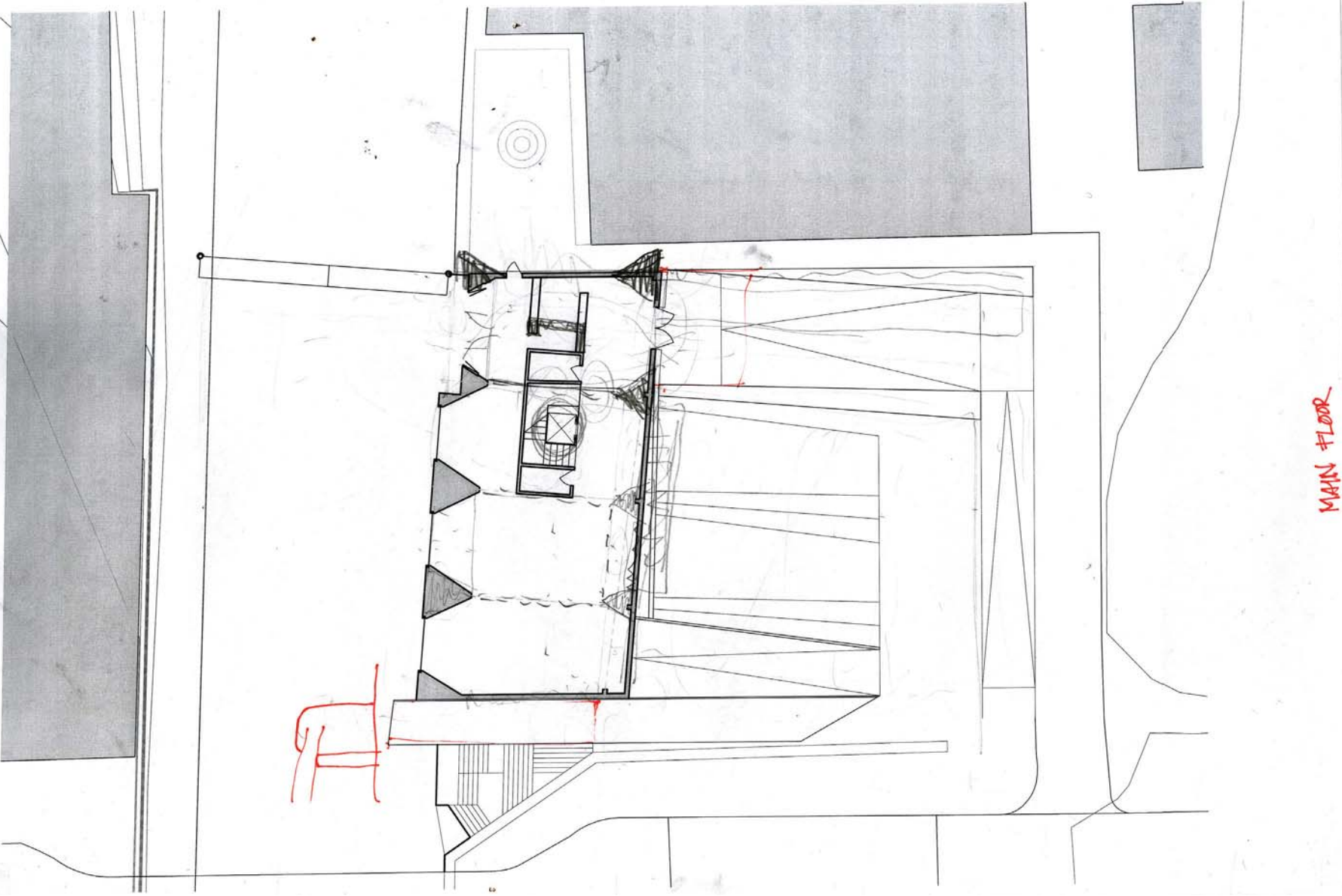

MAIN FLOOR

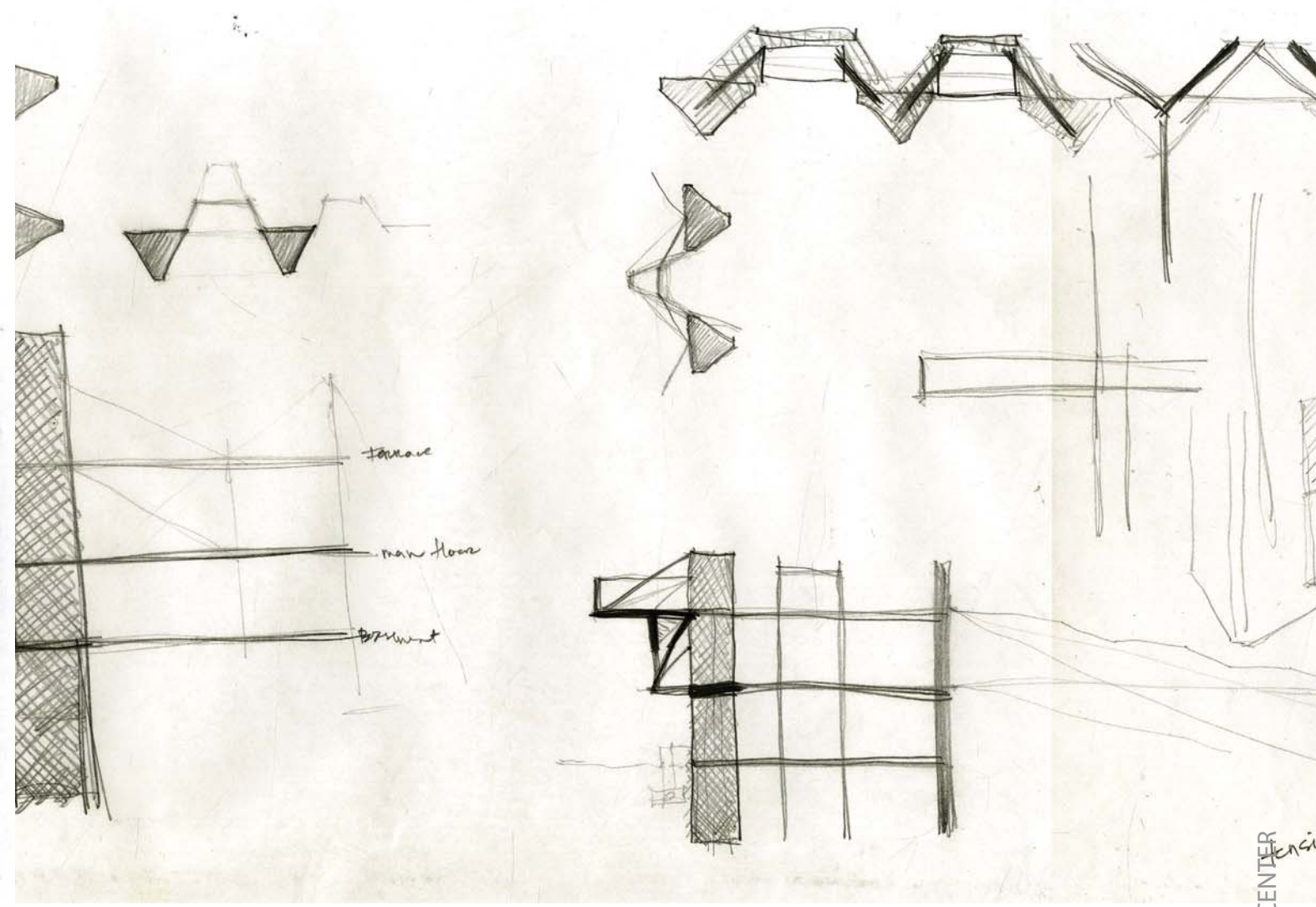

terrace

main floor

basement

ROLL: After realizing the direction of the building, I began to look at the smaller details like the supports for the cantilevered floors.

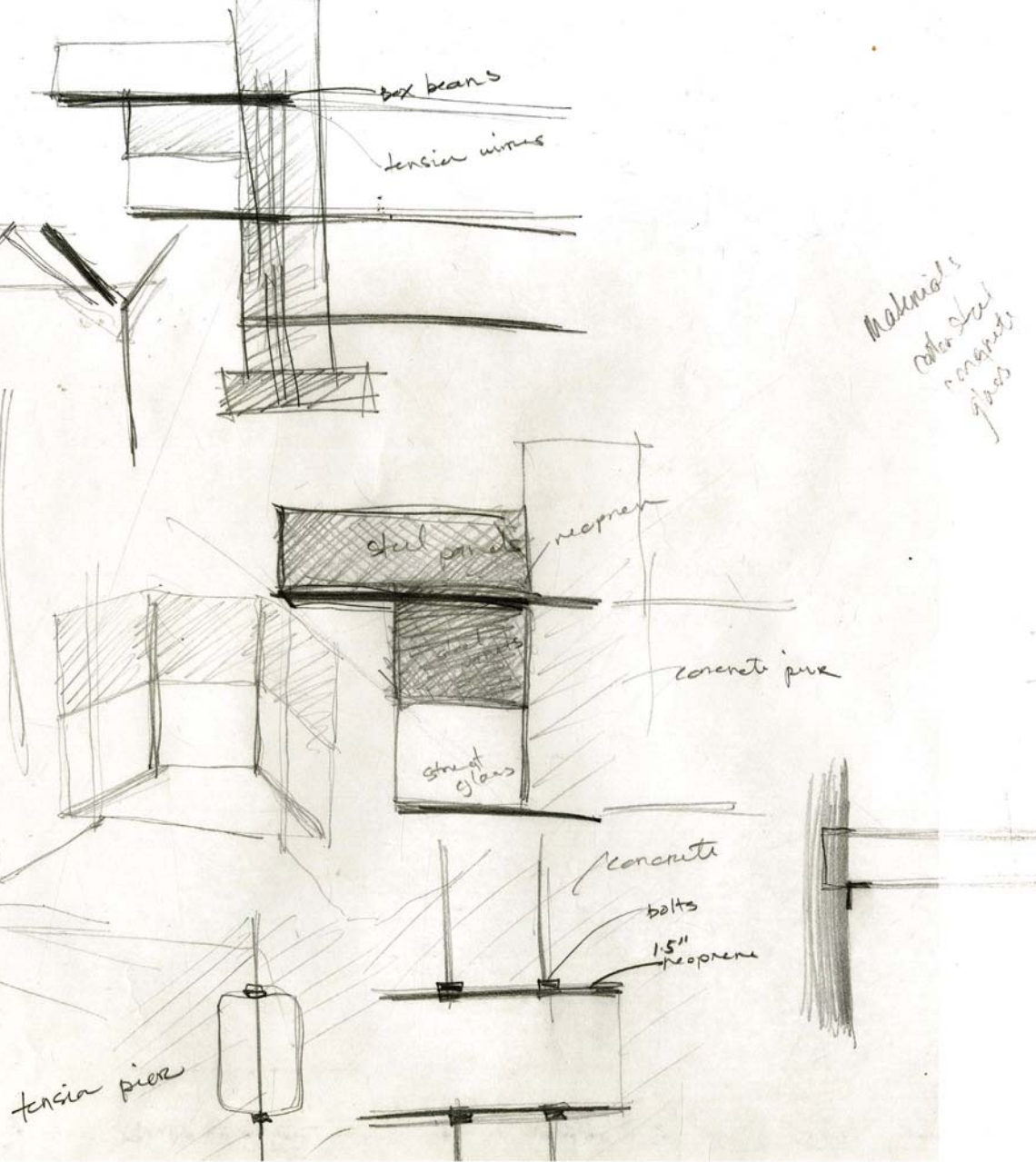

Materials
 color steel
 concrete
 glass

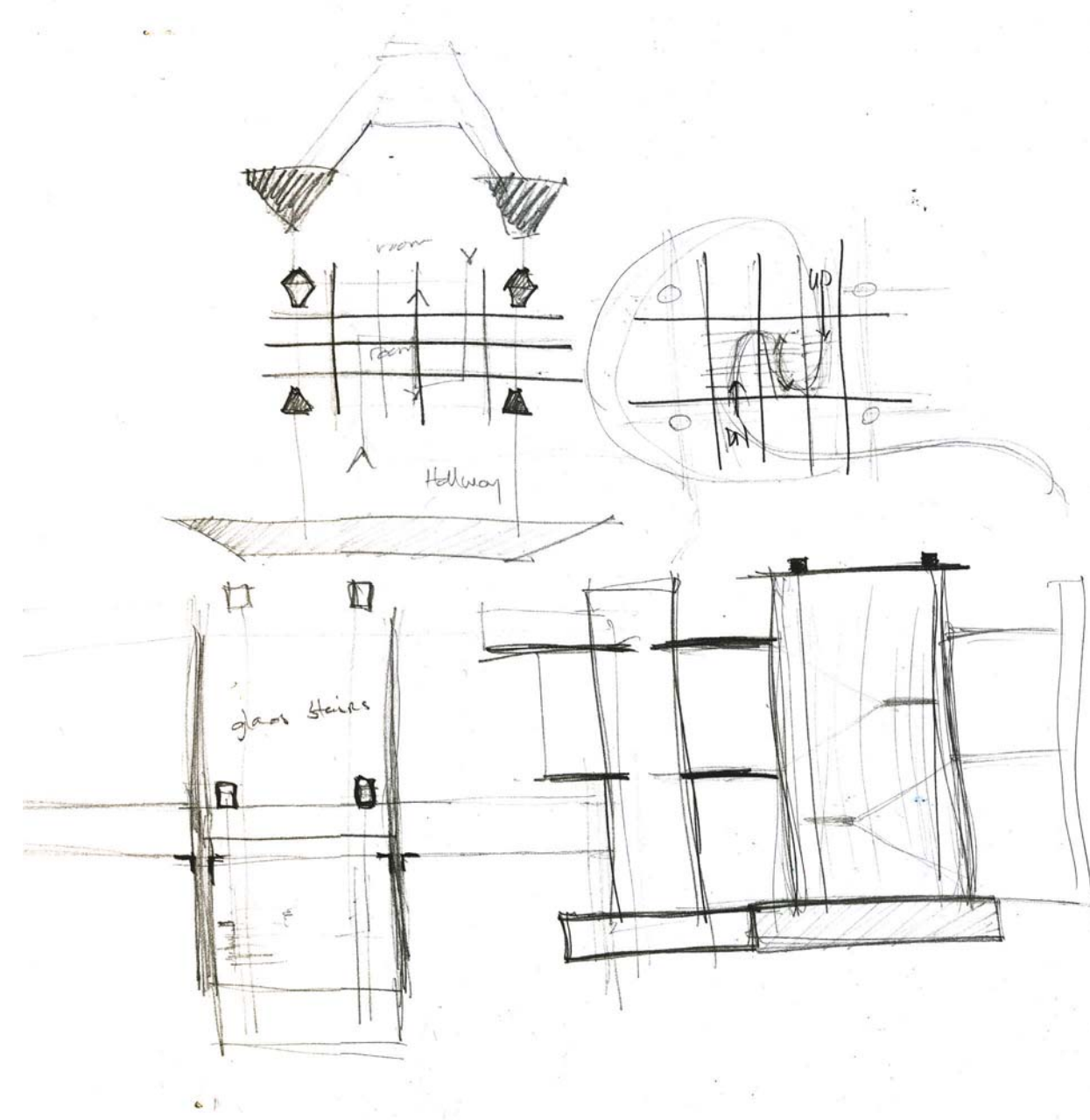

Water naturally flows downhill, but man continually tries to defy gravity. The locks allow for the complete control of the water levels on the canal. This controlled stepped movement is the main concept for the Visitors Center. Each floor is shifted towards the canal creating a view from the terrace that looks down the canal in either direction.

Visitors to the museum enter directly on the main floor where the information counter and some exhibits are displayed. On this level the visitors view is directed to the canal. Three openings jut out over the canal and direct your eyes to the water. These glass rooms are only 4 feet high, allowing visitors entering the space from the back of the building to see only the water and not the tow path beyond.

The circulation of the building can be found in the core. The main gallery space has no windows, so the staircase and the glass elevator provide some natural light.

The building is intended to be used even after business hours. The terrace can be accessed from within the building, but also directly from the street. The grade from the street to the terrace of the building is stepped. This manipulation of the landscape is symbolic of the flow of the canal. A breezeway and a retractable bridge allows pedestrians to cross to the other side of the canal more easily.

Next to the retractable bridge is a small gathering space where tours and small groups can congregate. A willow tree is planted in the center of the small space. Willows not only create intimate rooms with their branches, but they also thrive in wet environments.

The historic bridge that carries Wisconsin Avenue over the canal was a main feature on the site. The large stones on the bridge façade are full of character. I wanted to create a small intimate space to enjoy the bridge. A series of steps leading to the bottom of the canal are adjacent to bridge. Inspired by Carlo Scarpa, these steps allow people direct access to the water. As the levels in the canal change, the water begins to play on the steps. There are few places in Washington DC where people have direct contact with the water, and these steps allow people to really feel the flow of the water.

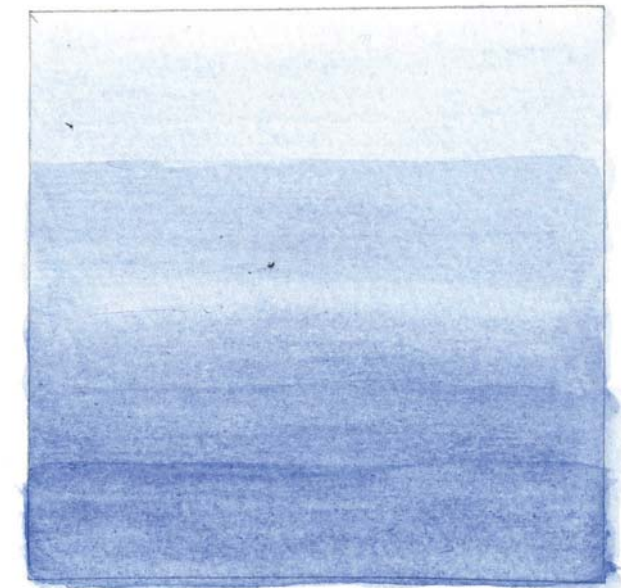

56. Fondazione Querini Stampalia, designed by Carlo Scarpa in Venice, is a library and art gallery. This photograph shows the gates and the steps that accept visitors from the canal. While the Venetian canals may seem static, they actually have a natural tidal flow. As the tides change the steps are flooded.

57. Plan of the canal entry

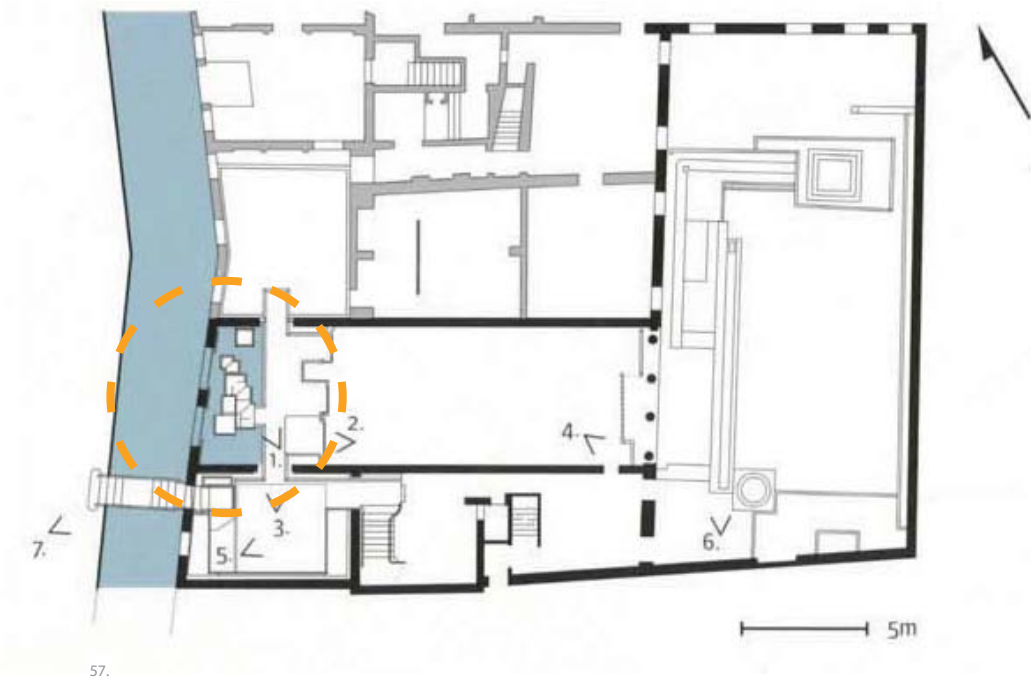

- 1. Entrance
- 2. Terrace
- 3. Retractable bridge
- 4. Willow tree and gathering space
- 5. Terraced landscape
- 6. Historic stone wall
- 7. Canal Stairs

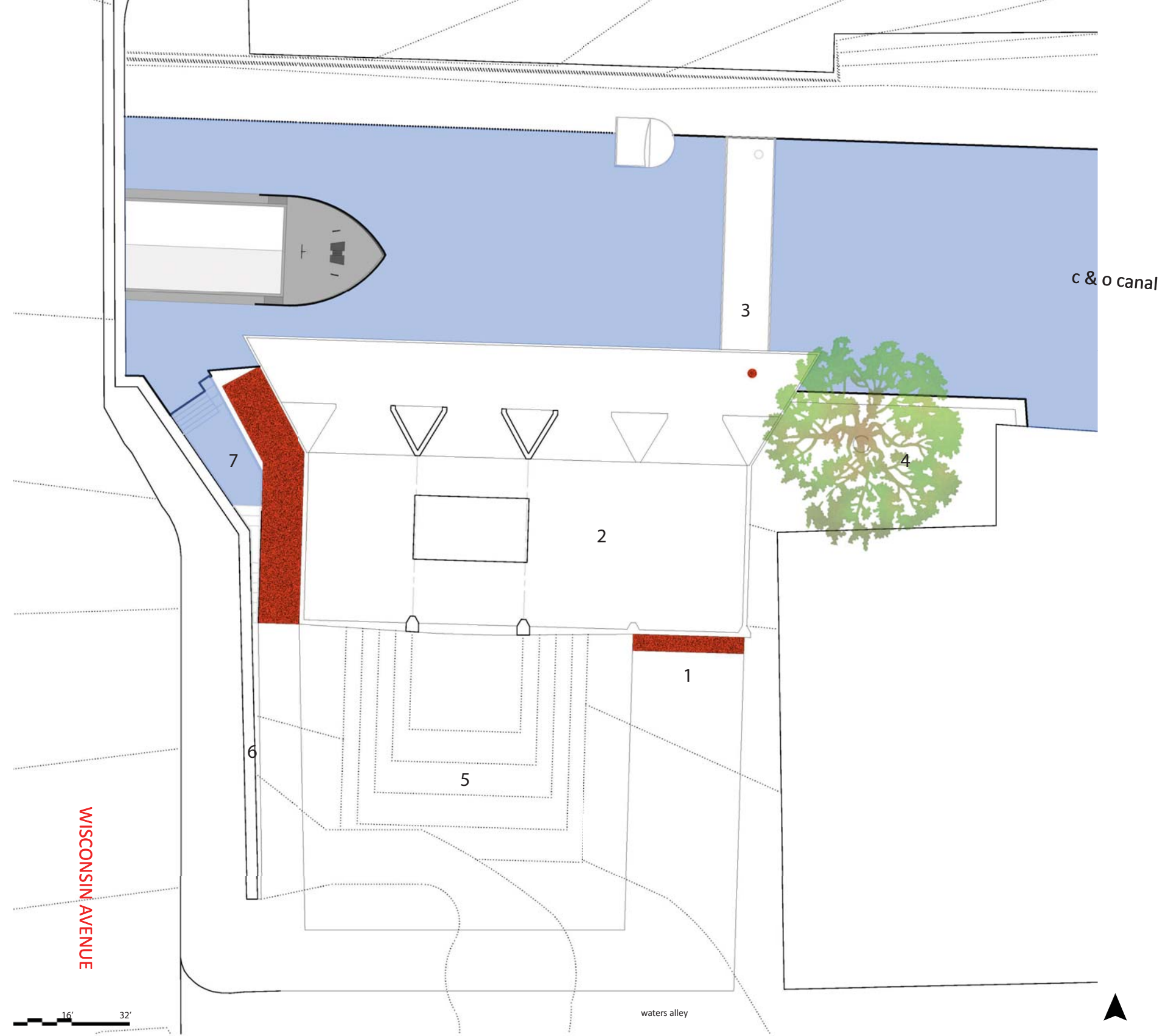
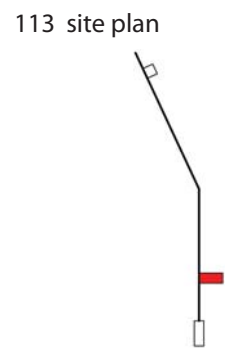

- 1. Main gallery space
- 2. Office
- 3. Restroom
- 4. Mechanical room
- 5. Canal stairs
- 6. Barge

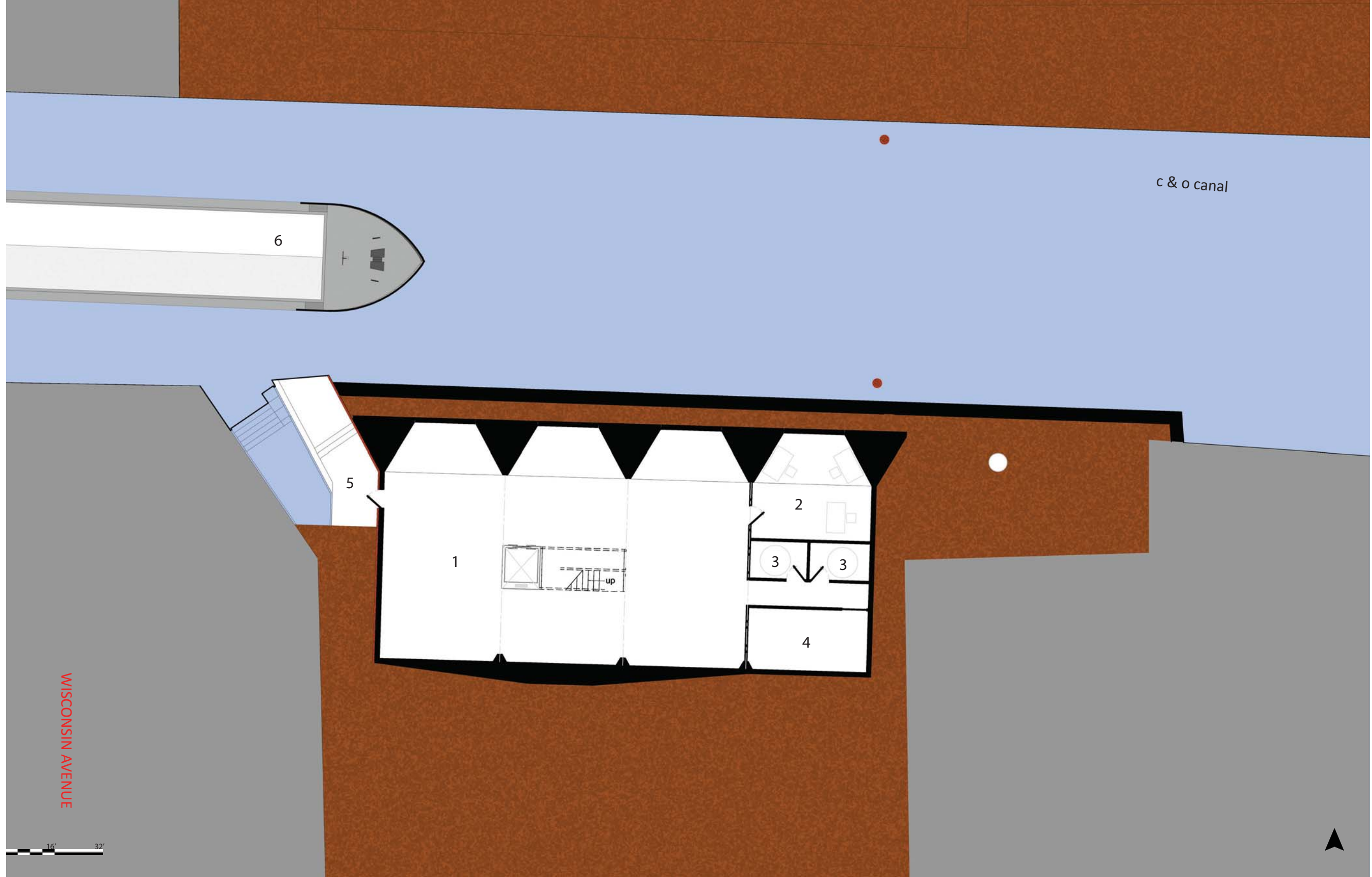

WISCONSIN AVENUE

16' 32'

- 1. Entrance
- 2. Information desk
- 3. Gallery space
- 4. Structural glass floors and windows
- 5. Exit
- 6. Breezeway
- 7. Willow tree and gathering space
- 8. Retractable bridge
- 9. Canal stairs

117

WISCONSIN AVENUE

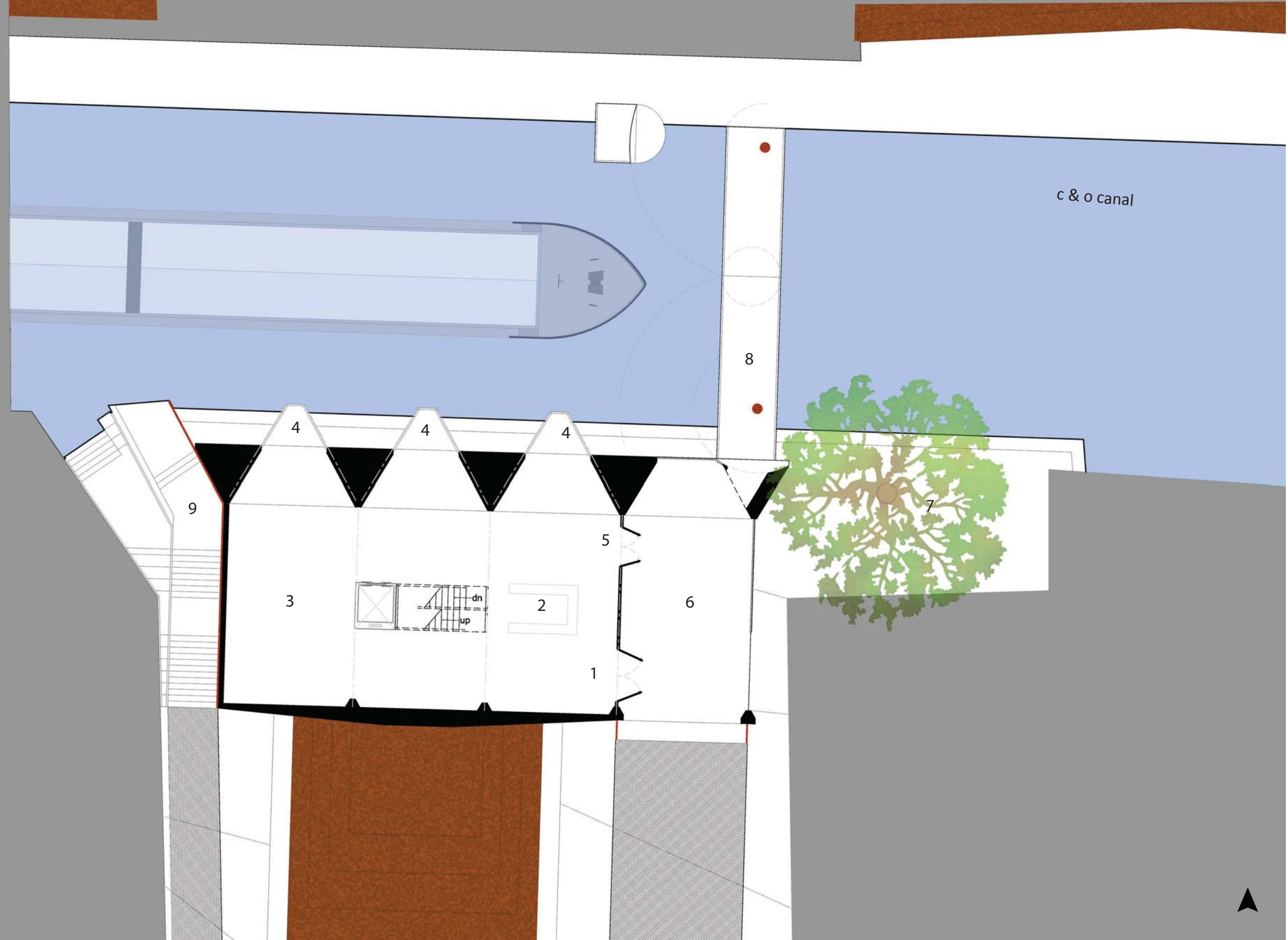
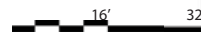

ground floor plan 118

- 1. Circulation
- 2. Terrace
- 3. Seating
- 4. Terraced landscape
- 5. Canal stair cover

WISCONSIN AVENUE

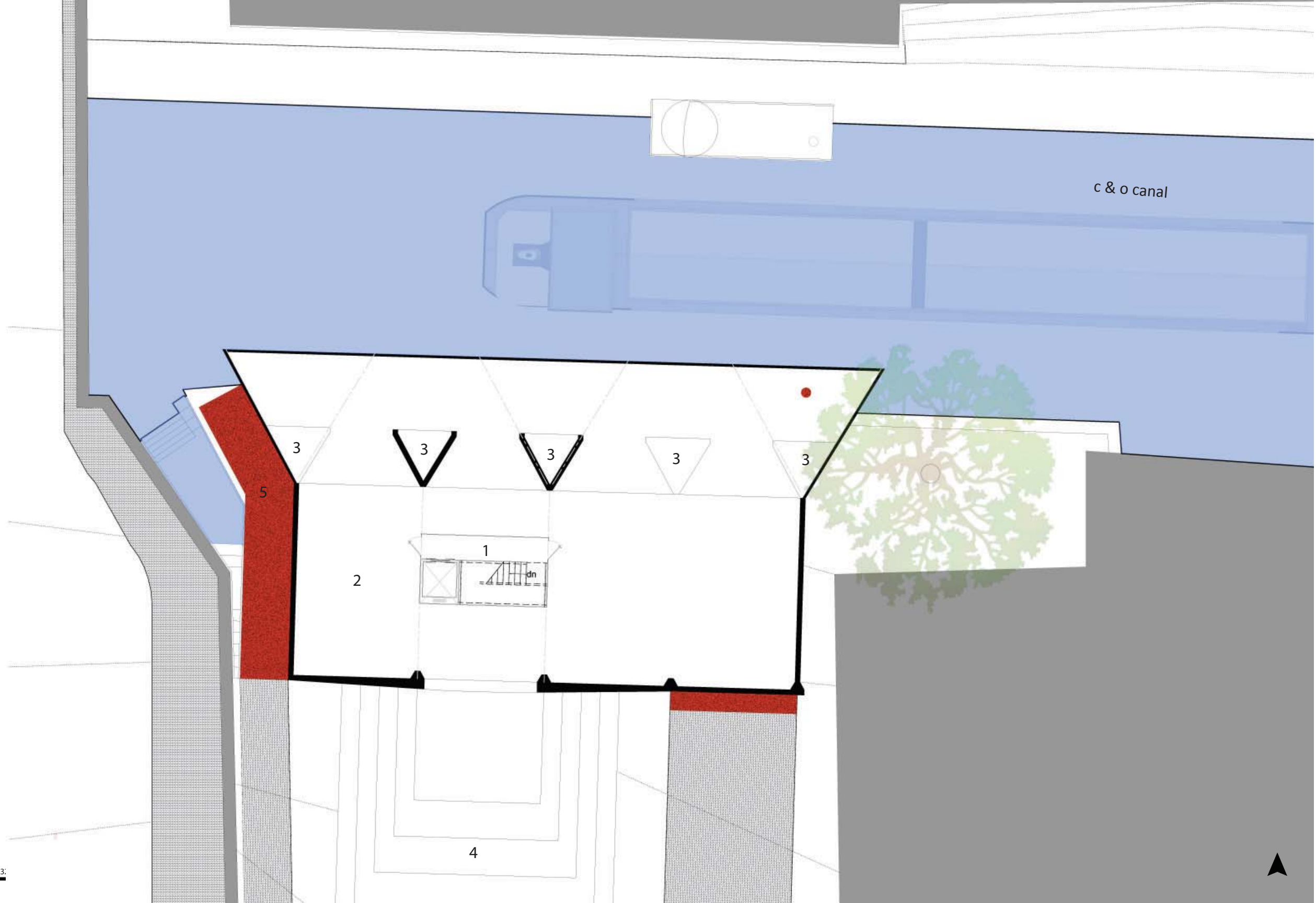
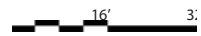

- 1. Cover
- 2. Barge
- 3. Tow path
- 4. Water line of the Potomac
- 5. Wisconsin Avenue

121

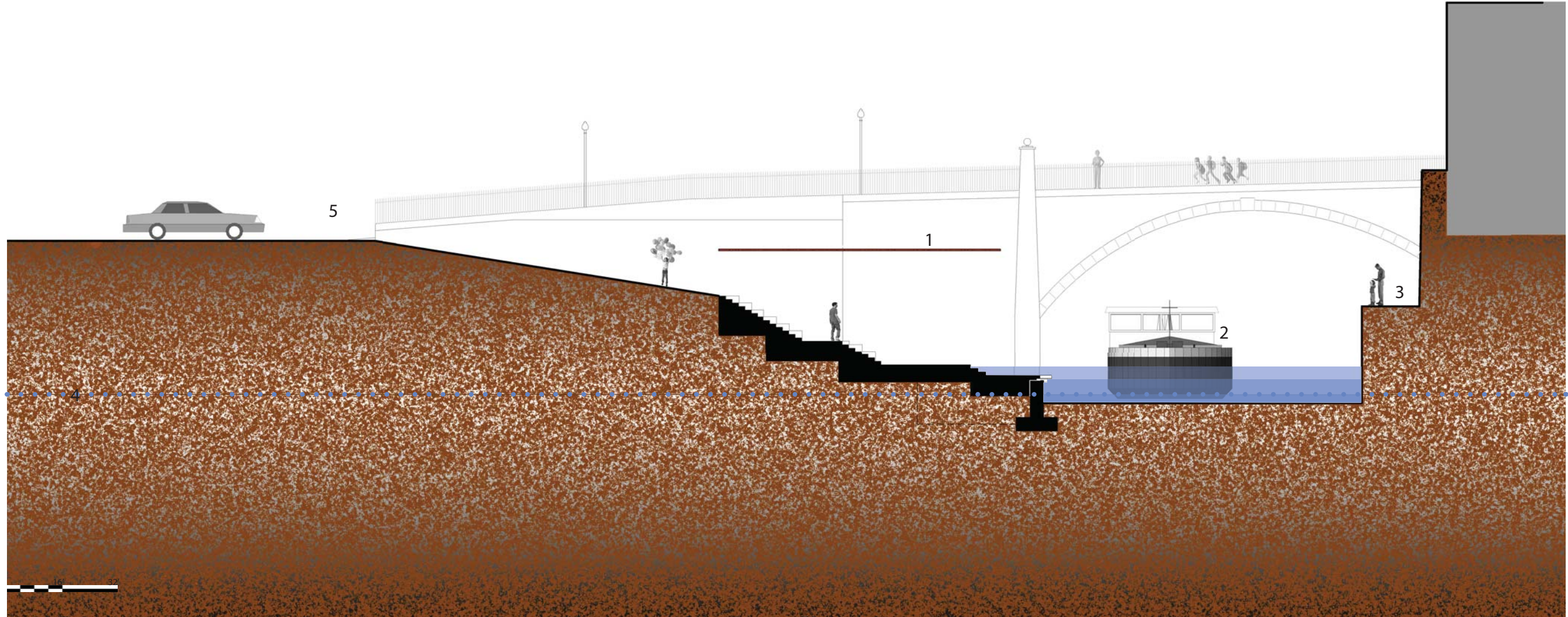

canal stair section 122

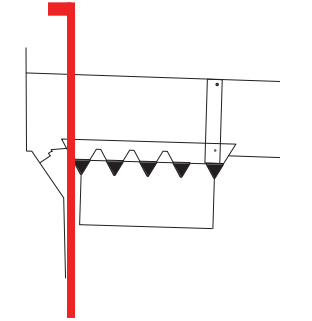

123

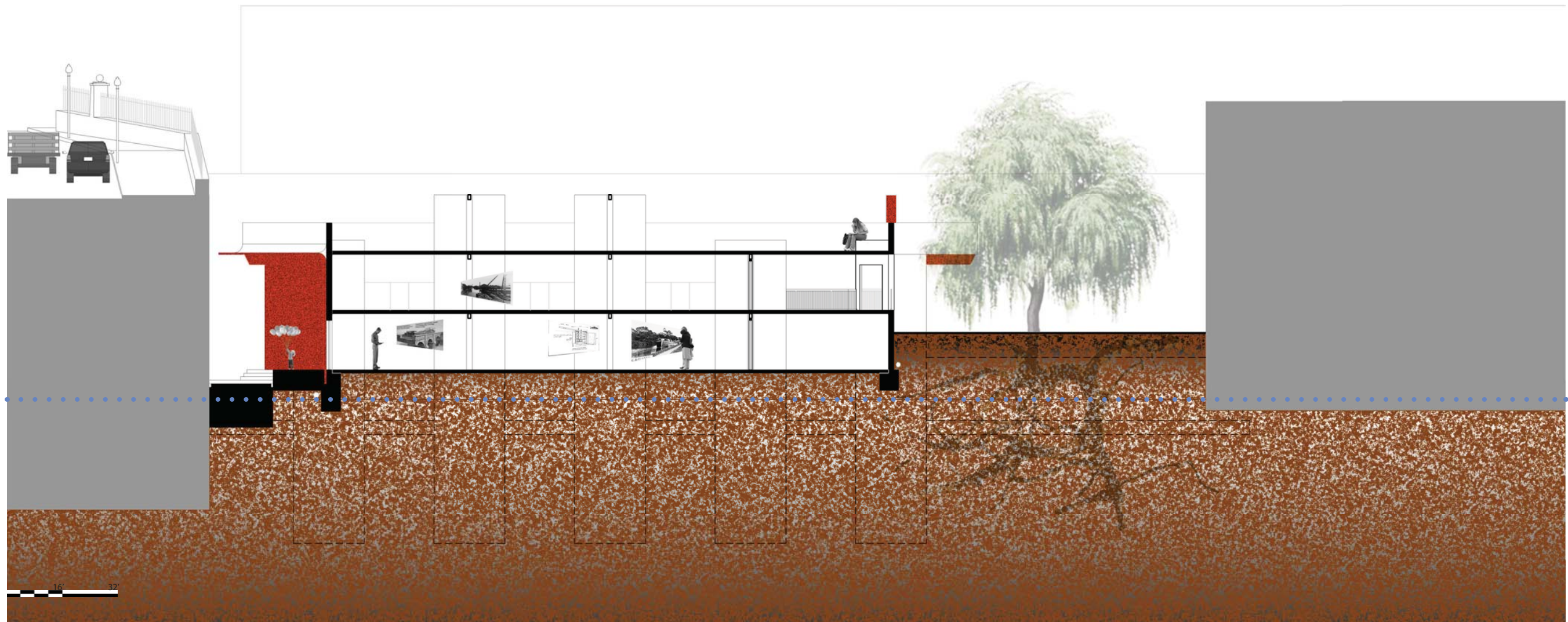

longitudinal section 124

VISITORS CENTER

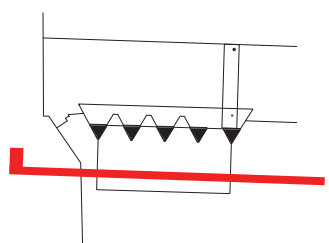

125

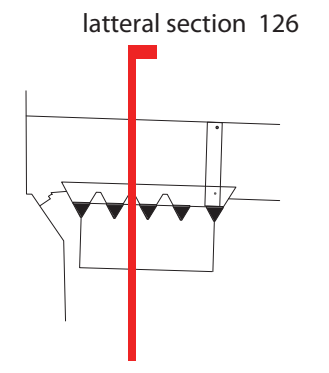
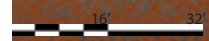
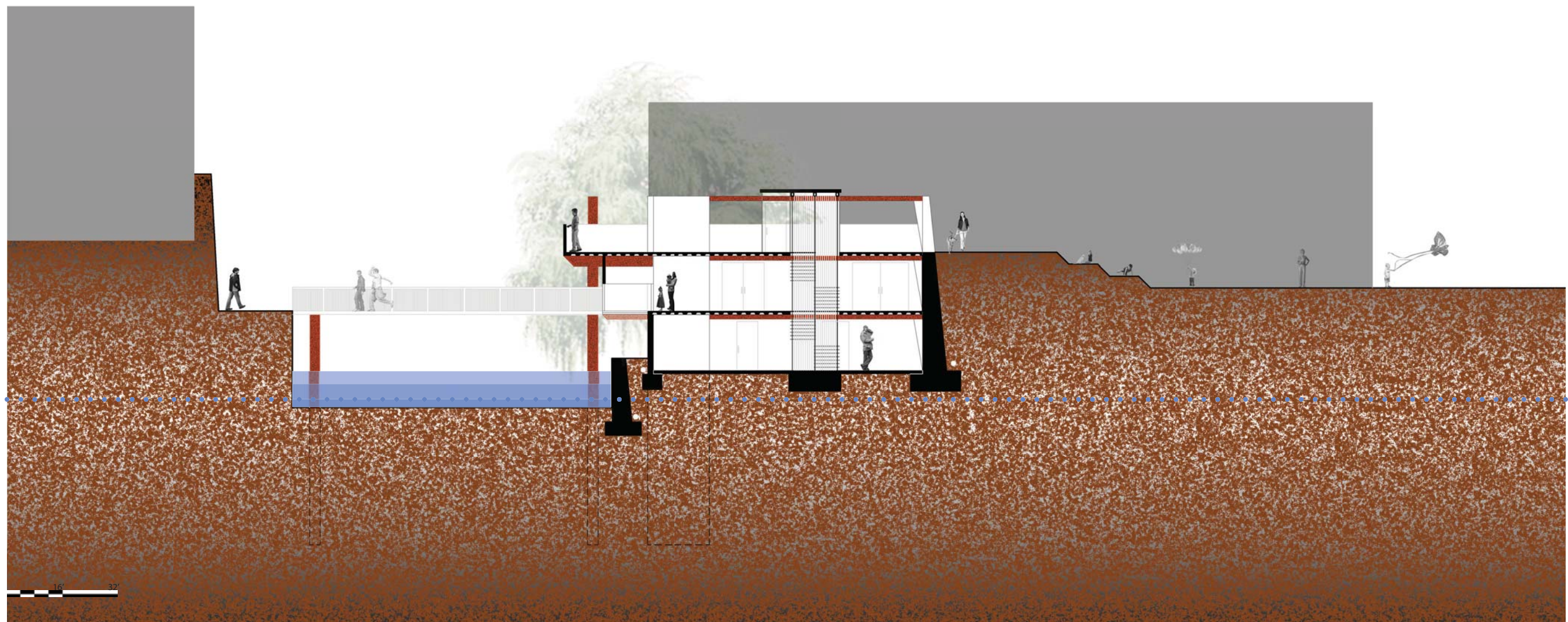

lateral section 126

| VISITORS CENTER

58. Five concrete piles support the cantilever of the two upper floors. Cast within each pile are three box beams.

59. The piles go deep into the ground and sit on solid bed rock.

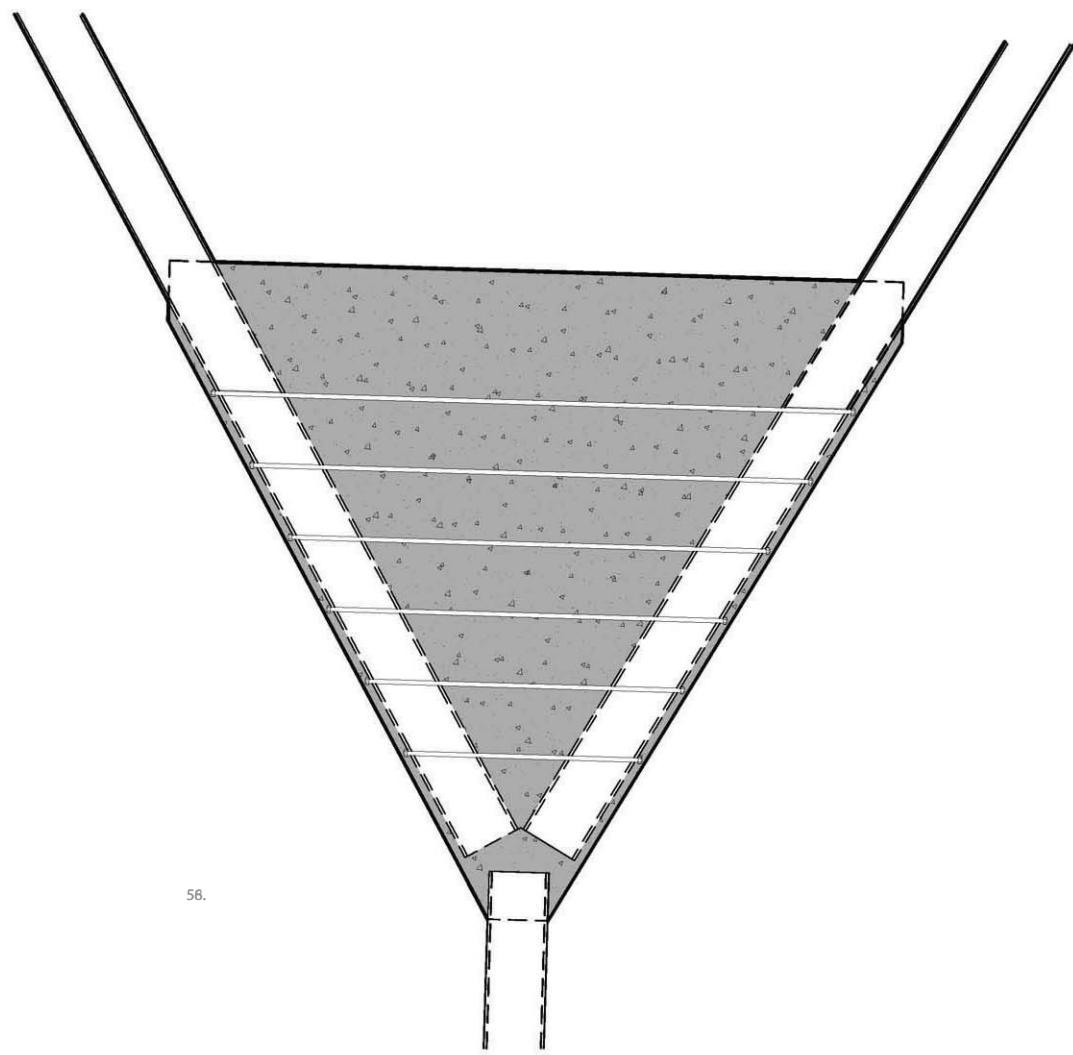

127 piles

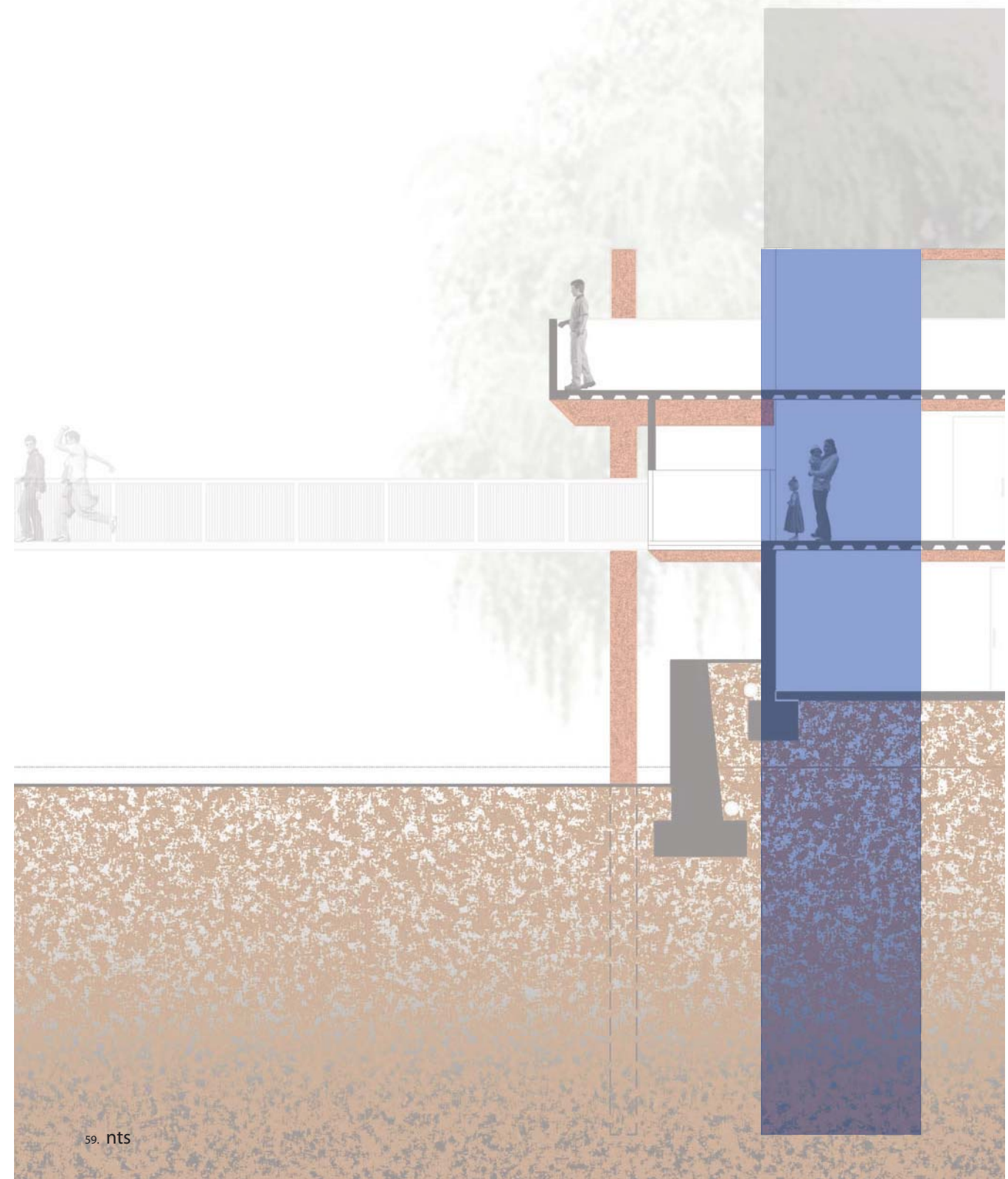
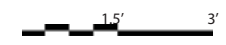
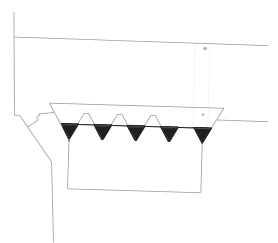

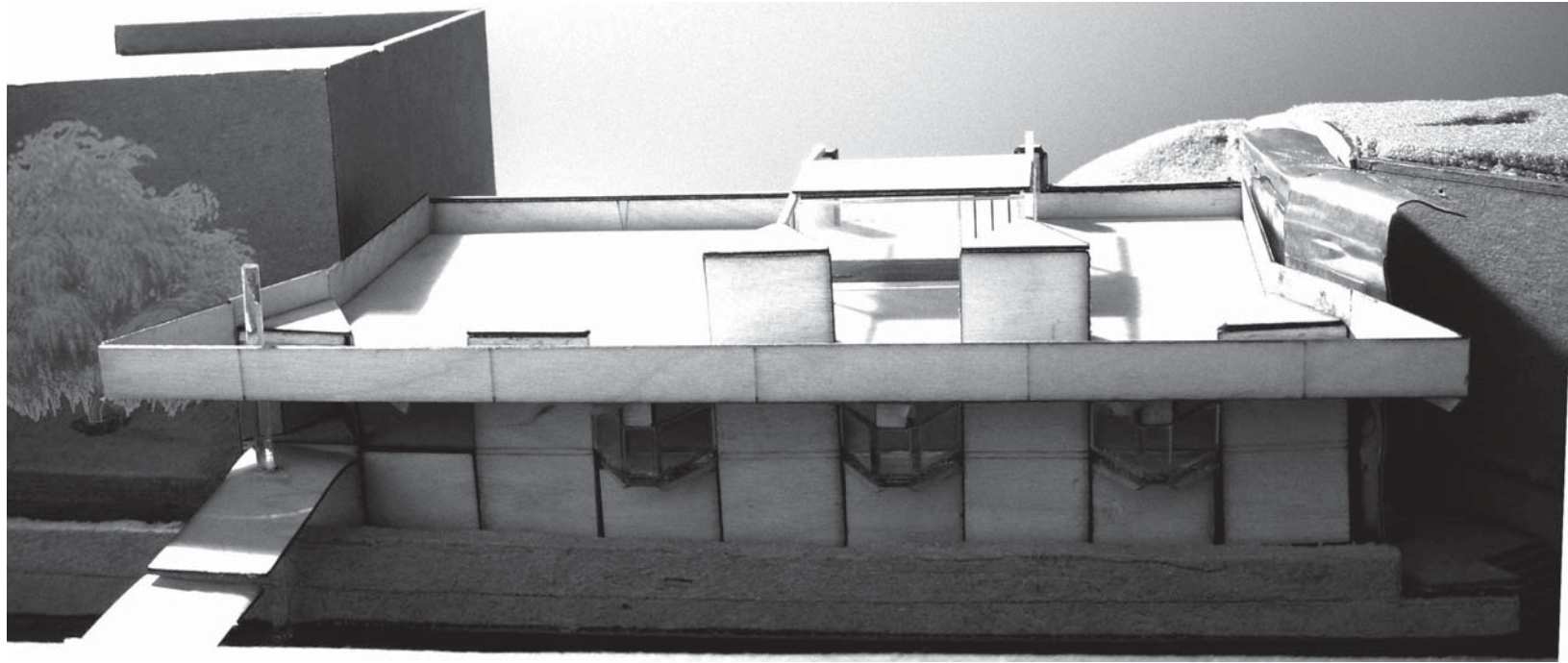

129 model north side

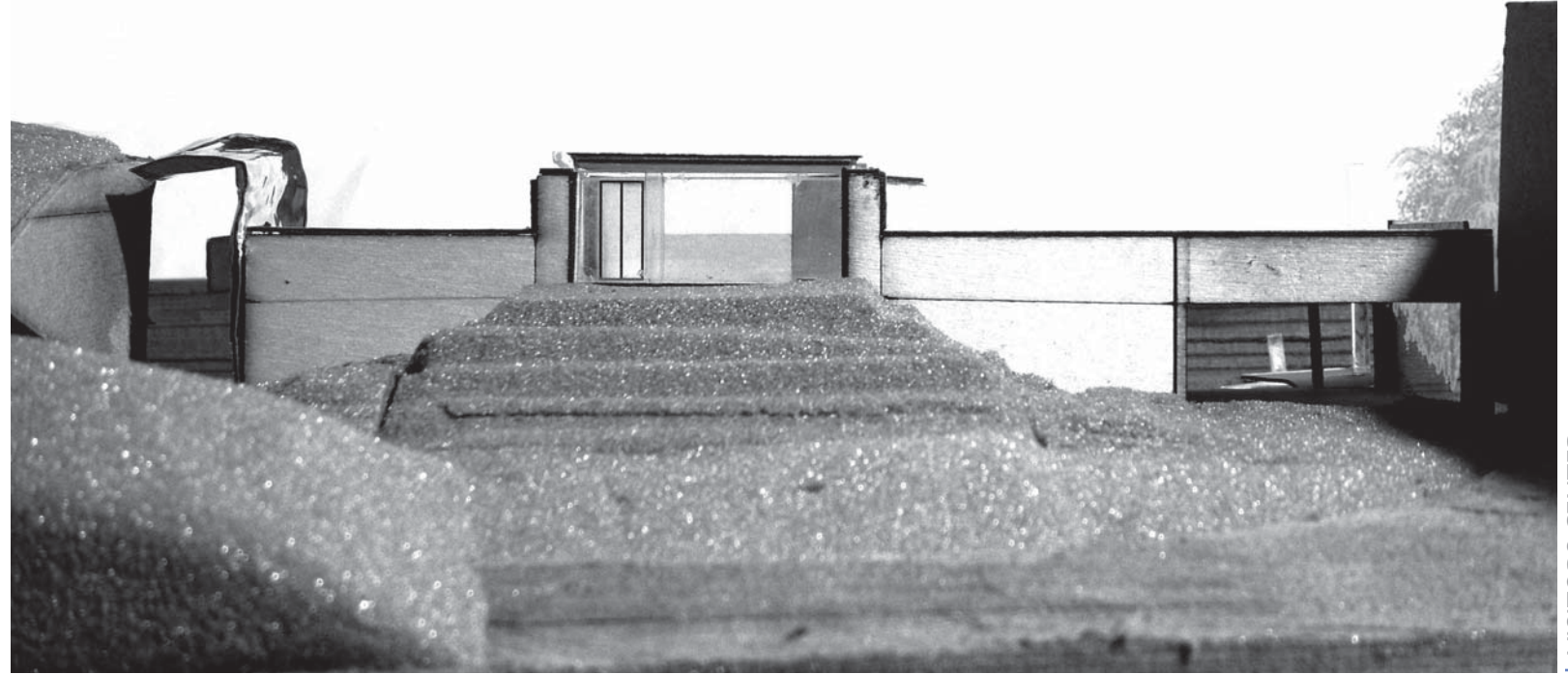

model south side 130



131 model west side



model east side 132

