

The Xcel Sleeve

Fall Prevention Through Digital
Strength Training

Joseph Ulrich Kauffman IV

Thesis submitted to the faculty of the Virginia Polytechnic and State University in partial
fulfillment of the requirements for the degree of

Master of Science
in
Architecture

Bill Green, Chair

Ed Dorsa

Ron Kemnitzer

May 4, 2009
Blacksburg, VA

Keywords: fall, balance, industrial design, therapy

© 2009, Joseph Ulrich Kauffman IV

The Xcel Sleeve

Joseph Ulrich Kauffman IV

Abstract

In America, a person has a 1 in 3 chance of falling each year once they reach the age of 65. When someone falls, they risk bodily injury. There are products available to help people when they fall, but they are only effective once a person reaches a point where they are at risk of falling. In order to reduce an individual's chance of falling as they age, preventive measures must be taken before the problems develop. With the use of digital technology, adults can be properly instructed on how to keep their bodies strong and balanced for their golden years. This thesis documents the research, conceptualization, and development of the Xcel Sleeve.

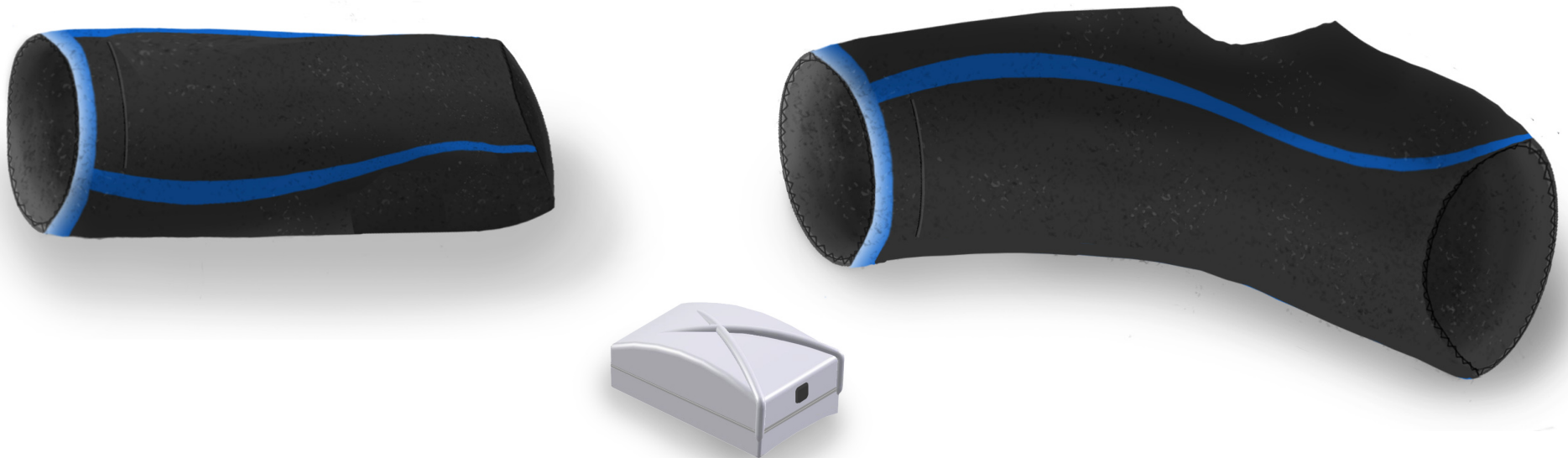



ex·cel

transitive verb: to be superior to : surpass in
accomplishment or achievement

- Webster's Dictionary

Table of Contents

Falls and Injury	1
Current Products	2-3
Initial Research	4
The Core	5
Goals and Needs	6
Market Research	7-8
Inspiration	9
Base Technology	10
Wearing The Device	11
The Display	12
The Pod	13
Sleeve Patterns	14
The Xcel Sleeve	15-16
How It Works	17
How It's Made	18
How It's Used	19
Expanded Markets	20-22
Future Concept	23
Appendix A: Bibliography	25
Appendix B: Video Recordings	26
Appendix C: Interviews	27-28
Appendix D: Pictures	29-31
Appendix E: Case Diagram	33-34

Falls and Injury

According to the Center for Disease Control, in 2000 the medical costs for non-fatal fall injuries was estimated at \$19 billion. Just how much is \$19 billion? With all of that money, one could easily purchase the top 16 highest grossing football teams in America. However, this money is not coming from sports enthusiasts, it is coming from people who have hurt themselves. When these people fall they can suffer bruises, hip fractures, wrist fractures, and even head trauma.

These injuries require weeks, sometimes months, spent in physical therapy sessions. According to the CDC, 1 in 3 adults of 65 years and older will fall at least once during the year. At 80 years and older, that number jumps to 1 in 2.

People fall, and the older they get the more it happens. There are products that attempt to keep people from falling, but many of them are only effective once a person is at risk. Is there a way to keep an individual from falling by training them at an early stage? It is intended that the Xcel Sleeve will help users reduce their risk of future falls, saving them money and saving them from the pains of injury.

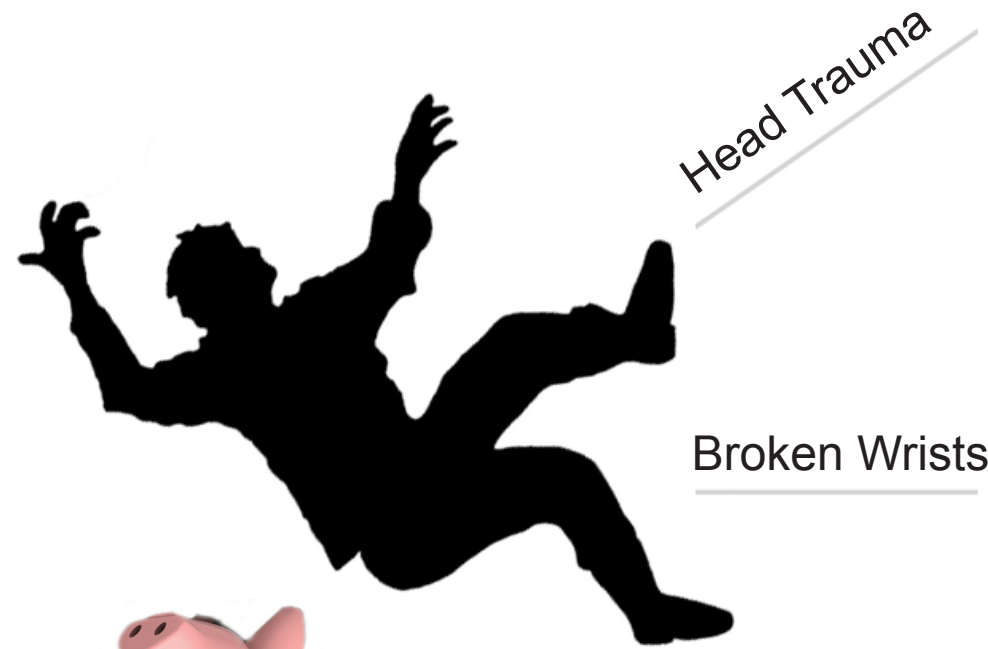

Broken Wrists

Broken Hips



\$19 Billion
Enough to buy 16 football teams

Current Products

There are many products on the market made for people who have fallen or are beginning to lose their ability to balance. There are the standard selection of canes and walkers which have changed over the years.

Canes have all sorts of different styles of handles, grips, bases, colors, and materials. These products are many, and it is nice to see such a variety of choices to suit different needs.

Walkers have also begun to change in style and material. The frame is still lightweight aluminum, but the material for the grips and other parts have changed. The walker's image has changed from just being a tool to a part of a user's life. This is seen with the wheeled walker's curves, deep coloring, ergonomic grips and hand brakes, storage basket, and fold down seat.

These two products serve their purpose, but they are turning their user's arm(s) into an extra leg. The human arm is capable of many things, but the shoulder and wrist were not meant to support the weight of a human body. Some users of canes and walkers report wrist and shoulder pains when they use the devices to support their weight for prolonged periods of time.



Current Products

There are a small assortment of products that have been developed to assist in either fall prevention or fall cushioning as well. Some of these products are interesting and creative, but what are they doing for their user?

The first big product, which is quite popular, are the walking poles. An evolution of the walking stick and ski poles, these poles help to increase balance and reduce joint impact while walking. However, it is possible for a user's body to become dependant on the poles to maintain balance.

Next is another simplistic product called Hip Protectors, which do exactly as their name suggests. When a person falls on their side, the easiest thing to break is their hip. This absorbent padding takes the impact energy and distributes it around the hip rather than on it.

The final product still in development is an elderly airbag vest designed by the Japanese firm Prop. When a person falls, accelerometers trigger an airbag deployment around the hips, back, and head. It's a fascinating product, but with one major flaw. The majority of people who fall, fall forwards.

These products are nice in how they help reduce injury if a person falls, but they are not looking at the big picture. It's not what can be done when a person falls, but what can be done to prevent the fall in the first place. These products are just band-aids on a bigger problem



Initial Research

In order to better understand the motion of a person and why people fall, interviews were conducted early on with physical therapists and a fitness instructor. Questions were asked such as what parts of the body were most key to balance, and what could people do to reduce their risks of falls. The reason behind the question of which body parts were key for balance was the thought that a device would be developed to support that area. After talking with the therapists, it was implied that a support device would be awkward and potentially hazardous to the user because of specific areas the brace would apply pressure. A limited knowledge of detailed human anatomy also discouraged this design route.

Talks with the therapists and fitness instructor indicated that people could prevent falls by keeping their bodies active. Although some falls can be the result of bone and nerve deterioration, disease, and other medical ailments; many causes of falls can be prevented. These causes include: shuffling feet, lack of activity, not walking for fear of eventually falling, and slowing reflexes. These causes are preventable, so the potential users would be people with poor balance, aging individuals who are worried about falling, and people who are just into self-improvement.

“Un”preventable Fall Causes

Low bone density
Nerve deterioration
Stroke
Disease

Preventable Fall Causes

Shuffling feet
Low activity
Fear of falling
Slowing reflexes

Therapist Questions

Name: _____

Company: _____

Position: _____

Years Practicing: _____

Divide among 100% the importance of the following sections for balance:

Ankle	-
Knee	-
Hip	-
Back	-
Arms	-

What are some of the causes of falls with the elderly?

What percentage of your elderly patients are due to falls, slips, etc?

Is the loss of balance a result of muscle atrophy, or is there more to it?

I heard muscle loss with age is inevitable what can people do to prevent this?

What exercises do you do to help encourage muscle growth?

Are you aware of any products for the elderly on the market?

Will improperly using equipment cause further injury?

What is the educational process on how to use the equipment?

Would it be possible/advisable to shift a person's center of gravity for better balance?

Potential Users

People with poor balance
Aging individuals
People into self-improvement

The Core

For a person to reduce their risk of falling, they must keep active and do it in a manner that does not pose a danger to their own health. Ironically many people will slow down, moving with more caution so they will not hurt themselves, but this is actually doing the greatest harm to their bodies. Slowing the body down, such as taking smaller steps, will increase one's chance of falling. It is true that as the body ages there is muscle loss, but that does not necessarily mean muscle strength loss.

These days, people are instructed to work on their core in order to give their body better balance. The body's core is located from the top of the abs down to the hips, basically the body's center of gravity. What many people do not realize is nearly every major body motion affects the core in some way. Whenever the body has to brace itself from a motion (swinging the arm, kicking the leg, and basic walking), the core is worked.

Posture: Shoulder position affects head position; can throw off the body's stability

Shoulders: Major pivot point; nearly all arm motions occur at this point

Arms: Many arm motions put forces on the body that it must resist

Hips: Major pivot point of the legs; nearly all leg motion occurs at this point

Legs: Contain large amount of body mass; easily throws off body when moved

Knees: Kicking the knee out gives body forward momentum for walking

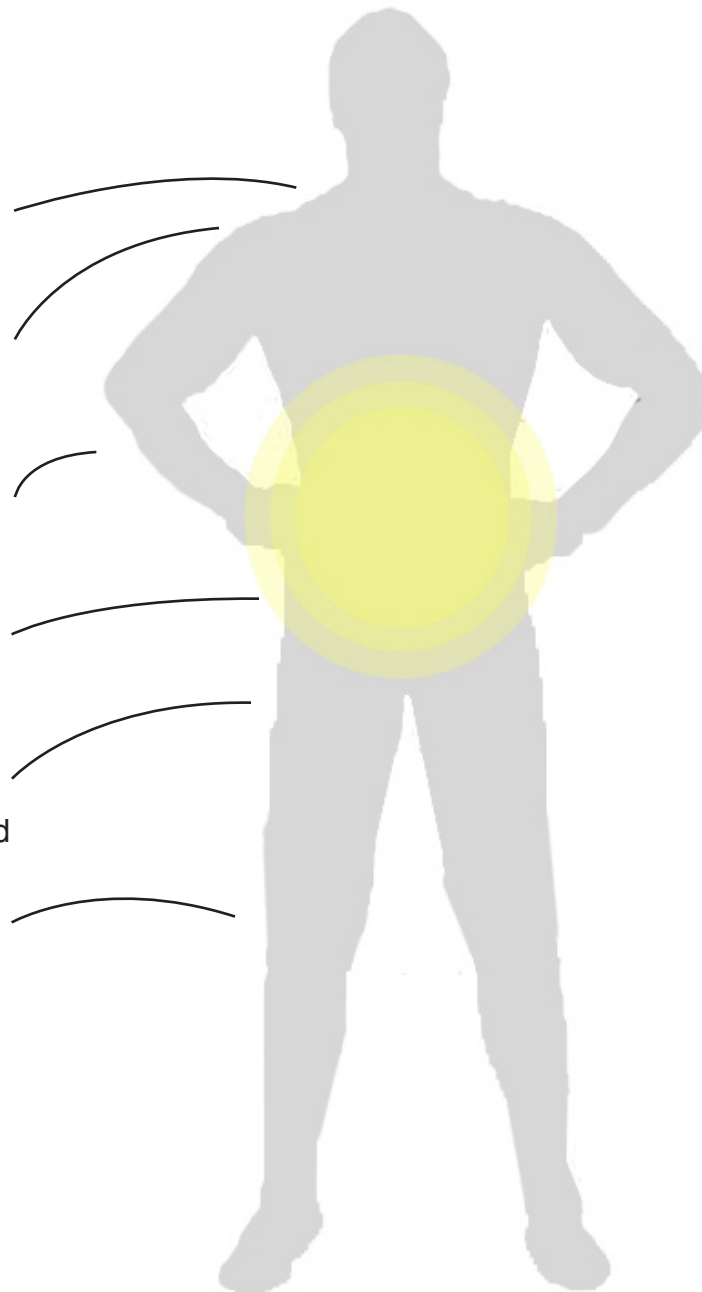

Goals and Needs

The essential goal of the Xcel Sleeve is to train its users to maintain their physical strength and confidence as they age. It must promote an independent, active lifestyle. Older individuals who continue to be active, are more self-reliant and confident.

There are two main product needs for the Xcel Sleeve: real-time display and water resistance. Many studies are being conducted by different groups to fully map and monitor the human walk. The hope is some form of a walking equation can be applied to each individual. If the person begins to deviate from that equation, that will be an indication that the person is about to fall. Currently there is no definite way of predicting exactly when a person will fall, but there is a sign which is noticeable: shuffling feet. If a person is not picking up their feet to an appropriate height, they dramatically increase their chances of tripping and falling. A real-time display would let a user know this is so. The device needs to be waterproof, because aqua aerobics is a new, popular form of exercise. Since the human body is buoyant in water, there is less stress on their muscles and joints.

Last are two user needs: lightweight and low profile. If the device has too much weight, it can throw off a person's balance. A low profile is required so a user will not be embarrassed to wear it. A user may be reluctant if the device is large enough that people continually stare at it.



Encourage Independence



Waterproof

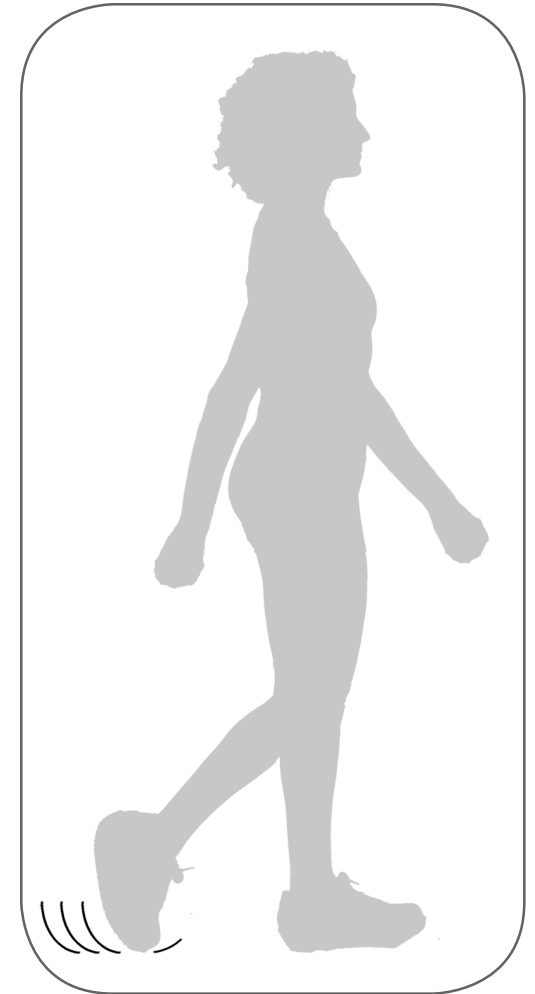

Real-Time Display

User Needs

Lightweight Low Profile

Market Research

Market research was conducted in one on one interviews with professionals in the fields of physical therapy and fitness training. The purpose was to determine what types of movements and exercises were important to a person's wellbeing. The physical therapist, Mike Casciere, displayed the different motions that determine the capabilities of the shoulder and arm.

Mike also expressed interest in a device that would track a patient's range and smoothness of motion. He explained that a therapist's attention is largely focussed on the joint or muscle needing therapy, and he cannot always tell if his patient is slowing down, speeding up, making smooth motions, or moving the same distances each time.

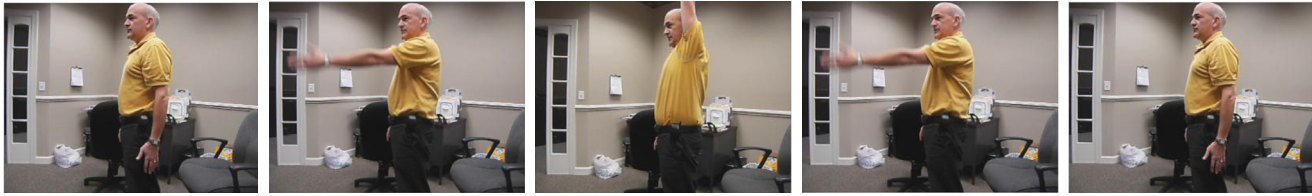

Flexion: raising and lowering of the arm in front of the body

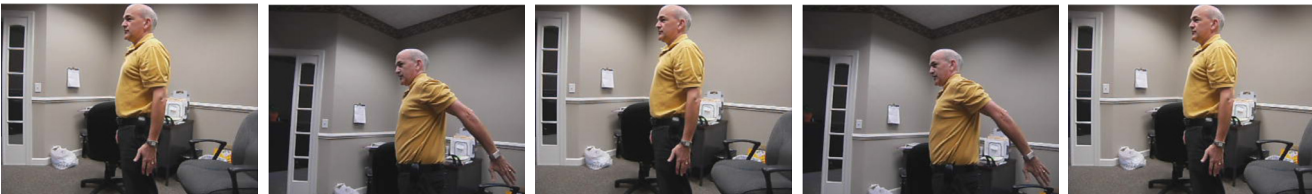

Extension: moving the arm in the reverse direction



Abduction/Adduction: side motion of arm away from and to the body

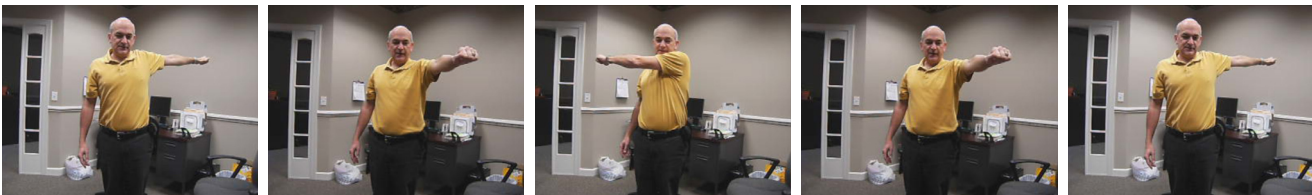

Horizontal Abduction/Adduction: moving the arm side to side parallel with the ground



Internal/External Rotation: side to side rotation at the elbow

The fitness instructor, Jocy Grahm, allowed herself to be recorded while teaching an aerobics class for older (50+) clients. She liked to focus on simultaneous arm and leg motion to improve coordination as well as fast paced movement to improve reaction time. Jocy explained that a person's reaction time will slow with age, but practicing will keep one's reaction from slowing too much. Many of the coordination exercises involved throwing the arm out or side to side while having the legs step forward or overlapping side to side. The arm motions, combined with the leg movement, throw the body's momentum in different directions. This forces the body to brace itself to keep from falling which strengthens a client's core.

Each of these professionals indicated an interest in a device that would assist them in monitoring their clients' progress. These expressed interests led to the idea that the Xcel Sleeve could be marketed to a variety of groups and not just the general public.

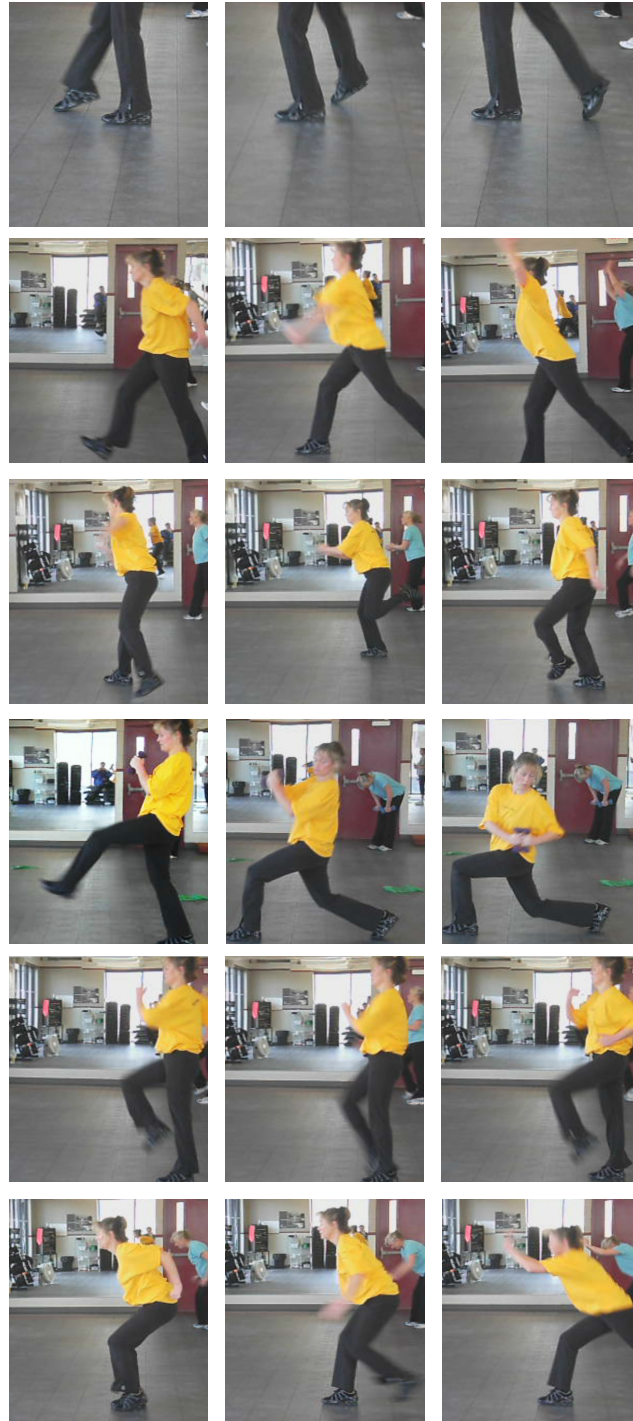

Figure 8: raising and lowering foot in a circular pattern

Front Step: throwing the hands up high while taking a large forward step

Side Step: overlapping side stepping while arms sway side to side

Rowing Lunge: forward step then pull weights back along side of body

Marching: high step marching with high coordinated arm motions

Back Step: swing arms forward while taking a large step back

Inspiration

Inspiration came from a variety of items that a person wears on the ankle and wrist. Wristwatches are worn all day by many people, a result of the service they provide as well as an image. Athletic braces give aid to users' joints, keeping them from overextending or twisting. The grey device with a digital display keeps track of blood pressure and heart rate. It has a sleek modern look to it, so a person wearing it will be less embarrassed. Armor of warriors from ancient dynasties have found their way into our modern culture in the form of protective padding. These guards give a sense of safety from injury.

However, not all the items seen here are positive. The ankle monitor, designed for alcoholics and people under house arrest, carries with it a very negative image. The device cannot resemble this, or else users will be embarrassed to use it.



Base Technology

Originally this project began with the intention of designing a walker that could meet all the needs of its users. However, that idea was changed. Instead of looking at what the problem was, focus was readjusted to what was causing the problem and what could be done about it.

Initial research pointed to the fact that middle aged individuals begin to slow down in their daily activity as they age; taking smaller steps, shuffling their feet, etc. The concept evolved into a product and system that would encourage people not only to walk more, but to walk correctly. This would be accomplished with a shoe insert with a small force gauge under the ball and heel of the foot. The insert would determine how a person was distributing their weight and report that data to a small hand held device.

The idea was evaluated by an expert in human mobility, Prof Thurmon Lockhart of Virginia Tech, and he suggested that the force gauge be changed to an accelerometer. With an accelerometer forces could be derived from the data, and more importantly a better analysis of body limb motion could be analyzed. The concept was changed and redesigned.

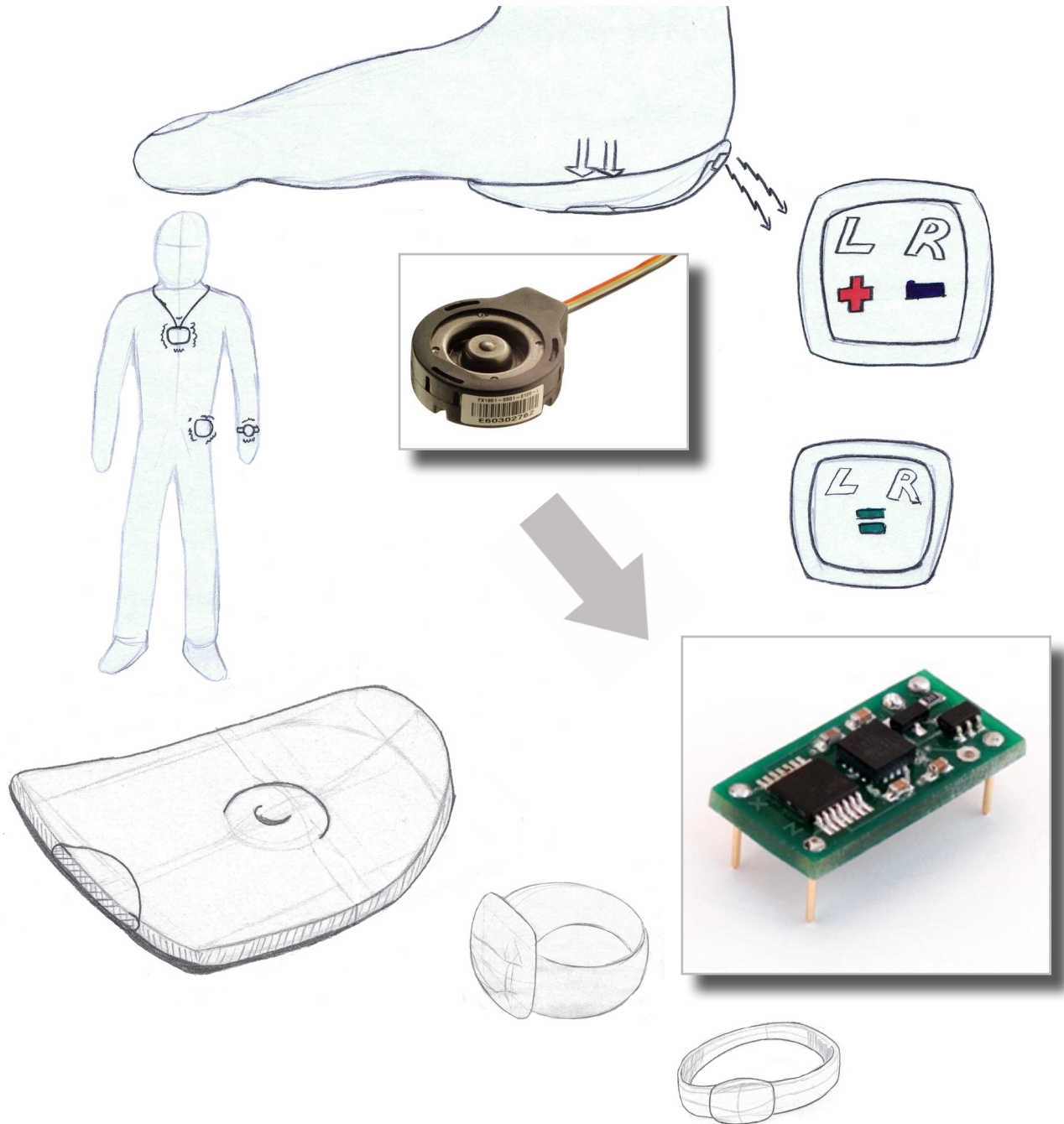

Wearing the Device

With the change in the technology, the design of the product changed as well. It would be necessary for the body of the product to hold the essential devices: an accelerometer to measure and collect data, a transceiver to send the data wirelessly, and a battery to power the setup.

The casing was assumed to be an enclosed box of some sort; water aerobics being a very popular form of rehabilitation and exercise. As for how the casing would be attached to the user, three methods were devised: direct application, strap-on, and sleeve.

The direct application method was simplistic but thought to be uncomfortable, having little blocks hanging off a user's body. This method was discouraged due to the constraints of current technology, but it was revisited for future concepts.

The strap on method would use a fabric belt to hold the case securely to the user's body. Although a simple solution, there was concern that the product would too closely resemble the ankle monitors given to alcoholics and house arrestees. Those products carry a negative image with them, and it was very possible the device would absorb that negativity.

The sleeve method was determined to be the better choice. Although multiple sizes have to be manufactured for different sized users, this method resembles athletic braces and is made from a durable and waterproof material, so the negative aspect was inconsequential.

Direct Application

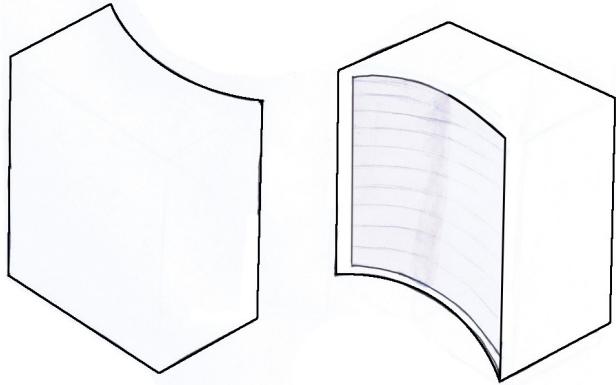

Strap-On

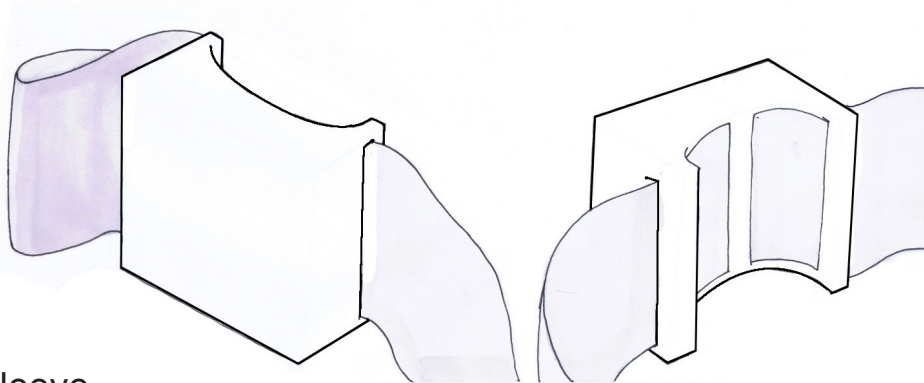

Sleeve

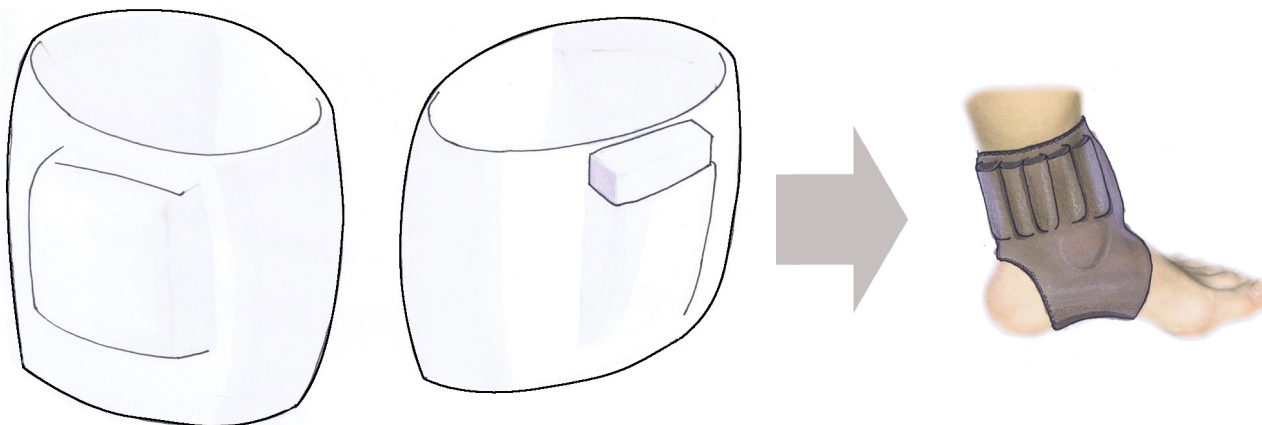

The Display

There was also the question of how the user would know whether their movement was correct or not. A person could certainly not watch the devices on their feet while in motion; he/she would either fall or run into something. It was decided that the Xcel Sleeve should communicate with some separate display device.

A few different PDA styled devices were designed, thinking that the user would wear this secondary device somewhere on their person. However, there's the issue of electronic waste. If this PDA device is made, then it will have to be updated, both in software and hardware. People may want newer models when there is nothing wrong with the model they currently have. Making another electronic device to work with the Xcel Sleeve is just environmentally irresponsible when the Sleeve could be made to work with a currently existing product.

The Xcel Sleeve communicates with a computer or smart phone, such as the Blackberry or iPhone, using a BlueTooth device. Smart phones use BlueTooth as a common communication style as well as many newer computers. If a computer does not have BlueTooth a small, inexpensive, USB device is used.

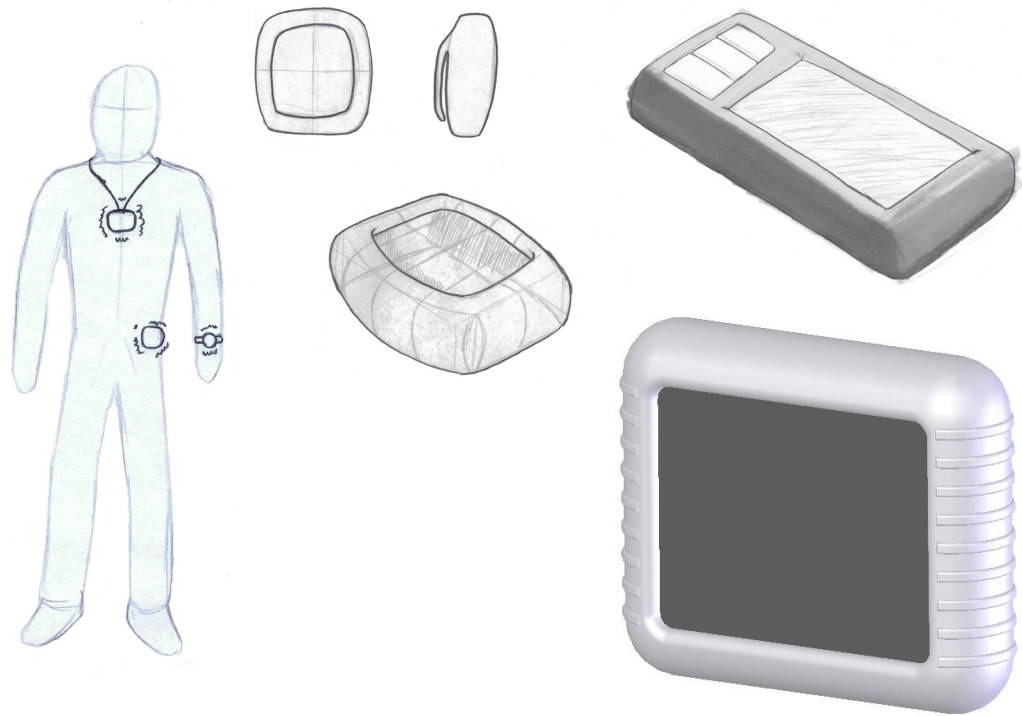

The Pod

Containment is very important. The Xcel Sleeve houses electrical components that are sensitive and certainly not cheap. Water aerobics and therapy, as previously mentioned, are important for physical rehabilitation, so first the casing has to be sealed. The Pod is a two-part case with an O-ring around the rim. This is the better method for making the product waterproof while allowing it to be accessed or disassembled at a later time.

The next step was the appearance of the pod. The Xcel Pod will contain a rechargeable battery, so the case will need to be removed from the sleeve in order to be charged. However, many accelerometers are orientation sensitive when recording data, if information was to be recorded and contrasted at different times then it is important for the user to place the case in the sleeve the same way every time.

The final draft of the case is designed asymmetrically to do just that. The end that slides first into the sleeve is angled, so only that end will fit.

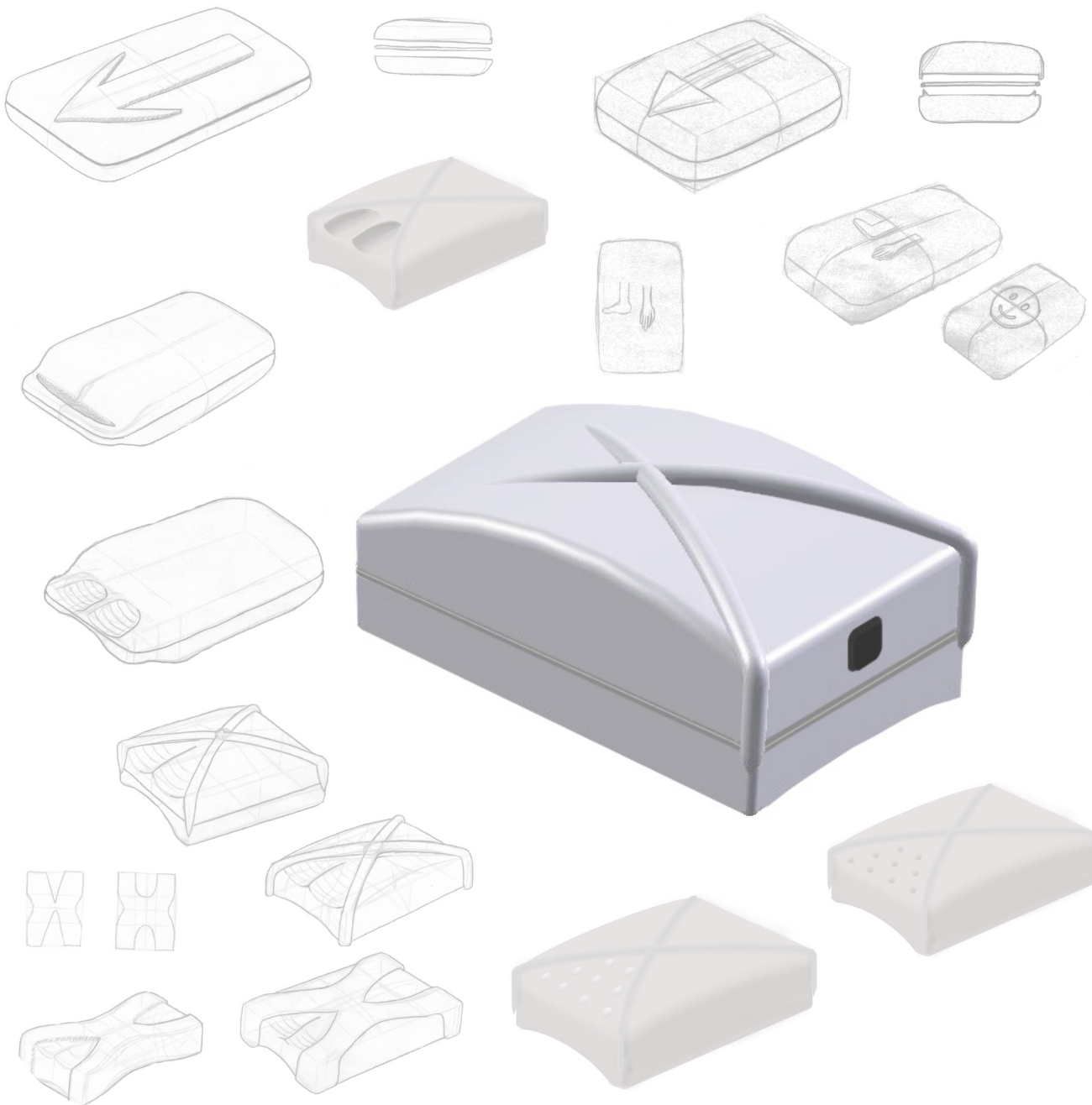

Sleeve Patterns

For the Neoprene sleeves, it's important for the user to have some variety. Solid colors, such as black or white, are fine for standard sports braces and supports, but the Xcel Sleeve needs its look to convey some positive image. The first pattern resembles the Samurai armor in an effort to express strength and to help the user feel they are protecting themselves from falling. The second pattern is that of woven blades. In shades of green or red it has a natural look it that users would find appealing. The third pattern is modeled after modern athletic shirt designs. Its two simple streaks, connected to a fading band, give an sporty look that will appeal to a different set of users.

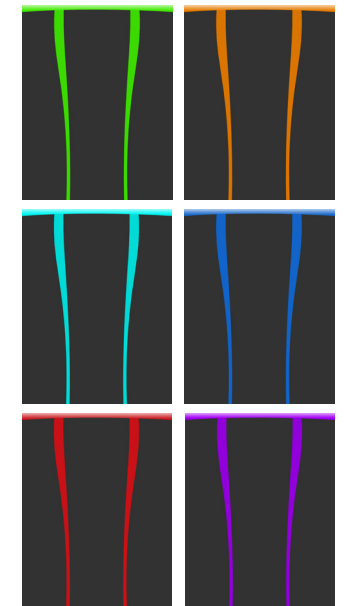
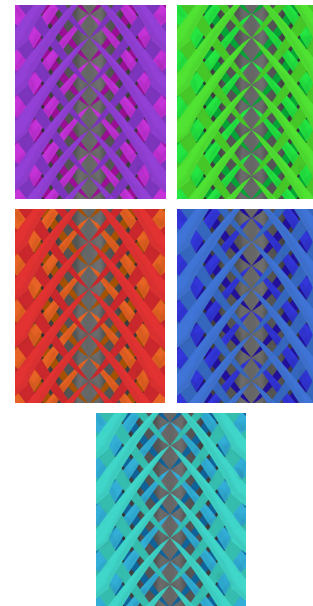
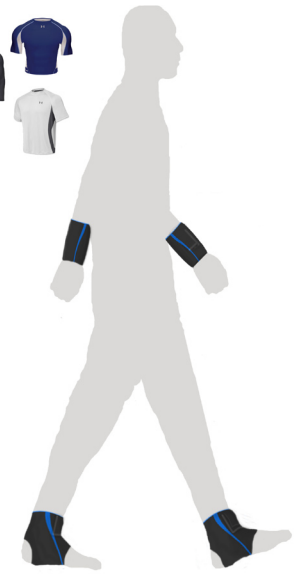
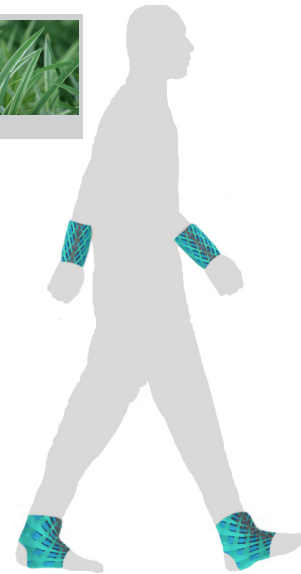
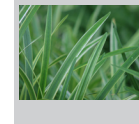
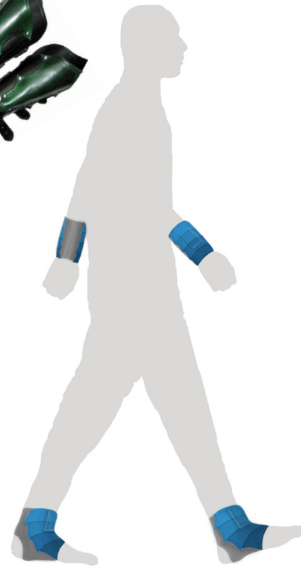

The Xcel Sleeve

The Xcel Sleeve includes the pod, the neoprene/nylon sleeves, and the Xcel software. The sleeve's material is a mix of neoprene and nylon, the standard material of most athletic braces. They are form fitting and snug, so the pod will only move when the user moves. The pod slips into a pocket at top end of the sleeve.

Without the Xcel Software, the device would be useless. This software is downloaded onto a user's smart phone via the web or uploaded onto a computer with a CD. The software contains programs that link the Xcel Sleeve to the computer/smart phone, display data in real-time, and catalog the data so comparisons can be made and progress monitored. Not only does the software give visual confirmation on a monitor, but it also gives audio alerts and suggestions should the user not be able to constantly look at a screen.

Since accelerometers only measure acceleration, the software uses calculus to integrate the acceleration data points into quantities of speed and distance. Also included in the software are variety of exercise regimes. Each regime is meant to target certain parts of the user which the Xcel Sleeve can monitor. With this visual display and the audio assistance, the user will perform the exercises correctly with little chance of personal injury.

Note: The software interfaces, as seen in this book, are mock displays; meant only to convey an idea of how the user might see the data from the accelerometer.



Last is the pod. The Xcel Pod's shape is based on user interaction, the technology used, and some aesthetic choices as well. The walls are angled, making one end thicker than the other. The thicker end is easier for the user to grab, and the pod can only fit one way into the sleeve's pocket. The pod has to be removable from the sleeve for sanitary purposes. Neoprene is waterproof not mold proof, so the sleeve needs to be able to be washed and not with the electronic device still in it. The bottom of the pod is curved so as to fit the contour of a user's arm or leg. On the back of the pod is the charge port. The pod will not function unless the plug is all the way in, acting as a safety feature. Last is the X on the top cover. This is a decorative choice meant to link the name "Xcel" to the product itself.

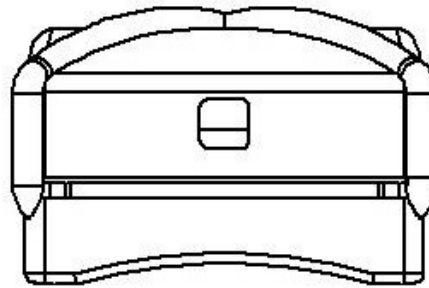

Front

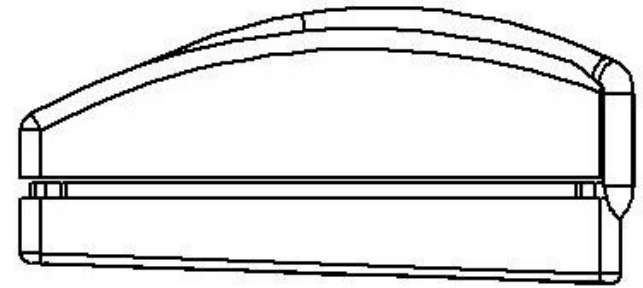

Side

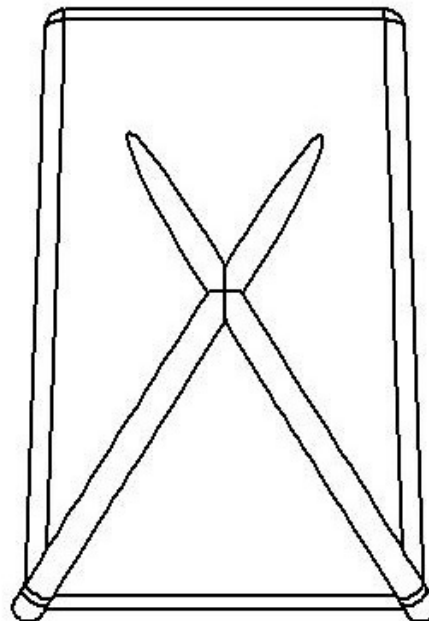

Top

Rubber plug covers charge port

Body angles in signifying front and back

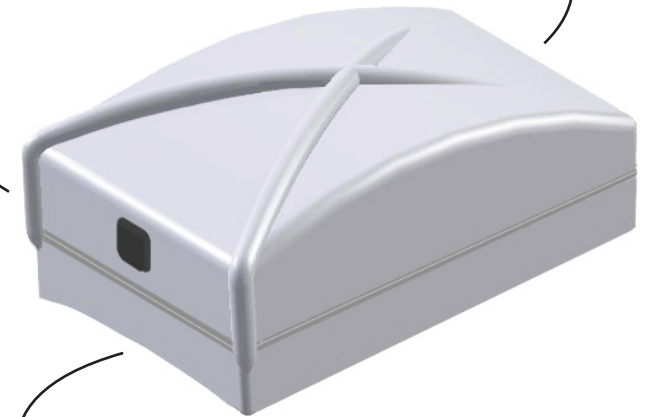

Curved backside fits body contour

How It Works

Inside the Xcel Pod are three main electronic components: an accelerometer, a battery, and a transceiver. Each device plays an important role in the function of the Xcel Sleeve.

The accelerometer, a tri-axis device, measures acceleration. It takes data points at set time intervals and sends that data to a recording program. The more accurate the data, the smaller the time intervals, but this requires more power consumption.

The lithium battery is the better choice to supply power because of its excellent in-use run time. It supplies power to both the accelerometer and transceiver.

The transceiver takes each data point from the accelerometer and transmits it to a receiving device: a computer or smart phone. It is on the third party device that the data is stored, not the Xcel Sleeve itself.

Keeping everything in place is a custom cut block of cellulose. This material plays a very important roll in keeping all the electronic parts from moving around. If the accelerometer is jostled in any way, the data it takes will be inaccurate.

The last parts that help to keep everything together and waterproof are the O-ring and fasteners. The O-ring provides a seal around the circumference of the Xcel Pod. The fasteners, coated with Teflon sealing tape, hold the top and bottom case together and keep water from entering the screw holes. The screws also have a custom head to prevent a user from opening and tampering with the components.

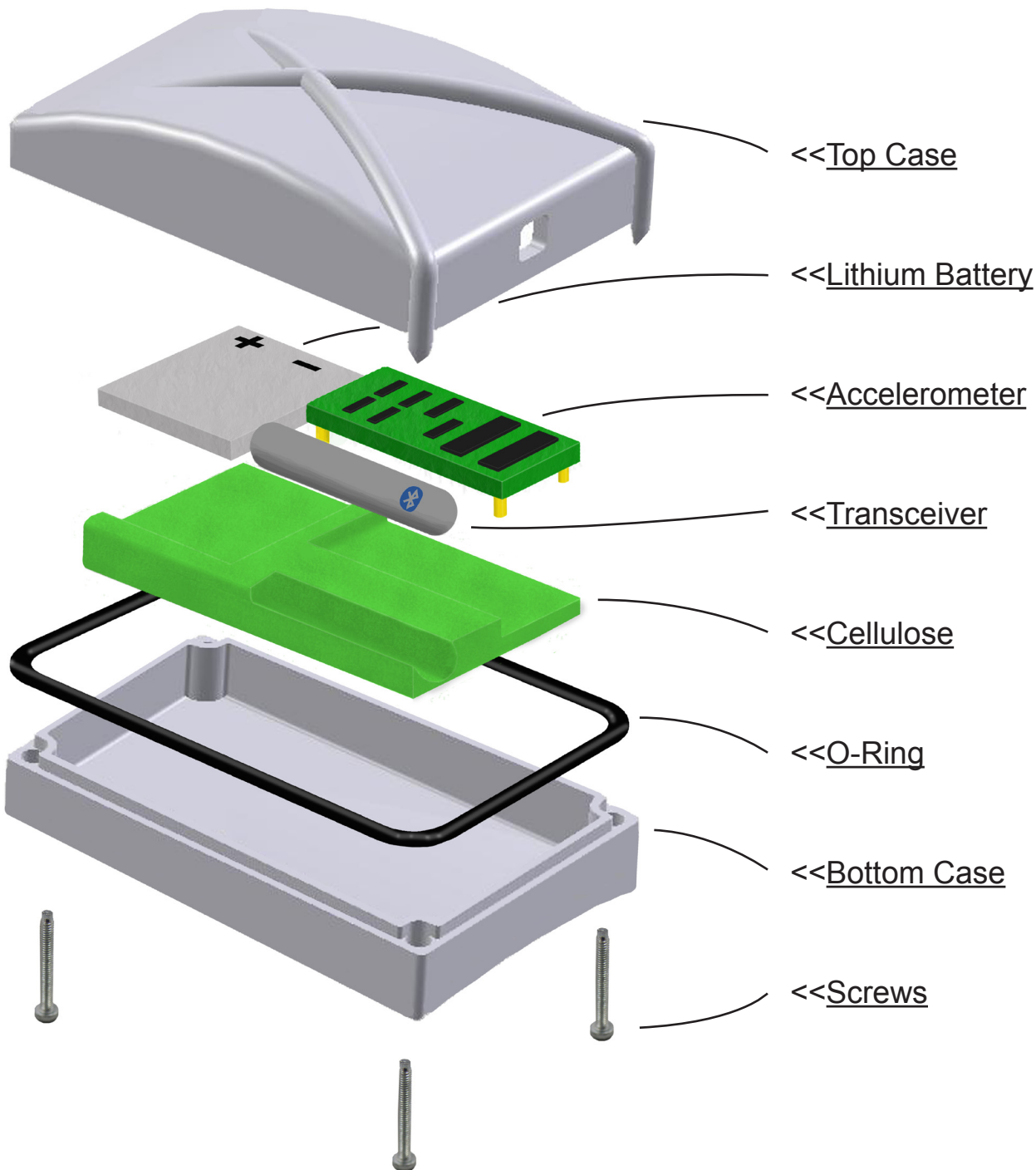

How It's Made

Each part of the Xcel Sleeve was chosen for its physical properties as well as the way they are manufactured. The accelerometer is very small and measures on three axes, so it consolidates the alternative method of placing multiple accelerometers in different orientations. The transceiver uses BlueTooth technology. The transceivers are very small and the BlueTooth communication technology is easily adopted by smart phones and most computers. The electronic parts are the most expensive pieces, so the price of the Xcel Sleeve is technology driven.

Neoprene, an elastomer made by DuPont, is a stretchy, durable material already used in athletic braces. It is water resistant and can have different designs printed on its surface. The casing is made from injection molded polypropylene (pp). PP is an easily recycled thermoplastic which can be molded in multiple ways. In the case of the Xcel Sleeve, the case is created by injection molding. PP can be made in a variety of densities from a squeezable soda bottle to a hard gun case.

Last is the cellulose block. Cellulose is a biodegradable material made from bamboo. The case of the Xcel Sleeve has no place settings or indents molded in it for the components. Since technology is constantly changing both in performance and more importantly size and shape, it made more ecological and economic sense to make the cellulose block have all the slots put in it. Should something change, only a cut pattern on a mill needs to be replaced rather than a tooling mold.



Neoprene
\$4.00 / sleeve
durable
common use



Polypropylene
\$0.50 / case
injection molded
used in cases



Cellulose
\$0.01 / block
biodegradable
made from bamboo

3-axis Accelerometer
\$30.00 / chip
small
accurate

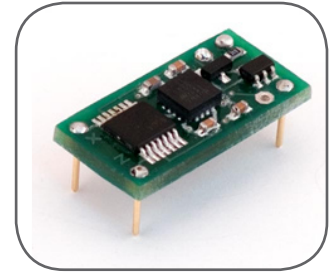

BT Transceiver
\$15.00 / chip
small
common

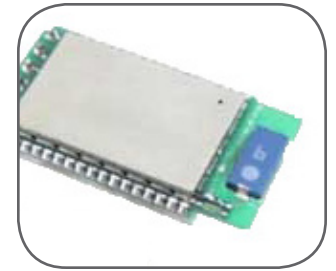

Lithium Battery
\$10.00 / battery
rechargeable
good in-use run time



Production Cost Per Sleeve: **\$59.50**

How It's Used

1



2



3

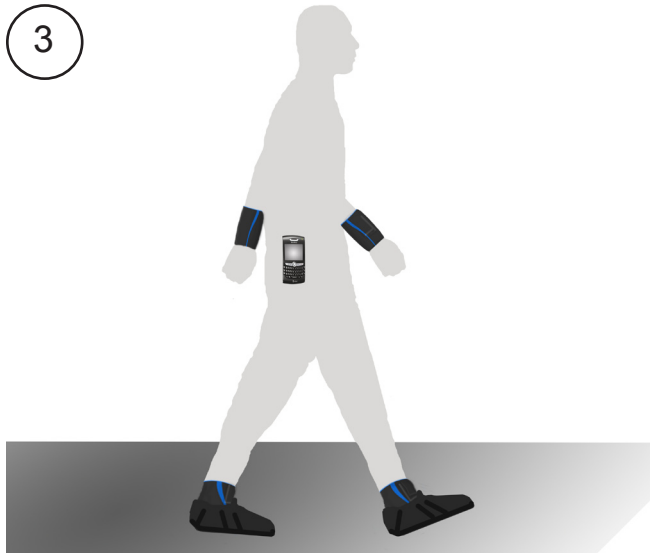

4



In this scenario, a user has purchased the Xcel Sleeve 4-Pack, containing two leg sleeves and two arm sleeves. Other package sizes would be available from a 2-pack of the same, a 2-pack with one of each, and the single Sleeve pack.

The user begins by putting on the Xcel Sleeves with the charged pods in the pouches (1). After the charge plugs are closed, the sleeves will activate when moved. Next, the smart phone application is run, a program is selected, and the user zeros the accelerometers while standing (2). Zeroing the accelerometers is a necessary step since they will not always be active and therefore not always know their new position.

Now the user begins the workout (3). In this case the user has chosen a walking exercise, where the Xcel Sleeves will monitor the feet (speed, motion, placement) and arms (swing rate, swing range, hand/foot coordination).

Upon completing the workout, stats are viewed and the data can be uploaded to a computer to compare with previous workouts (4). This visual confirmation assures the user of his/her progress.

Expanded Markets

The capabilities of the Xcel Sleeve give it purpose in markets other than the general public. These markets include physical therapist offices, fitness centers, and athletics.

Therapy

In the physical therapist office, a therapist is very hands on with the patient. Much of his/her attention is focussed on the patient's joint, and he/she is not always able to observe the patient's motions. Is the limb moving in a fluid motion? Is the limb traveling the same distance on each repetition?

With the Xcel Sleeve, the therapist can quickly glance at a monitor and determine if the patient is doing the movements correctly and consistently. The patient can also use the monitor as a guide, seeing if he/she is deviating from the specified motion.

The display and data printout serves a psychological purpose for the patient. Physical therapy can be a long and arduous process, sometimes a patient will feel like he/she is making little to no progress and will become apathetic to the therapy routines. The Xcel Sleeve will show those improvements, even if the increased motion range is a few millimeters more than the previous session.

Users

Primary: Patients

Secondary: Therapists

In America

4000 Hospitals

5000 Therapist Offices

Needs

Consistency

Range of Motion

Smoothness of Motion



Expanded Markets

Fitness

At a fitness center where aerobics style classes are taught, an instructor typically performs the exercises along with his/her clients. Most of the time the instructor is facing away from them. The sessions are fast paced, and the instructor cannot focus on each member of the class at the same time. This can be problematic since the instructor wants the clients motions to be consistent and coordinated.

With the Xcel Sleeve, an instructor would work with a smaller group of members since the individual displays would take up a lot of space. The visual aid displays which exercise or routine is being performed, and it can be calibrated to whatever speed music the instructor is using.

To better assist the instructor in helping his/her clients, the monitor has a list of the clients in the class. If one of the clients begins to fall behind or have trouble in some way, the display will point out to the instructor who it is. Just like the therapy market, the data compilation will show both instructor and client to view their progress.

<u>Users</u>	<u>In America</u>	<u>Needs</u>
Primary: Gym Members	30,000 Fitness Centers	Consistency
Secondary: Instructors		Coordination



Expanded Markets

Athletics

The potential market of athletics is quite extensive. This market includes sports franchises, college sports teams, and many more competitive sport activities. In athletics the main focus is on form and consistency, but there are few ways to verify them. The standard practice in observing an athlete is to record him/her and then analyze the video. To be more accurate, more recordings at different angles are required. The Xcel Sleeve would eliminate the need for extra videos and would provide both the coach and athlete with a 3-D data analysis to determine the athlete's consistency in his/her form.

Users

Primary: Athletes

Secondary: Coaches

In America

4000 Sports Franchises

2600 Colleges

Needs

Consistency

Form Analysis

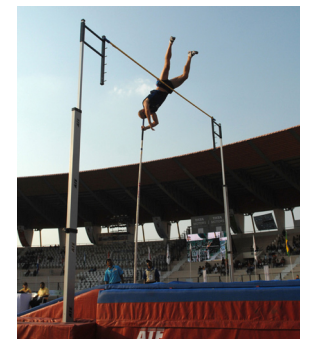

Future Concept

Technology is constantly changing. Every so many years devices are cheaper, smaller, and more efficient than they used to be. It is with this thought in mind that this concept of the Xcel system was devised.

The accelerometer laying on the quarter has not been adjusted. This is a 3-axis device, but it was not used because its capabilities were less than that of the larger one. The possibility still remains that some day that smaller accelerometer will be just as efficient and capable, if not more, as its larger counterpart. This improvement in technology would give birth to the Xcel Patch.

Inside the patch would be an accelerometer and a transceiver of some kind (BlueTooth might not always be the best). No battery would be required because the patch would be powered by the user's body. A user could wear these devices at key locations on his/her body, and keep themselves monitored through the course of an entire day.

There is much potential for a device like the Xcel Sleeve. Besides new market applications, additional features could be added such as blood pressure and heart rate monitoring. The important feature of the Xcel device that will never change is its goal to keep its users strong and balanced.

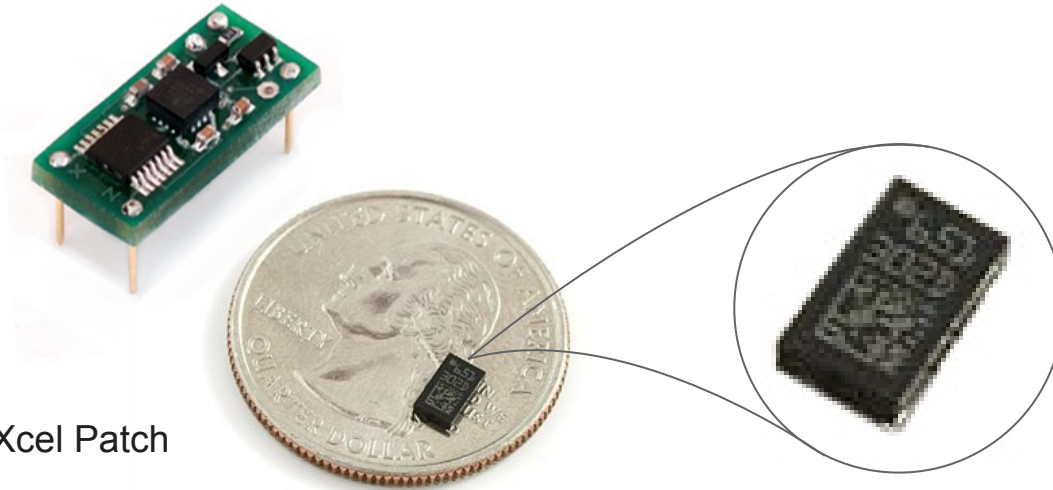

The Xcel Patch

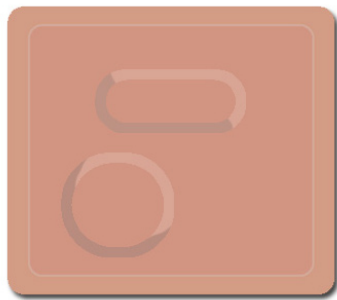

Transceiver

Accelerometer

Human Powered

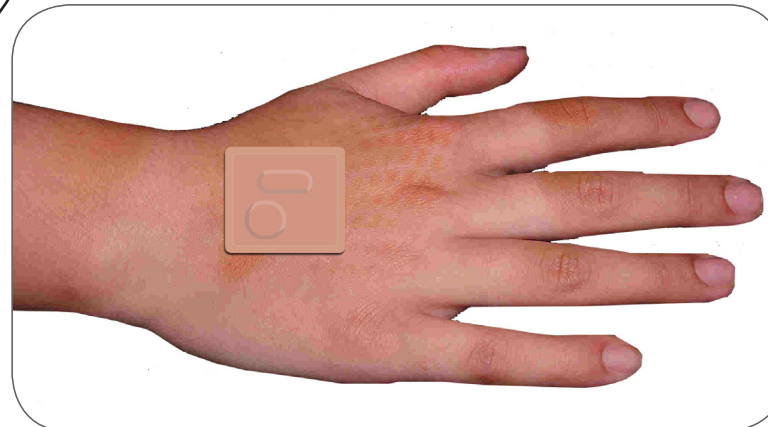

Work Cited

Appendix A: Bibliography

Center for Disease Control, (2008) "Falls Among Older Adults: An Overview." Retrieved October, 2008.
<http://www.cdc.gov/HomeandRecreationalSafety/Falls/adultfalls.html>

Mayo Clinic, (2008) "Fall Prevention: 6 Ways To Reduce Your Falling Risk." Retrieved October 2008.
<http://www.mayoclinic.com/health/fall-prevention/HQ00657>

United States Bureau of Census, (2006) statistical abstracts of businesses and schools. Retrieved January 2009.
<http://www.census.gov/main/www/srchttool.html> (keywords: schools, sports, hospitals, physical therapy, fitness)

Lockhart, Thurmon. "Dynamic Stability Differences in Fall-Prone and Healthy Adults."
Journal of Electromyography and Kinesiology. Volume 18, Number 2, April 2008.

Appendix B: Video Recordings

Mike Casciere, Physical Therapist, CAWH Physical Therapy
Blacksburg, VA. February 2009.

Jocy Surface, Assistant Manager, New Tech Fitness
Blacksburg, VA. March 2009.

Appendix C: Interviews

Therapist Questions

Name: Suzie Skinner

Company: CAWH Physical Therapy

Position: Physical Therapist, staff

Years Practicing: 9 years

Divide among 100% the importance of the following sections for balance:

Ankle	-	1
Knee	-	2
Hip	-	3
Back	-	5
Arms	-	4

What are some of the causes of falls with the elderly?

Vestibular (inner ear), sensory (nerve), vision.

Vision is a big one, cataracts ect..

Nerve degredation, can't feel what they are walking on. Slipping on floor transitions, and throw rugs.

Fear of falling reduces activity, causing muscle decrease, causing more chance of falling.

What percentage of your elderly patients are due to falls, slips, ect?

33% from falls

66% for fear of an eventual fall

Is the loss of balance a result of muscle atrophy, or is there more to it?

Vision, nervous system (less coordination)

What percentage of balance issues is purely physical and what are neurological?

Muscle loss is inevitable with age. (google muscle atrophy with age)

What exercises do you do to help encourage muscle growth?

Functional exercises: standup/sitdown, lunges, leg lifts, pumping ankles, sitting and marching, arm lifts. Exercises are done on uneven surfaces when they are in a safe environment.

Are you aware of any products for the elderly on the market?

Crutch canes, platform walkers (an accessory for standard frame walker)

Will improperly using equipment cause further injury?

Using walker too far out causing too much forward momentum.

Tripping over crutches.

Rocking the quad cane, reducing the balance it gives.

See height too low more than too high.

What is the educational process on how to use the equipment?

The people selling the product should be educating the users, but sometimes doesn't happen when purchased online or at a retail pharmacy.

Would it be possible/advisable to shift a person's center of gravity for better balance?

Between pelvis and belly button. Shifting COG happens auto, but can cause problems with other joints.

Are there any parts of the body one should avoid placing pressure?

Over boney areas, ankle bones, knee cap, and avoid rubbing.

Platform walker – good product, but needs to be special ordered, and in family practices might not occur to the doctor to special order it. And if patient is coming in for balance issues, patient may not think to mention their wrist problems, so doctor doesn't know anything is wrong.

AFO – ankle foot orthosis

KFO – Knee foot orthosis

More intervention before falls happen.

October 2008

Therapist Questions

Name: Anonymous

Company:

Position: Occupational Therapist

Years Practicing: 22 years

What are some of the causes of falls with the elderly?

Hip breaks then fall, reduced balance, letting themselves fall into chairs, shuffle feet, poor vision, poor grip on railing, orthostatic hypotension (drop in blood pressure), confusion, shortness of breath, inner ear, stroke, Parkinson's.

What percentage of your elderly patients are due to falls, slips, ect?

20%, she deals more with medical issues at Home Health.

Is the loss of balance a result of muscle atrophy, or is there more to it?

More common, about 75%.

I heard muscle loss with age is inevitable what can people do to prevent this?

Water aerobics, daily walks, motivation is important, just get up and move.

What exercises do you do to help encourage muscle growth?

See above

Are you aware of any products for the elderly on the market?

Walking sticks,

Will improperly using equipment cause further injury?

Walkers too far out in front.

What is the educational process on how to use the equipment?

Would it be possible/advisable to shift a person's center of gravity for better balance?

October 2008

Fitness Questions

Name: Joey Surface
Company: New Tech Fitness
Position: Assistant Manager
Years Practicing: 10 years as health fitness instructor for seniors

Keeping active is the most important thing to do for yourself.

Feeling tired is not an excuse of age. 20 days in bed is = 1 year of inactive lifestyle. Takes one year to get back to where you were.

Walking is important but it must be done right, must be motivated, and must have variety.

- Add a training setting

Backwards walking is important for balance.

Fast twitch muscles and slow twitch muscles. With age and because of fear of falling, fast twitch become slow twitch.

Muscle awareness is very important, include a chart of what walks help which leg muscles.

- Backwards – back of quads

- Side oversteps – Side Quads

- Reg Walking – front quads

Legs are not always the same length, because everything is not symmetrical.

Balance in water is important for balance training. (consider making waterproof)

Device needs to encourage them to walk.

Posture is very important.

Behind pinky, ball, and heel are triangle of balance says one article.

70% of people who fall and break hips die within a year.

December 2008

Appendix D: Pictures

Football Helmets

http://www.forbes.com/2008/09/10/nfl-team-valuations-biz-sports-nfl08_cz_kb_mo_0910nfl_land.html

Grandma w/ child

http://farm4.static.flickr.com/3275/2649997394_5549120e2b.jpg

Water Therapy

<http://www.intouchpt.com/pool.jpg>

Athletic Braces

<http://www.ankleshop.com/>

Ankle Weights

<http://www.medimart.com/Medical%20Mart%20Retail%20Website/Newimages/dailylivingimages/rehab/15W001-003,010.jpg>

Wrist Guards

<http://www.snowboardsecrets.com/images/Flex/flexmetermed.jpg>

Armor Cuffs

<http://princearmory.com/home.php?cat=9>

Samurai Armor

<http://www.bancroftnebraska.org/Samurai%20armor.jpg>

Watches

<http://www.watchismo.com/modern-watches.aspx?gclid=CNLA2PTCoJoCFQKaFQod0C7d8g>

Wrist Computer

<http://www.parvus.com/products/ProductPage.aspx?ProductID=117>

Glucose Monitor

http://www.bodymedia.com/pnt_over.asp

Ankle Monitor

<http://www.deseretnews.com/photos/midres/4817077.jpg>

Ankle Pouch

<http://www.smaggle.com/2007/10/09/chanel-accessories/>

Force Gauge

<http://www.robotshop.ca/ProductSearch.aspx?q=force+gauge>

Accelerometer

<http://www.robotshop.ca/ProductSearch.aspx?q=accelerometer>

Computer

http://img.alibaba.com/photo/11739866/Personal_Computer_Desktop.jpg

Laptop

<http://www.nimaheydarian.com/wp-content/uploads/2007/11/comapqc700.jpg>

Blackberry

<http://www.car-tel.com/images/phones/blackberry8820.jpg>

iPhone

http://www.styleguerilla.ch/wordpress/wp-content/uploads/2008/03/iphone_home.jpg

Athletic Shirts

<http://www.underarmour.com/>

Neoprene Sheets

<http://www.allproducts.com/plastic/shangyung/neoprene-fabric.jpg>

PP Cases

http://www.mtmcase-gard.com/products/handgun/images/handgun_cases.jpg

Lithium Battery

<http://www.robotshop.ca/ProductSearch.aspx?qslithium+battery>

BlueTooth Transceiver

<http://www.robotshop.ca/ProductSearch.aspx?qsluetooth>

Cellulose Block

<http://www.yogymbo.com/wp-content/uploads/2008/04/sponge-pads-cellulose-sponge.jpg>

Walkers

http://www.mobilitymegastore.co.uk/cat33_1.htm

Canes

<http://www.mobilitypeople.co.uk/index.php?cPath=44>

Hip Guards

<http://www.hiprotector.com/hipguard.html?source=google&gclid=CM6q--iVtZoCFRYpFQodQm8DcA>

Elderly Airbag

<http://news.bbc.co.uk/2/hi/asia-pacific/7635225.stm>

Leg Cast

http://farm4.static.flickr.com/3129/2390153381_0e35b6ec43_o.jpg

Appendix D: Pictures

Leg Therapy

<http://www.ct.gov/dph/cwp/view.asp?a=3143&q=388934>

Arm Therapy

http://www.southerntherapyservices.com/physicaltherapy_files/physicaltherapy.htm

Step Aerobics 1

<http://www.kelseykerridge.co.uk/upload/aerobics.JPG>

Step Aerobics 2

http://www.northlibertyiowa.org/rec/step_aerobics.jpg

Knee Aerobics

<http://ymcahattiesburg.org/IMG0062.jpg>

Trampoline

http://saddlebackgymnastics.com/images/new_imagex_e4gh.jpg

Swimming

<http://www.manitoupool.com/MPj04067770000%5B1%5D.jpg>

Pole Vault

<http://www.defenselink.mil/armedforcessports/worldgames2007/cism/images/071016-F-1798W-204.jpg>

Appendix E: Case Diagram

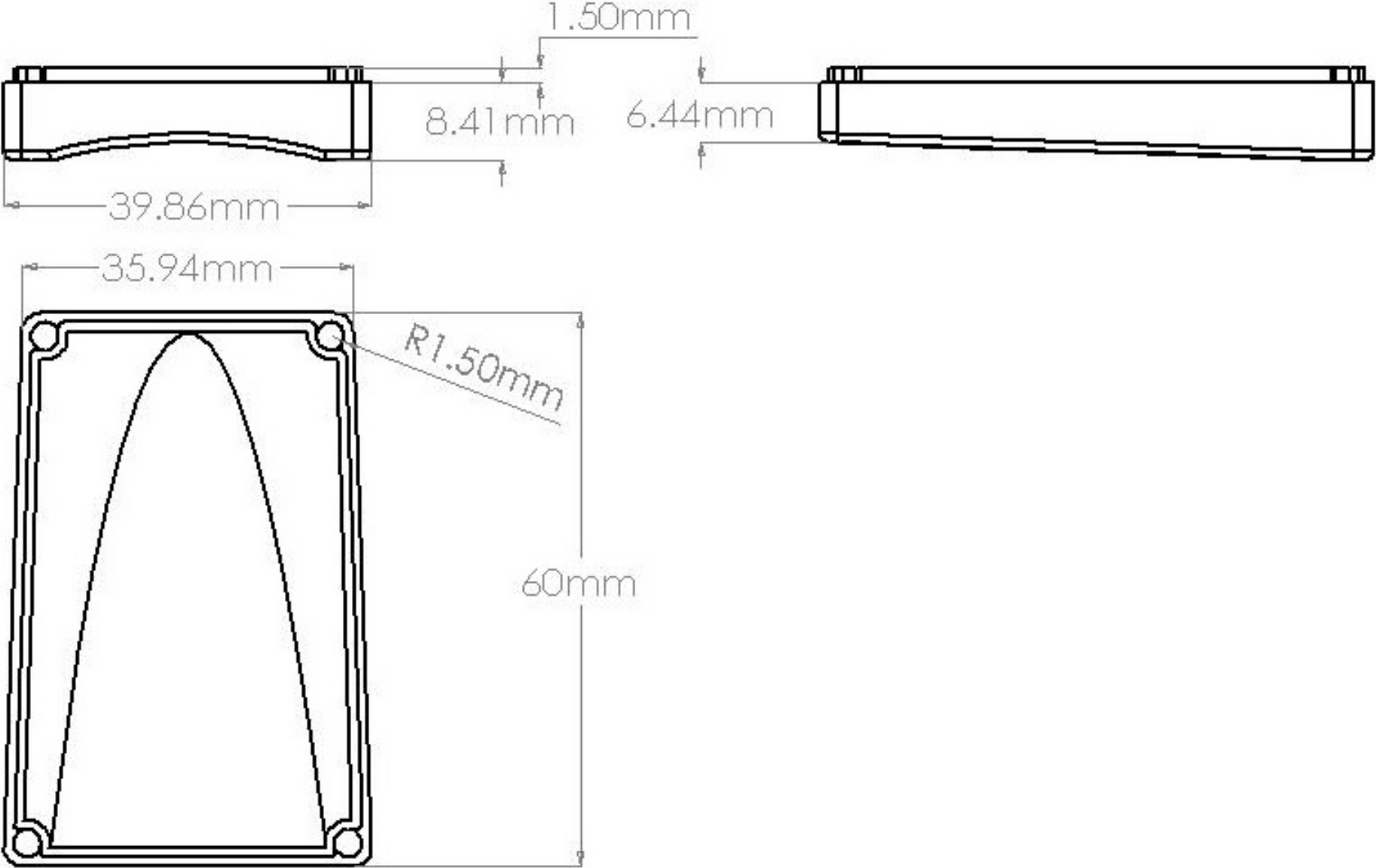

Bottom

Appendix E: Case Diagram

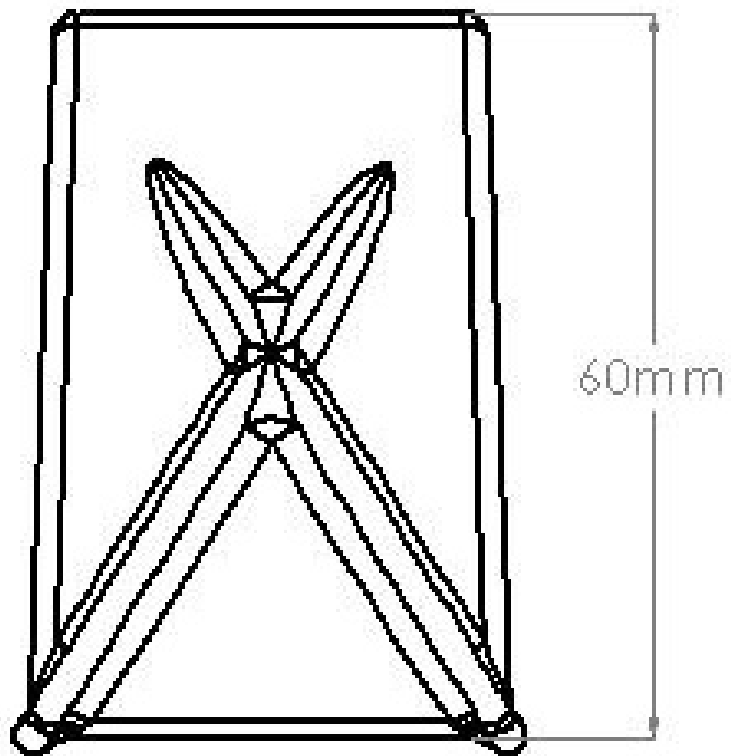
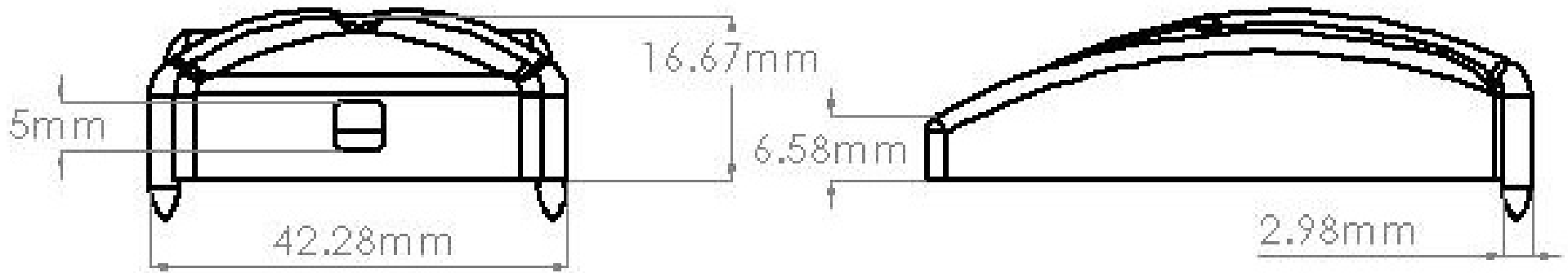

Top