

revisiting contemporary public housing solutions in historic Alexandria

Joshua Anderson Chambers

Thesis submitted to the faculty of the Washington Alexandria
Architecture Consortium, Virginia Polytechnic Institute and State
University in partial fulfillment of the degree of

Master of Architecture

Approved By:

Jaan Holt (chair)

Paul Emmons

Joseph Wheeler

November 24, 2006
Alexandria, Virginia

table of contents

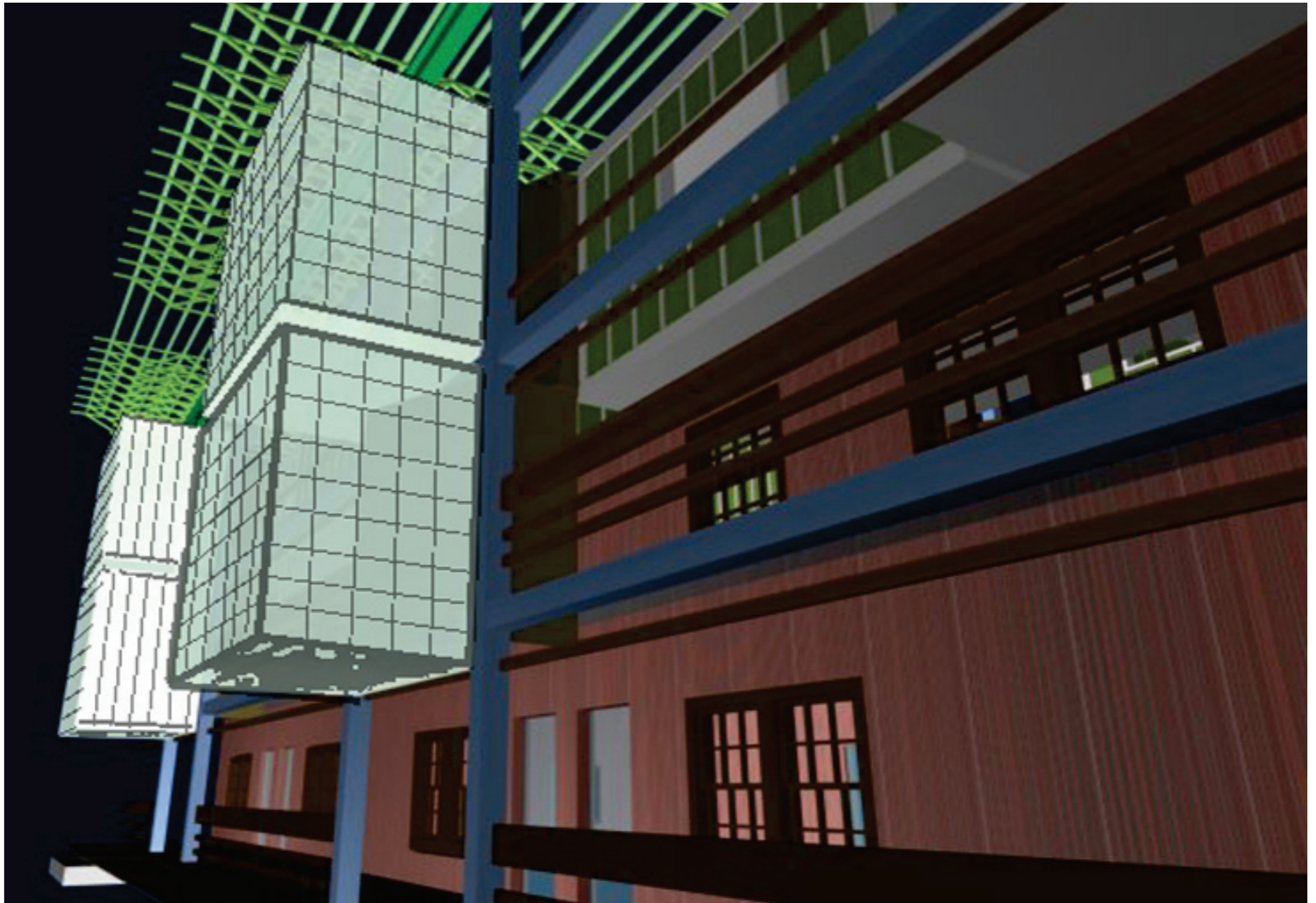

ackno	iii	
abstract	1	
intro	2	
history		4
site study	6	
phase 1	14	
phase 2	17	
phase 3	19	
site plan	20	
plan	22	
sect	24	
elev	26	
detl	28	
modl	30	

Acknowledgments

This book wouldn't be possible without the patience of so many wonderful people. Most importantly my mother and father who always believed in me, supported me, and encouraged me to finish and succeed.

Also to my friends who have been so understanding and helpful, trying to think all the time of how they could possibly help me succeed.

And finally to Jaan Holt and the staff at WAAC. You all have never questioned the feasibility of finishing this book and your casual confidence helped keep me going.

Thanks to you all.

abstract



composite photo showing existing Samuel Madden Homes next to their neocolonial replacements

The New World has always had an obsession with establishing its legitimacy through recreating previous architectural styles. Our colonial architecture imported the architecture of the Old World. The more important the building, the more grand the style. Most often our civic architecture received the most lavish attention. Washington DC became the home of the government and with that government came the most prestigious and most conservative European styles. These styles gave the new government a legitimacy and a connection to past.

Washington is becoming a museum of architecture frozen in time. With our fragile new world and shallow history we hold on to every precious building. The neighborhoods of Georgetown and Alexandria embody these ideals of historic landscapes. Regardless of how old a building may truly be, it is most important now to feel old and to fit in.

Contrast this to the architecture of Europe. True, even Europe has its various historic centers, but the majority of the landscape is a lively mix of architecture. European architects and the clients who commission them are far less intimidated by the past. They feel comfortable building a thoroughly modern edifice squeezed between a 16th century building on one side and an 18th century building on another. It is a landscape where the past is the canvas onto which contemporary builders must paint.

This thesis records the process of creating a more honest architectural timeline.

introduction



The project sits on a prime location in the north end of Old Town, an area known as “The Berg.” . It lies west of St. Asaph Street and slopes two blocks gently towards the Potomac River, bounded on the north end by Pendleton Street and by Princess Street to the south. The four blocks in question divide the boundary of high income 200 year old townhouses and 20th century light industrial and commercial zones.

In the mid-1990’s the government of Alexandria began to consider alternatives to some rather unsightly public housing located in The Berg. High real estate prices were peaking in the downtown area of Alexandria and pushing the limits of what would be considered “Old Town.” Ignoring protests by the residents who were currently living there, the city initiated development of the property into high-end luxury townhouses similar to the type found throughout Old Town. These new homes to be inevitably given the same “historical style” as the 200 year old townhouses a block away.

However historic the proposed gabled roofs and shuttered windows may appear, they have little to do with the true history of the site. The neighborhood deserved a more honest response to balance the needs of the city and the needs of its current residents. The city sought to change and make better the degraded quality of the original fifty year old public housing project. And the residents sought to stay in their homes, see them upgraded and maintained properly and to do it all with dignity and some respect for the past.

I propose continuing the line of history by respecting the history of the site and adding a contemporary solution to it, simultaneously augmenting the functionality of the buildings through prosthetic intervention. Instead of tearing down the old buildings and building new from the ground up, the goal was to insert discrete additions to the building. These additions should be low cost, built from inexpensive and rapidly installed materials, and update the functionality of the buildings for today's residents.

The thesis itself is a timeline of the process. It is not the definitive answer to the problem, but a snapshot of an evolving process - mirroring the goals of the buildings and solutions themselves. The process was divided into four phases. An initial phase of interventions tacked on to the facade. These suggested major structural alterations for relatively small changes to the overall use of the buildings. The second solution was a rethinking of the intervention aimed at minor architectural insertions designed for maximum effect. The third phase explored solutions through physical modelling and began the investigation of layering upon the skin. The final phase of the thesis added layers of architecture to the skin, roof, and a prefabricated third floor.

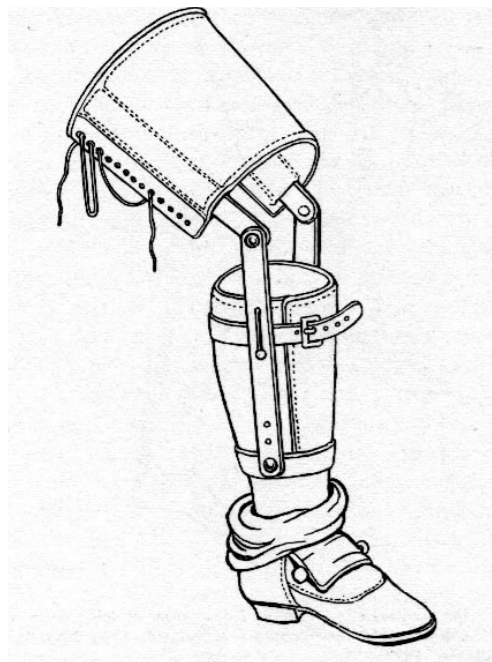

prosthetics

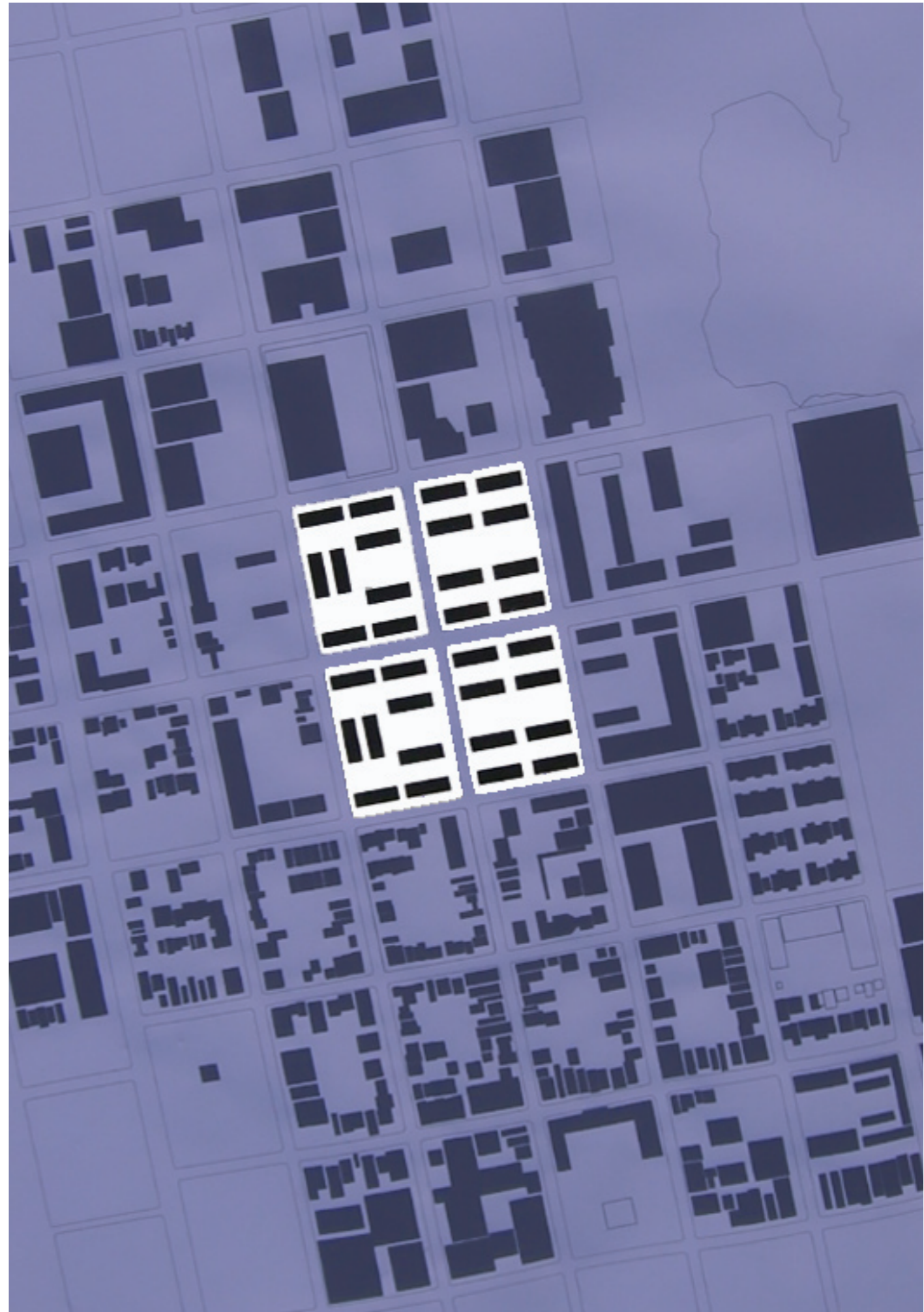
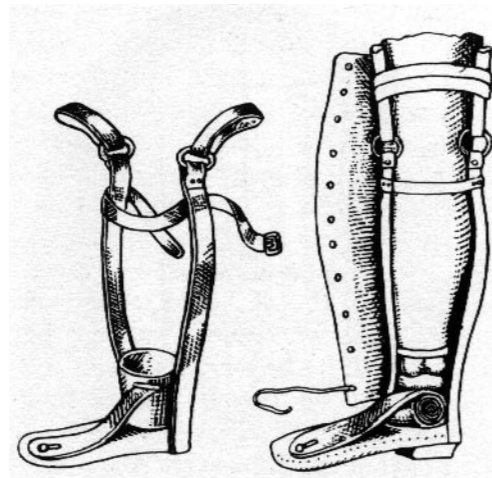

history

I began this thesis by learning more about the true history of the Berg. Everything built in Old Town is done in the shadow of history, real and imagined. The history of the Berg is in danger of being blurred because of what was being proposed by the city. The government proposed developing the area through the construction of large majestic upperclass townhomes in an historic style. This is the construction of a simulacrum - creating a history that never existed. Believing that our buildings were our most present and important links to our past, I felt that a more honest interpretation of the site was critical to informing the proposals.

The Berg is an historically marginalized zone in Alexandria. Originally the Berg was situated on the outskirts of Old Town away from the city's upperclass white neighborhoods. The area was first settled by free blacks in the late 18th and early 19th century. Alexandria was a draw for free blacks from the south as it occupied a unique situation geographically, politically and socially. Alexandria was a part of the plan of Washington and occupied a dual identity as southern town with the more progressive laws of the capital. Alexandria remained this way until it was ceded back to Virginia in 1846. During that time four distinct black neighborhoods developed in Alexandria: Uptown, Hayti, the Bottoms, and the Berg. From 1846 till the Civil War, development in these neighborhoods stabilized and even shrunk as the laws applied towards free blacks became much stricter and the Southern economy slowed.

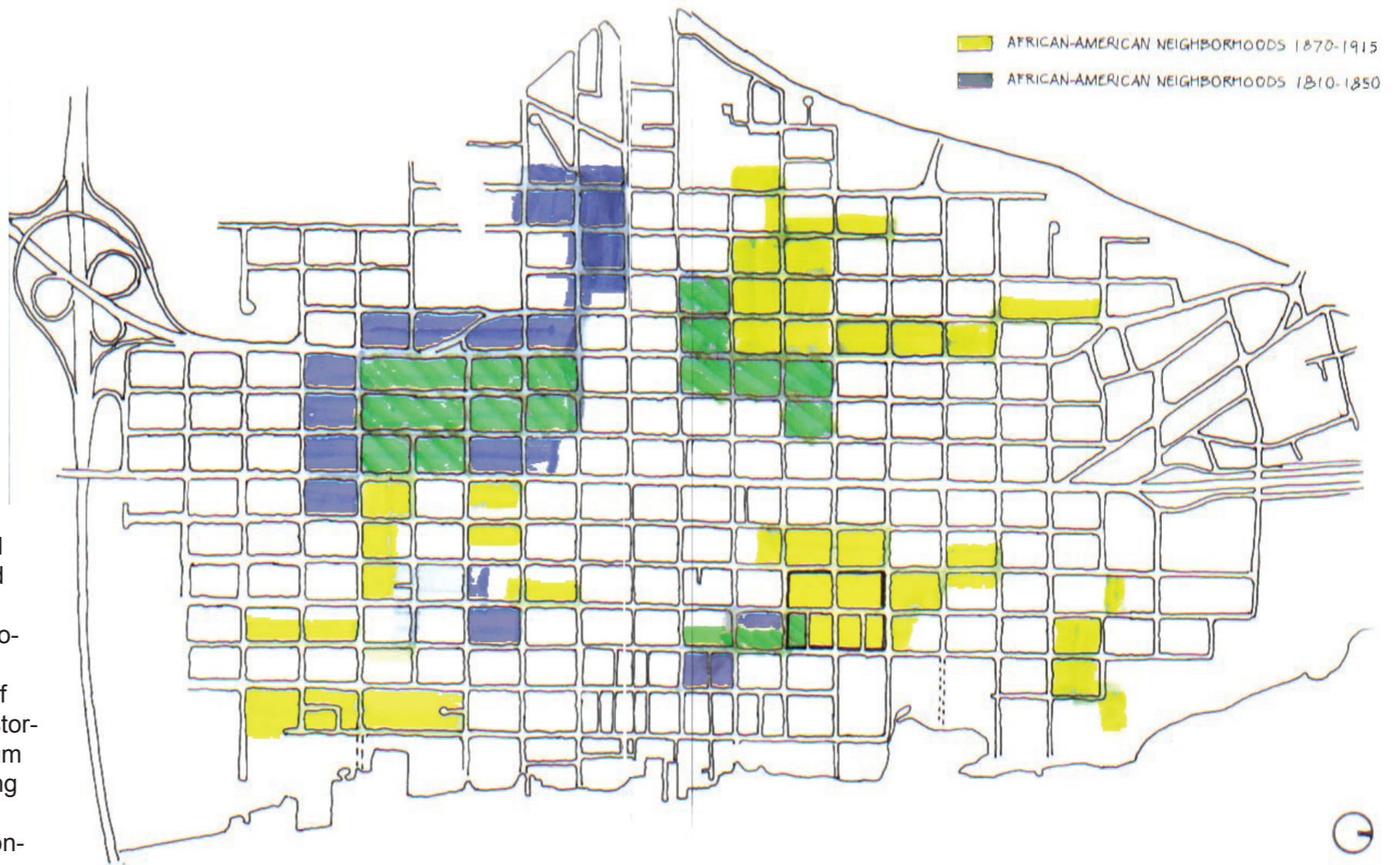

Alexandria African american neighborhood development



Alexandria's Freedom Band



original Shiloh Baptist Church

At the start of the Civil War, Alexandria was the first city that the North occupied because of its proximity to the capital and strategic hub of transportation. During the Civil War, Alexandria was the last stop in the South for many freed slaves heading north. As a busy border town controlled by the Union army, many new African-American residents settled in the area. The Berg grew quickly during this time as a node for the free black community. The area earned its name "Berg" (or "Burg") from slaves who migrated primarily from Petersburg, a town south of Alexandria. Alexandria also expanded rapidly as a train junction and military outpost for the Union army heading south. The development boundaries of the city expanded north and west during this time to accommodate the growth and the Berg firmly established itself as a low income community, now incorporating free slaves as well as poor whites heading north. The city also continued a rail line through the area and new light industrial companies set up shop. Many of them set up on the north end of Old Town near the Berg. And the area also saw the establishment of the city jail on the southeast corner of Princess and Pitt Streets. As a result conditions in the Berg became less desirable as the smells and sounds from these expanded industries entered the area.

After the war the army left and some of the industry shrank, but many of the residents stayed. The communities were still anchored by the churches. The Berg in 1891 saw the establishment of Alexandria's first black public school. With the establishment of that school for the newly emancipated African Americans, their community began to lay down permanent and now educated roots. For the next half a century, Alexandria's population grew slowly and steadily.

With the advent of the first World War, Alexandria felt once again growth as a military town. With its excellent railroad connections and quiet role as a port coupled with its proximity to Washington DC, Alexandria began another small industrial boom. The torpedo factory was built at the foot of King Street and shipyards and tank factories sprang up around the old Ford Plant at the end of Union Street. All these military assembly factories required workers and soldiers and with these new residents came a growing need for housing. The area known as the Berg was considered a prime site for developing this war housing as it was mostly filled with ramshackle wood frame housing.



family picnic at the Samuel Madden playground

The land was leased of the federal government who then built the current constructions as military housing. The plans were generic and used in many sites around the country. The design followed in the proud American tradition of pastoral homes in green pastures and was mostly out of context for their Alexandria environment. While they did in fact share some of the architectural language of the townhouses around them, namely brick walls, pitched roofs, and wood framed double hung windows, they were also not in the urban context, language or quality of the older historic townhouses located throughout the city. Chief among those differences; the blocks had large grassy courtyards in the middle of them instead of the private yards and alleys found elsewhere in Old Town. Also the entrances to the homes were set back from the street instead of meeting the sidewalk directly. After the end of the second World War the homes were decommissioned as war housing and became federally funded public housing. The site, the buildings, and the use remained relatively unchanged for the next half century and are currently being considered for demolition.

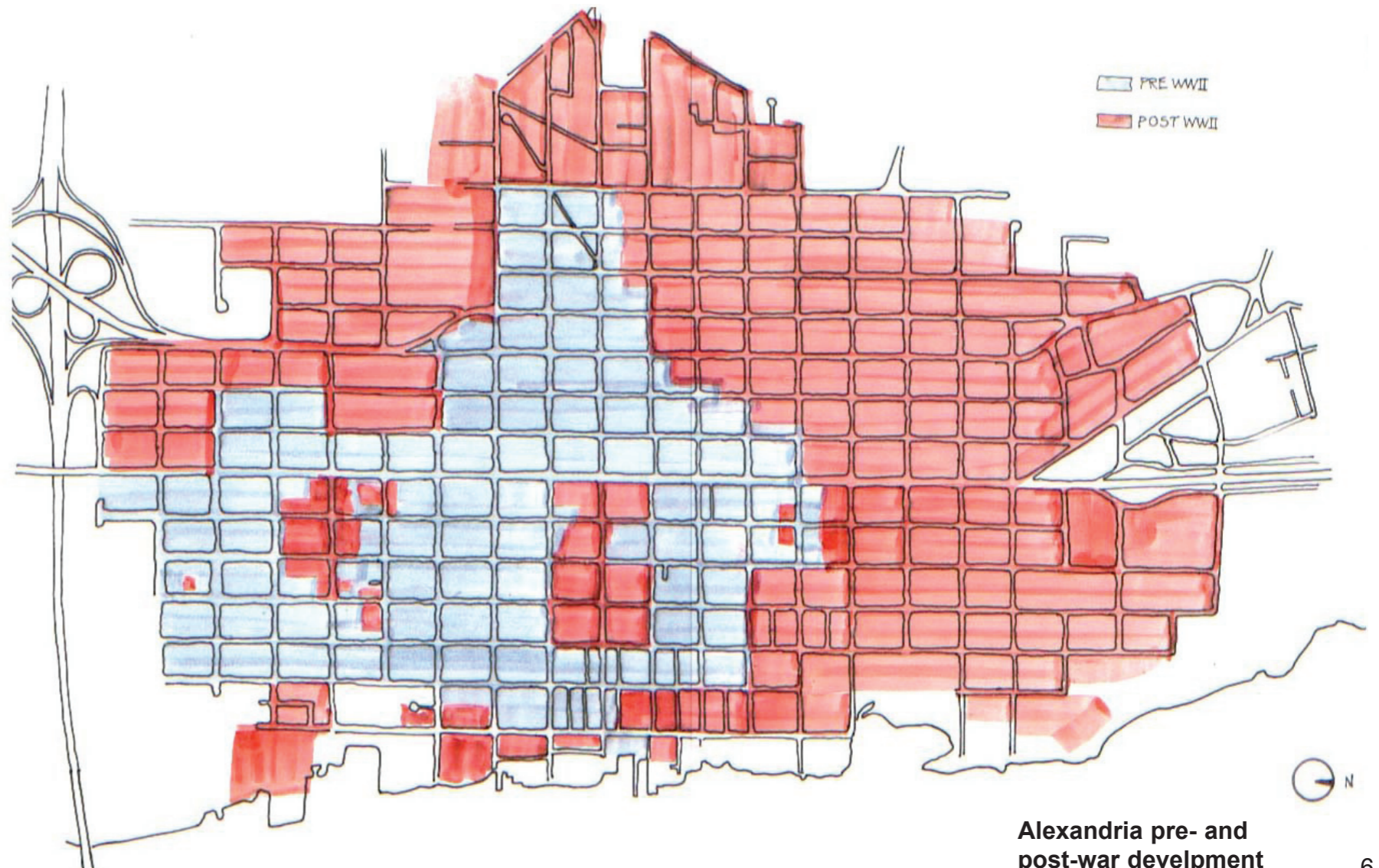

Alexandria pre- and post-war development

site studies



After studying the history of the site, it was important to examine the site itself. The topography of the Berg is a four square block area gently sloping from the higher street of North Pitt two blocks east towards the Potomac River, bounded on the north end by Pendleton Street and by Princess Street to the south. The four blocks in question divide the boundary of high income 200 year old townhouses and 20th century light industrial and commercial zones.

aerial view

Currently on the blocks surrounding The Berg the land use is changing rapidly. Many of the light industrial and commercial buildings are being converted into residential. On the south the houses are mostly two to three story historic townhomes. To the north, the buildings move quickly into taller structures, with four story office buildings quickly giving way to high rise twelve story apartment towers. To the west there is a mix of very traditionally styled homes with some being converted into loft style residences. Public transportation is provided primarily by city bus lines and a metro stop nine blocks to the west.

As mentioned before the homes are now 2 story, clustered townhouses. They in fact share some of the architectural language of the townhouses around them, namely brick walls, pitched roofs, and wood framed double hung windows, they are not in the language or quality of the older historic townhouses located throughout the city. Chief among those differences; the blocks had large grassy courtyards in the middle of them instead of the private yards and alleys found elsewhere and the entrances to the homes were set back from the street instead of meeting the sidewalk directly. While this design is in the spirit of American freedom, epitomized by the suburban form*, it is clearly outside the typology and urban plan of the rest of Old Town.

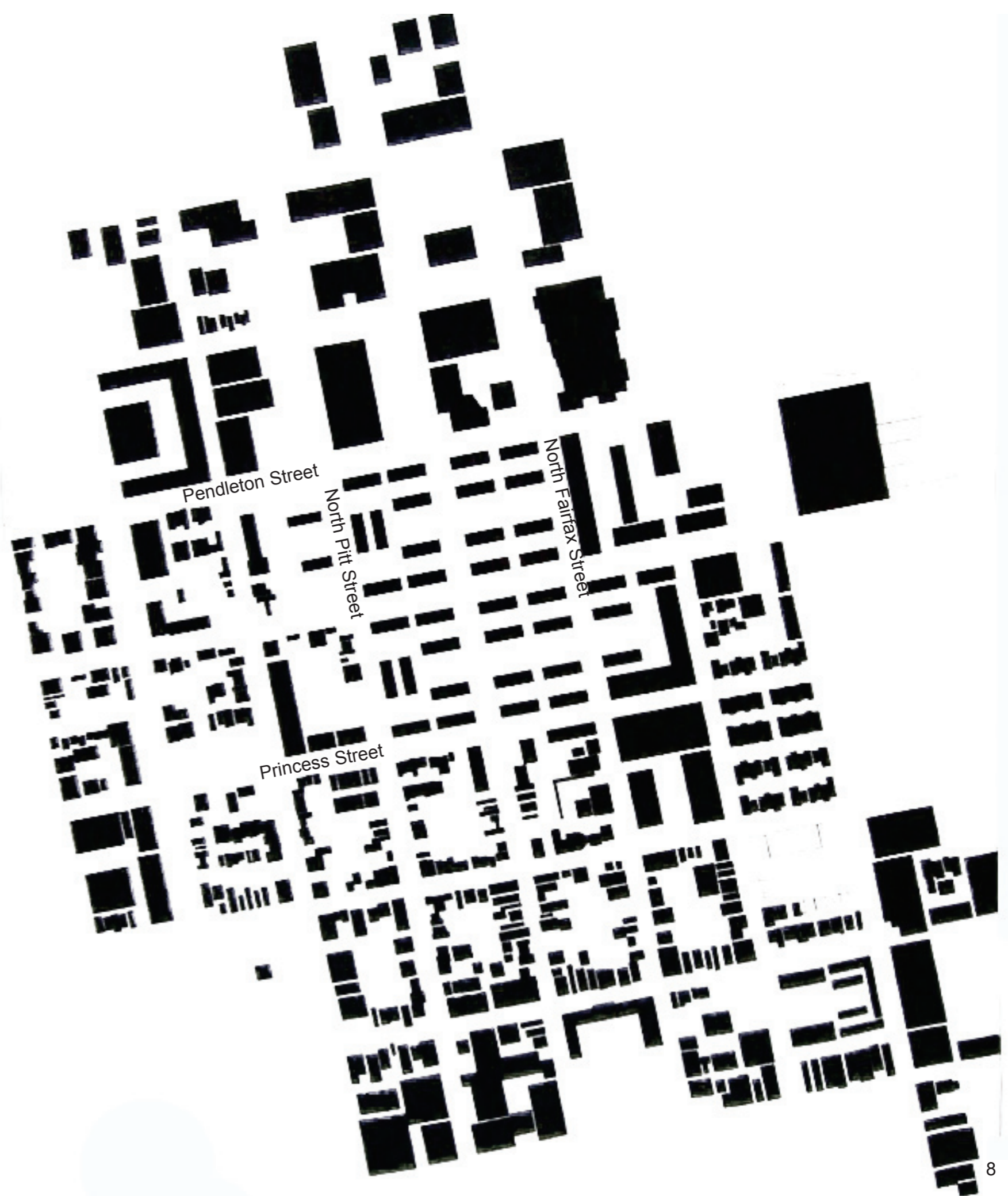

Project 2

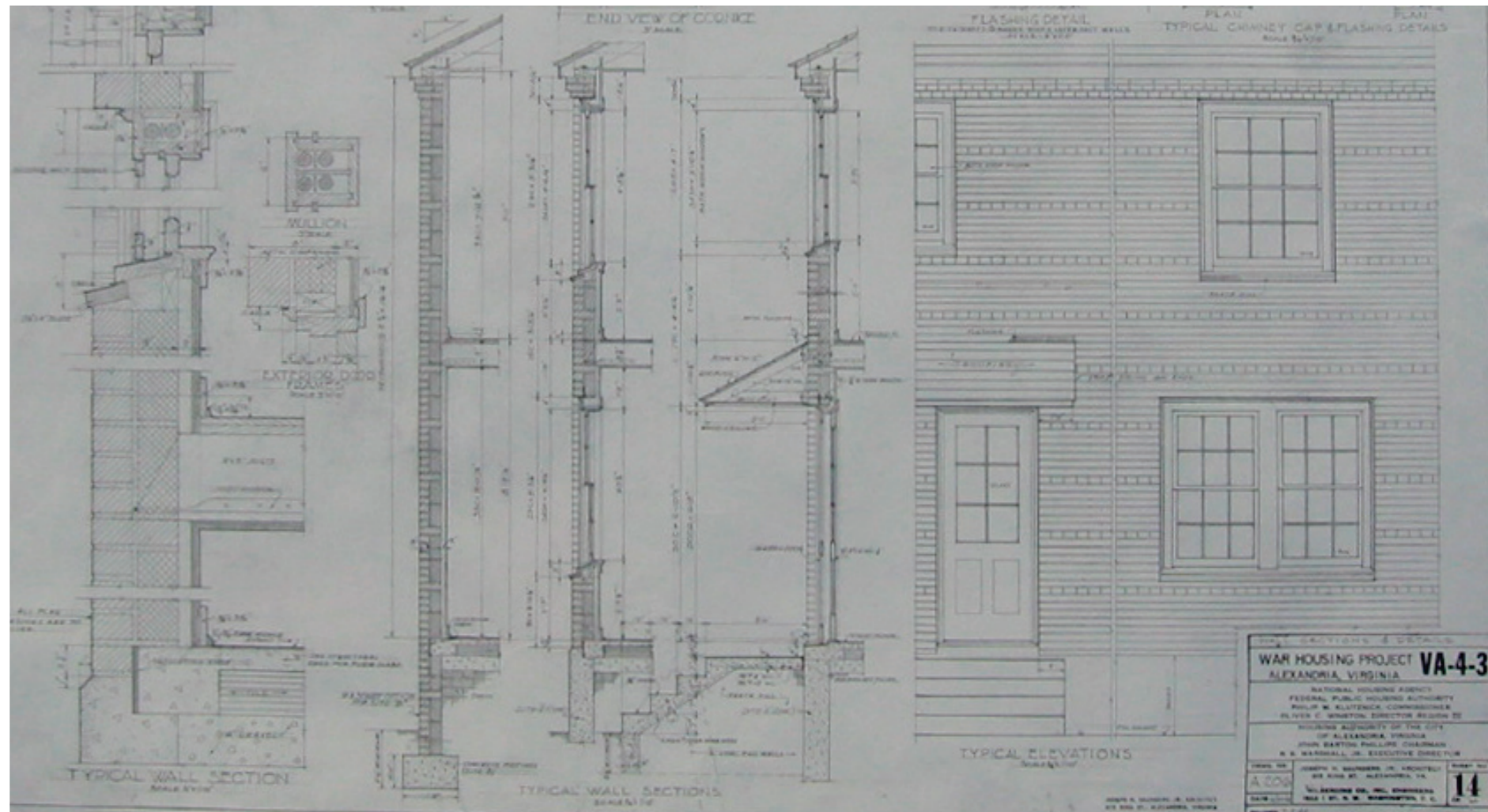

To initiate the design, I began by researching the original construction documents. It took a while to track them down through the city, but it was worth it. The hand drawn pencil construction docs were beautiful in their efficiency. Every inch of the paper was used and each page showed a variety of information. For instance one page showed a door schedule, a stair section, hand-rail details, building sections, coal room plans, and kitchen cabinet details. All of this is presented clearly and somehow logically. Quite a contrast to most firms carefully categorized drawings sets. It was as if the paper and pencil lines were precious versus today's computerized drawings which are less concerned with using the pages so wisely.

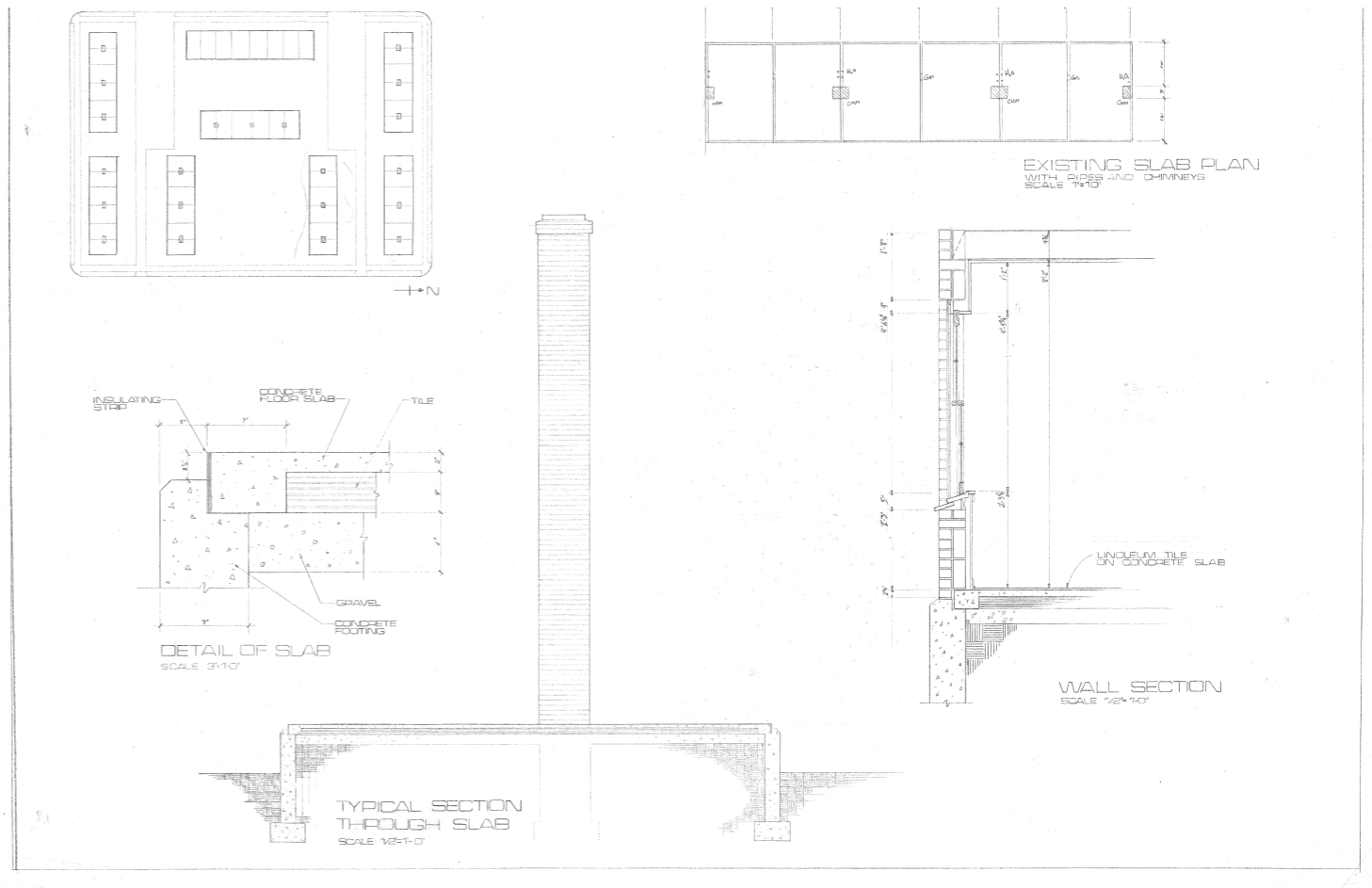

Before I laid my hands on the drawings, I considered a few different ideas. I toyed with using the foundation and site and building towers in the park. Perhaps it was some sort of residue from studying Corbu's designs for Paris. But some of these thoughts were too radical to be serious and so I thought far too expensive for a public housing project (I know realize how sometimes these larger more expensive projects can actually underwrite the publicly funded side of housing), but for this project I was concerned with how to do this on a lean budget.

After I found the original draws from the forties, I began studying their economy of design both graphically on the page and architecturally on the site. I decided to use the drawings as a template for graphically laying out my own designs on paper. I thought the economy of line and using every inch of the page to portray so many different aspects of the building at many different scales might actually inform the design process itself.

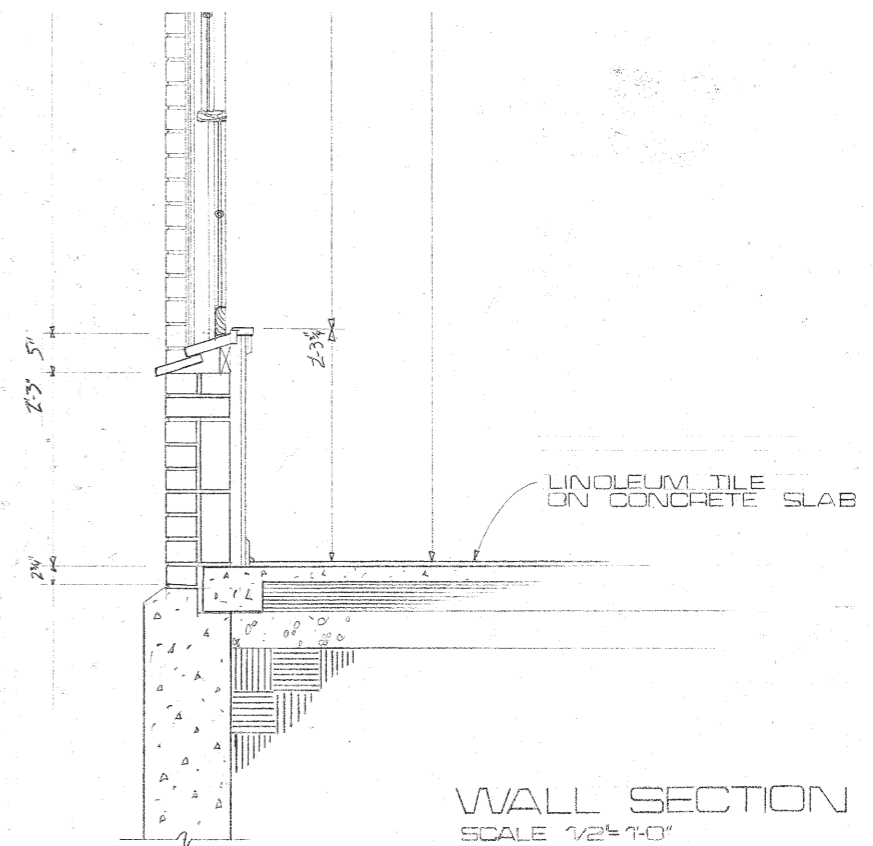

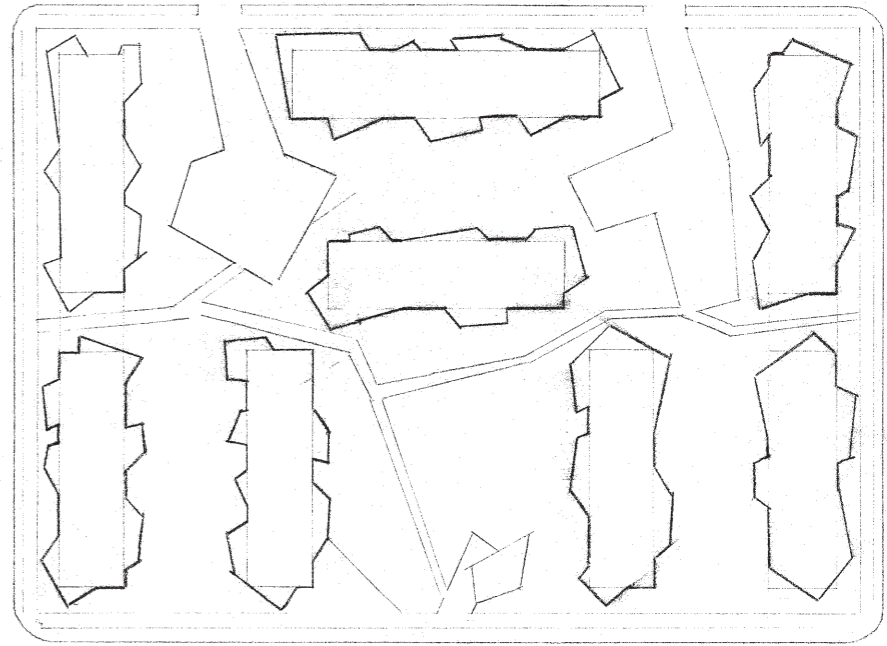
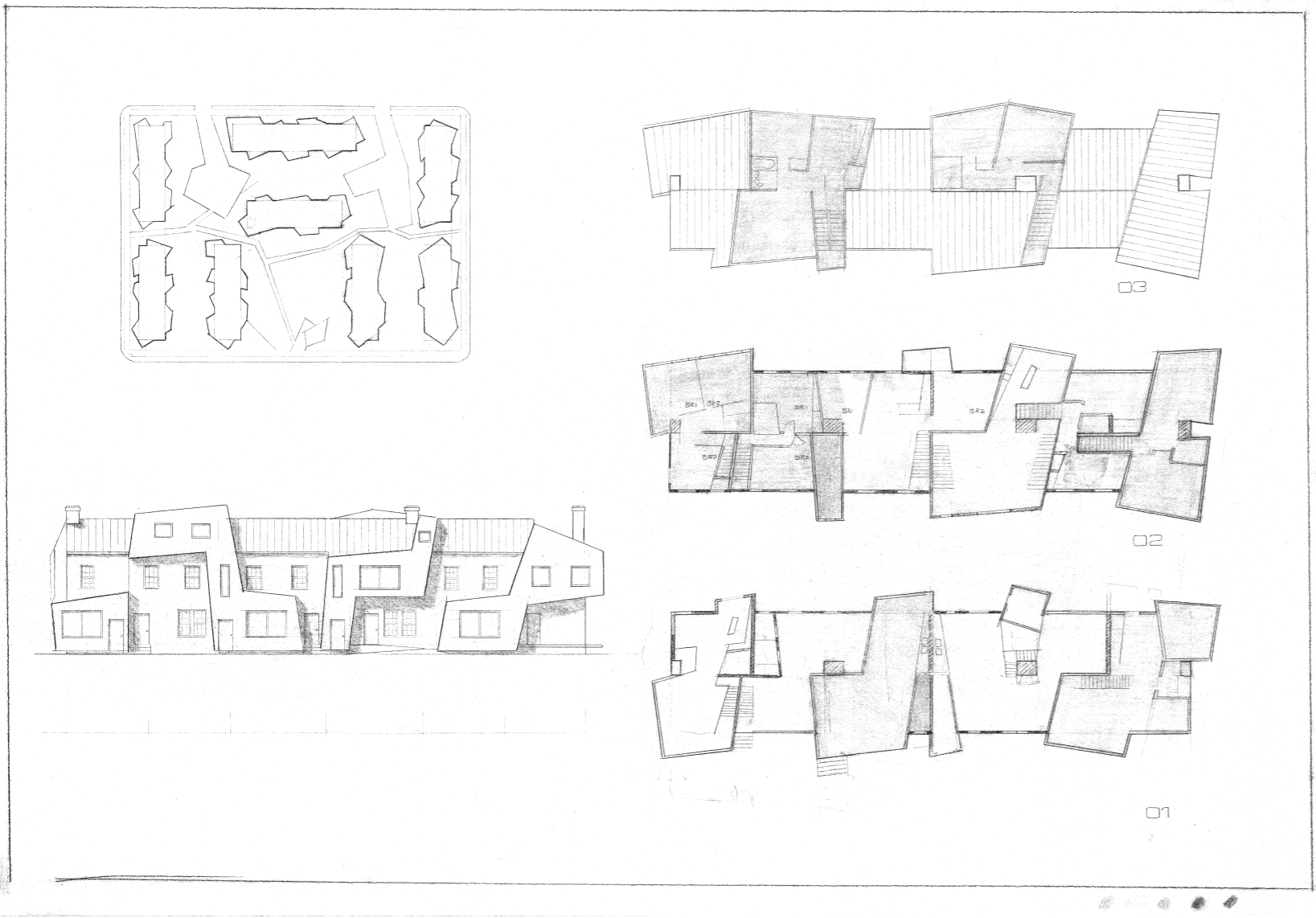

site plan

pencil drawing showing plans and elevations

I began using these simple drawings as a guidebook, following their principles. The plan called for reusing the building or at least reusing the foundations, recycling the past served to both save money and keep a footprint of what had been there on the site., The intention was to enliven the facade and create different units for different types of families. In doing this the interior walls were being blown out and replaced by new walls crawling with wooden insertions. The goal was to create a 3 dimensional jigsaw puzzle that carved out new spaces and uses for a contemporary user.

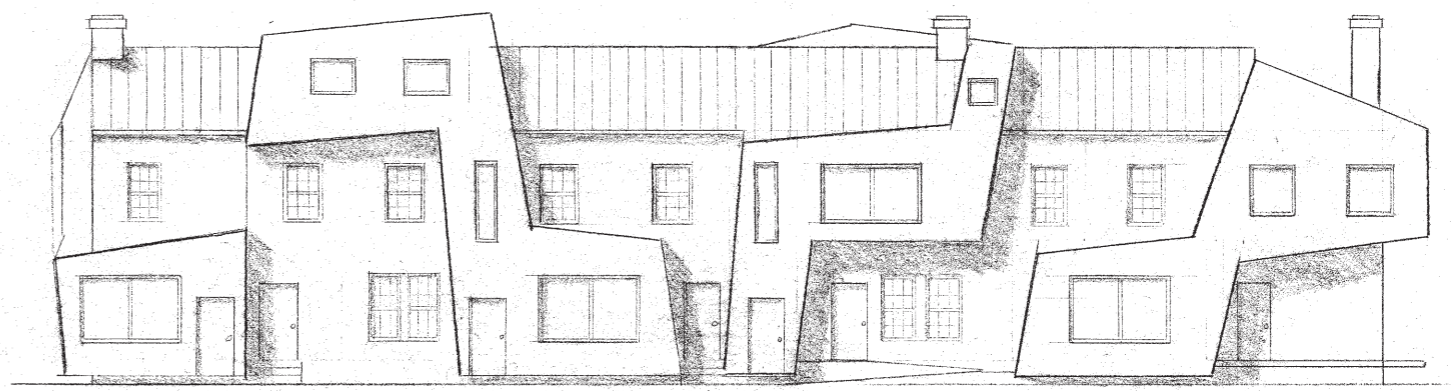

elevation

3rd floor plan

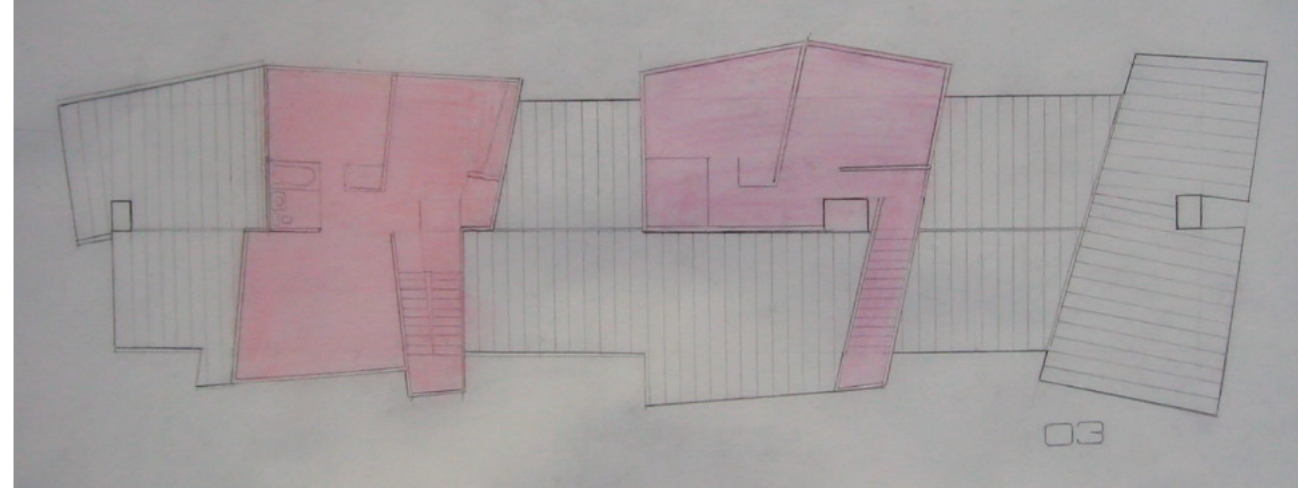

2nd floor plan

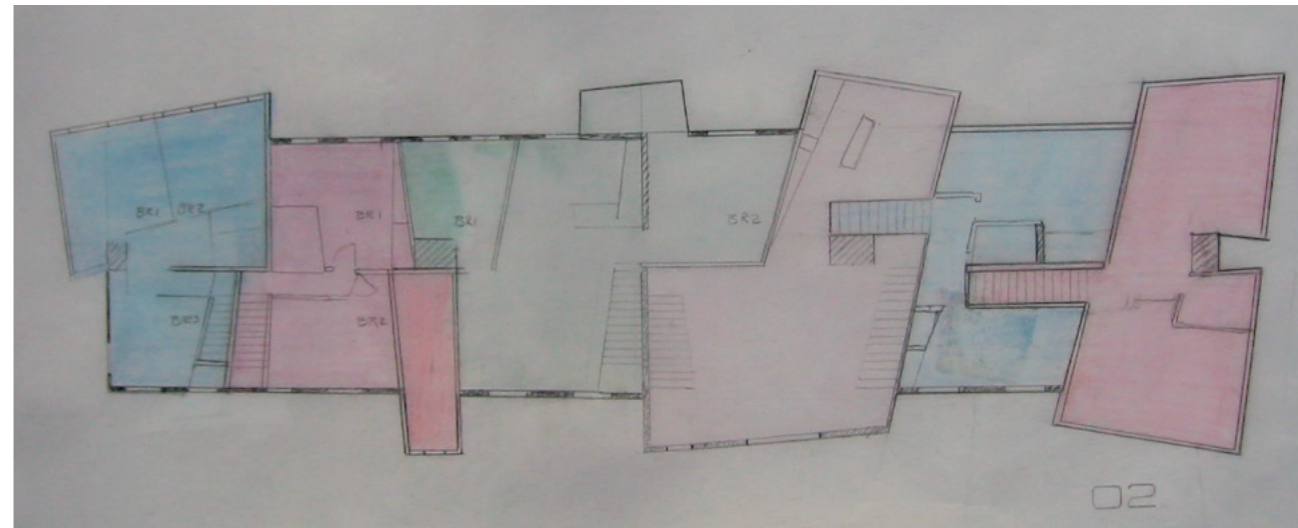

1st floor plan

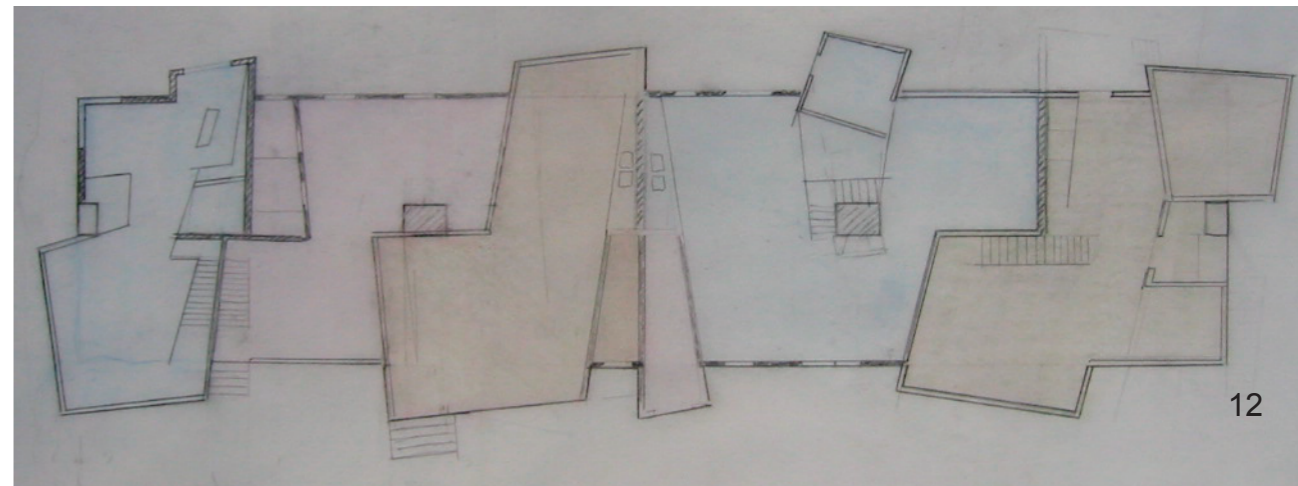

The plans and elevations created an intricately interlocking set of spaces of different sizes. bachelor studios were existing under large family dwellings spanning three stories. The units were varied in plan, section, and elevation. To follow the units up the building, I color coded them so that for instance, a purple unit that only happened on the upper two floors could be easily distinguished from its next door neighbor, a blue unit which had a large first floor living space and two smaller upper bedrooms. The number of units stayed the same, but the size of the spaces became much more individualized and much larger.

However, this process proved too complicated for the program. The spaces were only marginally larger and the facades still very similar to their previous brick clad elevations. It was advised that tearing down these walls to build them back up again in a similar massing pattern was not solving the problem of new housing as efficiently as desired.

Project B

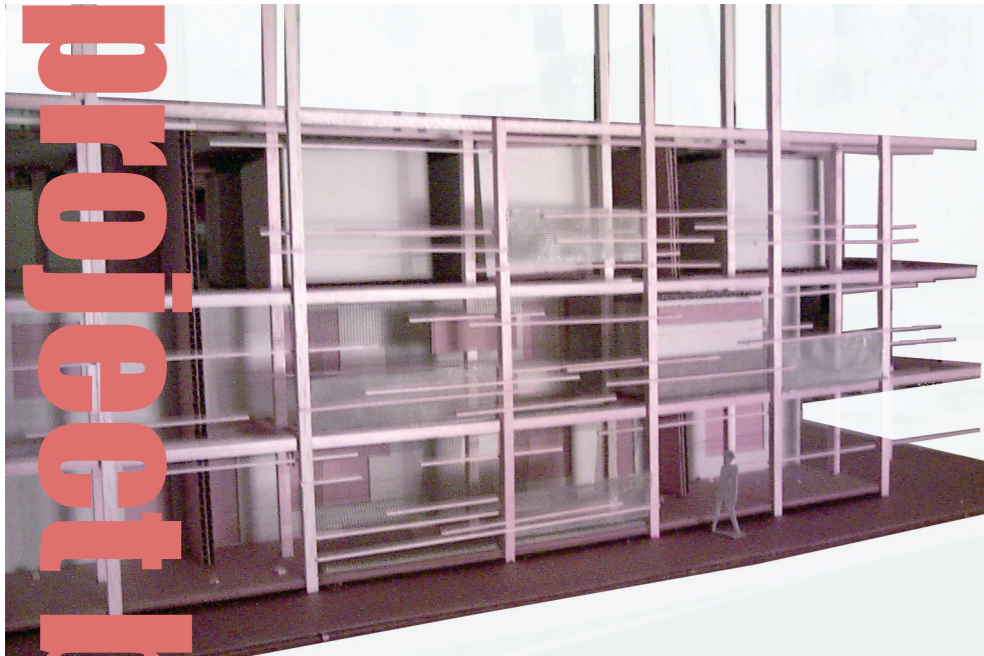

model of project b

For the next phase of the project, I decided to work more in model than in plan. After spending so much time with the page and the plan, playing with an architectural puzzle only to move on to a new idea, a model seemed like a way to free up my mind. I worked on quick study models to explore more efficient ways to construct this idea. I also began exploring virtual computer models as well, playing with the building in Photoshop..

I immediately was drawn to keeping the building skin as it was and working to build upon more of the existing building. I tore the roof off the building and began to work up and out. I struck on the idea of prefabricated rooms on the upper floors which could be quickly and efficiently constructed off site. They could then be laid in very rapidly on the existing building, using the brick base almost as a modularized foundation for the future.

After I had settled on this new strategy, I developed a study model further working on the skin and creating movement and shadow on these otherwise plain brick walls. After spending a good deal of time around these buildings and studying them I observed the residents spent a good deal of time outdoors. The children playing and the adults socializing. Taking in this need for an outdoor room and thinking also of a Southern and a Virginian tradition of porches I began working on a wrap around veranda.





PROJECT C

For the final iteration of this thesis I tried to combine the ideas in the previous versions and refine them. I reused the existing buildings and added further contemporary layers of history to them. I reused the foundation and much of the existing walls then reconfigured the interiors, added a third floor, and created a mix of indoor and outdoor spaces.





composite computer study

The design grew organically from the inside out. Four points were critical in developing this: that the building be economical in materials and resources, that it maximize the space on the given foot print, that it be sustainably designed, and that it could be constructed quickly with as little disturbance to the residents as possible.



front elevation

The elevations plainly show the layers of materials, constructions, and history. The base building is kept and the windows are replaced with updated high performance glass. The roof is replaced with a third floor and roof top terrace. There are pre-fabricated bathroom units made of Kalwall hung between each unit that will glow like chinese lanterns. Finally the entire facade is wrapped in a wooden balcon. The horizontal bands of wood railing tie the elements together and give the composition a certain dynamism.

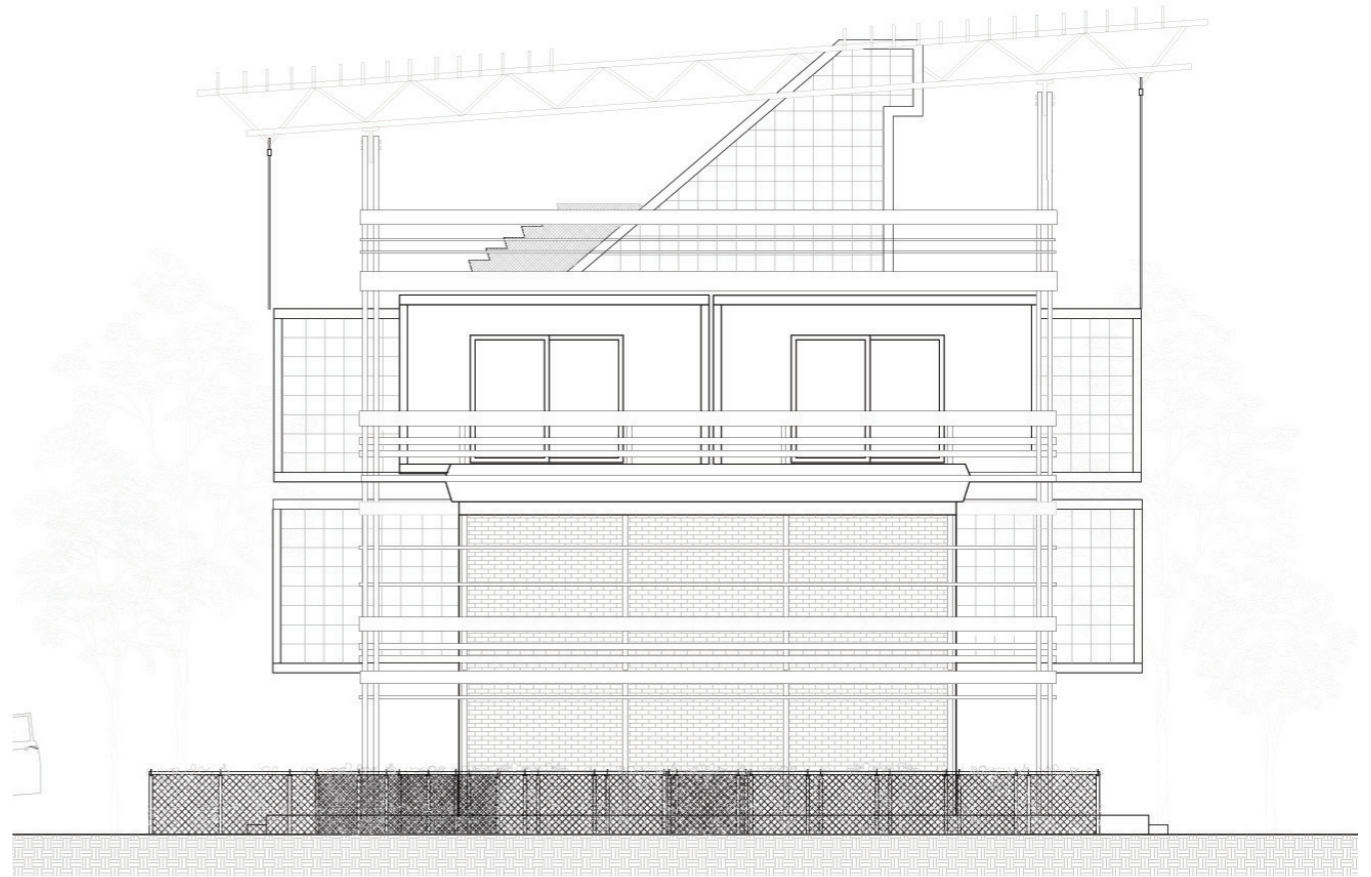

side elevation

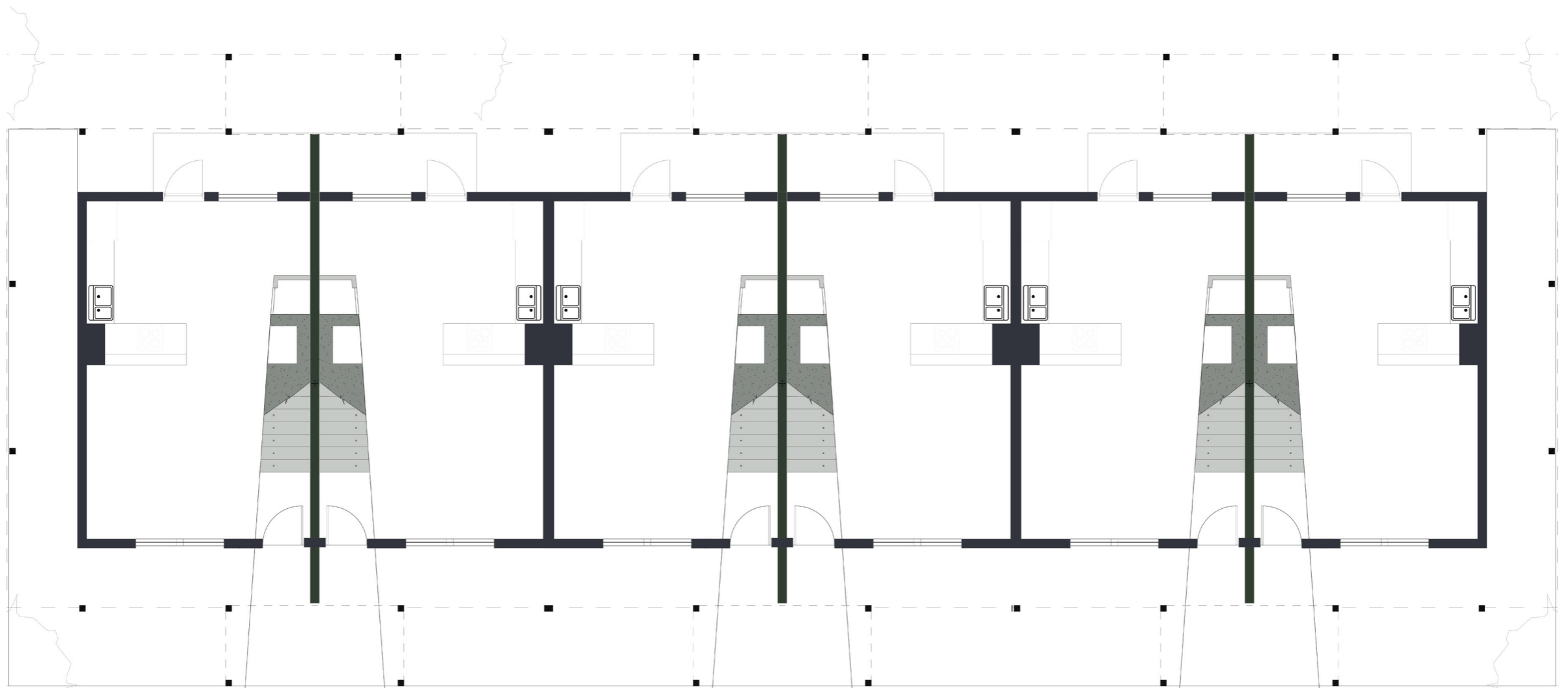

first floor plan

The entry to the first floor is dominated by the staircase. It is cast in place concrete and serves as the foundation for the light metal stairs above. The stair is carved out with assorted niches which provide storage and shelving for the unit. To the side of the stair is the kitchen which is light and open. The entire space is kept very minimal and filled with light.

stair detail

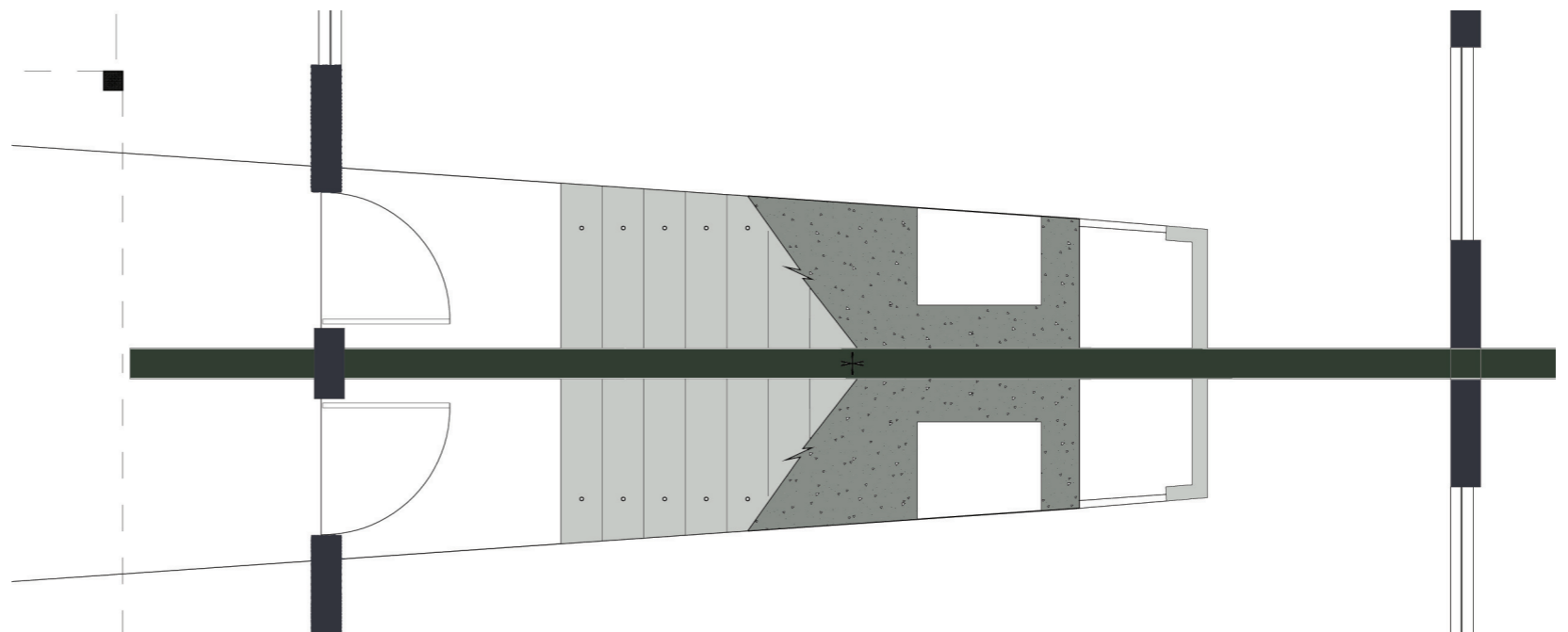

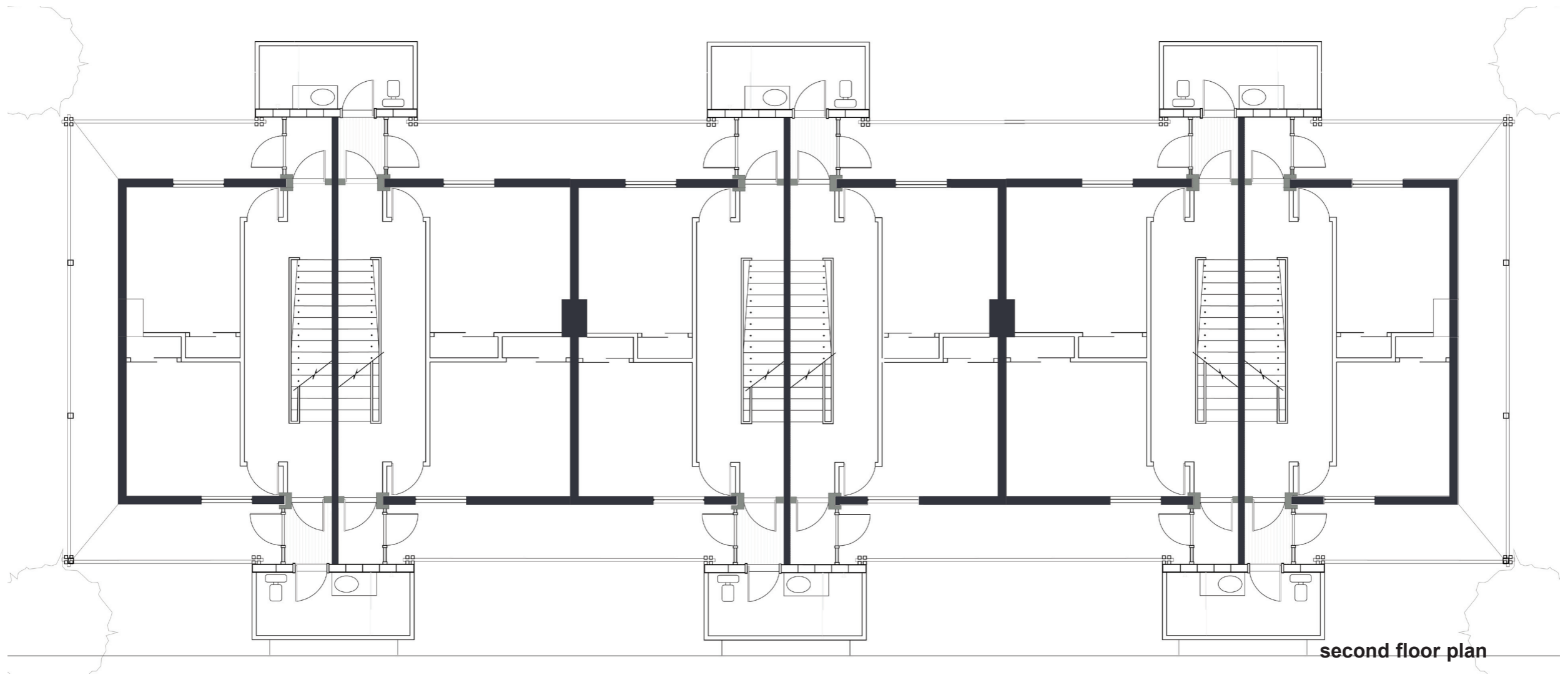

The second floor is a reconfiguration of the previous second floor. The previous plan was consumed by a bathroom awkwardly located in the center of the unit and resulted in cramped bedrooms on either in. By pulling the bathrooms out in a prefabricated unit issues of space, light, and ease of installation are all addressed. Light enters the hallway here from the stairs above and filters down through the light and airy structure of the staircase. Also the units are generously served by outdoor spaces with wrap around balconies. This extends the living area and offers a new relationship to the street.

stair detail

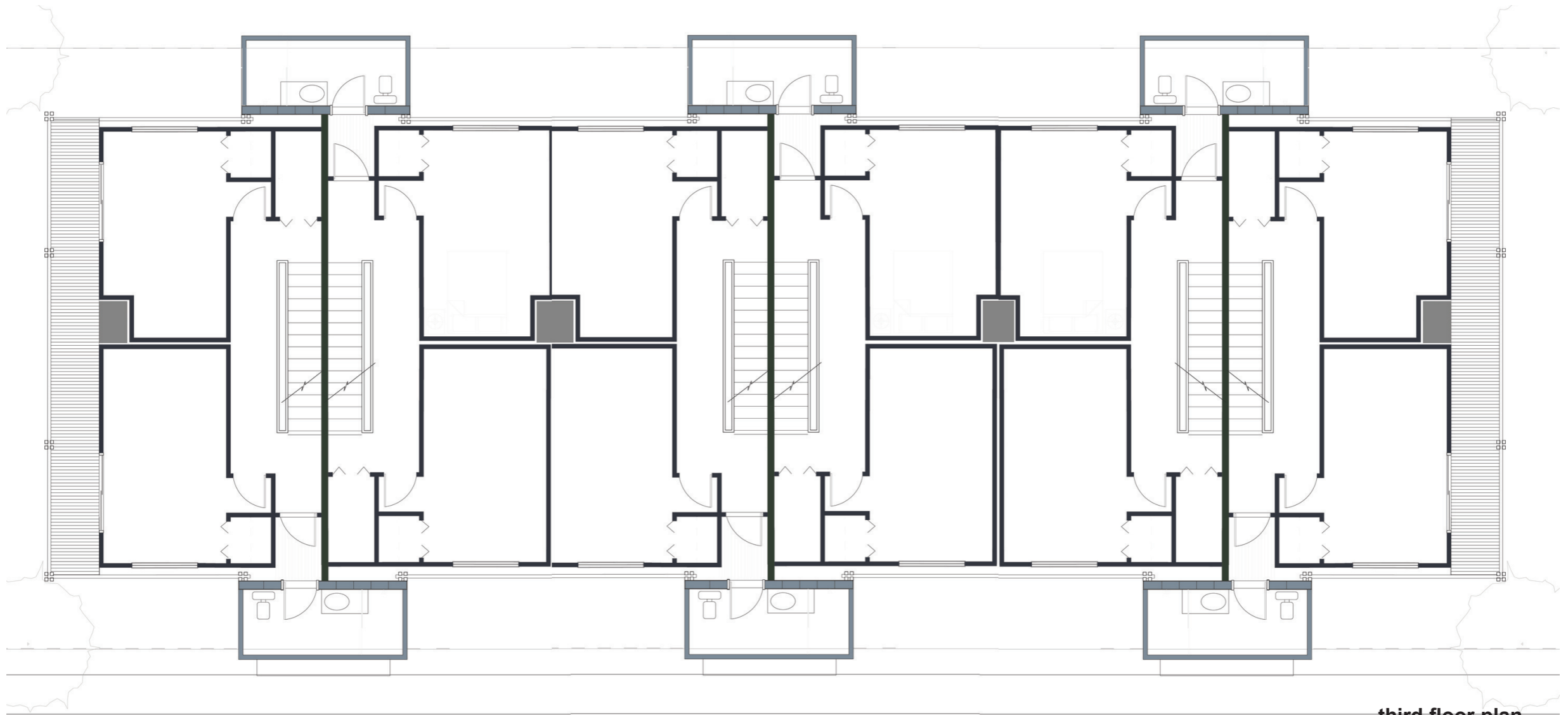

third floor plan

Finally the third floor is capped by the new prefabricated units. These lightweight units are composed of modular structural insulated panels (SIPs.) The SIPs panels offer the highest available insulation and replace the formerly uninsulated attics of the former construction. They are lightweight and offer fast installations. These are the largest rooms and extend to the edge of the balcony below, covering it. The rooms have large windows and offer a playful and practical addition.

SIPs detail

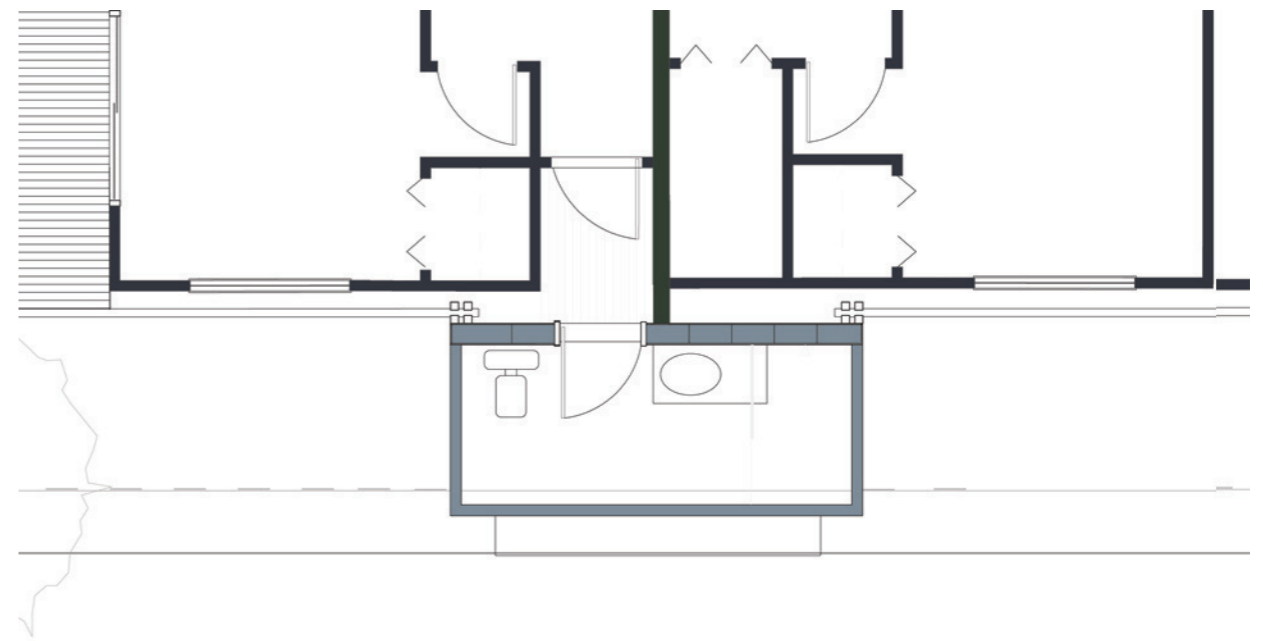

bathroom detail

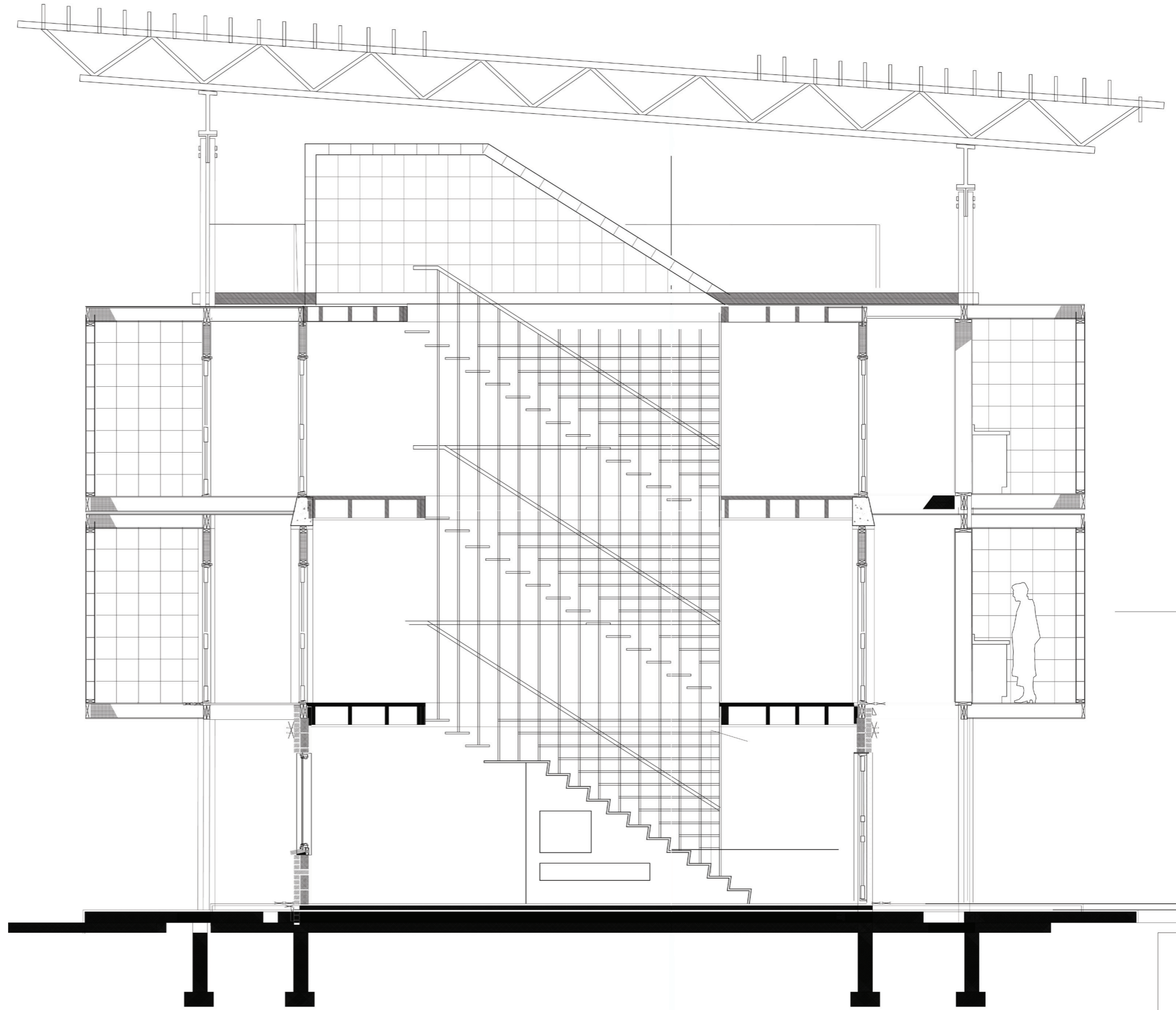

building section

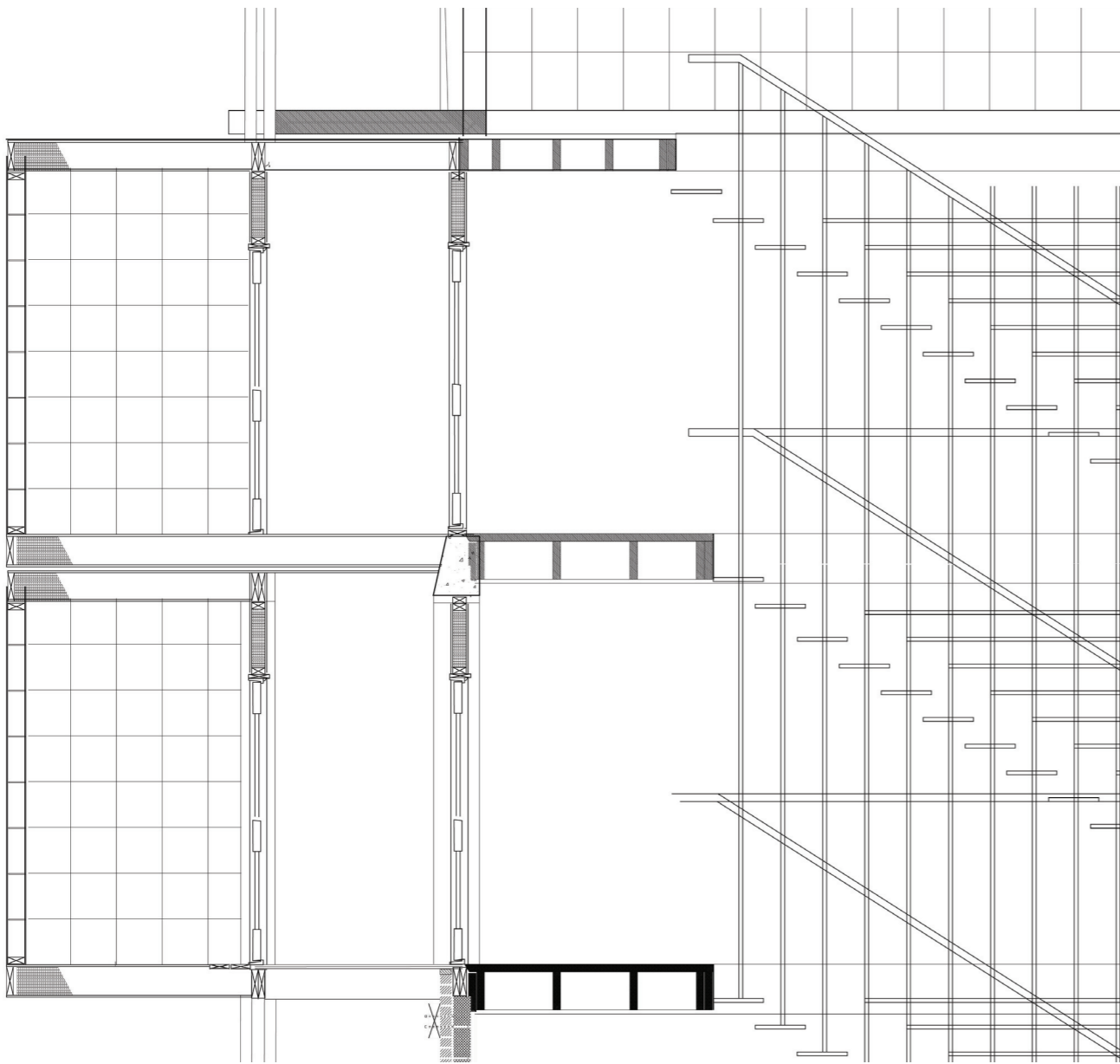

building section detail

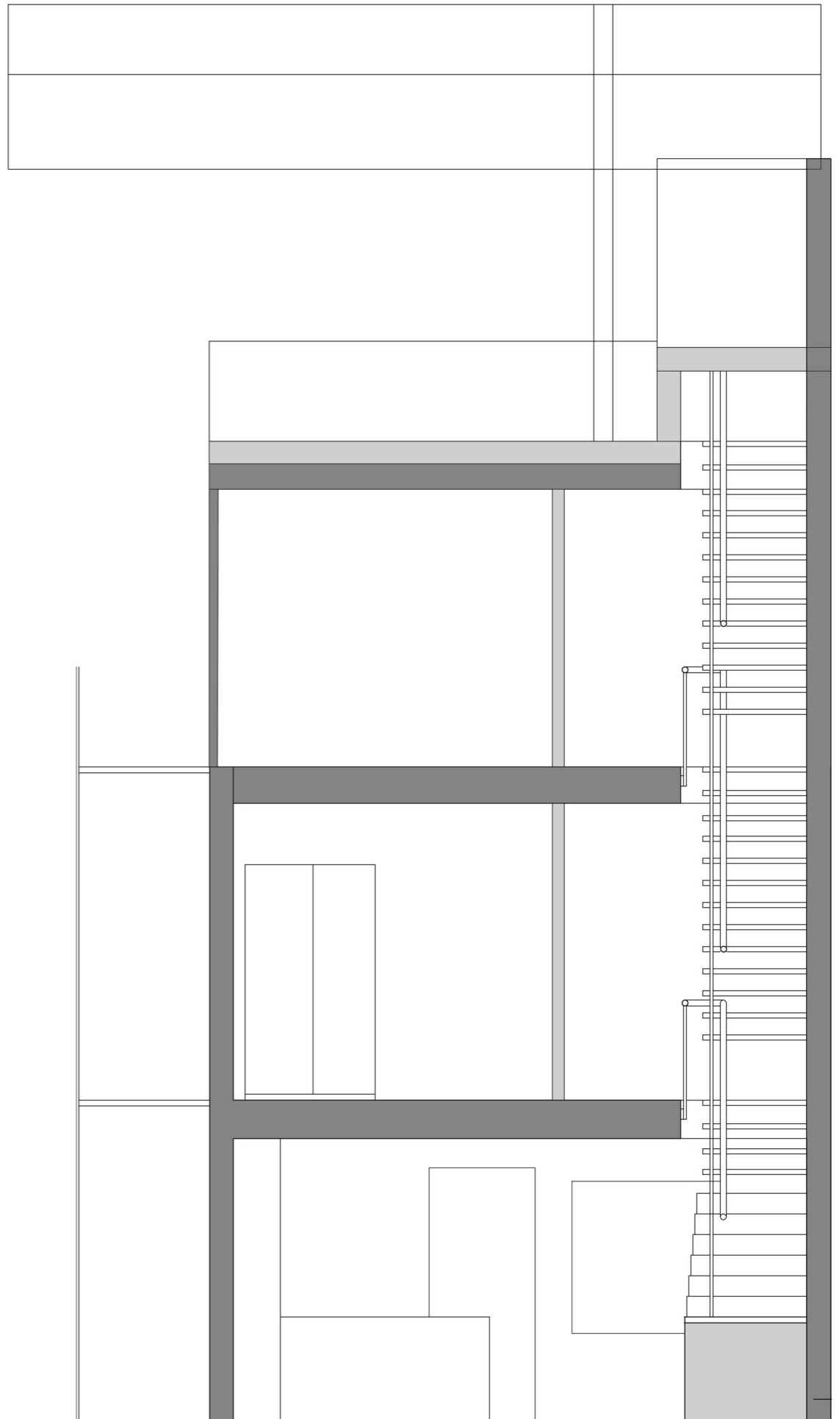

building section detail

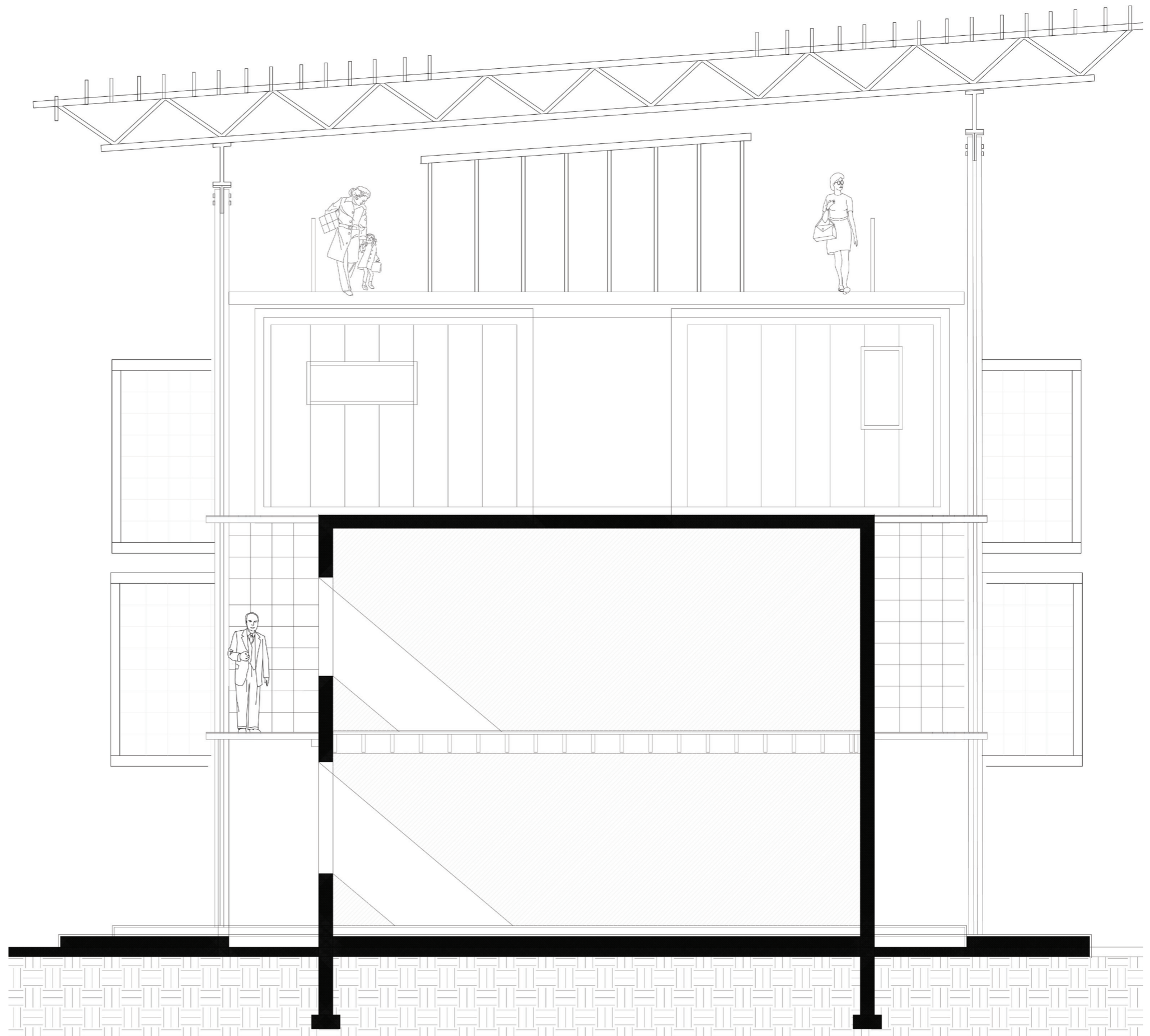

building section

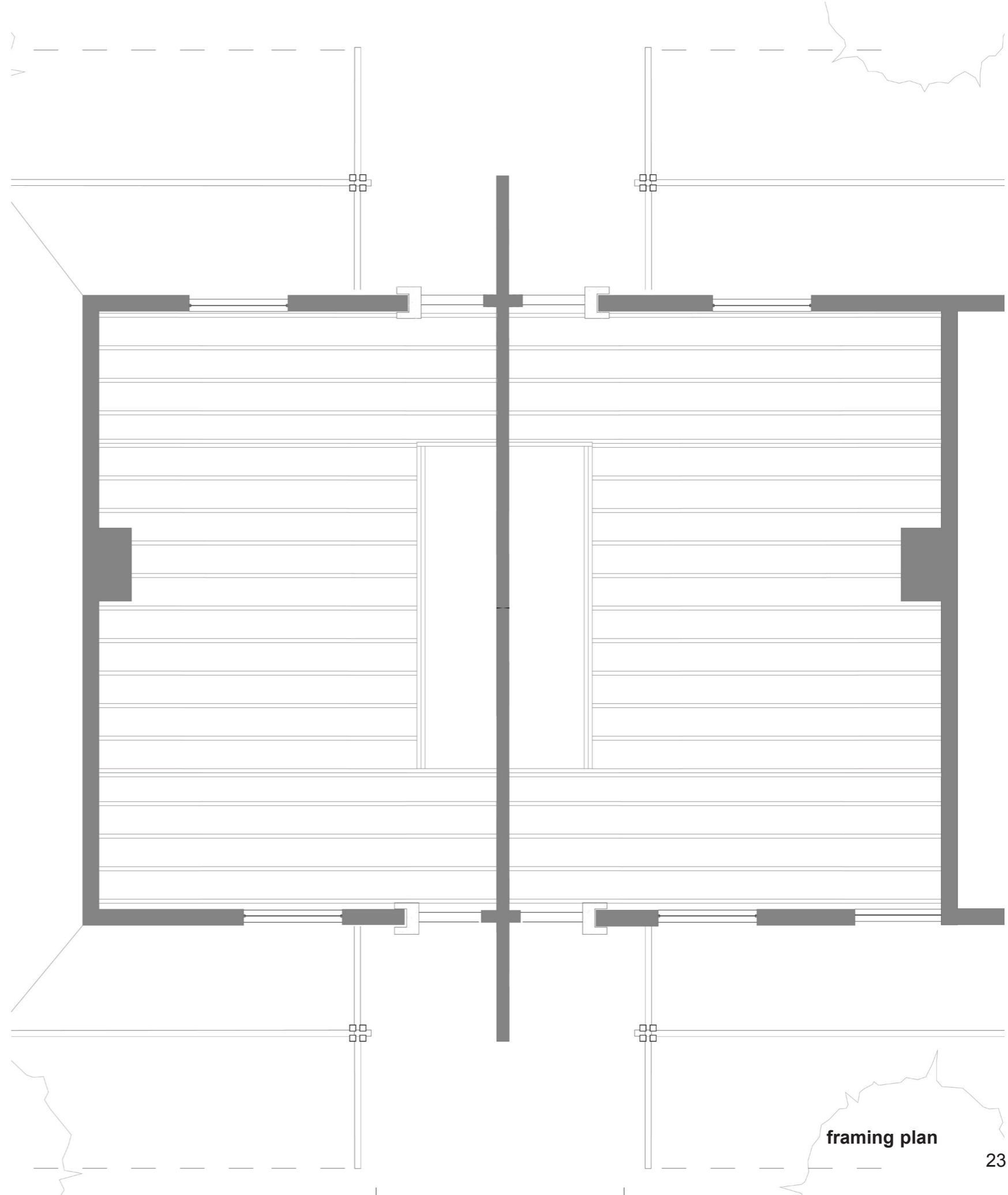

framing plan

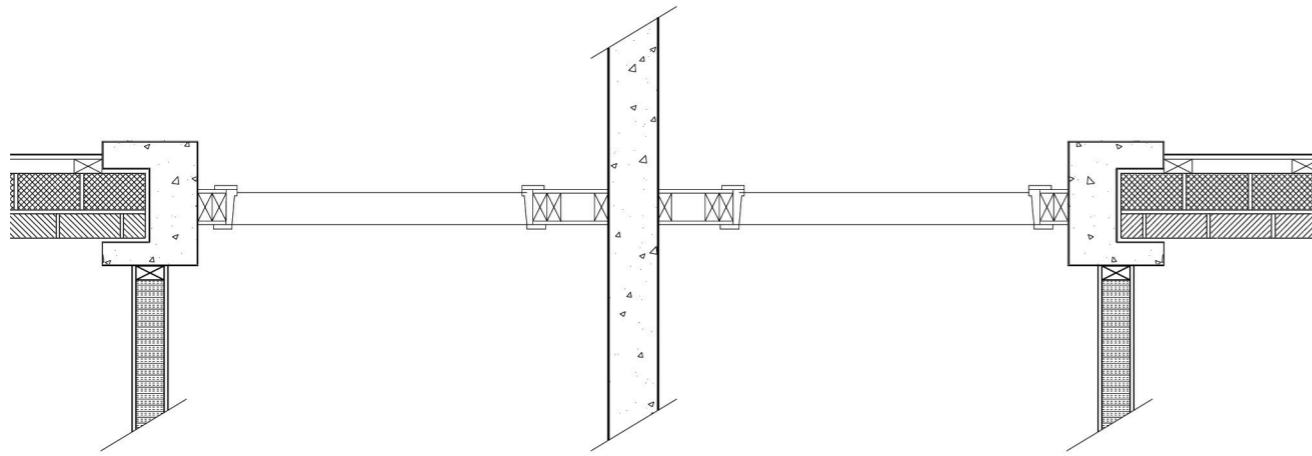

section details of new door to existing building

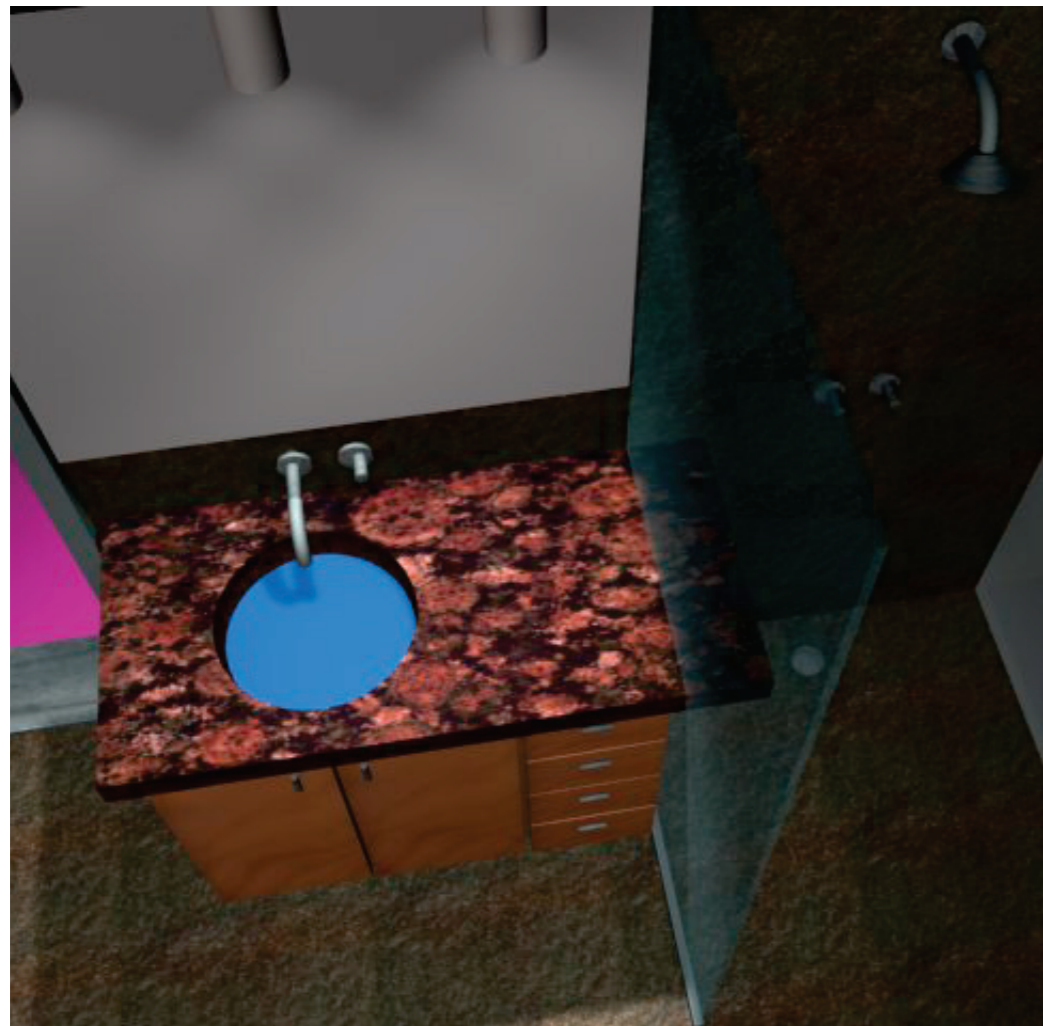

bathroom rendering

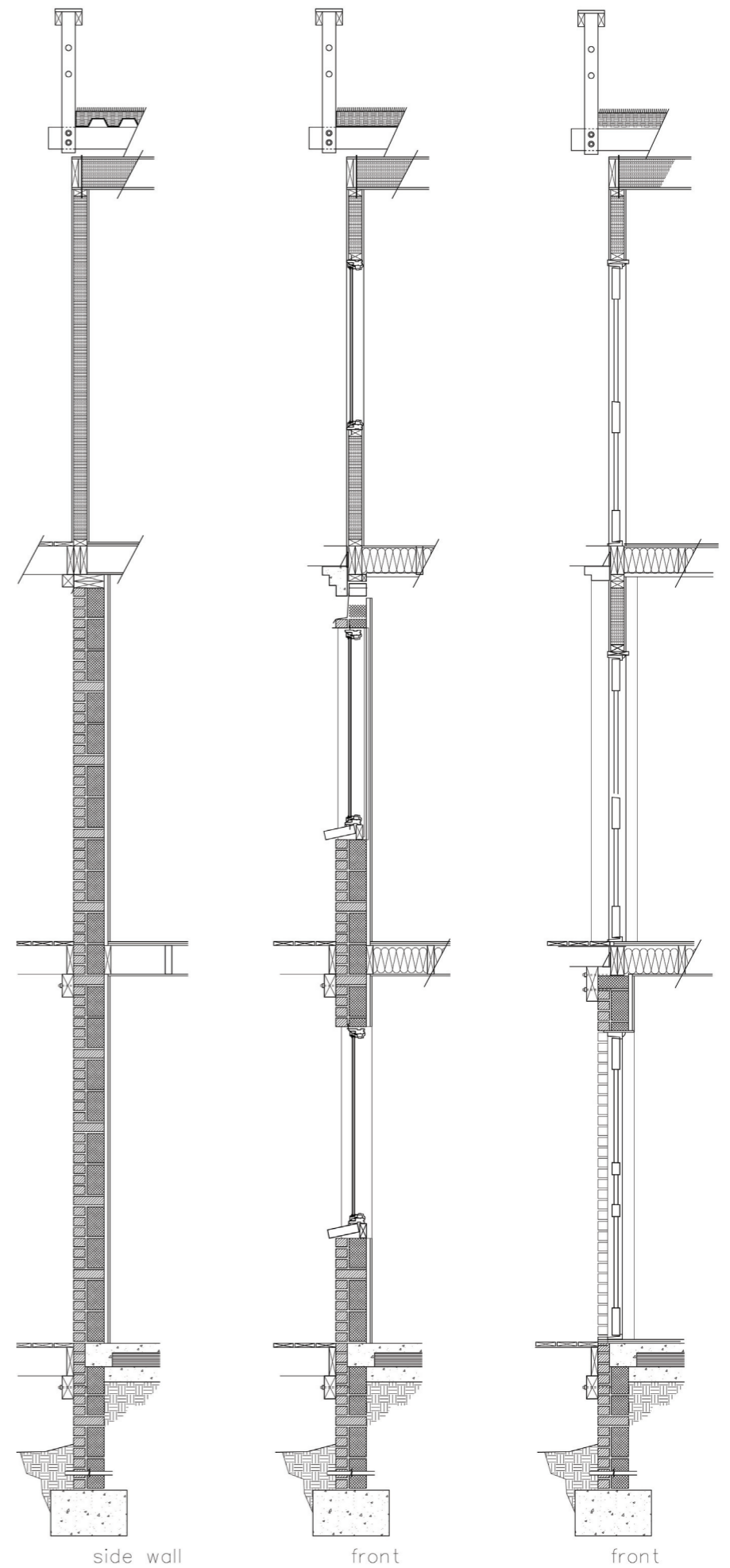

section details

side wall

front

front

model showing porch

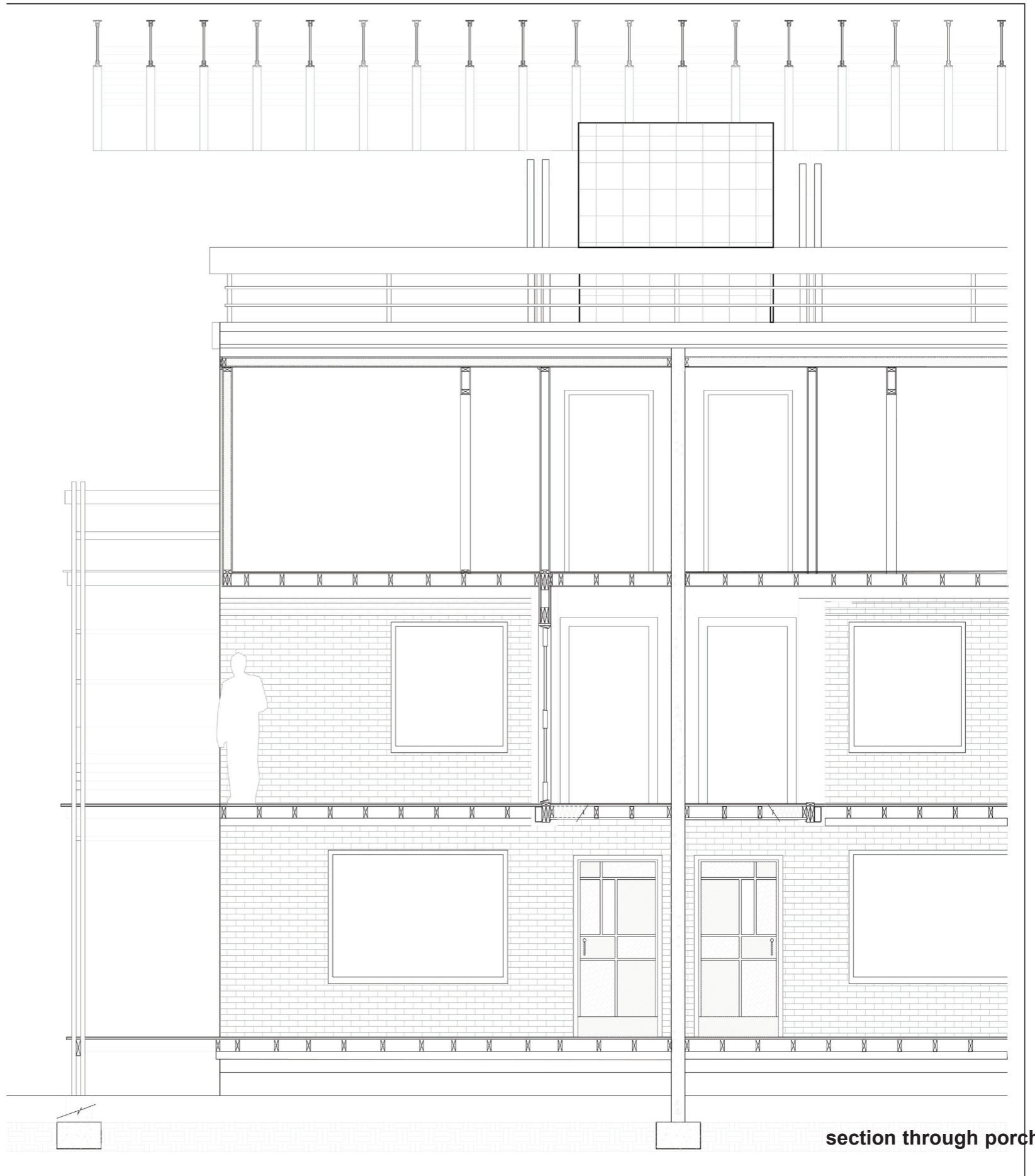
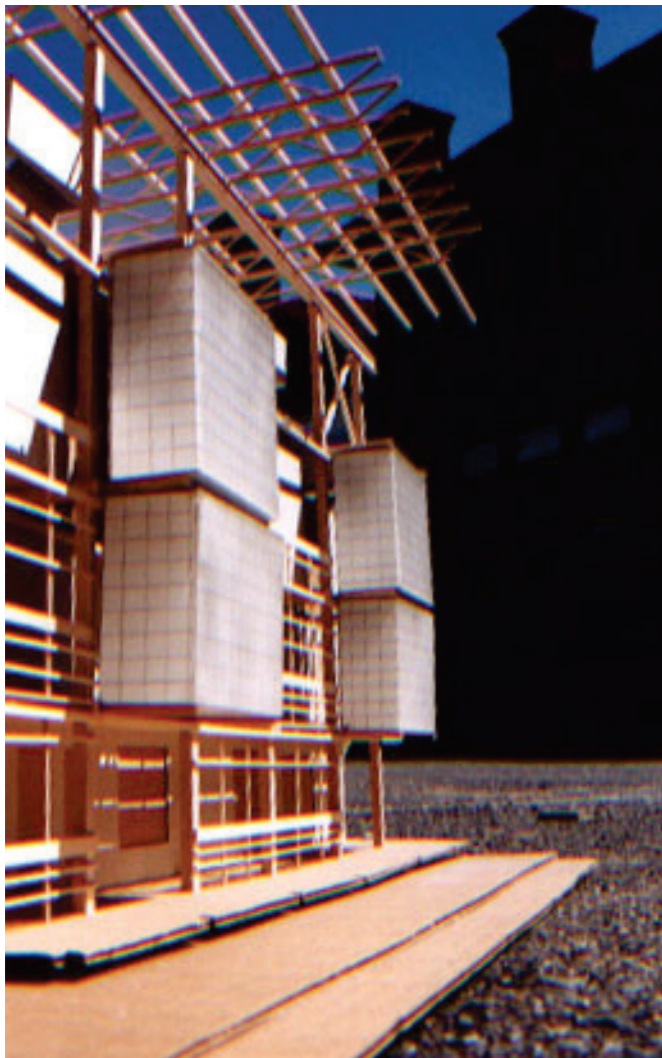

section through porch

computer model

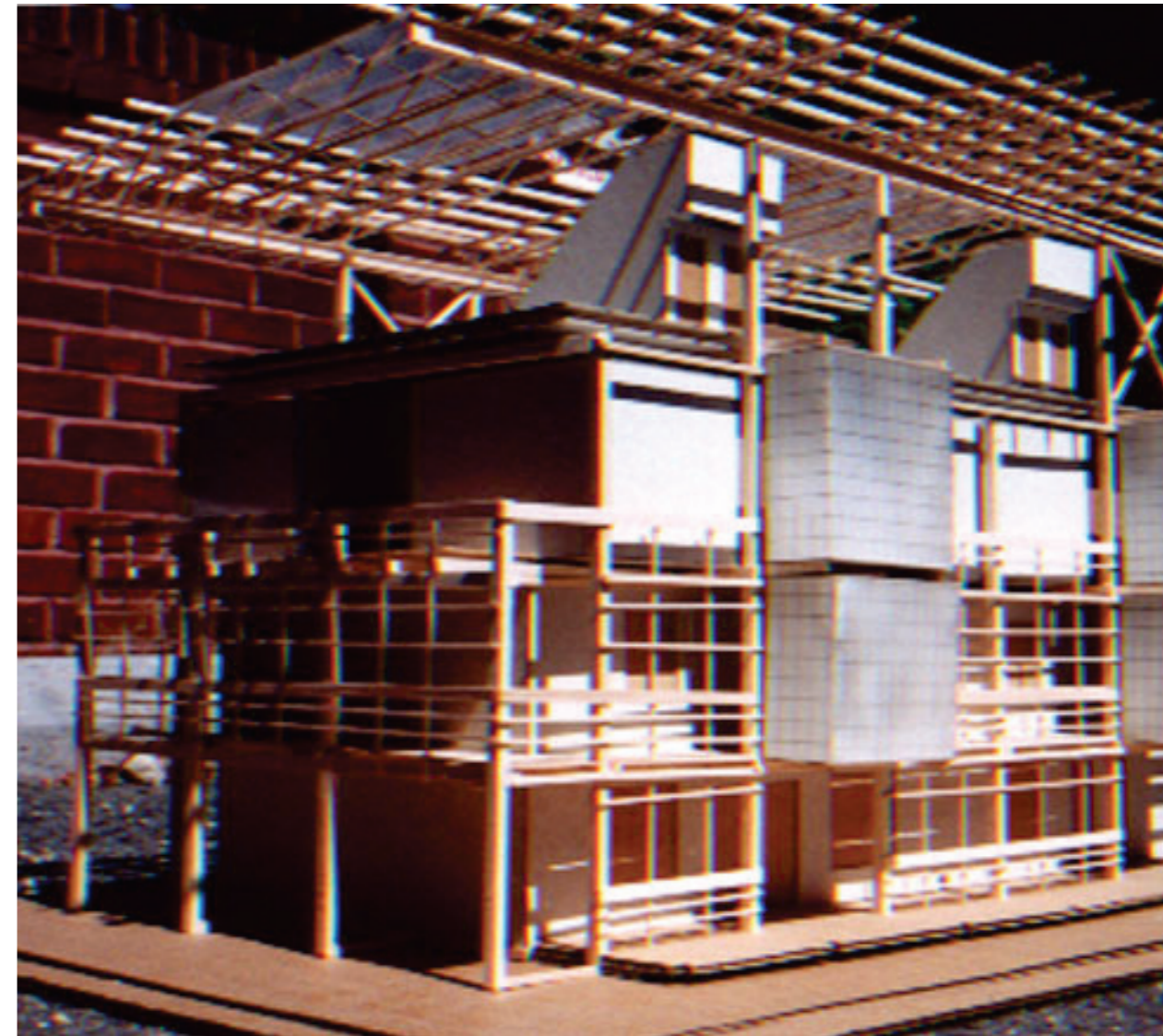
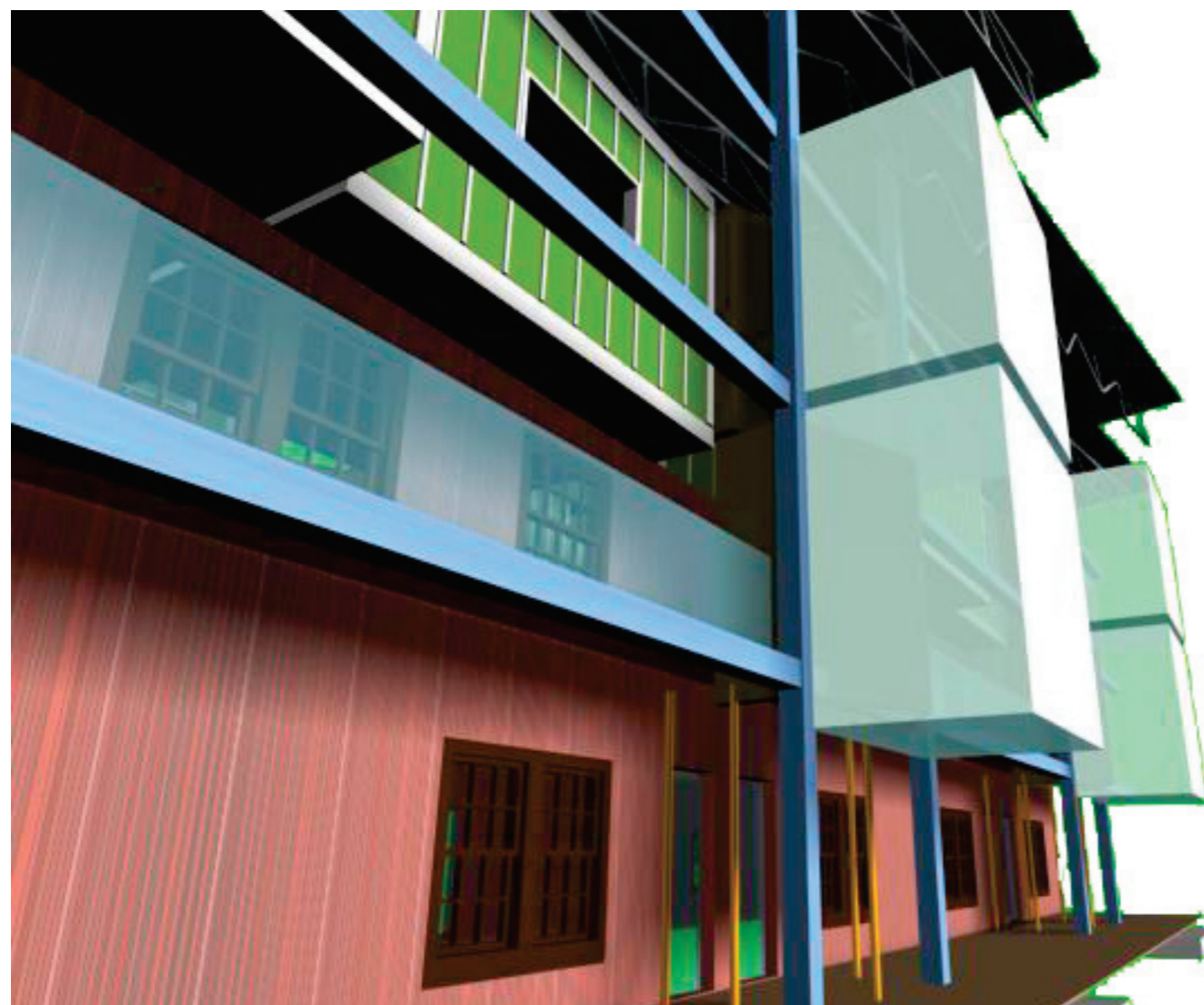

physical model

Conclusion

From the beginning I wanted to put together a project which helped put what I had learned between the US and Europe into one project. Comparing the way we Americans approach building in an historic and contrasting it with the way Europeans address the same problem. The politically charged site of the Berg seemed an ideal crucible to test my thoughts.

As the project went on, it became much more than that. It became an exploration of a process. Taking an idea apart, reexamining it, putting it back together in a new way, then tearing it down and starting from a different and informed perspective. This process became in some way the thesis itself. A learning journey of a path into territory that was more incognita than I may have originally supposed. This thesis paper is like a series of film stills capturing an evolving process.

What I finished with is a building that I believe could very well meet the needs of the residents and the community. It meets the needs of the residents by proposing a comfortable, environmentally responsible building which uses the past as the foundation to build for the future. It finally meets the needs of history as well as the needs of the present and an honesty to both.

graphics

All graphics by the author except the following:

3. Prosthetics, public domain images.
4. Freedom Band, Alexandria Black History Museum.
7. Google satellite photo
9. Pencil drawings from Alexandria Housing Authority
21. map by Belinda Bloomberg

Bibliography

Allen, Edward. Fundamentals of Building Construction. Materials and Methods. New York, John Wiley and Sons. 1990

Bachelard, Gaston. The Poetics of Space. Beacon Press, Boston 1994.

Banham, Reyner. Theory and Design in the First machine Age. The MIT Press, Cambridge, Mass. 1981.

Bloomberg, Belinda. Free Black Adaptive Responses to the Antebellum Urban Environment and Socioeconomic Stratification in Alexandria, Virginia, 1790-1850. PHD Dissertation, American University, 1988.

Dolan, Laurel C. A History of Negro Education in the Alexandria City Public Schools, 1900-1964. Masters Thesis, American University, 1969.

Hilberseimer, Ludwig. The Nature of Cities. Origin, Growth, and Decline. Pattern and Form. Planning Problems. Paul Theobald, Chicago, 1955

Hilberseimer, Ludwig. The New City. Principles of Planning. Paul Theobald, Chicago, 1944.

Jan van Pelt, Robert & Westfall, Carroll William. Architectural Principles in the Age of Humanism. Yale University Press, New Haven, Conn. 1991.

Howard, Mark. An Historical Study of the Desegregation of the Alexandria, Virginia City Public Schools, 1954-1973. Masters Thesis, George Washington University, 1976.

Mumford, Lewis. The City in History; Its Origins, Its Transformations, and Its Prospects. HBJ, San Diego, 1961.

Olsberg, Nicholas. Carlo Scarpa Architect, Intervening with History. The Monacelli Press, Montreal, Quebec, 1999.

Rasmussen, Steen Eiler. Experiencing Architecture. MIT Press, Cambridge, 1959.

Voges, Nettie Allen. Old Alexandria, Where America's Past is Present. EPM Publications, McLean, Virginia, 1975.