

# An Architectural Alternative to the Big Box

Kristen Fowler

Thesis submitted to the Faculty of the Virginia Polytechnic Institute and State University in partial fulfillment of the requirements for the degree of

Master of Architecture

Hans Rott  
Scott Gartner  
Frank Weiner

April 24, 2008  
Blacksburg, VA

Keywords: Retail, Brick, Market

Copyright 2008, Kristen Fowler



## Abstract

Wal-Mart has plans to open a store in the town of Blacksburg, Virginia. The fact that there is already a Wal-Mart store, in the town of Christiansburg, just four miles away from the proposed location makes this idea ridiculous for some. A large group of Blacksburg residents are opposed to the idea of a Wal-Mart in their town. The usual complaints are about how it will affect small businesses and traffic.

The core concept of the “big box” store is not the problem. The idea of being able to get everything you need, from motor oil, to toothpaste, is appealing to consumers. The “one-stop-shopping” concept is not the problem; the big box design is. Retailers like Wal-Mart, K-mart, and Target cause adverse effects on the communities they service because their design does not embrace the surrounding areas. This thesis project is an architectural alternative to the big box store design. I propose two corrective strategies.

The first correction is the removal of the sea of asphalt that acts as a barrier between the store and the street. Parking is coveted in this country; therefore, the car will not be banished. However, an activity as monotonous as parking can not be permitted to take center stage. A parking structure is proposed to be located behind the retail area. This allows the main activity, shopping, to be accessible directly from the street; and for the architecture of the shops to directly interact as close as it can with the fabric of the town.

Instead of one big box, several small structures make up a market place atmosphere. This allows each shop to have its own identity while still being part of a holistic place. The shopper is not funneled through a maze of merchandise all under one roof with no windows. Individual shops, each with their own entries and exits, restore a sense of orientation and give individuals an opportunity to choose how to spend their time. Wal-Mart has expressed an interest in exploring new store designs more fitting to small communities. This thesis is an example of what a new design concept might be.



**NO  
WAL-MART  
BY  
BEEKS**

## Acknowledgements

I would like to thank my Nana and Diddy for supporting me throughout my educational years and throughout my life. I would also like to thank my Mother, my rock.

# Table of Contents

- Early Studies.....1-9
- Resolution.....10-27
- Conclusion.....28-29
- References.....31



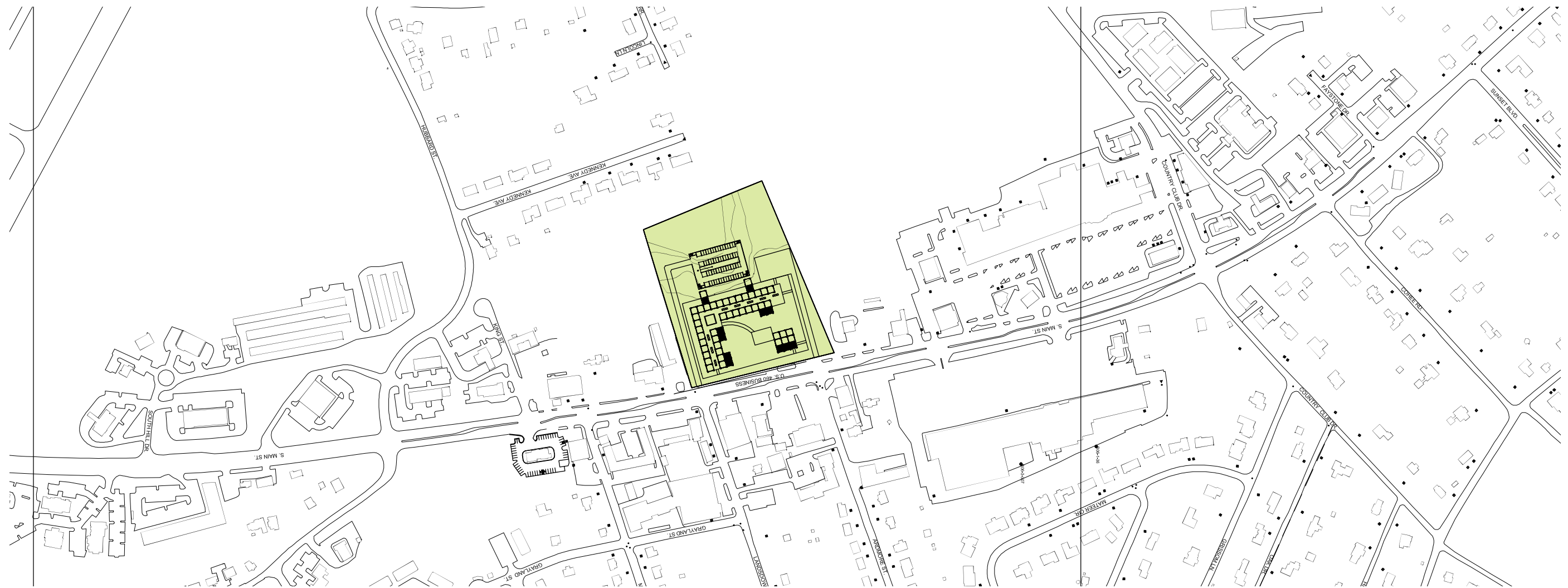

Site located on South Main Street, Blacksburg, VA

9 Square Diagram

- In relation to the 16 block original plan of Blacksburg.
- Imposes an order not present in this part of town.

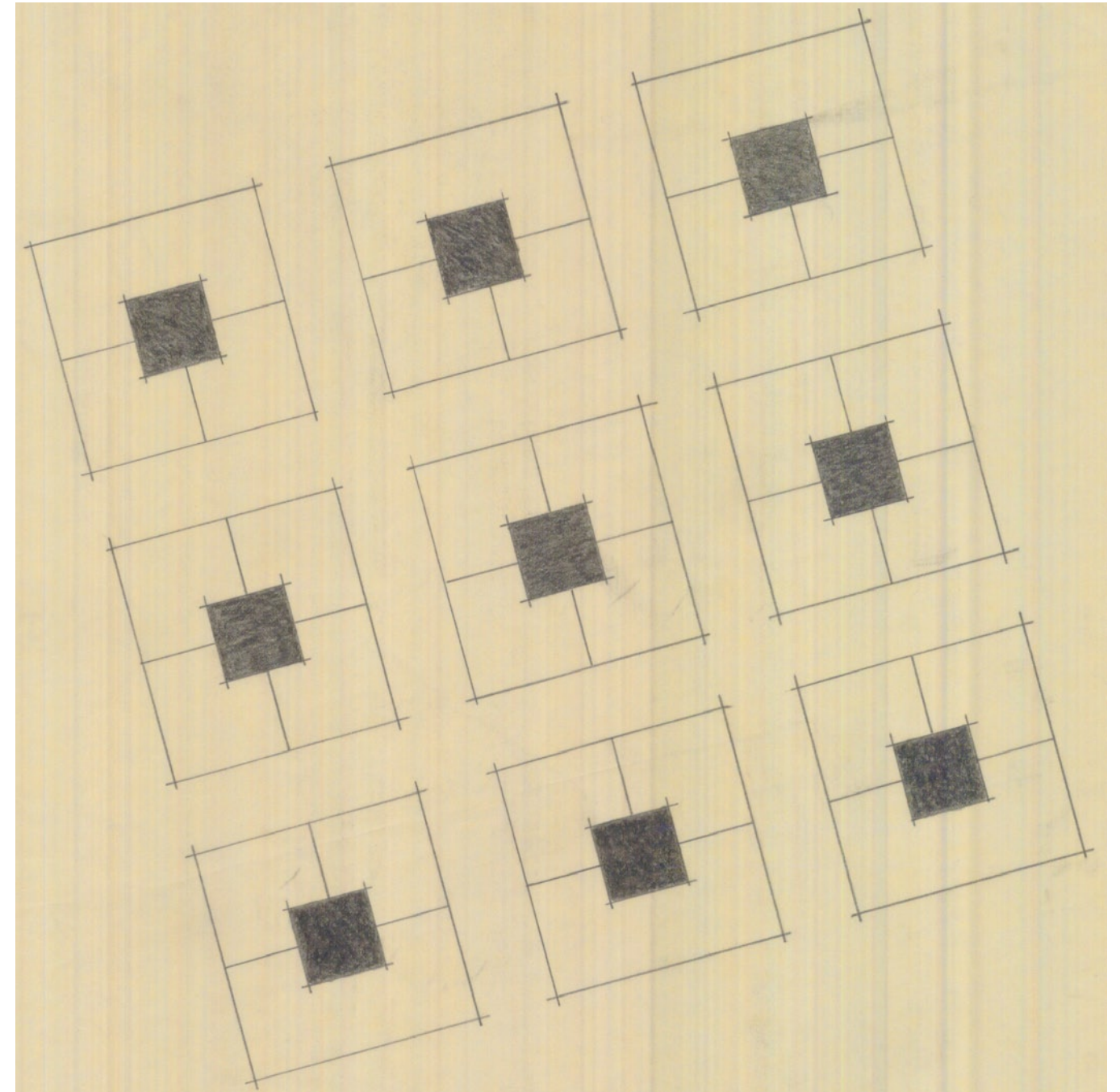



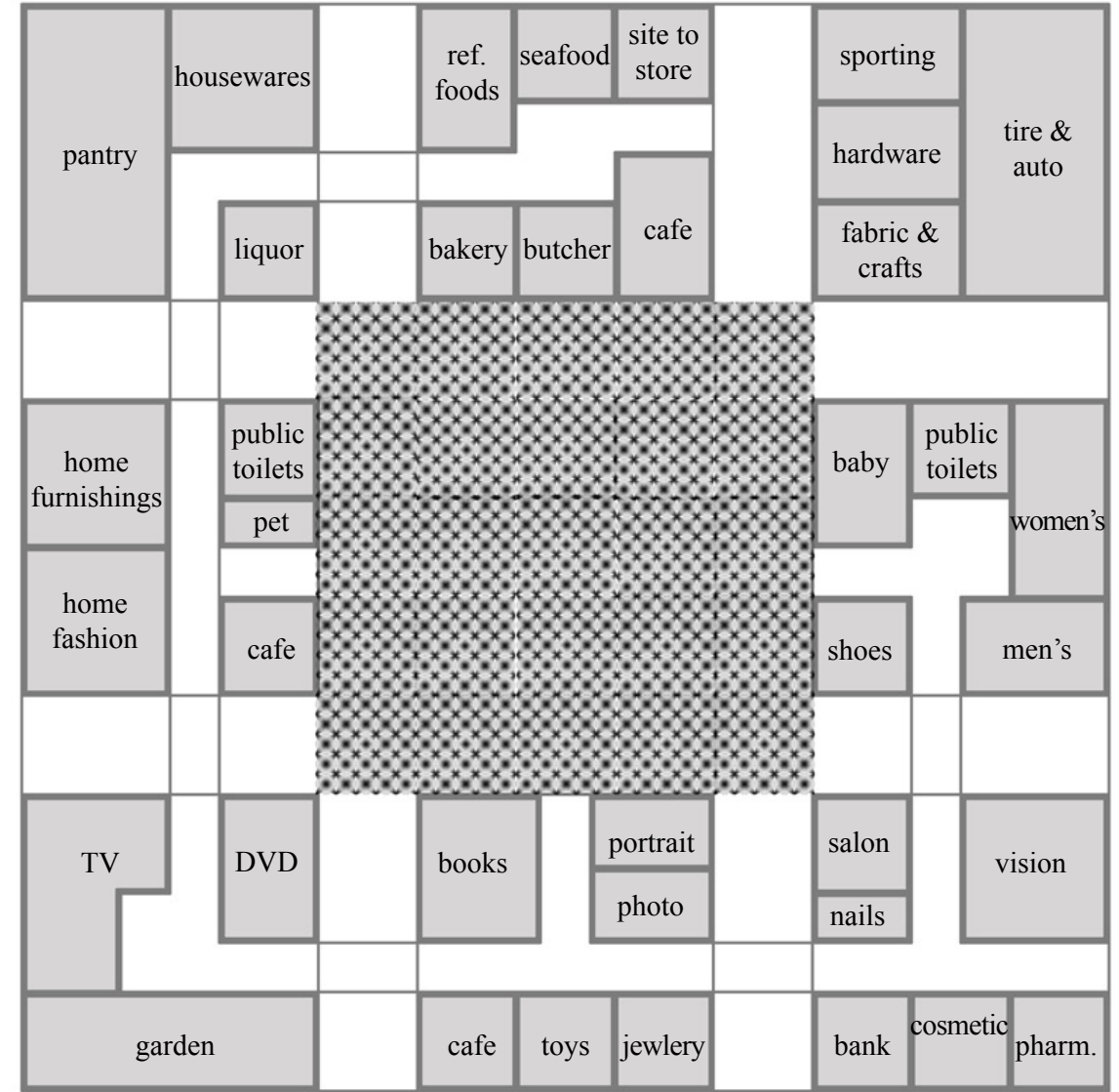
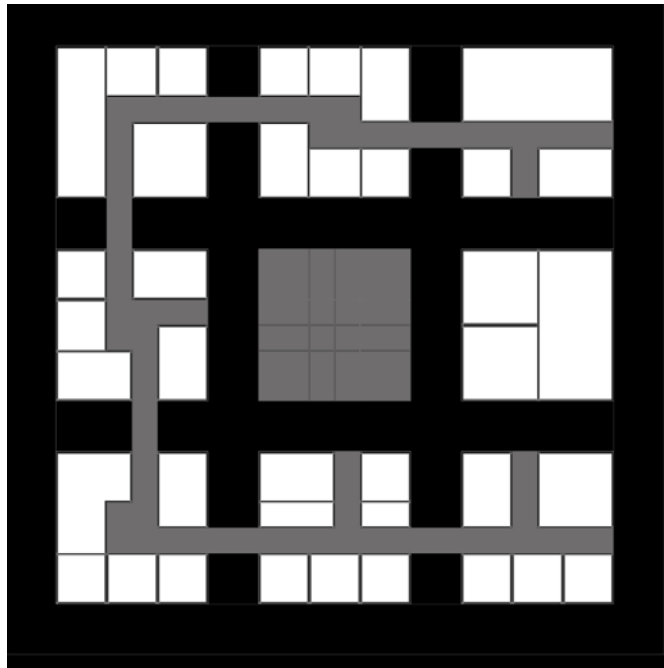
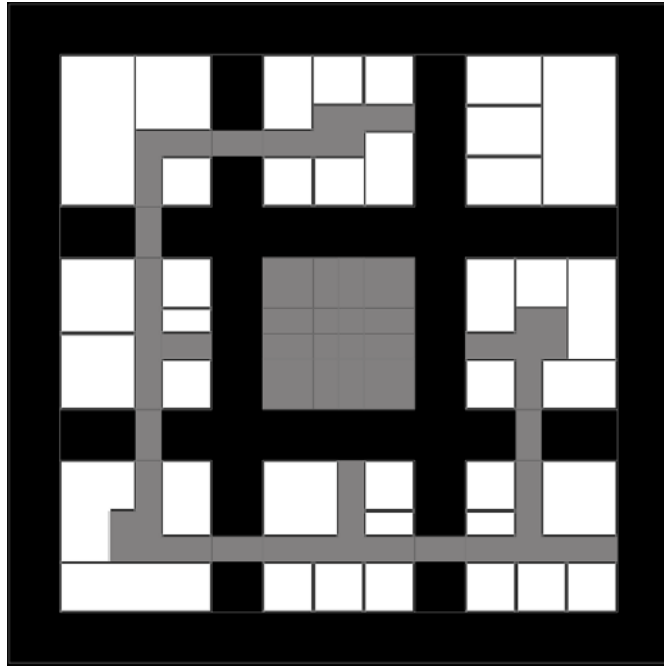

Initial schematic shop designs and possible  
apartment unit designs



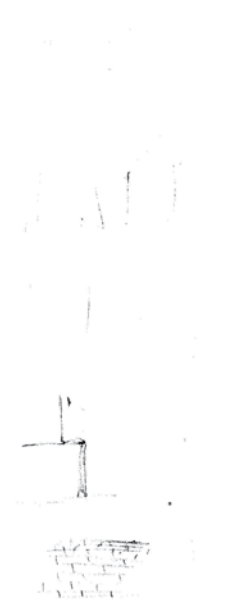
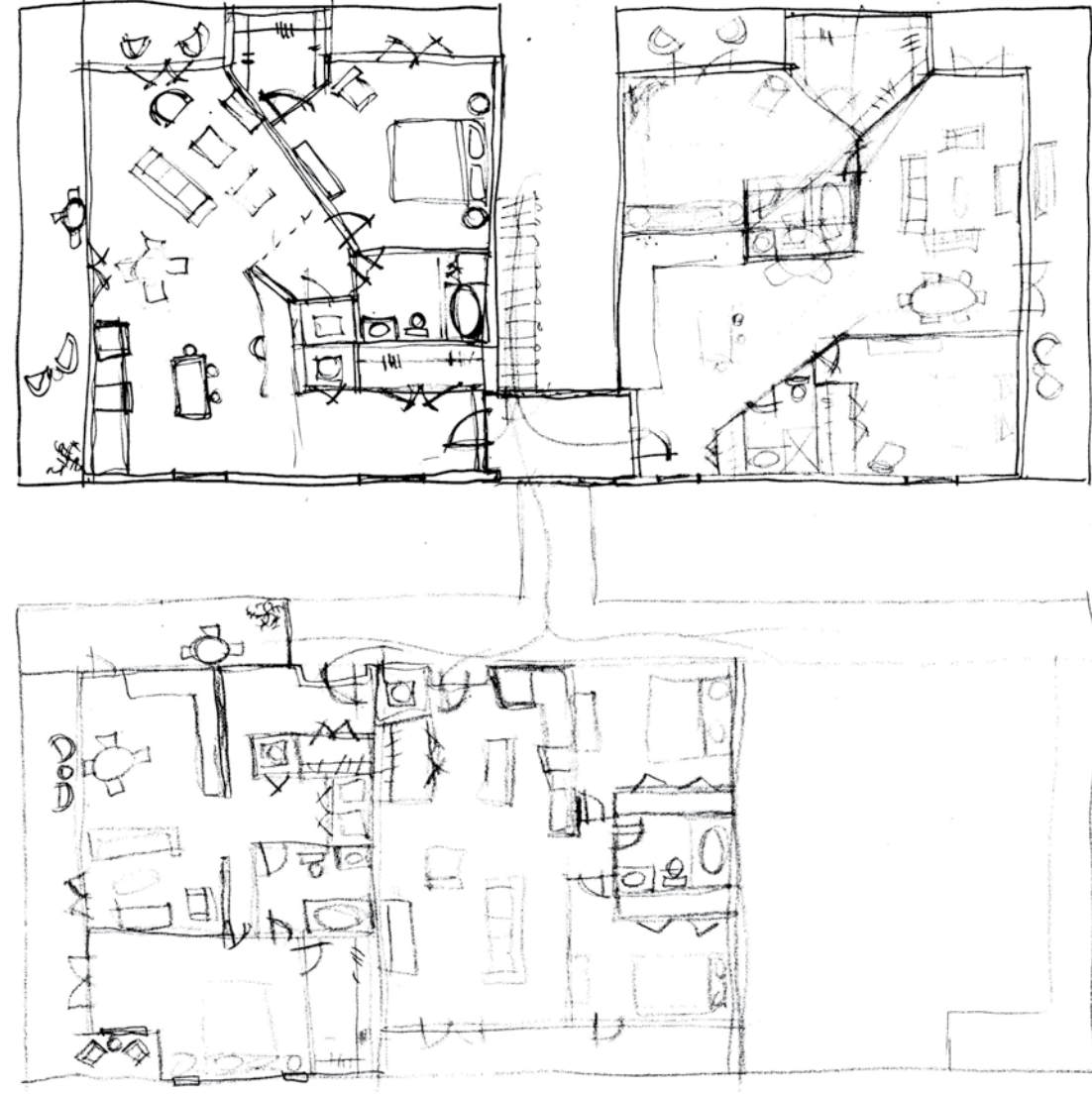
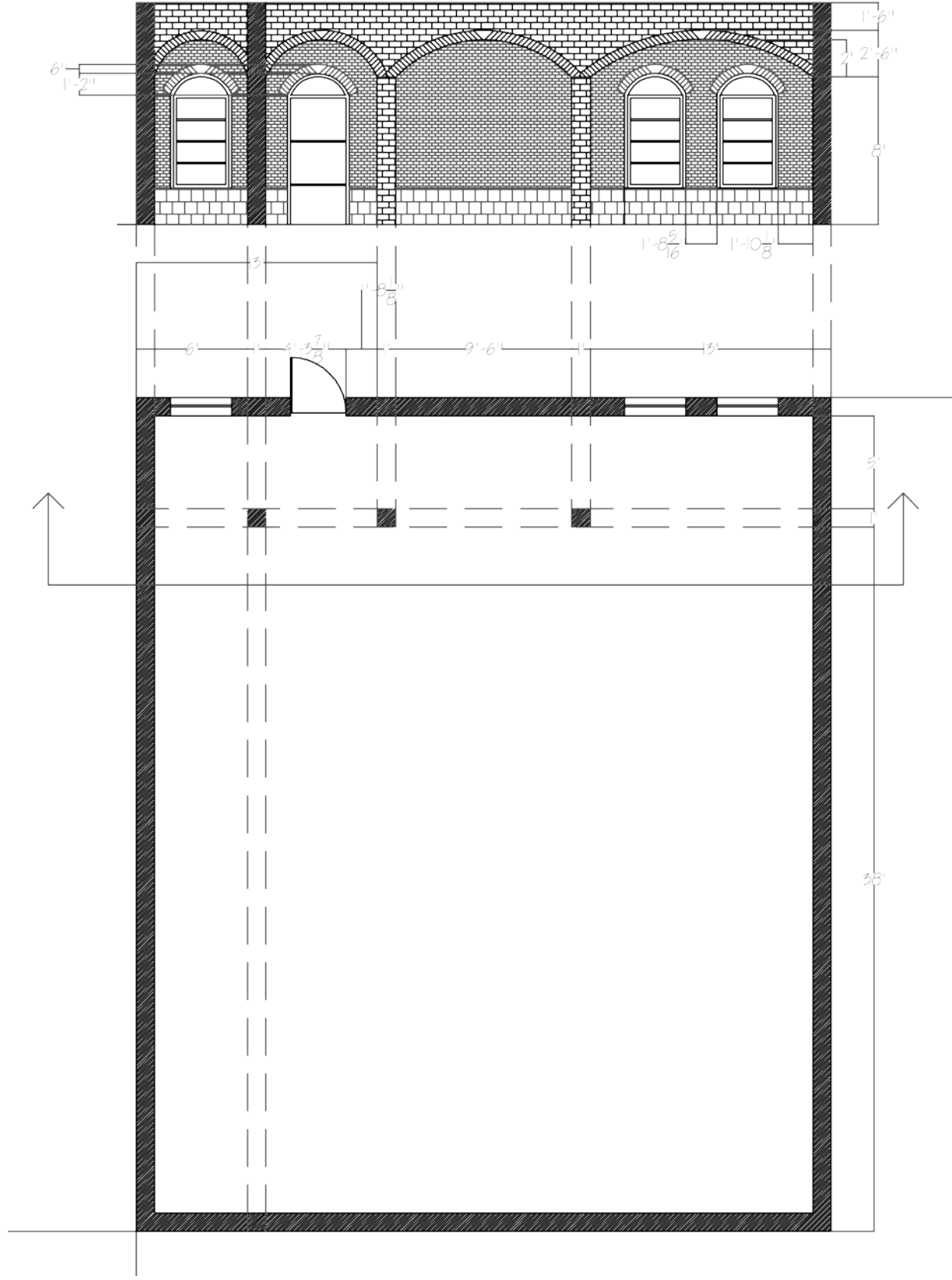

### The Urban Pond

The entire building is surrounded by a two-foot deep pool. Originally there was a retention pond on the site and a motel that was oriented in a similar way to the proposed shops. It was deemed important to keep a water element on the site. The urban pond idea stemmed from the geometry of the buildings and the idea of how water should exist in a city. It should not be an amorphous entity; rather it should be controlled and prescribed like its surroundings.

The pool has an infinity edge and drains below itself in order to keep it at its capacity at all times. It is designed to be frozen during winter months to support ice skating.

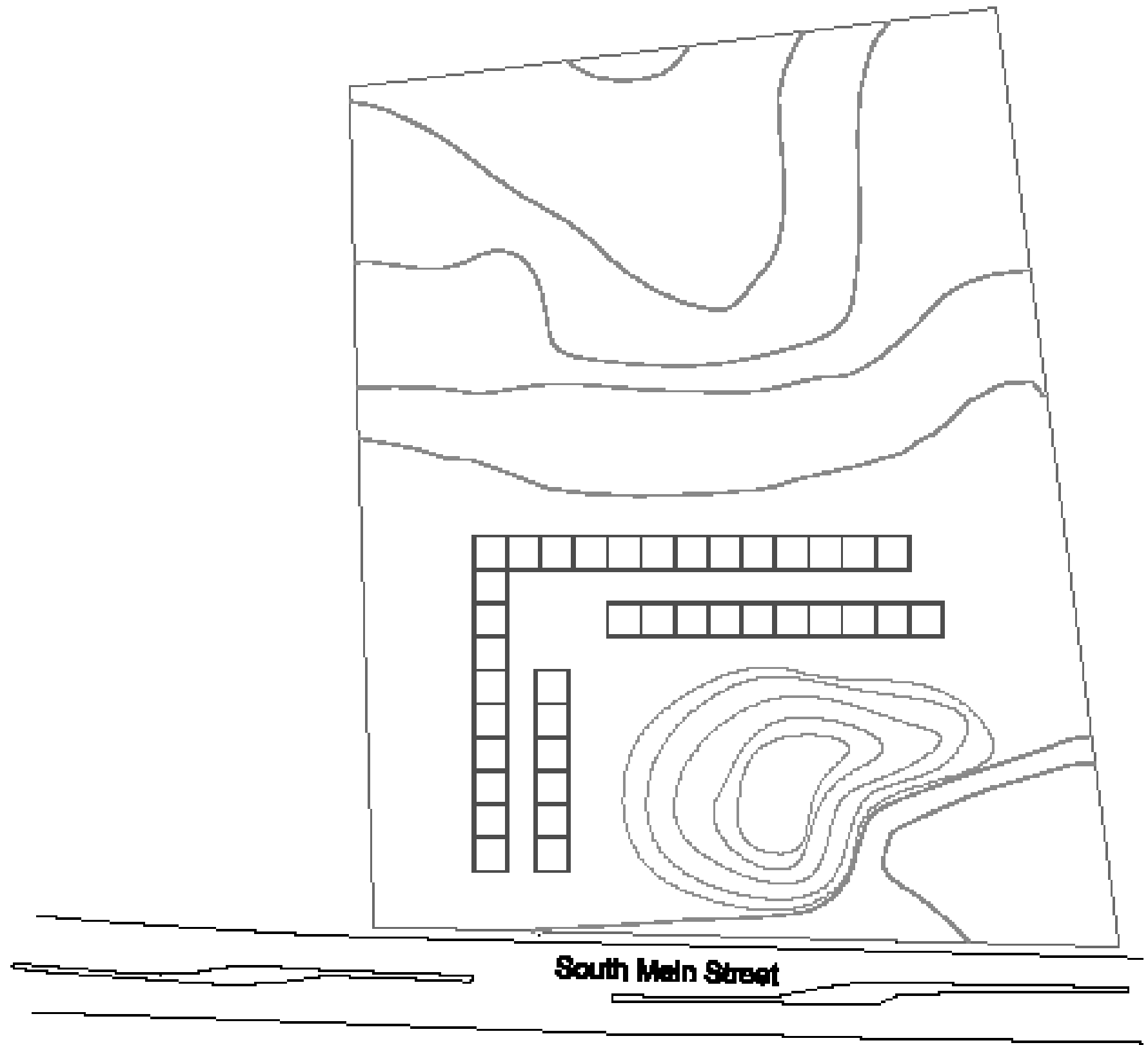



South Main Street

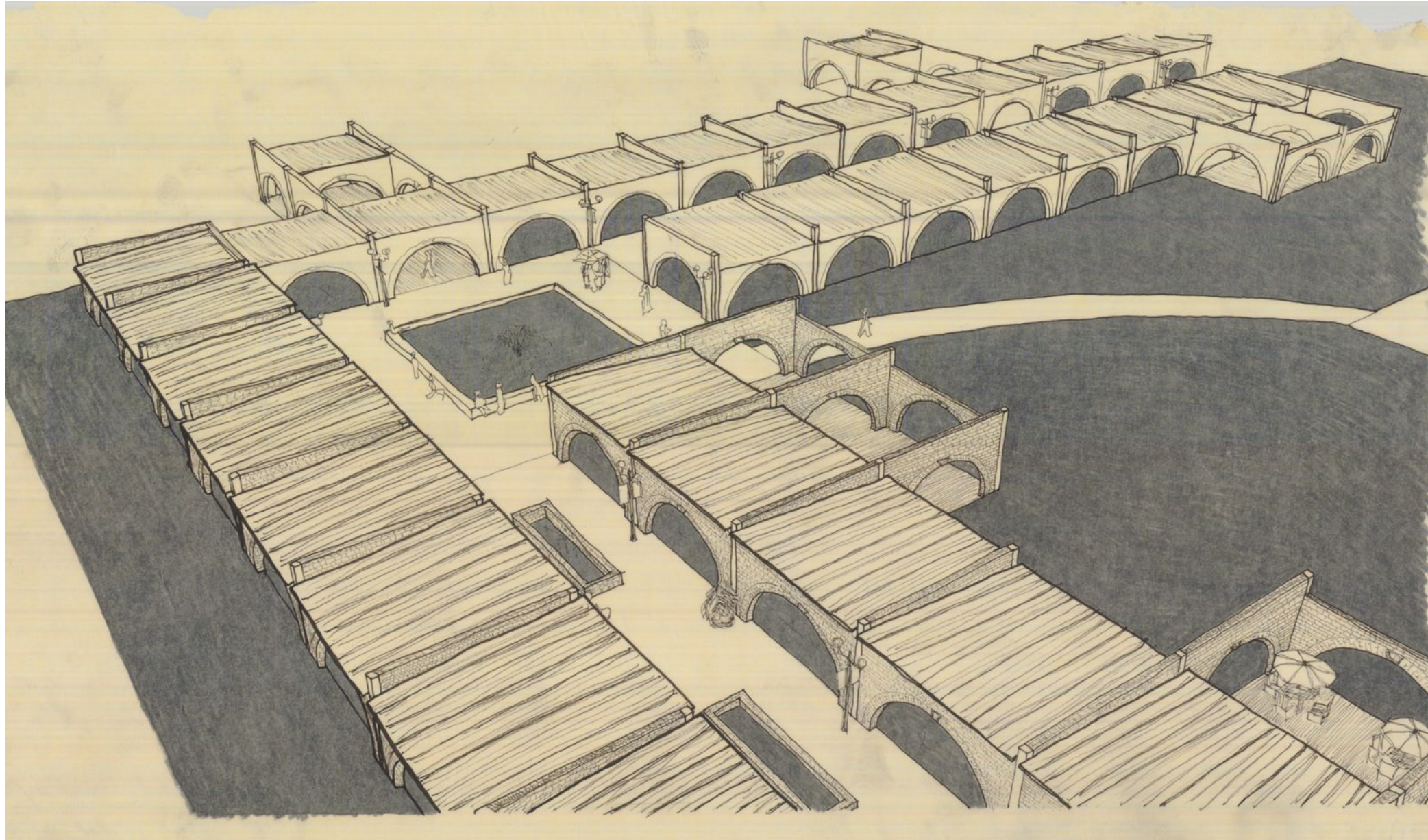

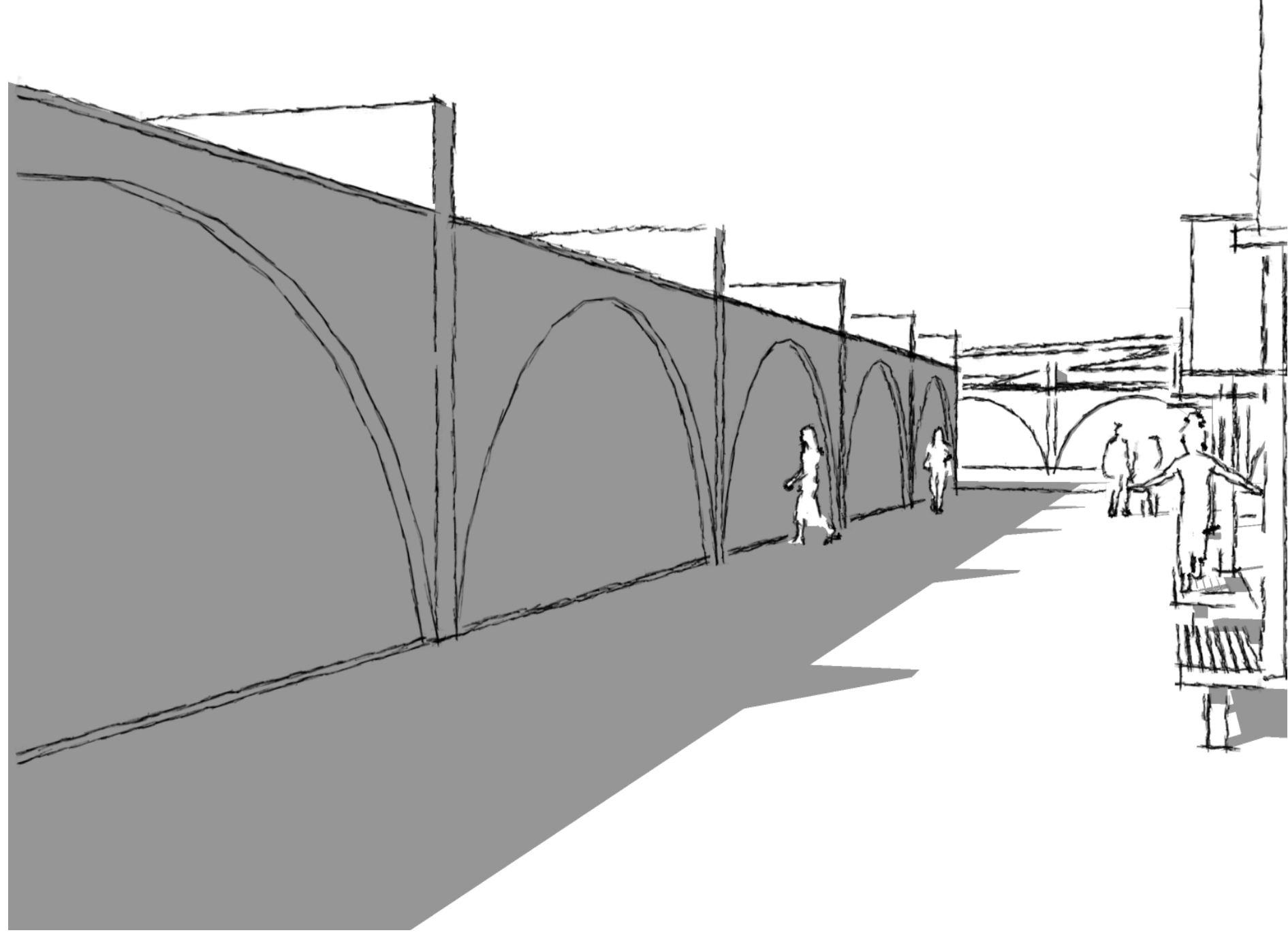

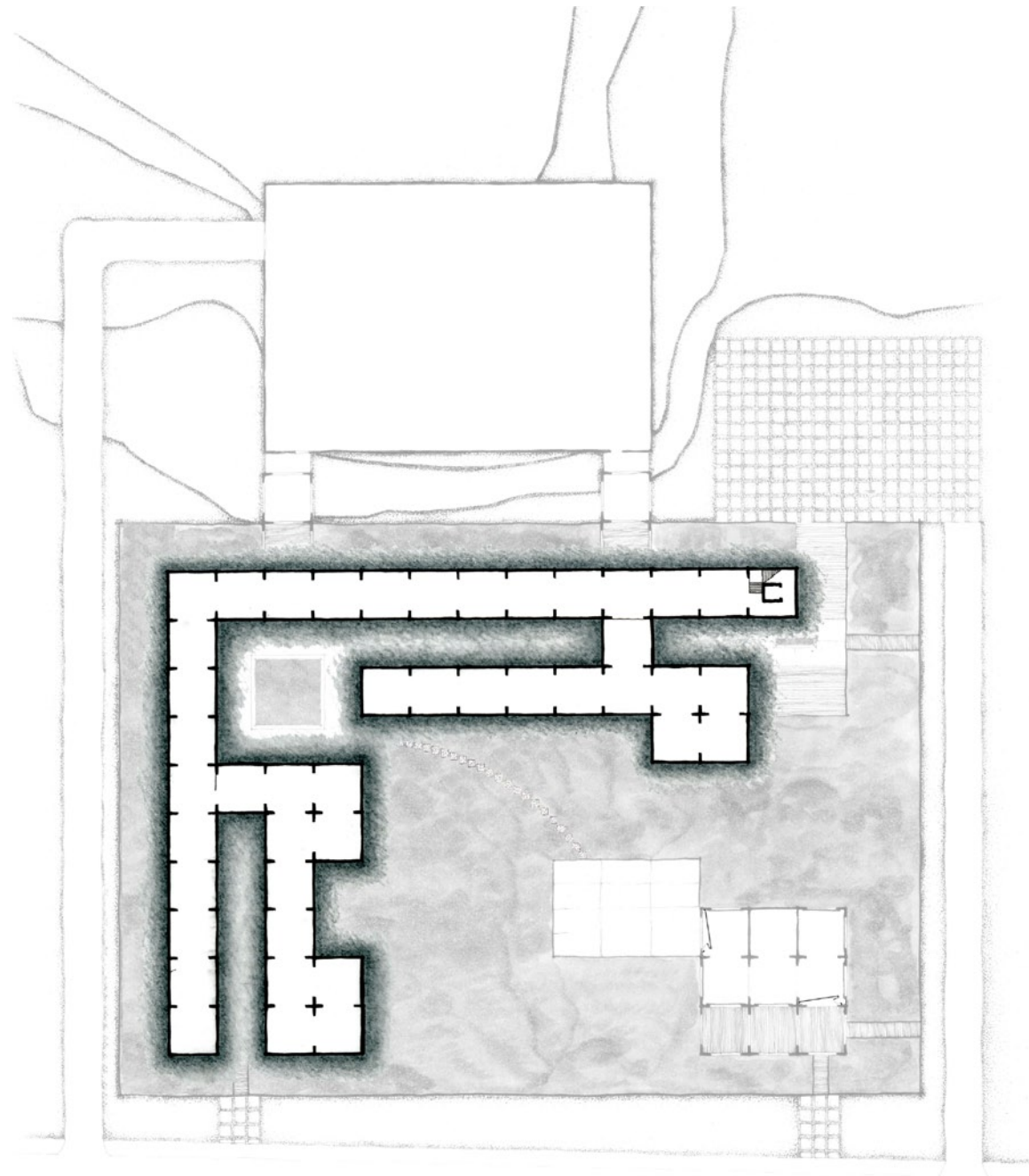

Basement Plan

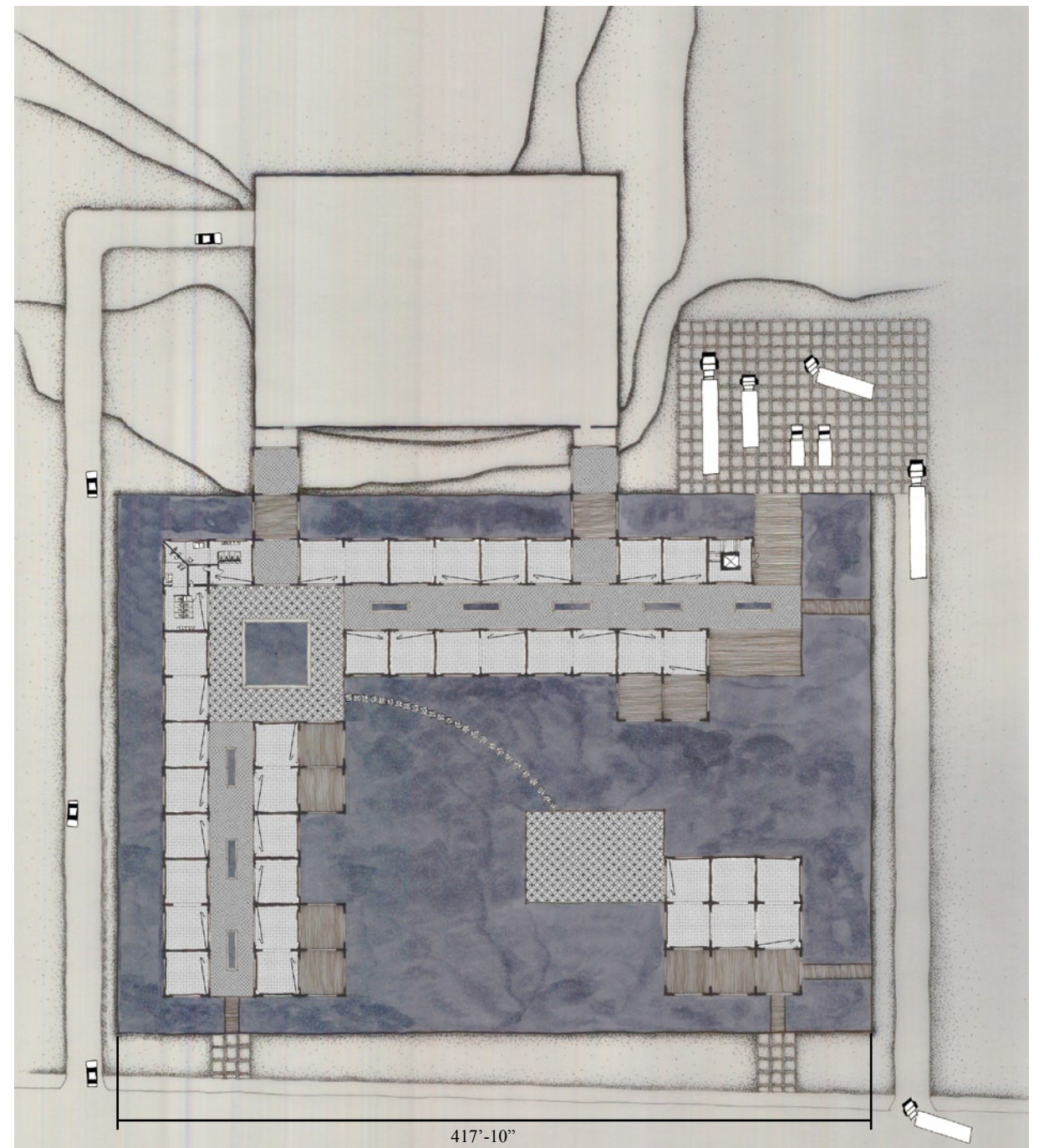

Main Level



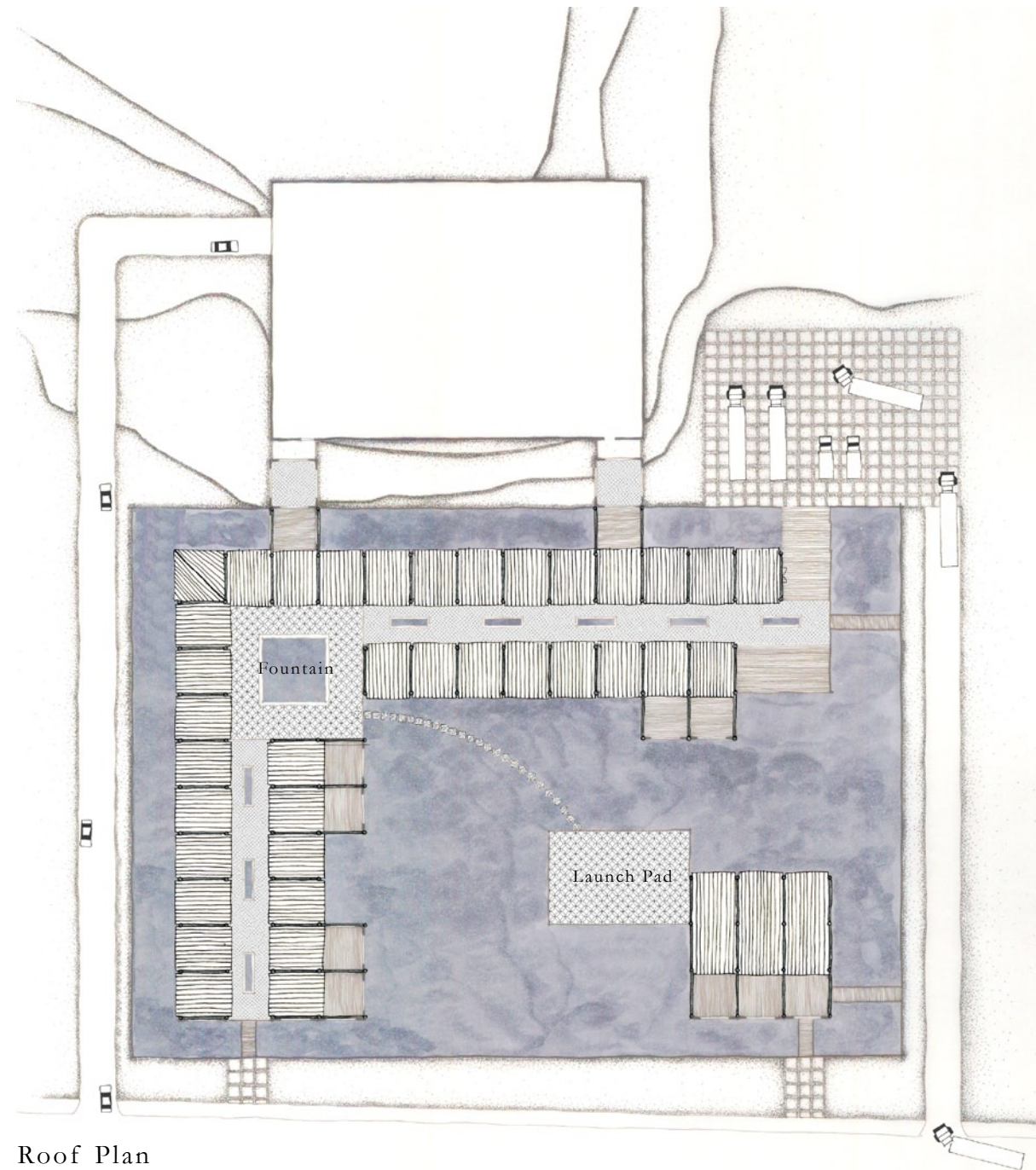

Roof Plan

The Basement Plan  
 -Houses electrical/mechanical systems and provides storage for shops.

The Main Level  
 -Retail level

The Roof Plan  
 -Roofs are copper standing-seam metal.

The Fountain  
 -Central location for interaction with the water.

The Launch Pad  
 -Multifunctional space for vendors, performing arts, fairs, private parties, etc.

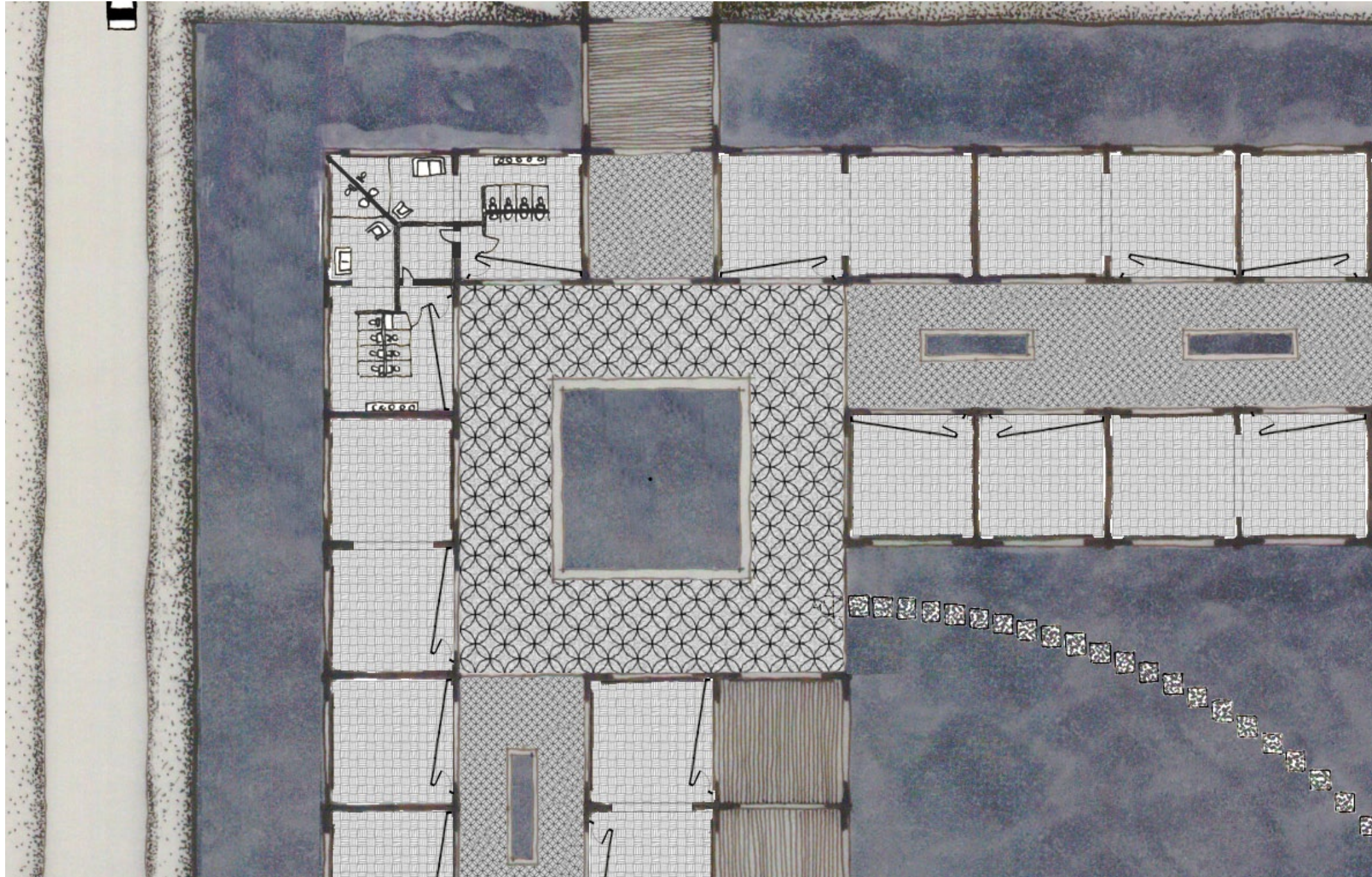

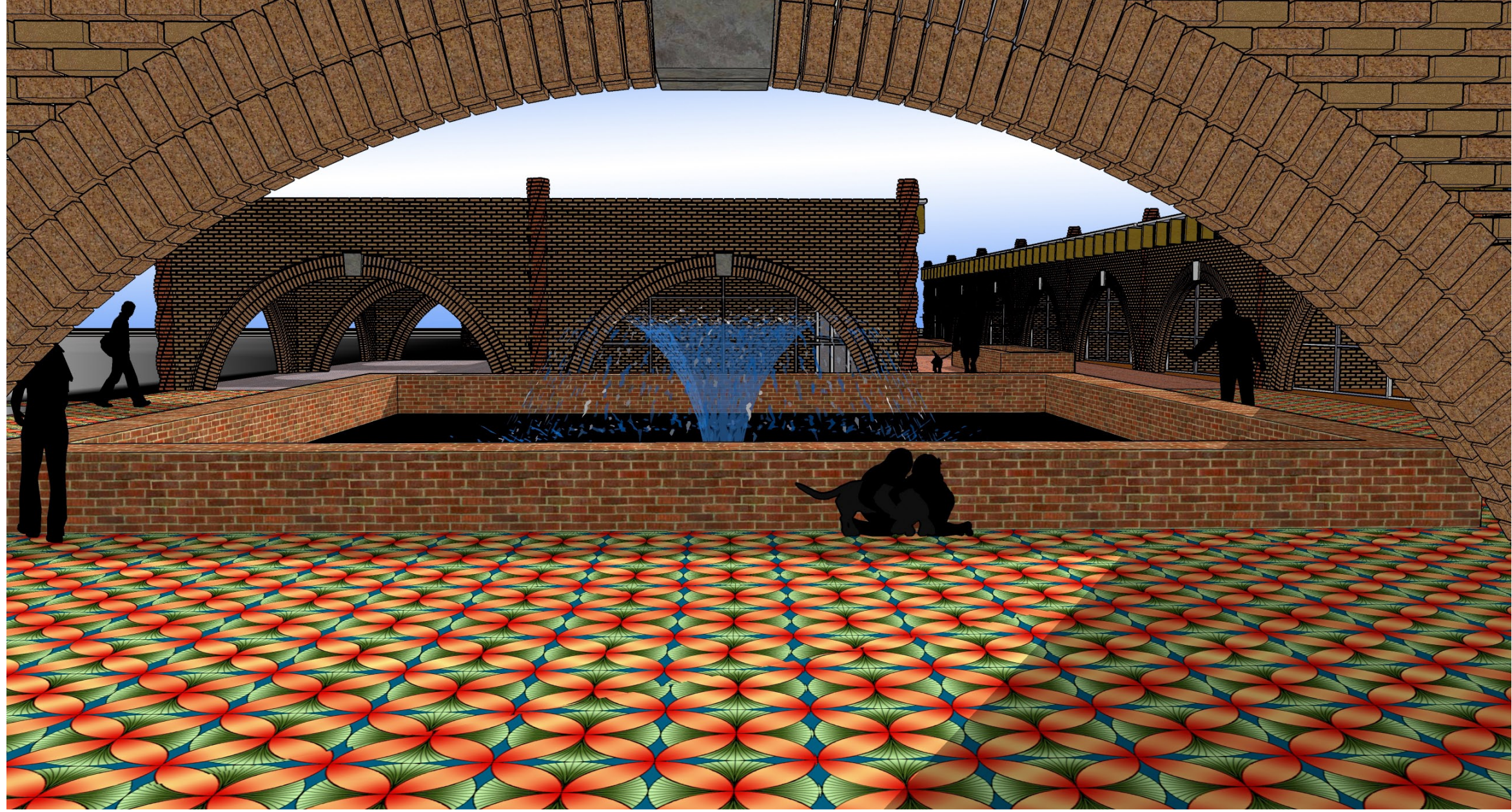

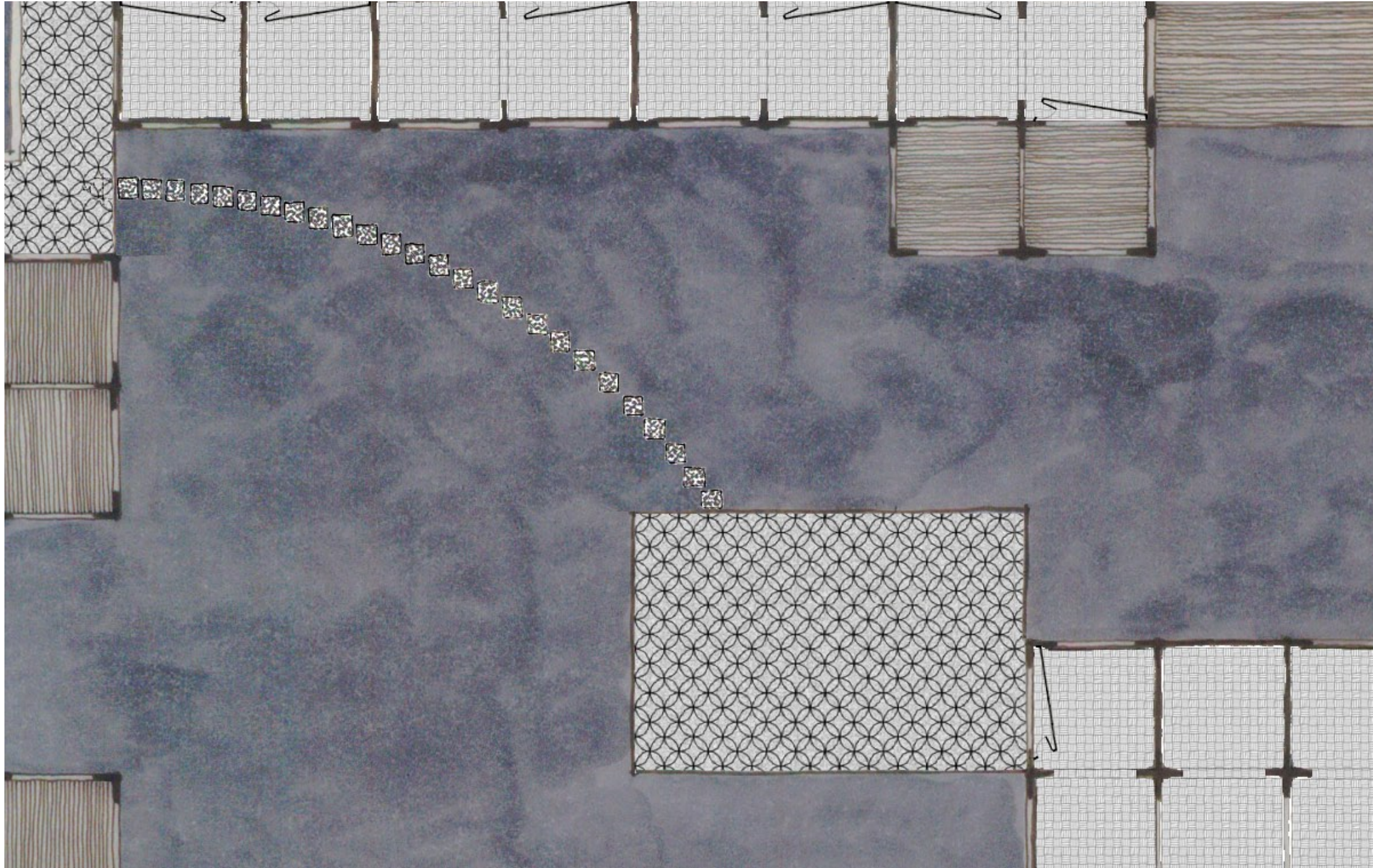

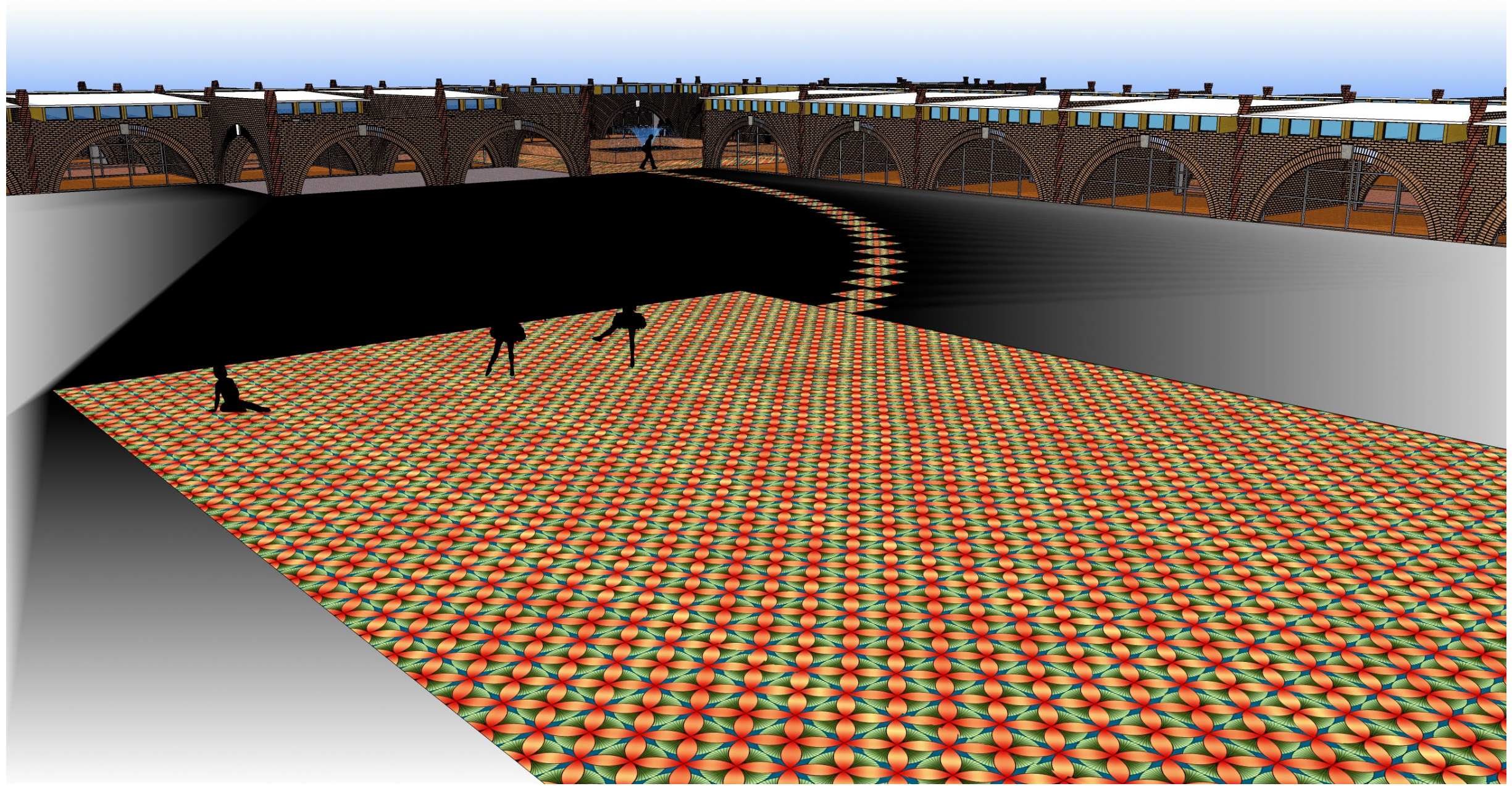

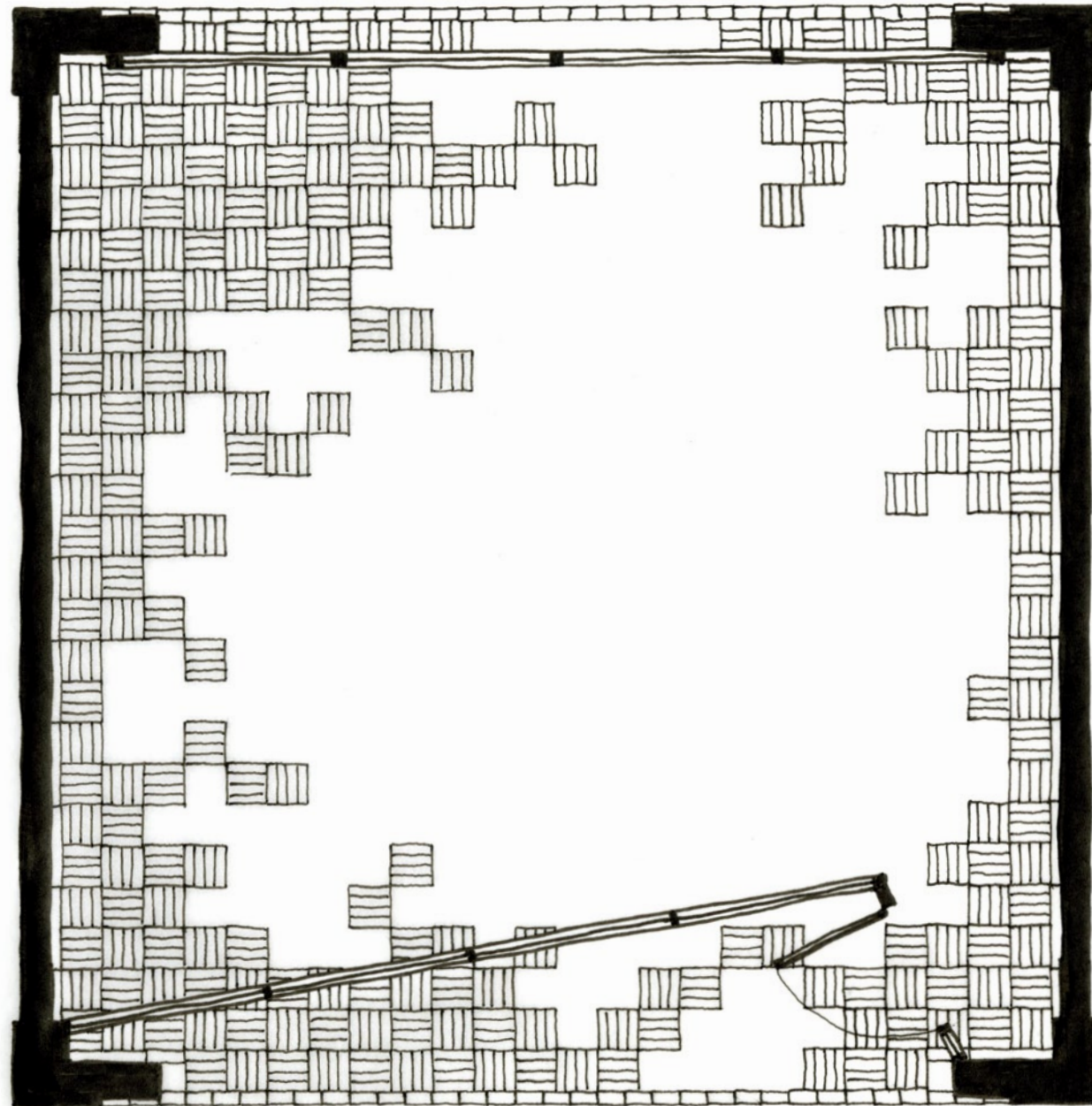

Shop Parquet Floor Pattern

### Flooring

- Designed to be a transition between spaces.
- wood decking: crossing over water
- brick paving: space between shops
- ceramic tile: outdoor points of interest
- parquet: inside shops
- concrete pavers: over grassy areas

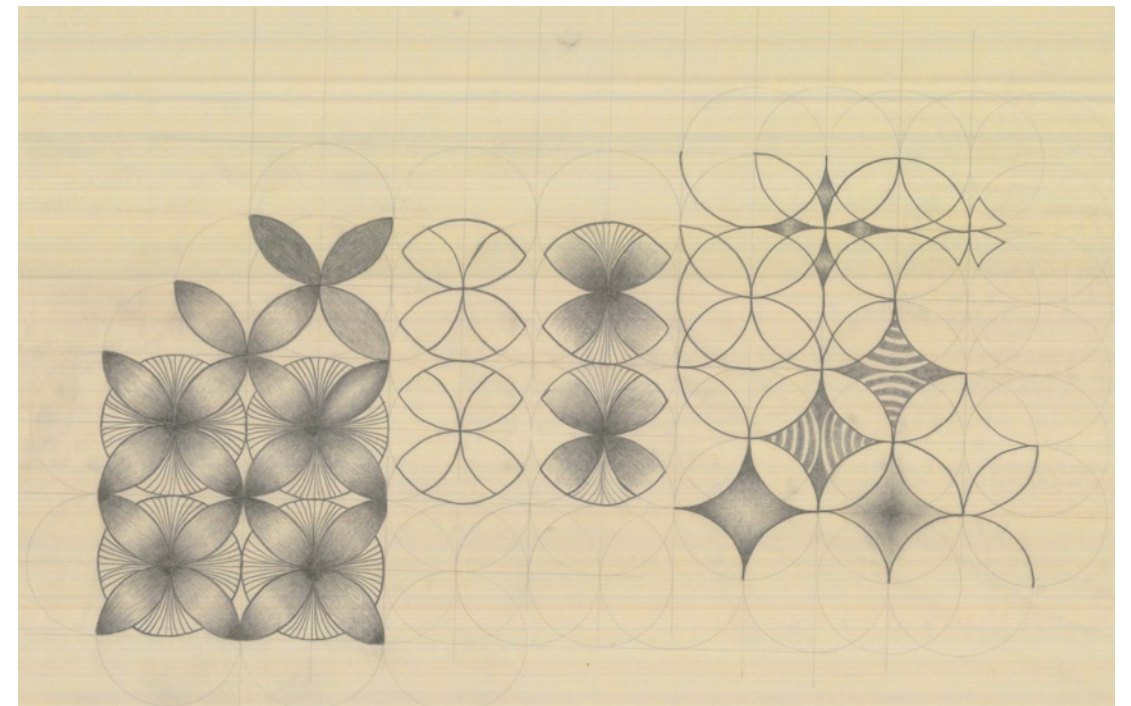

Sketch for Tile and Brick Paving Pattern

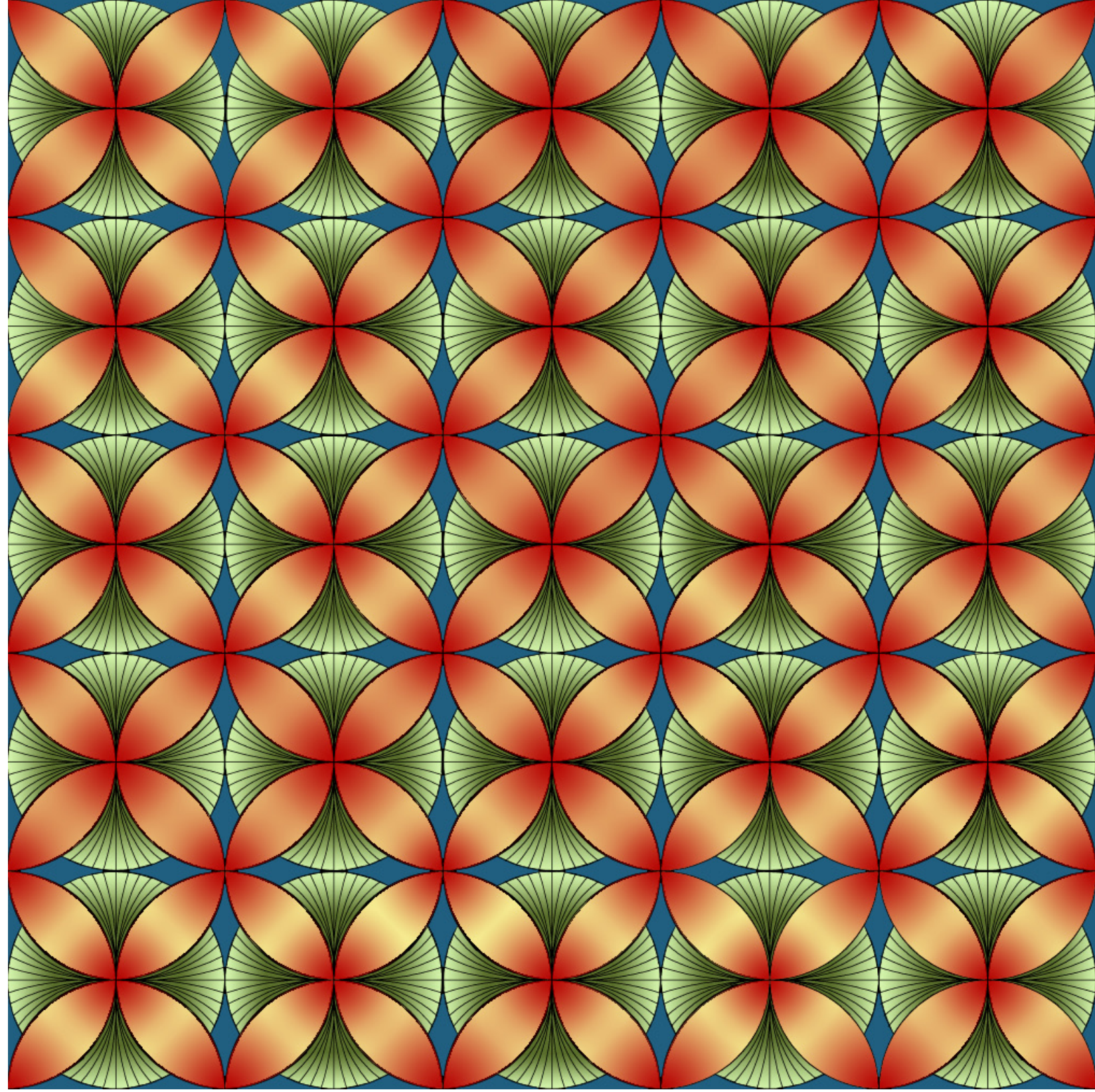

Ceramic Tile Pattern

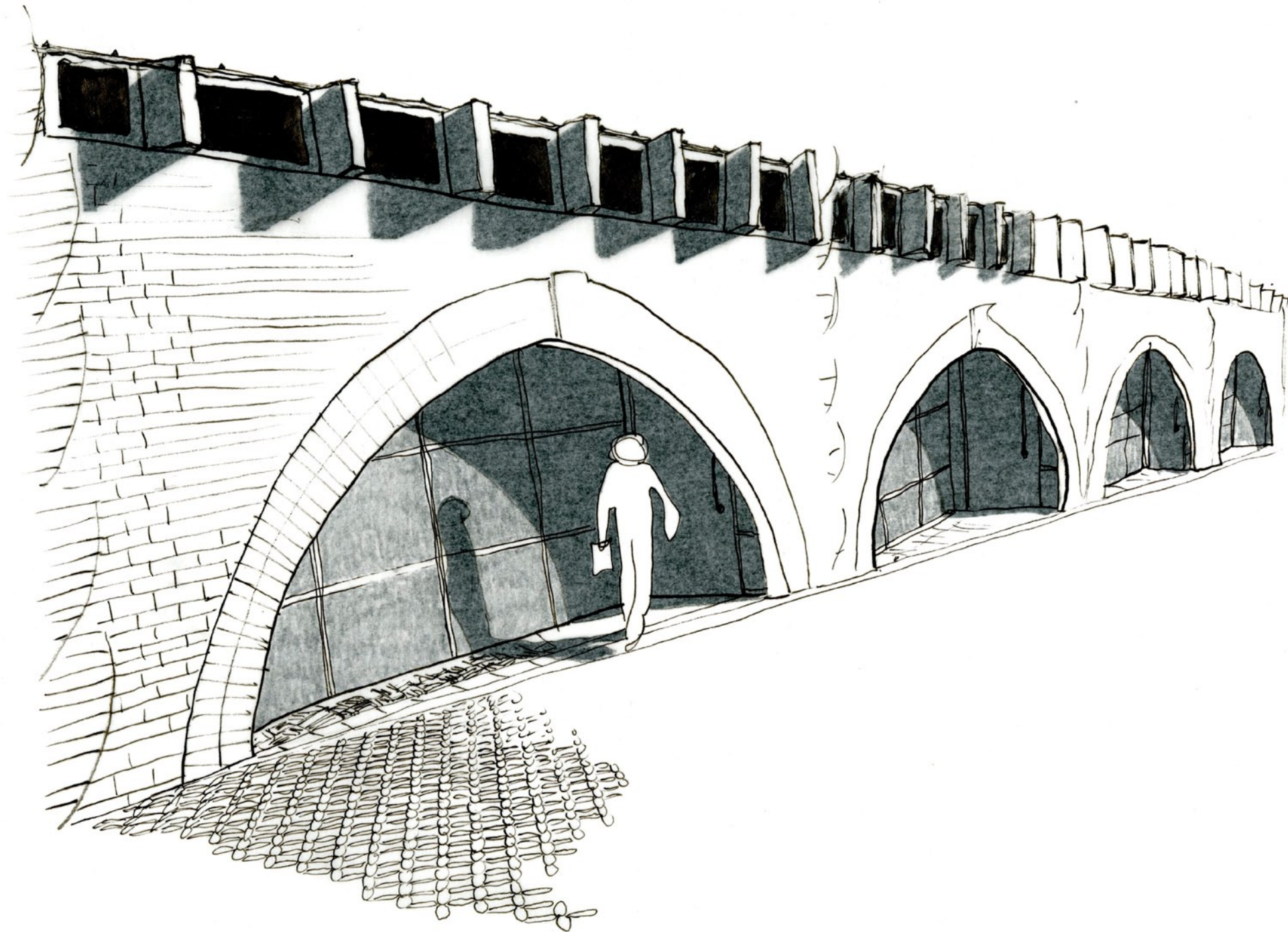



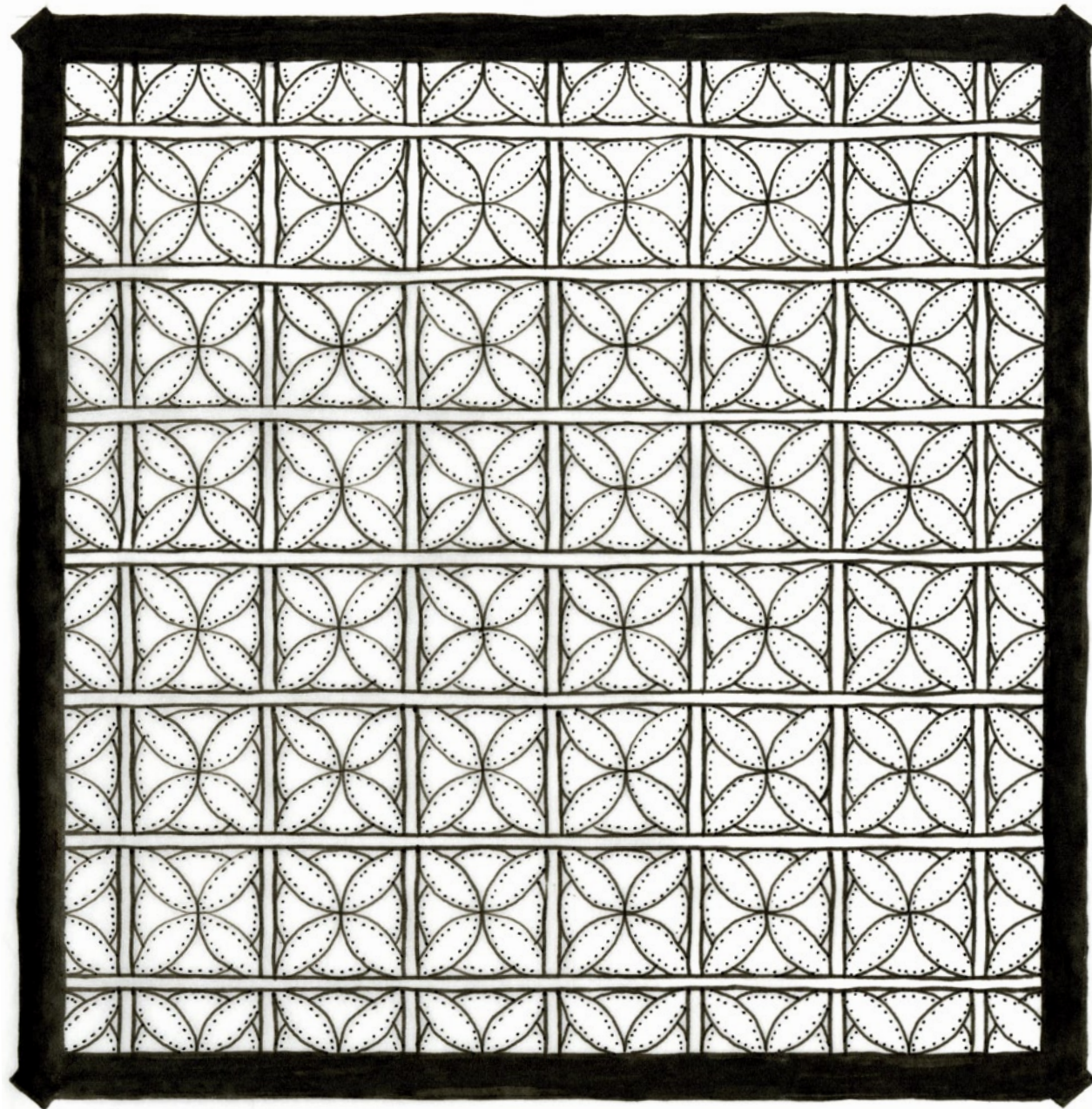

Ceiling Plan

#### Ceiling Plan

- Copper panels riveted to plywood sheathing.
- Reflects paving pattern in brick and tile.

#### Modular Shops

- Easy to adapt for multiple uses.
- Business owners can use one or more modules connecting.
- There is a bricked-up arch in the joining wall between each shop. The brick within the arch can be removed, leaving the arched opening, to join two or more shops.

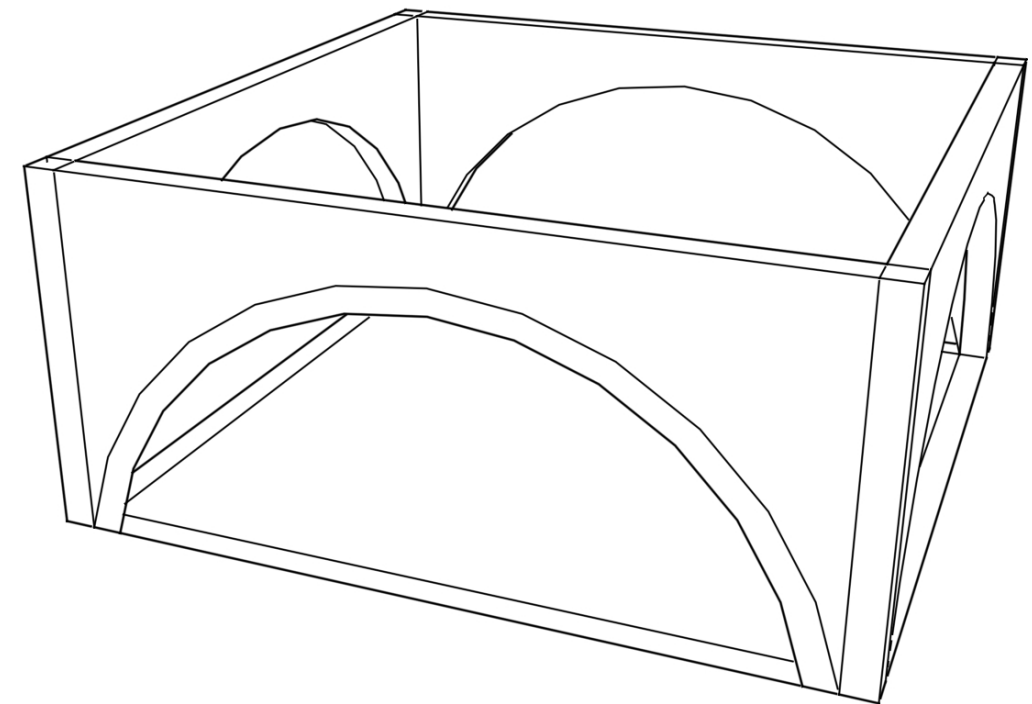

Modular Shop Diagram

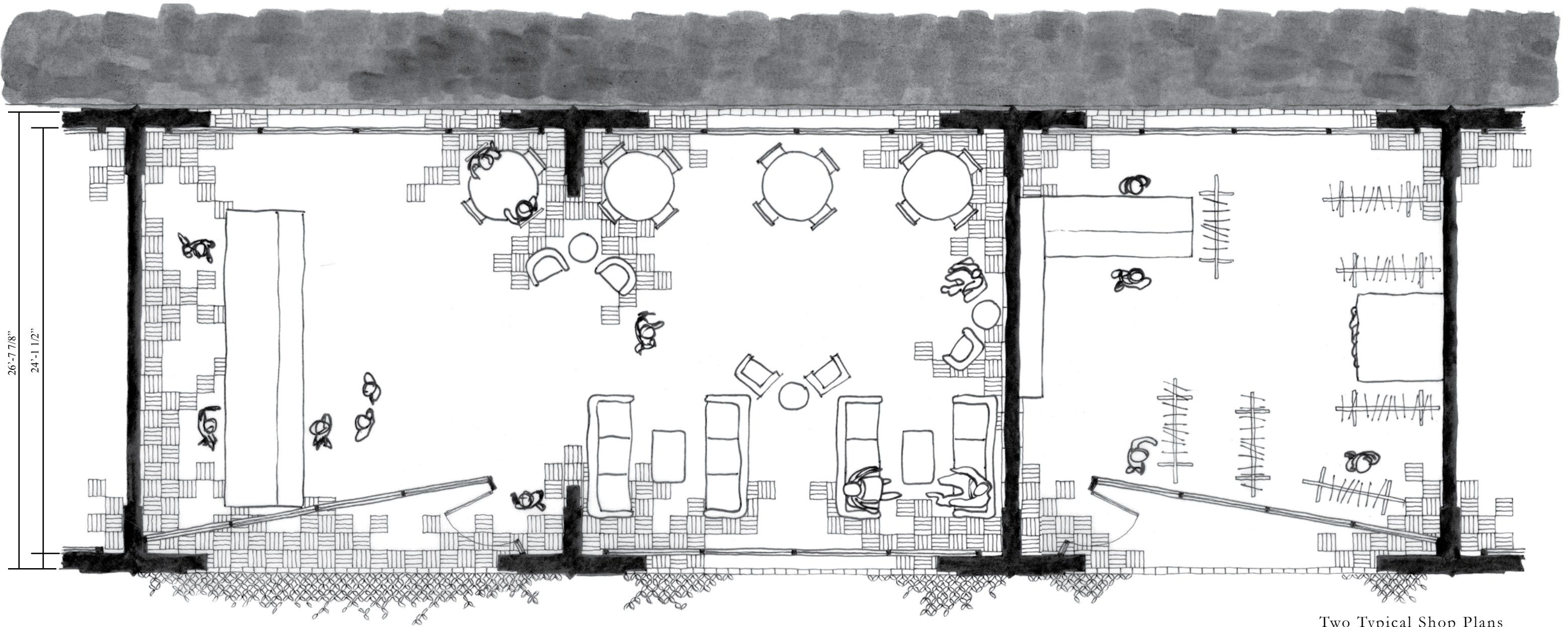

Two Typical Shop Plans

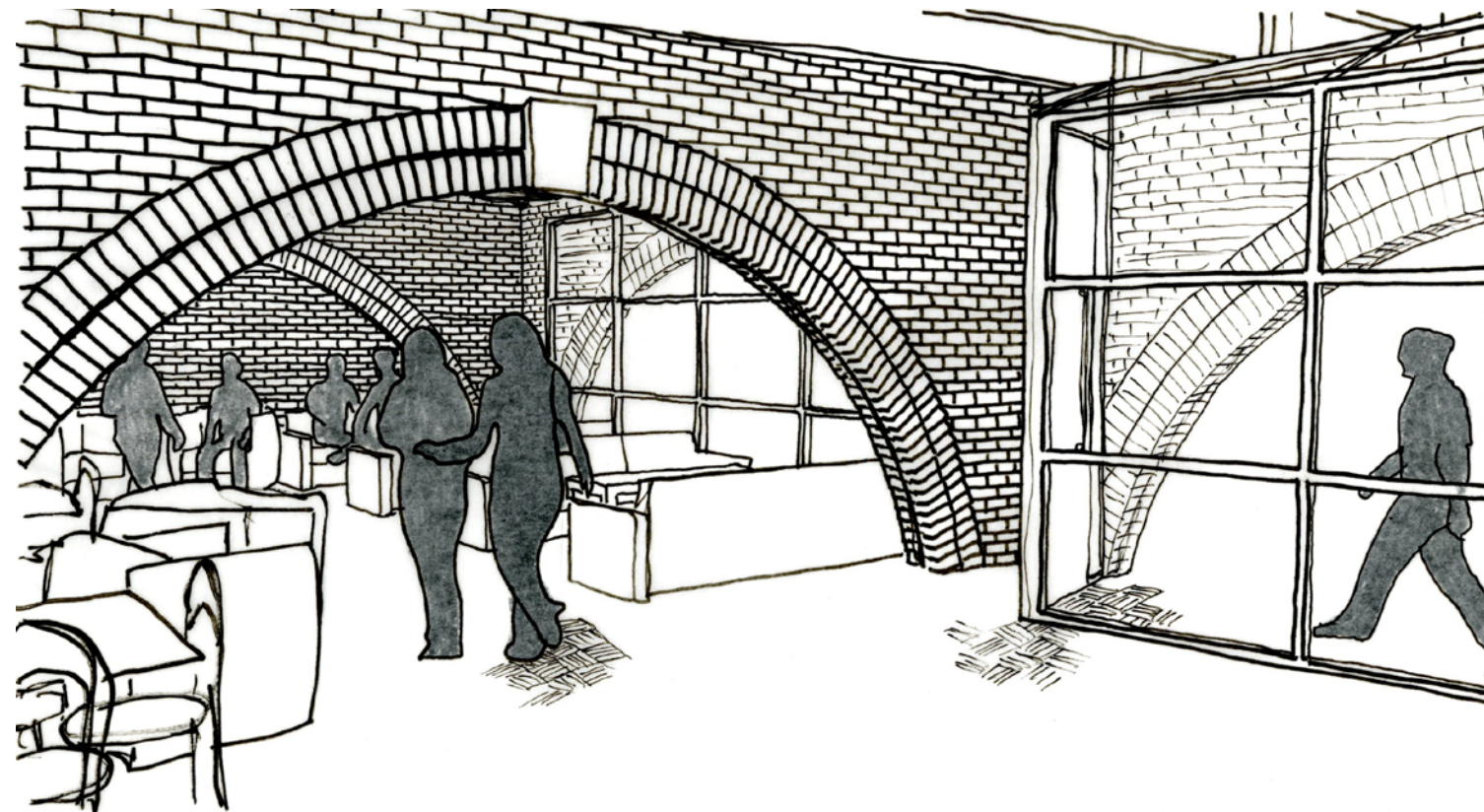

### Brick as a Building Material

- Relates to vernacular of Blacksburg and this part of the country.
- Structure of the arch allows for large opening for retail store-front glass.
- Shape and size of brick determines size in units of entire project.

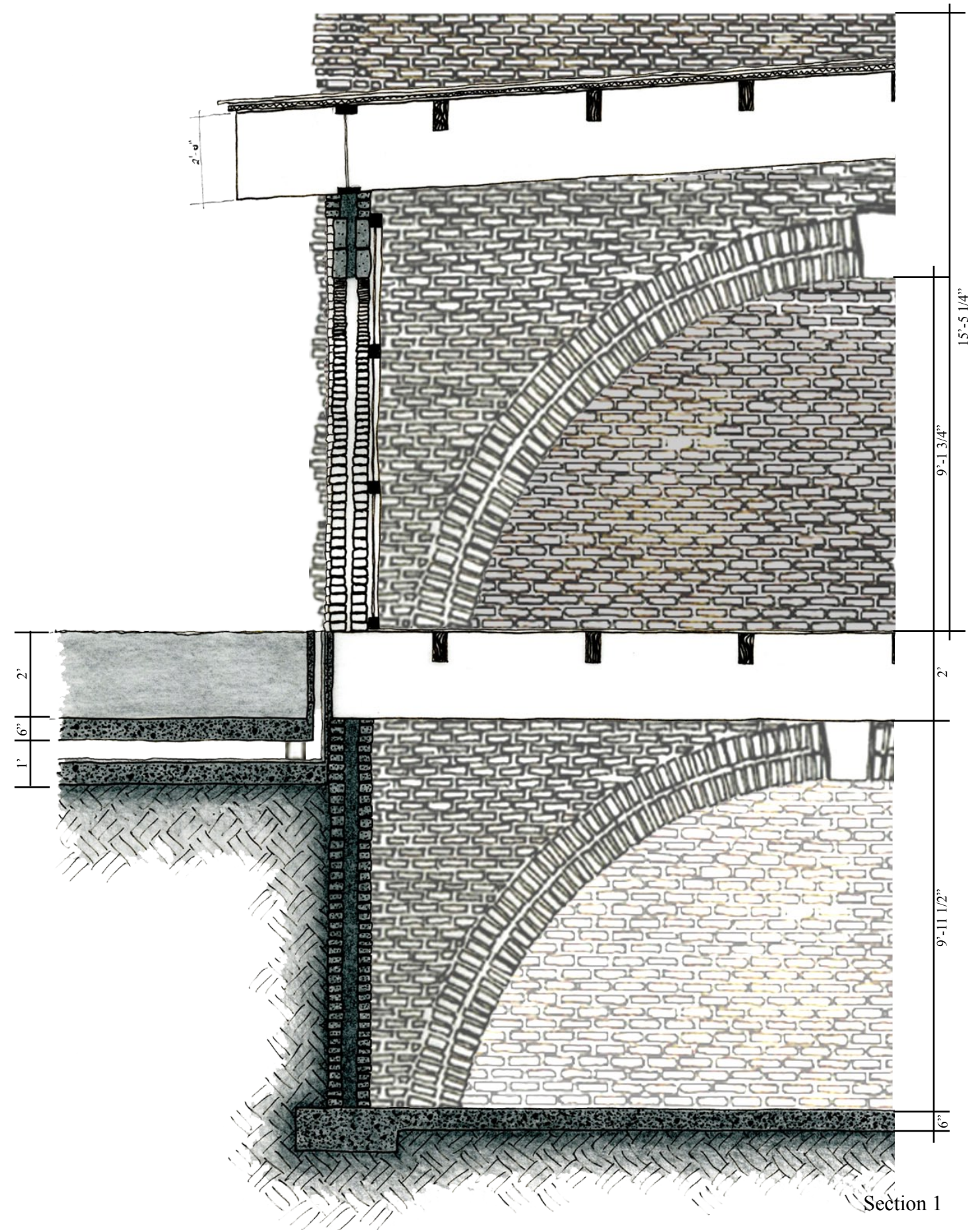
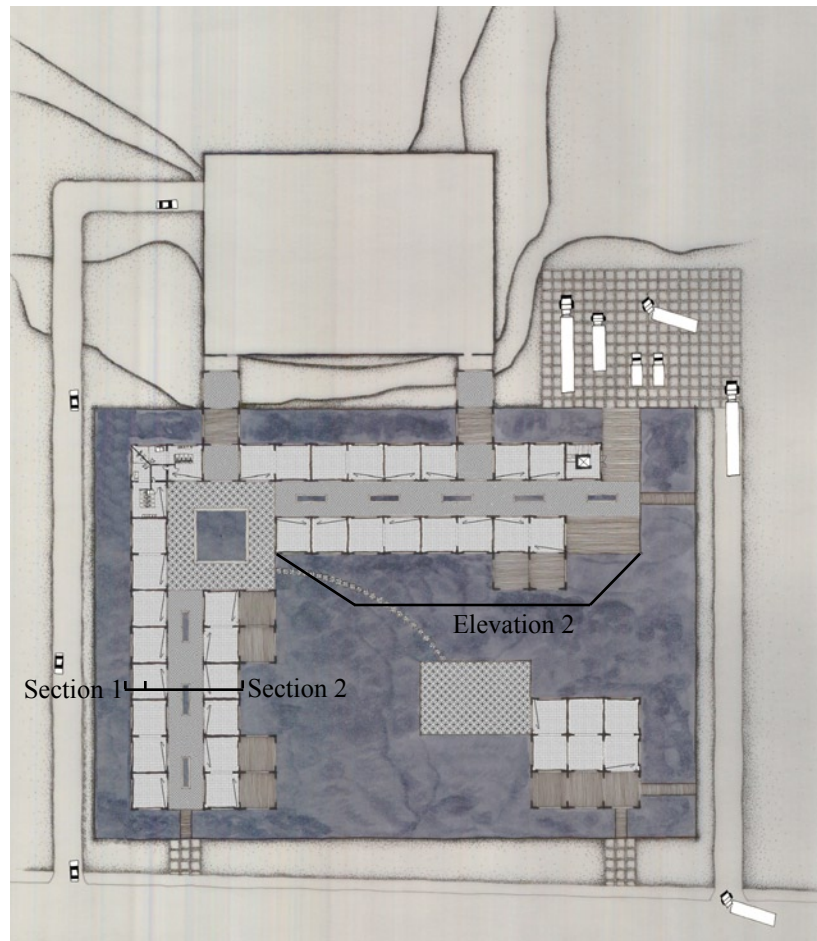

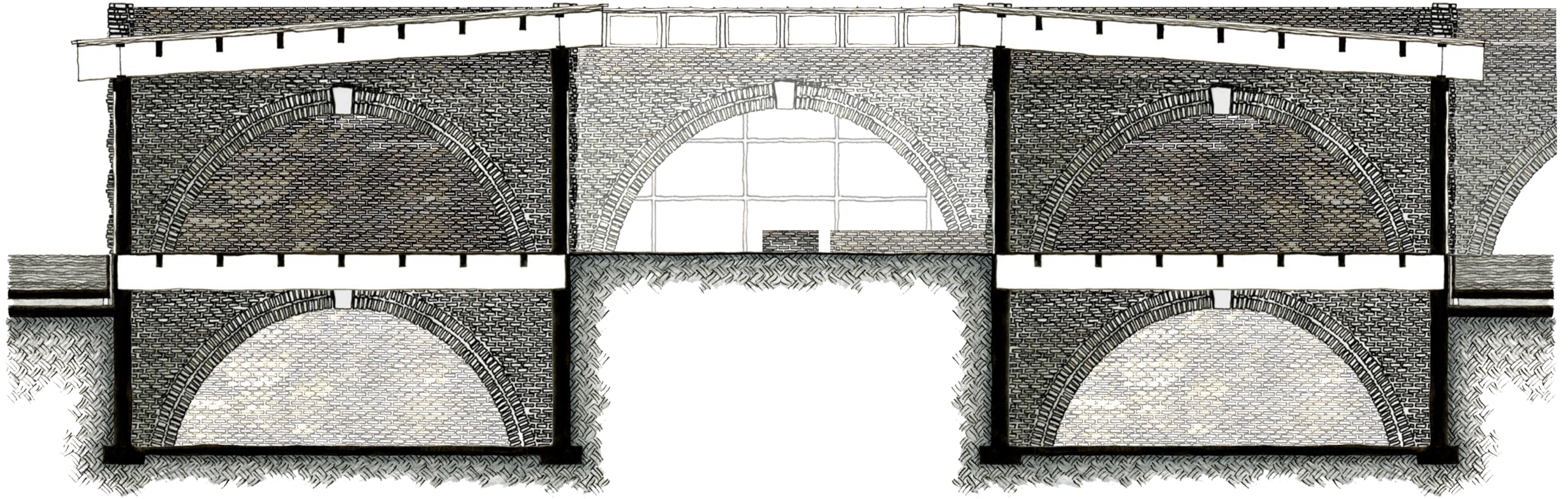

Section 2

Catalan Column

- Brick twists 10 degrees at each coursing.
- Forms distinct divide between shops.

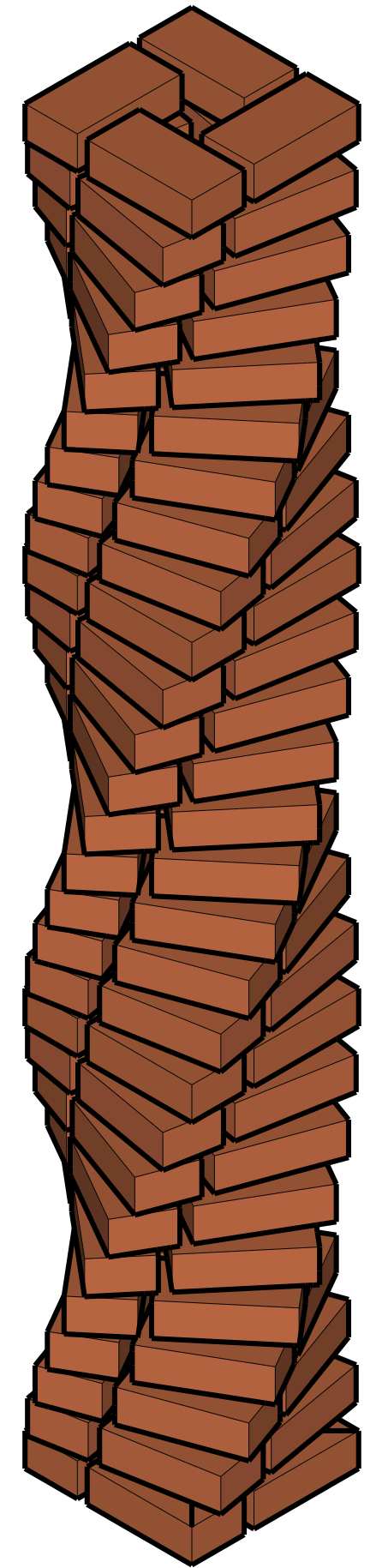
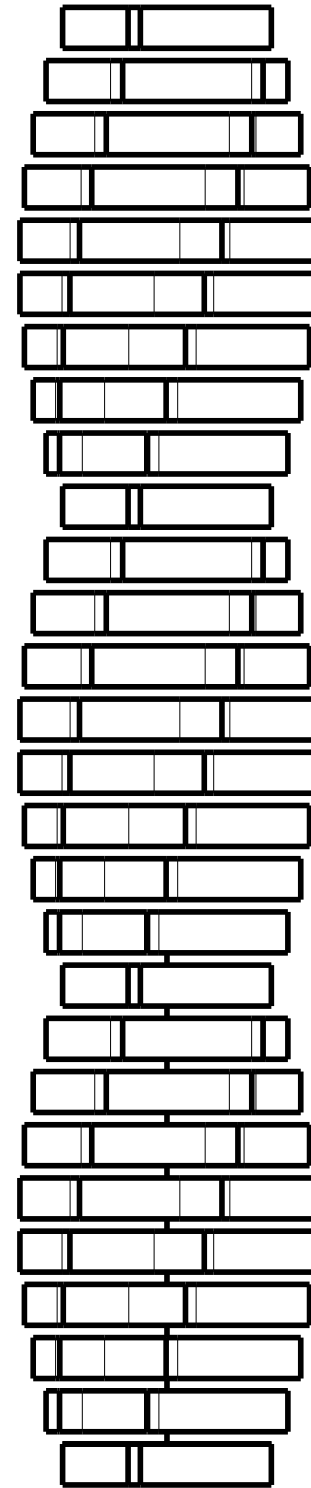
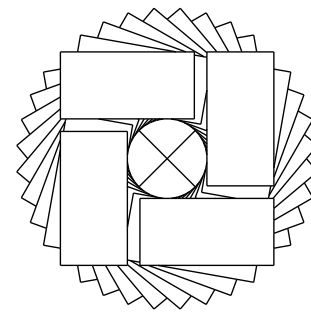

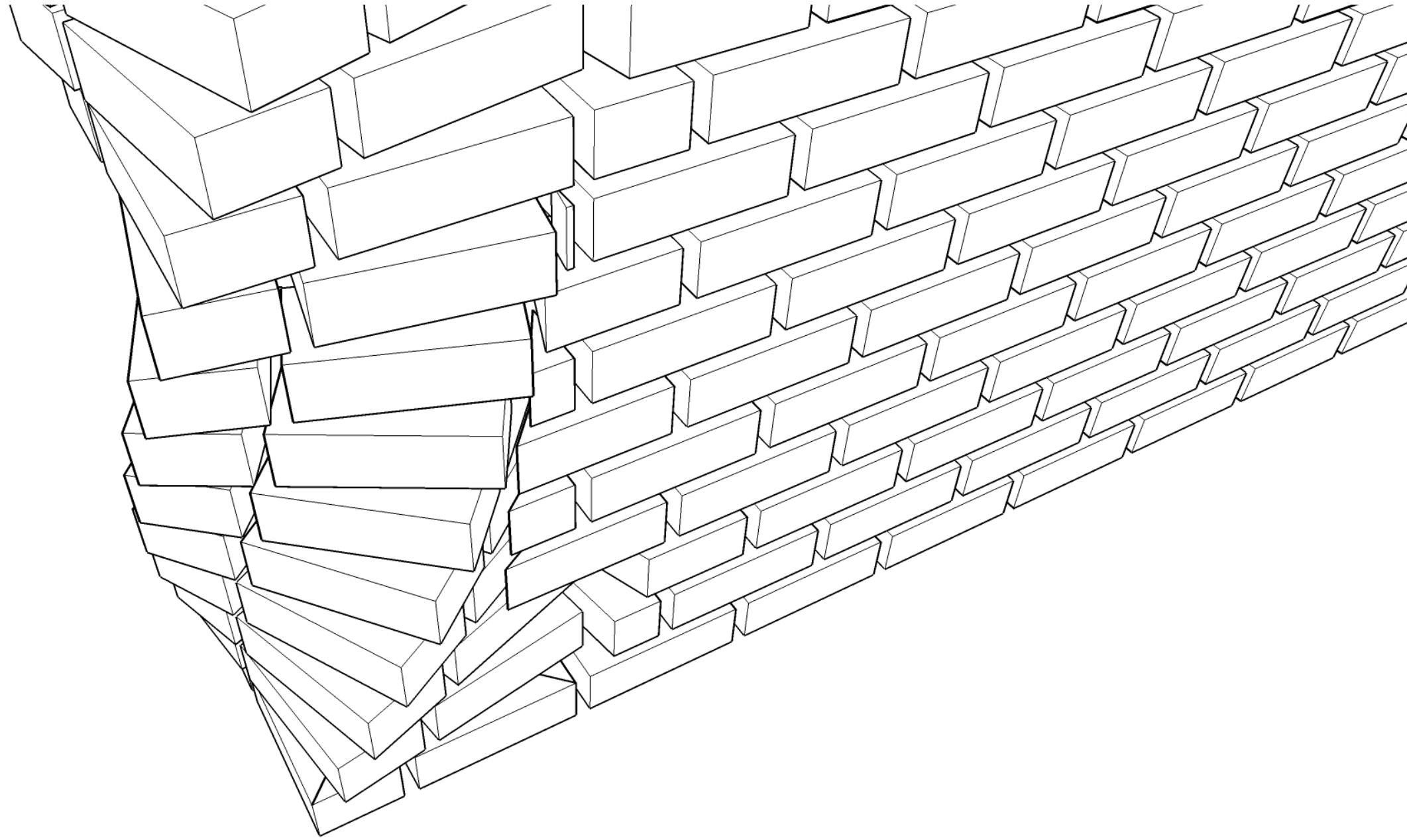

Brick Placement Diagram

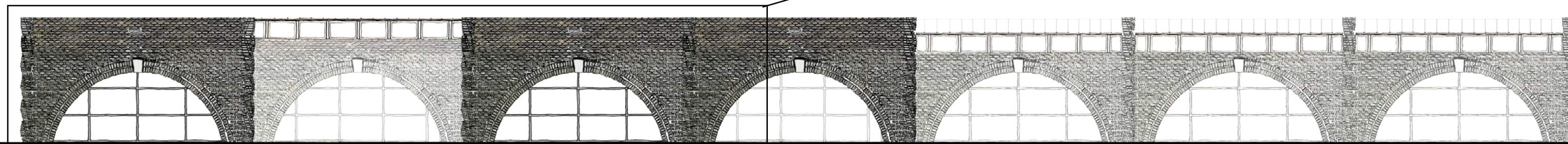
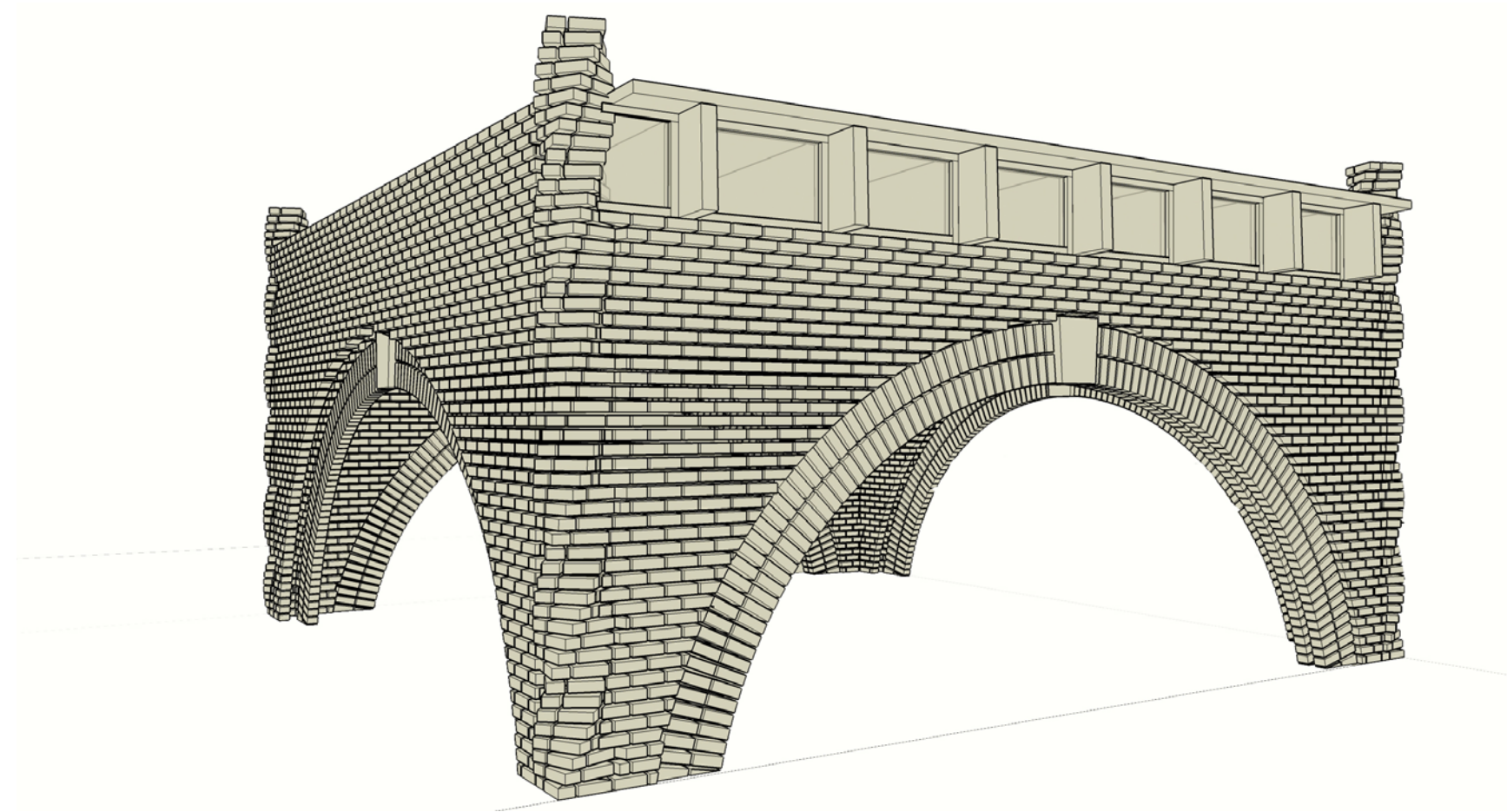



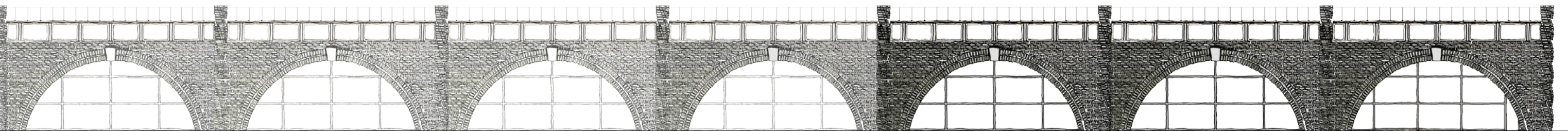
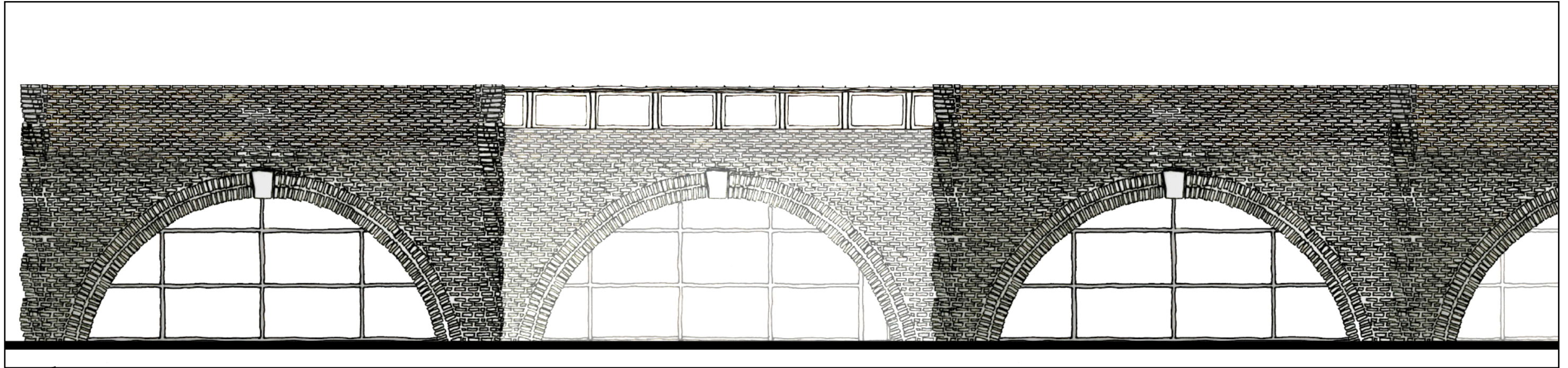

This design creates more than just another place to shop; it becomes a place to enjoy. It provides a place to showcase local events and activities, ice skating in the winter, and the only place in Blacksburg where you can eat and look out at a waterscape. This project is an exploration into how architecture can provide the opportunity to make a good idea work. Consumers are not opposed to “one-stop-shopping”; the design is what requires a makeover.

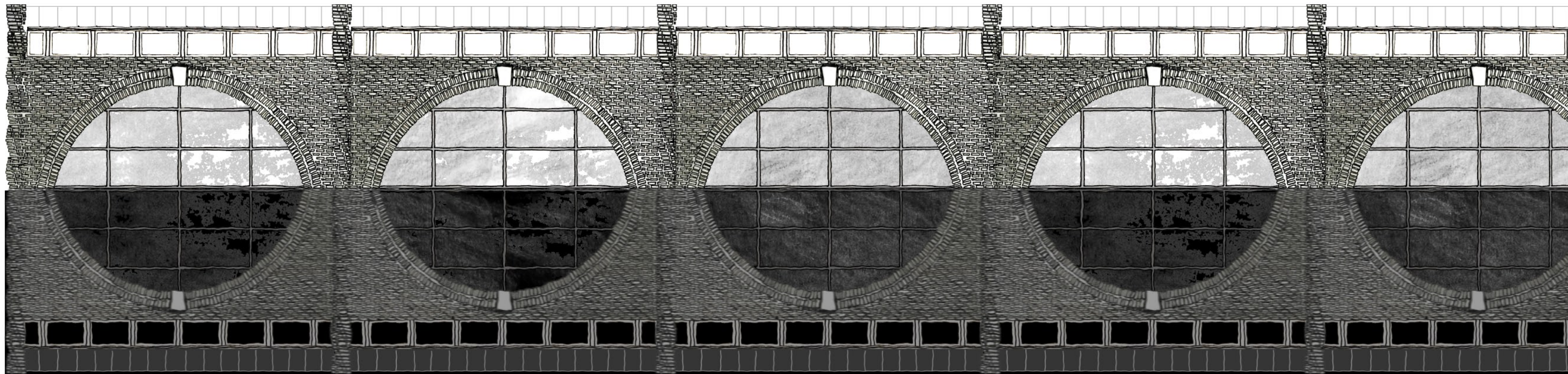

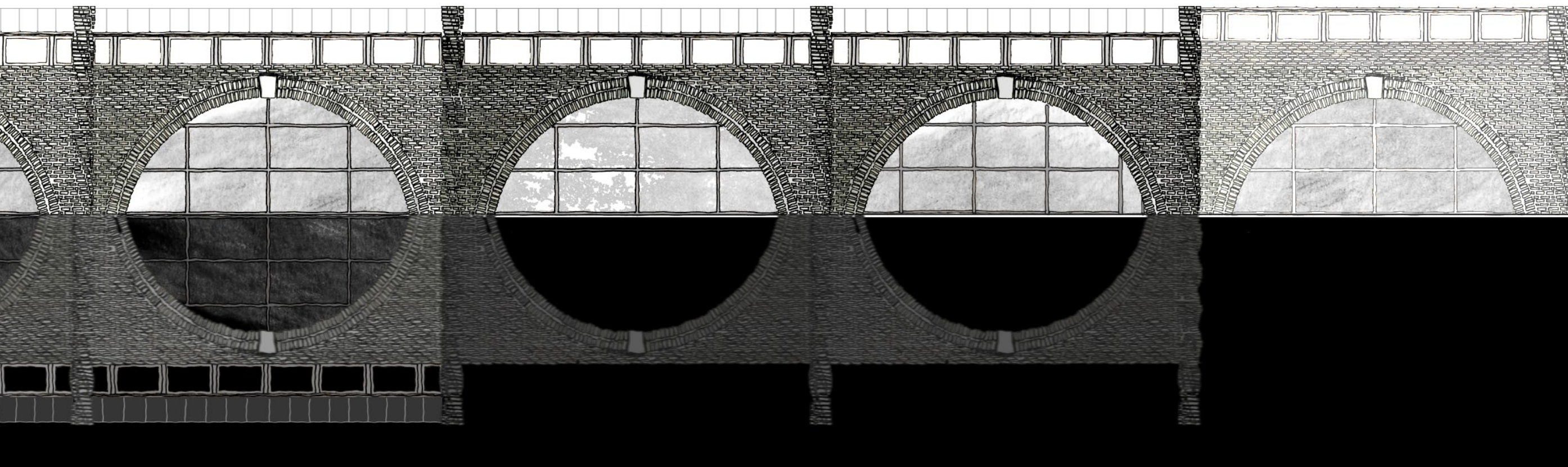

Elevation 2



## References

Map on page 1: courtesy of the Town of Blacksburg

[all other thoughts and images produced by author]