

THESIS SUBMITTED TO THE FACULTY OF THE
VIRGINIA POLYTECHNIC INSTITUTE AND STATE
UNIVERSITY IN PARTIAL FULFILLMENT OF THE
REQUIREMENTS FOR THE DEGREE OF

MASTER OF ARCHITECTURE

ESRA SAHIN

WILLIAM GALLOWAY, CHAIRMAN

WILLIAM BROWN

MICHAEL O'BRIEN

HEINRICH SCHNOEDT

B L A C K S B U R G
A U G U S T 2 0 0 1

prologue	05
the site	11
initiation	17
evolution	18
the building	22
components	35
conclusion	61
photographic credits	67
acknowledgments	69
vita	71

Thirteen centuries before Christ, just before fall of Troy and while King Tutankhamun was still ruling Egypt, a royal ship sets out from Syria with a course towards the West. It sails through the Mediterranean with a splendid cargo until being captured by a sudden wind near the rocky cliffs of Antiphellos. The ship collides with the rocks, capsizes and sinks. The cargo spills into the deep waters of the Mediterranean and lies silently for thirty four centuries until a Turkish sponge diver finds "strange metal biscuits" underwater. His discovery draws extensive attention after the metal biscuits were identified as copper ingots from an Early Bronze Age shipwreck. An international group of nautical archeologists start an immense excavation and research project prolonged to take more than a half century. The findings of the research continues to invalidate a number of accepted theories about the Early Bronze Age and to throw light on dark sides of a part of the story of human existence on earth.



unclosure_____



WORKSTATION FOR AQUARCHEOLOGY

THIS PROJECT IS A STORY OF FINDINGS

THE MAIN INTENTION IS TO DESIGN A WORKSTATION FOR NAUTICAL ARCHEOLOGISTS WHO ARE EXCAVATING AND RESEARCHING THE RUINS OF THE OLDEST KNOWN SHIPWRECK IN THE WORLD. THE USE OF THE BUILDING IS PROJECTED TO CHANGE OVER TIME TO HOUSE THE FINDINGS OF THE RESEARCH AND EXHIBIT THIS WORLD HERITAGE AND THE PROCESS THAT BROUGHT IT INTO LIGHT.

Permanence as a concept is the subject of the major inquiry of the architectural investigation through this project. The proposal of a permanent building instead of the existing temporary ones on the site is the initial design decision that leads to questioning and understanding of “temporariness” and “permanence” in architecture. The means to achieve “longevity” are explored.

Sustainability is considered a primary means to achieve permanence. Strategies to inhabit a remote site are studied. The project aims to employ the potentials of the local environment and natural resources to foster sustainability. The building is conceived as a living organism responding to its environmental conditions.

Interrelation of space and structure is primarily responsible for the “making” of the rooms. A clear primary structure and a flexible infill constitute the main approach of design. The synchronization of the repetitive skeleton, the backbone, and the enclosing surfaces is the main experiment through the design process. Various conditions of interdependency of the skeleton and the infill are studied to achieve distinctive spatial qualities. Permanence is sought through the generosity of the primary structure and flexibility of the infill to adapt to changing uses.

Lightness is considered an important issue regarding the remote location and limited assembly. The means to achieve a “light” building results in the use of steel as the primary efficient load carrier.

Locality, consideration of the region, enters through strict analysis of needs and a historical comparison of local building practices. Several unforeseen similarities are discovered.

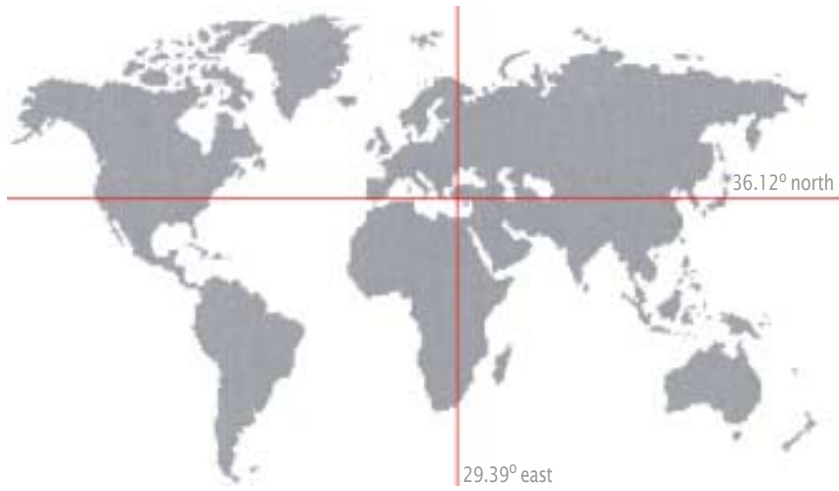



At present;

The site is an uninhabited peninsula called "Uluburun" (Great Cape) on the Mediterranean Coast of modern Turkey. The ancient name of the site *Antiphellos* means "rock land", and refers to the hard limestone nature of the land.

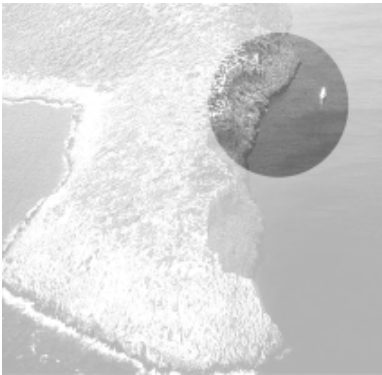

There is no access to the site by land, and the only means of transportation are sea vessels.

Every summer, a team of nautical archeologists settles on a slope on the east side of the peninsula close to the shipwreck.



The researchers spend four months diving, excavating, and documenting the ruins.

Each month of diving requires an indoor study of two years. Currently, this part of the research is conducted during cooler months, away from the site.



The necessary supplies of the team are shipped from a small tourist town, Kas, one hour away by boat.



Existing buildings on the site are temporary light timber frame huts built by the researchers. They consist of a laboratory, a kitchen, a bathroom, and sleeping areas for men and women, distributed across the site. The research is conducted only during summer months, and the buildings are demolished and rebuilt every year due to their inability to withstand the harsh winter waves. Site layout and construction change slightly every year, but one constant measure is that the working spaces are located closer to the shore while residential areas are located at the rear part of the site.





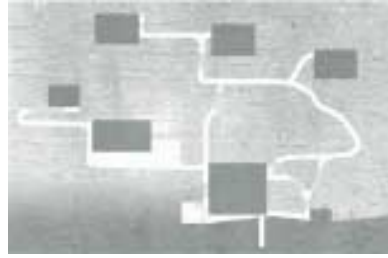

TWO MAJOR DECISIONS INITIATED THE PROJECT:

1. UNLIKE THE EXISTING DISTRIBUTED LAYOUT, A SINGLE INTERVENTION IS MADE ON THE SITE.

One building accommodating all the functions is proposed. The building is raised, providing protection from destructive winter waves and intensive summer heat radiated from the rocky terrain. An “inhabited beam” resting on two supports is proposed.

2. UNLIKE THE EXISTING TEMPORARY BUILDINGS, A PERMANENT STRUCTURE IS PROPOSED THAT CAN BE INHABITED THROUGHOUT THE YEAR.

In this scenario, year-round research is proposed. During the cooler months of the year when diving is not possible, the building houses the indoor research activities involving the documentation of the season’s findings. The use of contemporary information technologies are suggested as the means to carry out this part of the work.

AFTER DIVING AND RECOVERY IS COMPLETED, THE FINDINGS AND THE PROCESS OF “FINDING” WILL BE EXHIBITED IN THE BUILDING TO DESIGNATE IT AS A MUSEUM.

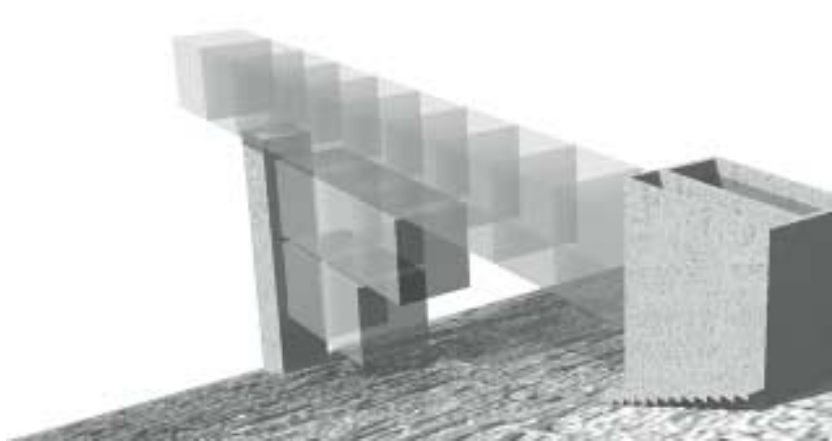

EVOLUTION: Development of the "beam"



Concerns for maintenance of the structural members against weathering conditions led to considering "concrete" as the material for the skeleton of the building with the presumption that the structure will be exposed. However, the idea of "not exposing the structure" by protecting it with layers of enclosure provided the chance for a lighter skeleton: a steel truss.



Design of the steel truss was mainly influenced by the fact that it would be "inhabited". Thus the first reaction was to minimize the obstruction of the steel members by avoiding the diagonal members of a truss. A Vierendale truss with welded moment connections was proposed.

18



Considering the restricted construction methods, on-site welding was avoided due to site conditions. Pre-welding of the whole truss and subsequent transportation to the site was considered impractical as well, as transportation to the site is also restricted. Therefore, a truss design with pin connections easily built on site was proposed. Still, visual obstruction of the truss members were minimized.

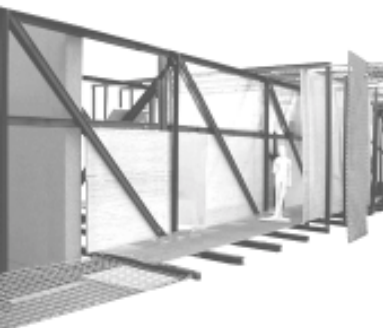
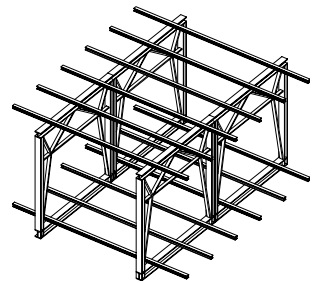

An important step was accepting the "diagonal" of the truss as a positive "ingredient" with potential to offer unusual architectural moments, rather than as an obstruction. A truss with a repetitive pattern of diagonals was proposed with the intention of utilizing the diagonals as coordinators of space.

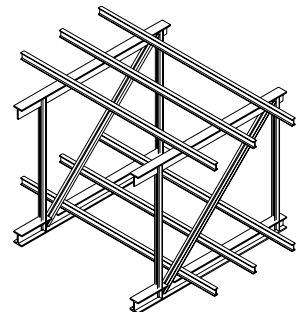

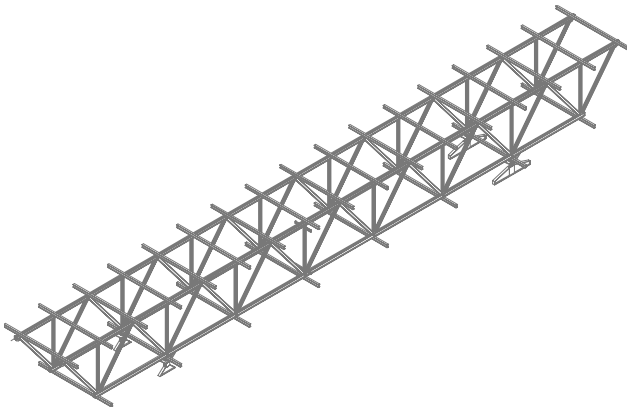

Through a study of structural behavior of the various proposals, the design of the truss was refined. The structural performance and efficiency of the final proposal was tested with computer analysis by using "RISA 3D", and the specific design was found to satisfy the structural requirements under various conditions of dead, live, wind, and earthquake loading.

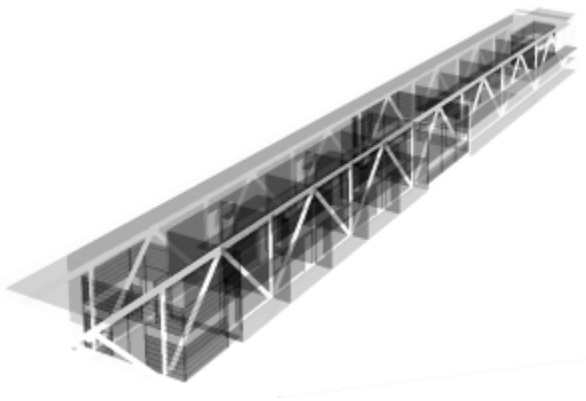

Interrelation of space and the structure became the architectural inquiry toward the making of "rooms". In order to minimize maintenance problems of the steel structure, the truss was wrapped by multiple layers of enclosure and protected from direct exposure. Layering of the enclosing surfaces and expansion of the enclosure by detaching the layers offered "in-between" spaces with a variety of distinct spatial qualities. The generosity of a protected primary structure and flexibility of the infill to adapt to change will hopefully contribute to the "longevity" of this architectural proposal.



REACTIONS TO ENVIRONMENTAL CONDITIONS

The study of the environmental conditions of the site is guided by sustainability. It is considered a major concern for the permanent inhabitation of this remote site.

The site has typical conditions of the Mediterranean climate. Hot and humid summers necessitate proper shading and ventilation. Spring and fall seasons are quite moderate offering a comfortable interaction with outdoors. While moderate heating is required during the cool and rainy winters, protection from freezing temperatures is not needed.

As the sun path studies show, the east-west elongation of the building provides a sensible interaction with the seasonal and daily route of the sun. The long south facade promotes higher solar gain during colder periods and prevents overheating during summer months when the solar rays are nearly vertical. The minimized east facade prevents solar gain on summer mornings. Leaning to the earth on the west end, the building is protected from western sun on summer afternoons.

The horizontal surface of the roof receives the highest solar gain when the solar rays are nearly vertical in the summer time. In order to utilize this resource, photovoltaic panels to provide electricity are proposed on the roof surface. The required area of the panels is determined according to the highest energy peaks. PV panels help for shading as well, by blocking the solar rays. They are detached from the surface of the building allowing air ventilation between the roof surface and PV panels, and increasing the efficiency of the panels. The south facade is partially covered with photovoltaic panels especially for cooler periods when the solar rays are oblique. Low-voltage electrical equipment (computers, lights, etc.) is proposed to save energy.

Seawater, being the other important natural resource of the site, is utilized to provide fresh water, desalinated by reverse osmosis units that are operated with solar energy.

9 am

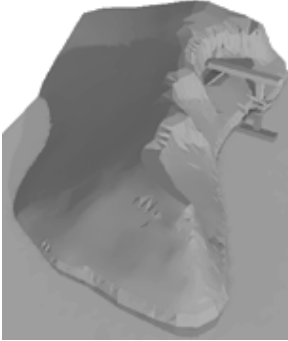

noon



2 pm



5 pm



DECEMBER 21

JUNE 21

8 am



noon



3 pm



7 pm

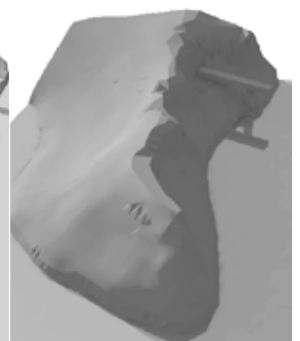

THE BUILDING

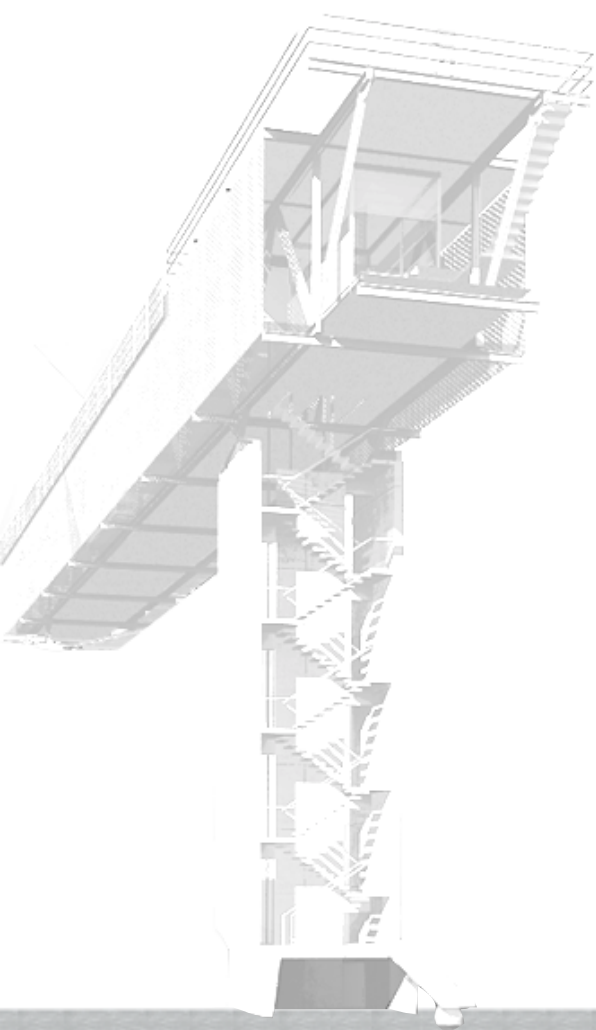



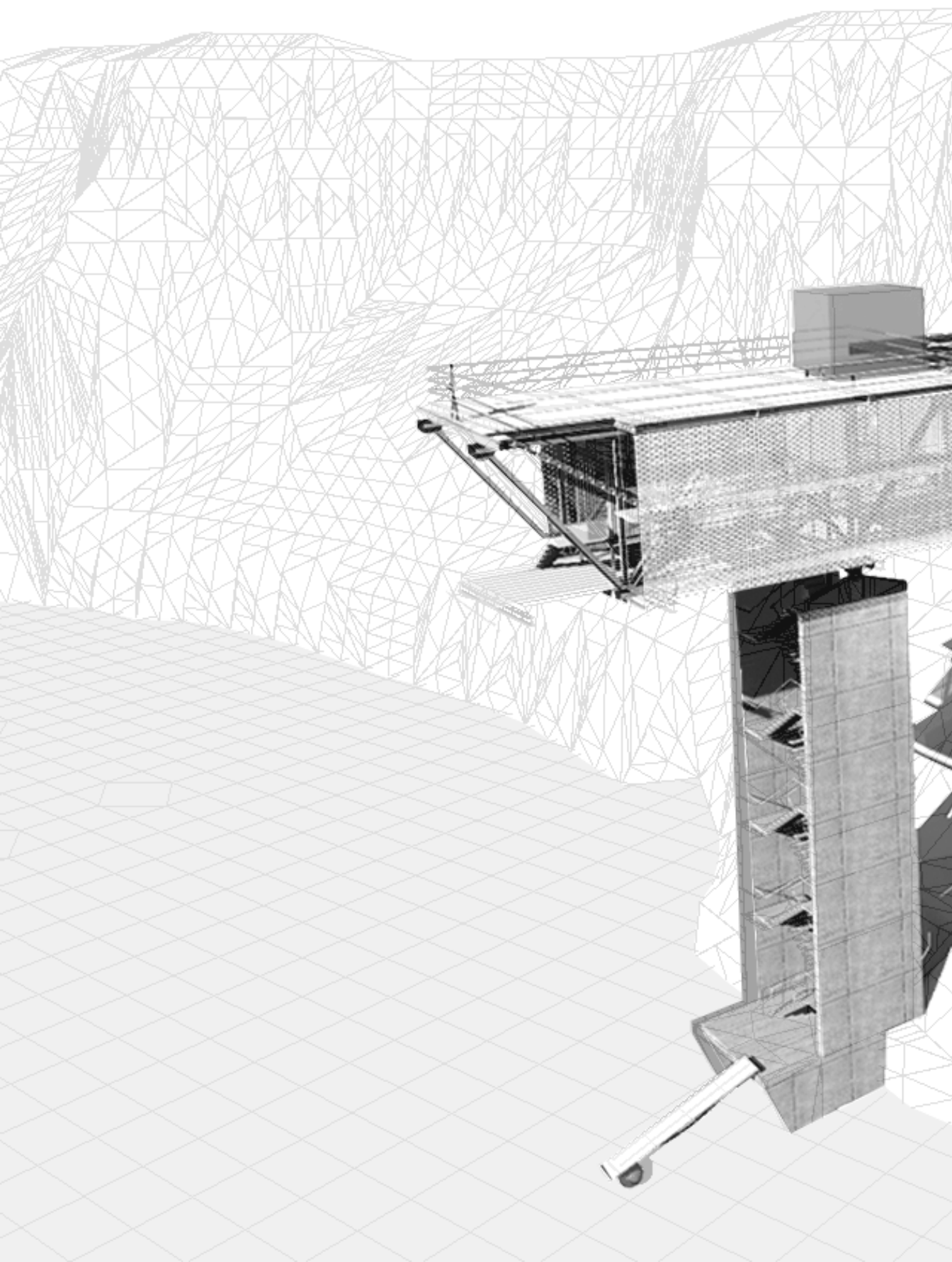

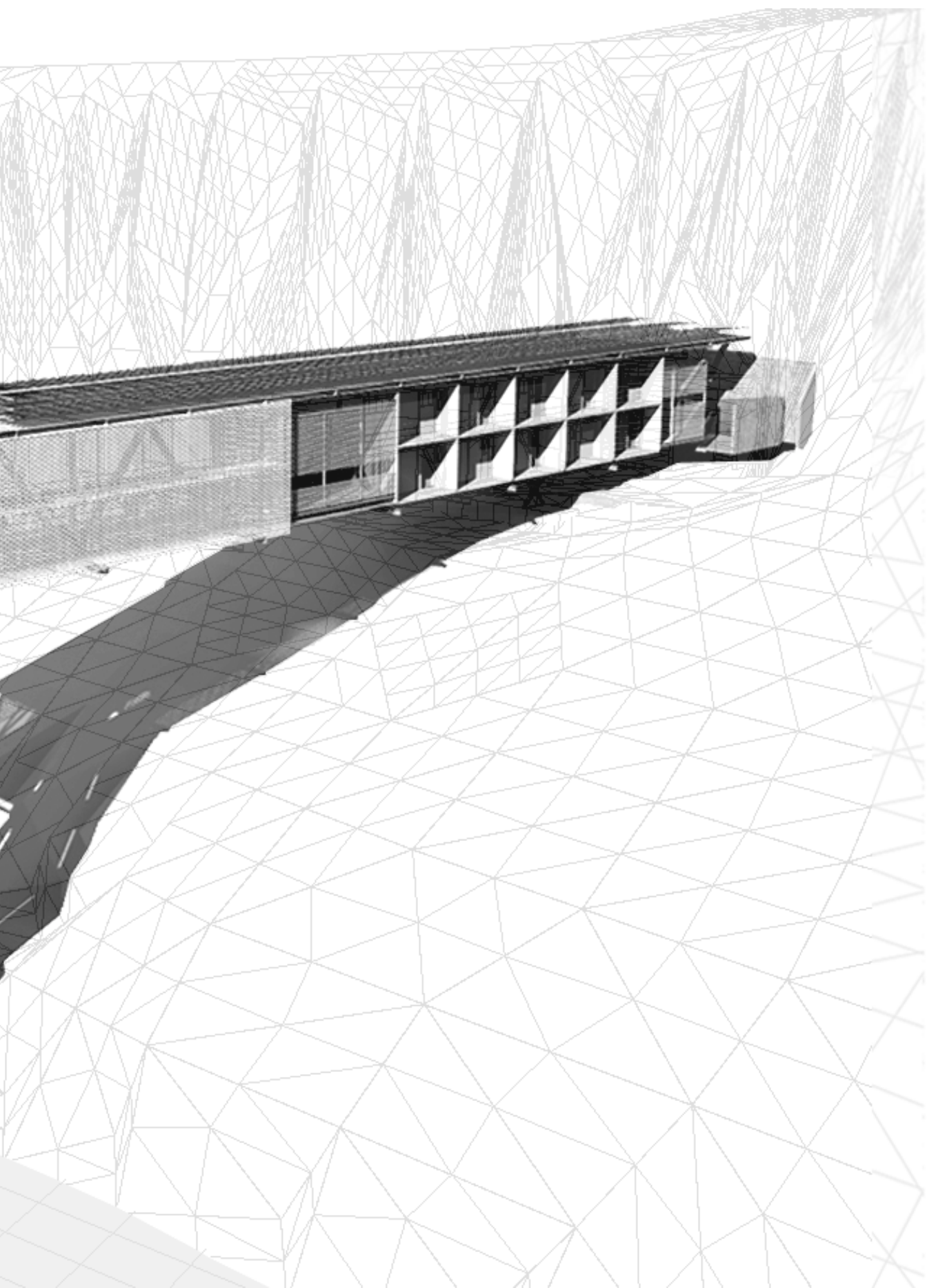



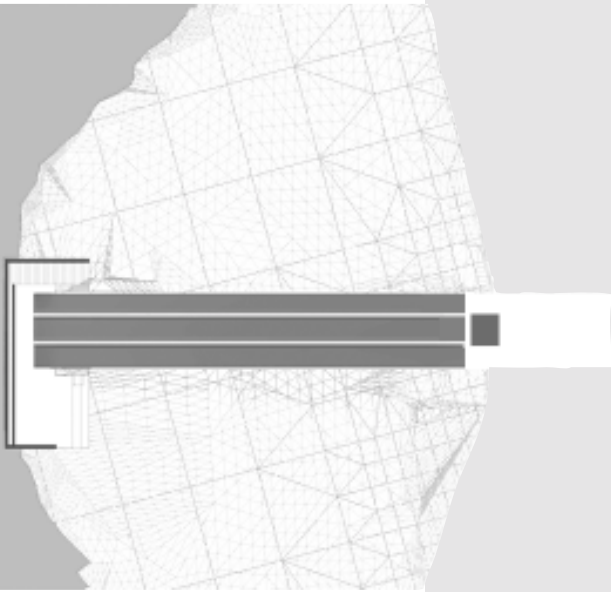

site plan in relation to the location of the shipwreck

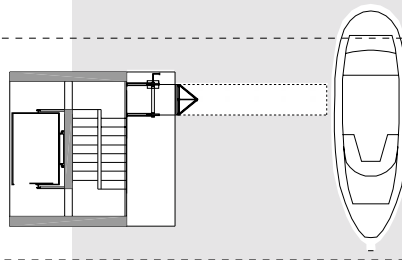

tower plan

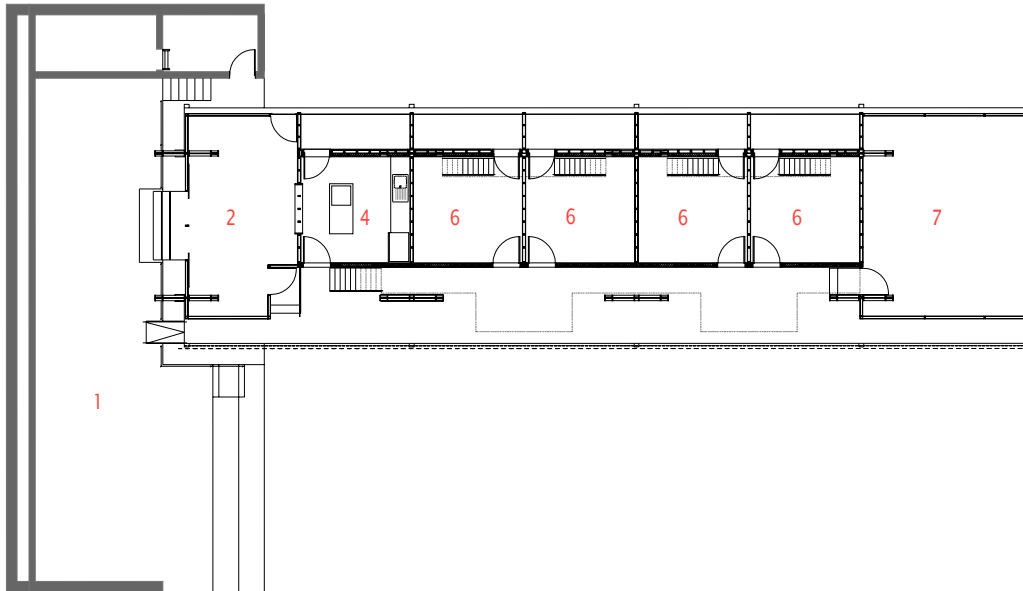
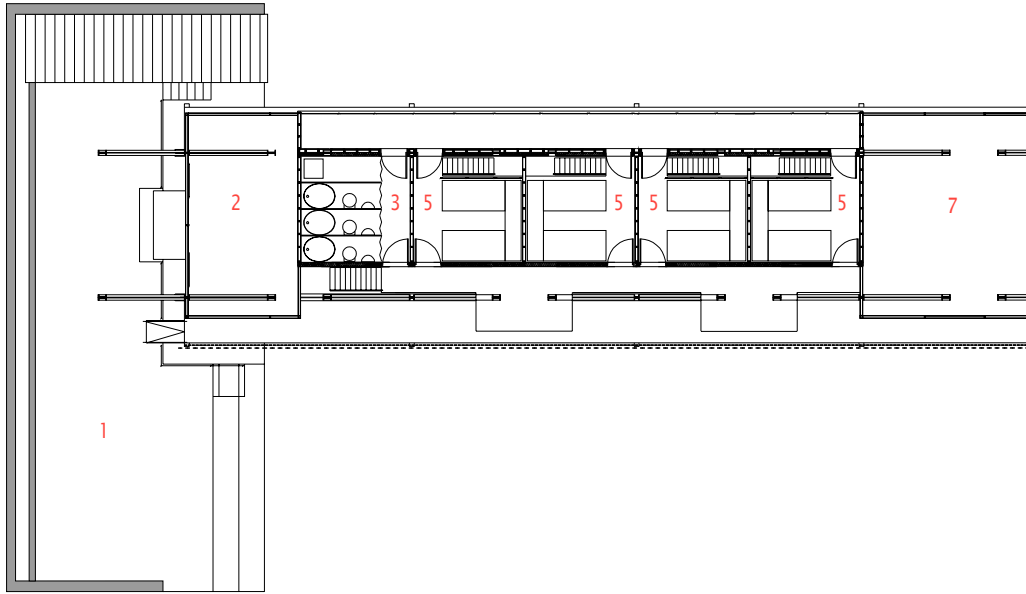

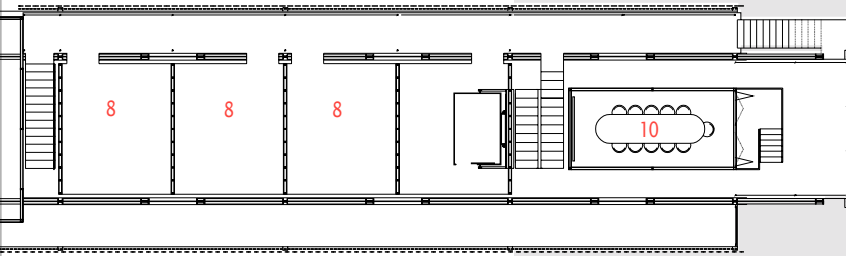

upper level plan

9. initial storage and treatment lab 10. meeting room

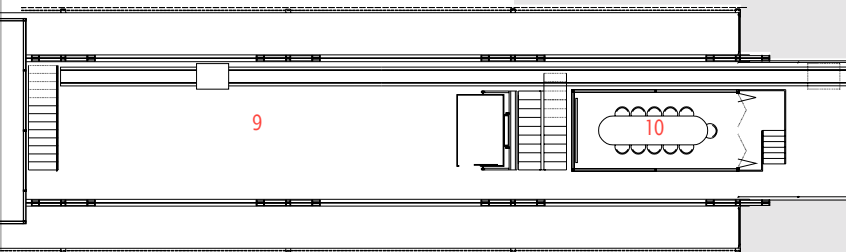

lower level plan

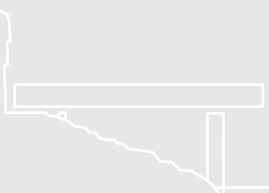
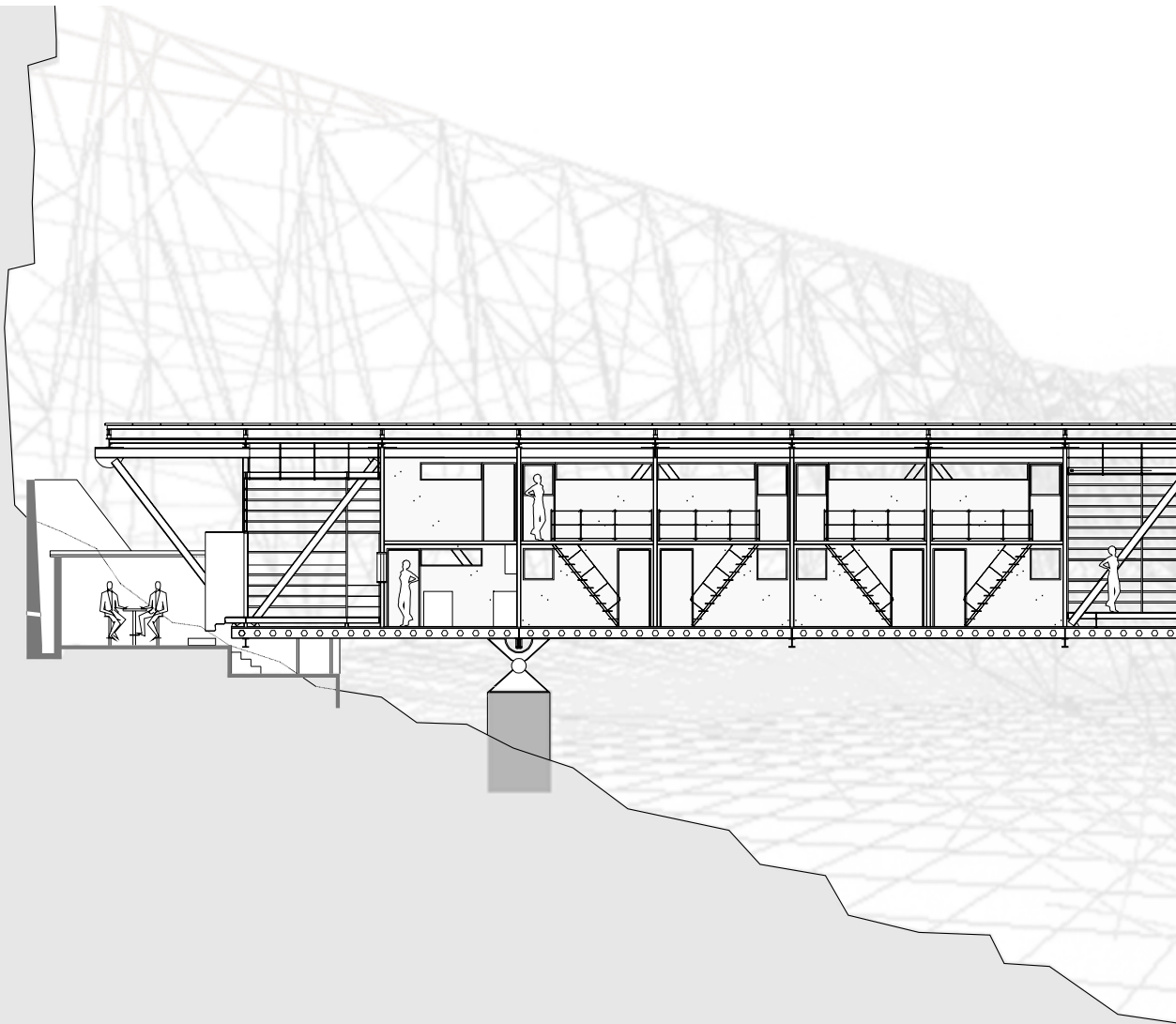

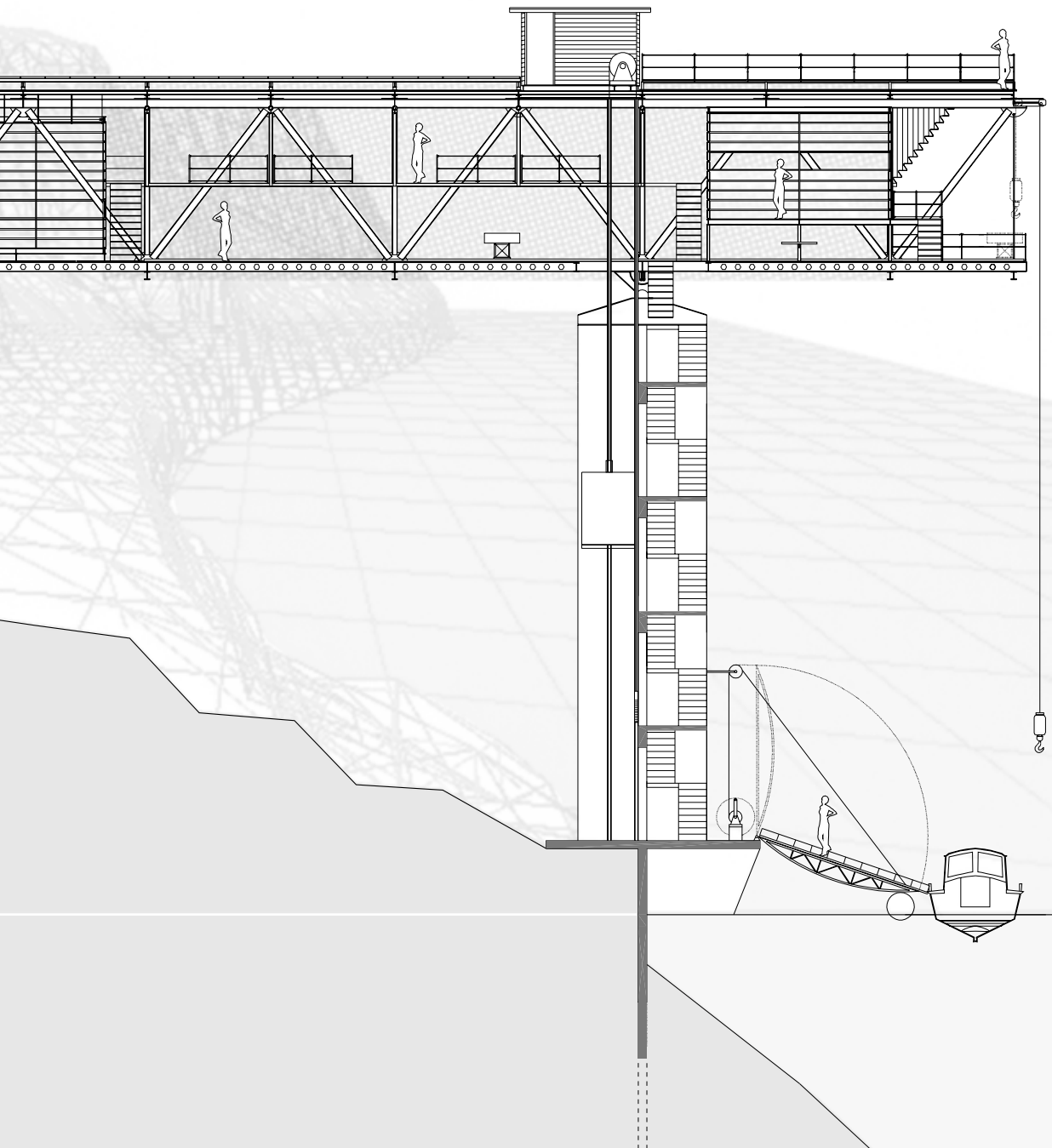

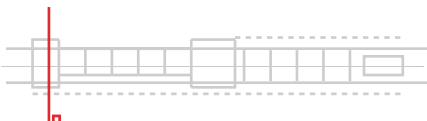
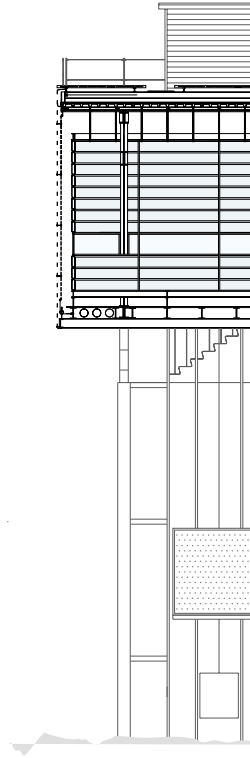
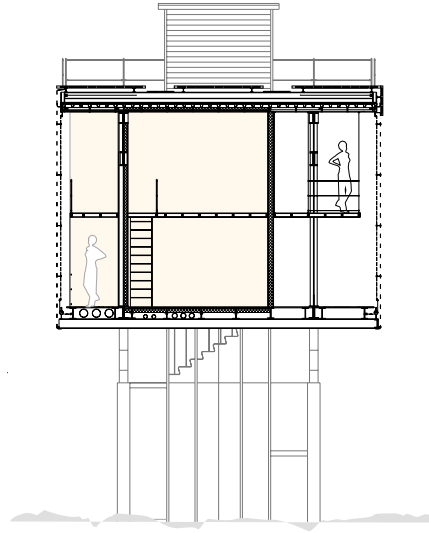
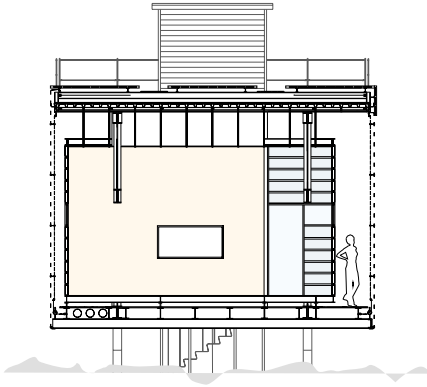

dining room

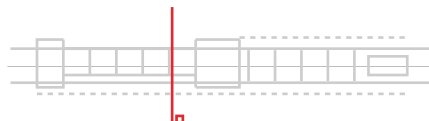

living unit

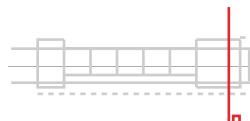

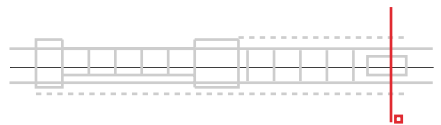
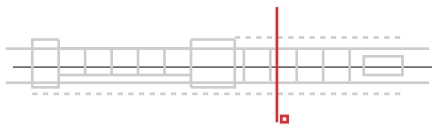
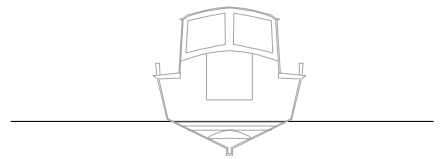
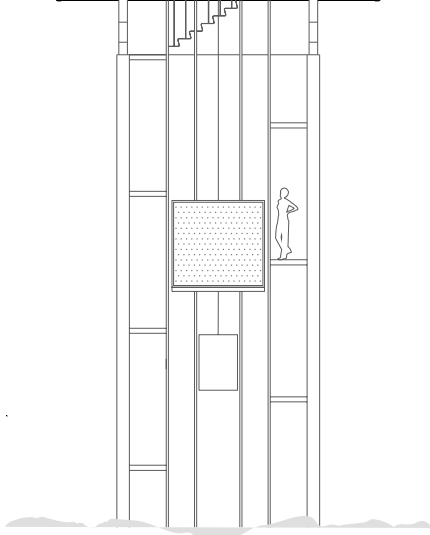
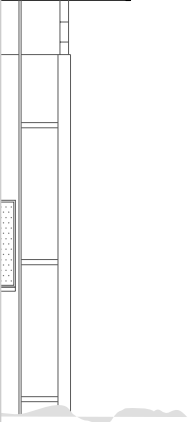
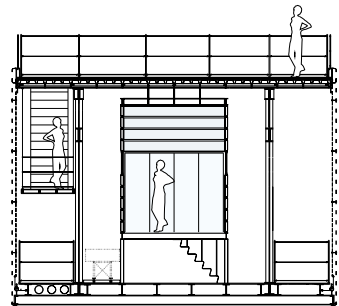
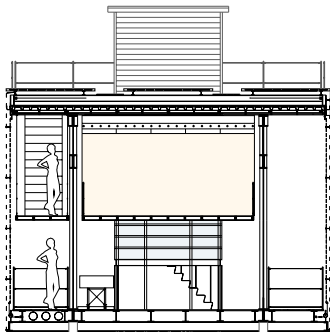
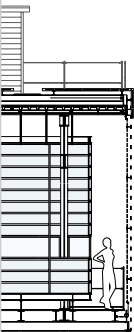

exhibition room

laboratory

meeting room

C O M P O N E N T S

G L A S S B O X E S

W O O D E N B O X

O P E N B O X

S C R E E N

B E A R I N G

T E R R A C E

C O R R I D O R

T H R E S H O L D S

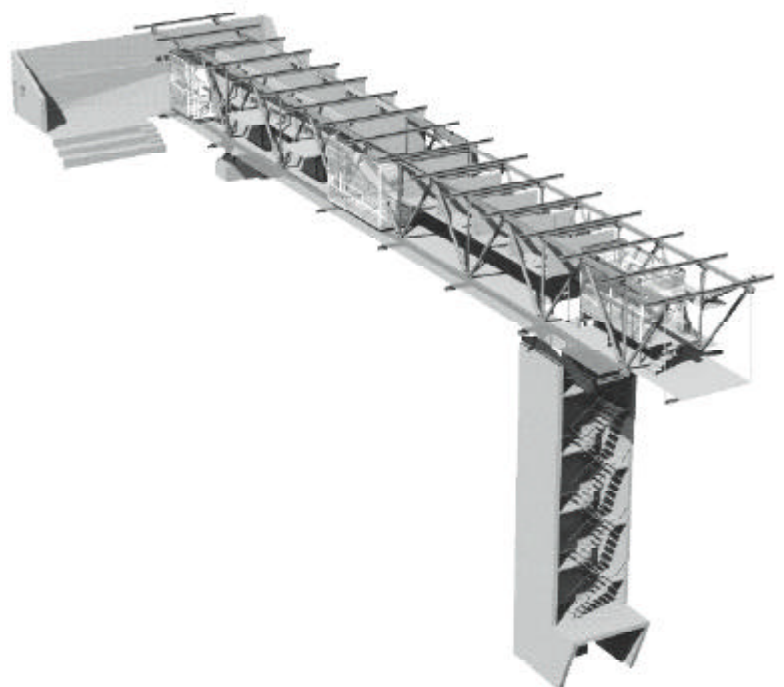

GLASS BOXES: enclosed public spaces of the building

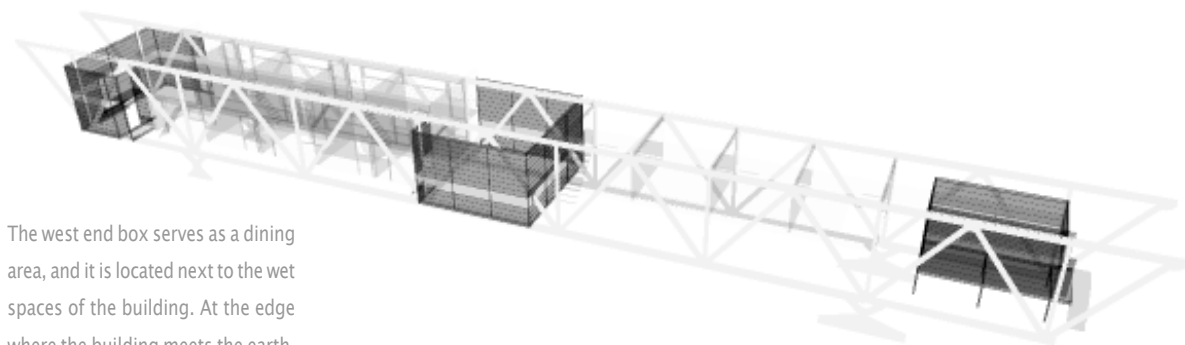

The west end box serves as a dining area, and it is located next to the wet spaces of the building. At the edge where the building meets the earth, this room can be extended to an open-air terrace.

Temporary exhibitions are located in the middle box. After the research is completed, this room will be the display area for special findings of the excavation.

The east end box features an open view of the excavation area. It is designed as a meeting room for the researchers. In the future, it is proposed to serve as a public lecture room for the visitors.



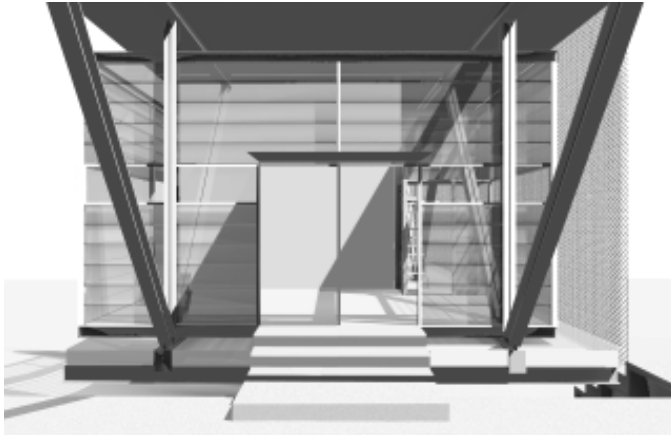

dining room

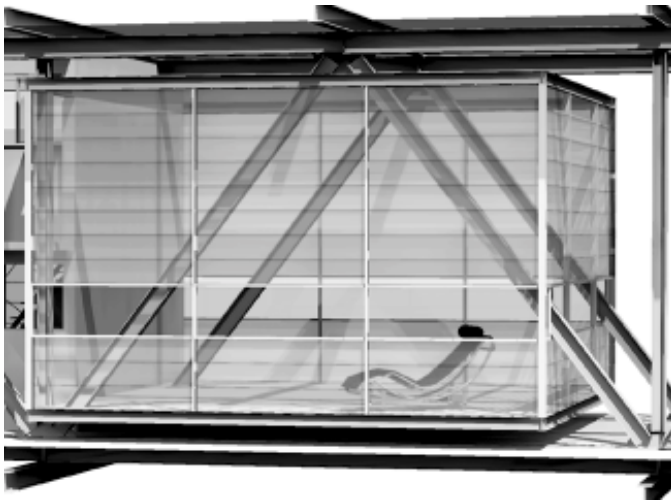

exhibition room

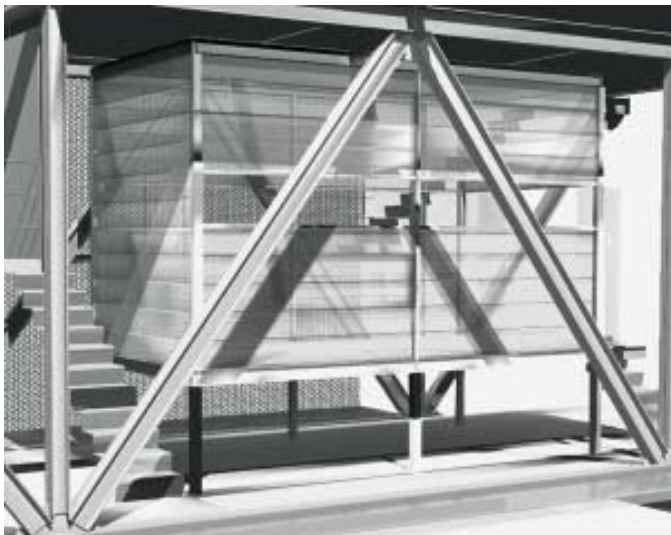

meeting room



U-shaped cast translucent glass pieces
stacked with an interlocking pattern.

aluminum framing:
2" x 4" tubes for intermediary columns
4" x 4" tubes for corner columns

clear glass

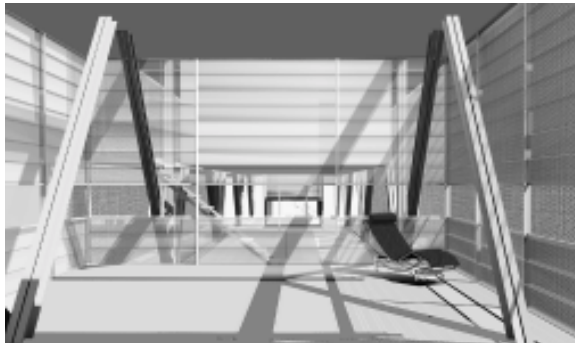
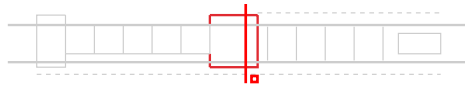
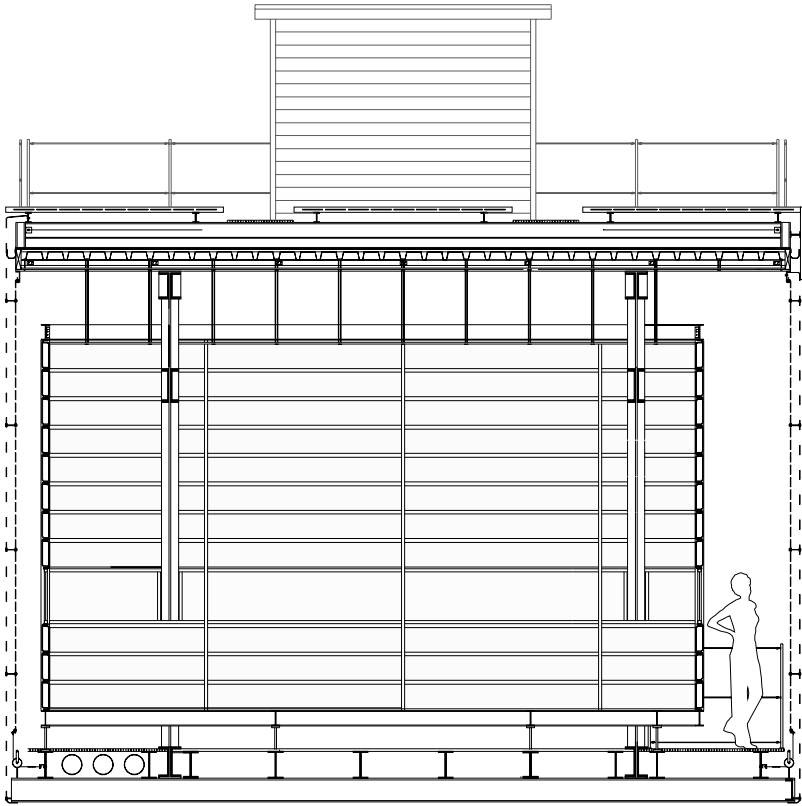

WOODEN BOX



The wooden box defines the private spaces of the workstation. It is an insulated, heated and air-conditioned space consisting of double-story living units, a kitchen, and a bathroom. During the winter months, the activities in the building are compacted into the wooden box. The number of the researchers diminish, and the work mainly involves indoor study of the findings.



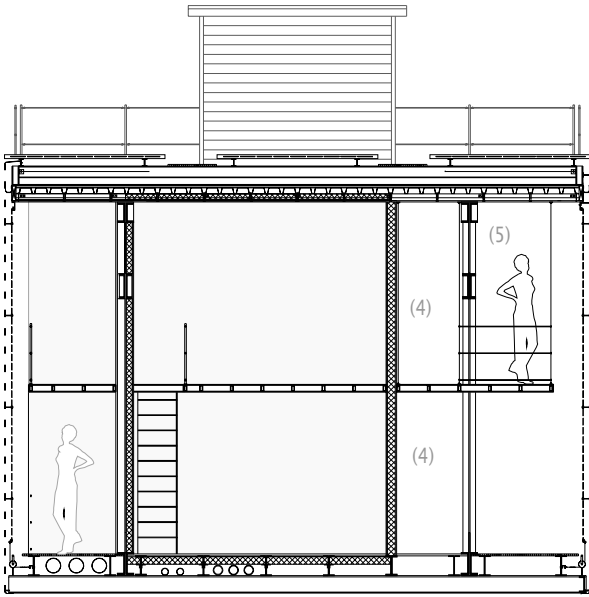

The lower level of the living units are equipped with computer facilities and serve as workspaces. The upper level rooms are the sleeping areas. The wooden box is surrounded by corridors on the north and south sides that enable private circulation without interfering with the public spaces.

On the western end of the wooden box, a bathroom (1) is located on the upper level, and a kitchen (2) on the lower level.

The northern corridors on both levels provide private terraces for the living rooms and working spaces. The side walls of the lower level balconies (3) on the north side also provide shading in the early summer mornings when the sun rises at 30 degrees north of east.

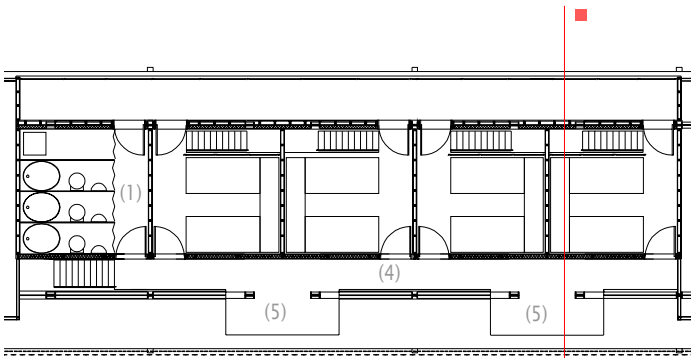

upper level plan

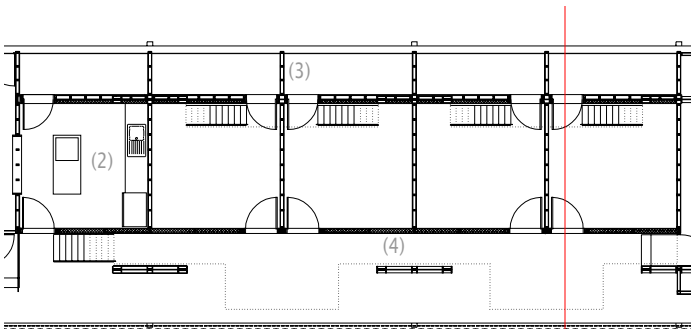

lower level plan



The south corridors (4) on both levels are recessed within the primary structure of the truss in order to avoid interference with the main corridor. Two balconies (5) extend outwards into the main corridor from the second floor south corridor offering possibilities to interact with the main corridor and also providing shade for the entrances of rooms below. The recessed south wall of the wooden box also helps to decrease solar gain during summer months and catches the oblique winter sun rays.

The outer wall of the wooden box is a sandwich type construction of insulated stress-skin panels. The south wall is recessed within the primary structure to open space for an inner corridor, and the north wall is "in-line" with the truss. The partition walls between the units are sandwich type planes built of plywood panels attached to 2" x 4" rectangular aluminum tube sections 16" o.c.

OPEN BOX

The open box is offered as a clean working area, mainly for documentation and drafting of the findings. It is an unconditioned, screened space that is exposed to outdoor temperatures. The screens surrounding the open box on the north and south sides provide shading and rain protection while allowing natural ventilation. Due to the climatic conditions, the open box can be comfortably occupied during the fall, summer, and spring seasons. When the temperatures drop during the winter season, the research is carried on within the heated and insulated volumes of the building.

The open box consists of a series of rooms connected by a suspended corridor. To provide clear space below, where the archeological findings of various sizes are initially stored and treated, the open box is suspended from the main structure by plywood panels that are attached to 2" x 4" rectangular aluminum tubes on 16" o.c. A cart on a track is proposed to facilitate easy transportation of the findings through the lower level workspace.



screened suspended corridor

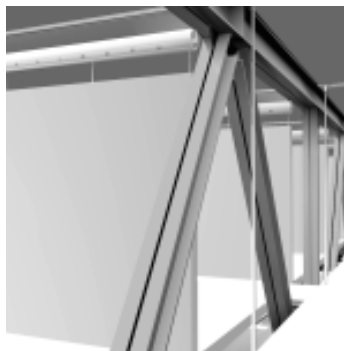

suspended planes of the open box



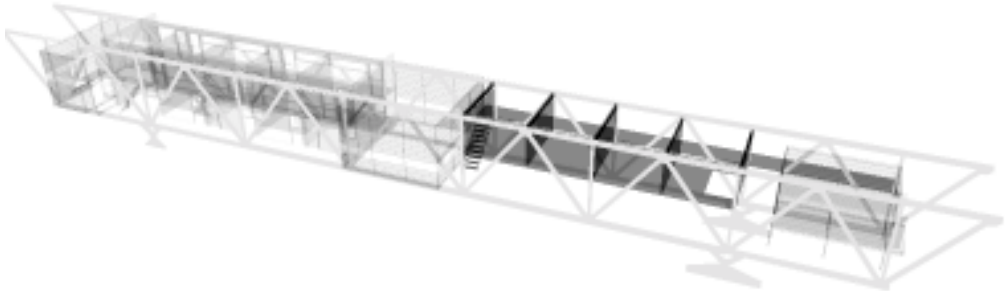
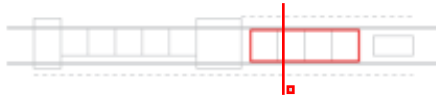
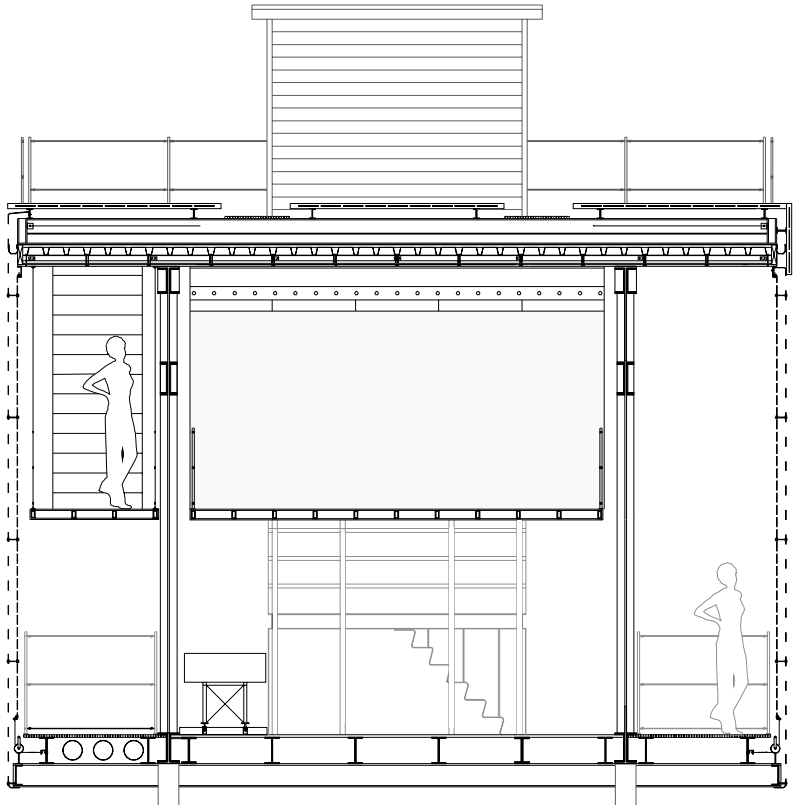

SCREEN

Climatic conditions and the program of the building allow less restricted interaction with outdoors. Excluding the heated and air-conditioned rooms, the building is naturally ventilated. However, the need for shade and rain protection necessitates controlled openness. The proposed solution involves “screening” of the building with perforated metal sheets. The screen is designed to provide shade, drain the rainwater, and permit air circulation. The particular pattern of perforation of the screens is decided through shadow pattern studies.

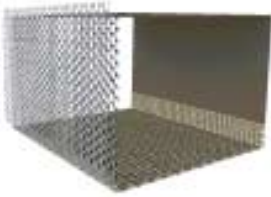

Considering “lightness” as an important aspect of the building, the means to decrease the weight is explored. The screen is designed as two layers of perforated metal sheet that are tensioned between upper and lower truss chords, eliminating a supporting structure. Instead of a static material construction, a dynamic construction where material is employed as a “carrier of forces” is exercised.

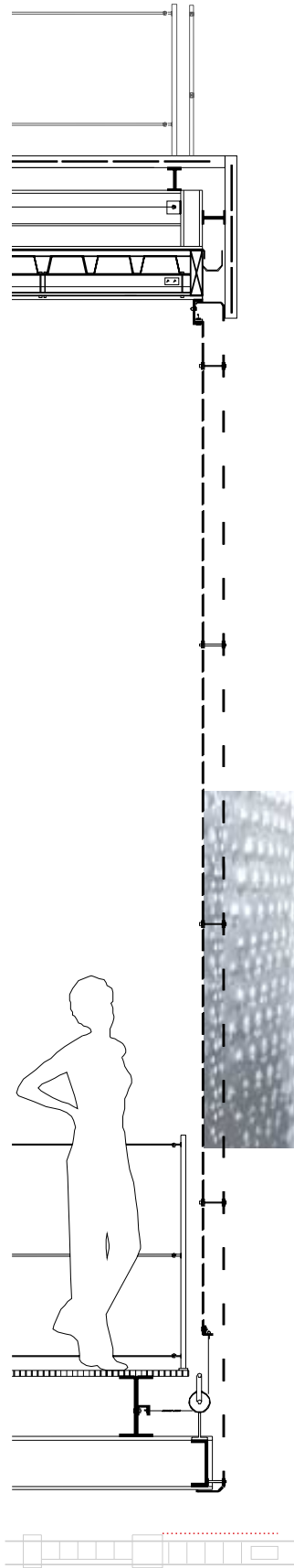

From the outside, the screen partially wraps the building like a veil. Both revealing and concealing, it provides an ambiguous enclosure. Changing light conditions during the day cause different reflections on the metal screen, displaying various colors and levels of transparency. Perception of the building from outside changes according to time of the day and location of the observer. To a visitor approaching on a swinging boat, the screen presents a kinetic facade. Interior night lighting reveals the building, rendering the screen virtually transparent.



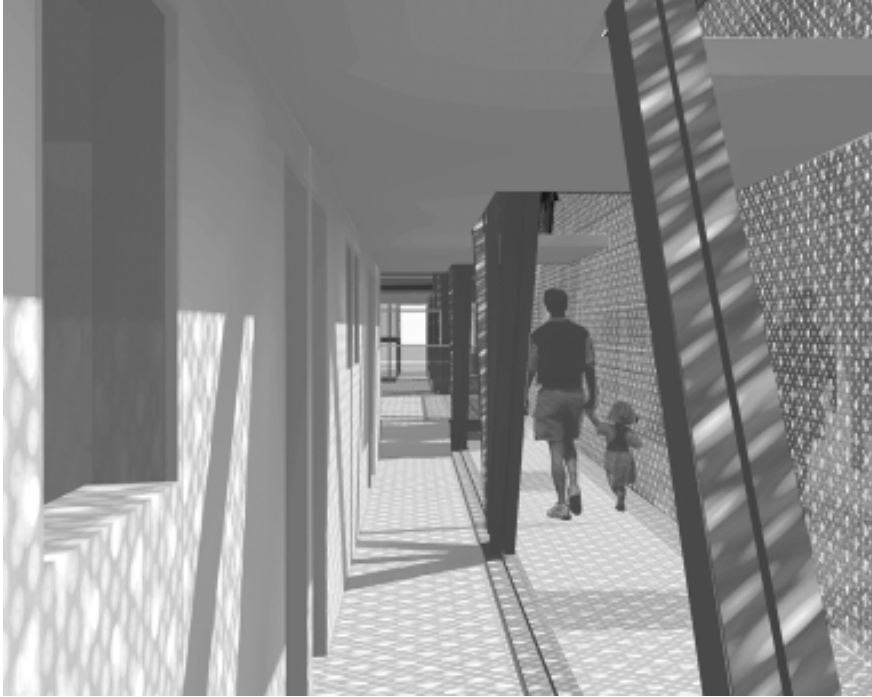

The analysis of the building parts and material assemblies led to finding unforeseen similarities with historic building practices. For centuries, wooden or stone “screens” have been widely used in traditional Turkish domestic and public architecture for controlling the light and in most of the cases allowing air ventilation as well. The proposed double layered metal screen offers a new interpretation of the traditional screens with modern materials and construction systems.

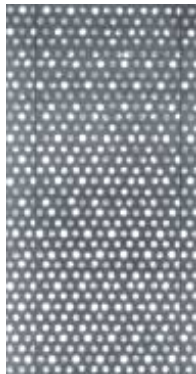

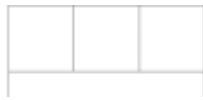

"open sofa" plan



The diagram of an "open sofa" plan in a traditional Turkish house is similar to the room structure in the truss. Repetitive adjacent rooms are connected by a common hall, *sofa*, which is a screened intermediary space between interior and exterior. The screen provides shading and air ventilation.

Interior view and window detail of Selimiye Mosque in Edirne (16th century design by Mimar Sinan)

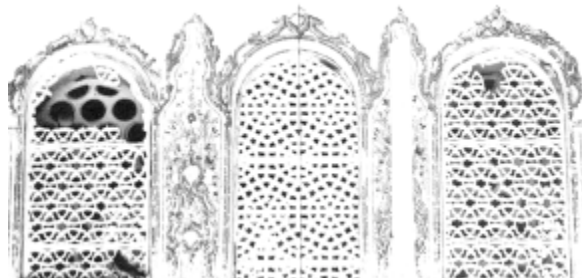

THE BEARING

In order to reduce the weight of the individual pieces for ease of handling during transportation and construction, truss members are designed as pairs of C-channels. To minimize on-site welding, the members are joined with "pin connections" and the truss is assembled on site. The bearings on the east side are roller supports that allow the steel structure to contract and expand during thermal changes.

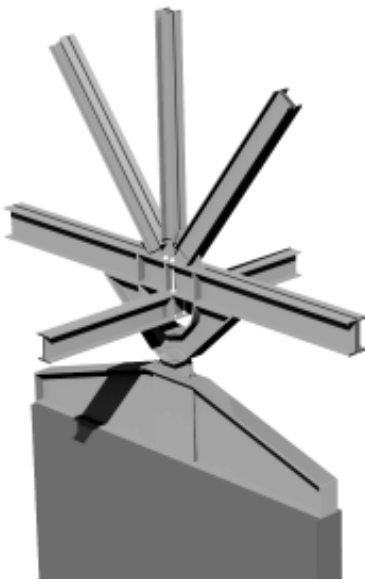

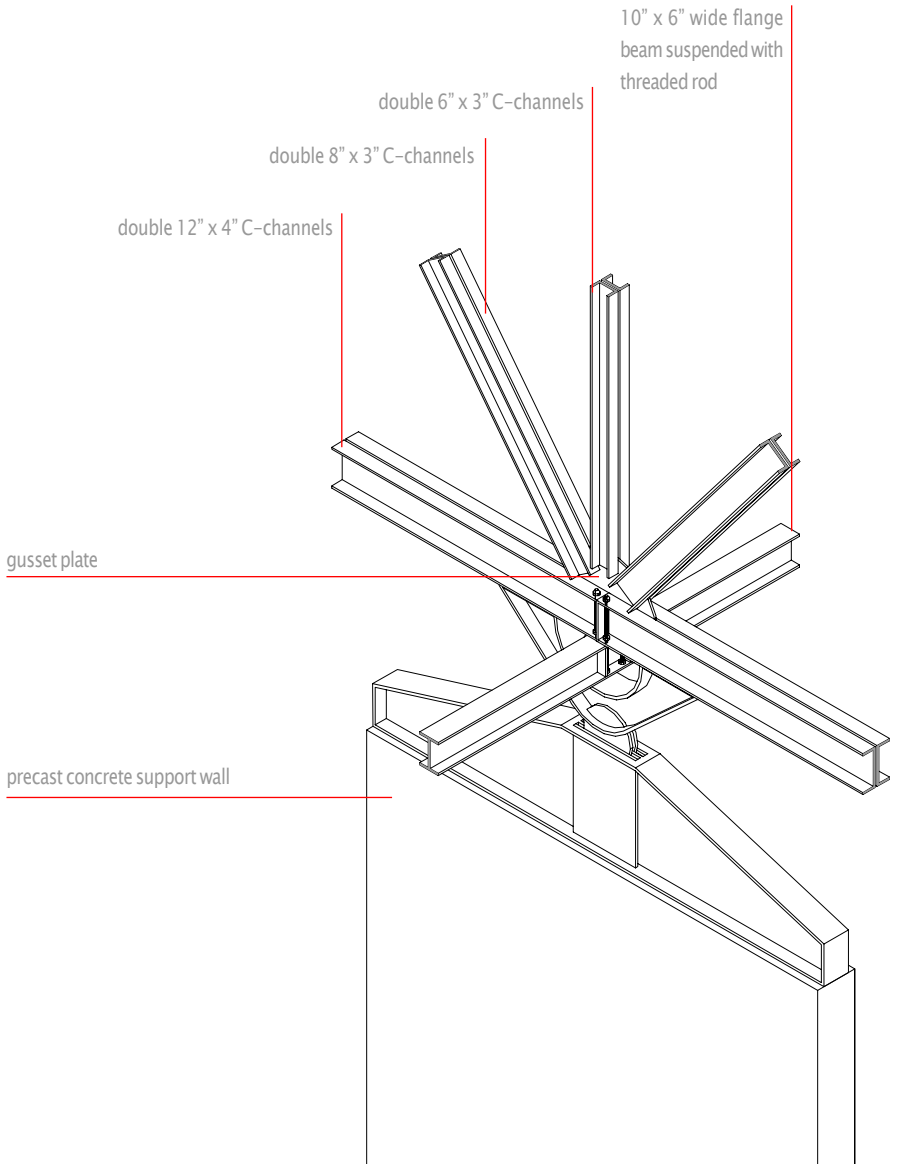
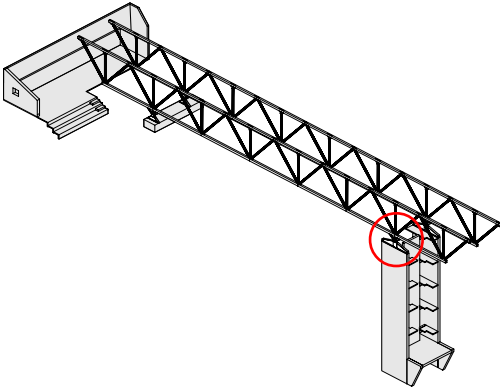

ROOF TERRACE



CORRIDOR

The main corridor provides an uninterrupted circulation path through the building and completes the link between the earth and the sea.



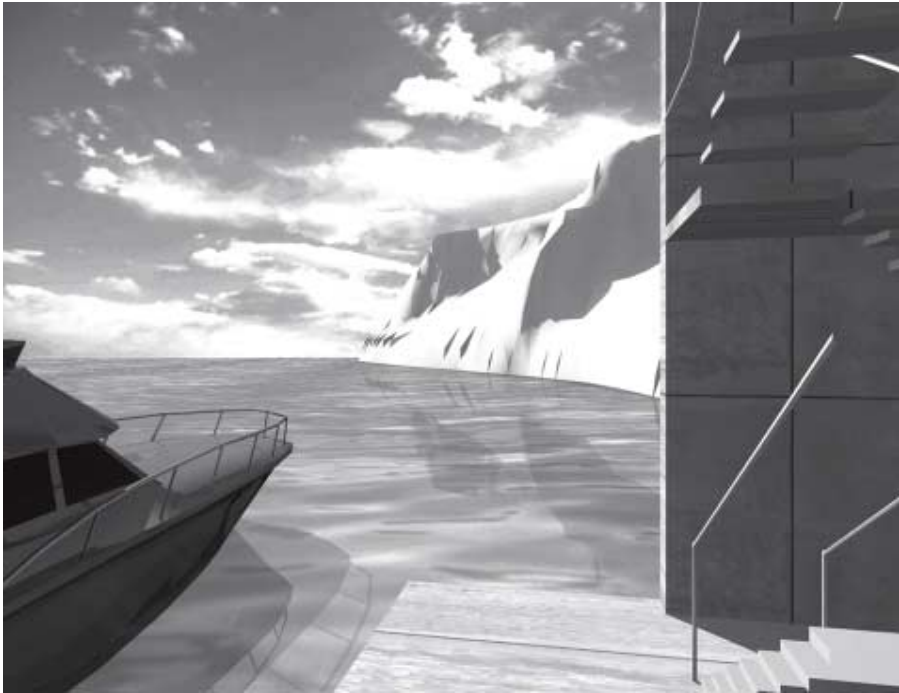
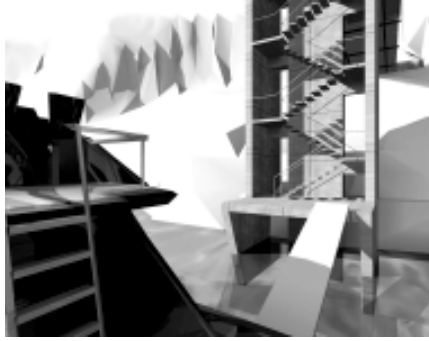

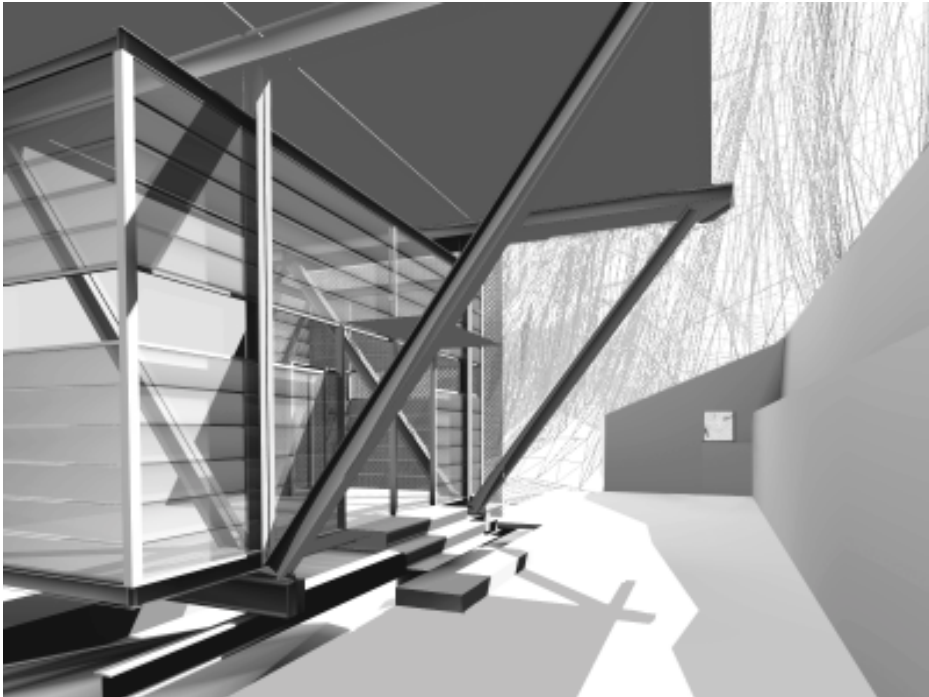
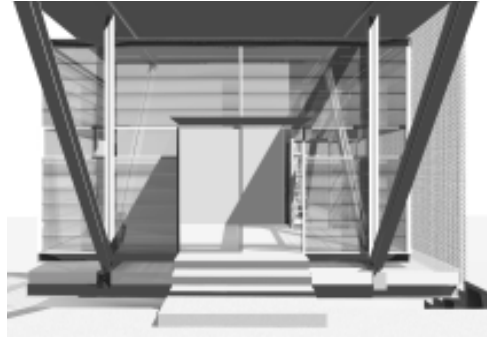

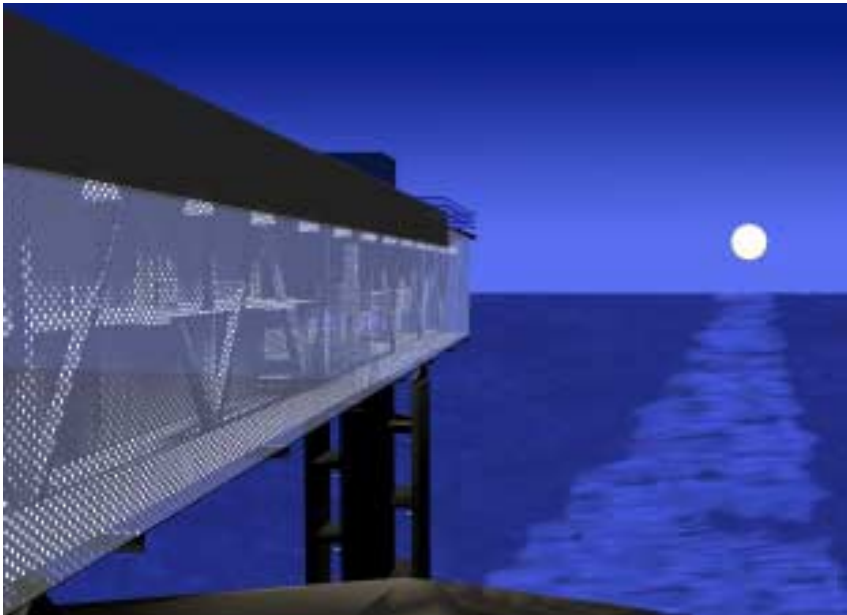

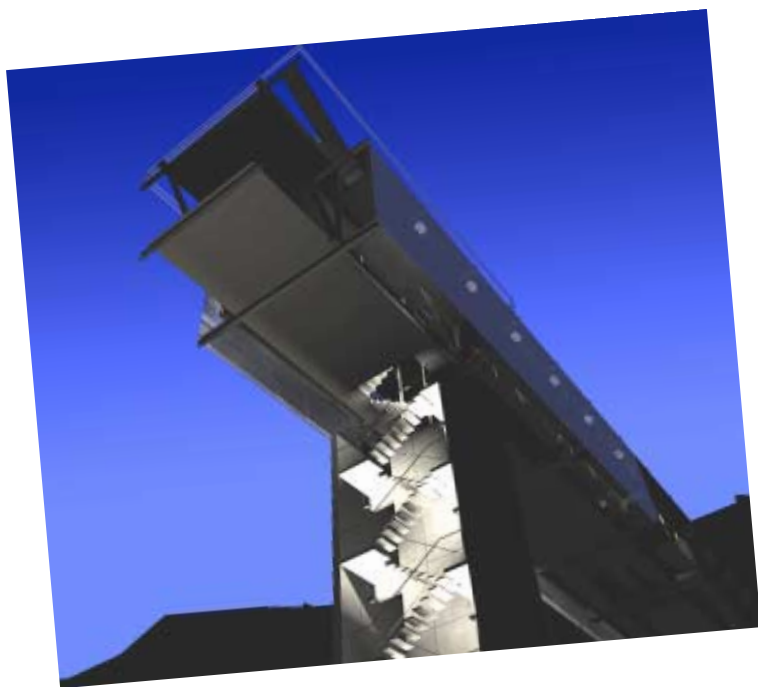



CONCLUSION









In the quest for permanence, the provision of a prolonged existence may be defined as the capability to adapt to change, as opposed to an inflexible solidity. In architecture, which itself is initially a process of transforming, longevity can be achieved by incorporating the means of further transformation. Therefore, we should conceive architecture with generosity and ample opportunity to accept change.

Institute of Nautical Archeology Archive
Texas A & M University



Institute of Nautical Archeology Archive
Texas A & M University



Atlas Magazine
February 1994



Tradition of the Turkish House and Safranbolu Houses
Gunay, Reha
Istanbul, 1998



Ottoman Turkey
Goodwin, Godfrey
London, 1971



A History of Ottoman Architecture
Goodwin, Godfrey
London, 1977



I wish to thank:

69

My dedicated companion Ozgur and my family
for their endless love and support

My committee members, Heinrich Schnoedt, William
Galloway, William Brown, and Michael O'Brien
for the guidance and encouragement
I have enjoyed every moment of their mentorship.

My studio friends
for the joy, support, and the great time we shared

Dr. Cemal Pulak, head of the Uluburun Excavation
for providing the valuable data on the existing
research facility in Uluburun

Higher Education Council of Turkey and Mersin
University
for sponsoring my studies in the US

And all the others who generously gave me a hand
and made this work possible.

ESRA SAHIN

1976

Education

- 01 – University of Pennsylvania
Doctoral Studies In Architecture
- 99 – 01 Virginia Polytechnic Institute and State University
Master of Architecture
- 98 – 99 Middle East Technical University (M.E.T.U.), Turkey
Graduate Studies in Theory and History of Architecture
- 94 – 98 Middle East Technical University, Turkey
Bachelor of Architecture

71

Awards and Scholarships

- 05/01 SOM 2001 Architecture Travelling Fellowship
- 05/01 Award for Excellence in ACSA/STI 2001 Steel Design and Engineering Challenge
- 05/01 Graduate Faculty Award for Excellence in Architecture
College of Architecture, Virginia Tech
- 05/01 Second Prize in Virginia Concrete Masonry Association Design Competition
- 06/99 Higher Education Council of Turkey Scholarship for Graduate Studies Abroad
- 06/98 1998 Ytong Award
- 07/96 Lions Club Travelling Scholarship

Conferences / Workshops

- 06/01 ACSA International Conference, Istanbul, Turkey
- 11/00 International Architecture Workshop in Virginia Tech
- 10/97 SanArt International Visual Arts Symposium, in M.E.T.U., Turkey
- 07/95 “TMMOB 95” Meeting of Architecture Students of Turkey, Northern Cyprus

