

**Evaluation of Fracture Flow at the Coles Hill Uranium Deposit in Pittsylvania County, VA
using Electrical Resistivity, Bore Hole Logging, Pumping Tests, and Age Dating Methods.**

John P. Gannon II

Thesis submitted to the faculty of the Virginia Polytechnic Institute and State University in
partial fulfillment of the requirements for the degree of

Master of Science
In
Geosciences

Thomas J. Burbey (Chair)
Robert J. Bodnar
Joseph Aylor

October 7, 2009
Blacksburg, VA

Keywords: Uranium Deposit, Electrical Resistivity, Borehole Logging, Pumping Test, Age
Dating

**Determination of Fracture Flow at the Coles Hill Uranium Deposit in Pittsylvania County,
VA using Electrical Resistivity, Bore Hole Logging, Pumping Tests, and Age Dating**

Methods.

John P. Gannon

Abstract

The Coles Hill uranium deposit in Pittsylvania County, VA, is the largest un-mined uranium deposit in the United States. The deposit is located in the Virginia Piedmont in a crystalline rock unit located immediately west of the Chatham Fault, which separates the granitic rocks of the Virginia Piedmont to the west from the metasediments of the Danville Triassic basin to the east. Groundwater at the site flows through a complex interconnected network of fractures controlled by the geology and structural history of the site. In this study groundwater is characterized in a small study area just south of the south ore body. Methods used in this investigation include electrical resistivity profiling, bore hole logging, a pumping test, and age dating and water chemistry. In this study groundwater flow is confirmed to occur from the Piedmont crystalline rocks across the Chatham Fault and into the Triassic basin at the study area as evidenced by pumping test data and static water-level data from observation wells. Well logs have identified fractures capable of transmitting water in the granitic rocks of the Piedmont, the Triassic basin metasediments and the Chatham Fault but the largest quantities of flow appear to occur in the Triassic basin. A definable recharge area for the groundwater present at Coles Hill can not yet be determined due to the complexity of the fracture system, but age dating confirms that groundwater is composed of both young and old (>60 years) components, indicating that at least a portion of groundwater at Coles Hill originates from a more distant area.

Acknowledgements

First I would like to thank my advisor, Dr. Thomas Burbey for his guidance and assistance in this project. Without Tom's help and instruction everything from field-work to the writing of this thesis would not have been possible.

Thanks as well to the rest of my committee, Dr. Joseph Aylor and Dr. Robert Bodnar for their guidance throughout this project.

A very important thanks goes to Virginia Uranium for funding this project as well as giving me access to their site and equipment. Without this funding the project would not have been possible.

I would especially like to thank William S. Henika for his invaluable guidance and instruction regarding the geology of this project as well as his numerous trips to the field to help me gather data.

A great deal of people helped me with field-work throughout this study and I would like to thank all of them, for without their assistance the process of completing this project would have been slowed a great deal. They are: Stewart East, Josh Whitney, John Wyatt, Philip Prince, Carol Johnson, Troy Dexter, Amy Snyder, Eric Kazlauskas, Ryan Thigpen, Jonathan Gerst, Khalaf Al-Temimi, Dr. Madeline Schreiber, Yinka Oweyumi, Matthew Steele-MacInnis, Peter Voice, Sam Fortson, and Jason Lunz.

Last and foremost I have to thank my parents, John and Laura Gannon for providing me the opportunity to arrive where I am today. The support and encouragement they have offered me throughout my life is without a doubt the primary reason this thesis exists. Mom and Dad, THANKS!

Table of Contents

Abstract.....	ii
Table of Contents	iv
List of Figures.....	v
List of Tables	vii
1.0 Introduction.....	1
2.0 Geologic Setting.....	5
3.0 Site Hydrogeology	9
4.0 Methods.....	11
4.1 Electrical Resistivity Profiling.....	11
4.2 Geophysical Well Logging.....	19
4.3 Water Levels.....	27
4.4 Pumping Test	28
4.5 Water Chemistry and Age Dating	32
5.0 Discussion.....	37
6.0 Conclusions.....	41
References	44
Appendix A	47
Appendix B	50

List of Figures

Figure 1.1: Dan and Banister River basins map (Virginia DEQ, personal commun., 2009).....	3
Figure 1.2: Location of Coles Hill in the Commonwealth of Virginia as well as the locations of the south ore body and south spring study areas.....	4
Figure 2.1: Geologic Map and cross section of the area surrounding Coles Hill (From Jerden, 2001)	6
Figure 2.2: Detailed geologic map of Coles Hill (From Jerden, 2001)	7
Figure 2.3: Detailed geologic cross section of Coles Hill (From Jerden, 2001).....	8
Figure 3.1: Conceptual model of groundwater flow at the south spring study area, Coles Hill, VA.....	10
Figure 4.1: Four electrode arrays used for resistivity profiling in this study (From Seaton and Burbey, 2002)	12
Figure 4.2: Electrical resistivity transects at ore bodies, Coles Hill, VA	13
Figure 4.3: Resistivity profiles COL1 and COL2.....	14
Figure 4.4: Resistivity profiles COL9 and COL10.....	15
Figure 4.5: Locations and profiles of south ore body electrical resistivity transects.....	16
Figure 4.6: Locations and profiles of south spring study area resistivity transects	17
Figure 4.7: Well and spring locations at the south spring study area. Wells logged include: VAUTrail, Cow1, Johns1, and Johns2.....	20
Figure 4.8: Eight, 16, 32, and 64 inch normal resistivity, single point resistance, fluid temperature, caliper, and heat pulse flow meter logs for the VAUTrail well.....	22
Figure 4.9: Optical televiewer log of fracture at 55m in VAUTrail well (fracture determined to be dipping at 82.76 deg)	23
Figure 4.10: Eight, 16, 32, and 64 inch normal resistivity, single point resistance, fluid temperature, caliper, and heat pulse flow meter logs for the Johns1 well.....	24
Figure 4.11: Eight, 16, 32, and 64 inch normal resistivity, single point resistance, fluid temperature, caliper, and heat pulse flow meter logs for the Johns2 well.....	25
Figure 4.12: Eight, 16, 32, and 64 inch normal resistivity, single point resistance, fluid temperature, caliper, and heat pulse flow meter logs for the Cow1 well.....	26
Figure 4.13: Inferred potentiometric surface of fractured rock aquifer at the south spring area of Coles Hill	27

Figure 4.14: Cow1_upper and Johns2 response to pumping of VAUTrail	29
Figure 4.15: Dimensionless drawdown vs. dimensionless time for different values of the fractional flow dimension n (From LeBorgne, 2004).....	31
Figure 4.16: Piper plot of chemistry data from sampled wells at Coles Hill.....	35
Figure 4.17: Plot of N ₂ vs Ar, gas concentrations normalized to sea level for Coles Hill (D.L. Nelms, U.S. Geological Survey, personal commun., 2009).....	35
Figure 4.18: Alkalinity and DO measurements for south spring area samples	36
Figure 4.19: CFC concentrations for wells sampled at south spring study area.....	36
Figure 4.20: Mixing ratios of Coles Hill samples plotted against piston flow and mixing lines for pre-CFC water and different years (D.L. Nelms, U.S. Geological Survey, personal commun., 2009)	37

List of Tables

Table 4.1: Well construction information for wells at the south spring area at Coles Hill.

* Wells that were logged.....20

Table 4.2: Chemistry and field parameters from sampled wells at Coles Hill34

Table 4.3: Atmospheric tracer concentrations(CFC, SF6) for sampled Coles Hill wells.....37

1.0 Introduction

Upon its discovery in the late 1970's by Marline Uranium Inc., the uranium deposit at Coles Hill, VA, located within the Dan River basin in the Banister River watershed (Figure 1.1), was recognized to be of economic significance (Pincock, Allen & Holt, 1982). Therefore, Marline began working to characterize the deposit. However, after a dramatic drop in uranium prices in the 1980's, Marline abandoned its development of the deposit. Recently, a new company, Virginia Uranium Inc. (VUI), started work on the deposit at Coles Hill. In independent study commissioned by VUI confirmed the existence of 13.8 million kilograms of U_3O_8 at an average grade of 0.216% and 54 million kilograms of U_3O_8 at an average grade of 0.062%(Santoy, 2009). This puts the value of the deposit between \$1.4 and \$7.6 billion according to 2009 market prices. However, in order for any uranium mining to take place at Coles Hill, the moratorium on uranium mining in Virginia must be overturned. One of the main concerns of the general public as well as VUI and the Virginia state legislature is the potential impact that the mining of this deposit would have on the local and regional groundwater system.

Current plans call for uranium mining at Coles Hill to be carried out using open pit methods, and open pit mines operating in areas with a shallow water table impact the local groundwater regime. The extent to which it would affect the groundwater remains in question. The two primary concerns regarding groundwater movement at Coles Hill are dewatering during excavation of the mine and contaminant transport of radioisotopes and any heavy metals off the site (Marline, 1983). It is therefore imperative that groundwater be studied thoroughly at the site to evaluate hydraulic gradients, potential quantities of flow, and the nature of recharge to and discharge from the site. The scope of this investigation does not involve the regional impact of mining operations at Coles Hill. In order to answer such questions a larger scale study would be

required. The aquifer system of the Coles Hill area is highly heterogeneous and has not been characterized as part of this study. Instead, in this investigation a small area just south of the two mapped ore bodies at Coles Hill (referred to henceforth as the south spring study area, Figure 1.2) was characterized to gain a better understanding of how water currently moves through the site. The findings herein, however, may be applicable for characterizing the general nature of specific structural features at Coles Hill.

The Coles Hill uranium deposit is located in the Virginia Piedmont along a normal fault that has been active since at least the Mesozoic and which separates the crystalline rocks of the Piedmont to the west from the Triassic basin metasediments to the east. The hydrogeology of the site is typical of the Virginia Piedmont in that flow occurs primarily in the saprolite and shallow weathered bedrock, or in deeper fractures in unweathered bedrock. Faulting at the site also plays a very important role in how water moves through the subsurface.

While groundwater likely discharges to the Dan River from the fractured rock aquifers it flows through, it is not possible to determine whether groundwater passing through the Coles Hill site discharges to the Dan and Banister Rivers. Such an assessment is beyond the scope of this investigation. The saprolite and fractured bedrock systems in this region are highly complex and the active tectonic history of the region has likely compartmentalized the fractured aquifer systems. Initial studies completed by the Marline Corporation in the 1980's (Lynott, 1985) began to characterize groundwater flow at Coles Hill but many questions remain.

Understanding the nature of flow through the different geologic units at the site will help to constrain how dewatering associated with an open pit mine will affect the ground water in the area. Units acting as barriers or conduits to flow will play a significant role in determining the

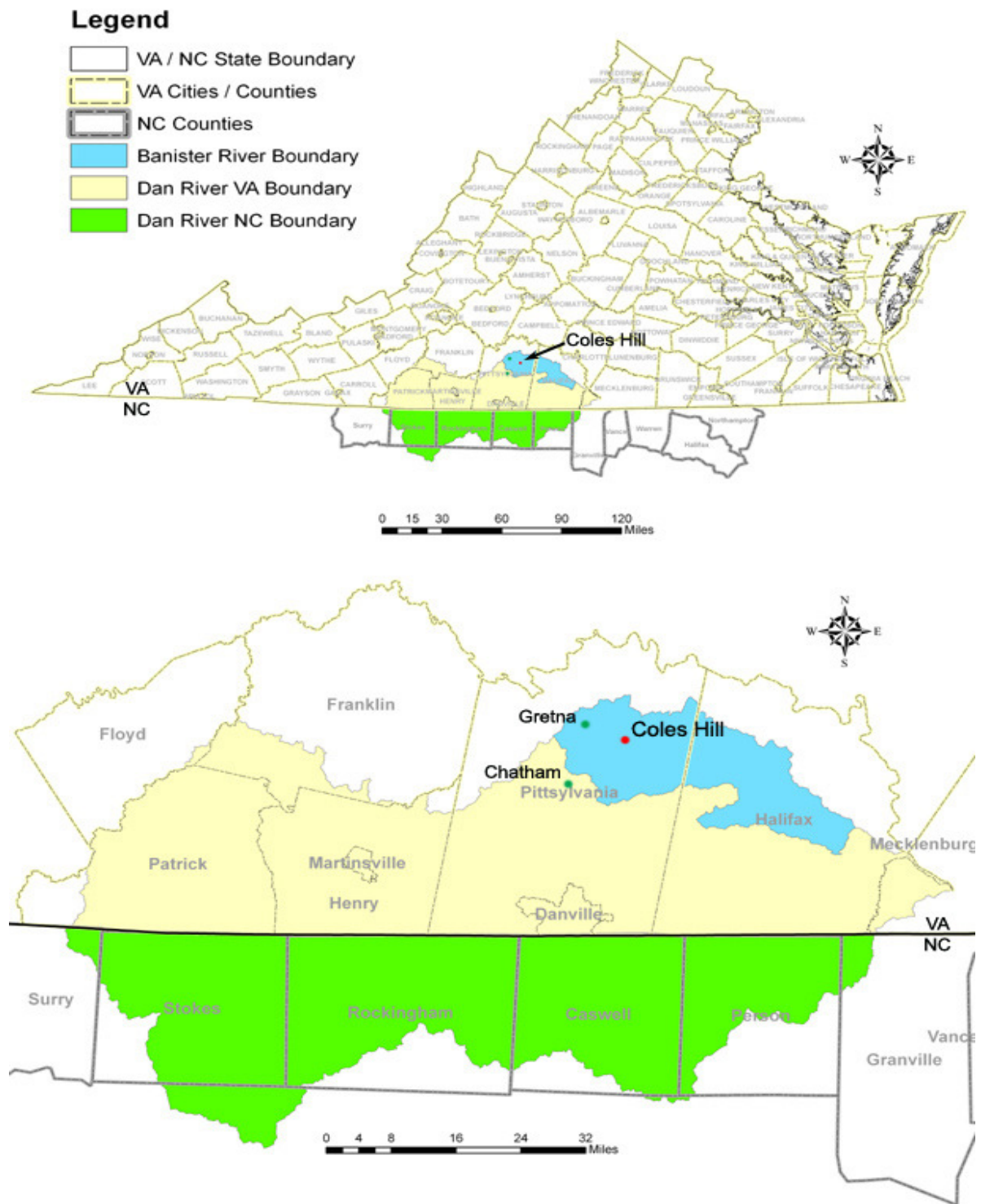

Figure 1.1: Map of the Dan and Banister River basins (Map courtesy of Virginia DEQ, 2009).

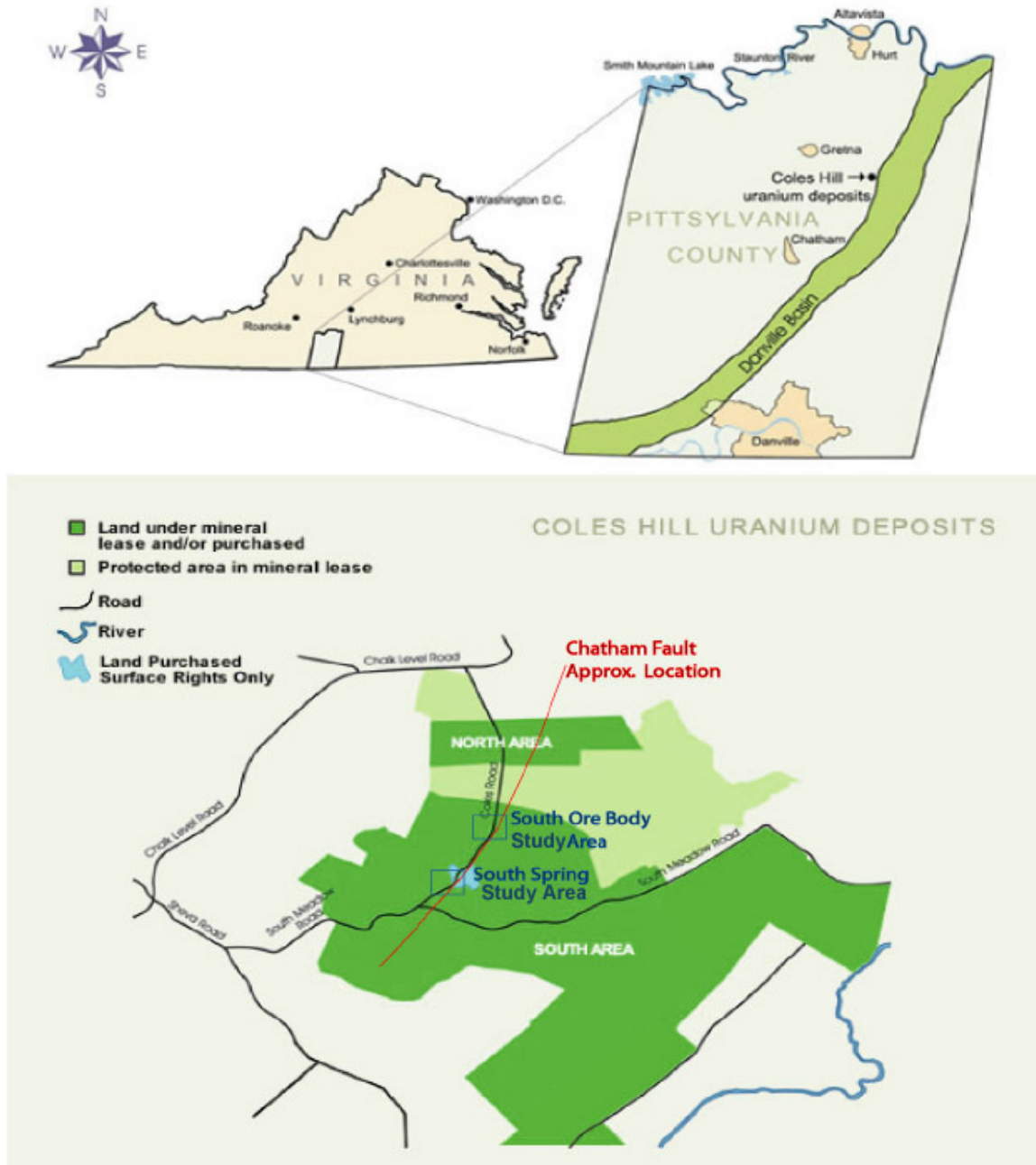

Figure 1.2: Location of the Coles Hill deposit and the locations of the south ore body and south spring study areas (Christopher, 2007).

response of the groundwater in the area to mining. It is therefore important that the hydrogeologic relationship between the geologic units be examined if the potential impact of a mine at Coles Hill is to be understood. This study examines the hydrogeologic relationship among the

three geologic units at Coles Hill, using a variety of different techniques including electrical resistivity, geophysical well logging, pumping tests, age dating, and water chemistry,

2.0 Geologic Setting

The Coles Hill uranium deposit is located in the Virginia Piedmont, near the towns of Chatham and Gretna (Figure 1.2). The Piedmont physiographic province is bordered by the Blue Ridge province to the west and by the Coastal Plain to the east and is divided into an eastern and western section by the Brookneal - Brevard Shear zone (Gates 1997; Hibbard et al., 2003; Carter, et al., 2006;). The western Piedmont zone consists mainly of metaclastic rocks with smaller inclusions of metamorphosed mafic-ultramafic rocks, whereas the eastern Piedmont hosts more metagneous rocks (Hibbard et al, 2003, Carter, et. al., 2006). Coles Hill is located in the western Piedmont, along the Chatham Fault (Figures 2.1 and 2.2); which is a Mesozoic aged northeast striking normal fault (Jerden, 2001). The Chatham Fault forms the eastern boundary of the Coles Hill site, separating the crystalline rocks of the western Piedmont that host the mineralization from the Danville Triassic basin metasediments to the east(Jerden, 2001; Figures 2.1 and 2.2). Mining activity at the site would therefore likely affect the groundwater flow in the crystalline Piedmont rocks, the Chatham Fault zone, and in the Danville Triassic basin.

The crystalline Piedmont rocks to the northwest of the fault can be divided into three distinct lithologic units (Jerden, 2001). From west to east these units are the Leatherwood granite, which is part of the Martinsville Igneous Complex, the Fork Mountain formation mica schist and biotite gneiss, and the Central Virginia Volcanic-Plutonic belt containing quartzofeldspathic augen gneisses interlayed by amphibolites (Jerden, 2001, Mylonite gneiss unit of

Henika, 2002). The foliation of these units dips to the southeast toward the Chatham Fault zone (Figures 2.1 and 2.3)

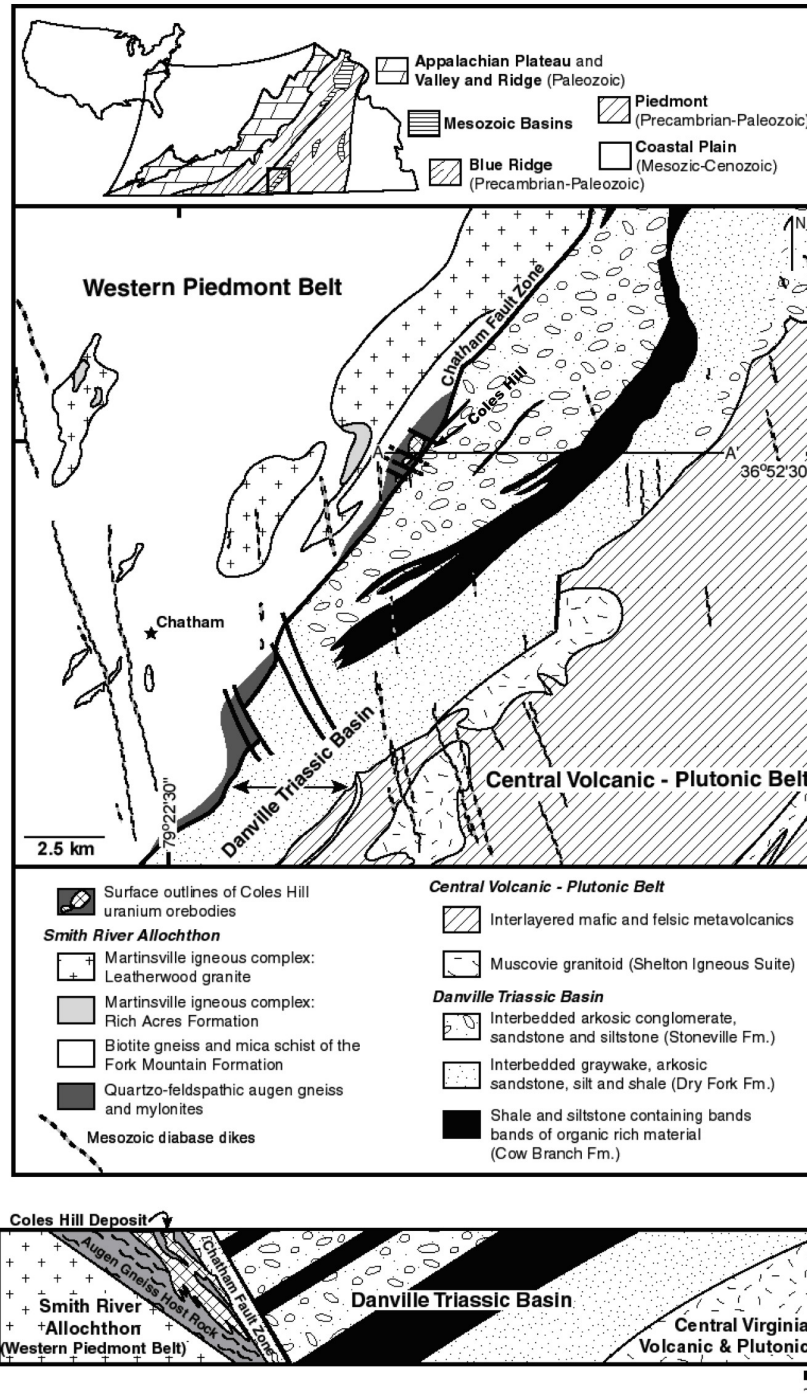

Figure 2.1: Geologic map and cross section of the area surrounding Coles Hill (From Jerden, 2001, adapted from Henika, 1998).

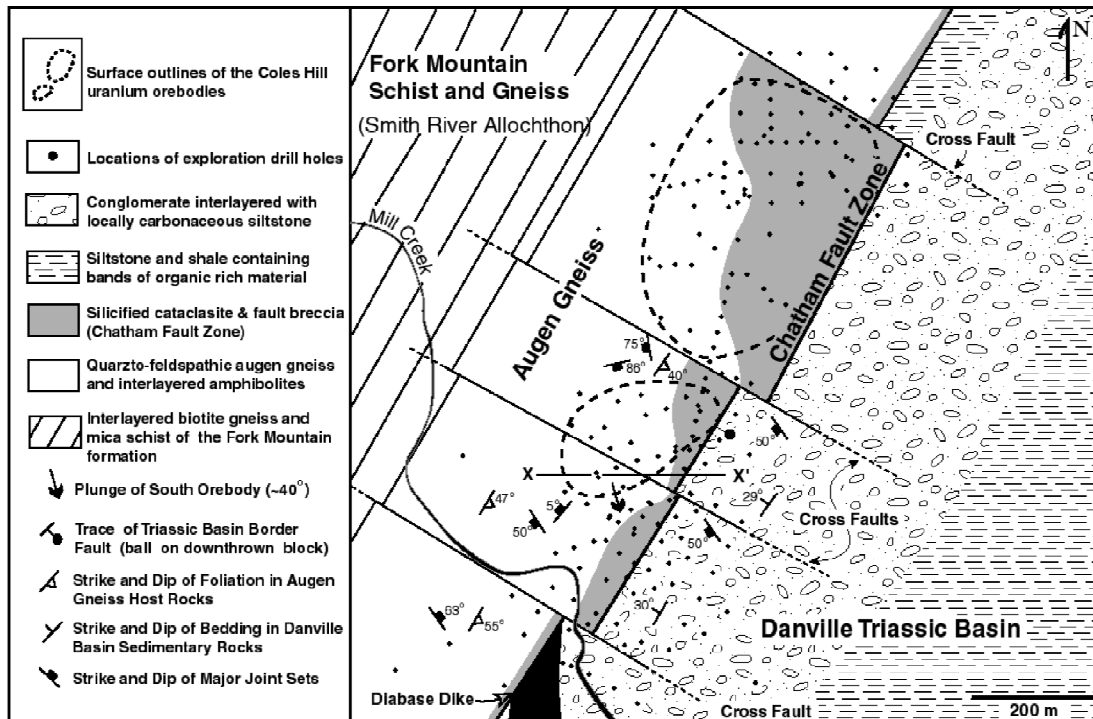

Figure 2.2: Detailed geologic map of Coles Hill (From Jerden, 2001) Based on Henika (1981), Lineberger (1983), and Jerden (2001).

The Chatham Fault zone divides the crystalline Piedmont rocks from the Danville Triassic basin sedimentary rocks. The history of the Chatham Fault zone includes two periods of faulting. The fault first existed as a Paleozoic thrust fault, the product of northwestern terranes being brought together with those of a large volcanic province (Lineberger, 1983, Gates, 1997). The fault was then reactivated by Post-Alleghenian rifting, forming the Danville Basin (Lineberger, 1983, Gates, 1997). Today, the fault and adjoining area to the west is characterized by silicified breccia and cataclasite that separates the crystalline Piedmont rocks from the Triassic basin border fault gouge (Jerden, 2001). The fault zone is estimated from cores to be approximately up to 40 meters thick, with 1-5 meters of noncohesive fault gouge forming the boundary between the fault zone and the Triassic basin (Jerden, 2001). This fault gouge is made

up of an unconsolidated matrix of green and gray clay containing angular pieces of quartz and feldspar (Jerden, 2001).

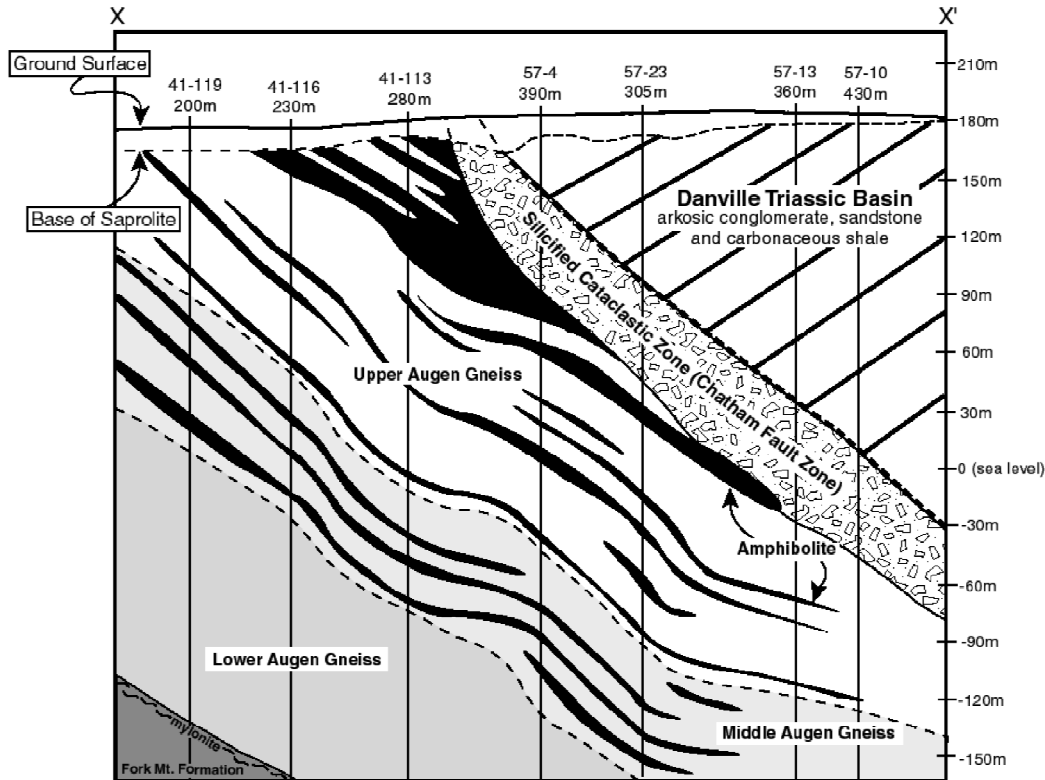

Figure 2.3: Detailed geologic cross section of Coles Hill (From Jerden, 2001 based on Marline Corporation drill hole data (Marline Uranium Corporation, 1983)).

Immediately to the east of the fault gouge is located the Danville Triassic Basin, formed by the post Alleghenian reactivation of the Chatham Fault (Lineberger, 1983). The basin contains primarily arkosic conglomerates with a siltstone matrix (Jerden, 2001); however these rock types are also interfingering with shales, siltstones, and carbonaceous black mudstones (Thayer, 1970, Henika and Thayer, 1983). Like the crystalline rocks of the Piedmont, the Triassic basin metasediments also dip toward the fault zone, at angles that increase toward the fault to about 40 – 50 degrees (Lineberger, 1983; Figure 2.3). The Triassic rocks near the fault contain fractures that are open in some cases and mineralogically sealed in others (Jerden, 2001). The open

fractures can have apertures ranging from 1-10 millimeters (Jerden, 2001) and provide the chief pathways for groundwater flow in the basin.

3.0 Site Hydrogeology

In general, the hydrogeology of the Piedmont is typically described as a simplified two-layered system consisting of a highly heterogeneous regolith overlying a highly variably fractured crystalline bedrock aquifer. The uppermost regolith, or soil zone, supplies water from precipitation to the highly weathered and fractured zone of bedrock referred to as saprolite (Daniel, 1996), which represents the lower regolith. Shallow groundwater typically occurs in the saprolite except during periods of prolonged drought or during the summer months when evapotranspiration can exceed precipitation. Below the regolith water is confined to less weathered fractures in crystalline bedrock. In general, these fractures tend to decrease in frequency with depth (Daniel, 1996). However, significant quantities of groundwater can be attributed to recharge and flow along minimally weathered fractures associated with geologic structures such as faults and lineaments (Seaton and Burbey, 2000, 2005).

At Coles Hill this two-layered system is modified by the presence of the Chatham Fault, which juxtaposes two different rock bodies with potentially different hydrogeologic characteristics and fracture densities (Figure 3.1). Adding additional complexity to the hydrogeologic setting are a number of northwest striking, steeply dipping, cross faults that intersect the Chatham Fault at nearly right angles (Jerden, 2001). These faults are thought to enhance fracture connectivity.

A pumping test was conducted by Gibbs and Hill for Marline Uranium in 1985, but was not intended to be exhaustive in nature (Halliday, 1985). The test was performed with wells

intersecting the Chatham fault, Triassic basin, and the Leatherwood granite. These wells were cased through the saprolite but no effort was made to isolate the different rock types from one another (Halliday, 1985). Because the Chatham fault, Leatherwood granite, and Triassic basin rocks present in the wells were not isolated, the transmissivity calculated from the pumping test tells us little about the complexities present at the site.

The goal of this investigation is to better understand the nature of groundwater flow in the vicinity of the Chatham Fault near the south spring site and to determine whether the fault behaves as a barrier or conduit to groundwater flow or some combination of both. A number of methods were employed to assess the nature of the groundwater flow associated with the fault, including surface electrical profiling, installation and borehole logging of wells near the fault, pumping tests, and chemical analysis and age dating of water from specific fracture zones encountered in the available wells. The following section provides the details of these methods.

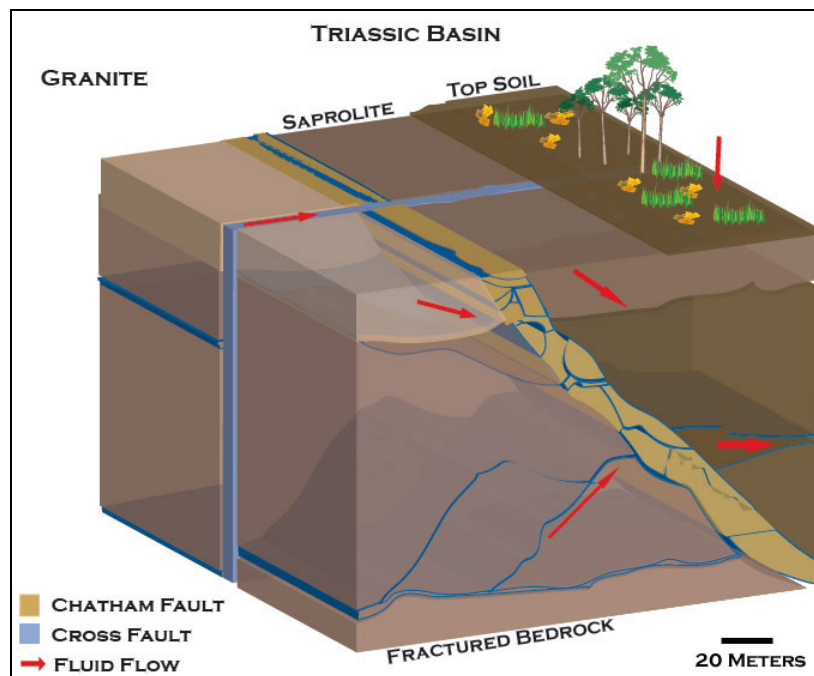

Figure 3.1: Conceptual model of groundwater flow at the south spring study area, Coles Hill, VA.

4.0 Methods

4.1 Electrical Resistivity Profiling

Electrical resistivity profiling is used to map the distribution of resistivity in the subsurface (Seaton and Burbey, 2002). The measured values of resistivity can then be correlated to the potential degree of fluid saturation (Seaton and Burbey, 2002). Data are collected and processed using an AGI SuperSting 8-channel resistivity imaging system. Conductive electrodes were installed in the shallow subsurface along the desired survey transect, which in turn were connected via a cable to the SuperSting that sends a current (C) to two electrodes while two other electrodes (P) measure the electrical potential. The potential difference is measured during a survey from each electrode and converted to a resistance. Resistance varies depending on rock competence, water content, rock type, depth of current penetration, resolution, and sensitivity to telluric noise and resistivity structures (Seaton and Burbey, 2002). The two types of survey configurations utilized in this study were dipole-dipole and Wenner (Figure 4.1). Because its potential probes lie outside the current probes, the dipole-dipole array has high resolution and sensitivity to small areas with much higher or lower resistivity than the surrounding area (Seaton and Burbey, 2002). The dipole-dipole method also has a greater depth of penetration than the Wenner method and is better able to identify vertically oriented structures (Seaton and Burbey, 2002). These characteristics make the dipole-dipole method favorable for a fractured rock environment such as Coles Hill. The Wenner configuration, on the other hand, yields high resolution results, albeit at shallower depths and is best suited for imaging horizontal features such as the water table and the top of bedrock (Seaton and Burbey, 2002). The Wenner method was used to complement and corroborate the results obtained with the dipole-dipole method.

Fourteen two-dimensional electrical resistivity profiles were created at Coles Hill in an effort to locate areas of potential fluid flow as well as to possibly identify the Chatham Fault as either a barrier or a conduit to groundwater flow (Figure 4.2-4.6). Most lines were configured with a dipole-dipole array and were 640 meters long with electrodes spaced 10 meters apart. A Wenner array was used in addition to the dipole-dipole array in lines COL13 and COL14 (Figure 4.6) in order to compare and further confirm the results of the dipole-dipole profiles. COL12 at the south spring area (Figure 4.6) was obtained using 5 meter electrode spacing and a line length of 320 meters to obtain a profile with higher resolution but shallower imaging depth. Data collected with the AGI SuperSting were then inverted using Loke's RES2DINV (Loke, 2006) to obtain a resistivity value. Because of high variations in near-surface resistivity measurements, electrode spacing was halved for many of the inversions.

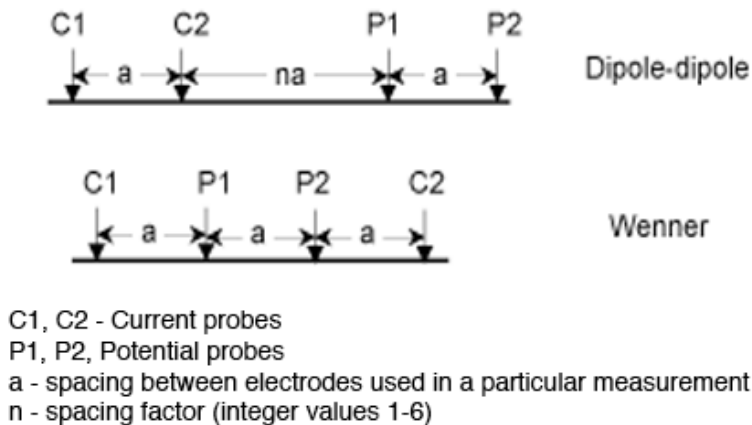

Figure 4.1: Four electrode arrays used for resistivity profiling in this study (From Seaton and Burbey, 2002).

Initial surveys were centered near the Coles house (Figure 4.2), between the north and south ore bodies, due to the relatively certain location of the Chatham Fault and ore body location in the area. COL1 was oriented to cross the Chatham Fault while COL2 was oriented

parallel to the fault and to the west, in the Leatherwood Granite. Initial surveys indicated a low resistivity body associated with the Chatham Fault, but the near surface of the Coles Hill site is otherwise highly heterogeneous (Figures 4.2, 4.3). Lines COL3-COL6 were obtained to complete a grid that would identify potential locations for monitoring and logging wells. Low resistivity sites are seen as potential locations for wells because of a likely higher probability of fracture permeability. Restrictions on drilling due to a historical preservation area

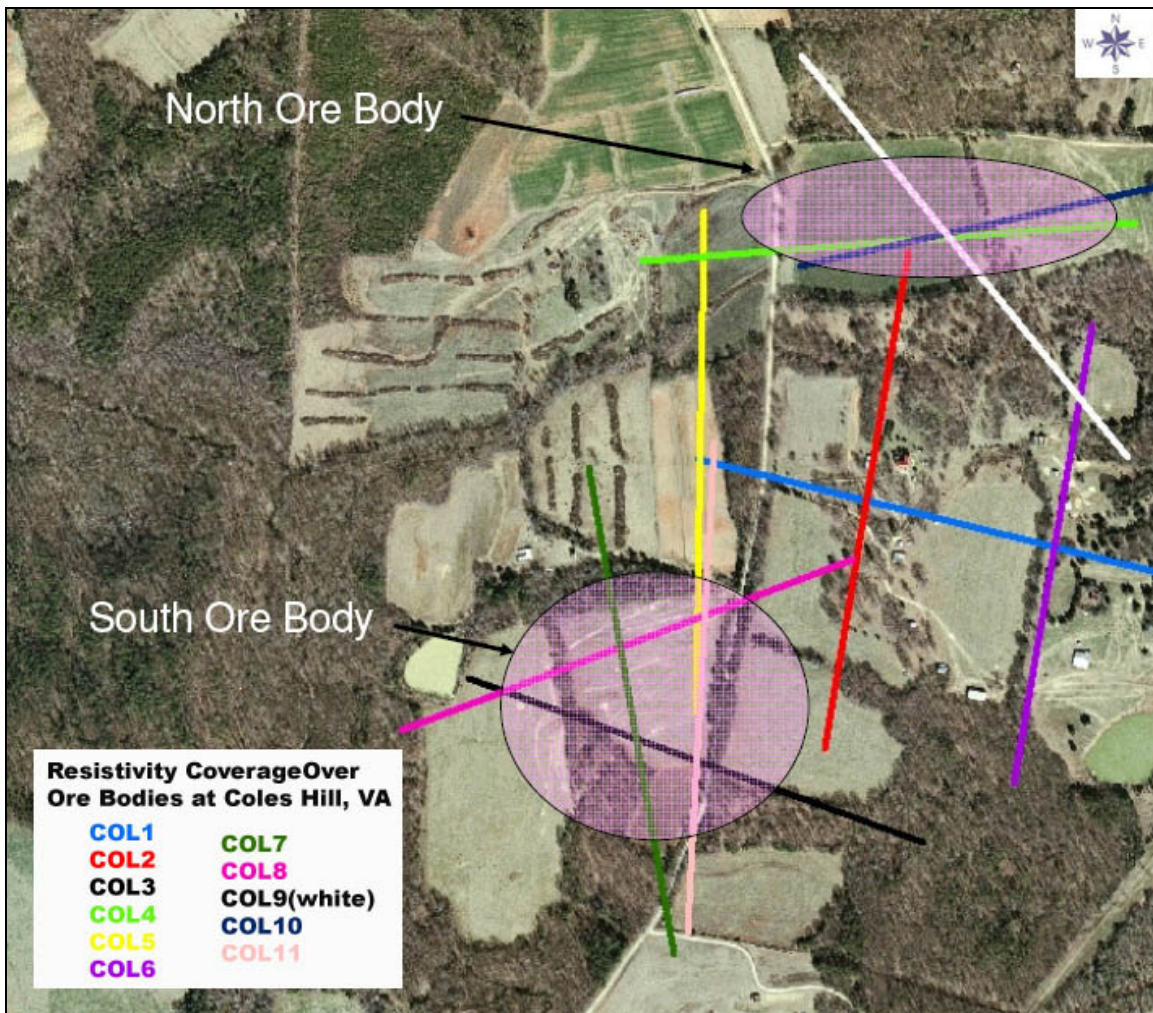

Figure 4.2: Electrical resistivity transects at ore bodies, Coles Hill, VA.

centered in the vicinity of the Coles' home shifted focus to the areas North and South of the Coles' house. COL9 and COL10 (Figures 4.2, 4.4) are located to the North, approximately over

the location of the north ore body and crossing the Chatham Fault. COL7, COL8, and COL11 (Figure 4.5) were obtained to complete a grid over the south ore body, south of the Coles' house.

The resistivity lines centered on the south ore body reveal a number of deep low resistivity areas. These areas appear to trend northwest to southeast across the Chatham Fault. The trends and locations of these anomalies are consistent with cross faults to the main Chatham Fault identified by Marline using magnetic, radiometric, and geological surveys (Figure 2.2). Further restrictions on drilling, however, necessitated locating a different site to install wells for conducting groundwater investigations in the vicinity of the Chatham Fault.

A spring emanating adjacent to the Chatham Fault south of the ore body was considered to be an ideal location to investigate the hydrologic nature of the fault and adjacent geologic units. The spring is located along a local topographic high 5-15 meters to the west of the Chatham Fault. It is also located at the projected intersection of the Chatham Fault with one of the cross faults mapped by Marline (Figure 4.7). Three existing wells are located within 100

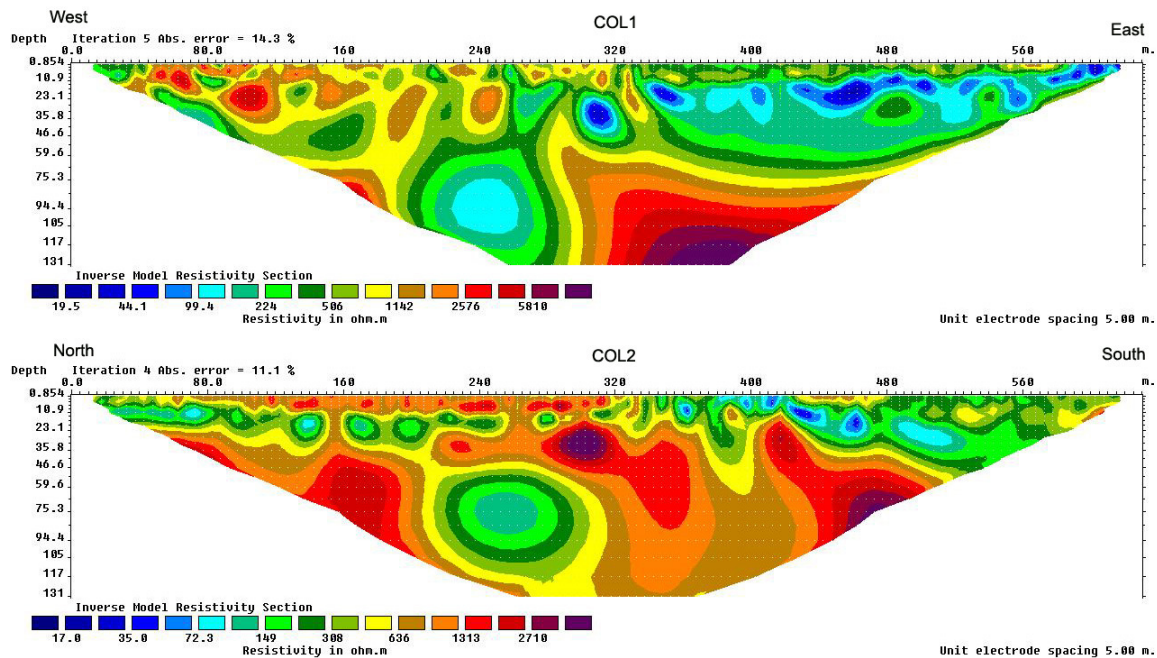

Figure 4.3: Resistivity profiles COL1 and COL2 .

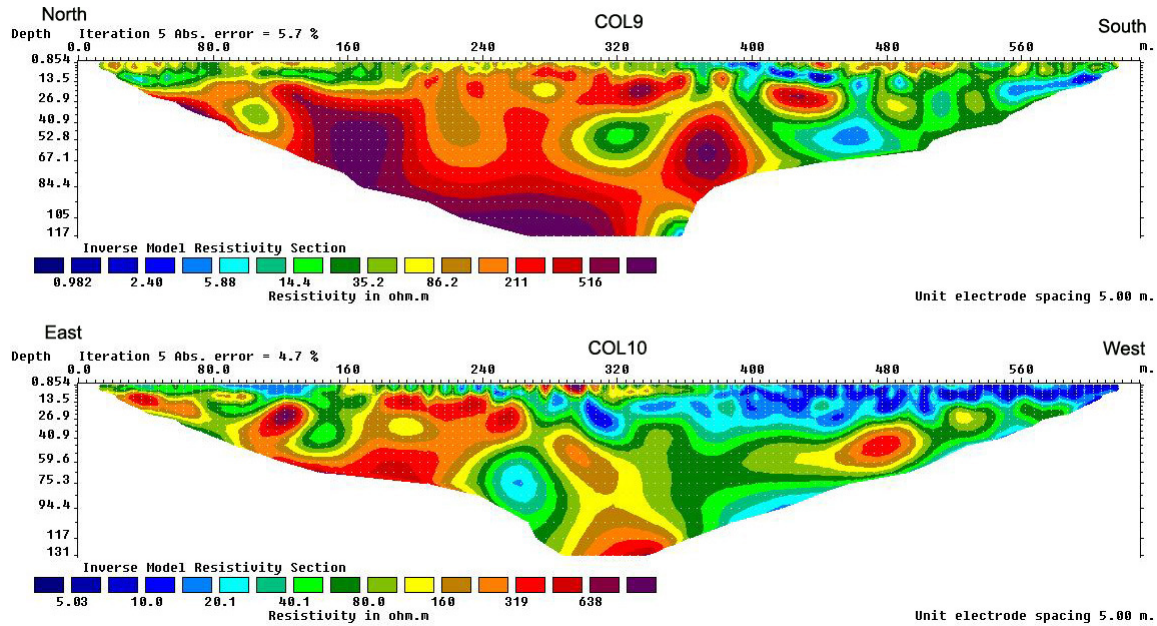

Figure 4.4: Resistivity profiles COL9 and COL10.

meters of the spring (Figure 4.7). One of the wells is located in the Leatherwood Granite (Johns1, ~90 m deep), a second well is located north-east from Johns1 and east of the fault in the Triassic Basin (VAUTrail1, ~90m deep) and the third is an unnamed dug well approximately 15m deep on the granite side of the fault close to Johns1 (Table 4.1, Figure 4.7). The concentration of wells and a spring at the site made it a favorable area for conducting additional resistivity surveys to provide some unification of data by comparing the resistivity profiles over these existing wells with borehole logs (discussed in the next section).

Resistivity line COL12 (Figure 4.6) extended in a east-west position directly over Johns1 and the spring and was collected using a 5 meter electrode spacing to improve imaging resolution in an effort to evaluate the source of the spring water. The profile created from COL12 shows little possibility for any connectivity between the spring and Johns1, as Johns1 appears to be drilled into unfractured bedrock as evidenced by the high resistivity at this site (950 ohm-m). The spring appears to be sourced by a deep fracture based on the resistivity profile over this well. Borehole logging was conducted (described in later section) in Johns1 and VAUTrail after

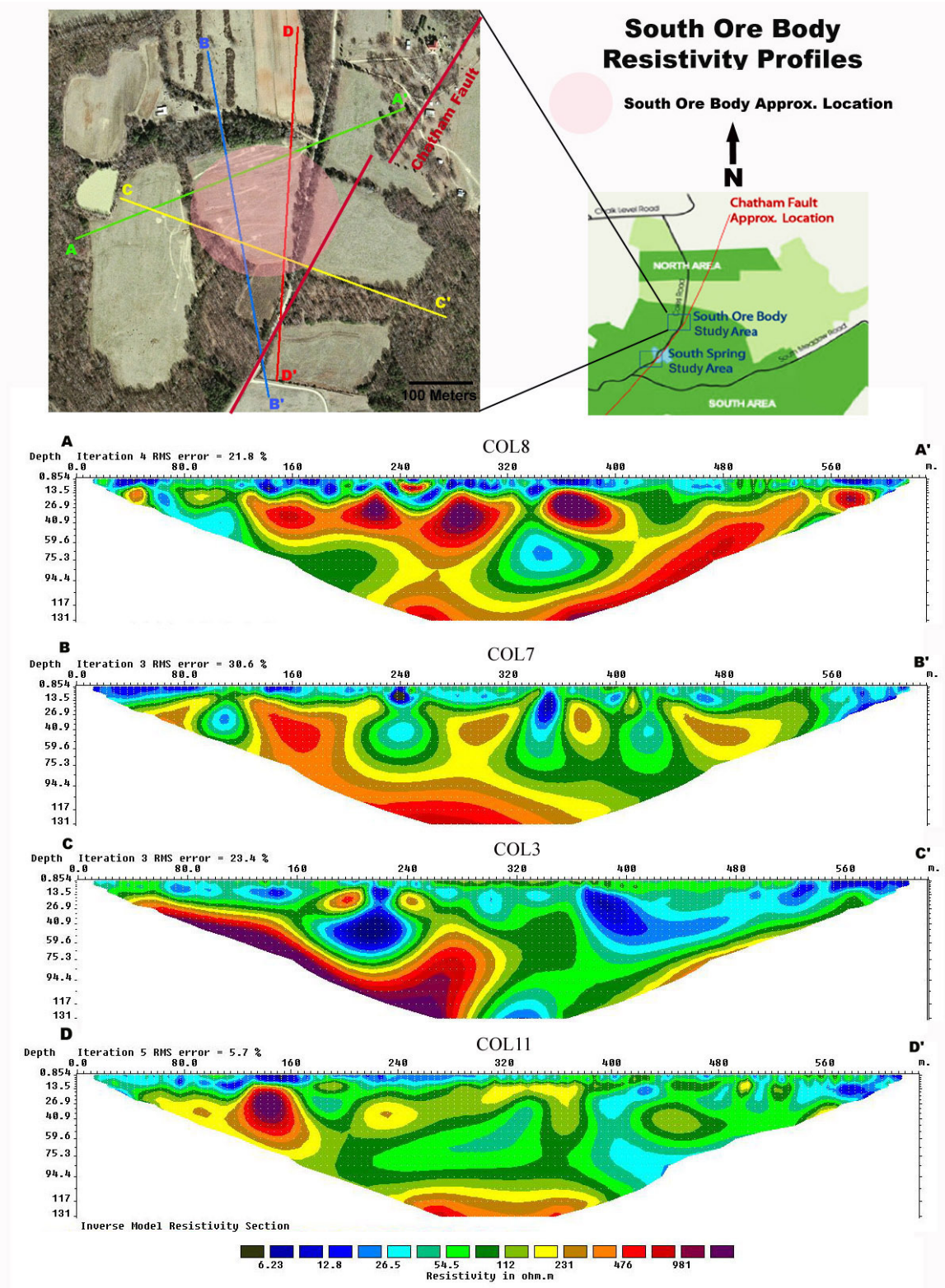

Figure 4.5: Locations and profiles of south ore body electrical resistivity transects.

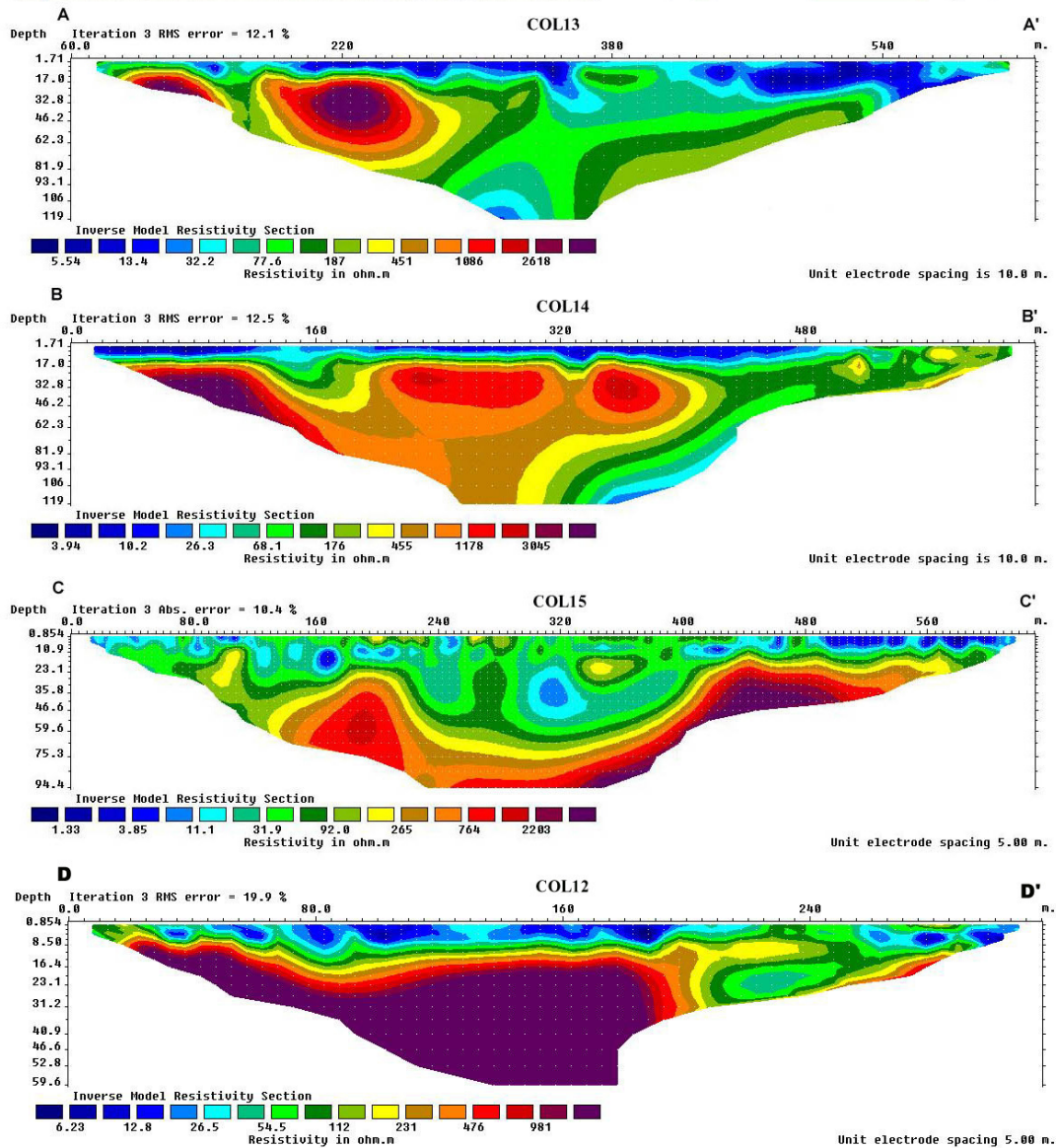
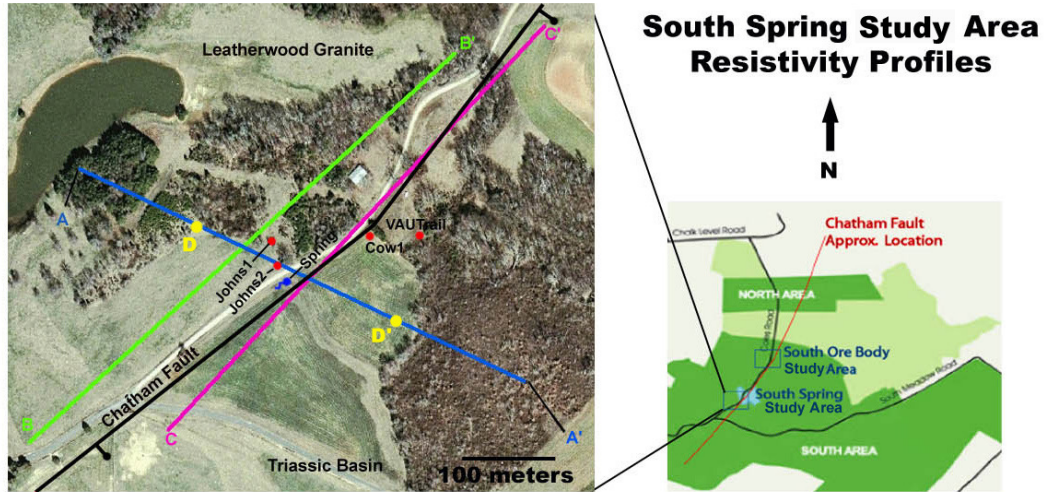

Figure 4.6: Locations and profiles of south spring study area resistivity transects.

creating the resistivity profile COL12 , to locate and identify conductive fractures and to test for hydraulic connection across the Chatham Fault. No connection was found between Johns1 and VAUTrail, and additional resistivity profiles were made to determine the optimal location for installation of two additional monitoring wells to be used for geophysical well logging and aquifer testing to evaluate the hydrologic behavior of the Chatham Fault, Leatherwood granite, and Triassic basin metasediments. One profile was obtained northwest to southeast along the Chatham Fault (COL13; Figure 4.6), a second was located parallel to the fault on the crystalline side of the fault (COL14; Figure 4.6), and a third was oriented directly over the fault at the intersection of the fault and a proposed cross fault (COL15; Figure 4.6). Because of a local bend in the Chatham Fault, COL15 crosses the fault twice. The Chatham Fault can be observed in the COL13 profile as an area of low resistivity (<100 ohm-m), which extends upward from the bottom of the profile to join the area of low resistivity determined to be associated with the spring, indicative of a possible connection between the fault and the spring. It is important to note that while the Chatham fault appears to dip toward the granite in these profiles, this is merely due to the shallow depth of penetration in these profiles, which prohibits an accurate determination of dip. Toward the northwest end of COL13 a small vertical low resistivity area is observed and is interpreted to be a signature of the cross fault. COL14 appears to show the cross fault as a deep low resistivity section and also shows some signs of being close to the low resistance area associated with the Chatham Fault. The profile associated with COL15 shows the Chatham Fault bending away from the profile, and may show the cross fault intersection with the Chatham Fault.

Based on the resistivity profiles from the four lines obtained at the south spring area, the optimal locations for two additional wells were chosen. Originally one well was to be located on

the cross fault in the study area, but due to landowner restrictions on drilling this was not possible. Instead, a well was drilled 10m west of the spring (Johns2; Table 4.1) in an attempt to intercept the fractures sourcing the spring (Figure 4.7). The second new well (COW1; Table 4.1) was sited to intersect the Chatham Fault near its intersection with the local cross fault (Figure 4.7) in order to evaluate the hydrogeologic nature of these cross faults, which are prevalent in the Coles Hill area.

4.2 Geophysical Well Logging

Geophysical well logging was performed in four wells at the south spring area (VAUTrail, Johns1, Johns2, Cow1) and shown in Figure 4.7 in order to locate and further characterize zones of fracturing identified as low resistivity zones. A suite of well logs was obtained using the Mount Sopris MGX II logging system and included caliper, spontaneous potential, fluid resistivity and temperature, 8, 16, 32, and 64 inch normal resistivity, single point resistivity, heat pulse flow meter, natural gamma, and optical televiewer.

The VAUTrail well is located in the Danville Triassic Basin ~30 meters east of the surface-inferred location of the Chatham Fault. While the VAUTrail well is close to the fault there is no evidence from the well logs that the well intersects the fault zone. The logs from the well (Figure 4.8) do however reveal a number of fractures producing flow as indicated by the heat pulse flowmeter, the most prominent fracture occurs at a depth of 55 meters. At this depth all four normal resistivity logs show a dramatic decrease in measured resistivity (Figure 4.8) while the caliper log (Figure 4.8) shows a 3 cm fracture (the drilled borehole diameter is 15.24 cm). The optical televiewer log (Figure 4.9) shows a 1.2-meter long steeply dipping fracture trending slightly north of east to slightly south of west, approximately orthogonal to the Chatham

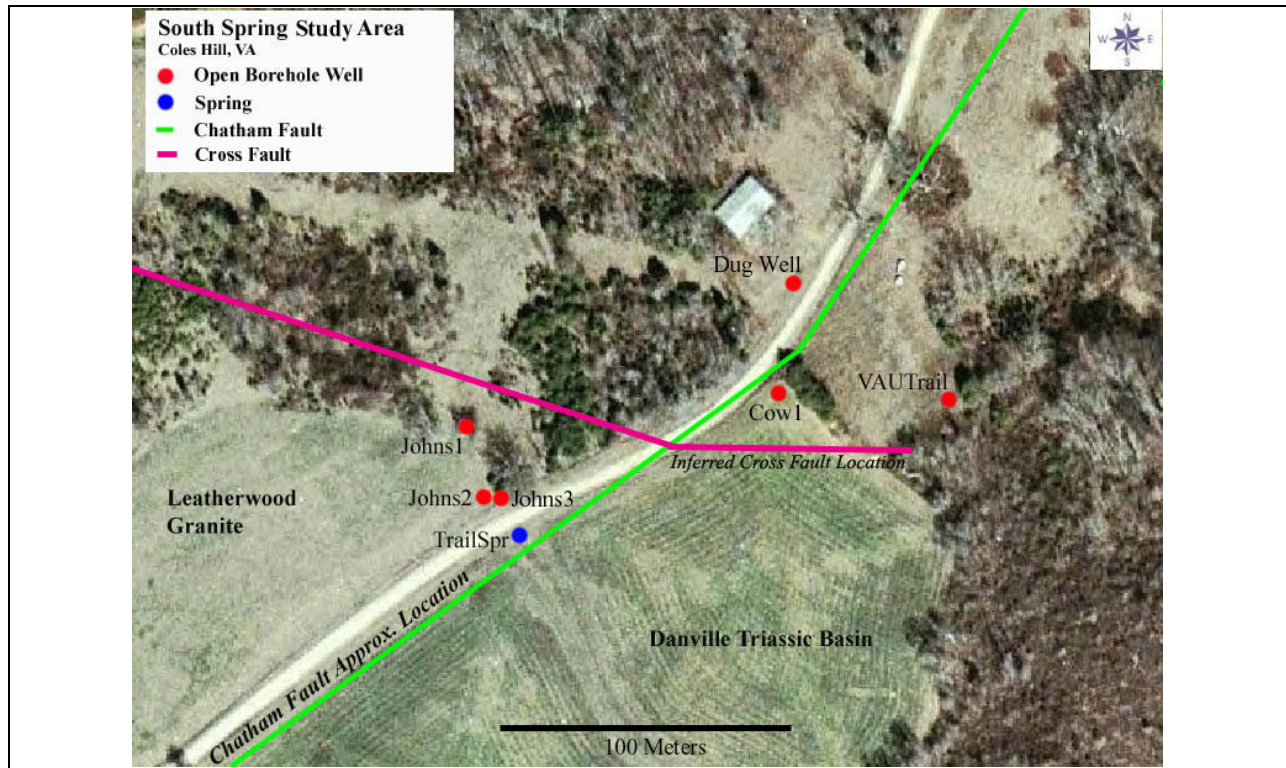

Figure 4.7: Well and spring locations at the south spring study area. Wells logged include: VAUTrail, Cow1, Johns1 and Johns2.

Well Name	Depth (m)	Cased Depth (m)	Rock Type
Johns1*	80	No casing	Granite
Johns2*	183	14.2	Granite
Johns3	12	No casing	Saprolite
Cow1*	183	12	10-30m: Chatham Fault Zone 30-183m: Granite
VAUTrail*	80	11.8	Triassic basin metasediments
Dug Well	13.64	No casing	Saprolite

Table 4.1: Information for wells at the south spring area at Coles Hill. An asterisk indicates wells that were logged.

Fault. The dip of the fracture is calculated to be 83 degrees from the optical televiewer log (Figure 4.9). Additionally the heat pulse flow meter log identifies this area as one associated with flow (Figure 4.8).

Johns1 is located in the Leatherwood Granite ~50 meters west of the Chatham Fault (Figure 4.7). The logs from Johns1 (Figure 4.10) corroborate the resistivity profile obtained directly over it, which shows it to be a minimally fractured section of granitic rock. However, small quantities of flow were detected at a number of depths according to the heat-pulse flow meter (Figure 4.10). The fractures producing flow are located at 60 m below land surface.

Johns2 is located ten to fifteen meters closer to the Chatham Fault than Johns1 (Figure 4.7). Despite intersecting a zone shown to have low electrical resistivity (COL13; Figure 4.6), Johns2 is very similar to Johns1. The geophysical logs show very few fractures, some of which have minimal flow associated with them (Figure 4.11). Total production from the well bore is less than 2 L/min and the production zones are at fractures located between 20 and 60 meters below land surface. Not all fractures produce flow, as the zone between 88m and 98m is shown to be fractured by caliper and resistivity measurements but has no flow associated with it (Figure 4.11).

Cow1 is located five to ten meters east of the Chatham Fault in the Triassic basin (Figure 4.7). At depths between 10-30m, the caliper, optical televiewer, resistivity, and heat pulse flow meter all indicate a highly fractured zone with some associated flow (Figure 4.12). This zone was further confirmed to be the Chatham Fault zone after analysis of cuttings from the drilling process (Henika, personal commun., 2009). Below a depth of 30m the well passes into Leatherwood granite similar to that observed in Johns1 and Johns2. The logs confirm the presence of few fractures with small amounts of associated flow (Figure 4.12). The fractures producing flow are located at 70-100m and 30-50m below land surface.

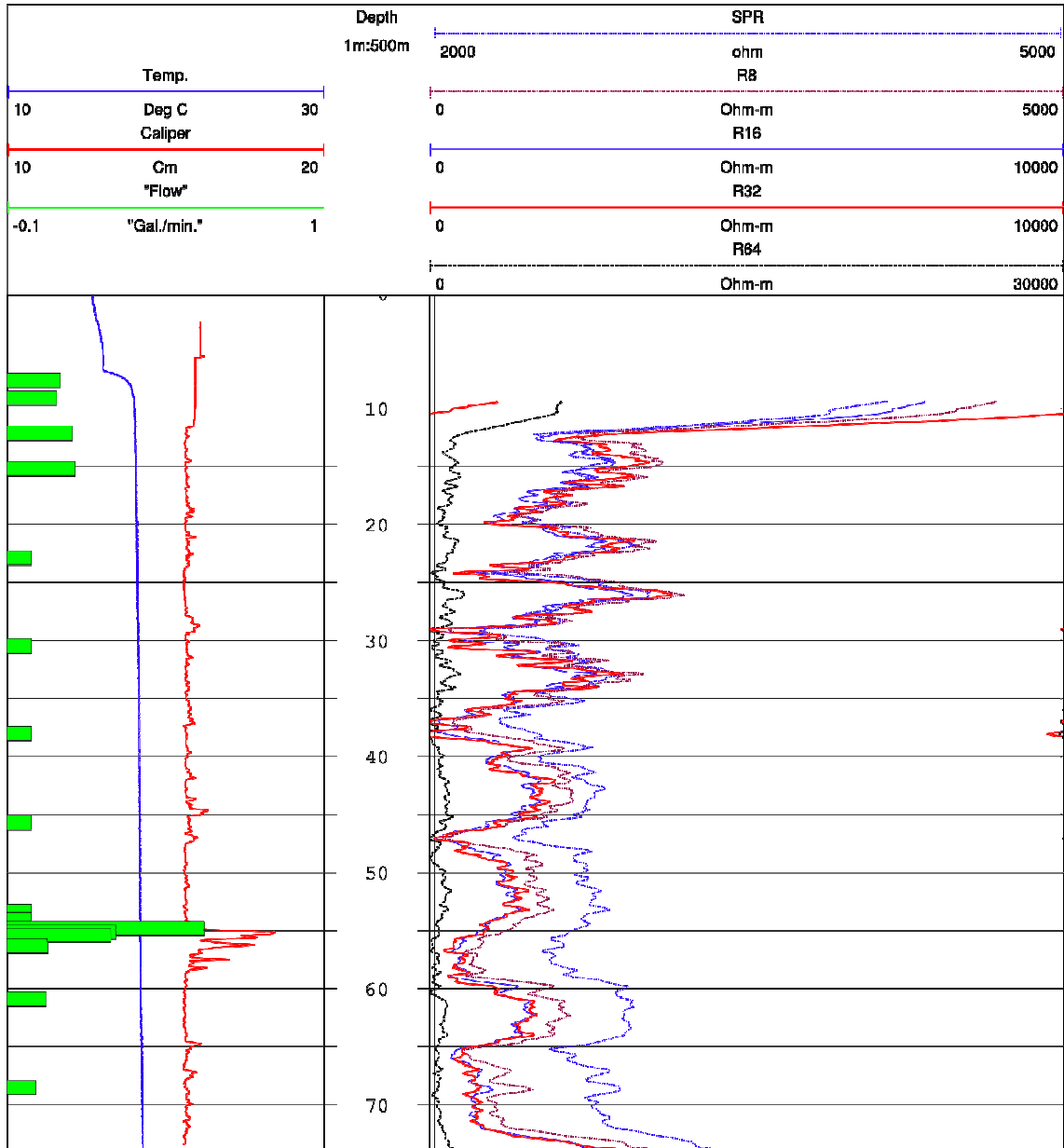

Figure 4.8: Eight, 16, 32, and 64 inch normal resistivity, single point resistance, fluid temperature, caliper, and heat pulse flow meter logs for the VAUtrail well.

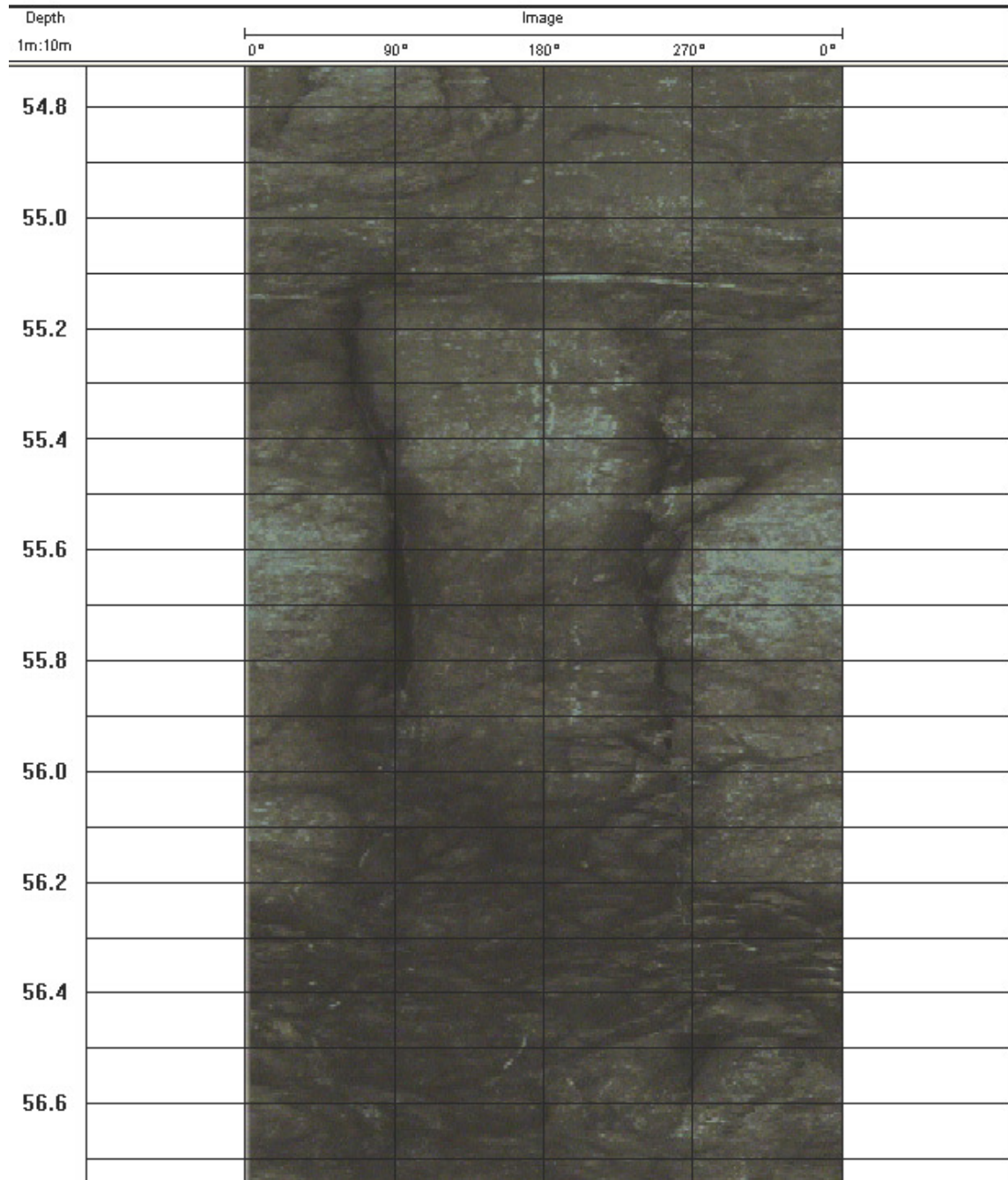

Figure 4.9: Optical televiewer log of fracture at 55m in VAUTrail well (fracture determined to be dipping at 82.76 deg).

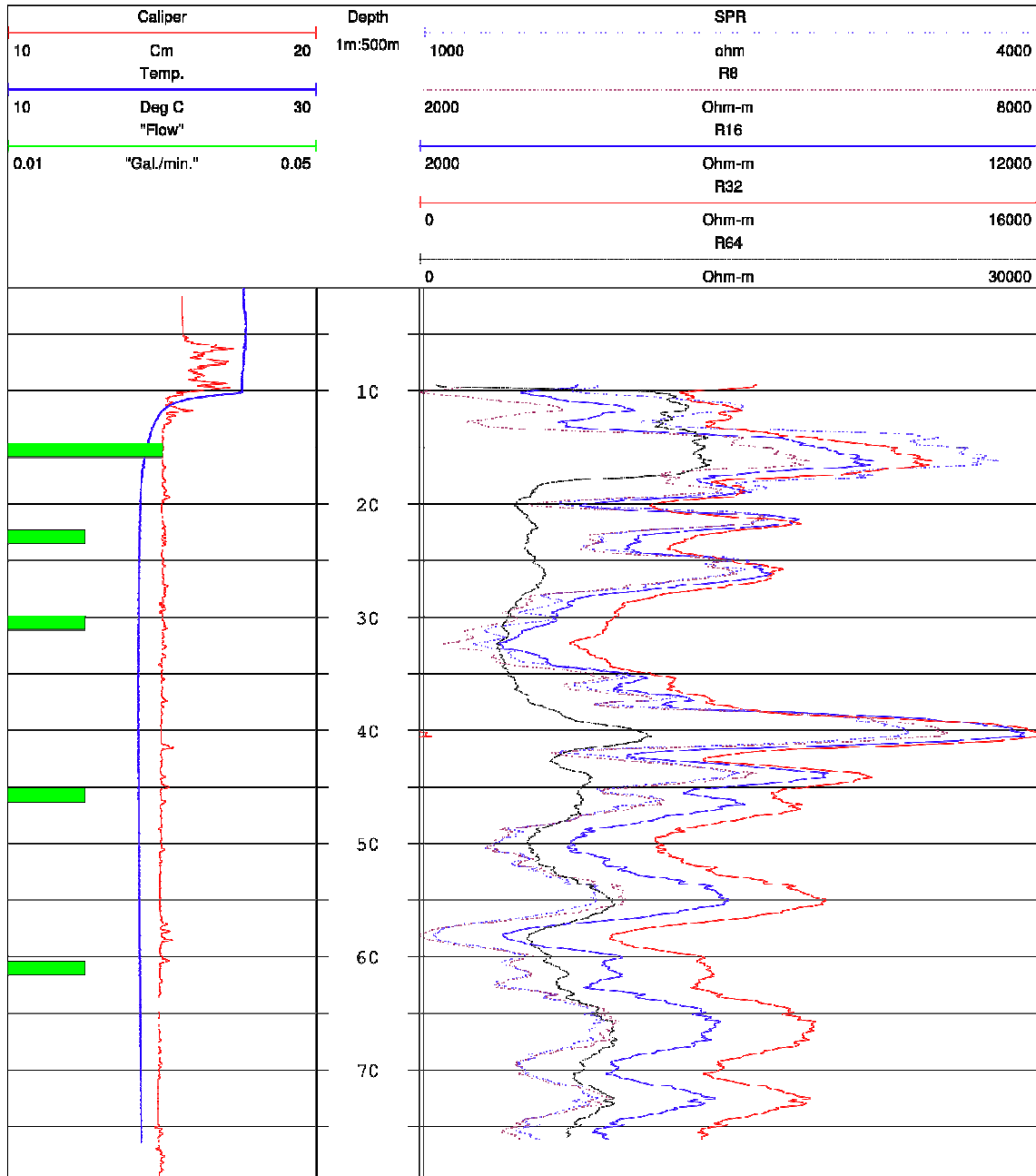

Figure 4.10: Eight, 16, 32, and 64 inch normal resistivity, single point resistance, fluid temperature, caliper, and heat pulse flow meter logs for the Johns1 well.

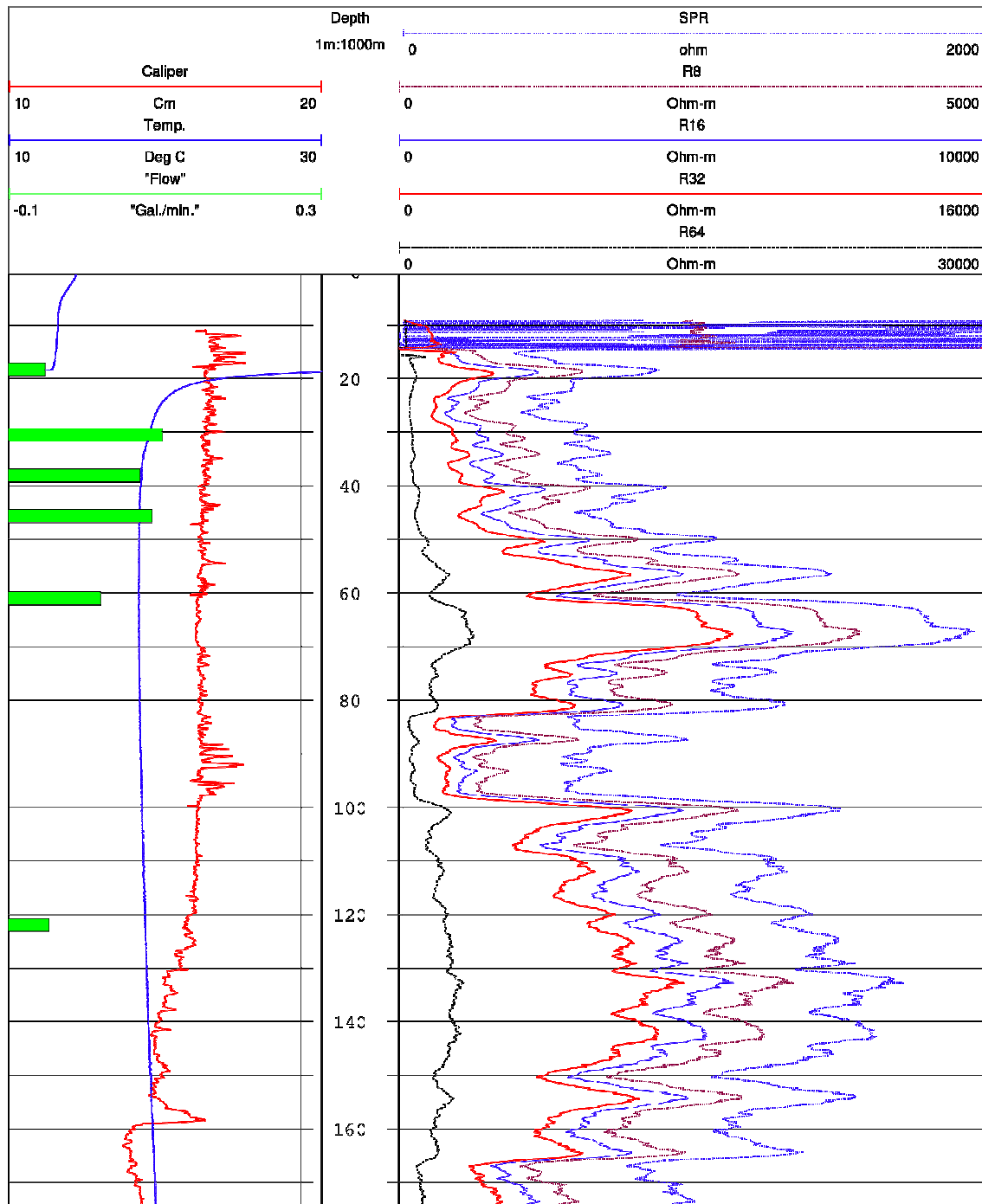

Figure 4.11: Eight, 16, 32, and 64 inch normal resistivity, single point resistance, fluid temperature, caliper, and heat pulse flow meter logs for the Johns2 well.

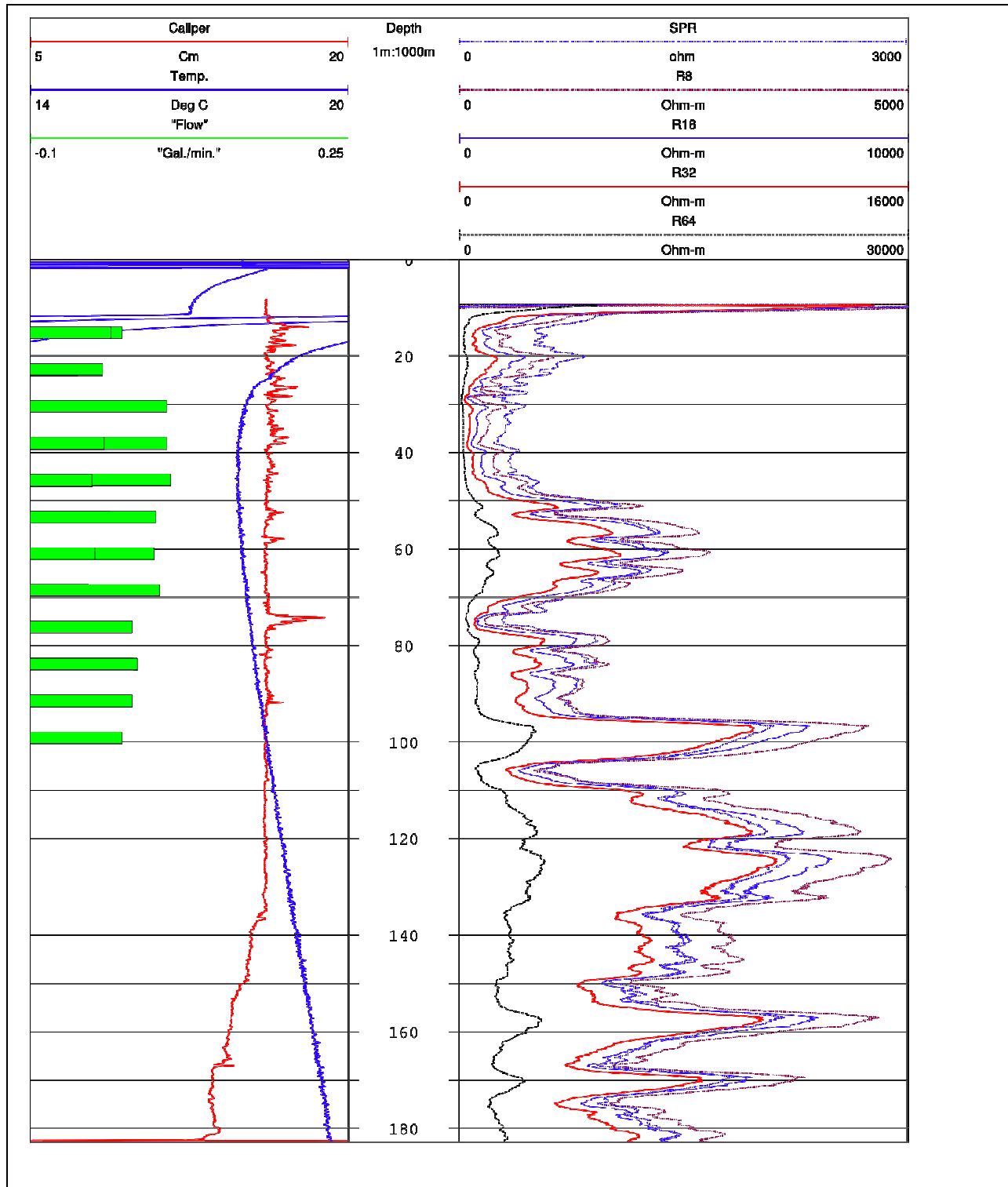

Figure 4.12: Eight, 16, 32, and 64 inch normal resistivity, single point resistance, fluid temperature, caliper, and heat pulse flow meter logs for the Cow1 well.

4.3 Water Levels

Water levels were recorded for a number of wells and for the spring at the south spring area to evaluate the natural hydraulic gradient of the area. On the west side of the fault in the Leatherwood granite, natural water levels were measured in Johns2 and Johns3. Johns2 is cased through the saprolite and only open to fractures in the granite while Johns3 is an open borehole, which is drilled only to the top of bedrock at a depth of 12 m. The water level in the granite fractures is 7.7 meters lower than that of the saprolite, and the saprolite water level between the saprolite in Johns3 and the spring illustrates that the spring is not sourced from the saprolite at this location. The Cow1 well intersects the Chatham Fault zone, and also has a water



Figure 4.13: Inferred potentiometric surface of fractured rock aquifer at the south spring area of Coles Hill.

level 6.39 meters below that of the spring. The VAUTrail well in the Triassic basin has a water level 1.32 meters lower than that of the Cow1, which intersects the Chatham Fault. Figure 4.13 is an estimated potentiometric surface within the deep fractured rock aquifer at the site.

4.4 Pumping Test

A pumping test was performed at the VAUTrail well to determine whether there was any fracture connectivity between this well and observation wells COW1 and Johns2, and to estimate the hydraulic properties of any connected fractures by observing the time-drawdown response at these two observation wells. The VAUTrail well was pumped for a period of 24 hours at a rate of 38.75 L/min. COW1 is located 65.5m from VAUTrail and extends through the fault zone into the underlying Leatherwood granite. A packer was placed at the transition between the fault material and the underlying granite at a depth of 32.9 m below land surface in order to monitor water levels in each zone independently. The upper zone located in the Chatham Fault is referred henceforth as Cow1_upper, while the lower zone located in the Leatherwood granite is referred to as Cow1_lower. After equilibration of the heads in each zone, transducers were installed to monitor both zones during the pumping test. Johns2 is located 176.78m from VAUTrail and was monitored with a transducer. All transducers collected water-level data at one-minute increments during the 24-hour test.

At the end of the 24-hour pumping test, the resulting total drawdown in pumping well VAUTrail was 11.35m. The hydraulic head in COW1_upper (in the Chatham Fault zone) declined 0.45 meters. The hydraulic head in the Leatherwood granite of Johns2 declined 0.3 meters. Figure 4.14 shows the results of the pumping test from these two wells. The head in the Chatham Fault in COW1_upper began responding to pumping after about 37 minutes while the

head in the more distant granitic rocks of Johns2 began responding after 110 minutes of pumping (Figure 4.14).

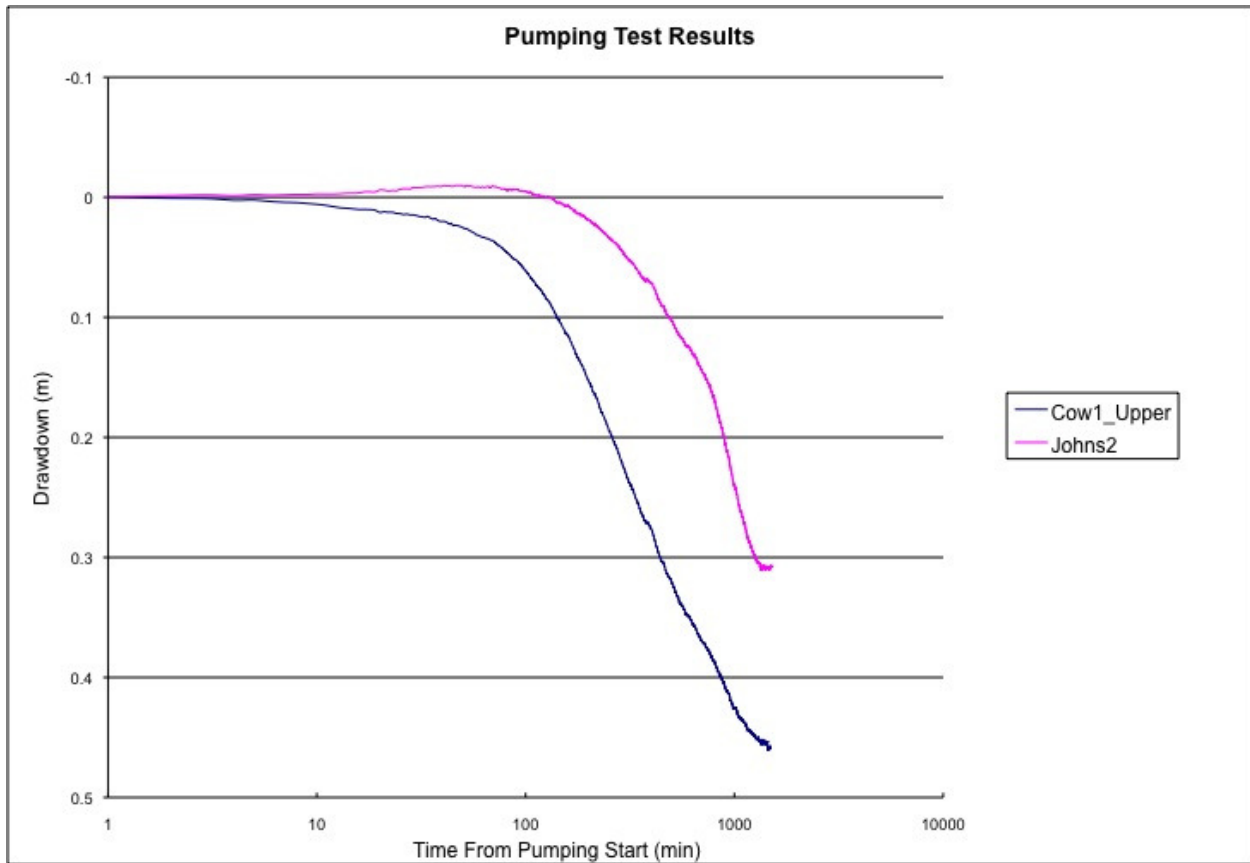

Figure 4.14: Cow1_upper and Johns2 response to pumping of VAUTrail.

Transmissivity and storativity are calculated using the time-drawdown response for both wells using the Barker method as described in LeBorgne, et al., (2004). The assumptions of the Barker method include scale-dependant permeability and storativity in heterogeneous (fractured) rocks (LeBorgne, et al., 2004). These assumptions describe the Coles Hill site better than those assuming scale independent parameters, which are unrealistic in the fractured and faulted environment of this site. In accordance with the Barker method, the responses of the two wells are fitted to a various type curves describing flow in an n -dimensional sphere where $1 < n < 3$ (LeBorgne, et al., 2004; Figure 4.15). The analytical solution for the drawdown according to the Barker method as presented by LeBorgne, et al., (2004) is:

$$s(r,t) = h_o(r) \Gamma\left(\frac{n}{2}-1, \frac{t_c(r)}{t}\right) \quad (1)$$

where Γ is the (complementary) incomplete gamma function given by

$$\Gamma(v,u) = \int_u^{\infty} e^{-t} t^{v-1} dt, \quad (2)$$

and where $s(r,t)$ is the drawdown at distance r and time t . The characteristic time t_c and characteristic amplitude h_o are used to calculate the transmissivity (T) and storativity (S) as follows:

$$t_c = \frac{Sr^2}{4T} \quad (3)$$

$$h_o = \frac{Qr^{2-n}}{4\pi^{\frac{n}{2}}T} \quad (4)$$

Characteristic time is the time elapsed from the start of the pump test to the inflection point of the drawdown curve (LeBorgne, et al., 2004).

The Cow1_upper response was determined to fit the type curve $n=1.2$, which leads to a transmissivity of $5.8 \times 10^{-3} \text{ m}^2/\text{sec}$ and a storativity of 1.2×10^{-3} using equations 3 and 4. The response of Johns2 was determined to fit the type curve $n=1$, which leads to a transmissivity of $1.27 \times 10^{-10} \text{ m}^2/\text{sec}$ and a storativity of 1.08×10^{-10} .

These results suggest Johns2 is drilled into a less transmissive zone with lower available storage. This is confirmed by observation of the Mandel-Cryer effect, a slight increase in hydraulic head just before the decrease in head level associated with the pumping test drawdown (Gibson, et al., 1963, Verruijt, 1969; Wang, 2000; Figure 4.14). This effect has been shown to be associated with a fracture of low transmissivity and storativity. Pumping at VAUTrail caused a contraction of the fracture. Strain compatibility requires that a pore pressure

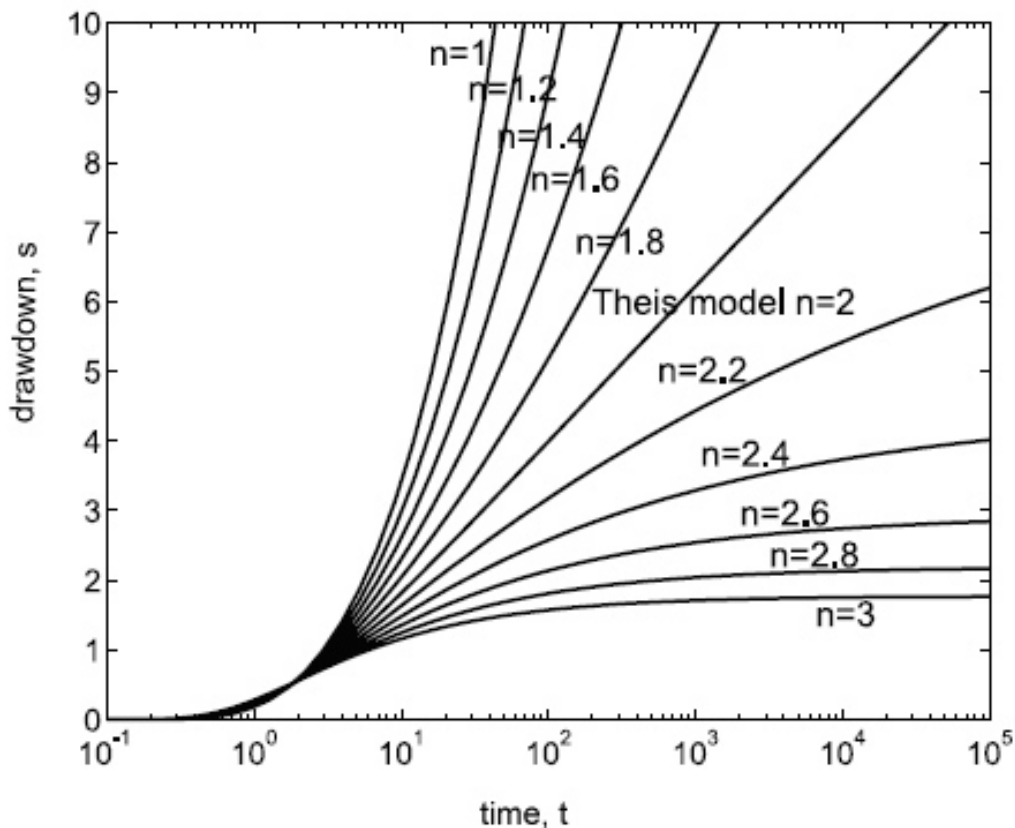

Figure 4.15: Dimensionless drawdown vs. dimensionless time for different values of the fractional flow dimension n (From LeBorgne, 2004).

buildup occur at the leading edge of the pressure wave extending radially outward from the pumping well. A buildup in pore pressure is therefore observed at Johns2 prior to a decrease in pressure. The large duration of this effect (between 20-100 minutes after the start of pumping) implies that the fracture probably has an aperture of microns or perhaps 10's of microns. The estimated T and S from the Barker method along with the drawdown response suggest a very small, but hydraulically connected, fracture.

4.5 Water Chemistry and Age Dating

Water samples were collected from VAUTrail, Johns2, and Cow1. Cow1 was packed off and sampled in the Chatham Fault zone and in the underlying granitic rocks. These samples were analyzed for field parameters, major cations and anions, dissolved gases to determine recharge temperatures, and CFC's and SF6 as environmental tracers (Tables 4.2 and 4.3, Figures 4.16, 4.17, 4.18, 4.19, 4.20). Samples were collected by members of the US Geological Survey and with methods adhering to the standards set forth at <http://water.usgs.gov/lab>.

CFC and SF6 concentrations were measured to determine a recharge date for the water samples. A recharge date effectively provides an age from the time that water entered the flow path to when it is collected at the well site. Chlorofluorocarbons, or CFCs, are manmade organic compounds that were introduced into the earth's atmosphere at detectable levels beginning in the 1950's (Cook and Solomon, 1997). Sulfur hexafluoride or SF6 occurs both naturally and as a man made compound whose production also increased greatly in the 1950's (Busenberg and Plummer, 2000). Once water enters the saturated zone of an aquifer it holds the unique signature of the gas concentration present in the atmosphere at the time it recharged. Therefore, if a sample is analyzed for CFCs or SF6, the concentrations can be compared to atmospheric concentrations in the past to obtain an apparent age (Cook and Solomom, 1997).

In areas where water moves through fractured rock, such as at Coles Hill, groundwater ages are sometimes best estimated by a binary mixing model (Plummer, et. al., 2003). In this model, it is assumed that water of one age containing a certain CFC concentration is mixing with old water, recharged before the CFCs were present in the atmosphere; that is pre-1950's (Plummer, et. al., 2003). Therefore, the age of the water containing CFCs can be determined by

plotting two of the tracers against one another (Plummer, et. al., 2003). Figure 4.20 is an example of such a comparison. A data point falling on the solid black line would be indicative of piston flow, where groundwater of only one age is present in the sample, whereas water falling on any of the colored lines would be indicative of the presence of water of that corresponding line's age along with pre CFC water (Plummer, et. al., 2001). The position of the point on this line indicates what percentage of young post-CFC water is present in the mixture (Plummer, et. al., 2003). A point plotted exactly half way along one of the mixing lines would therefore contain 50% water from the date of the mixing line and 50% pre-CFC water (Plummer, et. al., 2003).

The samples from the fault zone (Cow1_upper) were determined to be contaminated and degassed due to a packer leak (D.L. Nelms, U.S. Geological Survey, personal commun., 2009). The CFC concentrations in the VAUTrail well indicate that it is primarily sourced by old (>60 years) water, with a small amount of mixing with younger water (Figure 3.19; Table 4.3). Very low SF6 concentrations, while beyond the limits of the method, indicate water at the very old end of the young water spectrum (D.L. Nelms, U.S. Geological Survey, personal commun., 2009; Table 4.3). Cow1_lower and Johns2, both in the granitic Piedmont rocks, show signs of young and old water mixing (Figure 4.20). Cow1_lower appears to contain 42.5% water dated at 21.9 years, while Johns2 was calculated to contain 70% water dated to 23.4 years. The lower content of young water in Cow1_lower may be explained by its proximity to the Chatham Fault zone. Both samples from the granitic Piedmont rocks have anomalous SF6 concentrations that may be explained by a terrigenous SF6 source (D.L. Nelms, U.S. Geological Survey, personal commun., 2009; Table 4.2).

The water chemistry results show VAUTrail, Johns2, and Cow1_lower to contain similar aged water (Figure 4.16). The VAUTrail well samples, however, have higher alkalinity and lower dissolved oxygen (Figure 4.18; Table 4.2). Recharge temperatures were also calculated for these samples by plotting N₂ and Ar concentrations on Figure 4.17 (Plummer, et. al., 2001; D. L. Nelms, U.S. Geological Survey, personal commun., 2009; Table 4.2). The VAUTrail sample is shown to have a lower recharge temperature than the samples from Cow1_lower and Johns2. According to the age dating results, dissolved oxygen (DO), alkalinity, and estimated recharge temperature, the water from VAUTrail appears to be from a different source than the two wells in the granitic Piedmont rocks. However, the nearly identical chemistry of these samples, as well as the local natural hydraulic gradient, suggests that the source of the VAUTrail well, while different from that of Johns2 and Cow1_lower, is also from the granitic Piedmont rocks.

Sample Name	Temp Deg C	pH	DO (mg/L)	Alk mg/L CaCO ₃	N ₂ (mg/L)	Ar (mg/L)	Recharge Temp (deg C)
VAUTrail	15.2	7.6	1.3	199	24.35	0.8007	8.3
Cow1 Lower	15.5	7.5	2.3	137	23.01	0.7026	15.2
Cow1 Upper	16.0	7.0	0.8	109	0.00	0.0000	99.4
Johns2	15.3	7.4	4.8	128	20.63	0.6804	14.9
Anion Analysis (mg/L in solution)							
Sample Name	F	Cl	Br	NO ₃ -N	SO ₄		
VAUTrail	0.0448	10.1631	0.183		10.3994		
Cow1 Lower	0.2533	7.2636	0.4932	0.0401	7.3794		
Cow1 Upper	0.2108	5.955	0.06	0.4419	4.2305		
Johns2	0.1614	3.8827	0.0603	0.3544	19.91		
Cation Analysis (mg/L in solution)							
Sample Name	Ca	K	Mg	Mn	Na	Si	Sr
VAUTrail	46.367	2.825	17.274	0.043	17.606	23.247	0.596
Cow1 Lower	37.742	1.122	11.886	0.087	9.291	21.931	0.398
Cow1 Upper	29.392	1.029	8.538	0.255	7.769	16.437	0.171
Johns 2	43.269	1.322	6.177	0.078	9.396	24.905	0.299

Table 4.2: Chemistry and field parameters from sampled wells at Coles Hill.

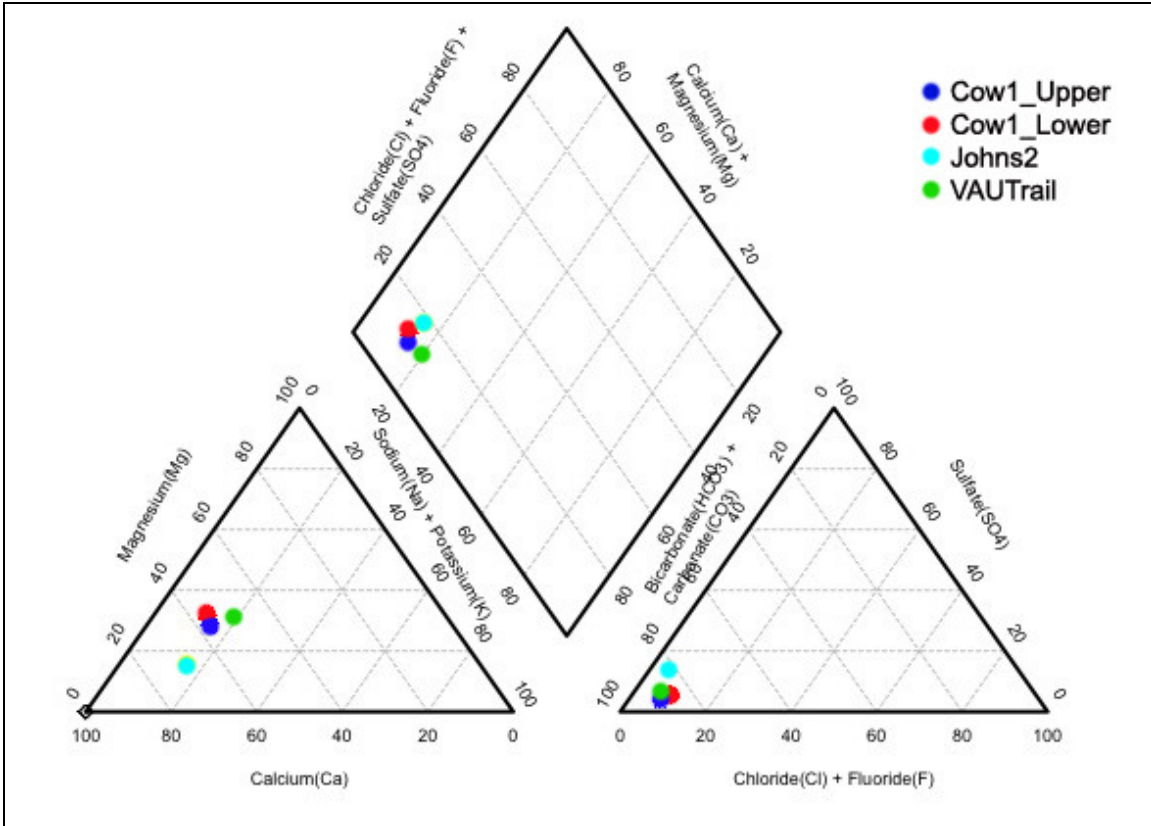

Figure 4.16: Piper plot of chemistry data from sampled wells at Coles Hill.

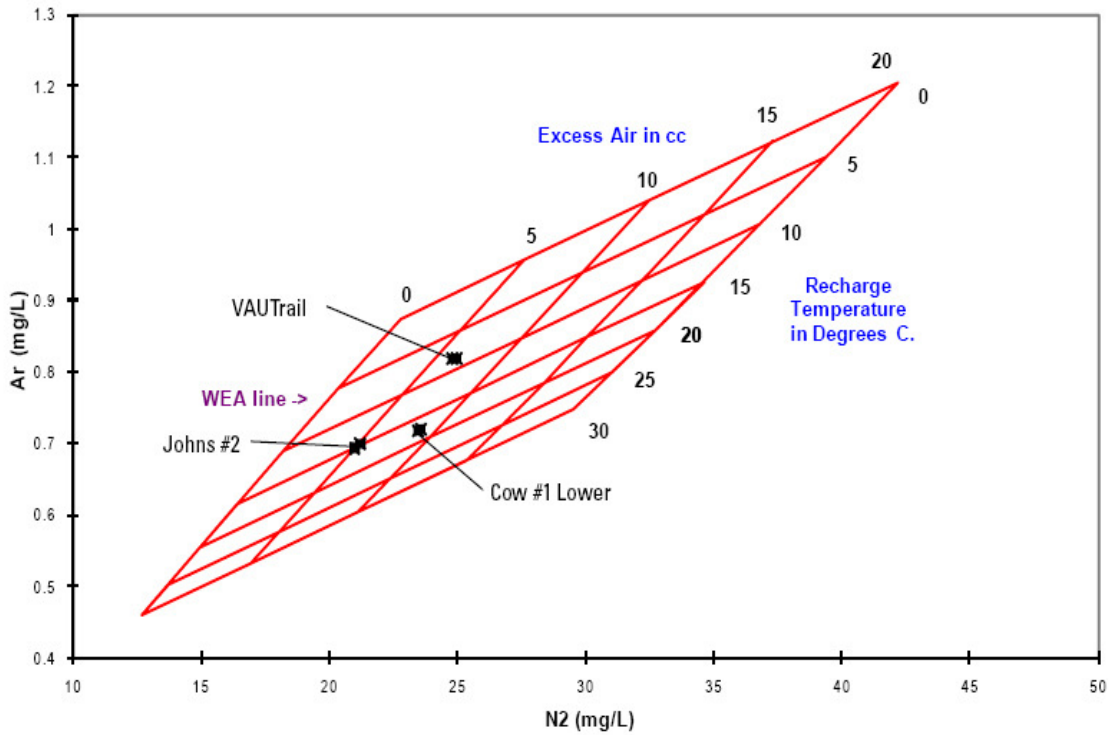

Figure 4.17: Plot of N_2 vs Ar, gas concentrations normalized to sea level for Coles Hill (D.L. Nelms, U.S. Geological Survey, personal commun., 2009).

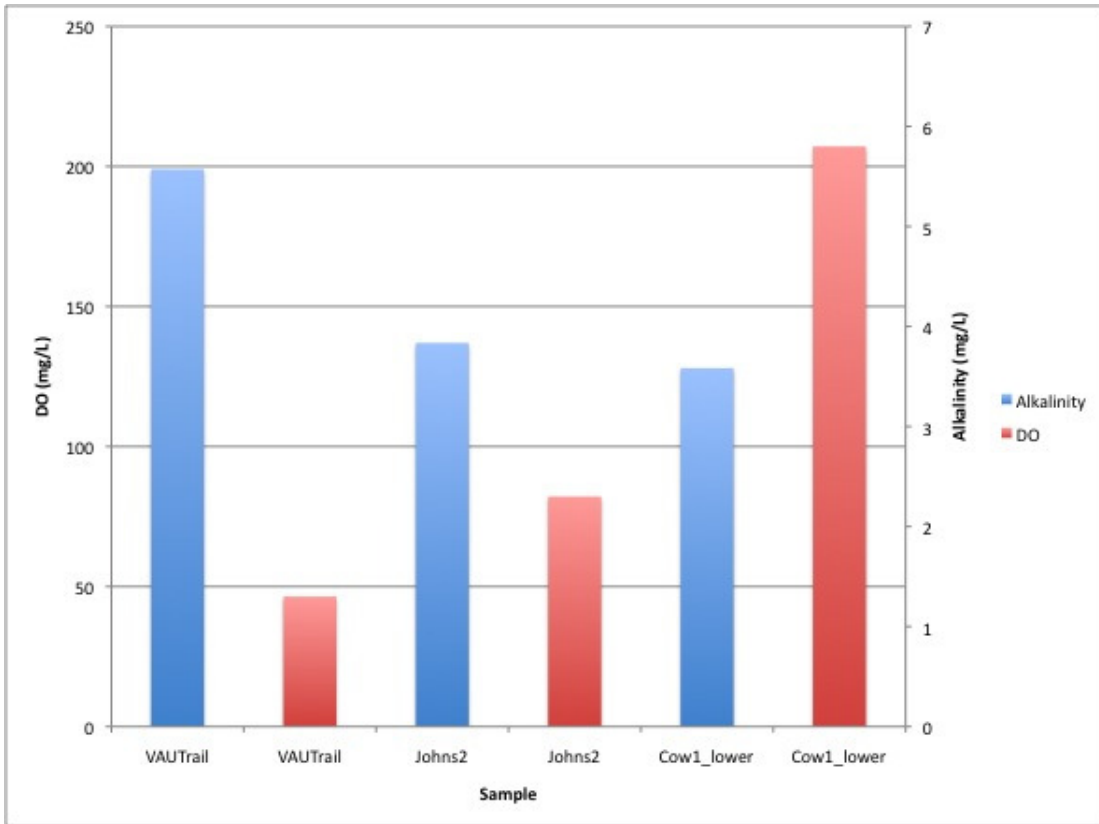

Figure 4.18: Alkalinity and DO measurements for south spring area water samples.

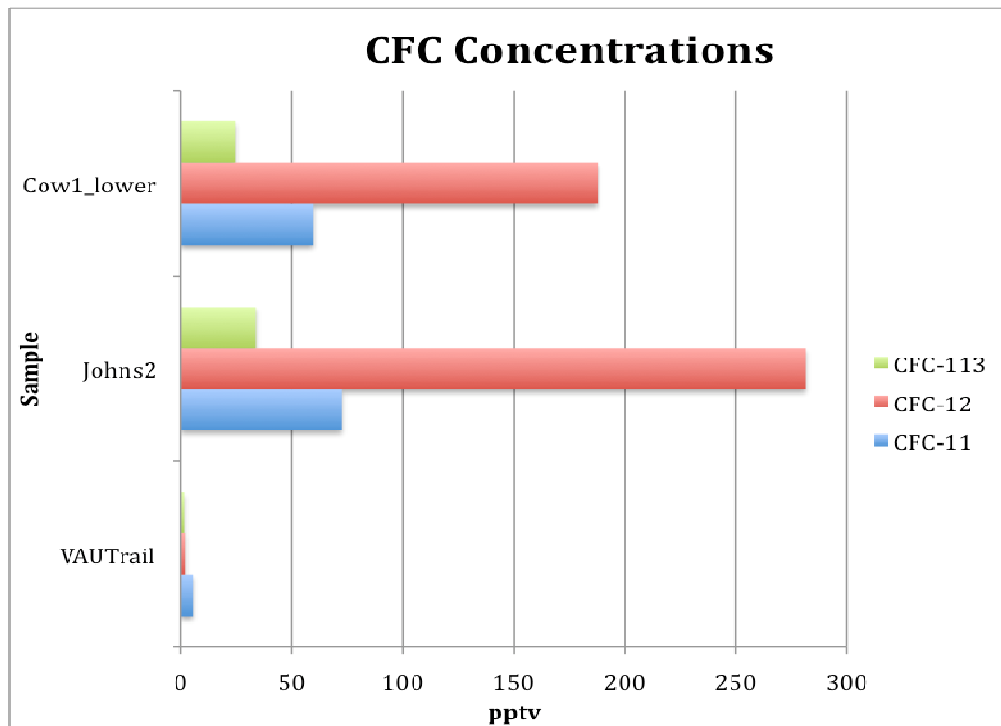

Figure 4.19: CFC concentrations for wells sampled at south spring study area.

Atmospheric Tracer Concentrations (pptv)				
	CFC-11	CFC-12	CFC-113	SF6
VAUTrail	5.3	2	1.6	0.07
Johns2	72.7	281.3	34	11.41
Cow1_lower	59.8	187.5	24.6	3.00

Table 4.3: Atmospheric tracer concentrations (CFC, SF6) for sampled Coles Hill wells.

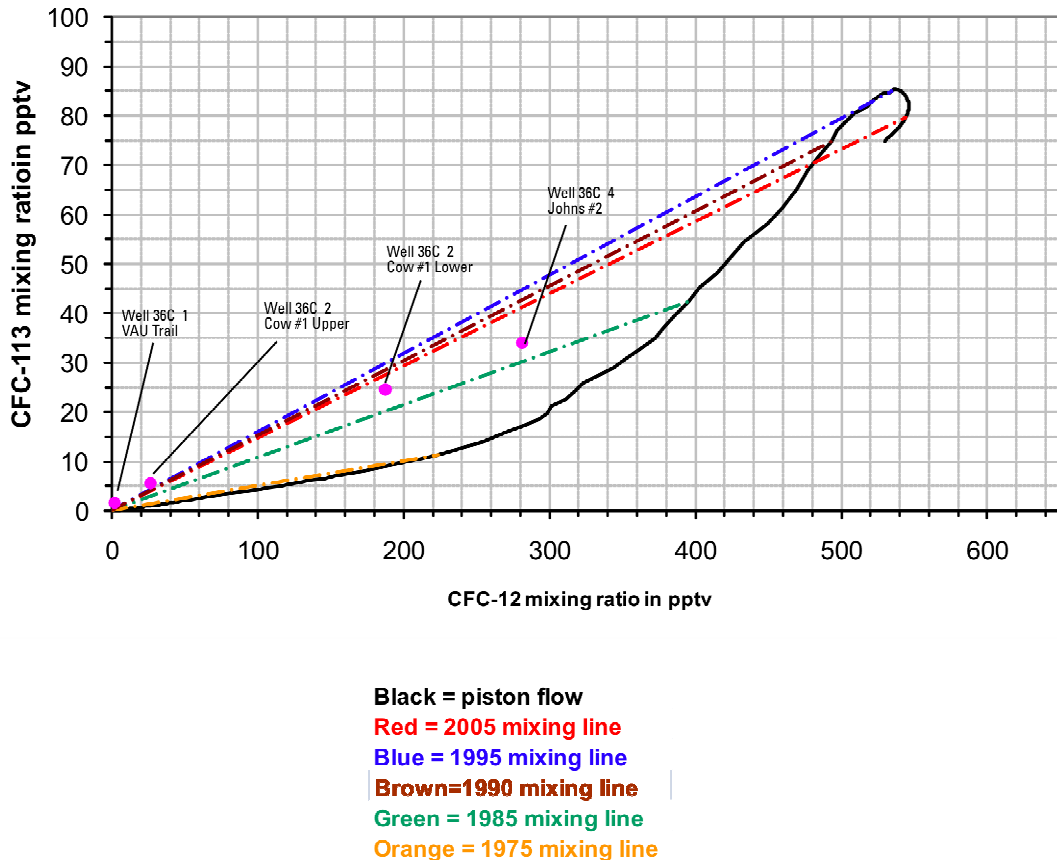

Figure 4.20: Mixing ratios of Coles Hill samples plotted against piston flow and mixing lines for pre-CFC water and different years (D.L. Nelms, U.S. Geological Survey, personal commun., 2009).

5.0 Discussion

Interpretation of electrical resistivity profiles, geophysical borehole logs, static water levels, pumping test data, local geology, chemistry, and groundwater age dates has provided useful information concerning groundwater flow at the Coles Hill site in the vicinity of the

Chatham Fault, particularly near the south spring site. Together, the analyses of these data allow a generalized conceptual model for the nature and quantity of groundwater movement within and across the different geologic units encountered at Coles Hill to be developed.

Resistivity profiles collected across a large area of Coles Hill confirm that the subsurface is extremely heterogeneous, with low (<20 ohm-m) resistivity occurring in localized zones controlled by the local geology and structural history. These low resistivity areas are associated not only with the main Chatham Fault zone but also the cross faults mapped throughout the site (Figures 2.2, 4.6). The Chatham Fault and cross faults were also located by electromagnetic and ground penetrating radar surveys in a related study by Virginia Tech student Josh Whitney(2009). It is important to note, however, that flow at the site is not confined merely to the low resistivity zones detected by these methods. Flow was detected via heat pulse flow meter tests in Johns1 (Figure 4.10), a well drilled directly into an area characterized by a large, high resistivity area (>1000 ohm-m). This indicates that observed high resistivity values may be related to rock properties and not to fluid saturation.

These observed heterogeneities and the inability of applied broad scale methods to adequately characterize the Coles Hill site led to a redefinition of the scope to a much smaller area. The south spring study area contains most of the features of interest at the Coles Hill site, namely the Chatham Fault, a cross fault, Piedmont granitic rocks, Triassic basin metasediments and a spring. This made the south spring area an acceptable analogue for the Coles Hill site and therefore became the focus of this investigation.

The hydrogeology of the south spring study area is found to be highly complex on the basis of the applied methods used to characterize it. While a study by Virginia Tech student John Wyatt (2009) found evidence that in the past groundwater flowed from east to west, the

hydraulic gradient inferred from the small number of available wells (Figure 4.13), indicates confined groundwater flow through fractures is from west to east in this area today. This indicates that water moves from the rocks of the Piedmont province, across the Chatham Fault, and into the Danville Triassic basin. Electrical resistivity profiling provides evidence of the flow pathways necessary for this to occur. Profiles at the south spring study area (Figure 4.6) confirmed zones of resistivity 2 orders of magnitude lower than the surrounding area along the Chatham Fault and along the cross fault in the south spring area. These lower resistivities suggest the possibility of flow, but well data are not available to corroborate this. Also, as is typical in profiles from the site, the Triassic basin is generally characterized as a low resistivity area (<20 ohm-m), while the granitic Piedmont rocks to the west of the fault are generally characterized as having higher resistivities. This characterization is illustrated in COL1, COL3, COL10, and COL13 (Figures 4.3, 4.4, 4.6). The possibility of flow through the granite, fault, and Triassic basin is confirmed by the pumping test performed at the study area. When VAUTrail is pumped, drawdown is observed in the Chatham Fault zone (Cow1_upper) and in the granitic Piedmont rocks (Johns2; Figure 4.14), which confirms that groundwater flows across the Chatham Fault from the granitic Piedmont rocks into the Triassic basin.

While the natural hydraulic gradient and pumping test results suggest that water in VAUTrail originates from the granitic rocks to the west, neither the production of Johns2 nor Cow1 is sufficient to be sourcing the large volume of water that VAUTrail is capable of producing. Evidence from water chemistry data, however, indicates that water from the VAUTrail well is similar to that of Cow1_lower and Johns2 (Figure 4.16), further indicating that the groundwater originates from similar rock types. Only DO and alkalinity differ at VAUTrail compared to Johns2 and Cow1_lower (Figure 4.18), suggesting that VAUTrail may contain more

old (>60 years) water based on observed CFC concentrations (Figure 4.20). The similar chemistry of this older water suggests that it is likely sourced from the same rocks as the younger water observed in Johns2 and Cow1_lower. This indicates that water in highly transmissive zones at Coles Hill is older than water in areas with lower transmissivity. Zones of higher transmissivity may be dispersed throughout the granite at Coles Hill, or the cross fault in the area may be providing a source of water to VAUTrail. The wells drilled in the granite in this study did not intersect any major fractures, nor did any wells intersect a cross fault due to restrictions placed on well location. Therefore neither of these possible flow scenarios can be confirmed. Another possible explanation for the greater quantity of flow to VAUTrail is that the observed hydraulic gradient in the area is extremely localized and is influenced by the Chatham Fault. It would therefore be possible that the old water in VAUTrail originates from areas farther to the east in the Danville Triassic basin and not from the granite. Additional wells in the Triassic basin are needed evaluate this hypothesis.

The differing ages of water from wells at the south spring study area suggest recharge is occurring from multiple locations. The young water detected in Johns2 and Cow1_lower (Figure 4.20) suggests locally recharged water. This water is found in rocks having very low transmissivity and storativity (according to the pumping test) and therefore likely has not travelled long distances. The predominance of old water in the VAUTrail sample, along with a highly productive fracture suggests that water is not being recharged locally at Coles Hill. This water is either being recharged somewhere to the west in the granite or to the east in the Triassic basin at a higher elevation and has been transported through fracture networks to Coles Hill over a long period of time (>60 years). Because of the extreme heterogeneity of the rock bodies on both sides of the fault it is difficult to define a recharge area without a more extensive and

exhaustive age dating study that includes many more wells in both the granite to the west and in the Triassic basin to the east.

Neither resistivity, nor observations of water levels were able to constrain the source of the spring located at the south spring area. It is possible that the spring is sourced from a highly transmissive zone in the granite or the fault, but this zone was not intersected in any drilling conducted at the site. Another possibility is that the spring drains an ancient river terrace located on the hill to the west of the spring (W. Henika, personal commun., 2009; figure 4.7). It is possible that Johns2 and Johns3 are just off the edge of the terrace, which could explain the much lower water levels observed in these wells.

6.0 Conclusions

The data collected in this study characterizes the hydrogeology of the south spring site area of Coles Hill as complexly interconnected system of fractures in the upper 100 m of bedrock. Water moves through a network of fractures, with the abundance of fractures generally decreasing with depth. The fracture networks can produce small or large amounts of water and are often connected with one another.

Electrical resistivity profiles gathered from the site confirm that many low resistivity areas (<20 ohm-m) are present, characterizing it as extremely heterogeneous, even within a single rock type. Borehole logging and aquifer testing reveals that flow can occur not only in low resistivity zones but also in zones of high resistivity (>1000 ohm-m).

Connectivity between the granitic Piedmont rocks, the Chatham Fault, and the Danville Triassic basin metasediments was confirmed by the pumping test conducted at VAUTrail and chemical data collected at wells VAUTrail, Johns2, and Cow1. Analysis of measured

drawdowns and the occurrence of the Mandel-Cryer effect in Johns2 suggest a complex interconnected system with small fracture apertures in the granitic Piedmont rocks.

The groundwater at Coles Hill is recharged not only locally but also at more distant locations as significant quantities of old (>60 years) and young water are observed in every sample dated. VAUTrail is almost entirely sourced by old water, indicating that perhaps some transmissive zones could exist that have not been identified from pumping tests at the site and contain old water sourced from locations up gradient of the site. Based on the similar chemistry and natural fracture hydraulic gradient in the area, it appears that at least some of the recharge is coming from areas to the west in the crystalline Piedmont rocks. While Johns2 and Cow1_lower contain greater portions of young water, the zones they intersect are incapable of supplying the quantity of water VAUTrail is producing, which suggests that (1) other unidentified hydraulically active fractures are occurring across the Chatham Fault (perhaps along the cross fault) or (2) a significant quantity of recharge is coming from the east in the Triassic basin and the hydraulic gradient that is observed here is extremely localized. Additional hydraulic head data along with analyses of age dates are needed farther to the east to evaluate this possibility.

This study has illustrated the complexity of hydrogeology of the Coles Hill area. The question of origin of recharge for the site remains unanswered, we can only speculate knowing the nature of flow at the site and the general age of the water. The Chatham Fault has at least some areas where small amounts of flow can occur across the structure. It is possible that larger quantities of flow may be occurring along the Chatham Fault (as evidenced by chemistry and age dating analyses), possibly along the cross faults where a number of low resistivity zones were mapped, but this would have to be further investigated with additional wells. These findings are important in the context of a mine at Coles Hill. Impacts to the groundwater in the crystalline

Piedmont rocks, which host the deposit, would also affect the groundwater in the fault zone and Triassic basin.

It is clear from this study that a more detailed hydrogeologic investigation surrounding the deposit is warranted in order to make any conclusions about the effects a potential mine would have on the groundwater of the area surrounding Coles Hill. It is essential that age dating and chemistry be performed on wells intersecting productive fracture zones located further into the Danville Triassic basin and the Leatherwood Granite. The age and chemistry of water from such wells, as well as their natural hydraulic head, would provide evidence of the origin of the water in highly transmissive zones at Coles Hill.

References

- Busenberg, E., Plummer, L.N. (2000). Dating young groundwater with sulfur hexafluoride: Natural and anthropogenic sources of sulfur hexafluoride. *Water Resources Research* 36:3011-3030.
- Buszka, P.M., Watson, L.R., Greeman, T.K., Hydrogeology (2007). Ground-Water-Age Dating, Water Quality, and Vulnerability of Ground Water to Contamination in a Part of the Whitewater Valley Aquifer System near Richmond, Indiana, 2002- 2003. Scientific Investigations Report, Richmond: *USGS*.
- Bye, A.R., Bell, F.G. (2001). Stability assessment and slope design at Sandsloot open pit, South Africa. *International Journal of Rock Mechanics and Mining Sciences* 38, no. 3: 449-466.
- Carter, B.T., Hibbart, J.P., Tubrett, M., Slyvester, P. (2006). Detrital zircon geochronology of the Smith River Allochthon and Lynchburg Group, southern Appalachians: Implications for Neoproterozoic-Early Cambrian paleogeography. *Precambrian Research* 147, no. 3-4: 279-304.
- Christopher, P.A. (2007). Technical Report on the Coles Hill Uranium Property, Pittsylvania County, Virginia. Unpublished technical report, *PAC Geological Consulting INC*, Vancouver, BC.
- Cook, P.G., Solomon, D.K. (1997). Recent advances in dating young groundwater: chlorofluorocarbons, $3\text{H}/3\text{He}$ and 85Kr . *Journal of Hydrology* 191: 245-265.
- Daniel, Charles C. (1996). Ground-Water Recharge to the Regolith-Fractured Crystalline Rock Aquifer System, Orange County, North Carolina. Water-Resources Investigations Report, *U.S. Geological Survey*, Raleigh, NC.
- Gates A.E. (1997). Multiple Reactivations of accreted terrane boundaries : An example from the Carolina Terrane , Brookneal Virginia in *Central and Southern Appalachian Sutures : Results of the EDGE Project and related studies* , edited by Lynn Glover III and Alexander Gates *Geological Society of America Special Paper 314, 135 pp., Boulder, Co.*
- Gibson, R.E., Knight, K and Taylor P.W. (1963). A critical experiment to examine theories of three-dimensional consolidation. Proceedings of European Conference on Soil Mechanics and Foundation Engineering, Wiesbaden, v. 1, p. 69-76.
- Henika, W.S. (1981). Geology of the Spring Garden quadrangle, Virginia: Virginia Division of Mineral Resources Open-File Map and Report, scale 1:24,000.
- Henika, W.S. (1998). Digital geologic map of the Virginia portion of the Danville 30x60 minute quadrangle: Virginia Division of Mineral Resources Publication DP-43A, unedited draft, scale 1:100,000.

- Henika, W.S. (2002). Geologic Map of the Danville 30 by 60 minute quadrangle, Virginia: Virginia Division of Mineral Resources Publication 166, 1:100000 scale color geologic map w/explanation.
- Henika, W.S., Thayer, P.A. (1983). Geology of the Spring Garden Quadrangle, Virginia, Virginia Division of Mineral Resources Publication 48. w/color geol. map.
- Henika, W.S. (2009). Personal Communication. Blacksburg, VA: E-mail
- Hibbard, J.P., Tracy, R.J., Henika, W.S. (2003). Smith River allochthon: A southern Appalachian peri-Gondwanan terrane emplaced directly on Laurentia, *Geological Society of America* 31, no. 3: 215-218.
- Jerden, James L. (2001). Origin of Uranium Mineralization at Coles Hill Virginia (USA) and its Natural Attenuation within an Oxidizing Rock-Soil-Ground Water System. PhD Thesis, Geosciences, *Virginia Tech*, Blacksburg, VA.
- Le Borgne, T., Bour, O., Riley, M.S., Gouze, P., Pezard, P.A., Belgoul, A., Lods, G. LeProvost, R., Greswell, R.B., Ellis, P.A., Isakov, E.E., Last, B.J. (2004). Comparison of alternative methodologies for identifying and characterizing preferential flow paths in heterogenous aquifers. *Journal of Hydrology* 345: 134-148.
- Lineberger, David Howard. (1983). Geology of the Chatham Fault Zone, Pittsylvania County, VA. MS Thesis, Geology, *University of North Carolina*, Chapel Hill.
- Loke, M.H. (2006). Res2Dinv software version 3.55.
- Lynott, W.P. (1985). Groundwater Investigations at the Swanson Uranium Project Site. Status Report, Denver: Gibbs and Hill, Inc.
- Marline Uranium Corporation (1983). An Evaluation of Uranium Development in Pittsylvania County Virginia.
- Nelms, D.L. (2009). Personal Communication. Blacksburg, VA: E-mail.
- Pincock, Allen & Holt. (1982). Geologic Reserves: Coles Hill South Uranium Deposit, Pittsylvania County, Virginia. Tucson, Arizona.
- Plummer, L.N., Busenberg, E., Bohlke, J.K., Nelms, D.L., Michel, R.L., Schlosser, P. (2001). Groundwater residence times in Shenandoah National Park, Blue Ridge Mountains, Virginia, USA: a multi-tracer approach. *Chemical Geology* 179: 93-111.
- Plummer, L.N., Bohlke, J.K., Busenbergu, E. (2003). Approaches for Ground-Water Dating. Water Resources Investigation Report 03-4035, *U.S. Geological Survey*.

- Santoy Resources LTD. (2009). NI 43-101 Technical Report for Coles Hill Uranium Deposit, Virginia. British Columbia, Canada.
- Seaton, W.J., Burbey, T.J. (2000). Aquifer Characterization in the Blue Ridge Physiographic Province Using Resistivity Profiling and Borehole Geophysics: Geologic Analysis. *Journal of Environmental and Engineering Geophysics* 5, no. 3: 45-48.
- Seaton, W.J., Burbey, T.J. (2005). Influence of ancient thrust faults on the hydrogeology of the blue ridge province." *Ground Water* 43, no. 3: 301-313.
- Seaton, W.J., Burbey, T.J. (2002). Evaluation of two-dimensional resistivity methods in a fractured crystalline-rock terrane. *Journal of Applied Geophysics* 51: 21-41.
- Thayer, P. (1970) Stratigraphy and geology of Dan River Triassic basin, North Carolina. *Southeastern Geology* 12.
- Verruijt A. (1969). Elastic storage of aquifers. In "Flow through Porous Media", edited by R.J.M. DeWiest, Academic Press, New York, p. 331-376.
- Virginia Department of Environmental Quality (2009). Personal Communication, Blacksburg, VA: E-mail
- Wang, H.F. (2000). Theory of Linear Poroelasticity, Princeton University Press, Princeton, 287 p.
- Whitney, J.A. (2009). Application of Electromagnetic Methods to Identify and Characterize Sub-surface Structures Associated with the Coles Hill Uranium Deposit. MS Thesis, Mining and Minerals Engineering, *Virginia Tech*, Blacksburg, VA.
- Wyatt, J. (2009). The Relationship Between Structural and Tectonic Evolution and Mineralization at the Coles Hill Uranium Deposit, Pittsylvania County, Virginia. MS Thesis, Geology, *Virginia Tech*, Blacksburg, VA.

Appendix A - Chemistry Data

SEQNO	Owner Name	USGS local no	SiteID	X Coord83
1	VAUTrail	36C 1	365203079182301	-79.306364183
2	Cow #1 Lower (108-600)	36C 2	365202079182501	-79.30706258
3	Cow #1 Upper (60-108)	36C 2	365202079182501	-79.307062578
4	John's #2	36C 4	365201079183001	-79.308244719
5	John's #1	36C 3	365202079183001	-79.308283023
6	Frith Spring	36CS	365152079184301	-79.311782078
7	Coreshed Spring	36CS	365200079183001	-79.308104367

Y_Coord83	X_Coord27	Y_Coord27	Geol	Alt29	DGPS_ALT87	Date
36.867391197	-79.306619383	36.867252457		595	596.840	5/28/09
36.86730482	-79.30731776	36.86716607		610	615.976	5/28/09
36.867304816	-79.30731776	36.86716607		610	615.976	5/29/09
36.867016016	-79.308499865	36.866877262		620	620.873	5/29/09
36.867132907	-79.308538168	36.866994150		620	622.128	nd
36.864725053	-79.312037133	36.864586308		630	nd	5/29/09
36.866886247	-79.308359519	36.866747497		615	nd	5/29/09

Time	Field Properties							
	TEMP P00010	pH P00400	SCOND P00095	DO mg/L P00300	Alk_Hach P39086	CO3_Hach P00452	HCO3_Hach P00453	Alk_Bur P39086
1312	15.2	7.6	346	1.3	158	0.6	192	199
1606	15.5	7.5	295	2.3	136	0.5	165	137
1017	16.0	7.0	242	0.8	105	0.1	127	109
1300	15.3	7.4	300	4.8	124	0.2	151	128
nd	nd	nd	nd	nd	nd	nd	nd	nd
1500	15.0	6.1	153	5.6	nd	nd	nd	nd
1530	17.9	6.3	253	-0.6	nd	nd	nd	nd

			Stable Isotopes		
CO3_Bur P00452	HCO3_Bur P00453	BP P00025	Delta 2H x 1000	Delta 2H 2sig	Delta 18O x 1000
0.5	242	742	-38.11	2.0	-6.43
0.4	166	742	-38.55	2.0	-6.52
0.1	133	739	-37.85	2.0	-6.44
0.2	156	739	-39.13	2.0	-6.65
nd	nd	nd	nd	nd	nd
nd	nd	739	nd	nd	nd
nd	nd	739	nd	nd	nd

Delta 18O 2sig	d_excess	NanoMol/kg in H ₂ O			cc/g of H ₂ O at STP x10 ⁹		
		(He)	(H ₂)	(Ne)	(He)	(H ₂)	(Ne)
0.2	13.3	24.9	14.8	nd	559	332	nd
0.2	13.6	4.2	1.3	10.1	95	30	227
0.2	13.7	3.8	261.4	8.5	85	5858	191
0.2	14.1	4.3	0.7	11.9	97	16	268
nd	nd	nd	nd	nd	nd	nd	nd
nd	nd	nd	nd	nd	nd	nd	nd
nd	nd	nd	nd	nd	nd	nd	nd

Helium, H2, & Ne						
cc/g of H2O at STP x10-8			AtmPress	4He air-water SL	4He air-water	Δ4He
(He)	(H2)	(Ne)				
55.9	33.2	nd	0.9784	2.069	2.024	91.88
9.5	3.0	22.7	0.9778	2.066	2.020	52.13
8.5	585.8	19.1	0.9778	2.064	2.018	46.61
9.7	1.6	26.8	0.9775	2.067	2.020	53.34
nd	nd	nd	0.9775	nd	nd	nd
nd	nd	nd	0.9771	nd	nd	nd
nd	nd	nd	0.9777	nd	nd	nd

Sample Status	Dissol							
	mg/L N2	StDev N2	mg/L Ar	StDev Ar	mg/L O2	StDev O2	mg/L CO2	StDev CO2
Good Sample	24.35	0.11	0.8007	0.0003	0.3	0.0	9.5	0.0
Good Sample	23.01	0.07	0.7026	0.0013	0.4	0.1	9.1	0.1
Degassed	0.00	0.00	0.0000	0.0000	0.0	0.0	0.0	0.0
Good Sample	20.63	0.16	0.6804	0.0041	1.4	0.2	10.1	0.2
nd	nd	nd	nd	nd	nd	nd	nd	nd
nd	nd	nd	nd	nd	nd	nd	nd	nd
nd	nd	nd	nd	nd	nd	nd	nd	nd

ved Gases--Averages								
mg/L CH4	StDev CH4	mg/L Excess N2	Recharge Elev. Ft.	mm Hg BP	Recharge T oC	Ex Air cc STP/L	Recharge T oC	Ex Air cc STP/L
0.0033	0.0001		595	743.6	8.3	6.1	8.3	6.1
0.0022	0.0004	1.0	610	743.2	15.2	6.2	17.5	8.0
0.0000	0.0000		610	743.2	99.4	0.0	99.4	0.0
0.0033	0.0002		620	742.9	14.9	4.7	14.9	4.7
nd	nd	nd	nd	nd	nd	nd	nd	nd
nd	nd	nd	nd	nd	nd	nd	nd	nd
nd	nd	nd	nd	nd	nd	nd	nd	nd

n	Calculated Atmospheric Mixing Ratio in pptv			Model piston dates (excess air corrected) Dual dates are possible for CFC-11, CFC-12 & CFC-113				
	CFC-11	CFC-12	CFC-113	CFC-11 (1)	CFC-11 (2)	CFC-12 (1)	CFC-12 (2)	CFC-113 (1)
	2	5.3	2.0	1.6	1956.0	NP	1945.5	NP
2	59.8	187.5	24.6	1970.0	NP	1973.0	NP	1980.5
2	16.6	26.5	5.5	1962.5	NP	1957.5	NP	1969.5
2	72.7	281.3	34.0	1971.5	NP	1977.5	NP	1983.0
nd	nd	nd	nd	nd	nd	nd	nd	nd
nd	nd	nd	nd	nd	nd	nd	nd	nd
nd	nd	nd	nd	nd	nd	nd	nd	nd

CFC Average Apparent Ages--Selected Age is Highlighted						
d) C-113	Piston Flow Ages					
	CFC-11 (1)	CFC-11 (2)	CFC-12(1)	CFC-12(2)	CFC-113 (1)	CFC-113 (2)
	Age yrs	Age yrs	Age yrs	Age yrs	Age yrs	Age yrs
CFC-113 (2)						
NP	53.4	NP	63.9	NP	48.9	NP
NP	39.4	NP	36.4	NP	28.9	NP
NP	46.9	NP	51.9	NP	39.9	NP
NP	37.9	NP	31.9	NP	26.4	NP
nd	nd	nd	nd	nd	nd	nd
nd	nd	nd	nd	nd	nd	nd
nd	nd	nd	nd	nd	nd	nd

Ratio Ages					
F11/F12 Age yrs	% young in Mix from F12	F113/F12 Age yrs	% young in Mix from F113	F113/F11 Age yrs	% young in Mix from F113
NP		NP		18.4	2.0
NP		21.9	42.5	NP	
NP		NP		11.9	6.5
NP		23.4	70.6	NP	
nd	nd	nd	nd	nd	nd
nd	nd	nd	nd	nd	nd
nd	nd	nd	nd	nd	nd

SF6 Corrected for Excess air		
Calc. SF6 partial pressure (pptv)	Piston flow model SF6 recharge year	Piston flow model SF6 recharge age, years
0.07	1960.5	48.9
11.41	C	C
6.53	2008.5	0.9
3.00	1993.0	16.4
nd	nd	nd
nd	nd	nd
nd	nd	nd

Appendix B – Electrical Resistivity Transects Raw Data

The following data is structured as follows:

Name

Electrode Spacing

Array Type (Wenner = 1, Pole-pole = 2, Dipole-dipole = 3, Pole-dipole = 6, Schlumberger = 7, Equatorial dipole dipole = 8)

Number of Data

Type of x location for data points

0 Indicates Resistivity Data

Distance Electrode Spacing Dipole Separation Factor Measured Resistivity

Sting/Swift prg: COL1

10.00000

3

842

1

0

615.00000	10.00000	1.00000	70.28810
610.00000	10.00000	2.00000	90.86210
605.00000	10.00000	3.00000	119.89400
600.00000	10.00000	4.00000	183.41600
595.00000	10.00000	5.00000	248.79401
590.00000	10.00000	6.00000	166.29300
585.00000	10.00000	7.00000	187.39700
605.00000	10.00000	1.00000	84.43850
600.00000	10.00000	2.00000	136.52299
595.00000	10.00000	3.00000	235.22400
590.00000	10.00000	4.00000	295.43100
585.00000	10.00000	5.00000	294.51300
580.00000	10.00000	6.00000	163.54201
575.00000	10.00000	7.00000	410.94101
570.00000	10.00000	8.00000	173.17000
570.00000	20.00000	4.00000	245.44800
560.00000	20.00000	5.00000	374.10400
540.00000	20.00000	7.00000	202.27800
530.00000	20.00000	8.00000	347.32999
595.00000	10.00000	1.00000	64.83910
590.00000	10.00000	2.00000	100.52800
585.00000	10.00000	3.00000	143.62700
580.00000	10.00000	4.00000	115.55800
575.00000	10.00000	5.00000	118.25000
570.00000	10.00000	6.00000	51.84560

565.00000	10.00000	7.00000	267.54700
560.00000	10.00000	8.00000	102.83800
560.00000	20.00000	4.00000	188.40700
550.00000	20.00000	5.00000	429.69400
530.00000	20.00000	7.00000	351.08200
495.00000	30.00000	7.00000	333.37900
480.00000	30.00000	8.00000	636.68701
510.00000	30.00000	6.00000	108.23500
585.00000	10.00000	1.00000	132.62100
580.00000	10.00000	2.00000	120.72100
575.00000	10.00000	3.00000	107.45900
570.00000	10.00000	4.00000	88.19110
565.00000	10.00000	5.00000	155.18401
555.00000	10.00000	7.00000	122.68500
550.00000	10.00000	8.00000	176.31300
560.00000	10.00000	6.00000	51.44580
550.00000	20.00000	4.00000	149.07899
540.00000	20.00000	5.00000	154.32100
530.00000	20.00000	6.00000	164.70900
520.00000	20.00000	7.00000	170.41200
510.00000	20.00000	8.00000	117.40300
500.00000	30.00000	6.00000	305.95099
485.00000	30.00000	7.00000	580.88397
470.00000	30.00000	8.00000	278.25800
470.00000	40.00000	6.00000	675.26703
450.00000	40.00000	7.00000	872.51001
430.00000	40.00000	8.00000	871.57703
575.00000	10.00000	1.00000	304.35199
570.00000	10.00000	2.00000	121.23700
565.00000	10.00000	3.00000	101.81600
560.00000	10.00000	4.00000	92.87000
555.00000	10.00000	5.00000	149.83600
550.00000	10.00000	6.00000	128.05600
545.00000	10.00000	7.00000	189.77600
540.00000	20.00000	4.00000	62.51130
530.00000	20.00000	5.00000	199.23900
520.00000	20.00000	6.00000	159.30701
510.00000	20.00000	7.00000	247.87700
500.00000	20.00000	8.00000	78.17300
490.00000	30.00000	6.00000	118.26700
460.00000	30.00000	8.00000	1162.59998
460.00000	40.00000	6.00000	931.32202
440.00000	40.00000	7.00000	922.05298
420.00000	40.00000	8.00000	979.75098
405.00000	50.00000	7.00000	686.24500
380.00000	50.00000	8.00000	724.35303

565.00000	10.00000	1.00000	283.59299
560.00000	10.00000	2.00000	171.74800
555.00000	10.00000	3.00000	130.25101
550.00000	10.00000	4.00000	192.79900
545.00000	10.00000	5.00000	165.95000
540.00000	10.00000	6.00000	210.69901
535.00000	10.00000	7.00000	227.15199
530.00000	20.00000	4.00000	172.06500
520.00000	20.00000	5.00000	143.98500
510.00000	20.00000	6.00000	171.50900
500.00000	20.00000	7.00000	248.85699
490.00000	20.00000	8.00000	245.40900
480.00000	30.00000	6.00000	328.36499
465.00000	30.00000	7.00000	426.96301
450.00000	30.00000	8.00000	1091.29004
450.00000	40.00000	6.00000	993.16101
430.00000	40.00000	7.00000	691.02197
410.00000	40.00000	8.00000	721.97498
395.00000	50.00000	7.00000	648.60199
370.00000	50.00000	8.00000	921.55298
360.00000	60.00000	7.00000	1566.06995
555.00000	10.00000	1.00000	416.10101
550.00000	10.00000	2.00000	198.08200
545.00000	10.00000	3.00000	214.86501
540.00000	10.00000	4.00000	205.81100
535.00000	10.00000	5.00000	269.69000
530.00000	10.00000	6.00000	175.82001
525.00000	10.00000	7.00000	282.59201
520.00000	20.00000	4.00000	140.20900
510.00000	20.00000	5.00000	195.73199
500.00000	20.00000	6.00000	241.57500
490.00000	20.00000	7.00000	279.81201
480.00000	20.00000	8.00000	317.66299
470.00000	30.00000	6.00000	481.36099
455.00000	30.00000	7.00000	638.96503
440.00000	30.00000	8.00000	1120.80005
440.00000	40.00000	6.00000	1026.18005
420.00000	40.00000	7.00000	772.99701
400.00000	40.00000	8.00000	809.95801
385.00000	50.00000	7.00000	683.23102
360.00000	50.00000	8.00000	1003.59003
545.00000	10.00000	1.00000	294.16599
540.00000	10.00000	2.00000	247.97099
535.00000	10.00000	3.00000	149.88200
530.00000	10.00000	4.00000	209.05000
525.00000	10.00000	5.00000	147.88400

515.00000	10.00000	7.00000	329.37500
520.00000	10.00000	6.00000	42.57940
510.00000	20.00000	4.00000	127.69400
500.00000	20.00000	5.00000	178.19200
490.00000	20.00000	6.00000	206.46100
480.00000	20.00000	7.00000	268.62900
470.00000	20.00000	8.00000	446.53201
460.00000	30.00000	6.00000	342.46201
445.00000	30.00000	7.00000	1044.53003
430.00000	30.00000	8.00000	952.53003
430.00000	40.00000	6.00000	889.78601
410.00000	40.00000	7.00000	836.82001
390.00000	40.00000	8.00000	626.71503
375.00000	50.00000	7.00000	741.39600
350.00000	50.00000	8.00000	1219.60999
340.00000	60.00000	7.00000	709.96600
535.00000	10.00000	1.00000	299.11099
530.00000	10.00000	2.00000	157.84300
525.00000	10.00000	3.00000	182.56500
520.00000	10.00000	4.00000	106.66700
515.00000	10.00000	5.00000	134.16100
505.00000	10.00000	7.00000	155.90401
500.00000	10.00000	8.00000	18.33900
500.00000	20.00000	4.00000	124.34900
490.00000	20.00000	5.00000	145.72701
480.00000	20.00000	6.00000	171.85800
470.00000	20.00000	7.00000	191.36501
460.00000	20.00000	8.00000	262.59399
450.00000	30.00000	6.00000	332.50299
435.00000	30.00000	7.00000	1096.76001
420.00000	30.00000	8.00000	669.89398
420.00000	40.00000	6.00000	705.49402
400.00000	40.00000	7.00000	823.52197
380.00000	40.00000	8.00000	544.91400
365.00000	50.00000	7.00000	598.70099
340.00000	50.00000	8.00000	1059.31006
300.00000	60.00000	8.00000	366.75699
525.00000	10.00000	1.00000	281.77802
520.00000	10.00000	2.00000	310.11099
515.00000	10.00000	3.00000	141.80099
510.00000	10.00000	4.00000	79.25790
505.00000	10.00000	5.00000	110.56100
495.00000	10.00000	7.00000	310.22101
490.00000	10.00000	8.00000	83.43060
490.00000	20.00000	4.00000	124.30700
480.00000	20.00000	5.00000	151.65300

450.00000	20.00000	8.00000	510.50000
470.00000	20.00000	6.00000	132.04100
460.00000	20.00000	7.00000	167.30400
440.00000	30.00000	6.00000	539.78601
425.00000	30.00000	7.00000	834.11798
410.00000	30.00000	8.00000	534.05200
410.00000	40.00000	6.00000	554.68103
390.00000	40.00000	7.00000	679.17603
370.00000	40.00000	8.00000	564.89697
355.00000	50.00000	7.00000	693.85699
515.00000	10.00000	1.00000	659.15399
510.00000	10.00000	2.00000	327.55600
505.00000	10.00000	3.00000	160.56900
500.00000	10.00000	4.00000	103.80800
495.00000	10.00000	5.00000	185.66299
485.00000	10.00000	7.00000	224.97301
480.00000	10.00000	8.00000	102.02700
480.00000	20.00000	4.00000	142.64200
470.00000	20.00000	5.00000	156.97900
460.00000	20.00000	6.00000	166.00800
450.00000	20.00000	7.00000	224.08299
430.00000	30.00000	6.00000	798.92401
415.00000	30.00000	7.00000	549.69702
400.00000	30.00000	8.00000	453.43701
400.00000	40.00000	6.00000	513.33002
380.00000	40.00000	7.00000	560.65399
360.00000	40.00000	8.00000	501.54300
345.00000	50.00000	7.00000	527.28497
320.00000	50.00000	8.00000	446.23099
310.00000	60.00000	7.00000	498.95999
505.00000	10.00000	1.00000	348.03400
500.00000	10.00000	2.00000	153.44901
495.00000	10.00000	3.00000	115.93500
490.00000	10.00000	4.00000	84.52090
485.00000	10.00000	5.00000	189.52000
480.00000	10.00000	6.00000	72.00310
475.00000	10.00000	7.00000	129.06200
470.00000	10.00000	8.00000	121.70300
470.00000	20.00000	4.00000	149.14301
460.00000	20.00000	5.00000	163.49100
450.00000	20.00000	6.00000	203.95900
430.00000	20.00000	8.00000	794.43103
440.00000	20.00000	7.00000	326.58899
420.00000	30.00000	6.00000	475.14700
405.00000	30.00000	7.00000	435.22299
390.00000	30.00000	8.00000	435.18701

390.00000	40.00000	6.00000	492.81000
370.00000	40.00000	7.00000	509.57101
350.00000	40.00000	8.00000	422.35101
335.00000	50.00000	7.00000	597.44800
310.00000	50.00000	8.00000	503.38400
300.00000	60.00000	7.00000	491.19400
495.00000	10.00000	1.00000	282.02200
490.00000	10.00000	2.00000	154.72400
485.00000	10.00000	3.00000	126.09700
480.00000	10.00000	4.00000	111.05400
475.00000	10.00000	5.00000	132.29300
470.00000	10.00000	6.00000	152.97301
465.00000	10.00000	7.00000	104.88700
460.00000	10.00000	8.00000	118.33400
460.00000	20.00000	4.00000	187.74899
450.00000	20.00000	5.00000	203.70599
430.00000	20.00000	7.00000	1086.91003
440.00000	20.00000	6.00000	15.93820
410.00000	30.00000	6.00000	570.75403
395.00000	30.00000	7.00000	458.52701
380.00000	30.00000	8.00000	517.91998
380.00000	40.00000	6.00000	517.74500
360.00000	40.00000	7.00000	368.64499
340.00000	40.00000	8.00000	463.75299
325.00000	50.00000	7.00000	559.35602
300.00000	50.00000	8.00000	733.64099
485.00000	10.00000	1.00000	210.02299
480.00000	10.00000	2.00000	119.80000
475.00000	10.00000	3.00000	106.14600
470.00000	10.00000	4.00000	112.76500
465.00000	10.00000	5.00000	97.49770
460.00000	10.00000	6.00000	161.02800
455.00000	10.00000	7.00000	182.95700
450.00000	20.00000	4.00000	124.60900
440.00000	20.00000	5.00000	200.02299
430.00000	20.00000	6.00000	244.95599
420.00000	20.00000	7.00000	310.62799
410.00000	20.00000	8.00000	572.59698
400.00000	30.00000	6.00000	421.84299
385.00000	30.00000	7.00000	340.36301
370.00000	30.00000	8.00000	473.29599
370.00000	40.00000	6.00000	523.64301
350.00000	40.00000	7.00000	426.23499
330.00000	40.00000	8.00000	464.97299
280.00000	60.00000	7.00000	208.54201
475.00000	10.00000	1.00000	227.20000

470.00000	10.00000	2.00000	160.96800
465.00000	10.00000	3.00000	118.89500
460.00000	10.00000	4.00000	112.29800
455.00000	10.00000	5.00000	89.81260
450.00000	10.00000	6.00000	100.65900
445.00000	10.00000	7.00000	117.16700
440.00000	20.00000	4.00000	101.07800
430.00000	20.00000	5.00000	365.11700
410.00000	20.00000	7.00000	379.68500
400.00000	20.00000	8.00000	424.98001
390.00000	30.00000	6.00000	371.00299
340.00000	40.00000	7.00000	381.14499
360.00000	40.00000	6.00000	473.10300
320.00000	40.00000	8.00000	526.06097
270.00000	60.00000	7.00000	434.15201
465.00000	10.00000	1.00000	335.73599
460.00000	10.00000	2.00000	206.25101
455.00000	10.00000	3.00000	164.82600
450.00000	10.00000	4.00000	120.92800
445.00000	10.00000	5.00000	78.58680
440.00000	10.00000	6.00000	222.84801
435.00000	10.00000	7.00000	133.36700
430.00000	10.00000	8.00000	46.45840
430.00000	20.00000	4.00000	124.98500
420.00000	20.00000	5.00000	146.92400
410.00000	20.00000	6.00000	112.57400
400.00000	20.00000	7.00000	479.97501
390.00000	20.00000	8.00000	319.17401
380.00000	30.00000	6.00000	301.34698
365.00000	30.00000	7.00000	352.83600
350.00000	30.00000	8.00000	341.90900
350.00000	40.00000	6.00000	358.13800
330.00000	40.00000	7.00000	348.01300
310.00000	40.00000	8.00000	400.80701
295.00000	50.00000	7.00000	702.43799
270.00000	50.00000	8.00000	245.18300
455.00000	10.00000	1.00000	388.53101
450.00000	10.00000	2.00000	297.03000
445.00000	10.00000	3.00000	196.27000
440.00000	10.00000	4.00000	115.89800
435.00000	10.00000	5.00000	150.53900
430.00000	10.00000	6.00000	72.58060
425.00000	10.00000	7.00000	182.76401
420.00000	10.00000	8.00000	68.47120
420.00000	20.00000	4.00000	81.63520
410.00000	20.00000	5.00000	95.70240

400.00000	20.00000	6.00000	270.47900
390.00000	20.00000	7.00000	604.48401
380.00000	20.00000	8.00000	290.87000
370.00000	30.00000	6.00000	229.67200
355.00000	30.00000	7.00000	339.41400
340.00000	30.00000	8.00000	226.80099
340.00000	40.00000	6.00000	287.00500
320.00000	40.00000	7.00000	367.64700
300.00000	40.00000	8.00000	472.31299
285.00000	50.00000	7.00000	330.49799
445.00000	10.00000	1.00000	537.27399
440.00000	10.00000	2.00000	329.34399
435.00000	10.00000	3.00000	260.98001
430.00000	10.00000	4.00000	156.59200
425.00000	10.00000	5.00000	159.61900
420.00000	10.00000	6.00000	116.71400
415.00000	10.00000	7.00000	165.35100
410.00000	10.00000	8.00000	167.66000
410.00000	20.00000	4.00000	150.40700
390.00000	20.00000	6.00000	385.10300
380.00000	20.00000	7.00000	287.71899
400.00000	20.00000	5.00000	134.37700
370.00000	20.00000	8.00000	227.33099
360.00000	30.00000	6.00000	236.91299
345.00000	30.00000	7.00000	305.78299
330.00000	30.00000	8.00000	258.14499
330.00000	40.00000	6.00000	252.11900
310.00000	40.00000	7.00000	241.16200
275.00000	50.00000	7.00000	478.98599
435.00000	10.00000	1.00000	480.78201
430.00000	10.00000	2.00000	401.88300
425.00000	10.00000	3.00000	224.30701
420.00000	10.00000	4.00000	183.41000
415.00000	10.00000	5.00000	182.50101
410.00000	10.00000	6.00000	206.90601
405.00000	10.00000	7.00000	166.81900
400.00000	10.00000	8.00000	193.17400
400.00000	20.00000	4.00000	196.96800
390.00000	20.00000	5.00000	284.06500
380.00000	20.00000	6.00000	243.17300
370.00000	20.00000	7.00000	270.97699
360.00000	20.00000	8.00000	243.91499
350.00000	30.00000	6.00000	290.17001
335.00000	30.00000	7.00000	274.78799
320.00000	30.00000	8.00000	254.45200
320.00000	40.00000	6.00000	290.08499

300.00000	40.00000	7.00000	290.55701
265.00000	50.00000	7.00000	362.95001
425.00000	10.00000	1.00000	479.73401
420.00000	10.00000	2.00000	297.67999
415.00000	10.00000	3.00000	237.30600
410.00000	10.00000	4.00000	199.18201
405.00000	10.00000	5.00000	201.95900
400.00000	10.00000	6.00000	138.88901
395.00000	10.00000	7.00000	294.75500
390.00000	10.00000	8.00000	213.31500
390.00000	20.00000	4.00000	243.26300
380.00000	20.00000	5.00000	349.36499
370.00000	20.00000	6.00000	347.07999
360.00000	20.00000	7.00000	276.17599
350.00000	20.00000	8.00000	264.80701
325.00000	30.00000	7.00000	266.92899
340.00000	30.00000	6.00000	371.94400
310.00000	30.00000	8.00000	281.28299
290.00000	40.00000	7.00000	303.69699
310.00000	40.00000	6.00000	272.07001
270.00000	40.00000	8.00000	222.57899
415.00000	10.00000	1.00000	341.85800
410.00000	10.00000	2.00000	278.74200
405.00000	10.00000	3.00000	231.90199
400.00000	10.00000	4.00000	270.71201
395.00000	10.00000	5.00000	246.00500
390.00000	10.00000	6.00000	114.07800
385.00000	10.00000	7.00000	213.58701
380.00000	10.00000	8.00000	254.92400
380.00000	20.00000	4.00000	267.70499
370.00000	20.00000	5.00000	387.59900
360.00000	20.00000	6.00000	294.21899
350.00000	20.00000	7.00000	268.92999
340.00000	20.00000	8.00000	280.85501
330.00000	30.00000	6.00000	354.40900
315.00000	30.00000	7.00000	312.57401
300.00000	30.00000	8.00000	327.03799
280.00000	40.00000	7.00000	372.30701
245.00000	50.00000	7.00000	384.74301
405.00000	10.00000	1.00000	320.87799
400.00000	10.00000	2.00000	305.33099
395.00000	10.00000	3.00000	322.57800
390.00000	10.00000	4.00000	263.31100
385.00000	10.00000	5.00000	226.95399
375.00000	10.00000	7.00000	451.96799
370.00000	10.00000	8.00000	402.75101

380.00000	10.00000	6.00000	41.20810
370.00000	20.00000	4.00000	379.22198
360.00000	20.00000	5.00000	311.78000
350.00000	20.00000	6.00000	253.12500
340.00000	20.00000	7.00000	238.41499
330.00000	20.00000	8.00000	378.84698
320.00000	30.00000	6.00000	291.34601
305.00000	30.00000	7.00000	300.22601
290.00000	30.00000	8.00000	321.78201
290.00000	40.00000	6.00000	310.07199
270.00000	40.00000	7.00000	698.31702
235.00000	50.00000	7.00000	232.79100
395.00000	10.00000	1.00000	352.53699
390.00000	10.00000	2.00000	398.17801
385.00000	10.00000	3.00000	334.94299
380.00000	10.00000	4.00000	293.78900
375.00000	10.00000	5.00000	337.42200
365.00000	10.00000	7.00000	232.46500
360.00000	10.00000	8.00000	325.30801
370.00000	10.00000	6.00000	107.61400
360.00000	20.00000	4.00000	348.78400
350.00000	20.00000	5.00000	232.74600
340.00000	20.00000	6.00000	221.80901
330.00000	20.00000	7.00000	216.91499
320.00000	20.00000	8.00000	372.95300
310.00000	30.00000	6.00000	255.11800
295.00000	30.00000	7.00000	314.36700
280.00000	30.00000	8.00000	305.68600
280.00000	40.00000	6.00000	342.44400
225.00000	50.00000	7.00000	171.41600
385.00000	10.00000	1.00000	436.34299
380.00000	10.00000	2.00000	431.61099
375.00000	10.00000	3.00000	406.77399
370.00000	10.00000	4.00000	279.21600
365.00000	10.00000	5.00000	271.68799
360.00000	10.00000	6.00000	310.81000
355.00000	10.00000	7.00000	379.29999
350.00000	10.00000	8.00000	315.53400
350.00000	20.00000	4.00000	270.10901
340.00000	20.00000	5.00000	210.78200
330.00000	20.00000	6.00000	194.69800
320.00000	20.00000	7.00000	308.96399
310.00000	20.00000	8.00000	267.15399
300.00000	30.00000	6.00000	263.17099
285.00000	30.00000	7.00000	255.16299
270.00000	30.00000	8.00000	226.58600

270.00000	40.00000	6.00000	265.62100
250.00000	40.00000	7.00000	244.64799
375.00000	10.00000	1.00000	383.13501
370.00000	10.00000	2.00000	427.24100
365.00000	10.00000	3.00000	370.57999
360.00000	10.00000	4.00000	308.06201
355.00000	10.00000	5.00000	264.59900
350.00000	10.00000	6.00000	327.15701
345.00000	10.00000	7.00000	285.15701
340.00000	10.00000	8.00000	210.60201
340.00000	20.00000	4.00000	217.17300
330.00000	20.00000	5.00000	202.41701
320.00000	20.00000	6.00000	193.16701
310.00000	20.00000	7.00000	336.80701
300.00000	20.00000	8.00000	194.88499
290.00000	30.00000	6.00000	275.65100
275.00000	30.00000	7.00000	309.56799
260.00000	40.00000	6.00000	280.97800
240.00000	40.00000	7.00000	292.81799
220.00000	40.00000	8.00000	245.21899
365.00000	10.00000	1.00000	464.79599
360.00000	10.00000	2.00000	465.64801
355.00000	10.00000	3.00000	384.48300
350.00000	10.00000	4.00000	295.14700
345.00000	10.00000	5.00000	362.06299
340.00000	10.00000	6.00000	317.68500
335.00000	10.00000	7.00000	228.66100
330.00000	10.00000	8.00000	219.11600
330.00000	20.00000	4.00000	200.39600
320.00000	20.00000	5.00000	184.80400
310.00000	20.00000	6.00000	292.24701
300.00000	20.00000	7.00000	259.23001
290.00000	20.00000	8.00000	260.97400
280.00000	30.00000	6.00000	265.13400
265.00000	30.00000	7.00000	255.68201
250.00000	30.00000	8.00000	355.68701
250.00000	40.00000	6.00000	560.10101
210.00000	40.00000	8.00000	128.52400
355.00000	10.00000	1.00000	394.88699
350.00000	10.00000	2.00000	382.76099
345.00000	10.00000	3.00000	278.35901
340.00000	10.00000	4.00000	323.96100
335.00000	10.00000	5.00000	280.98999
330.00000	10.00000	6.00000	196.68100
325.00000	10.00000	7.00000	184.22501
320.00000	10.00000	8.00000	149.65100

320.00000	20.00000	4.00000	179.61000
310.00000	20.00000	5.00000	172.26700
300.00000	20.00000	6.00000	308.21100
290.00000	20.00000	7.00000	186.14799
280.00000	20.00000	8.00000	253.38600
270.00000	30.00000	6.00000	243.98399
255.00000	30.00000	7.00000	249.87199
240.00000	30.00000	8.00000	204.42799
200.00000	40.00000	8.00000	160.47600
345.00000	10.00000	1.00000	491.14600
340.00000	10.00000	2.00000	355.53101
335.00000	10.00000	3.00000	404.01700
330.00000	10.00000	4.00000	341.95801
325.00000	10.00000	5.00000	229.30200
320.00000	10.00000	6.00000	213.49699
315.00000	10.00000	7.00000	170.10500
310.00000	10.00000	8.00000	196.51500
310.00000	20.00000	4.00000	160.25101
300.00000	20.00000	5.00000	252.32899
290.00000	20.00000	6.00000	233.91299
280.00000	20.00000	7.00000	237.75900
270.00000	20.00000	8.00000	238.06900
260.00000	30.00000	6.00000	289.30099
245.00000	30.00000	7.00000	280.95499
230.00000	40.00000	6.00000	324.42001
210.00000	40.00000	7.00000	237.98199
335.00000	10.00000	1.00000	321.25900
330.00000	10.00000	2.00000	403.85501
325.00000	10.00000	3.00000	366.95901
320.00000	10.00000	4.00000	244.43500
315.00000	10.00000	5.00000	222.69400
310.00000	10.00000	6.00000	173.36501
305.00000	10.00000	7.00000	202.12900
300.00000	10.00000	8.00000	113.77900
300.00000	20.00000	4.00000	156.80200
290.00000	20.00000	5.00000	305.13501
280.00000	20.00000	6.00000	182.71100
270.00000	20.00000	7.00000	262.96301
260.00000	20.00000	8.00000	259.78101
220.00000	30.00000	8.00000	600.57098
250.00000	30.00000	6.00000	108.69300
235.00000	30.00000	7.00000	179.50500
220.00000	40.00000	6.00000	340.22000
200.00000	40.00000	7.00000	233.72301
325.00000	10.00000	1.00000	549.15802
320.00000	10.00000	2.00000	596.90802

315.00000	10.00000	3.00000	405.10699
310.00000	10.00000	4.00000	360.36301
305.00000	10.00000	5.00000	263.14700
300.00000	10.00000	6.00000	304.88000
295.00000	10.00000	7.00000	168.25400
290.00000	10.00000	8.00000	304.21701
290.00000	20.00000	4.00000	317.81699
280.00000	20.00000	5.00000	303.60699
270.00000	20.00000	6.00000	299.07001
260.00000	20.00000	7.00000	331.52802
250.00000	20.00000	8.00000	362.21899
240.00000	30.00000	6.00000	253.48599
210.00000	30.00000	8.00000	619.83099
210.00000	40.00000	6.00000	405.82401
190.00000	40.00000	7.00000	303.94601
315.00000	10.00000	1.00000	600.39099
310.00000	10.00000	2.00000	499.97601
305.00000	10.00000	3.00000	482.84000
300.00000	10.00000	4.00000	344.47501
295.00000	10.00000	5.00000	408.03201
290.00000	10.00000	6.00000	224.63699
285.00000	10.00000	7.00000	387.52399
280.00000	10.00000	8.00000	559.15100
280.00000	20.00000	4.00000	520.94897
270.00000	20.00000	5.00000	318.64700
260.00000	20.00000	6.00000	439.27899
250.00000	20.00000	7.00000	455.98001
240.00000	20.00000	8.00000	472.40900
230.00000	30.00000	6.00000	365.35300
180.00000	40.00000	7.00000	294.06699
305.00000	10.00000	1.00000	822.37299
300.00000	10.00000	2.00000	869.60199
295.00000	10.00000	3.00000	568.90601
290.00000	10.00000	4.00000	709.76703
285.00000	10.00000	5.00000	202.74899
280.00000	10.00000	6.00000	663.86401
275.00000	10.00000	7.00000	723.19897
270.00000	10.00000	8.00000	797.61603
270.00000	20.00000	4.00000	632.78998
260.00000	20.00000	5.00000	369.15900
250.00000	20.00000	6.00000	600.20801
230.00000	20.00000	8.00000	619.14502
220.00000	30.00000	6.00000	635.63501
205.00000	30.00000	7.00000	574.22302
295.00000	10.00000	1.00000	994.74298
290.00000	10.00000	2.00000	632.09900

285.00000	10.00000	3.00000	722.25000
280.00000	10.00000	4.00000	321.52399
275.00000	10.00000	5.00000	379.91000
270.00000	10.00000	6.00000	696.48199
265.00000	10.00000	7.00000	696.14600
260.00000	10.00000	8.00000	286.45001
260.00000	20.00000	4.00000	439.51999
250.00000	20.00000	5.00000	634.65198
240.00000	20.00000	6.00000	616.33899
230.00000	20.00000	7.00000	687.42401
220.00000	20.00000	8.00000	539.48602
210.00000	30.00000	6.00000	924.28302
195.00000	30.00000	7.00000	444.67499
180.00000	30.00000	8.00000	377.22900
180.00000	40.00000	6.00000	440.84399
285.00000	10.00000	1.00000	721.21100
280.00000	10.00000	2.00000	973.21198
275.00000	10.00000	3.00000	274.83099
270.00000	10.00000	4.00000	422.48001
265.00000	10.00000	5.00000	607.83600
260.00000	10.00000	6.00000	673.32202
255.00000	10.00000	7.00000	349.15701
250.00000	10.00000	8.00000	445.32700
250.00000	20.00000	4.00000	570.88000
240.00000	20.00000	5.00000	488.41699
230.00000	20.00000	6.00000	410.40900
220.00000	20.00000	7.00000	579.94897
210.00000	20.00000	8.00000	650.26001
275.00000	10.00000	1.00000	1094.97998
270.00000	10.00000	2.00000	302.25900
265.00000	10.00000	3.00000	425.16599
260.00000	10.00000	4.00000	695.37402
255.00000	10.00000	5.00000	694.83398
250.00000	10.00000	6.00000	395.08401
245.00000	10.00000	7.00000	440.79901
240.00000	10.00000	8.00000	455.33200
240.00000	20.00000	4.00000	521.43201
230.00000	20.00000	5.00000	497.93399
220.00000	20.00000	6.00000	429.50601
210.00000	20.00000	7.00000	707.38702
200.00000	20.00000	8.00000	591.34998
190.00000	30.00000	6.00000	405.11301
175.00000	30.00000	7.00000	924.71002
160.00000	30.00000	8.00000	57.99040
160.00000	40.00000	6.00000	1386.93005
265.00000	10.00000	1.00000	285.35800

260.00000	10.00000	2.00000	415.32501
255.00000	10.00000	3.00000	631.03998
250.00000	10.00000	4.00000	744.41998
245.00000	10.00000	5.00000	397.72699
240.00000	10.00000	6.00000	461.38901
235.00000	10.00000	7.00000	636.92401
230.00000	10.00000	8.00000	380.54901
230.00000	20.00000	4.00000	552.94501
220.00000	20.00000	5.00000	465.59399
210.00000	20.00000	6.00000	536.12402
200.00000	20.00000	7.00000	565.64502
190.00000	20.00000	8.00000	786.83398
165.00000	30.00000	7.00000	1085.89001
150.00000	30.00000	8.00000	185.58600
255.00000	10.00000	1.00000	391.28101
250.00000	10.00000	2.00000	627.77802
245.00000	10.00000	3.00000	824.33398
240.00000	10.00000	4.00000	441.83899
235.00000	10.00000	5.00000	543.67297
230.00000	10.00000	6.00000	715.44702
225.00000	10.00000	7.00000	568.21802
220.00000	10.00000	8.00000	626.80200
220.00000	20.00000	4.00000	614.08801
210.00000	20.00000	5.00000	644.63000
200.00000	20.00000	6.00000	514.32800
190.00000	20.00000	7.00000	681.56897
245.00000	10.00000	1.00000	644.40399
240.00000	10.00000	2.00000	815.27301
235.00000	10.00000	3.00000	471.76300
230.00000	10.00000	4.00000	510.11499
225.00000	10.00000	5.00000	642.47998
220.00000	10.00000	6.00000	656.25897
215.00000	10.00000	7.00000	611.33698
210.00000	10.00000	8.00000	692.57098
210.00000	20.00000	4.00000	594.03699
200.00000	20.00000	5.00000	680.09900
190.00000	20.00000	6.00000	1013.89001
180.00000	20.00000	7.00000	1043.97998
160.00000	30.00000	6.00000	926.60101
235.00000	10.00000	1.00000	1219.73999
230.00000	10.00000	2.00000	706.34198
225.00000	10.00000	3.00000	708.63501
220.00000	10.00000	4.00000	949.45801
215.00000	10.00000	5.00000	844.54303
210.00000	10.00000	6.00000	874.01001
205.00000	10.00000	7.00000	1033.02002

200.00000	10.00000	8.00000	880.33502
200.00000	20.00000	4.00000	821.62299
190.00000	20.00000	5.00000	805.78302
180.00000	20.00000	6.00000	941.08398
150.00000	30.00000	6.00000	58.64900
135.00000	30.00000	7.00000	432.77100
225.00000	10.00000	1.00000	917.98901
220.00000	10.00000	2.00000	687.64600
215.00000	10.00000	3.00000	978.44702
210.00000	10.00000	4.00000	909.48798
205.00000	10.00000	5.00000	959.92297
200.00000	10.00000	6.00000	1153.91003
195.00000	10.00000	7.00000	1046.79004
190.00000	10.00000	8.00000	1155.22998
190.00000	20.00000	4.00000	1051.75000
180.00000	20.00000	5.00000	1104.23999
150.00000	20.00000	8.00000	1069.04004
170.00000	20.00000	6.00000	1491.13000
160.00000	20.00000	7.00000	304.41299
140.00000	30.00000	6.00000	532.50500
215.00000	10.00000	1.00000	573.84601
210.00000	10.00000	2.00000	820.82001
205.00000	10.00000	3.00000	815.90698
200.00000	10.00000	4.00000	862.68903
195.00000	10.00000	5.00000	1012.91998
190.00000	10.00000	6.00000	944.29901
185.00000	10.00000	7.00000	1077.70996
180.00000	10.00000	8.00000	922.79602
180.00000	20.00000	4.00000	1073.06006
170.00000	20.00000	5.00000	1221.45996
140.00000	20.00000	8.00000	840.61298
130.00000	30.00000	6.00000	434.33099
205.00000	10.00000	1.00000	529.40100
200.00000	10.00000	2.00000	477.33600
195.00000	10.00000	3.00000	521.58899
190.00000	10.00000	4.00000	614.02002
185.00000	10.00000	5.00000	548.52002
180.00000	10.00000	6.00000	599.58899
175.00000	10.00000	7.00000	576.91998
170.00000	10.00000	8.00000	799.14001
170.00000	20.00000	4.00000	926.57599
160.00000	20.00000	5.00000	1157.76001
150.00000	20.00000	6.00000	154.73801
140.00000	20.00000	7.00000	750.26599
130.00000	20.00000	8.00000	573.40198
120.00000	30.00000	6.00000	478.50400

195.00000	10.00000	1.00000	710.35901
190.00000	10.00000	2.00000	778.84998
185.00000	10.00000	3.00000	898.10699
180.00000	10.00000	4.00000	823.82703
175.00000	10.00000	5.00000	1051.47998
170.00000	10.00000	6.00000	967.74701
165.00000	10.00000	7.00000	800.92297
160.00000	10.00000	8.00000	1041.20996
160.00000	20.00000	4.00000	939.32001
130.00000	20.00000	7.00000	629.54102
120.00000	20.00000	8.00000	510.19101
185.00000	10.00000	1.00000	799.35199
180.00000	10.00000	2.00000	818.43402
175.00000	10.00000	3.00000	868.59497
170.00000	10.00000	4.00000	987.77399
165.00000	10.00000	5.00000	958.27698
160.00000	10.00000	6.00000	1130.07996
155.00000	10.00000	7.00000	1060.25000
150.00000	10.00000	8.00000	924.34900
150.00000	20.00000	4.00000	1280.50000
120.00000	20.00000	7.00000	2329.43994
110.00000	20.00000	8.00000	1093.93994
140.00000	20.00000	5.00000	42.78930
175.00000	10.00000	1.00000	976.23901
170.00000	10.00000	2.00000	877.24701
165.00000	10.00000	3.00000	1051.30005
160.00000	10.00000	4.00000	1077.25000
155.00000	10.00000	5.00000	1087.27002
150.00000	10.00000	6.00000	1037.28003
145.00000	10.00000	7.00000	1157.57996
140.00000	10.00000	8.00000	1466.10999
120.00000	20.00000	6.00000	797.71899
110.00000	20.00000	7.00000	740.73798
100.00000	20.00000	8.00000	484.72101
165.00000	10.00000	1.00000	956.85199
160.00000	10.00000	2.00000	1072.02002
155.00000	10.00000	3.00000	1138.04004
150.00000	10.00000	4.00000	1208.00000
145.00000	10.00000	5.00000	1116.81006
140.00000	10.00000	6.00000	1187.77002
135.00000	10.00000	7.00000	1574.62000
130.00000	20.00000	4.00000	789.42200
120.00000	20.00000	5.00000	1011.02002
100.00000	20.00000	7.00000	40.77760
110.00000	20.00000	6.00000	279.06601
155.00000	10.00000	1.00000	1047.56006

150.00000	10.00000	2.00000	1243.90002
145.00000	10.00000	3.00000	1380.30005
140.00000	10.00000	4.00000	1230.82996
135.00000	10.00000	5.00000	1283.19995
130.00000	10.00000	6.00000	1681.93994
110.00000	20.00000	5.00000	895.02698
90.00000	20.00000	7.00000	520.04700
100.00000	20.00000	6.00000	263.64200
145.00000	10.00000	1.00000	1031.43994
140.00000	10.00000	2.00000	1307.63000
135.00000	10.00000	3.00000	1091.72998
130.00000	10.00000	4.00000	1085.68994
125.00000	10.00000	5.00000	1404.01001
110.00000	10.00000	8.00000	1348.38000
110.00000	20.00000	4.00000	1470.82996
90.00000	20.00000	6.00000	468.08200
100.00000	20.00000	5.00000	93.08470
135.00000	10.00000	1.00000	1792.77002
130.00000	10.00000	2.00000	1484.90002
125.00000	10.00000	3.00000	1389.18005
120.00000	10.00000	4.00000	1728.75000
105.00000	10.00000	7.00000	960.64697
100.00000	10.00000	8.00000	1314.85999
100.00000	20.00000	4.00000	980.75702
90.00000	20.00000	5.00000	582.38599
80.00000	20.00000	6.00000	429.06500
125.00000	10.00000	1.00000	1138.76001
120.00000	10.00000	2.00000	1230.88000
115.00000	10.00000	3.00000	1639.81006
100.00000	10.00000	6.00000	1471.77002
95.00000	10.00000	7.00000	1181.04004
90.00000	10.00000	8.00000	825.25000
90.00000	20.00000	4.00000	639.42297
80.00000	20.00000	5.00000	468.52399
115.00000	10.00000	1.00000	1038.08997
110.00000	10.00000	2.00000	1584.26001
95.00000	10.00000	5.00000	1532.64001
90.00000	10.00000	6.00000	1465.85999
85.00000	10.00000	7.00000	1002.34003
80.00000	10.00000	8.00000	528.64600
80.00000	20.00000	4.00000	498.41299
70.00000	20.00000	5.00000	441.20200
105.00000	10.00000	1.00000	1157.93005
90.00000	10.00000	4.00000	1542.57996
85.00000	10.00000	5.00000	1568.10999
80.00000	10.00000	6.00000	873.48602

75.00000	10.00000	7.00000	632.76501
70.00000	10.00000	8.00000	397.14600
70.00000	20.00000	4.00000	483.80200
85.00000	10.00000	3.00000	1368.06006
80.00000	10.00000	4.00000	1447.65002
75.00000	10.00000	5.00000	841.27600
70.00000	10.00000	6.00000	531.89801
65.00000	10.00000	7.00000	417.78900
60.00000	10.00000	8.00000	415.17899
95.00000	10.00000	1.00000	710.10400
90.00000	10.00000	2.00000	1675.78003
60.00000	20.00000	4.00000	453.89600
80.00000	10.00000	2.00000	1256.81006
75.00000	10.00000	3.00000	1524.60999
70.00000	10.00000	4.00000	921.12000
65.00000	10.00000	5.00000	520.96002
60.00000	10.00000	6.00000	407.63501
55.00000	10.00000	7.00000	345.61700
50.00000	10.00000	8.00000	329.42899
85.00000	10.00000	1.00000	2325.79004
55.00000	10.00000	1.00000	1885.83997
50.00000	10.00000	2.00000	1219.80005
45.00000	10.00000	3.00000	899.83002
40.00000	10.00000	4.00000	811.34601
35.00000	10.00000	5.00000	839.58801
45.00000	10.00000	1.00000	935.75500
40.00000	10.00000	2.00000	919.53198
35.00000	10.00000	3.00000	825.79401
30.00000	10.00000	4.00000	909.61603
35.00000	10.00000	1.00000	450.56201
30.00000	10.00000	2.00000	418.93900
25.00000	10.00000	3.00000	512.84302
25.00000	10.00000	1.00000	309.07999
20.00000	10.00000	2.00000	329.51300
15.00000	10.00000	1.00000	307.47000
0			
0			
0			

Sting/Swift prg: COL2

10.00000

3

878

1

0

615.00000	10.00000	1.00000	483.71201
-----------	----------	---------	-----------

610.00000	10.00000	2.00000	509.29001
605.00000	10.00000	3.00000	495.39099
600.00000	10.00000	4.00000	525.15698
595.00000	10.00000	5.00000	408.49100
590.00000	10.00000	6.00000	353.49701
585.00000	10.00000	7.00000	309.20801
580.00000	10.00000	8.00000	301.14899
605.00000	10.00000	1.00000	361.08701
600.00000	10.00000	2.00000	403.44101
595.00000	10.00000	3.00000	456.13300
590.00000	10.00000	4.00000	364.44800
585.00000	10.00000	5.00000	333.23199
580.00000	10.00000	6.00000	292.47000
575.00000	10.00000	7.00000	316.39200
570.00000	10.00000	8.00000	437.17200
570.00000	20.00000	4.00000	372.04800
560.00000	20.00000	5.00000	295.88300
540.00000	20.00000	7.00000	457.13699
530.00000	20.00000	8.00000	396.87500
550.00000	20.00000	6.00000	141.21300
595.00000	10.00000	1.00000	344.06699
590.00000	10.00000	2.00000	419.59698
585.00000	10.00000	3.00000	323.34201
580.00000	10.00000	4.00000	389.86600
575.00000	10.00000	5.00000	304.66800
570.00000	10.00000	6.00000	290.33499
565.00000	10.00000	7.00000	368.72699
560.00000	10.00000	8.00000	295.66199
560.00000	20.00000	4.00000	253.26700
550.00000	20.00000	5.00000	346.48300
540.00000	20.00000	6.00000	391.34601
530.00000	20.00000	7.00000	594.13898
520.00000	20.00000	8.00000	463.52301
495.00000	30.00000	7.00000	306.88501
480.00000	30.00000	8.00000	1262.75000
510.00000	30.00000	6.00000	292.75800
585.00000	10.00000	1.00000	338.37701
580.00000	10.00000	2.00000	289.09299
575.00000	10.00000	3.00000	279.11301
570.00000	10.00000	4.00000	259.62399
565.00000	10.00000	5.00000	280.30899
560.00000	10.00000	6.00000	265.74799
555.00000	10.00000	7.00000	207.04100
550.00000	10.00000	8.00000	150.59700
550.00000	20.00000	4.00000	232.41901
540.00000	20.00000	5.00000	407.45599

530.00000	20.00000	6.00000	325.48700
520.00000	20.00000	7.00000	333.37000
510.00000	20.00000	8.00000	433.70901
500.00000	30.00000	6.00000	550.00800
485.00000	30.00000	7.00000	538.38202
470.00000	30.00000	8.00000	859.34802
470.00000	40.00000	6.00000	794.75500
450.00000	40.00000	7.00000	1341.67004
430.00000	40.00000	8.00000	716.54797
575.00000	10.00000	1.00000	270.74899
570.00000	10.00000	2.00000	277.08600
565.00000	10.00000	3.00000	266.61700
560.00000	10.00000	4.00000	278.24399
555.00000	10.00000	5.00000	295.36801
550.00000	10.00000	6.00000	252.84399
545.00000	10.00000	7.00000	348.26099
540.00000	10.00000	8.00000	23.47900
540.00000	20.00000	4.00000	177.50800
530.00000	20.00000	5.00000	326.56799
520.00000	20.00000	6.00000	307.02399
510.00000	20.00000	7.00000	290.90601
500.00000	20.00000	8.00000	613.38098
490.00000	30.00000	6.00000	639.85602
460.00000	30.00000	8.00000	1103.59998
475.00000	30.00000	7.00000	419.59201
460.00000	40.00000	6.00000	1046.55005
440.00000	40.00000	7.00000	1214.52002
420.00000	40.00000	8.00000	585.60797
405.00000	50.00000	7.00000	339.44501
380.00000	50.00000	8.00000	600.34399
565.00000	10.00000	1.00000	247.62000
560.00000	10.00000	2.00000	271.84201
555.00000	10.00000	3.00000	292.08801
550.00000	10.00000	4.00000	310.79800
545.00000	10.00000	5.00000	289.32901
540.00000	10.00000	6.00000	263.11801
535.00000	10.00000	7.00000	344.76700
530.00000	10.00000	8.00000	120.38900
530.00000	20.00000	4.00000	227.34801
520.00000	20.00000	5.00000	274.93900
510.00000	20.00000	6.00000	292.46799
500.00000	20.00000	7.00000	351.77399
490.00000	20.00000	8.00000	481.00601
480.00000	30.00000	6.00000	568.80103
465.00000	30.00000	7.00000	476.39200
450.00000	30.00000	8.00000	836.89801

450.00000	40.00000	6.00000	1160.89001
430.00000	40.00000	7.00000	956.21399
410.00000	40.00000	8.00000	361.72101
370.00000	50.00000	8.00000	671.56201
395.00000	50.00000	7.00000	413.23199
360.00000	60.00000	7.00000	622.93701
330.00000	60.00000	8.00000	628.15503
555.00000	10.00000	1.00000	215.26300
550.00000	10.00000	2.00000	254.40500
545.00000	10.00000	3.00000	267.30801
540.00000	10.00000	4.00000	241.39101
535.00000	10.00000	5.00000	262.14700
530.00000	10.00000	6.00000	185.53700
525.00000	10.00000	7.00000	168.88800
520.00000	10.00000	8.00000	418.65201
520.00000	20.00000	4.00000	280.13000
510.00000	20.00000	5.00000	222.84500
500.00000	20.00000	6.00000	215.12199
490.00000	20.00000	7.00000	304.51401
480.00000	20.00000	8.00000	624.88300
470.00000	30.00000	6.00000	393.64700
455.00000	30.00000	7.00000	577.70898
440.00000	30.00000	8.00000	1170.29004
440.00000	40.00000	6.00000	1241.66003
420.00000	40.00000	7.00000	665.88098
400.00000	40.00000	8.00000	591.47302
360.00000	50.00000	8.00000	534.90900
385.00000	50.00000	7.00000	387.29001
545.00000	10.00000	1.00000	288.48801
540.00000	10.00000	2.00000	341.00601
535.00000	10.00000	3.00000	352.35400
530.00000	10.00000	4.00000	301.70001
525.00000	10.00000	5.00000	256.14999
520.00000	10.00000	6.00000	224.04401
515.00000	10.00000	7.00000	226.82899
510.00000	10.00000	8.00000	235.21600
510.00000	20.00000	4.00000	221.90700
500.00000	20.00000	5.00000	221.62300
490.00000	20.00000	6.00000	280.82101
480.00000	20.00000	7.00000	358.31100
470.00000	20.00000	8.00000	576.36603
445.00000	30.00000	7.00000	537.75201
430.00000	30.00000	8.00000	1031.59998
460.00000	30.00000	6.00000	496.36899
430.00000	40.00000	6.00000	960.78003
410.00000	40.00000	7.00000	590.29901

390.00000	40.00000	8.00000	364.32800
375.00000	50.00000	7.00000	493.18100
350.00000	50.00000	8.00000	558.75098
340.00000	60.00000	7.00000	583.03198
310.00000	60.00000	8.00000	606.88000
535.00000	10.00000	1.00000	246.33000
530.00000	10.00000	2.00000	286.07300
525.00000	10.00000	3.00000	305.83801
520.00000	10.00000	4.00000	235.75101
515.00000	10.00000	5.00000	203.95500
510.00000	10.00000	6.00000	213.70000
505.00000	10.00000	7.00000	238.37100
500.00000	10.00000	8.00000	194.76300
500.00000	20.00000	4.00000	213.67900
490.00000	20.00000	5.00000	292.28400
480.00000	20.00000	6.00000	386.34299
460.00000	20.00000	8.00000	496.85501
470.00000	20.00000	7.00000	46.96720
450.00000	30.00000	6.00000	333.33301
435.00000	30.00000	7.00000	874.71301
420.00000	30.00000	8.00000	932.78400
420.00000	40.00000	6.00000	944.32397
400.00000	40.00000	7.00000	477.99200
380.00000	40.00000	8.00000	336.78101
365.00000	50.00000	7.00000	531.34497
340.00000	50.00000	8.00000	540.31201
330.00000	60.00000	7.00000	594.12201
300.00000	60.00000	8.00000	596.07501
525.00000	10.00000	1.00000	240.38000
520.00000	10.00000	2.00000	286.91299
515.00000	10.00000	3.00000	232.68201
510.00000	10.00000	4.00000	203.70700
505.00000	10.00000	5.00000	224.77200
500.00000	10.00000	6.00000	218.73801
495.00000	10.00000	7.00000	199.28799
490.00000	10.00000	8.00000	174.82600
490.00000	20.00000	4.00000	193.78999
480.00000	20.00000	5.00000	223.15800
470.00000	20.00000	6.00000	324.54501
460.00000	20.00000	7.00000	392.56601
450.00000	20.00000	8.00000	384.53000
440.00000	30.00000	6.00000	403.12701
410.00000	30.00000	8.00000	783.96503
425.00000	30.00000	7.00000	715.10602
370.00000	40.00000	8.00000	319.53699
410.00000	40.00000	6.00000	711.16803

390.00000	40.00000	7.00000	517.82098
355.00000	50.00000	7.00000	500.22198
320.00000	60.00000	7.00000	527.61603
515.00000	10.00000	1.00000	280.97101
510.00000	10.00000	2.00000	259.75201
505.00000	10.00000	3.00000	222.37500
500.00000	10.00000	4.00000	247.80299
495.00000	10.00000	5.00000	229.61200
490.00000	10.00000	6.00000	77.88140
485.00000	10.00000	7.00000	316.97299
480.00000	10.00000	8.00000	178.17900
480.00000	20.00000	4.00000	226.75700
470.00000	20.00000	5.00000	261.84799
460.00000	20.00000	6.00000	299.77301
450.00000	20.00000	7.00000	396.92599
430.00000	30.00000	6.00000	853.82501
400.00000	30.00000	8.00000	620.83899
415.00000	30.00000	7.00000	938.29303
400.00000	40.00000	6.00000	610.80603
360.00000	40.00000	8.00000	412.65799
380.00000	40.00000	7.00000	323.86301
345.00000	50.00000	7.00000	449.08301
320.00000	50.00000	8.00000	513.49402
310.00000	60.00000	7.00000	471.79300
505.00000	10.00000	1.00000	232.80200
500.00000	10.00000	2.00000	201.93900
495.00000	10.00000	3.00000	225.30000
490.00000	10.00000	4.00000	215.72701
485.00000	10.00000	5.00000	259.59601
480.00000	10.00000	6.00000	80.01920
475.00000	10.00000	7.00000	142.57100
470.00000	10.00000	8.00000	120.72900
470.00000	20.00000	4.00000	206.10500
460.00000	20.00000	5.00000	273.94601
450.00000	20.00000	6.00000	301.78601
440.00000	20.00000	7.00000	335.52200
430.00000	20.00000	8.00000	493.88400
420.00000	30.00000	6.00000	511.82999
405.00000	30.00000	7.00000	818.59100
390.00000	30.00000	8.00000	529.16602
390.00000	40.00000	6.00000	502.90799
350.00000	40.00000	8.00000	417.84900
370.00000	40.00000	7.00000	337.30099
335.00000	50.00000	7.00000	504.34500
310.00000	50.00000	8.00000	513.20502
300.00000	60.00000	7.00000	455.40500

495.00000	10.00000	1.00000	211.47301
490.00000	10.00000	2.00000	236.49200
485.00000	10.00000	3.00000	212.23900
480.00000	10.00000	4.00000	139.78900
475.00000	10.00000	5.00000	137.00000
470.00000	10.00000	6.00000	127.83800
460.00000	10.00000	8.00000	174.06599
465.00000	10.00000	7.00000	118.28500
460.00000	20.00000	4.00000	219.21800
450.00000	20.00000	5.00000	256.29001
440.00000	20.00000	6.00000	242.40700
430.00000	20.00000	7.00000	765.44098
410.00000	30.00000	6.00000	810.46198
395.00000	30.00000	7.00000	679.31403
380.00000	30.00000	8.00000	457.37201
380.00000	40.00000	6.00000	452.58801
360.00000	40.00000	7.00000	326.27499
340.00000	40.00000	8.00000	449.27701
325.00000	50.00000	7.00000	454.06699
300.00000	50.00000	8.00000	433.91599
485.00000	10.00000	1.00000	289.31699
480.00000	10.00000	2.00000	246.82800
475.00000	10.00000	3.00000	171.41000
470.00000	10.00000	4.00000	138.44000
465.00000	10.00000	5.00000	104.30500
460.00000	10.00000	6.00000	188.14999
455.00000	10.00000	7.00000	136.91600
450.00000	10.00000	8.00000	14.16680
450.00000	20.00000	4.00000	212.28900
440.00000	20.00000	5.00000	279.27701
430.00000	20.00000	6.00000	373.48001
420.00000	20.00000	7.00000	343.12601
410.00000	20.00000	8.00000	410.26199
400.00000	30.00000	6.00000	809.29901
385.00000	30.00000	7.00000	533.74597
370.00000	30.00000	8.00000	316.60400
370.00000	40.00000	6.00000	346.39301
350.00000	40.00000	7.00000	331.99500
330.00000	40.00000	8.00000	455.19299
315.00000	50.00000	7.00000	427.22501
290.00000	50.00000	8.00000	431.50900
280.00000	60.00000	7.00000	480.40500
475.00000	10.00000	1.00000	303.17599
470.00000	10.00000	2.00000	192.31900
465.00000	10.00000	3.00000	137.48700
460.00000	10.00000	4.00000	111.57900

455.00000	10.00000	5.00000	109.70900
450.00000	10.00000	6.00000	124.96500
445.00000	10.00000	7.00000	241.50999
440.00000	10.00000	8.00000	115.21700
440.00000	20.00000	4.00000	224.71100
430.00000	20.00000	5.00000	412.04300
410.00000	20.00000	7.00000	465.20499
420.00000	20.00000	6.00000	123.92500
400.00000	20.00000	8.00000	504.19299
390.00000	30.00000	6.00000	715.08600
375.00000	30.00000	7.00000	470.94601
360.00000	30.00000	8.00000	303.20499
360.00000	40.00000	6.00000	332.57800
340.00000	40.00000	7.00000	349.80099
320.00000	40.00000	8.00000	436.89801
270.00000	60.00000	7.00000	496.61899
465.00000	10.00000	1.00000	400.09601
460.00000	10.00000	2.00000	216.29900
455.00000	10.00000	3.00000	146.14400
450.00000	10.00000	4.00000	104.49800
445.00000	10.00000	5.00000	198.07201
440.00000	10.00000	6.00000	350.58099
435.00000	10.00000	7.00000	196.78700
430.00000	10.00000	8.00000	167.38800
430.00000	20.00000	4.00000	285.36600
420.00000	20.00000	5.00000	298.90799
390.00000	20.00000	8.00000	814.14001
400.00000	20.00000	7.00000	996.74103
380.00000	30.00000	6.00000	583.16602
365.00000	30.00000	7.00000	470.74600
350.00000	30.00000	8.00000	328.72699
350.00000	40.00000	6.00000	323.17999
330.00000	40.00000	7.00000	406.44101
310.00000	40.00000	8.00000	457.20099
295.00000	50.00000	7.00000	496.01300
270.00000	50.00000	8.00000	525.20001
455.00000	10.00000	1.00000	353.70901
450.00000	10.00000	2.00000	164.85699
445.00000	10.00000	3.00000	165.43900
440.00000	10.00000	4.00000	85.21120
435.00000	10.00000	5.00000	142.29601
430.00000	10.00000	6.00000	190.55299
425.00000	10.00000	7.00000	292.17001
420.00000	10.00000	8.00000	199.71600
420.00000	20.00000	4.00000	275.48700
410.00000	20.00000	5.00000	331.11600

400.00000	20.00000	6.00000	333.70999
390.00000	20.00000	7.00000	921.65302
380.00000	20.00000	8.00000	915.65100
370.00000	30.00000	6.00000	550.45398
355.00000	30.00000	7.00000	410.92599
340.00000	30.00000	8.00000	360.96100
340.00000	40.00000	6.00000	339.53601
320.00000	40.00000	7.00000	455.06299
300.00000	40.00000	8.00000	456.76501
260.00000	50.00000	8.00000	394.20001
285.00000	50.00000	7.00000	414.28900
445.00000	10.00000	1.00000	339.35101
440.00000	10.00000	2.00000	135.39301
435.00000	10.00000	3.00000	90.85950
430.00000	10.00000	4.00000	187.42400
425.00000	10.00000	5.00000	184.38200
420.00000	10.00000	6.00000	198.71400
415.00000	10.00000	7.00000	312.27899
410.00000	10.00000	8.00000	254.18900
410.00000	20.00000	4.00000	286.46500
400.00000	20.00000	5.00000	407.64899
390.00000	20.00000	6.00000	361.42999
380.00000	20.00000	7.00000	836.95203
370.00000	20.00000	8.00000	728.54199
360.00000	30.00000	6.00000	531.99799
345.00000	30.00000	7.00000	376.37100
330.00000	30.00000	8.00000	348.14499
330.00000	40.00000	6.00000	372.40500
310.00000	40.00000	7.00000	474.49500
290.00000	40.00000	8.00000	453.73099
250.00000	50.00000	8.00000	396.01300
275.00000	50.00000	7.00000	437.93301
435.00000	10.00000	1.00000	266.70200
430.00000	10.00000	2.00000	89.74300
425.00000	10.00000	3.00000	125.51300
420.00000	10.00000	4.00000	192.17101
415.00000	10.00000	5.00000	231.98199
410.00000	10.00000	6.00000	224.40700
405.00000	10.00000	7.00000	317.02899
400.00000	10.00000	8.00000	463.10999
400.00000	20.00000	4.00000	317.41501
390.00000	20.00000	5.00000	481.72101
370.00000	20.00000	7.00000	848.79199
360.00000	20.00000	8.00000	512.04797
380.00000	20.00000	6.00000	444.96600
350.00000	30.00000	6.00000	468.25699

335.00000	30.00000	7.00000	307.63699
320.00000	30.00000	8.00000	312.87000
320.00000	40.00000	6.00000	391.08701
300.00000	40.00000	7.00000	465.22900
265.00000	50.00000	7.00000	454.44800
425.00000	10.00000	1.00000	112.30500
420.00000	10.00000	2.00000	140.89301
415.00000	10.00000	3.00000	139.06300
410.00000	10.00000	4.00000	164.02699
405.00000	10.00000	5.00000	279.65799
400.00000	10.00000	6.00000	165.42200
395.00000	10.00000	7.00000	411.62601
390.00000	10.00000	8.00000	272.26999
390.00000	20.00000	4.00000	342.59399
380.00000	20.00000	5.00000	349.98499
360.00000	20.00000	7.00000	616.53101
350.00000	20.00000	8.00000	509.37500
370.00000	20.00000	6.00000	624.65503
340.00000	30.00000	6.00000	418.14301
325.00000	30.00000	7.00000	354.07700
310.00000	30.00000	8.00000	365.25101
310.00000	40.00000	6.00000	426.90701
270.00000	40.00000	8.00000	472.06201
290.00000	40.00000	7.00000	417.78000
415.00000	10.00000	1.00000	115.21600
410.00000	10.00000	2.00000	125.75500
405.00000	10.00000	3.00000	156.54201
400.00000	10.00000	4.00000	393.84500
395.00000	10.00000	5.00000	289.54999
390.00000	10.00000	6.00000	77.50820
385.00000	10.00000	7.00000	258.53500
380.00000	10.00000	8.00000	468.37201
380.00000	20.00000	4.00000	427.00101
370.00000	20.00000	5.00000	514.37402
360.00000	20.00000	6.00000	810.18103
350.00000	20.00000	7.00000	573.30603
340.00000	20.00000	8.00000	590.15997
330.00000	30.00000	6.00000	356.17001
315.00000	30.00000	7.00000	330.53699
300.00000	30.00000	8.00000	418.54099
300.00000	40.00000	6.00000	446.92499
280.00000	40.00000	7.00000	431.70401
260.00000	40.00000	8.00000	395.55899
245.00000	50.00000	7.00000	505.39200
405.00000	10.00000	1.00000	65.14380
400.00000	10.00000	2.00000	89.97300

395.00000	10.00000	3.00000	162.38200
390.00000	10.00000	4.00000	208.93401
385.00000	10.00000	5.00000	143.56900
380.00000	10.00000	6.00000	140.53700
375.00000	10.00000	7.00000	343.23099
370.00000	10.00000	8.00000	252.85699
370.00000	20.00000	4.00000	360.07199
360.00000	20.00000	5.00000	596.88300
350.00000	20.00000	6.00000	587.59100
340.00000	20.00000	7.00000	513.32001
330.00000	20.00000	8.00000	471.19601
320.00000	30.00000	6.00000	353.05899
305.00000	30.00000	7.00000	352.20700
290.00000	30.00000	8.00000	473.97900
290.00000	40.00000	6.00000	442.94601
270.00000	40.00000	7.00000	426.37399
250.00000	40.00000	8.00000	389.34601
235.00000	50.00000	7.00000	397.15500
395.00000	10.00000	1.00000	112.19800
390.00000	10.00000	2.00000	229.25999
385.00000	10.00000	3.00000	239.35600
380.00000	10.00000	4.00000	197.23700
375.00000	10.00000	5.00000	206.96700
370.00000	10.00000	6.00000	340.91199
365.00000	10.00000	7.00000	460.75800
360.00000	10.00000	8.00000	581.31299
360.00000	20.00000	4.00000	510.27802
350.00000	20.00000	5.00000	729.10999
340.00000	20.00000	6.00000	540.75000
330.00000	20.00000	7.00000	576.29700
320.00000	20.00000	8.00000	416.45099
310.00000	30.00000	6.00000	387.60999
295.00000	30.00000	7.00000	399.75699
280.00000	30.00000	8.00000	488.61301
280.00000	40.00000	6.00000	468.15799
225.00000	50.00000	7.00000	501.02399
385.00000	10.00000	1.00000	184.19200
380.00000	10.00000	2.00000	213.66299
375.00000	10.00000	3.00000	195.71700
370.00000	10.00000	4.00000	168.00400
365.00000	10.00000	5.00000	304.24701
360.00000	10.00000	6.00000	301.35501
355.00000	10.00000	7.00000	442.50101
350.00000	10.00000	8.00000	515.62598
350.00000	20.00000	4.00000	634.13098
340.00000	20.00000	5.00000	646.31299

330.00000	20.00000	6.00000	553.21100
320.00000	20.00000	7.00000	460.62201
310.00000	20.00000	8.00000	361.49500
300.00000	30.00000	6.00000	378.82199
285.00000	30.00000	7.00000	458.11301
270.00000	30.00000	8.00000	395.76700
270.00000	40.00000	6.00000	419.73700
250.00000	40.00000	7.00000	426.63101
230.00000	40.00000	8.00000	417.72501
375.00000	10.00000	1.00000	134.33800
370.00000	10.00000	2.00000	89.54440
365.00000	10.00000	3.00000	118.37600
360.00000	10.00000	4.00000	232.14500
355.00000	10.00000	5.00000	191.43800
350.00000	10.00000	6.00000	285.08301
345.00000	10.00000	7.00000	387.57199
340.00000	10.00000	8.00000	571.46997
330.00000	20.00000	5.00000	481.87000
340.00000	20.00000	4.00000	627.81000
320.00000	20.00000	6.00000	484.24100
310.00000	20.00000	7.00000	315.50201
300.00000	20.00000	8.00000	296.77200
290.00000	30.00000	6.00000	357.43201
275.00000	30.00000	7.00000	454.59000
260.00000	30.00000	8.00000	380.31601
260.00000	40.00000	6.00000	399.97900
240.00000	40.00000	7.00000	400.26599
220.00000	40.00000	8.00000	383.27899
365.00000	10.00000	1.00000	170.31300
360.00000	10.00000	2.00000	162.99699
355.00000	10.00000	3.00000	287.56100
350.00000	10.00000	4.00000	345.81000
345.00000	10.00000	5.00000	483.39200
340.00000	10.00000	6.00000	508.76199
335.00000	10.00000	7.00000	804.59900
330.00000	10.00000	8.00000	772.23901
330.00000	20.00000	4.00000	644.59100
320.00000	20.00000	5.00000	577.79498
310.00000	20.00000	6.00000	538.03802
300.00000	20.00000	7.00000	440.08899
290.00000	20.00000	8.00000	428.79800
280.00000	30.00000	6.00000	427.51901
265.00000	30.00000	7.00000	501.72101
250.00000	30.00000	8.00000	477.02100
250.00000	40.00000	6.00000	506.08801
230.00000	40.00000	7.00000	508.86801

210.00000	40.00000	8.00000	603.69501
355.00000	10.00000	1.00000	127.73000
350.00000	10.00000	2.00000	235.75700
345.00000	10.00000	3.00000	253.28700
340.00000	10.00000	4.00000	346.09000
335.00000	10.00000	5.00000	402.51001
330.00000	10.00000	6.00000	623.24902
325.00000	10.00000	7.00000	614.08099
320.00000	10.00000	8.00000	553.35498
320.00000	20.00000	4.00000	554.03802
310.00000	20.00000	5.00000	612.48798
300.00000	20.00000	6.00000	502.98801
290.00000	20.00000	7.00000	490.16000
280.00000	20.00000	8.00000	441.99301
270.00000	30.00000	6.00000	494.77899
255.00000	30.00000	7.00000	456.49399
240.00000	30.00000	8.00000	492.87399
200.00000	40.00000	8.00000	518.93402
345.00000	10.00000	1.00000	339.76700
340.00000	10.00000	2.00000	335.02499
335.00000	10.00000	3.00000	447.39801
330.00000	10.00000	4.00000	506.42499
325.00000	10.00000	5.00000	794.67902
320.00000	10.00000	6.00000	796.25598
315.00000	10.00000	7.00000	746.39899
310.00000	10.00000	8.00000	653.44397
310.00000	20.00000	4.00000	661.07501
300.00000	20.00000	5.00000	633.17499
290.00000	20.00000	6.00000	518.82599
280.00000	20.00000	7.00000	519.37097
270.00000	20.00000	8.00000	453.64600
260.00000	30.00000	6.00000	583.64203
245.00000	30.00000	7.00000	500.24500
230.00000	40.00000	6.00000	486.60999
210.00000	40.00000	7.00000	487.37701
335.00000	10.00000	1.00000	307.85199
330.00000	10.00000	2.00000	351.96100
325.00000	10.00000	3.00000	382.67599
320.00000	10.00000	4.00000	623.33899
315.00000	10.00000	5.00000	652.64099
310.00000	10.00000	6.00000	631.48798
305.00000	10.00000	7.00000	568.10498
300.00000	10.00000	8.00000	706.69897
300.00000	20.00000	4.00000	746.79199
290.00000	20.00000	5.00000	587.32599
280.00000	20.00000	6.00000	569.03400

270.00000	20.00000	7.00000	496.06201
260.00000	20.00000	8.00000	557.76202
250.00000	30.00000	6.00000	590.15997
235.00000	30.00000	7.00000	549.90997
220.00000	30.00000	8.00000	510.26801
220.00000	40.00000	6.00000	498.15500
200.00000	40.00000	7.00000	516.97302
325.00000	10.00000	1.00000	525.53198
320.00000	10.00000	2.00000	577.71600
315.00000	10.00000	3.00000	874.55200
310.00000	10.00000	4.00000	939.26703
305.00000	10.00000	5.00000	971.42499
300.00000	10.00000	6.00000	882.19299
295.00000	10.00000	7.00000	1117.37000
290.00000	10.00000	8.00000	1008.40002
290.00000	20.00000	4.00000	790.27802
280.00000	20.00000	5.00000	637.43597
270.00000	20.00000	6.00000	623.63000
260.00000	20.00000	7.00000	579.76099
250.00000	20.00000	8.00000	693.41803
240.00000	30.00000	6.00000	615.59003
225.00000	30.00000	7.00000	700.51001
210.00000	30.00000	8.00000	644.10303
210.00000	40.00000	6.00000	516.22601
190.00000	40.00000	7.00000	532.38599
315.00000	10.00000	1.00000	532.69501
310.00000	10.00000	2.00000	623.03302
305.00000	10.00000	3.00000	636.06403
300.00000	10.00000	4.00000	693.76099
295.00000	10.00000	5.00000	637.55200
290.00000	10.00000	6.00000	802.36798
285.00000	10.00000	7.00000	742.84698
280.00000	10.00000	8.00000	665.92499
280.00000	20.00000	4.00000	701.97198
270.00000	20.00000	5.00000	664.42700
260.00000	20.00000	6.00000	569.40802
250.00000	20.00000	7.00000	627.70203
240.00000	20.00000	8.00000	760.77600
230.00000	30.00000	6.00000	574.35199
180.00000	40.00000	7.00000	625.49402
305.00000	10.00000	1.00000	1331.57996
300.00000	10.00000	2.00000	1078.52002
295.00000	10.00000	3.00000	1095.10999
290.00000	10.00000	4.00000	976.46503
285.00000	10.00000	5.00000	1155.22998
280.00000	10.00000	6.00000	1158.16003

275.00000	10.00000	7.00000	922.59302
270.00000	10.00000	8.00000	872.78101
270.00000	20.00000	4.00000	782.39502
260.00000	20.00000	5.00000	651.26703
250.00000	20.00000	6.00000	600.82202
240.00000	20.00000	7.00000	842.81799
230.00000	20.00000	8.00000	650.18402
220.00000	30.00000	6.00000	675.58899
205.00000	30.00000	7.00000	643.43500
190.00000	30.00000	8.00000	391.26501
190.00000	40.00000	6.00000	305.78101
295.00000	10.00000	1.00000	1051.09998
290.00000	10.00000	2.00000	1036.64001
285.00000	10.00000	3.00000	902.98700
280.00000	10.00000	4.00000	1068.93005
275.00000	10.00000	5.00000	1130.89001
270.00000	10.00000	6.00000	1018.59003
265.00000	10.00000	7.00000	662.65698
260.00000	10.00000	8.00000	968.55603
260.00000	20.00000	4.00000	786.87402
250.00000	20.00000	5.00000	746.40802
240.00000	20.00000	6.00000	719.59900
230.00000	20.00000	7.00000	969.85901
220.00000	20.00000	8.00000	189.11700
210.00000	30.00000	6.00000	947.41602
195.00000	30.00000	7.00000	856.82898
180.00000	40.00000	6.00000	793.59802
285.00000	10.00000	1.00000	1387.60999
280.00000	10.00000	2.00000	1105.21997
275.00000	10.00000	3.00000	1231.54004
270.00000	10.00000	4.00000	1039.33997
265.00000	10.00000	5.00000	1022.73999
260.00000	10.00000	6.00000	882.69098
255.00000	10.00000	7.00000	813.88702
250.00000	10.00000	8.00000	1013.58002
250.00000	20.00000	4.00000	752.27100
240.00000	20.00000	5.00000	647.01703
230.00000	20.00000	6.00000	834.08698
220.00000	20.00000	7.00000	750.57800
210.00000	20.00000	8.00000	756.98999
170.00000	30.00000	8.00000	1333.14001
170.00000	40.00000	6.00000	1115.32996
275.00000	10.00000	1.00000	932.67798
270.00000	10.00000	2.00000	941.21198
265.00000	10.00000	3.00000	774.90503
260.00000	10.00000	4.00000	779.99500

255.00000	10.00000	5.00000	526.77802
250.00000	10.00000	6.00000	614.98401
245.00000	10.00000	7.00000	556.96698
240.00000	10.00000	8.00000	528.72302
240.00000	20.00000	4.00000	503.12100
230.00000	20.00000	5.00000	596.17798
220.00000	20.00000	6.00000	552.90302
210.00000	20.00000	7.00000	1031.71997
200.00000	20.00000	8.00000	649.33197
190.00000	30.00000	6.00000	597.58600
175.00000	30.00000	7.00000	680.39801
160.00000	30.00000	8.00000	624.25098
160.00000	40.00000	6.00000	834.48499
265.00000	10.00000	1.00000	975.09998
260.00000	10.00000	2.00000	808.51599
255.00000	10.00000	3.00000	814.47101
250.00000	10.00000	4.00000	630.09302
245.00000	10.00000	5.00000	696.64398
240.00000	10.00000	6.00000	637.84601
235.00000	10.00000	7.00000	653.26599
230.00000	10.00000	8.00000	460.86099
230.00000	20.00000	4.00000	548.22498
220.00000	20.00000	5.00000	582.03900
210.00000	20.00000	6.00000	614.03497
200.00000	20.00000	7.00000	658.81000
190.00000	20.00000	8.00000	695.87097
180.00000	30.00000	6.00000	490.61801
165.00000	30.00000	7.00000	1266.01001
150.00000	30.00000	8.00000	135.74699
255.00000	10.00000	1.00000	694.19000
250.00000	10.00000	2.00000	740.38202
245.00000	10.00000	3.00000	540.35999
240.00000	10.00000	4.00000	551.64203
235.00000	10.00000	5.00000	460.94699
230.00000	10.00000	6.00000	423.17700
225.00000	10.00000	7.00000	372.64301
220.00000	10.00000	8.00000	454.60999
220.00000	20.00000	4.00000	517.97198
210.00000	20.00000	5.00000	682.23999
200.00000	20.00000	6.00000	506.86301
190.00000	20.00000	7.00000	721.32001
155.00000	30.00000	7.00000	146.97099
245.00000	10.00000	1.00000	1101.47998
240.00000	10.00000	2.00000	874.11200
235.00000	10.00000	3.00000	835.92798
230.00000	10.00000	4.00000	623.07098

225.00000	10.00000	5.00000	560.19202
220.00000	10.00000	6.00000	403.19699
215.00000	10.00000	7.00000	528.36700
210.00000	10.00000	8.00000	474.37701
210.00000	20.00000	4.00000	507.49701
200.00000	20.00000	5.00000	511.52499
190.00000	20.00000	6.00000	541.51001
180.00000	20.00000	7.00000	554.31000
170.00000	20.00000	8.00000	581.65503
160.00000	30.00000	6.00000	699.67401
145.00000	30.00000	7.00000	649.49799
235.00000	10.00000	1.00000	1023.97998
230.00000	10.00000	2.00000	1085.91003
225.00000	10.00000	3.00000	773.72601
220.00000	10.00000	4.00000	631.67200
215.00000	10.00000	5.00000	453.45200
210.00000	10.00000	6.00000	559.08502
205.00000	10.00000	7.00000	487.21500
200.00000	10.00000	8.00000	661.80298
200.00000	20.00000	4.00000	657.74402
190.00000	20.00000	5.00000	451.54199
180.00000	20.00000	6.00000	713.81799
150.00000	30.00000	6.00000	568.43298
135.00000	30.00000	7.00000	835.33600
225.00000	10.00000	1.00000	989.31403
220.00000	10.00000	2.00000	784.00897
215.00000	10.00000	3.00000	623.28101
210.00000	10.00000	4.00000	400.42899
205.00000	10.00000	5.00000	493.26901
200.00000	10.00000	6.00000	424.00101
195.00000	10.00000	7.00000	585.73999
190.00000	10.00000	8.00000	537.02002
190.00000	20.00000	4.00000	530.73700
180.00000	20.00000	5.00000	592.54102
170.00000	20.00000	6.00000	661.80798
160.00000	20.00000	7.00000	596.54602
150.00000	20.00000	8.00000	715.28699
140.00000	30.00000	6.00000	709.80798
215.00000	10.00000	1.00000	787.03400
210.00000	10.00000	2.00000	657.25897
205.00000	10.00000	3.00000	399.19800
200.00000	10.00000	4.00000	412.07800
195.00000	10.00000	5.00000	308.68500
190.00000	10.00000	6.00000	398.93100
185.00000	10.00000	7.00000	382.60300
180.00000	10.00000	8.00000	302.00101

180.00000	20.00000	4.00000	383.04599
170.00000	20.00000	5.00000	561.80103
140.00000	20.00000	8.00000	531.68701
130.00000	30.00000	6.00000	682.30701
205.00000	10.00000	1.00000	1050.84998
200.00000	10.00000	2.00000	674.50800
195.00000	10.00000	3.00000	633.14697
190.00000	10.00000	4.00000	456.06100
185.00000	10.00000	5.00000	495.58899
180.00000	10.00000	6.00000	452.11301
175.00000	10.00000	7.00000	378.05899
170.00000	10.00000	8.00000	425.38501
170.00000	20.00000	4.00000	441.83899
160.00000	20.00000	5.00000	494.39200
150.00000	20.00000	6.00000	478.60999
140.00000	20.00000	7.00000	513.34003
130.00000	20.00000	8.00000	529.86102
120.00000	30.00000	6.00000	749.58899
195.00000	10.00000	1.00000	805.26300
190.00000	10.00000	2.00000	804.25299
185.00000	10.00000	3.00000	536.37799
180.00000	10.00000	4.00000	481.03500
175.00000	10.00000	5.00000	469.38901
170.00000	10.00000	6.00000	357.74600
165.00000	10.00000	7.00000	273.25800
160.00000	10.00000	8.00000	455.06201
160.00000	20.00000	4.00000	515.27698
130.00000	20.00000	7.00000	497.72900
120.00000	20.00000	8.00000	601.54303
185.00000	10.00000	1.00000	1050.92004
180.00000	10.00000	2.00000	767.76300
175.00000	10.00000	3.00000	604.71301
170.00000	10.00000	4.00000	470.46201
165.00000	10.00000	5.00000	359.11801
160.00000	10.00000	6.00000	356.97000
155.00000	10.00000	7.00000	490.25101
150.00000	10.00000	8.00000	372.78601
150.00000	20.00000	4.00000	424.44901
140.00000	20.00000	5.00000	460.08600
130.00000	20.00000	6.00000	497.51999
110.00000	20.00000	8.00000	811.86603
120.00000	20.00000	7.00000	316.75101
175.00000	10.00000	1.00000	881.36298
170.00000	10.00000	2.00000	703.78101
165.00000	10.00000	3.00000	487.64999
160.00000	10.00000	4.00000	346.26501

155.00000	10.00000	5.00000	277.92899
150.00000	10.00000	6.00000	387.39001
145.00000	10.00000	7.00000	406.72198
140.00000	10.00000	8.00000	403.12601
120.00000	20.00000	6.00000	498.10300
110.00000	20.00000	7.00000	574.52197
100.00000	20.00000	8.00000	677.72601
165.00000	10.00000	1.00000	1002.51001
160.00000	10.00000	2.00000	783.41199
155.00000	10.00000	3.00000	530.69598
150.00000	10.00000	4.00000	411.67300
145.00000	10.00000	5.00000	507.98999
140.00000	10.00000	6.00000	514.56299
135.00000	10.00000	7.00000	449.28201
130.00000	20.00000	4.00000	433.01501
120.00000	20.00000	5.00000	473.40399
110.00000	20.00000	6.00000	654.89899
100.00000	20.00000	7.00000	472.65900
155.00000	10.00000	1.00000	866.14099
150.00000	10.00000	2.00000	636.44299
145.00000	10.00000	3.00000	461.64600
140.00000	10.00000	4.00000	470.32199
135.00000	10.00000	5.00000	431.42499
130.00000	10.00000	6.00000	371.82901
110.00000	20.00000	5.00000	444.23499
100.00000	20.00000	6.00000	527.12701
90.00000	20.00000	7.00000	794.12903
145.00000	10.00000	1.00000	970.73602
140.00000	10.00000	2.00000	795.51801
135.00000	10.00000	3.00000	648.45300
130.00000	10.00000	4.00000	491.88501
125.00000	10.00000	5.00000	294.42599
110.00000	10.00000	8.00000	683.16602
110.00000	20.00000	4.00000	631.13202
100.00000	20.00000	5.00000	536.53699
90.00000	20.00000	6.00000	666.88800
135.00000	10.00000	1.00000	1148.60999
130.00000	10.00000	2.00000	959.26398
125.00000	10.00000	3.00000	564.30902
120.00000	10.00000	4.00000	396.04401
100.00000	10.00000	8.00000	557.52698
100.00000	20.00000	4.00000	550.82397
90.00000	20.00000	5.00000	708.40601
80.00000	20.00000	6.00000	643.96100
125.00000	10.00000	1.00000	935.02301
120.00000	10.00000	2.00000	565.61902

115.00000	10.00000	3.00000	387.76999
100.00000	10.00000	6.00000	498.04300
90.00000	10.00000	8.00000	431.45401
90.00000	20.00000	4.00000	416.41400
80.00000	20.00000	5.00000	544.63000
115.00000	10.00000	1.00000	668.45203
110.00000	10.00000	2.00000	418.39899
95.00000	10.00000	5.00000	276.35300
90.00000	10.00000	6.00000	319.63901
85.00000	10.00000	7.00000	314.33401
80.00000	10.00000	8.00000	347.89899
80.00000	20.00000	4.00000	406.32101
70.00000	20.00000	5.00000	530.08502
105.00000	10.00000	1.00000	646.51001
90.00000	10.00000	4.00000	338.57800
85.00000	10.00000	5.00000	342.86499
80.00000	10.00000	6.00000	365.30600
75.00000	10.00000	7.00000	516.79797
70.00000	10.00000	8.00000	434.15500
70.00000	20.00000	4.00000	507.56601
85.00000	10.00000	3.00000	264.82101
80.00000	10.00000	4.00000	275.17801
75.00000	10.00000	5.00000	289.32700
70.00000	10.00000	6.00000	391.76801
65.00000	10.00000	7.00000	478.52301
60.00000	10.00000	8.00000	463.58600
60.00000	20.00000	4.00000	639.99298
80.00000	10.00000	2.00000	232.78000
75.00000	10.00000	3.00000	222.48000
70.00000	10.00000	4.00000	217.71001
65.00000	10.00000	5.00000	305.22501
60.00000	10.00000	6.00000	365.89999
55.00000	10.00000	7.00000	369.91000
50.00000	10.00000	8.00000	517.57703
55.00000	10.00000	1.00000	368.78101
50.00000	10.00000	2.00000	273.32999
45.00000	10.00000	3.00000	255.50700
40.00000	10.00000	4.00000	271.69400
35.00000	10.00000	5.00000	383.87000
45.00000	10.00000	1.00000	307.29501
40.00000	10.00000	2.00000	224.22600
35.00000	10.00000	3.00000	210.16901
30.00000	10.00000	4.00000	310.62299
35.00000	10.00000	1.00000	282.69800
30.00000	10.00000	2.00000	195.93500
25.00000	10.00000	3.00000	243.54800

25.00000	10.00000	1.00000	288.51599
20.00000	10.00000	2.00000	249.13400
15.00000	10.00000	1.00000	242.66400

0
0
0

Sting/Swift prg: COL3

10
3
916
1
0

605	10	1	43.9872
600	10	2	72.6085
595	10	3	80.0424
590	10	4	113.93
585	10	5	82.0984
580	10	6	66.0743
575	10	7	83.2745
570	10	8	96.7108
595	10	1	45.6488
590	10	2	51.9331
585	10	3	74.5153
580	10	4	57.03
575	10	5	46.9494
570	10	6	53.9799
565	10	7	85.2212
560	10	8	95.3335
560	20	4	111.981
550	20	5	116.674
540	20	6	99.2178
530	20	7	138.535
520	20	8	217.771
585	10	1	42.5006
580	10	2	58.814
575	10	3	46.8508
570	10	4	39.8944
565	10	5	55.8695
560	10	6	53.3747
555	10	7	75.2282
550	10	8	95.9034
550	20	4	97.3621
540	20	5	94.3908
530	20	6	90.6348
520	20	7	181.254

510	20	8	211.836
500	30	6	172.972
485	30	7	162.024
470	30	8	216.061
575	10	1	66.5635
570	10	2	52.0369
565	10	3	44.9452
560	10	4	58.0444
555	10	5	70.868
550	10	6	92.4579
545	10	7	117.121
540	10	8	96.441
540	20	4	100.044
530	20	5	89.0906
520	20	6	134.30299
510	20	7	238.573
500	20	8	292.31601
475	30	7	190.186
460	30	8	252.86
490	30	6	82.9656
460	40	6	254.405
440	40	7	285.353
420	40	8	159.48599
565	10	1	44.3085
560	10	2	36.8225
555	10	3	46.8783
550	10	4	57.33
545	10	5	77.6283
540	10	6	97.6255
535	10	7	94.0846
530	10	8	110.387
530	20	4	101.711
520	20	5	97.3056
510	20	6	196.198
500	20	7	247.55499
490	20	8	273.04001
480	30	6	96.2794
465	30	7	245.894
450	30	8	222.791
450	40	6	232.754
430	40	7	267.409
410	40	8	103.089
395	50	7	113.933
370	50	8	140.326
555	10	1	39.9003
550	10	2	43.9698

545	10	3	53.4692
540	10	4	73.3723
535	10	5	94.8442
530	10	6	92.1193
525	10	7	110.394
520	10	8	82.4005
520	20	4	79.8299
510	20	5	129.077
500	20	6	221.257
490	20	7	310.09698
480	20	8	83.8889
470	30	6	181.34
455	30	7	254.80901
440	30	8	287.909
420	40	7	253.117
400	40	8	111.318
440	40	6	201.258
360	50	8	177.19501
385	50	7	132.25999
350	60	7	149.51199
320	60	8	236.55099
545	10	1	24.6565
540	10	2	25.4953
535	10	3	30.991
530	10	4	43.1893
525	10	5	42.5753
520	10	6	48.4385
515	10	7	44.0092
510	10	8	39.8244
510	20	4	65.7367
500	20	5	134.802
490	20	6	174.25101
480	20	7	192.298
470	20	8	60.8673
460	30	6	183.95399
445	30	7	201.349
430	30	8	253.439
430	40	6	277.047
410	40	7	190.12399
390	40	8	103.962
375	50	7	128.78799
350	50	8	172.548
340	60	7	162.933
310	60	8	187.88901
535	10	1	28.4925
530	10	2	25.4533

525	10	3	31.8235
520	10	4	30.0781
515	10	5	37.1701
510	10	6	24.7892
505	10	7	28.6165
500	10	8	35.7144
500	20	4	52.401
490	20	5	91.4653
480	20	6	125.49
460	20	8	73.3188
470	20	7	26.2336
450	30	6	123.4
435	30	7	190.959
420	30	8	211.05
420	40	6	214.81799
400	40	7	124.35
380	40	8	91.5912
365	50	7	124.318
340	50	8	142.48801
330	60	7	156.287
300	60	8	207.91901
525	10	1	32.7988
520	10	2	34.5555
515	10	3	32.9357
510	10	4	39.5436
505	10	5	28.9699
500	10	6	29.4409
495	10	7	40.9137
490	10	8	59.2785
490	20	4	65.5255
480	20	5	80.9117
470	20	6	90.3973
460	20	7	30.2123
450	20	8	82.1096
440	30	6	96.8892
425	30	7	100.363
410	30	8	126.815
410	40	6	164.65401
390	40	7	65.0593
370	40	8	74.8502
355	50	7	112.925
330	50	8	122.053
320	60	7	146.89999
515	10	1	40.1588
510	10	2	31.7077
505	10	3	35.5654

500	10	4	27.2189
495	10	5	27.6621
490	10	6	27.0969
485	10	7	65.9231
480	10	8	70.4577
480	20	4	78.0427
470	20	5	100.453
460	20	6	35.4453
450	20	7	61.6978
440	20	8	56.4299
430	30	6	98.8089
415	30	7	101.354
400	30	8	102.775
400	40	6	103.378
380	40	7	43.6969
360	40	8	57.0414
345	50	7	85.2318
320	50	8	104.793
310	60	7	118.703
505	10	1	40.1437
500	10	2	37.0551
495	10	3	28.299
490	10	4	27.639
485	10	5	41.3618
480	10	6	45.5049
475	10	7	78.0154
470	10	8	68.5843
470	20	4	78.4465
460	20	5	87.6844
450	20	6	29.966
440	20	7	73.8328
430	20	8	93.9146
420	30	6	68.0424
405	30	7	108.476
390	30	8	91.2239
390	40	6	74.9932
370	40	7	44.2226
350	40	8	59.3699
335	50	7	81.0922
310	50	8	92.7122
300	60	7	116.799
495	10	1	45.0134
490	10	2	29.1842
485	10	3	24.6713
480	10	4	31.3139
475	10	5	47.3745

470	10	6	67.864
465	10	7	65.7893
460	10	8	74.682
460	20	4	92.1937
440	20	6	58.6076
430	20	7	105.305
420	20	8	183.60201
450	20	5	44.0662
410	30	6	55.6148
395	30	7	101.895
380	30	8	66.9807
380	40	6	61.671
360	40	7	45.7782
340	40	8	59.4501
325	50	7	81.3906
300	50	8	88.9214
290	60	7	112.913
485	10	1	27.9341
480	10	2	18.5627
475	10	3	22.1197
470	10	4	32.9086
465	10	5	47.1436
460	10	6	48.6544
455	10	7	54.6252
450	10	8	64.2377
450	20	4	67.7661
430	20	6	61.8395
420	20	7	70.6333
410	20	8	71.2205
440	20	5	26.116
400	30	6	48.2271
385	30	7	79.5749
370	30	8	35.1937
370	40	6	39.583
350	40	7	46.0592
330	40	8	62.4352
315	50	7	60.1294
290	50	8	74.5405
280	60	7	96.2757
475	10	1	39.5432
470	10	2	33.6426
465	10	3	38.1568
460	10	4	50.59
455	10	5	49.5587
450	10	6	54.8229
445	10	7	69.2654

440	10	8	36.898
440	20	4	30.9309
430	20	5	46.1361
420	20	6	51.667
410	20	7	42.7337
400	20	8	79.4368
390	30	6	79.1733
375	30	7	62.5625
360	30	8	29.3735
360	40	6	34.1407
340	40	7	45.3847
320	40	8	61.7945
305	50	7	54.8042
280	50	8	74.9795
270	60	7	95.1767
465	10	1	42.9366
460	10	2	39.4597
455	10	3	45.4655
450	10	4	40.7179
445	10	5	42.2922
440	10	6	55.7145
435	10	7	38.6868
430	10	8	11.9447
420	20	5	43.2894
430	20	4	25.7402
410	20	6	48.4096
400	20	7	49.0365
390	20	8	52.4733
380	30	6	59.2322
365	30	7	39.081
350	30	8	23.9474
350	40	6	26.392
330	40	7	35.9546
310	40	8	51.1261
295	50	7	52.7734
270	50	8	67.4483
455	10	1	50.4773
450	10	2	54.6503
445	10	3	47.354
440	10	4	47.5363
435	10	5	54.3409
430	10	6	39.559
425	10	7	20.4793
420	10	8	32.3247
420	20	4	35.1856
410	20	5	40.578

400	20	6	56.6019
390	20	7	15.3559
380	20	8	40.7719
370	30	6	50.2872
355	30	7	21.9183
340	30	8	24.2542
320	40	7	34.9078
340	40	6	26.7445
300	40	8	48.0006
285	50	7	53.7618
260	50	8	70.6304
445	10	1	63.0171
440	10	2	54.7551
435	10	3	52.0115
430	10	4	61.5125
425	10	5	45.1964
420	10	6	23.6698
415	10	7	39.9559
410	10	8	45.8648
410	20	4	46.2526
400	20	5	45.3209
390	20	6	46.8018
380	20	7	46.3988
370	20	8	57.4851
360	30	6	37.6791
345	30	7	17.8176
330	30	8	18.8454
330	40	6	25.4009
310	40	7	36.0473
290	40	8	39.5441
275	50	7	48.1612
250	50	8	68.8906
435	10	1	70.8571
430	10	2	68.0153
425	10	3	76.7057
420	10	4	61.3728
415	10	5	34.6259
410	10	6	55.4063
405	10	7	63.6845
400	10	8	69.4957
400	20	4	59.2018
390	20	5	64.2569
380	20	6	45.3486
370	20	7	64.5909
360	20	8	63.8041
350	30	6	41.84

335	30	7	24.8136
320	30	8	32.6296
300	40	7	36.9369
280	40	8	38.4648
320	40	6	30.8307
265	50	7	44.0994
425	10	1	69.9439
420	10	2	81.3244
415	10	3	67.508
410	10	4	40.8306
405	10	5	62.7694
400	10	6	73.3303
395	10	7	82.6346
390	10	8	72.2082
390	20	4	73.0997
380	20	5	69.1045
370	20	6	67.2073
360	20	7	83.701
350	20	8	75.9665
340	30	6	31.0689
325	30	7	30.6895
310	30	8	38.7075
310	40	6	35.1925
290	40	7	41.6153
270	40	8	49.6572
255	50	7	62.4429
415	10	1	55.0678
410	10	2	46.528
405	10	3	29.6296
400	10	4	46.257
395	10	5	53.523
390	10	6	58.2738
385	10	7	53.5648
380	10	8	60.4823
380	20	4	70.3806
370	20	5	58.9952
360	20	6	75.1564
350	20	7	74.498
340	20	8	61.3101
330	30	6	29.4399
315	30	7	33.6156
300	30	8	43.1805
300	40	6	38.065
280	40	7	42.4766
260	40	8	43.5415
245	50	7	62.4424

405	10	1	44.174
400	10	2	26.6012
395	10	3	36.4596
390	10	4	42.4948
385	10	5	47.0544
380	10	6	40.5419
375	10	7	46.1923
370	10	8	43.8641
370	20	4	46.2224
360	20	5	43.1478
350	20	6	51.761
340	20	7	45.8056
330	20	8	21.6991
320	30	6	22.3994
305	30	7	25.474
290	30	8	28.8523
290	40	6	33.4361
270	40	7	33.4061
250	40	8	37.1316
235	50	7	47.957
395	10	1	26.3111
390	10	2	30.7068
385	10	3	32.9331
380	10	4	33.9697
375	10	5	27.978
370	10	6	27.287
365	10	7	23.9947
360	10	8	15.9451
360	20	4	21.4504
350	20	5	20.8577
340	20	6	12.9489
330	20	7	9.19492
310	30	6	7.22835
295	30	7	5.20735
280	30	8	2.5337
280	40	6	9.06629
225	50	7	12.825
385	10	1	44.0682
380	10	2	51.9423
375	10	3	59.4563
370	10	4	57.4659
365	10	5	69.052
360	10	6	69.8983
355	10	7	71.28
350	10	8	70.8995
350	20	4	49.3603

340	20	5	60.2938
330	20	6	55.9559
320	20	7	27.4365
310	20	8	22.6946
300	30	6	21.9439
285	30	7	24.7843
270	30	8	25.9375
270	40	6	27.5407
250	40	7	27.4117
230	40	8	27.7384
375	10	1	34.8076
370	10	2	40.3507
365	10	3	39.3087
360	10	4	48.7847
355	10	5	54.3866
350	10	6	49.1113
345	10	7	54.1306
340	10	8	71.2827
340	20	4	84.3272
330	20	5	94.3451
320	20	6	86.0208
310	20	7	46.1509
300	20	8	54.1473
290	30	6	45.8303
275	30	7	58.4559
260	30	8	65.3941
260	40	6	56.9743
240	40	7	62.4107
220	40	8	85.8165
365	10	1	41.5174
360	10	2	37.5431
355	10	3	42.9231
350	10	4	46.1642
345	10	5	42.2299
340	10	6	44.3149
335	10	7	57.1784
330	10	8	67.2421
330	20	4	77.0191
320	20	5	81.8507
310	20	6	42.5772
300	20	7	40.3811
290	20	8	48.1356
280	30	6	70.0436
265	30	7	93.2183
250	30	8	106.06
250	40	6	66.7979

230	40	7	82.5884
210	40	8	106.928
355	10	1	48.8565
350	10	2	45.7078
345	10	3	46.4745
340	10	4	36.9497
335	10	5	39.3025
330	10	6	51.3536
325	10	7	60.4182
320	10	8	65.3353
320	20	4	64.1383
310	20	5	60.1442
300	20	6	31.4236
290	20	7	35.5365
280	20	8	42.3827
270	30	6	64.5436
255	30	7	78.2125
240	30	8	90.8575
240	40	6	94.243
220	40	7	132.672
200	40	8	166.612
345	10	1	66.7613
340	10	2	58.5728
335	10	3	41.0071
330	10	4	40.2025
325	10	5	50.4969
320	10	6	58.0312
315	10	7	63.5895
310	10	8	57.0842
310	20	4	64.6843
300	20	5	35.0328
290	20	6	32.4985
280	20	7	37.2458
270	20	8	48.065
260	30	6	57.7874
245	30	7	67.2028
230	30	8	69.4006
230	40	6	93.1928
210	40	7	110.285
335	10	1	81.425
330	10	2	47.8654
325	10	3	40.0386
320	10	4	45.552
315	10	5	50.5255
310	10	6	54.9349
305	10	7	49.9783

300	10	8	66.0297
300	20	4	55.4096
290	20	5	29.5552
280	20	6	33.985
270	20	7	38.9228
260	20	8	48.8491
250	30	6	57.0279
235	30	7	62.4947
220	30	8	66.5427
220	40	6	70.2076
200	40	7	97.9338
325	10	1	62.0292
320	10	2	50.5452
315	10	3	50.429
310	10	4	50.7261
305	10	5	54.436
300	10	6	49.912
295	10	7	67.069
290	10	8	34.7422
290	20	4	32.4466
280	20	5	29.7388
270	20	6	34.6248
260	20	7	43.9599
250	20	8	48.0827
240	30	6	55.1717
225	30	7	61.1739
210	30	8	68.8579
210	40	6	74.7608
190	40	7	96.9451
315	10	1	66.8547
310	10	2	61.1296
305	10	3	52.8611
300	10	4	51.2587
295	10	5	45.9113
290	10	6	61.6331
285	10	7	32.6927
280	10	8	28.1495
280	20	4	28.0672
270	20	5	31.941
260	20	6	36.304
250	20	7	45.4933
240	20	8	53.2185
230	30	6	55.7487
215	30	7	56.0015
200	30	8	80.7434
200	40	6	84.5244

180	40	7	104.014
305	10	1	69.1341
300	10	2	54.9581
295	10	3	44.6592
290	10	4	38.8382
285	10	5	50.5572
280	10	6	28.8107
275	10	7	24.4137
270	10	8	21.9217
270	20	4	26.6917
260	20	5	30.2364
250	20	6	37.1863
240	20	7	45.2106
230	20	8	51.8029
220	30	6	57.0249
190	30	8	52.3778
205	30	7	62.7997
190	40	6	67.7684
295	10	1	86.0345
290	10	2	52.2432
285	10	3	37.5484
280	10	4	48.5718
275	10	5	27.2847
270	10	6	23.0187
265	10	7	17.8868
260	10	8	26.9482
260	20	4	24.5531
250	20	5	34.1813
240	20	6	34.7235
230	20	7	45.5014
220	20	8	30.6136
210	30	6	55.5948
195	30	7	59.3112
180	30	8	62.7718
180	40	6	79.9033
285	10	1	68.2724
280	10	2	45.7286
275	10	3	54.3096
270	10	4	27.7926
265	10	5	24.6523
260	10	6	25.5042
255	10	7	22.5286
250	10	8	36.8381
250	20	4	27.7224
240	20	5	35.3571
230	20	6	37.9624

220	20	7	47.067
210	20	8	46.7758
200	30	6	47.1161
185	30	7	56.7531
170	30	8	89.0305
170	40	6	83.975
275	10	1	65.2537
270	10	2	69.8743
265	10	3	33.3461
260	10	4	29.9724
255	10	5	23.9234
250	10	6	27.3515
245	10	7	29.4319
240	10	8	31.4726
240	20	4	29.2449
230	20	5	40.929
220	20	6	41.9093
210	20	7	59.3106
200	20	8	48.0749
190	30	6	53.346
175	30	7	64.3033
160	30	8	64.7719
160	40	6	90.2514
265	10	1	74.0148
260	10	2	36.7796
255	10	3	28.8339
250	10	4	23.6796
245	10	5	26.0797
240	10	6	26.5284
235	10	7	27.4918
230	10	8	30.6432
230	20	4	36.308
220	20	5	39.0772
210	20	6	48.7079
200	20	7	47.2291
190	20	8	51.4339
180	30	6	56.4533
165	30	7	76.5497
150	30	8	81.9664
255	10	1	29.3757
250	10	2	24.6688
245	10	3	19.8835
240	10	4	19.1217
235	10	5	20.1105
230	10	6	21.2167
225	10	7	23.8373

220	10	8	27.8458
220	20	4	31.5449
210	20	5	38.1268
200	20	6	35.8873
190	20	7	44.8815
180	20	8	33.9075
170	30	6	63.7111
155	30	7	65.0906
245	10	1	39.0953
240	10	2	28.5437
235	10	3	25.3713
230	10	4	21.504
225	10	5	26.7553
220	10	6	25.2087
215	10	7	31.5631
210	10	8	27.907
210	20	4	29.3642
200	20	5	36.0292
190	20	6	34.3402
180	20	7	36.505
170	20	8	45.7443
160	30	6	50.3975
145	30	7	71.4115
235	10	1	55.61
230	10	2	40.947
225	10	3	30.8214
220	10	4	22.1611
215	10	5	20.6533
210	10	6	21.802
205	10	7	17.5648
200	10	8	20.051
200	20	4	27.4202
190	20	5	25.5323
180	20	6	30.7118
170	20	7	24.2977
160	20	8	37.9342
150	30	6	44.1215
135	30	7	57.9174
225	10	1	73.2595
220	10	2	60.7046
215	10	3	43.8939
210	10	4	36.5754
205	10	5	35.2203
200	10	6	27.7346
195	10	7	29.2012
190	10	8	30.3794

190	20	4	25.8865
180	20	5	21.4291
170	20	6	23.3512
160	20	7	24.5934
150	20	8	21.8058
140	30	6	42.7253
215	10	1	68.8894
210	10	2	59.0147
205	10	3	50.2393
200	10	4	45.8704
195	10	5	34.0319
190	10	6	35.4861
185	10	7	37.2769
180	10	8	34.4727
180	20	4	28.4476
170	20	5	30.4476
160	20	6	20.2098
150	20	7	31.6134
140	20	8	33.5484
130	30	6	29.9027
205	10	1	65.0194
200	10	2	65.6656
195	10	3	60.7436
190	10	4	43.1303
185	10	5	43.1753
180	10	6	42.8684
175	10	7	43.7986
170	10	8	34.6903
170	20	4	33.7311
160	20	5	34.9502
150	20	6	37.0729
140	20	7	29.4623
130	20	8	42.2719
120	30	6	41.3605
195	10	1	61.4499
190	10	2	66.615
185	10	3	46.6546
180	10	4	43.5466
175	10	5	46.2833
170	10	6	41.6861
165	10	7	23.7808
160	10	8	40.9162
160	20	4	42.871
150	20	5	28.6708
140	20	6	43.4234
130	20	7	37.3709

120	20	8	52.0204
185	10	1	64.132
180	10	2	51.8847
175	10	3	48.7394
170	10	4	45.4093
165	10	5	41.4469
160	10	6	36.1478
155	10	7	35.0613
150	10	8	39.6123
150	20	4	36.8955
140	20	5	40.1982
130	20	6	31.4513
120	20	7	46.6024
110	20	8	48.7613
175	10	1	59.4186
170	10	2	57.0048
165	10	3	51.7654
160	10	4	44.1803
155	10	5	33.4085
150	10	6	39.4115
145	10	7	46.3011
140	10	8	33.4701
140	20	4	25.6183
130	20	5	47.8602
120	20	6	37.4339
110	20	7	64.1868
100	20	8	55.6608
165	10	1	75.3147
160	10	2	72.4764
155	10	3	55.2851
150	10	4	40.7976
145	10	5	46.7774
140	10	6	52.764
135	10	7	33.7479
130	10	8	39.3152
130	20	4	42.5825
120	20	5	37.1969
110	20	6	61.1879
100	20	7	64.0864
155	10	1	65.6161
150	10	2	48.698
145	10	3	33.9686
140	10	4	37.4984
135	10	5	42.2999
130	10	6	28.4076
125	10	7	25.5459

120	10	8	53.2041
120	20	4	45.0176
110	20	5	52.1331
100	20	6	41.3608
90	20	7	71.9406
145	10	1	60.0538
140	10	2	39.9524
135	10	3	38.7675
130	10	4	42.7811
125	10	5	27.5334
120	10	6	28.8281
115	10	7	52.0833
110	10	8	31.0171
110	20	4	35.047
100	20	5	47.8786
90	20	6	53.3173
135	10	1	60.4692
130	10	2	46.9724
125	10	3	41.0856
120	10	4	26.1035
115	10	5	29.7042
110	10	6	53.49
105	10	7	18.7124
100	10	8	45.3711
100	20	4	35.7798
90	20	5	75.2302
80	20	6	35.8926
125	10	1	62.4376
120	10	2	44.7868
115	10	3	32.2654
110	10	4	16.4925
105	10	5	41.1795
100	10	6	29.8672
95	10	7	27.6001
90	10	8	77.0023
90	20	4	48.1894
80	20	5	52.86
115	10	1	41.5177
110	10	2	25.8787
105	10	3	14.2566
100	10	4	41.0014
95	10	5	13.3379
90	10	6	24.7998
85	10	7	26.3567
80	10	8	15.4578
80	20	4	40.286

70	20	5	20.2888
105	10	1	43.0869
100	10	2	19.8452
95	10	3	32.2196
90	10	4	19.8558
85	10	5	24.1086
80	10	6	41.9785
75	10	7	23.9194
70	10	8	51.4077
70	20	4	53.6662
95	10	1	25.0487
90	10	2	36.6104
85	10	3	19.2577
80	10	4	28.4323
75	10	5	33.3019
70	10	6	72.8706
65	10	7	17.8425
60	10	8	43.6575
60	20	4	67.8766
85	10	1	20.494
80	10	2	11.3984
75	10	3	15.8006
70	10	4	26.8109
65	10	5	24.0384
60	10	6	38.8705
55	10	7	14.825
50	10	8	37.5712
75	10	1	12.9251
70	10	2	11.633
65	10	3	22.0619
60	10	4	23.3774
55	10	5	30.5932
50	10	6	20.8607
45	10	7	32.4186
65	10	1	19.8561
60	10	2	29.3475
55	10	3	43.4407
50	10	4	51.1317
45	10	5	35.2566
40	10	6	56.2613
55	10	1	10.8801
50	10	2	17.5472
45	10	3	20.1186
40	10	4	17.0728
35	10	5	24.6447
45	10	1	12.2139

40	10	2	19.367
35	10	3	13.5015
30	10	4	24.0576
35	10	1	17.241
30	10	2	14.8265
25	10	3	24.898
25	10	1	12.9546
20	10	2	21.4724
15	10	1	18.2149
0			
0			
0			

Sting/Swift prg: COL3

10			
3			
916			
1			
0			
605	10	1	43.9872
600	10	2	72.6085
595	10	3	80.0424
590	10	4	113.93
585	10	5	82.0984
580	10	6	66.0743
575	10	7	83.2745
570	10	8	96.7108
595	10	1	45.6488
590	10	2	51.9331
585	10	3	74.5153
580	10	4	57.03
575	10	5	46.9494
570	10	6	53.9799
565	10	7	85.2212
560	10	8	95.3335
560	20	4	111.981
550	20	5	116.674
540	20	6	99.2178
530	20	7	138.535
520	20	8	217.771
585	10	1	42.5006
580	10	2	58.814
575	10	3	46.8508
570	10	4	39.8944
565	10	5	55.8695
560	10	6	53.3747

555	10	7	75.2282
550	10	8	95.9034
550	20	4	97.3621
540	20	5	94.3908
530	20	6	90.6348
520	20	7	181.254
510	20	8	211.836
500	30	6	172.972
485	30	7	162.024
470	30	8	216.061
575	10	1	66.5635
570	10	2	52.0369
565	10	3	44.9452
560	10	4	58.0444
555	10	5	70.868
550	10	6	92.4579
545	10	7	117.121
540	10	8	96.441
540	20	4	100.044
530	20	5	89.0906
520	20	6	134.30299
510	20	7	238.573
500	20	8	292.31601
475	30	7	190.186
460	30	8	252.86
490	30	6	82.9656
460	40	6	254.405
440	40	7	285.353
420	40	8	159.48599
565	10	1	44.3085
560	10	2	36.8225
555	10	3	46.8783
550	10	4	57.33
545	10	5	77.6283
540	10	6	97.6255
535	10	7	94.0846
530	10	8	110.387
530	20	4	101.711
520	20	5	97.3056
510	20	6	196.198
500	20	7	247.55499
490	20	8	273.04001
480	30	6	96.2794
465	30	7	245.894
450	30	8	222.791
450	40	6	232.754

430	40	7	267.409
410	40	8	103.089
395	50	7	113.933
370	50	8	140.326
555	10	1	39.9003
550	10	2	43.9698
545	10	3	53.4692
540	10	4	73.3723
535	10	5	94.8442
530	10	6	92.1193
525	10	7	110.394
520	10	8	82.4005
520	20	4	79.8299
510	20	5	129.077
500	20	6	221.257
490	20	7	310.09698
480	20	8	83.8889
470	30	6	181.34
455	30	7	254.80901
440	30	8	287.909
420	40	7	253.117
400	40	8	111.318
440	40	6	201.258
360	50	8	177.19501
385	50	7	132.25999
350	60	7	149.51199
320	60	8	236.55099
545	10	1	24.6565
540	10	2	25.4953
535	10	3	30.991
530	10	4	43.1893
525	10	5	42.5753
520	10	6	48.4385
515	10	7	44.0092
510	10	8	39.8244
510	20	4	65.7367
500	20	5	134.802
490	20	6	174.25101
480	20	7	192.298
470	20	8	60.8673
460	30	6	183.95399
445	30	7	201.349
430	30	8	253.439
430	40	6	277.047
410	40	7	190.12399
390	40	8	103.962

375	50	7	128.78799
350	50	8	172.548
340	60	7	162.933
310	60	8	187.88901
535	10	1	28.4925
530	10	2	25.4533
525	10	3	31.8235
520	10	4	30.0781
515	10	5	37.1701
510	10	6	24.7892
505	10	7	28.6165
500	10	8	35.7144
500	20	4	52.401
490	20	5	91.4653
480	20	6	125.49
460	20	8	73.3188
470	20	7	26.2336
450	30	6	123.4
435	30	7	190.959
420	30	8	211.05
420	40	6	214.81799
400	40	7	124.35
380	40	8	91.5912
365	50	7	124.318
340	50	8	142.48801
330	60	7	156.287
300	60	8	207.91901
525	10	1	32.7988
520	10	2	34.5555
515	10	3	32.9357
510	10	4	39.5436
505	10	5	28.9699
500	10	6	29.4409
495	10	7	40.9137
490	10	8	59.2785
490	20	4	65.5255
480	20	5	80.9117
470	20	6	90.3973
460	20	7	30.2123
450	20	8	82.1096
440	30	6	96.8892
425	30	7	100.363
410	30	8	126.815
410	40	6	164.65401
390	40	7	65.0593
370	40	8	74.8502

355	50	7	112.925
330	50	8	122.053
320	60	7	146.89999
515	10	1	40.1588
510	10	2	31.7077
505	10	3	35.5654
500	10	4	27.2189
495	10	5	27.6621
490	10	6	27.0969
485	10	7	65.9231
480	10	8	70.4577
480	20	4	78.0427
470	20	5	100.453
460	20	6	35.4453
450	20	7	61.6978
440	20	8	56.4299
430	30	6	98.8089
415	30	7	101.354
400	30	8	102.775
400	40	6	103.378
380	40	7	43.6969
360	40	8	57.0414
345	50	7	85.2318
320	50	8	104.793
310	60	7	118.703
505	10	1	40.1437
500	10	2	37.0551
495	10	3	28.299
490	10	4	27.639
485	10	5	41.3618
480	10	6	45.5049
475	10	7	78.0154
470	10	8	68.5843
470	20	4	78.4465
460	20	5	87.6844
450	20	6	29.966
440	20	7	73.8328
430	20	8	93.9146
420	30	6	68.0424
405	30	7	108.476
390	30	8	91.2239
390	40	6	74.9932
370	40	7	44.2226
350	40	8	59.3699
335	50	7	81.0922
310	50	8	92.7122

300	60	7	116.799
495	10	1	45.0134
490	10	2	29.1842
485	10	3	24.6713
480	10	4	31.3139
475	10	5	47.3745
470	10	6	67.864
465	10	7	65.7893
460	10	8	74.682
460	20	4	92.1937
440	20	6	58.6076
430	20	7	105.305
420	20	8	183.60201
450	20	5	44.0662
410	30	6	55.6148
395	30	7	101.895
380	30	8	66.9807
380	40	6	61.671
360	40	7	45.7782
340	40	8	59.4501
325	50	7	81.3906
300	50	8	88.9214
290	60	7	112.913
485	10	1	27.9341
480	10	2	18.5627
475	10	3	22.1197
470	10	4	32.9086
465	10	5	47.1436
460	10	6	48.6544
455	10	7	54.6252
450	10	8	64.2377
450	20	4	67.7661
430	20	6	61.8395
420	20	7	70.6333
410	20	8	71.2205
440	20	5	26.116
400	30	6	48.2271
385	30	7	79.5749
370	30	8	35.1937
370	40	6	39.583
350	40	7	46.0592
330	40	8	62.4352
315	50	7	60.1294
290	50	8	74.5405
280	60	7	96.2757
475	10	1	39.5432

470	10	2	33.6426
465	10	3	38.1568
460	10	4	50.59
455	10	5	49.5587
450	10	6	54.8229
445	10	7	69.2654
440	10	8	36.898
440	20	4	30.9309
430	20	5	46.1361
420	20	6	51.667
410	20	7	42.7337
400	20	8	79.4368
390	30	6	79.1733
375	30	7	62.5625
360	30	8	29.3735
360	40	6	34.1407
340	40	7	45.3847
320	40	8	61.7945
305	50	7	54.8042
280	50	8	74.9795
270	60	7	95.1767
465	10	1	42.9366
460	10	2	39.4597
455	10	3	45.4655
450	10	4	40.7179
445	10	5	42.2922
440	10	6	55.7145
435	10	7	38.6868
430	10	8	11.9447
420	20	5	43.2894
430	20	4	25.7402
410	20	6	48.4096
400	20	7	49.0365
390	20	8	52.4733
380	30	6	59.2322
365	30	7	39.081
350	30	8	23.9474
350	40	6	26.392
330	40	7	35.9546
310	40	8	51.1261
295	50	7	52.7734
270	50	8	67.4483
455	10	1	50.4773
450	10	2	54.6503
445	10	3	47.354
440	10	4	47.5363

435	10	5	54.3409
430	10	6	39.559
425	10	7	20.4793
420	10	8	32.3247
420	20	4	35.1856
410	20	5	40.578
400	20	6	56.6019
390	20	7	15.3559
380	20	8	40.7719
370	30	6	50.2872
355	30	7	21.9183
340	30	8	24.2542
320	40	7	34.9078
340	40	6	26.7445
300	40	8	48.0006
285	50	7	53.7618
260	50	8	70.6304
445	10	1	63.0171
440	10	2	54.7551
435	10	3	52.0115
430	10	4	61.5125
425	10	5	45.1964
420	10	6	23.6698
415	10	7	39.9559
410	10	8	45.8648
410	20	4	46.2526
400	20	5	45.3209
390	20	6	46.8018
380	20	7	46.3988
370	20	8	57.4851
360	30	6	37.6791
345	30	7	17.8176
330	30	8	18.8454
330	40	6	25.4009
310	40	7	36.0473
290	40	8	39.5441
275	50	7	48.1612
250	50	8	68.8906
435	10	1	70.8571
430	10	2	68.0153
425	10	3	76.7057
420	10	4	61.3728
415	10	5	34.6259
410	10	6	55.4063
405	10	7	63.6845
400	10	8	69.4957

400	20	4	59.2018
390	20	5	64.2569
380	20	6	45.3486
370	20	7	64.5909
360	20	8	63.8041
350	30	6	41.84
335	30	7	24.8136
320	30	8	32.6296
300	40	7	36.9369
280	40	8	38.4648
320	40	6	30.8307
265	50	7	44.0994
425	10	1	69.9439
420	10	2	81.3244
415	10	3	67.508
410	10	4	40.8306
405	10	5	62.7694
400	10	6	73.3303
395	10	7	82.6346
390	10	8	72.2082
390	20	4	73.0997
380	20	5	69.1045
370	20	6	67.2073
360	20	7	83.701
350	20	8	75.9665
340	30	6	31.0689
325	30	7	30.6895
310	30	8	38.7075
310	40	6	35.1925
290	40	7	41.6153
270	40	8	49.6572
255	50	7	62.4429
415	10	1	55.0678
410	10	2	46.528
405	10	3	29.6296
400	10	4	46.257
395	10	5	53.523
390	10	6	58.2738
385	10	7	53.5648
380	10	8	60.4823
380	20	4	70.3806
370	20	5	58.9952
360	20	6	75.1564
350	20	7	74.498
340	20	8	61.3101
330	30	6	29.4399

315	30	7	33.6156
300	30	8	43.1805
300	40	6	38.065
280	40	7	42.4766
260	40	8	43.5415
245	50	7	62.4424
405	10	1	44.174
400	10	2	26.6012
395	10	3	36.4596
390	10	4	42.4948
385	10	5	47.0544
380	10	6	40.5419
375	10	7	46.1923
370	10	8	43.8641
370	20	4	46.2224
360	20	5	43.1478
350	20	6	51.761
340	20	7	45.8056
330	20	8	21.6991
320	30	6	22.3994
305	30	7	25.474
290	30	8	28.8523
290	40	6	33.4361
270	40	7	33.4061
250	40	8	37.1316
235	50	7	47.957
395	10	1	26.3111
390	10	2	30.7068
385	10	3	32.9331
380	10	4	33.9697
375	10	5	27.978
370	10	6	27.287
365	10	7	23.9947
360	10	8	15.9451
360	20	4	21.4504
350	20	5	20.8577
340	20	6	12.9489
330	20	7	9.19492
310	30	6	7.22835
295	30	7	5.20735
280	30	8	2.5337
280	40	6	9.06629
225	50	7	12.825
385	10	1	44.0682
380	10	2	51.9423
375	10	3	59.4563

370	10	4	57.4659
365	10	5	69.052
360	10	6	69.8983
355	10	7	71.28
350	10	8	70.8995
350	20	4	49.3603
340	20	5	60.2938
330	20	6	55.9559
320	20	7	27.4365
310	20	8	22.6946
300	30	6	21.9439
285	30	7	24.7843
270	30	8	25.9375
270	40	6	27.5407
250	40	7	27.4117
230	40	8	27.7384
375	10	1	34.8076
370	10	2	40.3507
365	10	3	39.3087
360	10	4	48.7847
355	10	5	54.3866
350	10	6	49.1113
345	10	7	54.1306
340	10	8	71.2827
340	20	4	84.3272
330	20	5	94.3451
320	20	6	86.0208
310	20	7	46.1509
300	20	8	54.1473
290	30	6	45.8303
275	30	7	58.4559
260	30	8	65.3941
260	40	6	56.9743
240	40	7	62.4107
220	40	8	85.8165
365	10	1	41.5174
360	10	2	37.5431
355	10	3	42.9231
350	10	4	46.1642
345	10	5	42.2299
340	10	6	44.3149
335	10	7	57.1784
330	10	8	67.2421
330	20	4	77.0191
320	20	5	81.8507
310	20	6	42.5772

300	20	7	40.3811
290	20	8	48.1356
280	30	6	70.0436
265	30	7	93.2183
250	30	8	106.06
250	40	6	66.7979
230	40	7	82.5884
210	40	8	106.928
355	10	1	48.8565
350	10	2	45.7078
345	10	3	46.4745
340	10	4	36.9497
335	10	5	39.3025
330	10	6	51.3536
325	10	7	60.4182
320	10	8	65.3353
320	20	4	64.1383
310	20	5	60.1442
300	20	6	31.4236
290	20	7	35.5365
280	20	8	42.3827
270	30	6	64.5436
255	30	7	78.2125
240	30	8	90.8575
240	40	6	94.243
220	40	7	132.672
200	40	8	166.612
345	10	1	66.7613
340	10	2	58.5728
335	10	3	41.0071
330	10	4	40.2025
325	10	5	50.4969
320	10	6	58.0312
315	10	7	63.5895
310	10	8	57.0842
310	20	4	64.6843
300	20	5	35.0328
290	20	6	32.4985
280	20	7	37.2458
270	20	8	48.065
260	30	6	57.7874
245	30	7	67.2028
230	30	8	69.4006
230	40	6	93.1928
210	40	7	110.285
335	10	1	81.425

330	10	2	47.8654
325	10	3	40.0386
320	10	4	45.552
315	10	5	50.5255
310	10	6	54.9349
305	10	7	49.9783
300	10	8	66.0297
300	20	4	55.4096
290	20	5	29.5552
280	20	6	33.985
270	20	7	38.9228
260	20	8	48.8491
250	30	6	57.0279
235	30	7	62.4947
220	30	8	66.5427
220	40	6	70.2076
200	40	7	97.9338
325	10	1	62.0292
320	10	2	50.5452
315	10	3	50.429
310	10	4	50.7261
305	10	5	54.436
300	10	6	49.912
295	10	7	67.069
290	10	8	34.7422
290	20	4	32.4466
280	20	5	29.7388
270	20	6	34.6248
260	20	7	43.9599
250	20	8	48.0827
240	30	6	55.1717
225	30	7	61.1739
210	30	8	68.8579
210	40	6	74.7608
190	40	7	96.9451
315	10	1	66.8547
310	10	2	61.1296
305	10	3	52.8611
300	10	4	51.2587
295	10	5	45.9113
290	10	6	61.6331
285	10	7	32.6927
280	10	8	28.1495
280	20	4	28.0672
270	20	5	31.941
260	20	6	36.304

250	20	7	45.4933
240	20	8	53.2185
230	30	6	55.7487
215	30	7	56.0015
200	30	8	80.7434
200	40	6	84.5244
180	40	7	104.014
305	10	1	69.1341
300	10	2	54.9581
295	10	3	44.6592
290	10	4	38.8382
285	10	5	50.5572
280	10	6	28.8107
275	10	7	24.4137
270	10	8	21.9217
270	20	4	26.6917
260	20	5	30.2364
250	20	6	37.1863
240	20	7	45.2106
230	20	8	51.8029
220	30	6	57.0249
190	30	8	52.3778
205	30	7	62.7997
190	40	6	67.7684
295	10	1	86.0345
290	10	2	52.2432
285	10	3	37.5484
280	10	4	48.5718
275	10	5	27.2847
270	10	6	23.0187
265	10	7	17.8868
260	10	8	26.9482
260	20	4	24.5531
250	20	5	34.1813
240	20	6	34.7235
230	20	7	45.5014
220	20	8	30.6136
210	30	6	55.5948
195	30	7	59.3112
180	30	8	62.7718
180	40	6	79.9033
285	10	1	68.2724
280	10	2	45.7286
275	10	3	54.3096
270	10	4	27.7926
265	10	5	24.6523

260	10	6	25.5042
255	10	7	22.5286
250	10	8	36.8381
250	20	4	27.7224
240	20	5	35.3571
230	20	6	37.9624
220	20	7	47.067
210	20	8	46.7758
200	30	6	47.1161
185	30	7	56.7531
170	30	8	89.0305
170	40	6	83.975
275	10	1	65.2537
270	10	2	69.8743
265	10	3	33.3461
260	10	4	29.9724
255	10	5	23.9234
250	10	6	27.3515
245	10	7	29.4319
240	10	8	31.4726
240	20	4	29.2449
230	20	5	40.929
220	20	6	41.9093
210	20	7	59.3106
200	20	8	48.0749
190	30	6	53.346
175	30	7	64.3033
160	30	8	64.7719
160	40	6	90.2514
265	10	1	74.0148
260	10	2	36.7796
255	10	3	28.8339
250	10	4	23.6796
245	10	5	26.0797
240	10	6	26.5284
235	10	7	27.4918
230	10	8	30.6432
230	20	4	36.308
220	20	5	39.0772
210	20	6	48.7079
200	20	7	47.2291
190	20	8	51.4339
180	30	6	56.4533
165	30	7	76.5497
150	30	8	81.9664
255	10	1	29.3757

250	10	2	24.6688
245	10	3	19.8835
240	10	4	19.1217
235	10	5	20.1105
230	10	6	21.2167
225	10	7	23.8373
220	10	8	27.8458
220	20	4	31.5449
210	20	5	38.1268
200	20	6	35.8873
190	20	7	44.8815
180	20	8	33.9075
170	30	6	63.7111
155	30	7	65.0906
245	10	1	39.0953
240	10	2	28.5437
235	10	3	25.3713
230	10	4	21.504
225	10	5	26.7553
220	10	6	25.2087
215	10	7	31.5631
210	10	8	27.907
210	20	4	29.3642
200	20	5	36.0292
190	20	6	34.3402
180	20	7	36.505
170	20	8	45.7443
160	30	6	50.3975
145	30	7	71.4115
235	10	1	55.61
230	10	2	40.947
225	10	3	30.8214
220	10	4	22.1611
215	10	5	20.6533
210	10	6	21.802
205	10	7	17.5648
200	10	8	20.051
200	20	4	27.4202
190	20	5	25.5323
180	20	6	30.7118
170	20	7	24.2977
160	20	8	37.9342
150	30	6	44.1215
135	30	7	57.9174
225	10	1	73.2595
220	10	2	60.7046

215	10	3	43.8939
210	10	4	36.5754
205	10	5	35.2203
200	10	6	27.7346
195	10	7	29.2012
190	10	8	30.3794
190	20	4	25.8865
180	20	5	21.4291
170	20	6	23.3512
160	20	7	24.5934
150	20	8	21.8058
140	30	6	42.7253
215	10	1	68.8894
210	10	2	59.0147
205	10	3	50.2393
200	10	4	45.8704
195	10	5	34.0319
190	10	6	35.4861
185	10	7	37.2769
180	10	8	34.4727
180	20	4	28.4476
170	20	5	30.4476
160	20	6	20.2098
150	20	7	31.6134
140	20	8	33.5484
130	30	6	29.9027
205	10	1	65.0194
200	10	2	65.6656
195	10	3	60.7436
190	10	4	43.1303
185	10	5	43.1753
180	10	6	42.8684
175	10	7	43.7986
170	10	8	34.6903
170	20	4	33.7311
160	20	5	34.9502
150	20	6	37.0729
140	20	7	29.4623
130	20	8	42.2719
120	30	6	41.3605
195	10	1	61.4499
190	10	2	66.615
185	10	3	46.6546
180	10	4	43.5466
175	10	5	46.2833
170	10	6	41.6861

165	10	7	23.7808
160	10	8	40.9162
160	20	4	42.871
150	20	5	28.6708
140	20	6	43.4234
130	20	7	37.3709
120	20	8	52.0204
185	10	1	64.132
180	10	2	51.8847
175	10	3	48.7394
170	10	4	45.4093
165	10	5	41.4469
160	10	6	36.1478
155	10	7	35.0613
150	10	8	39.6123
150	20	4	36.8955
140	20	5	40.1982
130	20	6	31.4513
120	20	7	46.6024
110	20	8	48.7613
175	10	1	59.4186
170	10	2	57.0048
165	10	3	51.7654
160	10	4	44.1803
155	10	5	33.4085
150	10	6	39.4115
145	10	7	46.3011
140	10	8	33.4701
140	20	4	25.6183
130	20	5	47.8602
120	20	6	37.4339
110	20	7	64.1868
100	20	8	55.6608
165	10	1	75.3147
160	10	2	72.4764
155	10	3	55.2851
150	10	4	40.7976
145	10	5	46.7774
140	10	6	52.764
135	10	7	33.7479
130	10	8	39.3152
130	20	4	42.5825
120	20	5	37.1969
110	20	6	61.1879
100	20	7	64.0864
155	10	1	65.6161

150	10	2	48.698
145	10	3	33.9686
140	10	4	37.4984
135	10	5	42.2999
130	10	6	28.4076
125	10	7	25.5459
120	10	8	53.2041
120	20	4	45.0176
110	20	5	52.1331
100	20	6	41.3608
90	20	7	71.9406
145	10	1	60.0538
140	10	2	39.9524
135	10	3	38.7675
130	10	4	42.7811
125	10	5	27.5334
120	10	6	28.8281
115	10	7	52.0833
110	10	8	31.0171
110	20	4	35.047
100	20	5	47.8786
90	20	6	53.3173
135	10	1	60.4692
130	10	2	46.9724
125	10	3	41.0856
120	10	4	26.1035
115	10	5	29.7042
110	10	6	53.49
105	10	7	18.7124
100	10	8	45.3711
100	20	4	35.7798
90	20	5	75.2302
80	20	6	35.8926
125	10	1	62.4376
120	10	2	44.7868
115	10	3	32.2654
110	10	4	16.4925
105	10	5	41.1795
100	10	6	29.8672
95	10	7	27.6001
90	10	8	77.0023
90	20	4	48.1894
80	20	5	52.86
115	10	1	41.5177
110	10	2	25.8787
105	10	3	14.2566

100	10	4	41.0014
95	10	5	13.3379
90	10	6	24.7998
85	10	7	26.3567
80	10	8	15.4578
80	20	4	40.286
70	20	5	20.2888
105	10	1	43.0869
100	10	2	19.8452
95	10	3	32.2196
90	10	4	19.8558
85	10	5	24.1086
80	10	6	41.9785
75	10	7	23.9194
70	10	8	51.4077
70	20	4	53.6662
95	10	1	25.0487
90	10	2	36.6104
85	10	3	19.2577
80	10	4	28.4323
75	10	5	33.3019
70	10	6	72.8706
65	10	7	17.8425
60	10	8	43.6575
60	20	4	67.8766
85	10	1	20.494
80	10	2	11.3984
75	10	3	15.8006
70	10	4	26.8109
65	10	5	24.0384
60	10	6	38.8705
55	10	7	14.825
50	10	8	37.5712
75	10	1	12.9251
70	10	2	11.633
65	10	3	22.0619
60	10	4	23.3774
55	10	5	30.5932
50	10	6	20.8607
45	10	7	32.4186
65	10	1	19.8561
60	10	2	29.3475
55	10	3	43.4407
50	10	4	51.1317
45	10	5	35.2566
40	10	6	56.2613

55	10	1	10.8801
50	10	2	17.5472
45	10	3	20.1186
40	10	4	17.0728
35	10	5	24.6447
45	10	1	12.2139
40	10	2	19.367
35	10	3	13.5015
30	10	4	24.0576
35	10	1	17.241
30	10	2	14.8265
25	10	3	24.898
25	10	1	12.9546
20	10	2	21.4724
15	10	1	18.2149
0			
0			
0			

Sting/Swift prg: COL5

1.00000			
3			
690			
1			
0			
61.50000	1.00000	1.00000	38.23020
61.00000	1.00000	2.00000	27.05670
60.50000	1.00000	3.00000	24.85920
60.00000	1.00000	4.00000	25.88720
59.50000	1.00000	5.00000	27.94240
59.00000	1.00000	6.00000	26.00720
58.50000	1.00000	7.00000	27.58000
58.00000	1.00000	8.00000	26.78040
60.50000	1.00000	1.00000	36.73930
60.00000	1.00000	2.00000	26.83640
59.50000	1.00000	3.00000	25.11490
59.00000	1.00000	4.00000	27.08070
58.50000	1.00000	5.00000	25.79940
58.00000	1.00000	6.00000	28.04340
57.50000	1.00000	7.00000	28.64580
57.00000	1.00000	8.00000	25.85980
57.00000	2.00000	4.00000	24.35620
56.00000	2.00000	5.00000	24.03490
55.00000	2.00000	6.00000	32.42330
54.00000	2.00000	7.00000	26.27500
59.50000	1.00000	1.00000	38.78190

59.00000	1.00000	2.00000	27.29180
58.50000	1.00000	3.00000	28.07840
58.00000	1.00000	4.00000	27.01100
57.50000	1.00000	5.00000	29.50290
57.00000	1.00000	6.00000	30.51530
56.50000	1.00000	7.00000	32.06600
56.00000	1.00000	8.00000	25.39740
56.00000	2.00000	4.00000	23.43740
55.00000	2.00000	5.00000	28.42030
54.00000	2.00000	6.00000	34.84750
53.00000	2.00000	7.00000	20.18920
51.00000	3.00000	6.00000	29.68040
58.50000	1.00000	1.00000	32.88970
57.50000	1.00000	3.00000	26.83670
57.00000	1.00000	4.00000	29.77140
56.50000	1.00000	5.00000	31.37610
56.00000	1.00000	6.00000	28.96790
55.50000	1.00000	7.00000	27.19750
55.00000	2.00000	4.00000	26.01160
54.00000	2.00000	5.00000	40.09390
53.00000	2.00000	6.00000	34.21890
48.50000	3.00000	7.00000	39.52870
57.50000	1.00000	1.00000	31.68550
57.00000	1.00000	2.00000	24.45280
56.50000	1.00000	3.00000	26.23030
56.00000	1.00000	4.00000	27.95520
55.50000	1.00000	5.00000	27.36300
55.00000	1.00000	6.00000	25.63590
54.00000	1.00000	8.00000	22.56080
54.00000	2.00000	4.00000	31.73620
53.00000	2.00000	5.00000	38.74830
46.00000	4.00000	6.00000	52.91300
44.00000	4.00000	7.00000	63.96160
42.00000	4.00000	8.00000	71.54860
56.50000	1.00000	1.00000	28.79720
56.00000	1.00000	2.00000	25.32430
55.50000	1.00000	3.00000	26.42970
55.00000	1.00000	4.00000	25.81530
54.50000	1.00000	5.00000	24.61710
54.00000	1.00000	6.00000	26.44240
53.50000	1.00000	7.00000	27.29400
53.00000	1.00000	8.00000	37.86880
53.00000	2.00000	4.00000	40.47280
52.00000	2.00000	5.00000	35.80680
50.00000	2.00000	7.00000	36.44510
45.00000	4.00000	6.00000	54.85820

43.00000	4.00000	7.00000	60.98450
41.00000	4.00000	8.00000	62.42620
55.50000	1.00000	1.00000	27.03950
55.00000	1.00000	2.00000	26.09760
54.50000	1.00000	3.00000	24.59010
54.00000	1.00000	4.00000	23.02610
53.50000	1.00000	5.00000	24.91880
53.00000	1.00000	6.00000	25.72730
52.50000	1.00000	7.00000	38.97000
52.00000	1.00000	8.00000	41.59570
52.00000	2.00000	4.00000	39.31210
50.00000	2.00000	6.00000	40.71860
54.50000	1.00000	1.00000	25.77810
54.00000	1.00000	2.00000	22.73680
53.50000	1.00000	3.00000	19.68130
53.00000	1.00000	4.00000	21.64030
52.50000	1.00000	5.00000	21.80740
52.00000	1.00000	6.00000	33.48440
51.50000	1.00000	7.00000	36.58150
51.00000	1.00000	8.00000	31.75490
51.00000	2.00000	4.00000	33.59770
43.00000	4.00000	6.00000	60.96010
53.50000	1.00000	1.00000	22.82890
53.00000	1.00000	2.00000	18.05560
52.50000	1.00000	3.00000	20.12500
52.00000	1.00000	4.00000	21.28280
51.50000	1.00000	5.00000	32.85760
51.00000	1.00000	6.00000	37.04650
50.50000	1.00000	7.00000	32.70390
50.00000	2.00000	4.00000	30.62190
49.00000	2.00000	5.00000	38.64160
42.00000	4.00000	6.00000	65.12810
52.50000	1.00000	1.00000	16.08300
52.00000	1.00000	2.00000	16.64900
51.50000	1.00000	3.00000	17.84110
51.00000	1.00000	4.00000	28.84150
50.50000	1.00000	5.00000	33.59370
50.00000	1.00000	6.00000	30.29950
49.50000	1.00000	7.00000	31.87510
49.00000	2.00000	4.00000	33.59480
48.00000	2.00000	5.00000	33.94130
47.00000	2.00000	6.00000	31.43200
45.00000	2.00000	8.00000	35.52920
41.00000	4.00000	6.00000	64.00130
39.00000	4.00000	7.00000	65.95040
37.00000	4.00000	8.00000	85.07320

35.50000	5.00000	7.00000	83.91450
51.50000	1.00000	1.00000	14.69640
51.00000	1.00000	2.00000	14.46600
50.50000	1.00000	3.00000	23.41250
50.00000	1.00000	4.00000	28.22030
49.50000	1.00000	5.00000	26.60660
49.00000	1.00000	6.00000	24.69640
48.50000	1.00000	7.00000	28.10150
48.00000	1.00000	8.00000	33.63340
48.00000	2.00000	4.00000	36.58900
47.00000	2.00000	5.00000	27.62740
46.00000	2.00000	6.00000	34.89490
45.00000	2.00000	7.00000	30.22550
44.00000	2.00000	8.00000	33.91970
40.00000	4.00000	6.00000	55.23550
32.00000	5.00000	8.00000	54.22170
50.50000	1.00000	1.00000	13.45260
50.00000	1.00000	2.00000	19.84610
49.50000	1.00000	3.00000	24.57910
49.00000	1.00000	4.00000	24.04290
48.50000	1.00000	5.00000	27.60140
48.00000	1.00000	6.00000	21.49060
47.50000	1.00000	7.00000	32.40630
47.00000	1.00000	8.00000	31.00030
47.00000	2.00000	4.00000	30.70910
45.00000	2.00000	6.00000	37.38190
43.00000	2.00000	8.00000	58.07540
49.50000	1.00000	1.00000	16.17150
49.00000	1.00000	2.00000	19.22330
48.50000	1.00000	3.00000	19.69590
48.00000	1.00000	4.00000	21.14140
47.50000	1.00000	5.00000	19.63120
47.00000	1.00000	6.00000	30.52190
46.50000	1.00000	7.00000	23.18120
46.00000	1.00000	8.00000	19.71400
46.00000	2.00000	4.00000	26.42120
45.00000	2.00000	5.00000	28.28160
44.00000	2.00000	6.00000	22.59190
43.00000	2.00000	7.00000	46.81680
48.50000	1.00000	1.00000	18.58180
48.00000	1.00000	2.00000	18.42280
47.50000	1.00000	3.00000	20.05920
47.00000	1.00000	4.00000	19.51150
46.50000	1.00000	5.00000	27.61490
46.00000	1.00000	6.00000	29.15290
45.50000	1.00000	7.00000	25.57660

47.50000	1.00000	1.00000	23.36210
47.00000	1.00000	2.00000	26.39610
46.50000	1.00000	3.00000	26.23000
46.00000	1.00000	4.00000	39.51010
45.50000	1.00000	5.00000	36.79590
45.00000	1.00000	6.00000	31.94160
44.50000	1.00000	7.00000	32.06600
44.00000	2.00000	4.00000	31.43670
43.00000	2.00000	5.00000	34.36820
42.00000	2.00000	6.00000	33.77970
41.00000	2.00000	7.00000	48.88250
39.00000	3.00000	6.00000	58.22600
32.00000	4.00000	8.00000	54.47700
30.50000	5.00000	7.00000	68.99410
28.00000	5.00000	8.00000	98.67250
46.50000	1.00000	1.00000	21.05630
45.50000	1.00000	3.00000	35.15550
45.00000	1.00000	4.00000	33.15170
43.00000	1.00000	8.00000	37.52940
43.00000	2.00000	4.00000	37.57260
42.00000	2.00000	5.00000	35.65600
40.00000	2.00000	7.00000	49.29770
38.00000	3.00000	6.00000	59.83920
33.00000	4.00000	7.00000	98.23580
35.00000	4.00000	6.00000	63.73090
45.50000	1.00000	1.00000	18.12990
45.00000	1.00000	2.00000	26.81830
44.50000	1.00000	3.00000	25.60100
44.00000	1.00000	4.00000	22.85020
43.50000	1.00000	5.00000	20.96540
43.00000	1.00000	6.00000	25.60740
42.50000	1.00000	7.00000	30.24450
42.00000	1.00000	8.00000	26.38300
42.00000	2.00000	4.00000	29.90220
41.00000	2.00000	5.00000	38.32510
40.00000	2.00000	6.00000	36.95740
38.00000	2.00000	8.00000	62.99640
39.00000	2.00000	7.00000	56.41310
34.00000	4.00000	6.00000	65.59600
32.00000	4.00000	7.00000	90.63250
30.00000	4.00000	8.00000	60.37920
44.50000	1.00000	1.00000	29.41170
44.00000	1.00000	2.00000	27.62230
43.50000	1.00000	3.00000	23.81570
43.00000	1.00000	4.00000	23.78740
42.50000	1.00000	5.00000	26.92380

42.00000	1.00000	6.00000	31.30030
41.50000	1.00000	7.00000	27.87800
41.00000	1.00000	8.00000	26.97530
41.00000	2.00000	4.00000	27.54390
40.00000	2.00000	5.00000	35.51380
39.00000	2.00000	6.00000	39.11930
29.00000	4.00000	8.00000	78.76200
27.50000	5.00000	7.00000	78.87340
43.50000	1.00000	1.00000	27.37820
42.50000	1.00000	3.00000	20.38030
42.00000	1.00000	4.00000	22.37180
41.50000	1.00000	5.00000	30.93340
40.00000	2.00000	4.00000	31.47490
39.00000	2.00000	5.00000	28.94210
38.00000	2.00000	6.00000	51.95790
37.00000	2.00000	7.00000	47.92690
36.00000	2.00000	8.00000	41.68940
35.00000	3.00000	6.00000	58.07150
26.50000	5.00000	7.00000	85.80940
42.50000	1.00000	1.00000	40.45700
42.00000	1.00000	2.00000	28.99740
41.50000	1.00000	3.00000	37.81050
41.00000	1.00000	4.00000	44.20210
40.50000	1.00000	5.00000	40.76870
40.00000	1.00000	6.00000	37.10150
39.50000	1.00000	7.00000	42.44810
39.00000	2.00000	4.00000	49.73830
38.00000	2.00000	5.00000	42.91990
37.00000	2.00000	6.00000	57.32580
36.00000	2.00000	7.00000	53.64190
35.00000	2.00000	8.00000	59.52670
31.00000	3.00000	8.00000	104.74500
31.00000	4.00000	6.00000	91.01870
41.50000	1.00000	1.00000	32.73410
41.00000	1.00000	2.00000	38.36080
40.50000	1.00000	3.00000	43.87310
40.00000	1.00000	4.00000	41.98020
39.50000	1.00000	5.00000	41.01010
39.00000	1.00000	6.00000	48.71910
38.50000	1.00000	7.00000	56.60500
38.00000	1.00000	8.00000	53.01520
38.00000	2.00000	4.00000	53.32030
37.00000	2.00000	5.00000	56.13620
33.00000	3.00000	6.00000	75.67420
31.50000	3.00000	7.00000	85.16930
30.00000	3.00000	8.00000	119.51800

30.00000	4.00000	6.00000	104.76500
26.00000	4.00000	8.00000	91.43100
40.50000	1.00000	1.00000	34.00060
40.00000	1.00000	2.00000	36.65730
39.50000	1.00000	3.00000	32.36740
39.00000	1.00000	4.00000	33.22590
38.50000	1.00000	5.00000	40.44100
38.00000	1.00000	6.00000	52.02220
37.50000	1.00000	7.00000	47.30420
37.00000	1.00000	8.00000	45.24400
37.00000	2.00000	4.00000	52.27610
36.00000	2.00000	5.00000	68.97510
35.00000	2.00000	6.00000	65.56340
34.00000	2.00000	7.00000	72.02870
33.00000	2.00000	8.00000	75.06630
32.00000	3.00000	6.00000	77.25150
30.50000	3.00000	7.00000	111.18500
29.00000	4.00000	6.00000	78.76370
25.00000	4.00000	8.00000	87.96050
39.50000	1.00000	1.00000	36.05710
39.00000	1.00000	2.00000	27.47020
38.50000	1.00000	3.00000	28.17360
38.00000	1.00000	4.00000	31.89780
37.50000	1.00000	5.00000	54.61120
37.00000	1.00000	6.00000	41.35890
36.50000	1.00000	7.00000	42.55160
36.00000	1.00000	8.00000	50.43970
36.00000	2.00000	4.00000	56.13280
35.00000	2.00000	5.00000	66.92090
34.00000	2.00000	6.00000	58.70700
33.00000	2.00000	7.00000	69.38870
32.00000	2.00000	8.00000	77.28970
28.00000	3.00000	8.00000	73.50140
28.00000	4.00000	6.00000	71.35060
38.50000	1.00000	1.00000	28.17360
38.00000	1.00000	2.00000	25.33580
37.50000	1.00000	3.00000	30.23540
37.00000	1.00000	4.00000	49.63890
36.50000	1.00000	5.00000	42.03140
36.00000	1.00000	6.00000	42.95730
35.50000	1.00000	7.00000	50.56350
35.00000	1.00000	8.00000	61.71310
35.00000	2.00000	4.00000	63.77140
34.00000	2.00000	5.00000	62.20130
33.00000	2.00000	6.00000	68.56950
28.50000	3.00000	7.00000	116.51900

27.00000	3.00000	8.00000	64.79870
27.00000	4.00000	6.00000	73.79480
25.00000	4.00000	7.00000	85.72550
23.00000	4.00000	8.00000	115.87900
37.50000	1.00000	1.00000	22.35520
37.00000	1.00000	2.00000	28.90720
36.50000	1.00000	3.00000	38.26450
36.00000	1.00000	4.00000	39.64520
35.50000	1.00000	5.00000	41.24070
35.00000	1.00000	6.00000	49.89750
34.50000	1.00000	7.00000	61.17500
34.00000	1.00000	8.00000	68.36480
34.00000	2.00000	4.00000	69.43610
33.00000	2.00000	5.00000	62.62510
32.00000	2.00000	6.00000	73.57780
31.00000	2.00000	7.00000	83.38630
30.00000	2.00000	8.00000	78.51550
26.00000	3.00000	8.00000	80.46120
26.00000	4.00000	6.00000	76.99110
24.00000	4.00000	7.00000	90.89460
22.00000	4.00000	8.00000	122.44400
36.50000	1.00000	1.00000	19.44350
36.00000	1.00000	2.00000	29.80140
35.50000	1.00000	3.00000	28.23470
35.00000	1.00000	4.00000	29.84060
34.50000	1.00000	5.00000	36.51240
34.00000	1.00000	6.00000	45.30970
33.50000	1.00000	7.00000	51.76130
33.00000	1.00000	8.00000	53.35230
33.00000	2.00000	4.00000	56.73120
29.00000	2.00000	8.00000	73.34450
30.00000	2.00000	7.00000	70.53420
28.00000	3.00000	6.00000	129.11301
35.50000	1.00000	1.00000	25.44120
35.00000	1.00000	2.00000	22.63020
34.50000	1.00000	3.00000	23.22840
34.00000	1.00000	4.00000	29.39990
33.50000	1.00000	5.00000	36.99270
33.00000	1.00000	6.00000	43.17530
32.50000	1.00000	7.00000	45.31830
32.00000	1.00000	8.00000	38.49290
32.00000	2.00000	4.00000	44.68650
34.50000	1.00000	1.00000	26.02340
33.50000	1.00000	3.00000	27.46470
33.00000	1.00000	4.00000	35.57280
32.50000	1.00000	5.00000	42.24700

32.00000	1.00000	6.00000	45.57620
31.00000	2.00000	4.00000	48.82960
30.00000	2.00000	5.00000	51.24970
29.00000	2.00000	6.00000	58.16550
33.50000	1.00000	1.00000	25.26420
33.00000	1.00000	2.00000	28.02830
32.50000	1.00000	3.00000	36.22500
32.00000	1.00000	4.00000	44.56160
31.50000	1.00000	5.00000	49.76320
31.00000	1.00000	6.00000	43.62070
30.50000	1.00000	7.00000	55.11350
30.00000	1.00000	8.00000	60.23910
30.00000	2.00000	4.00000	55.07610
29.00000	2.00000	5.00000	64.78800
28.00000	2.00000	6.00000	64.25570
27.00000	2.00000	7.00000	89.35570
25.00000	3.00000	6.00000	71.86560
22.00000	4.00000	6.00000	90.64920
32.50000	1.00000	1.00000	24.16640
32.00000	1.00000	2.00000	27.29280
31.50000	1.00000	3.00000	32.63740
31.00000	1.00000	4.00000	37.53850
30.50000	1.00000	5.00000	33.40620
30.00000	1.00000	6.00000	42.95040
29.50000	1.00000	7.00000	46.74610
29.00000	2.00000	4.00000	53.35570
28.00000	2.00000	5.00000	63.91990
27.00000	2.00000	6.00000	70.91620
26.00000	2.00000	7.00000	132.83600
31.50000	1.00000	1.00000	29.33490
31.00000	1.00000	2.00000	29.93050
30.50000	1.00000	3.00000	33.59890
30.00000	1.00000	4.00000	30.37320
29.50000	1.00000	5.00000	39.83190
29.00000	1.00000	6.00000	43.20560
28.50000	1.00000	7.00000	41.49330
28.00000	1.00000	8.00000	48.66760
28.00000	2.00000	4.00000	53.23720
27.00000	2.00000	5.00000	55.94760
26.00000	2.00000	6.00000	80.16980
25.00000	2.00000	7.00000	131.53101
23.00000	3.00000	6.00000	78.16700
21.50000	3.00000	7.00000	94.61910
20.00000	3.00000	8.00000	119.40000
18.00000	4.00000	7.00000	129.49899
30.50000	1.00000	1.00000	34.68610

30.00000	1.00000	2.00000	34.03630
29.50000	1.00000	3.00000	29.93810
29.00000	1.00000	4.00000	39.81860
28.50000	1.00000	5.00000	43.16250
28.00000	1.00000	6.00000	42.37500
27.50000	1.00000	7.00000	50.07690
27.00000	1.00000	8.00000	61.18170
27.00000	2.00000	4.00000	57.81200
26.00000	2.00000	5.00000	67.05080
25.00000	2.00000	6.00000	129.63699
24.00000	2.00000	7.00000	109.66700
23.00000	2.00000	8.00000	73.62750
20.50000	3.00000	7.00000	100.36900
19.00000	3.00000	8.00000	93.36600
19.00000	4.00000	6.00000	131.77100
29.50000	1.00000	1.00000	36.07290
29.00000	1.00000	2.00000	28.75160
28.50000	1.00000	3.00000	36.08110
28.00000	1.00000	4.00000	39.92400
27.50000	1.00000	5.00000	39.61870
27.00000	1.00000	6.00000	48.52450
26.00000	2.00000	4.00000	62.38040
25.00000	2.00000	5.00000	96.79180
24.00000	2.00000	6.00000	162.09801
23.00000	2.00000	7.00000	96.29490
22.00000	2.00000	8.00000	82.15580
21.00000	3.00000	6.00000	107.51100
19.50000	3.00000	7.00000	120.25500
18.00000	3.00000	8.00000	153.29601
18.00000	4.00000	6.00000	151.29601
28.50000	1.00000	1.00000	30.03200
28.00000	1.00000	2.00000	31.21510
27.50000	1.00000	3.00000	32.80810
27.00000	1.00000	4.00000	31.65050
26.50000	1.00000	5.00000	40.31980
26.00000	1.00000	6.00000	52.94020
25.50000	1.00000	7.00000	50.86930
25.00000	2.00000	4.00000	70.71750
24.00000	2.00000	5.00000	146.52901
23.00000	2.00000	6.00000	123.47100
22.00000	2.00000	7.00000	88.15910
21.00000	2.00000	8.00000	108.44700
27.50000	1.00000	1.00000	26.92940
27.00000	1.00000	2.00000	25.42810
26.50000	1.00000	3.00000	21.36040
26.00000	1.00000	4.00000	27.93180

25.50000	1.00000	5.00000	37.16400
25.00000	1.00000	6.00000	38.20130
24.50000	1.00000	7.00000	50.07610
24.00000	1.00000	8.00000	57.89890
24.00000	2.00000	4.00000	79.99180
23.00000	2.00000	5.00000	146.52200
22.00000	2.00000	6.00000	88.83710
21.00000	2.00000	7.00000	81.35850
20.00000	2.00000	8.00000	117.34000
16.00000	4.00000	6.00000	198.87900
26.50000	1.00000	1.00000	34.76880
26.00000	1.00000	2.00000	18.27420
25.50000	1.00000	3.00000	19.40460
25.00000	1.00000	4.00000	25.98020
24.50000	1.00000	5.00000	28.00120
24.00000	1.00000	6.00000	37.19140
23.50000	1.00000	7.00000	44.67930
23.00000	1.00000	8.00000	73.03470
23.00000	2.00000	4.00000	102.45400
22.00000	2.00000	5.00000	91.31590
21.00000	2.00000	6.00000	67.00580
20.00000	2.00000	7.00000	84.24200
19.00000	2.00000	8.00000	96.37470
18.00000	3.00000	6.00000	118.88600
16.50000	3.00000	7.00000	170.96100
15.00000	3.00000	8.00000	149.75400
25.50000	1.00000	1.00000	26.31890
25.00000	1.00000	2.00000	16.68520
24.50000	1.00000	3.00000	21.27680
24.00000	1.00000	4.00000	23.98460
23.50000	1.00000	5.00000	33.71820
23.00000	1.00000	6.00000	42.05970
22.50000	1.00000	7.00000	70.40770
22.00000	1.00000	8.00000	113.72700
22.00000	2.00000	4.00000	105.75800
21.00000	2.00000	5.00000	67.42440
20.00000	2.00000	6.00000	61.90720
19.00000	2.00000	7.00000	92.60580
18.00000	2.00000	8.00000	89.84700
24.50000	1.00000	1.00000	24.26470
24.00000	1.00000	2.00000	19.21060
23.50000	1.00000	3.00000	21.94390
23.00000	1.00000	4.00000	32.28050
22.50000	1.00000	5.00000	41.20200
22.00000	1.00000	6.00000	69.36710
21.50000	1.00000	7.00000	115.40100

21.00000	1.00000	8.00000	101.35100
21.00000	2.00000	4.00000	85.57510
20.00000	2.00000	5.00000	65.08750
19.00000	2.00000	6.00000	83.95730
18.00000	2.00000	7.00000	97.70490
17.00000	2.00000	8.00000	112.62700
14.50000	3.00000	7.00000	128.16901
23.50000	1.00000	1.00000	17.52580
23.00000	1.00000	2.00000	14.98590
22.50000	1.00000	3.00000	22.88180
22.00000	1.00000	4.00000	29.36730
21.50000	1.00000	5.00000	50.61260
21.00000	1.00000	6.00000	85.22270
20.50000	1.00000	7.00000	75.55480
20.00000	1.00000	8.00000	55.44980
20.00000	2.00000	4.00000	60.71490
19.00000	2.00000	5.00000	59.85210
18.00000	2.00000	6.00000	93.60940
17.00000	2.00000	7.00000	92.90880
16.00000	2.00000	8.00000	121.44600
15.00000	3.00000	6.00000	151.66701
13.50000	3.00000	7.00000	147.87199
22.50000	1.00000	1.00000	13.92550
22.00000	1.00000	2.00000	21.07770
21.50000	1.00000	3.00000	27.34150
21.00000	1.00000	4.00000	48.09710
20.50000	1.00000	5.00000	81.14210
20.00000	1.00000	6.00000	74.04020
19.50000	1.00000	7.00000	50.84480
19.00000	1.00000	8.00000	48.83540
19.00000	2.00000	4.00000	50.05800
18.00000	2.00000	5.00000	67.58290
17.00000	2.00000	6.00000	80.74000
16.00000	2.00000	7.00000	96.75710
15.00000	2.00000	8.00000	117.17700
14.00000	3.00000	6.00000	151.09599
21.50000	1.00000	1.00000	13.55360
21.00000	1.00000	2.00000	20.39150
20.50000	1.00000	3.00000	37.71940
20.00000	1.00000	4.00000	66.23420
19.50000	1.00000	5.00000	61.01380
18.50000	1.00000	7.00000	41.58240
18.00000	1.00000	8.00000	38.52470
18.00000	2.00000	4.00000	46.12260
17.00000	2.00000	5.00000	74.87520
16.00000	2.00000	6.00000	77.31260

15.00000	2.00000	7.00000	105.48300
14.00000	2.00000	8.00000	130.29601
20.50000	1.00000	1.00000	13.34800
20.00000	1.00000	2.00000	23.83090
19.50000	1.00000	3.00000	41.53030
19.00000	1.00000	4.00000	40.21510
18.50000	1.00000	5.00000	28.36480
18.00000	1.00000	6.00000	27.26410
17.50000	1.00000	7.00000	25.23760
17.00000	1.00000	8.00000	38.36020
17.00000	2.00000	4.00000	49.53230
16.00000	2.00000	5.00000	59.71530
15.00000	2.00000	6.00000	74.00100
14.00000	2.00000	7.00000	91.88930
13.00000	2.00000	8.00000	117.32900
12.00000	3.00000	6.00000	110.86100
19.50000	1.00000	1.00000	20.73050
19.00000	1.00000	2.00000	39.16060
18.50000	1.00000	3.00000	39.61430
18.00000	1.00000	4.00000	28.19650
17.50000	1.00000	5.00000	27.78140
17.00000	1.00000	6.00000	28.00360
16.50000	1.00000	7.00000	27.91790
16.00000	1.00000	8.00000	46.64120
16.00000	2.00000	4.00000	50.04400
18.50000	1.00000	1.00000	36.47700
18.00000	1.00000	2.00000	40.28000
17.50000	1.00000	3.00000	31.13220
17.00000	1.00000	4.00000	28.13470
16.50000	1.00000	5.00000	27.81310
16.00000	1.00000	6.00000	34.48250
15.50000	1.00000	7.00000	52.27500
15.00000	1.00000	8.00000	50.01520
15.00000	2.00000	4.00000	51.47770
17.50000	1.00000	1.00000	49.93730
17.00000	1.00000	2.00000	40.74070
16.50000	1.00000	3.00000	40.31170
16.00000	1.00000	4.00000	41.24730
15.50000	1.00000	5.00000	49.81880
15.00000	1.00000	6.00000	76.84070
14.50000	1.00000	7.00000	83.21510
14.00000	2.00000	4.00000	70.98000
13.00000	2.00000	5.00000	95.62620
12.00000	2.00000	6.00000	107.64600
16.50000	1.00000	1.00000	46.19640
16.00000	1.00000	2.00000	46.56930

15.50000	1.00000	3.00000	48.64670
15.00000	1.00000	4.00000	60.96060
14.50000	1.00000	5.00000	94.35040
14.00000	1.00000	6.00000	103.82900
13.50000	1.00000	7.00000	103.40800
13.00000	1.00000	8.00000	114.37500
13.00000	2.00000	4.00000	112.75000
12.00000	2.00000	5.00000	142.14600
11.00000	2.00000	6.00000	191.54500
10.00000	2.00000	7.00000	159.12801
15.50000	1.00000	1.00000	26.88080
15.00000	1.00000	2.00000	32.17510
14.50000	1.00000	3.00000	43.15310
14.00000	1.00000	4.00000	70.16850
13.50000	1.00000	5.00000	80.63280
13.00000	1.00000	6.00000	82.52440
12.50000	1.00000	7.00000	93.00180
12.00000	1.00000	8.00000	123.65800
12.00000	2.00000	4.00000	134.20100
11.00000	2.00000	5.00000	179.38600
10.00000	2.00000	6.00000	175.22800
9.00000	2.00000	7.00000	179.30499
14.50000	1.00000	1.00000	13.52960
14.00000	1.00000	2.00000	19.39980
13.50000	1.00000	3.00000	33.23060
13.00000	1.00000	4.00000	39.91940
12.50000	1.00000	5.00000	42.41040
12.00000	1.00000	6.00000	49.91450
11.50000	1.00000	7.00000	64.99530
11.00000	1.00000	8.00000	72.72110
11.00000	2.00000	4.00000	104.00500
10.00000	2.00000	5.00000	137.46800
9.00000	2.00000	6.00000	122.25100
13.50000	1.00000	1.00000	12.10790
13.00000	1.00000	2.00000	22.20230
12.50000	1.00000	3.00000	28.32470
12.00000	1.00000	4.00000	31.35670
11.50000	1.00000	5.00000	37.47420
11.00000	1.00000	6.00000	53.86300
10.50000	1.00000	7.00000	54.10590
10.00000	1.00000	8.00000	67.14710
10.00000	2.00000	4.00000	80.94250
9.00000	2.00000	5.00000	97.56050
12.50000	1.00000	1.00000	15.15280
12.00000	1.00000	2.00000	19.92070
11.50000	1.00000	3.00000	22.93280

11.00000	1.00000	4.00000	28.23600
10.50000	1.00000	5.00000	40.26360
10.00000	1.00000	6.00000	46.45780
9.50000	1.00000	7.00000	53.17530
9.00000	1.00000	8.00000	73.55630
9.00000	2.00000	4.00000	74.88190
8.00000	2.00000	5.00000	67.10010
11.50000	1.00000	1.00000	17.88640
11.00000	1.00000	2.00000	21.47180
10.50000	1.00000	3.00000	27.86910
10.00000	1.00000	4.00000	42.47430
9.50000	1.00000	5.00000	47.45440
9.00000	1.00000	6.00000	57.71070
8.50000	1.00000	7.00000	71.00040
8.00000	1.00000	8.00000	73.69360
8.00000	2.00000	4.00000	67.43520
7.00000	2.00000	5.00000	63.31640
10.50000	1.00000	1.00000	19.68130
10.00000	1.00000	2.00000	28.99140
9.50000	1.00000	3.00000	46.92250
9.00000	1.00000	4.00000	57.10320
8.50000	1.00000	5.00000	70.74800
8.00000	1.00000	6.00000	87.34220
7.50000	1.00000	7.00000	96.28900
7.00000	1.00000	8.00000	85.00640
7.00000	2.00000	4.00000	74.64030
9.50000	1.00000	1.00000	16.97560
9.00000	1.00000	2.00000	33.47500
8.50000	1.00000	3.00000	45.12750
8.00000	1.00000	4.00000	58.17840
7.50000	1.00000	5.00000	72.47820
7.00000	1.00000	6.00000	83.68670
6.50000	1.00000	7.00000	77.02130
6.00000	1.00000	8.00000	72.05940
6.00000	2.00000	4.00000	79.61130
8.50000	1.00000	1.00000	21.65340
8.00000	1.00000	2.00000	35.07520
7.50000	1.00000	3.00000	49.11380
7.00000	1.00000	4.00000	62.49740
6.50000	1.00000	5.00000	77.12270
6.00000	1.00000	6.00000	69.93070
5.50000	1.00000	7.00000	63.04930
5.00000	1.00000	8.00000	74.79900
7.50000	1.00000	1.00000	25.91800
7.00000	1.00000	2.00000	43.89290
6.50000	1.00000	3.00000	64.17430

6.00000	1.00000	4.00000	71.44940
5.50000	1.00000	5.00000	72.10160
5.00000	1.00000	6.00000	67.19960
4.50000	1.00000	7.00000	79.73010
6.50000	1.00000	1.00000	35.74340
6.00000	1.00000	2.00000	61.05650
5.50000	1.00000	3.00000	77.07980
5.00000	1.00000	4.00000	79.03140
4.50000	1.00000	5.00000	75.34800
4.00000	1.00000	6.00000	91.43100
5.50000	1.00000	1.00000	43.14600
5.00000	1.00000	2.00000	62.69050
4.50000	1.00000	3.00000	67.31170
4.00000	1.00000	4.00000	67.16950
3.50000	1.00000	5.00000	82.56580
4.50000	1.00000	1.00000	62.88590
4.00000	1.00000	2.00000	73.31020
3.50000	1.00000	3.00000	75.85020
3.00000	1.00000	4.00000	95.04530
3.50000	1.00000	1.00000	62.08160
3.00000	1.00000	2.00000	70.73080
2.50000	1.00000	3.00000	94.10300
2.50000	1.00000	1.00000	52.25710
2.00000	1.00000	2.00000	73.57860
1.50000	1.00000	1.00000	52.35740

0
0
0

Sting/Swift prg: COL6

1.00000

3

747

1

0

61.50000	1.00000	1.00000	6.91395
61.00000	1.00000	2.00000	6.90681
60.50000	1.00000	3.00000	8.30753
60.00000	1.00000	4.00000	9.58385
59.50000	1.00000	5.00000	14.74150
59.00000	1.00000	6.00000	16.79460
58.50000	1.00000	7.00000	10.25370
58.00000	1.00000	8.00000	7.50983
60.50000	1.00000	1.00000	4.61118
60.00000	1.00000	2.00000	7.55712
59.50000	1.00000	3.00000	7.55381

59.00000	1.00000	4.00000	12.05510
58.50000	1.00000	5.00000	15.24890
58.00000	1.00000	6.00000	8.47249
57.50000	1.00000	7.00000	7.41406
57.00000	1.00000	8.00000	19.32830
57.00000	2.00000	4.00000	14.27670
56.00000	2.00000	5.00000	10.15590
55.00000	2.00000	6.00000	7.89271
54.00000	2.00000	7.00000	8.09481
53.00000	2.00000	8.00000	17.26180
59.50000	1.00000	1.00000	7.22708
59.00000	1.00000	2.00000	8.46748
58.50000	1.00000	3.00000	14.16920
58.00000	1.00000	4.00000	18.28580
57.50000	1.00000	5.00000	10.52050
57.00000	1.00000	6.00000	9.63060
56.50000	1.00000	7.00000	28.32600
56.00000	2.00000	4.00000	5.90472
55.00000	2.00000	5.00000	10.36860
54.00000	2.00000	6.00000	15.80090
53.00000	2.00000	7.00000	7.97959
51.00000	3.00000	6.00000	21.93700
58.50000	1.00000	1.00000	6.92913
58.00000	1.00000	2.00000	11.84420
57.50000	1.00000	3.00000	16.46600
57.00000	1.00000	4.00000	9.85062
56.50000	1.00000	5.00000	8.53016
56.00000	1.00000	6.00000	15.97850
55.50000	1.00000	7.00000	8.81190
55.00000	1.00000	8.00000	14.88980
55.00000	2.00000	4.00000	13.94260
54.00000	2.00000	5.00000	11.90450
53.00000	2.00000	6.00000	16.92150
50.00000	3.00000	6.00000	21.56080
47.00000	4.00000	6.00000	15.51260
57.50000	1.00000	1.00000	16.47410
57.00000	1.00000	2.00000	20.66760
56.50000	1.00000	3.00000	11.41220
56.00000	1.00000	4.00000	9.64379
55.50000	1.00000	5.00000	18.26470
55.00000	1.00000	6.00000	18.57480
54.50000	1.00000	7.00000	16.78160
54.00000	1.00000	8.00000	9.90290
54.00000	2.00000	4.00000	10.41620
52.00000	2.00000	6.00000	17.51800
49.00000	3.00000	6.00000	8.19570

46.00000	4.00000	6.00000	18.83210
40.50000	5.00000	7.00000	38.62700
56.50000	1.00000	1.00000	43.72930
56.00000	1.00000	2.00000	15.09770
55.50000	1.00000	3.00000	9.30676
55.00000	1.00000	4.00000	16.33200
54.50000	1.00000	5.00000	17.15890
54.00000	1.00000	6.00000	13.68000
53.50000	1.00000	7.00000	13.31380
53.00000	1.00000	8.00000	10.72790
53.00000	2.00000	4.00000	11.25090
51.00000	2.00000	6.00000	21.71570
49.00000	2.00000	8.00000	33.06470
46.50000	3.00000	7.00000	13.25800
45.00000	3.00000	8.00000	18.18210
45.00000	4.00000	6.00000	15.16930
36.00000	6.00000	7.00000	37.22740
33.00000	6.00000	8.00000	47.74330
55.50000	1.00000	1.00000	37.88420
55.00000	1.00000	2.00000	16.71620
54.50000	1.00000	3.00000	24.84580
54.00000	1.00000	4.00000	24.02210
53.50000	1.00000	5.00000	21.04740
53.00000	1.00000	6.00000	17.13780
52.50000	1.00000	7.00000	13.49610
52.00000	1.00000	8.00000	16.52790
52.00000	2.00000	4.00000	13.50830
51.00000	2.00000	5.00000	20.80010
50.00000	2.00000	6.00000	33.14050
49.00000	2.00000	7.00000	37.11100
47.00000	3.00000	6.00000	20.80380
45.50000	3.00000	7.00000	16.11000
44.00000	3.00000	8.00000	22.90990
44.00000	4.00000	6.00000	23.12170
54.50000	1.00000	1.00000	24.72600
54.00000	1.00000	2.00000	30.57990
53.50000	1.00000	3.00000	28.52910
53.00000	1.00000	4.00000	24.06480
52.50000	1.00000	5.00000	18.13550
52.00000	1.00000	6.00000	13.62770
51.50000	1.00000	7.00000	18.46150
51.00000	1.00000	8.00000	15.99880
51.00000	2.00000	4.00000	19.12490
50.00000	2.00000	5.00000	29.08170
49.00000	2.00000	6.00000	42.08020
48.00000	2.00000	7.00000	46.60450

47.00000	2.00000	8.00000	27.70410
46.00000	3.00000	6.00000	24.03070
44.50000	3.00000	7.00000	20.19060
43.00000	3.00000	8.00000	30.50780
43.00000	4.00000	6.00000	29.66120
39.00000	4.00000	8.00000	53.79140
37.50000	5.00000	7.00000	54.70380
35.00000	5.00000	8.00000	47.36500
34.00000	6.00000	7.00000	63.52520
53.50000	1.00000	1.00000	25.35490
53.00000	1.00000	2.00000	26.28030
52.50000	1.00000	3.00000	18.95830
52.00000	1.00000	4.00000	13.38830
51.50000	1.00000	5.00000	10.26640
51.00000	1.00000	6.00000	11.87160
50.50000	1.00000	7.00000	10.56800
50.00000	1.00000	8.00000	15.85550
50.00000	2.00000	4.00000	20.22210
49.00000	2.00000	5.00000	32.95230
48.00000	2.00000	6.00000	38.49470
47.00000	2.00000	7.00000	32.77180
46.00000	2.00000	8.00000	23.40840
45.00000	3.00000	6.00000	20.10830
42.00000	3.00000	8.00000	30.50360
52.50000	1.00000	1.00000	24.62120
52.00000	1.00000	2.00000	16.82250
51.50000	1.00000	3.00000	10.58490
51.00000	1.00000	4.00000	7.54859
50.50000	1.00000	5.00000	9.20166
49.50000	1.00000	7.00000	12.33150
49.00000	1.00000	8.00000	13.04740
49.00000	2.00000	4.00000	17.77120
48.00000	2.00000	5.00000	26.61180
47.00000	2.00000	6.00000	29.97330
45.00000	2.00000	8.00000	17.09770
44.00000	3.00000	6.00000	18.28740
42.50000	3.00000	7.00000	24.81960
41.00000	3.00000	8.00000	27.46390
41.00000	4.00000	6.00000	32.25310
39.00000	4.00000	7.00000	51.37050
32.00000	6.00000	7.00000	70.38280
51.50000	1.00000	1.00000	36.52660
51.00000	1.00000	2.00000	19.48700
50.50000	1.00000	3.00000	10.77940
50.00000	1.00000	4.00000	12.70410
49.50000	1.00000	5.00000	11.03050

49.00000	1.00000	6.00000	15.16120
48.50000	1.00000	7.00000	21.67150
48.00000	1.00000	8.00000	26.65600
48.00000	2.00000	4.00000	26.61830
47.00000	2.00000	5.00000	32.17950
46.00000	2.00000	6.00000	28.60540
45.00000	2.00000	7.00000	19.65010
43.00000	3.00000	6.00000	22.31720
50.50000	1.00000	1.00000	25.22980
50.00000	1.00000	2.00000	11.63730
49.50000	1.00000	3.00000	11.63700
49.00000	1.00000	4.00000	9.06907
48.50000	1.00000	5.00000	16.69630
48.00000	1.00000	6.00000	14.35220
47.00000	1.00000	8.00000	29.45610
47.00000	2.00000	4.00000	32.36990
46.00000	2.00000	5.00000	38.13010
44.00000	2.00000	7.00000	18.22060
43.00000	2.00000	8.00000	25.48340
42.00000	3.00000	6.00000	19.83290
39.00000	4.00000	6.00000	36.94280
37.00000	4.00000	7.00000	49.08910
33.50000	5.00000	7.00000	51.95430
49.50000	1.00000	1.00000	18.46010
49.00000	1.00000	2.00000	16.25560
48.50000	1.00000	3.00000	10.26330
48.00000	1.00000	4.00000	14.05950
47.50000	1.00000	5.00000	15.87710
47.00000	1.00000	6.00000	23.54990
46.50000	1.00000	7.00000	30.17690
46.00000	1.00000	8.00000	32.20380
46.00000	2.00000	4.00000	34.39380
45.00000	2.00000	5.00000	31.24180
44.00000	2.00000	6.00000	12.73620
42.00000	2.00000	8.00000	12.80770
41.00000	3.00000	6.00000	26.74830
39.50000	3.00000	7.00000	30.01110
38.00000	3.00000	8.00000	43.43830
38.00000	4.00000	6.00000	48.40950
36.00000	4.00000	7.00000	44.65440
34.00000	4.00000	8.00000	57.52920
32.50000	5.00000	7.00000	50.79530
30.00000	5.00000	8.00000	83.30170
48.50000	1.00000	1.00000	21.42270
48.00000	1.00000	2.00000	9.64904
47.50000	1.00000	3.00000	12.92420

47.00000	1.00000	4.00000	13.85940
46.50000	1.00000	5.00000	20.18200
46.00000	1.00000	6.00000	27.75650
45.50000	1.00000	7.00000	27.01820
45.00000	1.00000	8.00000	32.95600
45.00000	2.00000	4.00000	35.72660
44.00000	2.00000	5.00000	22.36450
43.00000	2.00000	6.00000	21.73050
42.00000	2.00000	7.00000	19.29540
40.00000	3.00000	6.00000	26.31090
38.50000	3.00000	7.00000	33.06690
37.00000	3.00000	8.00000	50.33410
37.00000	4.00000	6.00000	51.59310
47.50000	1.00000	1.00000	10.47350
47.00000	1.00000	2.00000	11.37240
46.50000	1.00000	3.00000	11.47480
46.00000	1.00000	4.00000	15.31130
45.50000	1.00000	5.00000	20.50340
45.00000	1.00000	6.00000	21.12930
44.50000	1.00000	7.00000	26.21090
44.00000	1.00000	8.00000	25.09400
44.00000	2.00000	4.00000	25.15330
43.00000	2.00000	5.00000	22.65750
41.00000	2.00000	7.00000	20.92940
40.00000	2.00000	8.00000	12.75830
39.00000	3.00000	6.00000	24.66410
37.50000	3.00000	7.00000	33.52560
36.00000	3.00000	8.00000	50.69180
46.50000	1.00000	1.00000	16.11190
46.00000	1.00000	2.00000	17.00500
45.50000	1.00000	3.00000	20.96790
45.00000	1.00000	4.00000	26.93860
44.50000	1.00000	5.00000	27.41410
44.00000	1.00000	6.00000	34.75350
43.50000	1.00000	7.00000	34.37190
43.00000	1.00000	8.00000	22.76390
43.00000	2.00000	4.00000	19.77440
42.00000	2.00000	5.00000	17.28740
41.00000	2.00000	6.00000	17.18470
40.00000	2.00000	7.00000	16.02790
39.00000	2.00000	8.00000	22.18720
36.50000	3.00000	7.00000	36.88550
35.00000	4.00000	6.00000	46.96810
33.00000	4.00000	7.00000	52.26320
31.00000	4.00000	8.00000	49.37260
45.50000	1.00000	1.00000	16.31800

45.00000	1.00000	2.00000	18.80970
44.50000	1.00000	3.00000	25.77420
44.00000	1.00000	4.00000	24.47890
43.50000	1.00000	5.00000	30.21180
43.00000	1.00000	6.00000	30.48790
42.50000	1.00000	7.00000	21.19200
42.00000	2.00000	4.00000	19.43620
40.00000	2.00000	6.00000	16.98120
39.00000	2.00000	7.00000	21.67510
38.00000	2.00000	8.00000	24.39850
37.00000	3.00000	6.00000	27.10730
34.00000	3.00000	8.00000	33.70000
35.50000	3.00000	7.00000	42.85730
34.00000	4.00000	6.00000	39.52190
28.50000	5.00000	7.00000	72.79740
44.50000	1.00000	1.00000	21.52730
44.00000	1.00000	2.00000	36.34430
43.50000	1.00000	3.00000	33.63620
43.00000	1.00000	4.00000	41.45680
42.50000	1.00000	5.00000	41.85970
42.00000	1.00000	6.00000	28.84000
41.50000	1.00000	7.00000	24.28700
41.00000	1.00000	8.00000	25.51310
41.00000	2.00000	4.00000	20.50430
40.00000	2.00000	5.00000	19.22390
39.00000	2.00000	6.00000	18.30000
38.00000	2.00000	7.00000	24.02650
37.00000	2.00000	8.00000	25.07180
36.00000	3.00000	6.00000	34.44910
34.50000	3.00000	7.00000	52.58040
33.00000	4.00000	6.00000	43.59410
31.00000	4.00000	7.00000	54.25080
27.50000	5.00000	7.00000	81.82310
43.50000	1.00000	1.00000	28.14460
43.00000	1.00000	2.00000	30.57240
42.50000	1.00000	3.00000	38.58300
42.00000	1.00000	4.00000	40.15700
41.50000	1.00000	5.00000	27.53730
41.00000	1.00000	6.00000	23.12570
40.00000	2.00000	4.00000	18.22880
39.00000	2.00000	5.00000	22.63860
36.00000	2.00000	8.00000	27.93840
35.00000	3.00000	6.00000	39.08510
33.50000	3.00000	7.00000	50.13160
32.00000	3.00000	8.00000	49.13040
32.00000	4.00000	6.00000	52.01410

30.00000	4.00000	7.00000	52.53050
28.00000	4.00000	8.00000	76.35990
26.50000	5.00000	7.00000	72.20650
42.50000	1.00000	1.00000	28.01620
42.00000	1.00000	2.00000	41.44120
41.50000	1.00000	3.00000	46.54670
41.00000	1.00000	4.00000	33.13370
40.50000	1.00000	5.00000	27.33240
40.00000	1.00000	6.00000	24.92620
39.50000	1.00000	7.00000	25.72240
39.00000	1.00000	8.00000	20.29210
39.00000	2.00000	4.00000	22.13140
38.00000	2.00000	5.00000	18.04780
37.00000	2.00000	6.00000	25.53580
36.00000	2.00000	7.00000	25.98900
35.00000	2.00000	8.00000	35.22520
34.00000	3.00000	6.00000	51.80210
32.50000	3.00000	7.00000	43.63160
31.00000	4.00000	6.00000	58.85040
41.50000	1.00000	1.00000	38.00450
41.00000	1.00000	2.00000	51.64260
40.50000	1.00000	3.00000	38.96020
40.00000	1.00000	4.00000	31.91870
39.50000	1.00000	5.00000	34.48840
39.00000	1.00000	6.00000	18.45910
38.50000	1.00000	7.00000	21.46340
38.00000	1.00000	8.00000	28.33500
38.00000	2.00000	4.00000	24.36400
37.00000	2.00000	5.00000	22.78770
36.00000	2.00000	6.00000	28.36490
35.00000	2.00000	7.00000	30.15730
34.00000	2.00000	8.00000	42.71600
33.00000	3.00000	6.00000	58.69990
31.50000	3.00000	7.00000	48.22840
24.50000	5.00000	7.00000	60.84400
40.50000	1.00000	1.00000	51.43630
40.00000	1.00000	2.00000	43.21740
39.50000	1.00000	3.00000	33.32860
39.00000	1.00000	4.00000	32.57780
38.50000	1.00000	5.00000	22.12280
38.00000	1.00000	6.00000	18.87790
37.50000	1.00000	7.00000	25.46060
37.00000	1.00000	8.00000	17.22680
37.00000	2.00000	4.00000	18.50990
36.00000	2.00000	5.00000	24.91060
35.00000	2.00000	6.00000	25.50650

34.00000	2.00000	7.00000	35.69860
33.00000	2.00000	8.00000	42.07010
32.00000	3.00000	6.00000	55.01700
30.50000	3.00000	7.00000	56.16020
29.00000	3.00000	8.00000	67.59400
23.50000	5.00000	7.00000	59.87380
39.50000	1.00000	1.00000	51.13850
39.00000	1.00000	2.00000	41.79080
38.50000	1.00000	3.00000	41.60190
38.00000	1.00000	4.00000	24.89090
37.50000	1.00000	5.00000	20.95890
37.00000	1.00000	6.00000	26.50740
36.50000	1.00000	7.00000	17.81110
36.00000	1.00000	8.00000	16.76730
36.00000	2.00000	4.00000	18.91110
35.00000	2.00000	5.00000	23.71570
34.00000	2.00000	6.00000	24.82720
33.00000	2.00000	7.00000	35.26460
32.00000	2.00000	8.00000	55.33770
31.00000	3.00000	6.00000	42.44280
29.50000	3.00000	7.00000	58.33710
38.50000	1.00000	1.00000	48.21280
38.00000	1.00000	2.00000	51.34050
37.50000	1.00000	3.00000	29.51340
37.00000	1.00000	4.00000	20.92330
36.50000	1.00000	5.00000	26.05320
36.00000	1.00000	6.00000	16.56470
35.00000	1.00000	8.00000	18.41060
35.00000	2.00000	4.00000	20.74340
34.00000	2.00000	5.00000	21.55460
33.00000	2.00000	6.00000	28.91730
32.00000	2.00000	7.00000	35.11540
31.00000	2.00000	8.00000	53.97200
30.00000	3.00000	6.00000	40.74030
28.50000	3.00000	7.00000	57.31890
27.00000	3.00000	8.00000	52.86470
27.00000	4.00000	6.00000	54.37650
25.00000	4.00000	7.00000	92.49240
23.00000	4.00000	8.00000	65.54940
37.50000	1.00000	1.00000	45.85400
37.00000	1.00000	2.00000	27.36530
36.50000	1.00000	3.00000	16.04930
36.00000	1.00000	4.00000	18.69520
35.50000	1.00000	5.00000	11.36010
35.00000	1.00000	6.00000	8.67595
34.00000	1.00000	8.00000	12.26040

34.00000	2.00000	4.00000	15.66280
33.00000	2.00000	5.00000	15.84890
32.00000	2.00000	6.00000	23.55130
31.00000	2.00000	7.00000	36.84220
30.00000	2.00000	8.00000	24.61620
29.00000	3.00000	6.00000	39.74950
27.50000	3.00000	7.00000	49.42230
24.00000	4.00000	7.00000	83.56500
36.50000	1.00000	1.00000	39.58000
36.00000	1.00000	2.00000	21.30060
35.50000	1.00000	3.00000	22.41200
35.00000	1.00000	4.00000	12.56130
34.50000	1.00000	5.00000	9.25608
34.00000	1.00000	6.00000	10.64060
33.50000	1.00000	7.00000	11.69470
33.00000	2.00000	4.00000	11.18010
32.00000	2.00000	5.00000	15.06740
29.00000	2.00000	8.00000	18.88290
23.00000	4.00000	7.00000	66.67140
21.00000	4.00000	8.00000	42.67450
35.50000	1.00000	1.00000	30.42120
35.00000	1.00000	2.00000	30.76560
34.50000	1.00000	3.00000	16.65480
34.00000	1.00000	4.00000	11.50330
33.50000	1.00000	5.00000	11.65080
33.00000	1.00000	6.00000	11.97040
32.00000	1.00000	8.00000	12.67650
29.00000	2.00000	7.00000	18.22270
24.00000	4.00000	6.00000	49.45430
22.00000	4.00000	7.00000	42.71480
34.50000	1.00000	1.00000	36.15010
34.00000	1.00000	2.00000	20.32330
33.50000	1.00000	3.00000	11.13360
33.00000	1.00000	4.00000	10.05860
32.50000	1.00000	5.00000	9.90481
32.00000	1.00000	6.00000	9.88668
31.50000	1.00000	7.00000	9.46941
31.00000	2.00000	4.00000	14.00330
29.00000	2.00000	6.00000	24.86260
26.00000	3.00000	6.00000	28.33010
24.50000	3.00000	7.00000	23.73200
33.50000	1.00000	1.00000	36.62460
33.00000	1.00000	2.00000	17.83570
32.50000	1.00000	3.00000	12.24800
32.00000	1.00000	4.00000	10.68000
31.50000	1.00000	5.00000	10.18490

31.00000	1.00000	6.00000	9.36808
30.50000	1.00000	7.00000	11.02910
30.00000	1.00000	8.00000	13.89340
30.00000	2.00000	4.00000	13.00050
29.00000	2.00000	5.00000	20.88220
27.00000	2.00000	7.00000	19.11150
32.50000	1.00000	1.00000	37.33920
32.00000	1.00000	2.00000	20.80580
31.50000	1.00000	3.00000	14.62240
31.00000	1.00000	4.00000	13.45990
30.50000	1.00000	5.00000	11.73050
30.00000	1.00000	6.00000	13.51700
29.50000	1.00000	7.00000	17.32910
29.00000	2.00000	4.00000	15.35080
28.00000	2.00000	5.00000	26.40770
27.00000	2.00000	6.00000	18.01200
26.00000	2.00000	7.00000	24.26470
25.00000	2.00000	8.00000	31.26100
21.00000	4.00000	6.00000	46.75280
19.00000	4.00000	7.00000	30.70540
31.50000	1.00000	1.00000	31.18340
31.00000	1.00000	2.00000	15.62490
30.50000	1.00000	3.00000	12.42680
30.00000	1.00000	4.00000	9.52896
29.50000	1.00000	5.00000	10.18490
29.00000	1.00000	6.00000	13.02420
28.50000	1.00000	7.00000	10.84170
28.00000	1.00000	8.00000	14.23150
28.00000	2.00000	4.00000	21.77850
27.00000	2.00000	5.00000	16.64340
26.00000	2.00000	6.00000	21.13210
25.00000	2.00000	7.00000	25.03270
23.00000	3.00000	6.00000	25.15890
21.50000	3.00000	7.00000	48.47990
18.00000	4.00000	7.00000	31.81450
30.50000	1.00000	1.00000	26.84890
30.00000	1.00000	2.00000	17.25660
29.50000	1.00000	3.00000	11.36500
29.00000	1.00000	4.00000	10.12430
28.50000	1.00000	5.00000	12.20090
28.00000	1.00000	6.00000	9.52850
27.50000	1.00000	7.00000	12.46410
27.00000	1.00000	8.00000	30.59930
27.00000	2.00000	4.00000	24.00930
26.00000	2.00000	5.00000	13.50980
24.00000	2.00000	7.00000	33.97010

23.00000	2.00000	8.00000	23.92320
22.00000	3.00000	6.00000	26.11740
20.50000	3.00000	7.00000	59.42810
19.00000	4.00000	6.00000	26.94430
29.50000	1.00000	1.00000	32.71460
29.00000	1.00000	2.00000	17.20400
28.50000	1.00000	3.00000	12.73800
28.00000	1.00000	4.00000	15.37700
27.50000	1.00000	5.00000	13.35820
27.00000	1.00000	6.00000	16.30870
26.50000	1.00000	7.00000	24.15790
26.00000	1.00000	8.00000	17.88050
26.00000	2.00000	4.00000	14.76940
25.00000	2.00000	5.00000	21.75850
19.50000	3.00000	7.00000	53.09150
28.50000	1.00000	1.00000	28.65430
28.00000	1.00000	2.00000	15.04770
27.50000	1.00000	3.00000	16.72720
27.00000	1.00000	4.00000	12.34900
26.50000	1.00000	5.00000	14.40500
26.00000	1.00000	6.00000	28.34230
25.50000	1.00000	7.00000	17.09370
25.00000	1.00000	8.00000	18.89110
25.00000	2.00000	4.00000	16.81550
24.00000	2.00000	5.00000	23.41760
23.00000	2.00000	6.00000	28.34490
22.00000	2.00000	7.00000	28.34130
20.00000	3.00000	6.00000	52.34060
18.50000	3.00000	7.00000	36.57180
17.00000	3.00000	8.00000	52.09290
17.00000	4.00000	6.00000	41.61570
27.50000	1.00000	1.00000	21.41230
27.00000	1.00000	2.00000	18.90700
26.50000	1.00000	3.00000	12.31560
26.00000	1.00000	4.00000	15.60650
25.50000	1.00000	5.00000	22.57950
25.00000	1.00000	6.00000	16.01750
24.50000	1.00000	7.00000	12.65200
24.00000	1.00000	8.00000	15.52110
24.00000	2.00000	4.00000	17.03540
21.00000	2.00000	7.00000	34.50810
19.00000	3.00000	6.00000	66.65010
17.50000	3.00000	7.00000	42.93240
26.50000	1.00000	1.00000	27.28440
26.00000	1.00000	2.00000	19.46180
25.50000	1.00000	3.00000	13.48940

25.00000	1.00000	4.00000	22.91250
24.50000	1.00000	5.00000	15.67270
24.00000	1.00000	6.00000	12.21570
23.50000	1.00000	7.00000	17.55830
23.00000	1.00000	8.00000	19.13380
23.00000	2.00000	4.00000	21.21290
22.00000	2.00000	5.00000	24.19850
20.00000	2.00000	7.00000	28.04400
19.00000	2.00000	8.00000	42.14880
18.00000	3.00000	6.00000	58.30950
16.50000	3.00000	7.00000	51.67340
15.00000	3.00000	8.00000	28.75650
25.50000	1.00000	1.00000	28.10160
25.00000	1.00000	2.00000	17.47720
24.50000	1.00000	3.00000	23.18430
24.00000	1.00000	4.00000	17.05630
23.00000	1.00000	6.00000	16.99530
22.00000	1.00000	8.00000	22.15440
18.00000	2.00000	8.00000	71.42100
17.00000	3.00000	6.00000	56.69110
24.50000	1.00000	1.00000	24.94520
24.00000	1.00000	2.00000	22.52520
23.50000	1.00000	3.00000	18.21150
23.00000	1.00000	4.00000	13.96200
22.50000	1.00000	5.00000	18.76450
21.50000	1.00000	7.00000	23.87220
21.00000	2.00000	4.00000	29.72050
20.00000	2.00000	5.00000	30.09770
19.00000	2.00000	6.00000	33.26480
18.00000	2.00000	7.00000	50.04580
17.00000	2.00000	8.00000	79.60580
16.00000	3.00000	6.00000	52.24530
23.50000	1.00000	1.00000	16.21020
23.00000	1.00000	2.00000	14.36500
22.50000	1.00000	3.00000	11.50660
22.00000	1.00000	4.00000	13.61230
21.50000	1.00000	5.00000	16.26730
21.00000	1.00000	6.00000	19.29620
20.50000	1.00000	7.00000	22.64400
20.00000	1.00000	8.00000	26.72620
20.00000	2.00000	4.00000	31.01450
19.00000	2.00000	5.00000	24.55770
18.00000	2.00000	6.00000	32.19310
17.00000	2.00000	7.00000	75.54510
16.00000	2.00000	8.00000	57.38890
15.00000	3.00000	6.00000	51.55100

22.50000	1.00000	1.00000	21.93900
22.00000	1.00000	2.00000	16.45460
21.50000	1.00000	3.00000	15.60260
21.00000	1.00000	4.00000	18.49430
20.50000	1.00000	5.00000	20.46250
20.00000	1.00000	6.00000	27.69910
19.00000	1.00000	8.00000	33.66670
19.00000	2.00000	4.00000	27.59270
18.00000	2.00000	5.00000	31.09680
17.00000	2.00000	6.00000	47.19960
16.00000	2.00000	7.00000	76.92830
14.00000	3.00000	6.00000	54.13380
21.50000	1.00000	1.00000	42.61550
21.00000	1.00000	2.00000	24.65150
20.50000	1.00000	3.00000	28.68540
20.00000	1.00000	4.00000	30.82040
19.50000	1.00000	5.00000	36.85910
19.00000	1.00000	6.00000	45.35390
18.50000	1.00000	7.00000	50.62020
18.00000	1.00000	8.00000	36.28830
18.00000	2.00000	4.00000	35.74270
17.00000	2.00000	5.00000	45.10120
16.00000	2.00000	6.00000	108.21400
15.00000	2.00000	7.00000	84.29260
14.00000	2.00000	8.00000	75.46170
13.00000	3.00000	6.00000	64.55250
20.50000	1.00000	1.00000	25.33570
20.00000	1.00000	2.00000	17.49290
19.50000	1.00000	3.00000	17.56420
19.00000	1.00000	4.00000	21.41420
18.50000	1.00000	5.00000	25.33560
18.00000	1.00000	6.00000	27.42060
17.50000	1.00000	7.00000	20.60000
17.00000	1.00000	8.00000	30.84650
17.00000	2.00000	4.00000	38.85860
16.00000	2.00000	5.00000	60.18210
15.00000	2.00000	6.00000	102.51600
14.00000	2.00000	7.00000	66.72360
13.00000	2.00000	8.00000	76.94830
12.00000	3.00000	6.00000	60.57140
19.50000	1.00000	1.00000	19.41370
19.00000	1.00000	2.00000	16.82140
18.50000	1.00000	3.00000	19.16470
18.00000	1.00000	4.00000	22.52250
17.50000	1.00000	5.00000	26.81440
17.00000	1.00000	6.00000	20.40830

16.50000	1.00000	7.00000	18.80820
16.00000	1.00000	8.00000	16.25010
16.00000	2.00000	4.00000	28.63940
15.00000	2.00000	5.00000	68.66390
14.00000	2.00000	6.00000	56.05230
13.00000	2.00000	7.00000	49.98520
12.00000	2.00000	8.00000	55.49560
18.50000	1.00000	1.00000	26.76080
18.00000	1.00000	2.00000	24.87430
17.50000	1.00000	3.00000	28.38470
17.00000	1.00000	4.00000	31.91570
16.50000	1.00000	5.00000	24.66490
16.00000	1.00000	6.00000	29.87630
15.50000	1.00000	7.00000	42.56600
15.00000	2.00000	4.00000	44.06660
14.00000	2.00000	5.00000	83.21980
13.00000	2.00000	6.00000	52.32540
12.00000	2.00000	7.00000	58.68580
11.00000	2.00000	8.00000	50.83240
17.50000	1.00000	1.00000	27.73370
17.00000	1.00000	2.00000	26.80840
16.50000	1.00000	3.00000	30.35150
16.00000	1.00000	4.00000	23.58950
15.50000	1.00000	5.00000	27.68630
15.00000	1.00000	6.00000	31.68070
14.50000	1.00000	7.00000	29.28460
14.00000	1.00000	8.00000	70.85990
14.00000	2.00000	4.00000	79.85380
13.00000	2.00000	5.00000	68.68740
12.00000	2.00000	6.00000	57.28770
11.00000	2.00000	7.00000	82.25120
10.00000	2.00000	8.00000	65.97440
15.50000	1.00000	1.00000	20.60280
15.00000	1.00000	2.00000	19.52870
14.50000	1.00000	3.00000	22.19200
14.00000	1.00000	4.00000	26.40930
13.50000	1.00000	5.00000	23.91610
13.00000	1.00000	6.00000	58.99680
12.50000	1.00000	7.00000	83.18210
12.00000	1.00000	8.00000	73.14160
12.00000	2.00000	4.00000	65.43940
11.00000	2.00000	5.00000	63.91730
10.00000	2.00000	6.00000	65.17010
9.00000	2.00000	7.00000	69.25480
14.50000	1.00000	1.00000	20.30240
14.00000	1.00000	2.00000	19.53480

13.50000	1.00000	3.00000	23.26470
13.00000	1.00000	4.00000	20.82150
12.50000	1.00000	5.00000	51.35580
12.00000	1.00000	6.00000	75.41990
11.50000	1.00000	7.00000	66.71000
11.00000	1.00000	8.00000	50.43940
11.00000	2.00000	4.00000	55.50810
10.00000	2.00000	5.00000	67.87440
9.00000	2.00000	6.00000	48.55300
13.50000	1.00000	1.00000	15.67910
13.00000	1.00000	2.00000	19.09500
12.50000	1.00000	3.00000	16.15180
12.00000	1.00000	4.00000	39.11990
11.50000	1.00000	5.00000	61.49600
11.00000	1.00000	6.00000	57.75570
10.50000	1.00000	7.00000	37.82500
10.00000	1.00000	8.00000	55.89780
10.00000	2.00000	4.00000	52.14810
9.00000	2.00000	5.00000	69.90190
8.00000	2.00000	6.00000	53.80210
12.50000	1.00000	1.00000	13.69470
12.00000	1.00000	2.00000	11.08750
11.50000	1.00000	3.00000	25.92420
11.00000	1.00000	4.00000	38.69950
10.50000	1.00000	5.00000	35.87170
10.00000	1.00000	6.00000	32.32510
9.50000	1.00000	7.00000	30.82900
9.00000	1.00000	8.00000	39.83500
9.00000	2.00000	4.00000	48.32000
8.00000	2.00000	5.00000	34.81210
11.50000	1.00000	1.00000	13.61650
11.00000	1.00000	2.00000	23.78570
10.50000	1.00000	3.00000	41.48080
10.00000	1.00000	4.00000	45.66270
9.50000	1.00000	5.00000	32.81450
9.00000	1.00000	6.00000	40.30830
8.50000	1.00000	7.00000	39.57770
8.00000	1.00000	8.00000	51.58150
8.00000	2.00000	4.00000	44.43790
7.00000	2.00000	5.00000	30.70150
10.50000	1.00000	1.00000	17.36970
10.00000	1.00000	2.00000	37.95430
9.50000	1.00000	3.00000	38.75810
9.00000	1.00000	4.00000	32.14310
8.50000	1.00000	5.00000	39.20240
8.00000	1.00000	6.00000	37.85870

7.50000	1.00000	7.00000	68.81110
7.00000	2.00000	4.00000	32.16100
9.50000	1.00000	1.00000	21.30890
9.00000	1.00000	2.00000	25.99500
8.50000	1.00000	3.00000	23.49480
8.00000	1.00000	4.00000	27.56330
7.50000	1.00000	5.00000	27.66380
7.00000	1.00000	6.00000	47.77780
6.50000	1.00000	7.00000	36.53070
6.00000	1.00000	8.00000	27.25840
8.50000	1.00000	1.00000	35.09300
8.00000	1.00000	2.00000	35.69540
7.50000	1.00000	3.00000	43.73880
7.00000	1.00000	4.00000	46.24570
6.50000	1.00000	5.00000	81.15640
6.00000	1.00000	6.00000	58.26790
5.50000	1.00000	7.00000	40.41920
5.00000	1.00000	8.00000	93.38600
7.50000	1.00000	1.00000	28.08340
7.00000	1.00000	2.00000	33.31230
6.50000	1.00000	3.00000	39.97670
6.00000	1.00000	4.00000	69.48880
5.50000	1.00000	5.00000	54.19340
5.00000	1.00000	6.00000	39.45680
4.50000	1.00000	7.00000	90.13100
6.50000	1.00000	1.00000	17.74970
6.00000	1.00000	2.00000	21.42890
5.50000	1.00000	3.00000	42.71040
5.00000	1.00000	4.00000	30.78660
4.50000	1.00000	5.00000	24.02810
4.00000	1.00000	6.00000	59.68240
5.50000	1.00000	1.00000	11.06720
5.00000	1.00000	2.00000	24.36380
4.50000	1.00000	3.00000	18.36810
4.00000	1.00000	4.00000	14.29930
3.50000	1.00000	5.00000	33.03140
4.50000	1.00000	1.00000	22.18860
4.00000	1.00000	2.00000	22.13740
3.50000	1.00000	3.00000	16.53710
3.00000	1.00000	4.00000	40.34650
3.50000	1.00000	1.00000	13.01340
3.00000	1.00000	2.00000	10.79170
2.50000	1.00000	3.00000	28.07610
2.50000	1.00000	1.00000	9.41685
2.00000	1.00000	2.00000	28.08500
1.50000	1.00000	1.00000	14.43330

0
0
0

Sting/Swift prg: COL7_tri

1.00000

3

580

1

0

61.50000	1.00000	1.00000	35.17290
61.00000	1.00000	2.00000	24.32910
60.50000	1.00000	3.00000	21.69600
60.00000	1.00000	4.00000	15.84980
58.50000	1.00000	7.00000	33.02230
60.50000	1.00000	1.00000	17.86490
60.00000	1.00000	2.00000	15.37600
59.50000	1.00000	3.00000	11.81050
58.00000	1.00000	6.00000	23.29700
57.50000	1.00000	7.00000	31.53170
57.00000	1.00000	8.00000	30.04630
57.00000	2.00000	4.00000	39.25200
56.00000	2.00000	5.00000	28.50610
55.00000	2.00000	6.00000	29.44060
53.00000	2.00000	8.00000	50.13380
59.50000	1.00000	1.00000	25.44610
59.00000	1.00000	2.00000	15.39100
57.50000	1.00000	5.00000	33.21380
56.00000	2.00000	4.00000	35.84820
55.00000	2.00000	5.00000	32.18250
54.00000	2.00000	6.00000	37.72960
49.50000	3.00000	7.00000	61.42200
58.50000	1.00000	1.00000	21.50750
57.00000	1.00000	4.00000	34.46790
56.50000	1.00000	5.00000	49.11320
55.00000	2.00000	4.00000	36.36310
54.00000	2.00000	5.00000	48.91300
53.00000	2.00000	6.00000	43.89550
52.00000	2.00000	7.00000	58.26430
51.00000	2.00000	8.00000	64.10670
45.00000	4.00000	7.00000	39.17540
56.50000	1.00000	3.00000	38.05560
56.00000	1.00000	4.00000	45.26040
55.00000	1.00000	6.00000	51.14860
54.50000	1.00000	7.00000	22.73110
53.00000	2.00000	5.00000	57.91700

46.00000	4.00000	6.00000	59.93680
38.00000	5.00000	8.00000	110.89600
56.00000	1.00000	2.00000	29.74520
55.50000	1.00000	3.00000	41.39480
55.00000	1.00000	4.00000	41.16970
54.50000	1.00000	5.00000	54.28550
54.00000	1.00000	6.00000	39.40200
53.50000	1.00000	7.00000	56.00260
53.00000	1.00000	8.00000	33.78710
53.00000	2.00000	4.00000	42.31910
52.00000	2.00000	5.00000	44.36990
51.00000	2.00000	6.00000	61.54280
50.00000	2.00000	7.00000	80.66060
49.00000	2.00000	8.00000	64.93910
46.50000	3.00000	7.00000	49.06600
41.00000	4.00000	8.00000	59.24270
36.00000	6.00000	7.00000	127.59800
51.00000	2.00000	4.00000	83.29840
50.00000	2.00000	5.00000	112.04300
49.00000	2.00000	6.00000	149.00200
46.00000	3.00000	6.00000	136.30800
43.00000	4.00000	6.00000	73.42620
35.00000	5.00000	8.00000	234.28600
53.50000	1.00000	1.00000	81.38880
53.00000	1.00000	2.00000	87.61730
52.50000	1.00000	3.00000	80.06220
52.00000	1.00000	4.00000	77.68690
51.50000	1.00000	5.00000	92.66500
51.00000	1.00000	6.00000	109.42000
50.50000	1.00000	7.00000	93.64750
50.00000	1.00000	8.00000	107.28000
45.00000	3.00000	6.00000	76.74780
43.50000	3.00000	7.00000	139.09200
40.00000	4.00000	7.00000	119.94700
52.50000	1.00000	1.00000	80.26800
52.00000	1.00000	2.00000	70.35320
51.50000	1.00000	3.00000	75.66830
51.00000	1.00000	4.00000	94.37140
50.50000	1.00000	5.00000	114.92800
50.00000	1.00000	6.00000	96.78420
49.50000	1.00000	7.00000	115.63100
49.00000	1.00000	8.00000	129.96300
49.00000	2.00000	4.00000	141.91701
48.00000	2.00000	5.00000	196.30701
47.00000	2.00000	6.00000	157.89600
46.00000	2.00000	7.00000	148.90401

45.00000	2.00000	8.00000	264.04700
41.00000	4.00000	6.00000	144.93401
35.50000	5.00000	7.00000	236.70599
33.00000	5.00000	8.00000	291.12201
51.50000	1.00000	1.00000	38.35880
51.00000	1.00000	2.00000	44.66850
50.50000	1.00000	3.00000	60.34870
50.00000	1.00000	4.00000	75.69870
41.50000	3.00000	7.00000	110.75200
50.50000	1.00000	1.00000	42.08790
50.00000	1.00000	2.00000	58.89950
49.50000	1.00000	3.00000	76.98950
49.00000	1.00000	4.00000	67.06860
48.50000	1.00000	5.00000	80.34110
48.00000	1.00000	6.00000	85.48800
47.50000	1.00000	7.00000	117.09000
47.00000	1.00000	8.00000	140.56900
37.00000	4.00000	7.00000	172.64400
35.00000	4.00000	8.00000	238.17599
49.50000	1.00000	1.00000	37.74280
49.00000	1.00000	2.00000	50.04070
48.50000	1.00000	3.00000	43.16600
48.00000	1.00000	4.00000	43.75700
47.50000	1.00000	5.00000	52.37660
47.00000	1.00000	6.00000	71.55110
46.50000	1.00000	7.00000	85.11490
46.00000	1.00000	8.00000	103.63300
46.00000	2.00000	4.00000	117.28600
45.00000	2.00000	5.00000	90.80230
41.00000	3.00000	6.00000	82.94510
38.00000	3.00000	8.00000	130.01900
38.00000	4.00000	6.00000	132.37900
36.00000	4.00000	7.00000	194.09801
34.00000	4.00000	8.00000	191.43201
32.50000	5.00000	7.00000	378.26599
48.50000	1.00000	1.00000	45.75770
48.00000	1.00000	2.00000	39.87650
47.50000	1.00000	3.00000	34.39040
47.00000	1.00000	4.00000	40.32560
46.50000	1.00000	5.00000	54.02430
46.00000	1.00000	6.00000	77.92940
45.50000	1.00000	7.00000	74.17630
45.00000	1.00000	8.00000	55.72370
45.00000	2.00000	4.00000	72.77070
44.00000	2.00000	5.00000	68.16030
31.50000	5.00000	7.00000	339.86099

47.50000	1.00000	1.00000	44.90660
47.00000	1.00000	2.00000	32.55500
46.50000	1.00000	3.00000	35.15610
46.00000	1.00000	4.00000	47.89750
45.50000	1.00000	5.00000	62.40450
45.00000	1.00000	6.00000	70.68530
40.00000	2.00000	8.00000	50.47130
30.50000	5.00000	7.00000	248.34399
28.00000	5.00000	8.00000	173.37100
46.50000	1.00000	1.00000	39.98880
46.00000	1.00000	2.00000	37.22280
45.50000	1.00000	3.00000	46.52110
45.00000	1.00000	4.00000	60.82300
44.50000	1.00000	5.00000	72.19080
44.00000	1.00000	6.00000	66.31480
43.50000	1.00000	7.00000	58.47440
43.00000	1.00000	8.00000	50.15530
43.00000	2.00000	4.00000	56.67440
39.00000	2.00000	8.00000	53.01690
38.00000	3.00000	6.00000	70.64650
35.00000	3.00000	8.00000	90.64190
35.00000	4.00000	6.00000	102.85400
29.50000	5.00000	7.00000	198.35100
45.50000	1.00000	1.00000	36.44750
45.00000	1.00000	2.00000	39.93290
44.50000	1.00000	3.00000	51.16710
44.00000	1.00000	4.00000	60.03020
43.50000	1.00000	5.00000	55.37790
43.00000	1.00000	6.00000	49.09970
42.50000	1.00000	7.00000	43.42180
42.00000	2.00000	4.00000	60.17180
41.00000	2.00000	5.00000	61.86000
39.00000	2.00000	7.00000	54.76820
38.00000	2.00000	8.00000	51.56510
35.50000	3.00000	7.00000	68.73660
34.00000	3.00000	8.00000	99.92900
32.00000	4.00000	7.00000	113.64700
26.00000	5.00000	8.00000	144.35201
44.50000	1.00000	1.00000	38.54090
44.00000	1.00000	2.00000	47.54820
43.50000	1.00000	3.00000	62.22520
43.00000	1.00000	4.00000	62.34000
42.50000	1.00000	5.00000	55.95400
42.00000	1.00000	6.00000	49.24570
41.50000	1.00000	7.00000	60.87840
41.00000	1.00000	8.00000	66.14410

33.00000	3.00000	8.00000	103.67500
43.50000	1.00000	1.00000	33.09080
43.00000	1.00000	2.00000	46.15650
42.50000	1.00000	3.00000	49.58510
42.00000	1.00000	4.00000	46.94560
41.50000	1.00000	5.00000	41.51640
41.00000	1.00000	6.00000	52.36090
39.00000	2.00000	5.00000	44.41410
37.00000	2.00000	7.00000	55.11210
36.00000	2.00000	8.00000	69.23140
28.00000	4.00000	8.00000	163.23801
42.50000	1.00000	1.00000	49.45840
42.00000	1.00000	2.00000	54.76590
41.50000	1.00000	3.00000	50.75620
41.00000	1.00000	4.00000	45.71050
40.50000	1.00000	5.00000	58.66920
40.00000	1.00000	6.00000	61.11250
39.50000	1.00000	7.00000	86.85270
39.00000	1.00000	8.00000	40.40060
38.00000	2.00000	5.00000	56.83190
37.00000	2.00000	6.00000	54.73520
36.00000	2.00000	7.00000	65.54550
35.00000	2.00000	8.00000	77.60690
34.00000	3.00000	6.00000	72.67160
32.50000	3.00000	7.00000	105.61500
31.00000	3.00000	8.00000	125.53900
31.00000	4.00000	6.00000	117.52700
29.00000	4.00000	7.00000	215.05901
41.50000	1.00000	1.00000	56.49210
41.00000	1.00000	2.00000	47.70980
40.50000	1.00000	3.00000	40.81230
39.50000	1.00000	5.00000	59.31380
39.00000	1.00000	6.00000	76.02150
38.50000	1.00000	7.00000	37.50940
38.00000	1.00000	8.00000	47.15140
38.00000	2.00000	4.00000	52.21680
37.00000	2.00000	5.00000	63.00770
36.00000	2.00000	6.00000	63.41370
35.00000	2.00000	7.00000	77.79660
31.50000	3.00000	7.00000	111.70400
30.00000	4.00000	6.00000	121.58800
28.00000	4.00000	7.00000	256.84201
40.50000	1.00000	1.00000	71.43910
37.00000	2.00000	4.00000	64.84680
36.00000	2.00000	5.00000	60.42030
33.00000	2.00000	8.00000	79.44450

27.00000	4.00000	7.00000	228.34200
39.50000	1.00000	1.00000	41.37290
39.00000	1.00000	2.00000	49.98340
38.50000	1.00000	3.00000	44.15150
36.00000	1.00000	8.00000	51.18670
36.00000	2.00000	4.00000	54.80700
35.00000	2.00000	5.00000	56.39860
31.00000	3.00000	6.00000	102.15200
28.00000	4.00000	6.00000	152.59100
26.00000	4.00000	7.00000	229.75999
24.00000	4.00000	8.00000	175.42300
38.50000	1.00000	1.00000	61.37080
38.00000	1.00000	2.00000	51.78190
35.00000	1.00000	8.00000	51.84340
35.00000	2.00000	4.00000	49.39190
34.00000	2.00000	5.00000	62.09820
33.00000	2.00000	6.00000	71.21140
32.00000	2.00000	7.00000	66.09530
30.00000	3.00000	6.00000	92.52440
27.00000	3.00000	8.00000	179.13200
23.00000	4.00000	8.00000	153.43500
37.50000	1.00000	1.00000	43.97750
37.00000	1.00000	2.00000	39.91660
35.50000	1.00000	5.00000	42.05540
35.00000	1.00000	6.00000	48.60940
34.50000	1.00000	7.00000	43.93400
34.00000	1.00000	8.00000	46.30660
34.00000	2.00000	4.00000	53.78260
33.00000	2.00000	5.00000	64.82170
30.00000	2.00000	8.00000	81.84810
26.00000	3.00000	8.00000	223.83400
22.00000	4.00000	8.00000	124.33900
36.50000	1.00000	1.00000	39.09870
36.00000	1.00000	2.00000	36.82190
35.50000	1.00000	3.00000	41.68730
35.00000	1.00000	4.00000	45.43230
34.50000	1.00000	5.00000	53.67230
34.00000	1.00000	6.00000	50.29870
33.50000	1.00000	7.00000	51.91120
33.00000	1.00000	8.00000	62.92510
33.00000	2.00000	4.00000	61.82040
32.00000	2.00000	5.00000	68.25410
31.00000	2.00000	6.00000	64.78680
28.00000	3.00000	6.00000	97.48640
26.50000	3.00000	7.00000	113.86200
25.00000	3.00000	8.00000	181.93800

25.00000	4.00000	6.00000	175.37601
23.00000	4.00000	7.00000	119.57900
35.50000	1.00000	1.00000	37.83940
35.00000	1.00000	2.00000	35.02320
34.50000	1.00000	3.00000	35.40060
34.00000	1.00000	4.00000	41.44600
33.50000	1.00000	5.00000	39.14110
33.00000	1.00000	6.00000	39.78770
32.50000	1.00000	7.00000	48.70280
32.00000	1.00000	8.00000	50.00820
32.00000	2.00000	4.00000	57.68610
29.00000	2.00000	7.00000	77.29940
25.50000	3.00000	7.00000	90.68200
34.50000	1.00000	1.00000	41.97630
34.00000	1.00000	2.00000	33.53080
33.50000	1.00000	3.00000	34.18330
33.00000	1.00000	4.00000	31.36100
32.50000	1.00000	5.00000	28.83290
32.00000	1.00000	6.00000	32.99090
30.00000	2.00000	5.00000	30.07440
29.00000	2.00000	6.00000	48.82750
28.00000	2.00000	7.00000	26.06650
33.50000	1.00000	1.00000	59.48000
33.00000	1.00000	2.00000	59.98890
32.50000	1.00000	3.00000	62.13620
32.00000	1.00000	4.00000	67.75130
31.50000	1.00000	5.00000	91.25580
31.00000	1.00000	6.00000	103.59400
30.50000	1.00000	7.00000	120.03000
30.00000	1.00000	8.00000	135.42101
28.00000	2.00000	6.00000	111.58600
27.00000	2.00000	7.00000	119.92500
26.00000	2.00000	8.00000	122.59400
23.50000	3.00000	7.00000	190.25900
22.00000	3.00000	8.00000	128.43900
32.50000	1.00000	1.00000	58.26980
32.00000	1.00000	2.00000	46.32870
31.50000	1.00000	3.00000	45.90870
31.00000	1.00000	4.00000	62.80860
30.50000	1.00000	5.00000	73.07220
30.00000	1.00000	6.00000	85.55060
29.50000	1.00000	7.00000	96.10190
29.00000	2.00000	4.00000	108.79000
28.00000	2.00000	5.00000	132.88400
27.00000	2.00000	6.00000	151.28300
24.00000	3.00000	6.00000	250.26401

22.50000	3.00000	7.00000	228.77200
21.00000	3.00000	8.00000	166.56300
21.00000	4.00000	6.00000	149.41800
31.50000	1.00000	1.00000	53.53330
31.00000	1.00000	2.00000	38.29120
30.50000	1.00000	3.00000	45.68110
30.00000	1.00000	4.00000	51.40460
29.50000	1.00000	5.00000	59.42420
29.00000	1.00000	6.00000	65.19630
27.00000	2.00000	5.00000	113.35600
26.00000	2.00000	6.00000	132.73300
25.00000	2.00000	7.00000	149.66800
24.00000	2.00000	8.00000	128.57700
23.00000	3.00000	6.00000	451.17599
20.00000	3.00000	8.00000	203.00500
20.00000	4.00000	6.00000	162.30800
18.00000	4.00000	7.00000	185.88200
30.50000	1.00000	1.00000	41.14860
30.00000	1.00000	2.00000	42.68780
29.50000	1.00000	3.00000	43.77450
29.00000	1.00000	4.00000	49.93550
28.50000	1.00000	5.00000	54.18650
27.00000	1.00000	8.00000	56.34240
27.00000	2.00000	4.00000	76.38970
26.00000	2.00000	5.00000	79.21100
22.00000	3.00000	6.00000	260.79901
20.50000	3.00000	7.00000	144.56400
19.00000	3.00000	8.00000	138.74899
19.00000	4.00000	6.00000	167.71201
29.50000	1.00000	1.00000	41.83850
29.00000	1.00000	2.00000	37.10820
28.50000	1.00000	3.00000	39.21420
27.50000	1.00000	5.00000	67.06000
26.50000	1.00000	7.00000	39.36790
26.00000	2.00000	4.00000	69.29900
25.00000	2.00000	5.00000	77.22880
24.00000	2.00000	6.00000	84.63450
23.00000	2.00000	7.00000	78.13700
22.00000	2.00000	8.00000	199.06500
18.00000	4.00000	6.00000	138.32100
28.50000	1.00000	1.00000	29.89030
28.00000	1.00000	2.00000	30.57110
27.50000	1.00000	3.00000	32.20260
27.00000	1.00000	4.00000	49.34210
26.50000	1.00000	5.00000	8.40053
26.00000	1.00000	6.00000	36.87390

25.50000	1.00000	7.00000	61.41210
25.00000	1.00000	8.00000	43.12400
25.00000	2.00000	4.00000	51.09590
21.00000	2.00000	8.00000	168.05499
18.50000	3.00000	7.00000	96.52040
17.00000	3.00000	8.00000	106.71400
20.00000	3.00000	6.00000	98.63300
17.00000	4.00000	6.00000	118.78300
27.50000	1.00000	1.00000	34.05290
27.00000	1.00000	2.00000	33.22170
26.50000	1.00000	3.00000	47.77680
25.50000	1.00000	5.00000	37.59930
25.00000	1.00000	6.00000	66.10000
24.50000	1.00000	7.00000	45.40310
24.00000	1.00000	8.00000	58.11140
24.00000	2.00000	4.00000	59.60950
23.00000	2.00000	5.00000	61.66050
22.00000	2.00000	6.00000	56.75740
19.00000	3.00000	6.00000	86.23630
17.50000	3.00000	7.00000	45.23430
16.00000	3.00000	8.00000	148.89400
16.00000	4.00000	6.00000	148.29800
26.50000	1.00000	1.00000	28.55100
26.00000	1.00000	2.00000	42.34050
25.50000	1.00000	3.00000	18.68940
25.00000	1.00000	4.00000	36.20890
24.50000	1.00000	5.00000	63.06370
24.00000	1.00000	6.00000	43.70030
23.50000	1.00000	7.00000	56.48660
23.00000	1.00000	8.00000	63.11510
25.50000	1.00000	1.00000	33.85590
25.00000	1.00000	2.00000	21.34170
24.50000	1.00000	3.00000	31.33550
24.00000	1.00000	4.00000	55.16020
23.50000	1.00000	5.00000	39.79210
23.00000	1.00000	6.00000	51.36860
22.50000	1.00000	7.00000	59.16280
22.00000	2.00000	4.00000	59.04730
21.00000	2.00000	5.00000	59.04190
17.00000	3.00000	6.00000	88.15150
15.50000	3.00000	7.00000	77.84540
24.50000	1.00000	1.00000	25.39790
24.00000	1.00000	2.00000	23.10860
23.50000	1.00000	3.00000	42.32480
23.00000	1.00000	4.00000	31.73440
22.00000	1.00000	6.00000	47.43910

20.00000	2.00000	5.00000	80.74520
19.00000	2.00000	6.00000	130.84801
16.00000	3.00000	6.00000	102.74800
23.50000	1.00000	1.00000	13.33620
23.00000	1.00000	2.00000	21.12640
22.50000	1.00000	3.00000	14.62780
22.00000	1.00000	4.00000	13.76820
21.50000	1.00000	5.00000	11.49050
20.00000	2.00000	4.00000	11.62140
18.00000	2.00000	6.00000	51.96700
17.00000	2.00000	7.00000	31.62920
22.50000	1.00000	1.00000	31.45220
22.00000	1.00000	2.00000	33.24840
21.50000	1.00000	3.00000	49.98130
21.00000	1.00000	4.00000	67.14170
19.50000	1.00000	7.00000	94.03240
19.00000	1.00000	8.00000	94.89820
19.00000	2.00000	4.00000	87.56750
18.00000	2.00000	5.00000	150.14799
17.00000	2.00000	6.00000	99.11280
16.00000	2.00000	7.00000	78.15640
15.00000	2.00000	8.00000	84.06980
21.50000	1.00000	1.00000	23.44170
21.00000	1.00000	2.00000	33.54030
20.50000	1.00000	3.00000	44.23370
19.00000	1.00000	6.00000	59.45040
18.50000	1.00000	7.00000	58.66140
18.00000	1.00000	8.00000	153.95799
18.00000	2.00000	4.00000	212.27499
17.00000	2.00000	5.00000	217.77200
16.00000	2.00000	6.00000	134.90900
15.00000	2.00000	7.00000	146.67300
14.00000	2.00000	8.00000	131.35699
13.00000	3.00000	6.00000	105.14100
20.50000	1.00000	1.00000	30.16250
20.00000	1.00000	2.00000	42.70100
18.50000	1.00000	5.00000	51.16530
18.00000	1.00000	6.00000	59.88640
17.50000	1.00000	7.00000	171.47301
17.00000	1.00000	8.00000	165.74699
17.00000	2.00000	4.00000	197.92300
16.00000	2.00000	5.00000	131.21201
15.00000	2.00000	6.00000	109.04000
14.00000	2.00000	7.00000	116.16700
13.00000	2.00000	8.00000	108.69300
12.00000	3.00000	6.00000	181.36600

19.50000	1.00000	1.00000	27.23990
18.00000	1.00000	4.00000	31.57160
17.50000	1.00000	5.00000	36.61240
17.00000	1.00000	6.00000	102.40400
16.50000	1.00000	7.00000	83.50510
16.00000	1.00000	8.00000	145.21001
16.00000	2.00000	4.00000	157.82800
15.00000	2.00000	5.00000	98.56490
14.00000	2.00000	6.00000	98.13910
13.00000	2.00000	7.00000	91.11970
12.00000	2.00000	8.00000	103.66600
17.50000	1.00000	3.00000	37.19770
17.00000	1.00000	4.00000	39.72730
16.50000	1.00000	5.00000	106.08200
16.00000	1.00000	6.00000	105.50800
15.50000	1.00000	7.00000	173.14400
15.00000	1.00000	8.00000	98.03160
15.00000	2.00000	4.00000	93.47190
14.00000	2.00000	5.00000	77.24780
13.00000	2.00000	6.00000	78.43540
12.00000	2.00000	7.00000	69.59580
17.00000	1.00000	2.00000	25.58590
16.50000	1.00000	3.00000	31.85500
16.00000	1.00000	4.00000	83.20040
15.50000	1.00000	5.00000	85.26740
15.00000	1.00000	6.00000	147.80000
14.50000	1.00000	7.00000	92.71460
14.00000	1.00000	8.00000	90.14200
14.00000	2.00000	4.00000	81.40750
13.00000	2.00000	5.00000	83.30550
12.00000	2.00000	6.00000	71.39380
11.00000	2.00000	7.00000	102.39400
10.00000	2.00000	8.00000	110.26200
12.00000	2.00000	4.00000	68.53220
11.00000	2.00000	5.00000	55.80640
10.00000	2.00000	6.00000	43.05440
9.00000	2.00000	7.00000	126.61000
14.50000	1.00000	1.00000	23.68940
14.00000	1.00000	2.00000	29.66230
13.50000	1.00000	3.00000	69.24080
13.00000	1.00000	4.00000	48.31630
12.50000	1.00000	5.00000	47.06180
12.00000	1.00000	6.00000	39.76660
11.50000	1.00000	7.00000	37.48010
11.00000	1.00000	8.00000	47.98020
13.50000	1.00000	1.00000	16.22910

13.00000	1.00000	2.00000	44.24890
12.50000	1.00000	3.00000	34.74650
12.00000	1.00000	4.00000	36.03450
11.50000	1.00000	5.00000	29.55370
11.00000	1.00000	6.00000	34.77880
10.50000	1.00000	7.00000	26.49460
10.00000	1.00000	8.00000	36.01810
10.00000	2.00000	4.00000	36.11420
9.00000	2.00000	5.00000	60.23200
8.00000	2.00000	6.00000	17.28440
12.50000	1.00000	1.00000	75.48740
12.00000	1.00000	2.00000	74.44200
11.50000	1.00000	3.00000	83.97010
11.00000	1.00000	4.00000	68.38430
10.50000	1.00000	5.00000	78.15350
10.00000	1.00000	6.00000	92.10020
9.50000	1.00000	7.00000	70.72560
9.00000	1.00000	8.00000	79.71870
9.00000	2.00000	4.00000	58.42430
8.00000	2.00000	5.00000	77.47840
11.50000	1.00000	1.00000	40.48450
11.00000	1.00000	2.00000	53.88070
10.50000	1.00000	3.00000	46.97570
10.00000	1.00000	4.00000	56.17020
9.50000	1.00000	5.00000	58.75470
9.00000	1.00000	6.00000	54.80850
8.50000	1.00000	7.00000	52.86010
8.00000	1.00000	8.00000	52.30680
8.00000	2.00000	4.00000	72.50250
7.00000	2.00000	5.00000	85.54390
10.50000	1.00000	1.00000	45.15340
10.00000	1.00000	2.00000	51.77710
9.50000	1.00000	3.00000	68.91590
9.00000	1.00000	4.00000	84.78340
8.50000	1.00000	5.00000	82.77230
8.00000	1.00000	6.00000	82.77540
7.50000	1.00000	7.00000	97.79590
7.00000	1.00000	8.00000	94.33470
7.00000	2.00000	4.00000	94.17990
9.50000	1.00000	1.00000	26.16110
9.00000	1.00000	2.00000	40.25140
8.50000	1.00000	3.00000	56.92740
8.00000	1.00000	4.00000	58.18440
7.50000	1.00000	5.00000	59.56010
7.00000	1.00000	6.00000	69.37110
6.50000	1.00000	7.00000	93.60980

6.00000	1.00000	8.00000	99.62520
6.00000	2.00000	4.00000	115.22500
8.50000	1.00000	1.00000	19.59200
8.00000	1.00000	2.00000	33.91410
7.50000	1.00000	3.00000	40.63530
7.00000	1.00000	4.00000	42.19130
6.50000	1.00000	5.00000	52.48660
6.00000	1.00000	6.00000	66.25510
5.50000	1.00000	7.00000	67.71080
5.00000	1.00000	8.00000	75.97060
7.50000	1.00000	1.00000	17.56690
7.00000	1.00000	2.00000	22.57570
6.50000	1.00000	3.00000	28.68980
6.00000	1.00000	4.00000	29.58830
5.50000	1.00000	5.00000	41.19050
5.00000	1.00000	6.00000	45.87560
4.50000	1.00000	7.00000	46.66680
6.50000	1.00000	1.00000	18.24570
6.00000	1.00000	2.00000	21.97820
5.50000	1.00000	3.00000	25.94550
5.00000	1.00000	4.00000	30.80640
4.50000	1.00000	5.00000	38.17140
4.00000	1.00000	6.00000	38.83660
5.50000	1.00000	1.00000	19.86910
5.00000	1.00000	2.00000	22.80060
4.50000	1.00000	3.00000	25.95240
4.00000	1.00000	4.00000	31.09860
3.50000	1.00000	5.00000	34.29820
4.50000	1.00000	1.00000	15.95720
4.00000	1.00000	2.00000	19.28930
3.50000	1.00000	3.00000	20.56750
3.00000	1.00000	4.00000	23.01150
3.50000	1.00000	1.00000	14.09590
3.00000	1.00000	2.00000	16.02690
2.50000	1.00000	3.00000	17.80730
2.50000	1.00000	1.00000	16.17090
2.00000	1.00000	2.00000	17.16010
1.50000	1.00000	1.00000	18.57120

0

0

0

Sting/Swift prg: COL8

1.00000

3

748

1
0

61.50000	1.00000	1.00000	33.62900
61.00000	1.00000	2.00000	41.37460
60.50000	1.00000	3.00000	29.06010
60.00000	1.00000	4.00000	24.23390
59.50000	1.00000	5.00000	52.78540
59.00000	1.00000	6.00000	113.10700
58.50000	1.00000	7.00000	92.31760
58.00000	1.00000	8.00000	105.66500
60.50000	1.00000	1.00000	23.31130
60.00000	1.00000	2.00000	19.96070
59.50000	1.00000	3.00000	16.78500
59.00000	1.00000	4.00000	37.29010
58.50000	1.00000	5.00000	83.45920
58.00000	1.00000	6.00000	69.43220
57.50000	1.00000	7.00000	86.40820
57.00000	1.00000	8.00000	95.13710
57.00000	2.00000	4.00000	106.70900
56.00000	2.00000	5.00000	113.32000
55.00000	2.00000	6.00000	75.39360
54.00000	2.00000	7.00000	63.43470
53.00000	2.00000	8.00000	98.57490
59.50000	1.00000	1.00000	14.03880
59.00000	1.00000	2.00000	11.85600
58.50000	1.00000	3.00000	25.88200
58.00000	1.00000	4.00000	61.18230
57.50000	1.00000	5.00000	51.76710
57.00000	1.00000	6.00000	62.75970
56.50000	1.00000	7.00000	72.75160
56.00000	1.00000	8.00000	78.84540
56.00000	2.00000	4.00000	83.78220
55.00000	2.00000	5.00000	83.97070
54.00000	2.00000	6.00000	62.65450
53.00000	2.00000	7.00000	40.43870
52.00000	2.00000	8.00000	93.73030
58.50000	1.00000	1.00000	14.64520
58.00000	1.00000	2.00000	35.71470
57.50000	1.00000	3.00000	94.38690
57.00000	1.00000	4.00000	78.09700
56.50000	1.00000	5.00000	96.31410
56.00000	1.00000	6.00000	106.34700
55.50000	1.00000	7.00000	121.56500
55.00000	1.00000	8.00000	119.00300
55.00000	2.00000	4.00000	107.98900
54.00000	2.00000	5.00000	77.19710

53.00000	2.00000	6.00000	66.43740
52.00000	2.00000	7.00000	100.96100
50.00000	3.00000	6.00000	102.74000
48.50000	3.00000	7.00000	88.53610
47.00000	3.00000	8.00000	118.63200
45.00000	4.00000	7.00000	118.73800
57.50000	1.00000	1.00000	14.95170
57.00000	1.00000	2.00000	48.83920
56.50000	1.00000	3.00000	44.87870
56.00000	1.00000	4.00000	57.63460
55.50000	1.00000	5.00000	65.66680
55.00000	1.00000	6.00000	75.22300
54.50000	1.00000	7.00000	76.74430
54.00000	2.00000	4.00000	93.78260
53.00000	2.00000	5.00000	65.85690
52.00000	2.00000	6.00000	72.23530
51.00000	2.00000	7.00000	118.29800
50.00000	2.00000	8.00000	94.21330
49.00000	3.00000	6.00000	90.93640
46.00000	3.00000	8.00000	82.01680
46.00000	4.00000	6.00000	88.15210
44.00000	4.00000	7.00000	118.29200
42.00000	4.00000	8.00000	146.13000
40.50000	5.00000	7.00000	173.81400
56.50000	1.00000	1.00000	22.33430
56.00000	1.00000	2.00000	25.20540
55.50000	1.00000	3.00000	35.23640
55.00000	1.00000	4.00000	41.40550
54.50000	1.00000	5.00000	49.07860
54.00000	1.00000	6.00000	49.54330
53.50000	1.00000	7.00000	59.10440
53.00000	2.00000	4.00000	47.40820
52.00000	2.00000	5.00000	42.39230
51.00000	2.00000	6.00000	64.61030
49.00000	2.00000	8.00000	65.06090
45.00000	3.00000	8.00000	101.72000
43.00000	4.00000	7.00000	122.33600
36.00000	6.00000	7.00000	160.44901
33.00000	6.00000	8.00000	124.17700
55.50000	1.00000	1.00000	31.08850
55.00000	1.00000	2.00000	48.44680
54.50000	1.00000	3.00000	61.20300
54.00000	1.00000	4.00000	74.89390
53.50000	1.00000	5.00000	77.71070
53.00000	1.00000	6.00000	93.71710
52.50000	1.00000	7.00000	79.95720

52.00000	1.00000	8.00000	49.18180
52.00000	2.00000	4.00000	46.05340
51.00000	2.00000	5.00000	55.36040
50.00000	2.00000	6.00000	93.77840
49.00000	2.00000	7.00000	77.82370
45.50000	3.00000	7.00000	111.18200
44.00000	3.00000	8.00000	95.77320
44.00000	4.00000	6.00000	109.70100
42.00000	4.00000	7.00000	135.35300
54.50000	1.00000	1.00000	53.69500
54.00000	1.00000	2.00000	72.19270
53.50000	1.00000	3.00000	97.32560
53.00000	1.00000	4.00000	110.64000
52.50000	1.00000	5.00000	140.53700
52.00000	1.00000	6.00000	115.43200
51.50000	1.00000	7.00000	94.28290
51.00000	1.00000	8.00000	95.81030
51.00000	2.00000	4.00000	81.14140
50.00000	2.00000	5.00000	131.97400
49.00000	2.00000	6.00000	159.80499
48.00000	2.00000	7.00000	138.78300
47.00000	2.00000	8.00000	148.66701
43.00000	3.00000	8.00000	142.50999
41.00000	4.00000	7.00000	173.56300
39.00000	4.00000	8.00000	228.13600
37.50000	5.00000	7.00000	160.35899
35.00000	5.00000	8.00000	216.76300
31.00000	6.00000	8.00000	135.06400
53.50000	1.00000	1.00000	44.84250
53.00000	1.00000	2.00000	59.77440
52.50000	1.00000	3.00000	71.49070
52.00000	1.00000	4.00000	96.00140
51.50000	1.00000	5.00000	82.52960
51.00000	1.00000	6.00000	69.48580
50.50000	1.00000	7.00000	74.25740
50.00000	1.00000	8.00000	78.59840
50.00000	2.00000	4.00000	101.23400
49.00000	2.00000	5.00000	178.33800
48.00000	2.00000	6.00000	154.33099
47.00000	2.00000	7.00000	162.69099
46.00000	2.00000	8.00000	146.23900
45.00000	3.00000	6.00000	200.02400
42.00000	4.00000	6.00000	175.94099
40.00000	4.00000	7.00000	222.25999
33.00000	6.00000	7.00000	264.32001
52.50000	1.00000	1.00000	40.98930

52.00000	1.00000	2.00000	52.67670
51.50000	1.00000	3.00000	75.34450
51.00000	1.00000	4.00000	69.48850
50.50000	1.00000	5.00000	60.27430
50.00000	1.00000	6.00000	60.27510
49.50000	1.00000	7.00000	77.90620
49.00000	1.00000	8.00000	96.61110
49.00000	2.00000	4.00000	121.06000
48.00000	2.00000	5.00000	153.08600
47.00000	2.00000	6.00000	137.78300
46.00000	2.00000	7.00000	145.69701
45.00000	2.00000	8.00000	152.98000
44.00000	3.00000	6.00000	200.94200
41.00000	3.00000	8.00000	257.02200
41.00000	4.00000	6.00000	233.94901
39.00000	4.00000	7.00000	287.29599
51.50000	1.00000	1.00000	51.53080
51.00000	1.00000	2.00000	70.99030
50.50000	1.00000	3.00000	68.70810
50.00000	1.00000	4.00000	60.61690
49.50000	1.00000	5.00000	68.07270
49.00000	1.00000	6.00000	65.07210
48.50000	1.00000	7.00000	101.48300
48.00000	1.00000	8.00000	142.96001
48.00000	2.00000	4.00000	151.95000
47.00000	2.00000	5.00000	135.10699
46.00000	2.00000	6.00000	144.33299
45.00000	2.00000	7.00000	131.09700
41.50000	3.00000	7.00000	198.88901
40.00000	3.00000	8.00000	250.20399
40.00000	4.00000	6.00000	263.43100
38.00000	4.00000	7.00000	347.48599
36.00000	4.00000	8.00000	269.95700
32.00000	5.00000	8.00000	386.33301
31.00000	6.00000	7.00000	254.96001
50.50000	1.00000	1.00000	70.15020
50.00000	1.00000	2.00000	64.70480
49.50000	1.00000	3.00000	56.10080
49.00000	1.00000	4.00000	61.19240
48.50000	1.00000	5.00000	70.58290
48.00000	1.00000	6.00000	90.05590
47.50000	1.00000	7.00000	139.05400
47.00000	1.00000	8.00000	153.12399
47.00000	2.00000	4.00000	147.70399
46.00000	2.00000	5.00000	133.20599
45.00000	2.00000	6.00000	143.40800

44.00000	2.00000	7.00000	150.40601
43.00000	2.00000	8.00000	250.76900
39.00000	4.00000	6.00000	269.44699
35.00000	4.00000	8.00000	229.39400
33.50000	5.00000	7.00000	314.75400
31.00000	5.00000	8.00000	356.59900
30.00000	6.00000	7.00000	263.79501
49.50000	1.00000	1.00000	60.68230
49.00000	1.00000	2.00000	48.97230
48.50000	1.00000	3.00000	48.86030
48.00000	1.00000	4.00000	53.55480
47.50000	1.00000	5.00000	75.09410
47.00000	1.00000	6.00000	114.79600
46.50000	1.00000	7.00000	127.04700
46.00000	1.00000	8.00000	110.63700
46.00000	2.00000	4.00000	118.95800
45.00000	2.00000	5.00000	126.39700
44.00000	2.00000	6.00000	112.85100
43.00000	2.00000	7.00000	235.46600
42.00000	2.00000	8.00000	126.12800
41.00000	3.00000	6.00000	164.69200
39.50000	3.00000	7.00000	245.47000
38.00000	3.00000	8.00000	264.87601
38.00000	4.00000	6.00000	282.29700
36.00000	4.00000	7.00000	319.57001
34.00000	4.00000	8.00000	226.07300
32.50000	5.00000	7.00000	344.96100
30.00000	5.00000	8.00000	314.01599
29.00000	6.00000	7.00000	252.80701
48.50000	1.00000	1.00000	52.10880
48.00000	1.00000	2.00000	42.71210
47.50000	1.00000	3.00000	47.59310
47.00000	1.00000	4.00000	66.55100
46.50000	1.00000	5.00000	103.30900
46.00000	1.00000	6.00000	120.53900
45.50000	1.00000	7.00000	102.06200
45.00000	1.00000	8.00000	92.30610
45.00000	2.00000	4.00000	104.36900
44.00000	2.00000	5.00000	111.70400
43.00000	2.00000	6.00000	119.62400
42.00000	2.00000	7.00000	191.85500
40.00000	3.00000	6.00000	178.78200
38.50000	3.00000	7.00000	227.38300
37.00000	3.00000	8.00000	279.21799
37.00000	4.00000	6.00000	298.55600
28.00000	6.00000	7.00000	229.90401

47.50000	1.00000	1.00000	29.04290
47.00000	1.00000	2.00000	26.90200
46.50000	1.00000	3.00000	37.05820
46.00000	1.00000	4.00000	60.21360
45.50000	1.00000	5.00000	70.64870
45.00000	1.00000	6.00000	61.96330
44.50000	1.00000	7.00000	64.29310
44.00000	1.00000	8.00000	61.29650
44.00000	2.00000	4.00000	83.74970
43.00000	2.00000	5.00000	80.20170
42.00000	2.00000	6.00000	150.66400
40.00000	2.00000	8.00000	128.66000
36.00000	3.00000	8.00000	249.62700
36.00000	4.00000	6.00000	275.98801
34.00000	4.00000	7.00000	219.24500
32.00000	4.00000	8.00000	230.55800
30.50000	5.00000	7.00000	355.88599
28.00000	5.00000	8.00000	216.42000
46.50000	1.00000	1.00000	26.68930
46.00000	1.00000	2.00000	27.75640
45.50000	1.00000	3.00000	42.56440
45.00000	1.00000	4.00000	47.83250
44.50000	1.00000	5.00000	45.85860
44.00000	1.00000	6.00000	57.07870
43.50000	1.00000	7.00000	49.30810
43.00000	1.00000	8.00000	41.22170
43.00000	2.00000	4.00000	56.24040
42.00000	2.00000	5.00000	56.59780
41.00000	2.00000	6.00000	96.64550
40.00000	2.00000	7.00000	83.42560
39.00000	2.00000	8.00000	77.66460
38.00000	3.00000	6.00000	139.03500
36.50000	3.00000	7.00000	155.47701
35.00000	3.00000	8.00000	210.41499
29.50000	5.00000	7.00000	300.35599
27.00000	5.00000	8.00000	162.29201
45.50000	1.00000	1.00000	30.12880
45.00000	1.00000	2.00000	37.12480
44.50000	1.00000	3.00000	47.79800
44.00000	1.00000	4.00000	41.97070
43.50000	1.00000	5.00000	34.70800
43.00000	1.00000	6.00000	44.41240
42.50000	1.00000	7.00000	50.51580
42.00000	1.00000	8.00000	33.63820
42.00000	2.00000	4.00000	40.60270
41.00000	2.00000	5.00000	76.33150

39.00000	2.00000	7.00000	80.89590
38.00000	2.00000	8.00000	69.98370
37.00000	3.00000	6.00000	98.65450
34.00000	4.00000	6.00000	167.14600
32.00000	4.00000	7.00000	118.78700
30.00000	4.00000	8.00000	201.14200
28.50000	5.00000	7.00000	207.67000
44.50000	1.00000	1.00000	36.76330
44.00000	1.00000	2.00000	39.90590
43.50000	1.00000	3.00000	37.52150
43.00000	1.00000	4.00000	38.72880
42.50000	1.00000	5.00000	41.57810
42.00000	1.00000	6.00000	42.18930
41.50000	1.00000	7.00000	41.29310
41.00000	1.00000	8.00000	34.50450
41.00000	2.00000	4.00000	43.36180
40.00000	2.00000	5.00000	74.29150
39.00000	2.00000	6.00000	66.29980
38.00000	2.00000	7.00000	58.23510
37.00000	2.00000	8.00000	79.94330
36.00000	3.00000	6.00000	87.18590
27.50000	5.00000	7.00000	148.71899
43.50000	1.00000	1.00000	48.30870
43.00000	1.00000	2.00000	43.79650
42.50000	1.00000	3.00000	44.54250
42.00000	1.00000	4.00000	49.81780
41.50000	1.00000	5.00000	51.21600
41.00000	1.00000	6.00000	49.83040
40.50000	1.00000	7.00000	42.14040
40.00000	1.00000	8.00000	66.53050
40.00000	2.00000	4.00000	79.55150
35.00000	3.00000	6.00000	96.35140
32.00000	4.00000	6.00000	99.51430
30.00000	4.00000	7.00000	103.18800
28.00000	4.00000	8.00000	160.36900
42.50000	1.00000	1.00000	42.80540
42.00000	1.00000	2.00000	46.29370
41.50000	1.00000	3.00000	55.38760
41.00000	1.00000	4.00000	58.89240
40.50000	1.00000	5.00000	59.32620
40.00000	1.00000	6.00000	49.71500
39.50000	1.00000	7.00000	83.34840
39.00000	1.00000	8.00000	139.60400
39.00000	2.00000	4.00000	110.33900
38.00000	2.00000	5.00000	99.03730
37.00000	2.00000	6.00000	87.81810

36.00000	2.00000	7.00000	118.12200
35.00000	2.00000	8.00000	123.95100
31.00000	3.00000	8.00000	99.78450
31.00000	4.00000	6.00000	93.30000
25.50000	5.00000	7.00000	98.21020
41.50000	1.00000	1.00000	35.44680
41.00000	1.00000	2.00000	43.50000
40.50000	1.00000	3.00000	48.47960
40.00000	1.00000	4.00000	52.83220
39.50000	1.00000	5.00000	45.66370
39.00000	1.00000	6.00000	72.01710
38.50000	1.00000	7.00000	129.99200
38.00000	1.00000	8.00000	91.87720
38.00000	2.00000	4.00000	96.20850
37.00000	2.00000	5.00000	113.70600
36.00000	2.00000	6.00000	108.44600
35.00000	2.00000	7.00000	130.77400
34.00000	2.00000	8.00000	141.46500
33.00000	3.00000	6.00000	170.86400
31.50000	3.00000	7.00000	164.78500
30.00000	3.00000	8.00000	116.86300
40.50000	1.00000	1.00000	26.48570
40.00000	1.00000	2.00000	29.80720
39.50000	1.00000	3.00000	33.57290
39.00000	1.00000	4.00000	29.59730
38.50000	1.00000	5.00000	52.43440
37.00000	2.00000	4.00000	94.09260
36.00000	2.00000	5.00000	84.20980
34.00000	2.00000	7.00000	120.01600
23.50000	5.00000	7.00000	106.10800
39.50000	1.00000	1.00000	21.77580
39.00000	1.00000	2.00000	26.15940
38.50000	1.00000	3.00000	24.30000
38.00000	1.00000	4.00000	38.90170
37.50000	1.00000	5.00000	75.01040
37.00000	1.00000	6.00000	59.34560
36.50000	1.00000	7.00000	66.74180
36.00000	1.00000	8.00000	82.51410
36.00000	2.00000	4.00000	81.57280
35.00000	2.00000	5.00000	77.67920
34.00000	2.00000	6.00000	94.66260
33.00000	2.00000	7.00000	103.19100
31.00000	3.00000	6.00000	164.20900
29.50000	3.00000	7.00000	104.80600
28.00000	3.00000	8.00000	111.35200
28.00000	4.00000	6.00000	129.37900

26.00000	4.00000	7.00000	191.97701
24.00000	4.00000	8.00000	116.49600
22.50000	5.00000	7.00000	110.18600
38.50000	1.00000	1.00000	18.42340
38.00000	1.00000	2.00000	18.48940
37.50000	1.00000	3.00000	31.58650
37.00000	1.00000	4.00000	61.31770
36.50000	1.00000	5.00000	56.37770
36.00000	1.00000	6.00000	62.49380
35.50000	1.00000	7.00000	78.93630
35.00000	1.00000	8.00000	67.23800
35.00000	2.00000	4.00000	65.00450
34.00000	2.00000	5.00000	86.59970
33.00000	2.00000	6.00000	91.88980
32.00000	2.00000	7.00000	104.10400
31.00000	2.00000	8.00000	138.97501
30.00000	3.00000	6.00000	129.24699
28.50000	3.00000	7.00000	91.91520
27.00000	3.00000	8.00000	118.25000
27.00000	4.00000	6.00000	143.41400
25.00000	4.00000	7.00000	160.91200
23.00000	4.00000	8.00000	83.91170
37.50000	1.00000	1.00000	13.85690
37.00000	1.00000	2.00000	23.36300
36.50000	1.00000	3.00000	47.76060
35.50000	1.00000	5.00000	56.53410
35.00000	1.00000	6.00000	72.44380
34.50000	1.00000	7.00000	62.92790
34.00000	1.00000	8.00000	54.72490
34.00000	2.00000	4.00000	67.51470
33.00000	2.00000	5.00000	82.74060
32.00000	2.00000	6.00000	91.07820
31.00000	2.00000	7.00000	118.86700
30.00000	2.00000	8.00000	135.07100
26.00000	3.00000	8.00000	140.85100
26.00000	4.00000	6.00000	147.57899
24.00000	4.00000	7.00000	127.33800
36.50000	1.00000	1.00000	13.46640
36.00000	1.00000	2.00000	25.44000
35.50000	1.00000	3.00000	30.65990
35.00000	1.00000	4.00000	37.58350
34.50000	1.00000	5.00000	50.18830
34.00000	1.00000	6.00000	45.29690
33.50000	1.00000	7.00000	40.31230
33.00000	1.00000	8.00000	58.98620
33.00000	2.00000	4.00000	66.86380

32.00000	2.00000	5.00000	72.71780
31.00000	2.00000	6.00000	83.49030
30.00000	2.00000	7.00000	114.28300
29.00000	2.00000	8.00000	117.05800
28.00000	3.00000	6.00000	76.87190
26.50000	3.00000	7.00000	82.12880
25.00000	3.00000	8.00000	146.26100
25.00000	4.00000	6.00000	141.67101
23.00000	4.00000	7.00000	103.06200
35.50000	1.00000	1.00000	15.90930
34.50000	1.00000	3.00000	22.37160
34.00000	1.00000	4.00000	31.65610
33.50000	1.00000	5.00000	29.20090
33.00000	1.00000	6.00000	26.64590
32.50000	1.00000	7.00000	39.39400
32.00000	1.00000	8.00000	38.83290
32.00000	2.00000	4.00000	48.97250
31.00000	2.00000	5.00000	55.85640
30.00000	2.00000	6.00000	73.72690
29.00000	2.00000	7.00000	86.30430
28.00000	2.00000	8.00000	72.21580
24.00000	4.00000	6.00000	123.75900
22.00000	4.00000	7.00000	68.99570
34.50000	1.00000	1.00000	22.53200
34.00000	1.00000	2.00000	23.27710
33.50000	1.00000	3.00000	32.73450
33.00000	1.00000	4.00000	31.55910
32.50000	1.00000	5.00000	29.31920
32.00000	1.00000	6.00000	44.26490
31.50000	1.00000	7.00000	44.21300
31.00000	2.00000	4.00000	46.80450
30.00000	2.00000	5.00000	54.82060
29.00000	2.00000	6.00000	76.00240
28.00000	2.00000	7.00000	78.73150
24.50000	3.00000	7.00000	87.91340
23.00000	3.00000	8.00000	85.54590
23.00000	4.00000	6.00000	93.37770
21.00000	4.00000	7.00000	44.30250
33.50000	1.00000	1.00000	29.11140
33.00000	1.00000	2.00000	31.91800
32.50000	1.00000	3.00000	30.34050
32.00000	1.00000	4.00000	28.61660
31.50000	1.00000	5.00000	43.71850
31.00000	1.00000	6.00000	42.88840
30.50000	1.00000	7.00000	46.65520
30.00000	1.00000	8.00000	48.67280

30.00000	2.00000	4.00000	51.39060
29.00000	2.00000	5.00000	66.53920
28.00000	2.00000	6.00000	76.84550
27.00000	2.00000	7.00000	62.70310
25.00000	3.00000	6.00000	46.72090
23.50000	3.00000	7.00000	75.11050
22.00000	3.00000	8.00000	55.22510
20.00000	4.00000	7.00000	27.49170
32.50000	1.00000	1.00000	34.67290
32.00000	1.00000	2.00000	28.98590
31.50000	1.00000	3.00000	30.05280
31.00000	1.00000	4.00000	51.32780
30.50000	1.00000	5.00000	56.34440
30.00000	1.00000	6.00000	67.26420
29.50000	1.00000	7.00000	75.24130
29.00000	1.00000	8.00000	87.59260
29.00000	2.00000	4.00000	76.89970
28.00000	2.00000	5.00000	112.28400
27.00000	2.00000	6.00000	123.32300
24.00000	3.00000	6.00000	98.24120
22.50000	3.00000	7.00000	141.96001
21.00000	3.00000	8.00000	110.53600
31.50000	1.00000	1.00000	23.40310
31.00000	1.00000	2.00000	19.52660
30.50000	1.00000	3.00000	33.46310
30.00000	1.00000	4.00000	37.85030
29.50000	1.00000	5.00000	45.58760
29.00000	1.00000	6.00000	51.80210
28.50000	1.00000	7.00000	60.12670
28.00000	1.00000	8.00000	70.33710
28.00000	2.00000	4.00000	97.09850
27.00000	2.00000	5.00000	126.93500
23.00000	3.00000	6.00000	145.20799
21.50000	3.00000	7.00000	151.64200
20.00000	3.00000	8.00000	102.99800
20.00000	4.00000	6.00000	89.01330
30.50000	1.00000	1.00000	17.99270
30.00000	1.00000	2.00000	28.40830
29.50000	1.00000	3.00000	33.25400
29.00000	1.00000	4.00000	42.04160
28.50000	1.00000	5.00000	49.37510
28.00000	1.00000	6.00000	59.46510
27.50000	1.00000	7.00000	68.76080
27.00000	1.00000	8.00000	98.06180
27.00000	2.00000	4.00000	99.81700
26.00000	2.00000	5.00000	114.88000

23.00000	2.00000	8.00000	98.33450
22.00000	3.00000	6.00000	199.37300
20.50000	3.00000	7.00000	182.58400
19.00000	3.00000	8.00000	96.37160
19.00000	4.00000	6.00000	70.54860
29.50000	1.00000	1.00000	18.15100
29.00000	1.00000	2.00000	20.79540
28.50000	1.00000	3.00000	27.59650
28.00000	1.00000	4.00000	33.88950
27.50000	1.00000	5.00000	43.15200
27.00000	1.00000	6.00000	51.58670
26.50000	1.00000	7.00000	69.81660
26.00000	1.00000	8.00000	80.31010
26.00000	2.00000	4.00000	92.80130
25.00000	2.00000	5.00000	90.04630
24.00000	2.00000	6.00000	74.51790
23.00000	2.00000	7.00000	79.21650
22.00000	2.00000	8.00000	109.03500
21.00000	3.00000	6.00000	162.24100
19.50000	3.00000	7.00000	132.45100
28.50000	1.00000	1.00000	11.29870
28.00000	1.00000	2.00000	16.13350
27.50000	1.00000	3.00000	23.52270
27.00000	1.00000	4.00000	27.64150
26.50000	1.00000	5.00000	34.89350
26.00000	1.00000	6.00000	52.26960
25.50000	1.00000	7.00000	54.67430
25.00000	1.00000	8.00000	67.94590
25.00000	2.00000	4.00000	76.22630
22.00000	2.00000	7.00000	70.37650
21.00000	2.00000	8.00000	124.69100
20.00000	3.00000	6.00000	127.68400
18.50000	3.00000	7.00000	67.72210
27.50000	1.00000	1.00000	15.34900
27.00000	1.00000	2.00000	24.79930
26.50000	1.00000	3.00000	31.83610
26.00000	1.00000	4.00000	44.29330
25.50000	1.00000	5.00000	61.10870
25.00000	1.00000	6.00000	71.02530
24.50000	1.00000	7.00000	83.85180
24.00000	1.00000	8.00000	94.05550
24.00000	2.00000	4.00000	68.94850
23.00000	2.00000	5.00000	61.93760
22.00000	2.00000	6.00000	61.45630
21.00000	2.00000	7.00000	117.17800
20.00000	2.00000	8.00000	143.69600

19.00000	3.00000	6.00000	121.92000
17.50000	3.00000	7.00000	19.55200
16.00000	3.00000	8.00000	151.58000
16.00000	4.00000	6.00000	153.55299
21.00000	2.00000	6.00000	84.97070
20.00000	2.00000	7.00000	150.98300
19.00000	2.00000	8.00000	134.83600
18.00000	3.00000	6.00000	105.37800
16.50000	3.00000	7.00000	95.70750
24.50000	1.00000	3.00000	35.77040
24.00000	1.00000	4.00000	42.64960
23.50000	1.00000	5.00000	53.87050
23.00000	1.00000	6.00000	64.82540
22.50000	1.00000	7.00000	43.25060
25.00000	1.00000	2.00000	388.75000
22.00000	2.00000	4.00000	55.15750
21.00000	2.00000	5.00000	67.47510
20.00000	2.00000	6.00000	94.44980
19.00000	2.00000	7.00000	140.36501
18.00000	2.00000	8.00000	120.60700
17.00000	3.00000	6.00000	103.62000
24.00000	1.00000	2.00000	26.83560
23.50000	1.00000	3.00000	32.23190
23.00000	1.00000	4.00000	41.39180
22.50000	1.00000	5.00000	51.51960
22.00000	1.00000	6.00000	35.17460
20.00000	2.00000	5.00000	66.90490
19.00000	2.00000	6.00000	121.19400
18.00000	2.00000	7.00000	110.83600
17.00000	2.00000	8.00000	120.43200
16.00000	3.00000	6.00000	103.02200
14.50000	3.00000	7.00000	19.51860
23.50000	1.00000	1.00000	24.38000
23.00000	1.00000	2.00000	27.46150
22.50000	1.00000	3.00000	38.18180
22.00000	1.00000	4.00000	61.43840
21.50000	1.00000	5.00000	33.54680
20.00000	1.00000	8.00000	50.77010
20.00000	2.00000	4.00000	-60.96160
19.00000	2.00000	5.00000	285.87701
18.00000	2.00000	6.00000	123.70800
17.00000	2.00000	7.00000	109.13500
16.00000	2.00000	8.00000	88.60770
15.00000	3.00000	6.00000	52.08840
13.50000	3.00000	7.00000	83.18450
22.50000	1.00000	1.00000	21.93860

22.00000	1.00000	2.00000	33.95900
21.50000	1.00000	3.00000	40.66120
21.00000	1.00000	4.00000	31.67580
19.50000	1.00000	7.00000	53.10460
19.00000	2.00000	4.00000	64.38090
18.00000	2.00000	5.00000	84.00310
17.00000	2.00000	6.00000	160.04300
16.00000	2.00000	7.00000	117.93800
15.00000	2.00000	8.00000	36.69930
14.00000	3.00000	6.00000	81.24570
21.50000	1.00000	1.00000	33.60200
21.00000	1.00000	2.00000	45.49020
20.50000	1.00000	3.00000	35.89390
19.00000	1.00000	6.00000	63.17170
18.50000	1.00000	7.00000	143.81400
18.00000	1.00000	8.00000	-20.46370
17.00000	2.00000	5.00000	140.13100
16.00000	2.00000	6.00000	123.68200
15.00000	2.00000	7.00000	102.10700
14.00000	2.00000	8.00000	71.19610
13.00000	3.00000	6.00000	79.82700
20.50000	1.00000	1.00000	41.33460
20.00000	1.00000	2.00000	28.35710
18.50000	1.00000	5.00000	55.18720
17.50000	1.00000	7.00000	151.05701
17.00000	1.00000	8.00000	116.92700
17.00000	2.00000	4.00000	145.36800
16.00000	2.00000	5.00000	107.90600
15.00000	2.00000	6.00000	140.88300
13.00000	2.00000	8.00000	147.27400
12.00000	3.00000	6.00000	95.31050
19.50000	1.00000	1.00000	30.28910
18.00000	1.00000	4.00000	48.75210
17.50000	1.00000	5.00000	31.84370
17.00000	1.00000	6.00000	116.65400
16.50000	1.00000	7.00000	101.26000
16.00000	1.00000	8.00000	129.41901
16.00000	2.00000	4.00000	135.33701
15.00000	2.00000	5.00000	124.06100
14.00000	2.00000	6.00000	103.48000
13.00000	2.00000	7.00000	70.02960
12.00000	2.00000	8.00000	14.10620
17.50000	1.00000	3.00000	43.63310
17.00000	1.00000	4.00000	85.85650
16.00000	1.00000	6.00000	92.30240
15.50000	1.00000	7.00000	142.00200

15.00000	1.00000	8.00000	78.38880
15.00000	2.00000	4.00000	101.24800
14.00000	2.00000	5.00000	124.28000
17.00000	1.00000	2.00000	21.50980
16.50000	1.00000	3.00000	25.55360
16.00000	1.00000	4.00000	34.44980
15.50000	1.00000	5.00000	51.91180
15.00000	1.00000	6.00000	72.28450
14.50000	1.00000	7.00000	66.20600
14.00000	1.00000	8.00000	59.86350
14.00000	2.00000	4.00000	85.25540
13.00000	2.00000	5.00000	73.87880
12.00000	2.00000	6.00000	51.92610
11.00000	2.00000	7.00000	93.22710
10.00000	2.00000	8.00000	20.06820
12.00000	2.00000	4.00000	51.03110
11.00000	2.00000	5.00000	36.08660
10.00000	2.00000	6.00000	34.79090
14.50000	1.00000	1.00000	15.95030
14.00000	1.00000	2.00000	25.28420
13.50000	1.00000	3.00000	39.39200
13.00000	1.00000	4.00000	40.36310
12.50000	1.00000	5.00000	38.32880
12.00000	1.00000	6.00000	55.31700
11.50000	1.00000	7.00000	50.79240
13.50000	1.00000	1.00000	23.84680
13.00000	1.00000	2.00000	25.32430
12.50000	1.00000	3.00000	57.51540
12.00000	1.00000	4.00000	36.93330
11.50000	1.00000	5.00000	53.04300
11.00000	1.00000	6.00000	52.28510
10.50000	1.00000	7.00000	28.23850
10.00000	2.00000	4.00000	30.92590
9.00000	2.00000	5.00000	29.24420
8.00000	2.00000	6.00000	60.46680
12.50000	1.00000	1.00000	28.77320
12.00000	1.00000	2.00000	24.61180
11.50000	1.00000	3.00000	36.18170
11.00000	1.00000	4.00000	53.08450
10.50000	1.00000	5.00000	52.79320
10.00000	1.00000	6.00000	36.35920
9.50000	1.00000	7.00000	44.73030
9.00000	2.00000	4.00000	32.57000
8.00000	2.00000	5.00000	51.03250
11.50000	1.00000	1.00000	42.20670
11.00000	1.00000	2.00000	46.04580

10.50000	1.00000	3.00000	74.11500
10.00000	1.00000	4.00000	75.84320
9.50000	1.00000	5.00000	48.16560
9.00000	1.00000	6.00000	41.70670
8.50000	1.00000	7.00000	48.41280
8.00000	1.00000	8.00000	30.97370
8.00000	2.00000	4.00000	49.76380
7.00000	2.00000	5.00000	37.91060
10.50000	1.00000	1.00000	43.97540
10.00000	1.00000	2.00000	79.66880
9.50000	1.00000	3.00000	88.08820
9.00000	1.00000	4.00000	58.41240
8.50000	1.00000	5.00000	47.95500
8.00000	1.00000	6.00000	60.55850
7.50000	1.00000	7.00000	51.27950
7.00000	2.00000	4.00000	65.77310
9.50000	1.00000	1.00000	55.53100
9.00000	1.00000	2.00000	66.08700
8.50000	1.00000	3.00000	45.48140
8.00000	1.00000	4.00000	39.54770
7.50000	1.00000	5.00000	44.68410
7.00000	1.00000	6.00000	37.55840
6.50000	1.00000	7.00000	66.92500
6.00000	2.00000	4.00000	69.24840
8.50000	1.00000	1.00000	54.98890
8.00000	1.00000	2.00000	39.61170
7.50000	1.00000	3.00000	34.20680
7.00000	1.00000	4.00000	42.50400
6.50000	1.00000	5.00000	34.66630
6.00000	1.00000	6.00000	59.39080
5.50000	1.00000	7.00000	62.39460
5.00000	1.00000	8.00000	45.18280
7.50000	1.00000	1.00000	38.92400
7.00000	1.00000	2.00000	34.93720
6.50000	1.00000	3.00000	47.02000
6.00000	1.00000	4.00000	36.91990
5.50000	1.00000	5.00000	67.72710
5.00000	1.00000	6.00000	71.66970
4.50000	1.00000	7.00000	51.96330
6.50000	1.00000	1.00000	25.22980
6.00000	1.00000	2.00000	39.54320
5.50000	1.00000	3.00000	34.27970
5.00000	1.00000	4.00000	60.01310
4.50000	1.00000	5.00000	67.59340
4.00000	1.00000	6.00000	48.46710
5.50000	1.00000	1.00000	21.52370

5.00000	1.00000	2.00000	22.59400
4.50000	1.00000	3.00000	45.44610
4.00000	1.00000	4.00000	53.53590
3.50000	1.00000	5.00000	38.48860
4.50000	1.00000	1.00000	14.16950
4.00000	1.00000	2.00000	33.58440
3.50000	1.00000	3.00000	42.95430
3.00000	1.00000	4.00000	32.55550
3.50000	1.00000	1.00000	15.75800
3.00000	1.00000	2.00000	26.71300
2.50000	1.00000	3.00000	21.45040
2.50000	1.00000	1.00000	20.50220
2.00000	1.00000	2.00000	14.93080
1.50000	1.00000	1.00000	30.82820

0
0
0

Sting/Swift prg: COL9

10

3

619

1

0

615	10	1	14.6924
610	10	2	8.61032
605	10	3	10.1636
600	10	4	11.5155
595	10	5	12.4887
590	10	6	12.4849
605	10	1	16.7736
600	10	2	11.8088
595	10	3	9.30146
590	10	4	8.46981
585	10	5	10.0631
570	20	4	19.4378
560	20	5	24.3418
540	20	7	24.2932
595	10	1	19.3598
590	10	2	10.9846
585	10	3	7.95162
580	10	4	9.24329
565	10	7	17.2312
495	30	7	19.3978
585	10	1	18.2083
580	10	2	11.5836

575	10	3	9.27713
560	10	6	10.6608
555	10	7	14.424
550	20	4	15.3515
530	20	6	4.81325
575	10	1	23.5021
570	10	2	19.8591
555	10	5	18.999
550	10	6	22.5573
545	10	7	21.39
540	20	4	12.7136
530	20	5	28.0621
520	20	6	13.1191
565	10	1	31.7614
550	10	4	23.674
545	10	5	27.9871
540	10	6	25.7721
535	10	7	28.4709
530	10	8	20.9558
530	20	4	20.8844
520	20	5	18.0547
545	10	3	53.888
540	10	4	27.1635
520	10	8	123.114
510	20	5	14.7664
540	10	2	35.6279
535	10	3	38.4285
530	10	4	31.8627
510	10	8	21.0196
510	20	4	16.1183
500	20	5	11.4302
470	20	8	27.1542
350	50	8	43.8895
425	30	7	44.6313
355	50	7	22.77
515	10	1	55.5282
510	10	2	30.9001
505	10	3	20.5719
500	10	4	16.1542
495	10	5	16.9275
485	10	7	52.3613
310	60	7	41.6315
505	10	1	81.0917
500	10	2	36.8276
495	10	3	28.5495
490	10	4	23.737

485	10	5	36.5041
470	20	4	7.36833
450	20	6	16.0885
390	40	6	54.242
495	10	1	61.6655
490	10	2	36.2524
485	10	3	24.4133
480	10	4	17.0853
475	10	5	13.5508
460	10	8	25.7941
460	20	4	13.6031
430	20	7	129.23
410	30	6	76.7016
395	30	7	65.5655
485	10	1	58.9184
480	10	2	30.5706
475	10	3	20.554
470	10	4	16.5676
465	10	5	8.62126
460	10	6	21.8199
430	20	6	39.5817
400	30	6	60.2449
385	30	7	65.598
475	10	1	54.3817
470	10	2	30.0993
465	10	3	19.3618
460	10	4	14.6547
430	20	5	50.1844
410	20	7	62.8105
320	40	8	52.2038
465	10	1	60.2099
460	10	2	31.6612
445	10	5	15.0432
430	20	4	21.4202
420	20	5	19.6497
410	20	6	39.1453
400	20	7	71.7697
455	10	1	45.3837
450	10	2	20.4627
445	10	3	14.2292
425	10	7	47.3094
410	20	5	37.9823
390	20	7	121.242
380	20	8	69.2672
370	30	6	66.8213
355	30	7	69.521

340	30	8	69.9513
445	10	1	36.461
440	10	2	8.77422
435	10	3	5.31808
430	10	4	13.4719
425	10	5	11.7144
420	10	6	14.0591
410	10	8	22.032
370	20	8	56.136
275	50	7	63.1688
435	10	1	22.0975
430	10	2	7.83071
415	10	5	12.4359
410	10	6	16.069
405	10	7	10.393
400	20	4	34.365
390	20	5	59.8203
370	20	7	56.8592
320	40	6	47.5499
425	10	1	12.0524
420	10	2	6.91308
415	10	3	6.1996
410	10	4	11.396
395	10	7	58.6852
390	20	4	41.8955
380	20	5	26.5807
370	20	6	45.1332
340	30	6	57.2095
255	50	7	46.3055
415	10	1	6.19223
405	10	3	7.48856
400	10	4	19.6065
395	10	5	16.0345
380	10	8	31.2793
380	20	4	31.7977
370	20	5	35.9635
360	20	6	45.6499
340	20	8	37.8912
300	40	6	38.3196
280	40	7	60.0998
260	40	8	52.6599
245	50	7	42.9015
405	10	1	4.4788
400	10	2	8.62971
395	10	3	6.81881
390	10	4	9.41734

385	10	5	20.5819
380	10	6	24.123
370	10	8	27.1236
290	40	6	34.1624
395	10	1	5.41389
390	10	2	10.1046
385	10	3	8.21001
380	10	4	17.3955
375	10	5	25.1864
370	10	6	25.4445
365	10	7	25.2697
360	10	8	39.2844
360	20	4	35.1163
280	40	6	45.548
260	40	7	62.4162
385	10	1	8.09663
380	10	2	10.7231
370	10	4	25.7325
365	10	5	27.2809
360	10	6	28.9186
355	10	7	40.1658
350	10	8	34.2932
350	20	4	37.153
340	20	5	44.8059
330	20	6	38.316
320	20	7	39.5781
310	20	8	52.9326
375	10	1	12.671
370	10	2	25.2668
365	10	3	39.5092
360	10	4	45.992
355	10	5	49.255
350	10	6	68.7581
345	10	7	58.8459
340	10	8	80.3983
340	20	4	65.963
330	20	5	68.7725
320	20	6	58.2605
310	20	7	73.542
300	20	8	80.1397
290	30	6	51.989
275	30	7	51.4915
260	30	8	69.3238
365	10	1	17.3942
360	10	2	30.0171
355	10	3	36.4873

350	10	4	41.6882
345	10	5	60.1226
340	10	6	52.7547
335	10	7	72.3686
330	10	8	73.6316
330	20	4	80.2823
320	20	5	70.0398
310	20	6	73.5516
300	20	7	98.8261
290	20	8	82.1126
280	30	6	58.404
265	30	7	65.8652
250	30	8	103.708
355	10	1	25.5201
350	10	2	35.2503
345	10	3	44.107
340	10	4	68.4881
335	10	5	61.9818
330	10	6	86.4619
325	10	7	89.3383
320	10	8	97.2517
300	20	6	84.0878
290	20	7	89.5173
240	30	8	124.749
345	10	1	49.5793
340	10	2	68.533
335	10	3	115.452
330	10	4	111.154
325	10	5	161.77499
320	10	6	170.739
315	10	7	189.673
310	10	8	156.87199
310	20	4	116.881
300	20	5	116.857
290	20	6	146.153
280	20	7	117.207
270	20	8	97.9711
260	30	6	85.0787
245	30	7	124.26
230	30	8	167.856
230	40	6	145.479
210	40	7	107.286
335	10	1	49.9026
330	10	2	89.6031
325	10	3	96.5755
320	10	4	150.769

315	10	5	165.93401
310	10	6	191.444
305	10	7	160.937
300	10	8	136.164
300	20	4	140.45399
290	20	5	170.509
280	20	6	175.119
270	20	7	135.871
260	20	8	109.322
250	30	6	119.959
235	30	7	196.478
220	30	8	175.147
220	40	6	151.91
200	40	7	145.41901
325	10	1	53.6116
320	10	2	66.2709
315	10	3	112.809
310	10	4	129.59801
305	10	5	154.752
300	10	6	133.203
295	10	7	112.956
290	10	8	125.555
290	20	4	138.383
280	20	5	175.035
270	20	6	142.302
260	20	7	120.493
250	20	8	106.811
240	30	6	161.29601
225	30	7	246.028
210	30	8	170.931
210	40	6	145.576
190	40	7	189.521
315	10	1	48.8007
310	10	2	92.9101
305	10	3	111.488
300	10	4	139.213
295	10	5	121.294
290	10	6	101.947
285	10	7	112.739
280	10	8	115.262
280	20	4	136.377
270	20	5	142.755
260	20	6	112.621
250	20	7	92.0682
240	20	8	115.023
230	30	6	168.494

215	30	7	233.576
200	40	6	152.868
180	40	7	215.392
305	10	1	94.4145
300	10	2	132.582
295	10	3	179.519
290	10	4	162.188
285	10	5	134.39
280	10	6	152.77
275	10	7	151.12601
270	10	8	202.79201
270	20	4	175.92599
260	20	5	140.87
250	20	6	120.364
240	20	7	117.168
230	20	8	153.744
220	30	6	224.39
205	30	7	205.416
190	30	8	159.235
190	40	6	169.847
295	10	1	84.5165
290	10	2	130.118
285	10	3	120.346
280	10	4	99.0716
275	10	5	110.376
270	10	6	110.638
265	10	7	138.168
260	10	8	138.584
260	20	4	155.44701
250	20	5	124.381
240	20	6	99.2257
230	20	7	141.235
220	20	8	151.819
210	30	6	254.151
195	30	7	174.687
180	30	8	162.022
180	40	6	181.82401
285	10	1	134.26199
280	10	2	145.101
275	10	3	123.578
270	10	4	133.849
265	10	5	132.91499
260	10	6	175.576
255	10	7	166.618
250	10	8	158.933
250	20	4	131.41701

240	20	5	113.323
230	20	6	100.999
220	20	7	145.66701
210	20	8	199.664
200	30	6	266.14801
185	30	7	154.976
170	30	8	227.058
170	40	6	225.448
275	10	1	135.896
270	10	2	120.03
265	10	3	131.422
260	10	4	127.649
255	10	5	163.89101
250	10	6	161.679
245	10	7	149.901
240	10	8	114.615
240	20	4	123.817
230	20	5	106.892
220	20	6	131.38
210	20	7	188.298
190	30	6	211.664
160	30	8	805.73401
160	40	6	615.74298
265	10	1	92.8929
260	10	2	116.725
255	10	3	116.124
250	10	4	156.908
245	10	5	155.44299
240	10	6	144.845
235	10	7	118.411
230	10	8	124.928
230	20	4	118.702
220	20	5	106.804
210	20	6	155.02
200	20	7	213.27
190	20	8	294.035
180	30	6	184.028
165	30	7	216.30499
150	30	8	255.147
255	10	1	83.6118
250	10	2	89.3021
245	10	3	124.042
240	10	4	125.373
235	10	5	118.806
230	10	6	97.4374
225	10	7	105.397

220	10	8	86.8984
220	20	4	92.595
210	20	5	119.692
200	20	6	166.12199
190	20	7	237.978
180	20	8	234.659
170	30	6	165.74001
245	10	1	63.443
240	10	2	95.0688
235	10	3	102.445
230	10	4	98.5993
225	10	5	81.6204
220	10	6	89.288
215	10	7	73.1874
210	10	8	71.8046
210	20	4	80.764
200	20	5	120.836
190	20	6	171.79401
180	20	7	236.49899
160	30	6	475.13199
235	10	1	64.1557
230	10	2	79.724
225	10	3	82.9283
220	10	4	71.3615
215	10	5	80.1252
210	10	6	67.0871
205	10	7	65.5315
200	10	8	75.1476
200	20	4	90.6121
190	20	5	126.492
180	20	6	193.621
170	20	7	189.06
160	20	8	128.494
150	30	6	159.43201
135	30	7	231.63699
225	10	1	75.8682
220	10	2	82.0272
215	10	3	70.1121
210	10	4	79.0197
205	10	5	65.8255
200	10	6	64.1173
195	10	7	80.3254
190	10	8	104.742
190	20	4	106.502
180	20	5	155.565
170	20	6	219.448

160	20	7	143.24899
150	20	8	141.015
140	30	6	187.222
215	10	1	71.2023
210	10	2	70.7813
205	10	3	84.0001
200	10	4	72.6139
195	10	5	70.3824
190	10	6	83.0137
185	10	7	119.292
180	10	8	121.405
180	20	4	134.16701
170	20	5	210.157
160	20	6	207.77699
150	20	7	140.821
140	20	8	170.565
130	30	6	217.147
205	10	1	48.5637
200	10	2	64.9765
195	10	3	58.726
190	10	4	58.7061
185	10	5	70.0926
180	10	6	102.259
175	10	7	106.65
170	10	8	148.981
170	20	4	168.177
160	20	5	243.533
150	20	6	163.785
140	20	7	159.05499
130	20	8	202.409
120	30	6	247.74899
195	10	1	45.1181
190	10	2	42.8758
185	10	3	43.445
180	10	4	51.6607
175	10	5	77.7968
170	10	6	81.963
165	10	7	111.219
160	10	8	130.256
160	20	4	176.97701
150	20	5	180.82201
140	20	6	125.066
130	20	7	156.069
120	20	8	196.08501
185	10	1	33.3635
180	10	2	28.8412

175	10	3	34.9132
170	10	4	49.4064
165	10	5	49.5948
160	10	6	70.6085
155	10	7	89.6251
150	10	8	115.357
150	20	4	143.72501
140	20	5	103.439
120	20	7	120.771
175	10	1	28.5053
170	10	2	28.6676
165	10	3	43.1321
160	10	4	43.559
155	10	5	64.7277
150	10	6	72.53
145	10	7	113.216
140	10	8	106.07
140	20	4	99.2079
130	20	5	72.8087
120	20	6	88.3001
110	20	7	111.117
100	20	8	136.496
165	10	1	26.9969
160	10	2	34.4277
155	10	3	29.9653
150	10	4	43.0199
145	10	5	52.5228
140	10	6	79.276
135	10	7	76.0573
130	10	8	71.1084
130	20	4	63.8913
120	20	5	63.7901
110	20	6	90.5482
100	20	7	116.75
155	10	1	44.1564
150	10	2	28.1488
145	10	3	35.913
140	10	4	44.0523
135	10	5	67.1302
130	10	6	65.3409
125	10	7	58.1565
120	10	8	42.1232
120	20	4	46.9405
110	20	5	58.6973
100	20	6	63.0731
145	10	1	33.6478

140	10	2	31.9206
135	10	3	38.5679
130	10	4	58.3616
125	10	5	56.517
120	10	6	59.5529
115	10	7	37.5656
110	20	4	51.3932
100	20	5	60.7184
90	20	6	80.1618
135	10	1	47.2349
130	10	2	38.5094
125	10	3	61.4492
120	10	4	64.3766
115	10	5	58.6197
110	10	6	45.9705
105	10	7	50.8051
100	10	8	56.213
100	20	4	59.1166
90	20	5	81.8607
80	20	6	74.1394
125	10	1	37.7096
120	10	2	45.9766
115	10	3	51.5763
110	10	4	49.2256
105	10	5	37.2506
100	10	6	52.1453
95	10	7	44.6049
90	10	8	65.259
90	20	4	65.1896
80	20	5	87.905
115	10	1	55.8719
110	10	2	48.6083
105	10	3	49.3421
100	10	4	51.6114
95	10	5	51.3458
90	10	6	56.9074
85	10	7	67.2244
80	10	8	39.6275
80	20	4	68.7725
70	20	5	60.103
105	10	1	44.6071
100	10	2	44.2223
95	10	3	31.6761
90	10	4	49.6105
85	10	5	45.858
70	20	4	83.3934

95	10	1	55.7904
90	10	2	45.1009
85	10	3	60.6118
80	10	4	60.3593
75	10	5	80.5926
70	10	6	73.7969
65	10	7	106.114
60	10	8	116.056
60	20	4	123.43
85	10	1	35.6106
80	10	2	45.4044
75	10	3	45.6669
70	10	4	61.6688
65	10	5	56.096
60	10	6	80.6313
55	10	7	86.5551
50	10	8	91.5303
75	10	1	32.4889
70	10	2	29.667
65	10	3	38.9877
60	10	4	35.4895
55	10	5	51.2177
50	10	6	58.8878
45	10	7	62.9149
65	10	1	23.7413
60	10	2	22.8745
55	10	3	19.4998
50	10	4	26.5292
45	10	5	32.4781
40	10	6	35.2168
55	10	1	33.99
50	10	2	21.4875
45	10	3	26.2988
40	10	4	32.3625
35	10	5	35.7556
45	10	1	31.6679
40	10	2	24.1124
35	10	3	25.4888
30	10	4	28.4116
35	10	1	44.8987
30	10	2	35.1095
25	10	3	32.621
25	10	1	45.9567
20	10	2	28.3148
15	10	1	49.3447
0			

0
0

Sting/Swift prg: COL10

10

3

665

1

0

615	10	1	10.361
610	10	2	11.8705
605	10	3	13.6455
600	10	4	15.6939
595	10	5	15.4272
590	10	6	17.0355
585	10	7	16.4838
580	10	8	20.2409
605	10	1	9.88094
600	10	2	11.52
595	10	3	13.3992
590	10	4	13.744
585	10	5	14.8657
580	10	6	15.5764
575	10	7	18.1986
570	10	8	19.425
570	20	4	21.633
560	20	5	25.5981
550	20	6	19.1634
540	20	7	20.0361
595	10	1	10.4674
590	10	2	11.7369
585	10	3	12.4964
580	10	4	13.851
575	10	5	15.3798
570	10	6	18.2927
560	20	4	20.6383
550	20	5	23.0203
510	30	6	16.7616
495	30	7	24.3345
480	30	8	36.2195
585	10	1	10.8252
580	10	2	10.784
575	10	3	13.25
570	10	4	14.8229
565	10	5	19.4533
560	10	6	20.1537

555	10	7	20.4247
550	20	4	22.3876
540	20	5	28.4234
530	20	6	23.5083
520	20	7	21.5293
510	20	8	21.9771
485	30	7	27.4584
470	40	6	41.7573
575	10	1	11.8547
570	10	2	12.6836
565	10	3	15.1043
560	10	4	20.1792
555	10	5	23.049
550	10	6	24.9656
545	10	7	29.6082
540	20	4	26.5563
530	20	5	28.4041
520	20	6	26.4422
500	20	8	39.4237
490	30	6	33.4544
475	30	7	29.1541
460	30	8	54.2028
460	40	6	47.7314
565	10	1	12.2179
560	10	2	12.8527
555	10	3	17.7158
550	10	4	20.7713
545	10	5	24.0932
540	10	6	26.6147
535	10	7	32.7219
530	20	4	28.3811
520	20	5	26.869
510	20	6	26.1913
500	20	7	28.6615
490	20	8	31.445
465	30	7	41.5848
450	30	8	49.8622
555	10	1	9.57842
550	10	2	12.7873
545	10	3	15.8533
540	10	4	18.9881
535	10	5	21.5803
530	10	6	25.2547
525	10	7	28.2245
520	10	8	22.8805
520	20	4	25.8878

480	20	8	25.3172
470	30	6	33.1633
455	30	7	50.6474
440	40	6	55.127
420	40	7	70.7497
400	40	8	96.792
545	10	1	11.8748
540	10	2	13.4887
535	10	3	14.8837
530	10	4	19.5334
525	10	5	17.6975
520	10	6	22.2068
510	10	8	18.0206
510	20	4	22.1629
500	20	5	21.2633
490	20	6	28.6828
470	20	8	37.0583
460	30	6	68.1546
430	40	6	56.0844
410	40	7	73.5984
390	40	8	108.372
340	60	7	54.2267
310	60	8	79.7875
535	10	1	10.9946
530	10	2	12.6844
525	10	3	15.9334
520	10	4	21.6802
515	10	5	18.1554
510	10	6	13.3505
505	10	7	21.0234
500	20	4	23.2565
490	20	5	22.3345
480	20	6	29.0713
470	20	7	29.7099
450	30	6	35.2331
435	30	7	60.4353
420	40	6	62.1411
300	60	8	80.833
525	10	1	12.5895
520	10	2	12.8518
515	10	3	17.1739
510	10	4	16.2975
505	10	5	19.1355
500	10	6	17.6665
495	10	7	22.5683
490	10	8	22.8017

490	20	4	23.1571
480	20	5	23.8848
460	20	7	36.5234
450	20	8	62.1373
440	30	6	38.6617
355	50	7	90.0408
330	50	8	54.8383
515	10	1	12.9769
510	10	2	14.2581
505	10	3	13.9625
500	10	4	16.7231
495	10	5	15.9106
485	10	7	25.0199
480	10	8	19.0484
480	20	4	21.7491
460	20	6	29.5759
450	20	7	39.5199
430	30	6	53.5146
400	30	8	77.2138
400	40	6	70.9673
380	40	7	91.2112
360	40	8	110.767
505	10	1	14.0571
495	10	3	14.8018
490	10	4	12.7114
485	10	5	20.6615
480	10	6	15.9977
470	10	8	18.2091
470	20	4	24.1106
460	20	5	27.4709
450	20	6	34.0242
440	20	7	37.2936
420	30	6	43.0098
390	40	6	76.1695
370	40	7	114.866
350	40	8	114.571
335	50	7	62.3313
310	50	8	69.7832
495	10	1	13.6407
490	10	2	12.5099
485	10	3	11.3849
480	10	4	13.9168
475	10	5	15.9612
470	10	6	16.1807
460	20	4	26.4996
450	20	5	29.0339

440	20	6	32.3967
430	20	7	59.1863
420	20	8	30.5343
485	10	1	14.0432
480	10	2	11.0405
475	10	3	14.5086
470	10	4	16.2034
465	10	5	12.6533
460	10	6	22.772
455	10	7	28.5487
450	20	4	22.1865
440	20	5	34.8322
420	20	7	50.4014
410	20	8	52.7279
385	30	7	79.0905
370	40	6	88.8943
315	50	7	45.8379
475	10	1	8.10319
470	10	2	10.5288
465	10	3	12.7188
460	10	4	13.7635
450	10	6	19.3663
440	10	8	8.87295
440	20	4	29.9631
430	20	5	43.0632
420	20	6	29.9664
410	20	7	50.7454
400	20	8	46.0177
390	30	6	60.8229
360	40	6	101.681
340	40	7	128.584
320	40	8	66.882
280	50	8	70.6766
465	10	1	12.3276
460	10	2	13.6577
455	10	3	13.242
450	10	4	15.3667
445	10	5	19.7129
440	10	6	36.8502
430	10	8	22.528
430	20	4	26.2573
420	20	5	31.4658
410	20	6	35.4839
400	20	7	48.6467
365	30	7	72.0453
350	30	8	98.431

455	10	1	12.0608
450	10	2	10.9218
445	10	3	13.1715
440	10	4	16.9687
435	10	5	14.0783
430	10	6	15.6329
425	10	7	20.5051
420	10	8	19.018
420	20	4	17.12
410	20	5	34.8006
400	20	6	58.0896
370	30	6	59.4178
355	30	7	63.364
340	30	8	101.195
445	10	1	11.4484
440	10	2	12.5541
435	10	3	17.1806
430	10	4	18.3098
425	10	5	16.0877
420	10	6	18.1727
415	10	7	22.3867
410	10	8	24.4023
410	20	4	25.9065
400	20	5	30.5383
390	20	6	38.3031
330	40	6	99.4109
310	40	7	63.0006
435	10	1	11.0409
430	10	2	15.9437
425	10	3	13.7114
420	10	4	14.4792
415	10	5	14.5865
410	10	6	20.7419
405	10	7	19.9968
400	10	8	24.7401
380	20	6	31.4164
370	20	7	38.9019
320	40	6	91.9074
300	40	7	42.5284
425	10	1	14.5698
420	10	2	14.0611
415	10	3	11.2045
410	10	4	12.1055
405	10	5	12.8506
400	10	6	10.5293
395	10	7	29.5925

390	10	8	19.8562
390	20	4	24.909
380	20	5	26.7085
310	40	6	73.1686
290	40	7	31.5757
270	40	8	39.8117
415	10	1	18.9021
410	10	2	12.1501
405	10	3	11.3535
400	10	4	20.4579
395	10	5	20.5182
390	10	6	7.79041
385	10	7	22.5508
380	20	4	24.3419
370	20	5	24.9609
360	20	6	28.4746
330	30	6	48.9431
405	10	1	13.2589
400	10	2	14.8315
395	10	3	16.7594
390	10	4	20.9265
385	10	5	21.5237
380	10	6	20.3059
375	10	7	30.7558
370	10	8	27.3397
370	20	4	27.087
270	40	7	29.1134
395	10	1	13.2561
390	10	2	16.7715
385	10	3	19.5854
380	10	4	18.3387
375	10	5	25.9306
370	10	6	24.0605
365	10	7	24.7327
360	10	8	33.4307
360	20	4	29.8969
350	20	5	29.6999
340	20	6	41.5968
280	30	8	42.6595
385	10	1	21.4608
380	10	2	22.2893
375	10	3	25.9083
370	10	4	24.836
365	10	5	27.9603
360	10	6	25.8773
355	10	7	33.2506

350	10	8	26.7352
330	20	6	40.2336
320	20	7	43.6983
300	30	6	74.7086
270	30	8	33.791
375	10	1	30.7918
370	10	2	31.3076
365	10	3	30.8086
360	10	4	30.6745
355	10	5	27.3892
350	10	6	31.7256
345	10	7	26.6797
340	20	4	28.4344
290	30	6	76.2647
275	30	7	55.2656
365	10	1	52.4125
360	10	2	47.4627
355	10	3	40.8839
350	10	4	33.2717
345	10	5	38.2743
340	10	6	30.4639
320	20	5	42.9564
310	20	6	47.9679
300	20	7	60.4857
280	30	6	82.4065
355	10	1	73.0756
350	10	2	57.2909
345	10	3	42.0342
340	10	4	43.4562
335	10	5	33.1903
320	10	8	42.598
320	20	4	42.6363
310	20	5	46.8225
300	20	6	54.9006
290	20	7	83.3182
280	20	8	95.4463
345	10	1	77.6678
340	10	2	55.8631
335	10	3	54.6593
330	10	4	39.2497
315	10	7	37.654
310	20	4	40.959
290	20	6	61.4965
260	30	6	70.9522
335	10	1	87.2778
330	10	2	88.6457

325	10	3	63.4066
310	10	6	37.3022
305	10	7	36.9167
300	10	8	41.162
300	20	4	41.8151
290	20	5	50.2849
220	40	6	56.2411
325	10	1	108.706
320	10	2	95.5807
305	10	5	37.5572
300	10	6	37.4467
295	10	7	42.0187
290	10	8	43.3263
290	20	4	46.4961
280	20	5	60.7799
270	20	6	89.0578
260	20	7	86.91
250	20	8	78.8542
210	30	8	67.9907
315	10	1	78.2039
300	10	4	27.836
295	10	5	27.8518
290	10	6	31.2816
285	10	7	34.3036
280	10	8	40.7975
280	20	4	46.5474
270	20	5	72.1318
260	20	6	84.3963
200	40	6	69.5253
295	10	3	26.1015
290	10	4	29.6953
285	10	5	29.1493
280	10	6	35.4003
275	10	7	38.6302
270	10	8	50.8909
270	20	4	53.7341
260	20	5	77.2924
250	20	6	72.2396
240	20	7	82.7849
230	20	8	38.3245
290	10	2	25.1351
285	10	3	18.9903
280	10	4	22.234
275	10	5	25.5427
270	10	6	33.8608
265	10	7	28.7181

260	10	8	50.0243
260	20	4	59.4141
250	20	5	75.3295
240	20	6	76.1255
230	20	7	50.8721
210	30	6	34.9491
195	30	7	58.7903
180	30	8	53.9663
180	40	6	70.3174
240	20	4	98.4044
230	20	5	108.35
220	20	6	58.383
210	20	7	49.8638
160	40	6	221.834
265	10	1	37.2506
260	10	2	38.3155
255	10	3	61.181
250	10	4	70.9085
245	10	5	113.075
240	10	6	141.935
235	10	7	169.856
230	10	8	168.38
180	30	6	81.7453
165	30	7	158.17101
255	10	1	26.0638
250	10	2	42.8538
245	10	3	56.9772
240	10	4	93.7205
235	10	5	123.162
230	10	6	155.886
225	10	7	154.757
220	10	8	182.83701
220	20	4	190.58299
210	20	5	118.749
200	20	6	74.0483
190	20	7	81.3772
180	20	8	112.354
245	10	1	27.4526
240	10	2	38.4586
235	10	3	69.8038
230	10	4	95.0115
225	10	5	122.864
220	10	6	124.557
215	10	7	148.862
210	10	8	165.44501
210	20	4	151.17599

200	20	5	77.385
160	30	6	256.82901
235	10	1	29.4616
230	10	2	60.418
225	10	3	92.4937
220	10	4	120.229
215	10	5	132.66499
210	10	6	163.569
205	10	7	183.476
200	10	8	120.633
200	20	4	105.145
190	20	5	64.3211
180	20	6	75.0348
170	20	7	103.35
150	30	6	137.308
135	30	7	224.756
225	10	1	38.7207
220	10	2	66.3641
215	10	3	93.5875
210	10	4	109.78
205	10	5	142.689
200	10	6	168.356
195	10	7	117.355
190	10	8	86.7567
190	20	4	78.3546
180	20	5	70.9351
170	20	6	90.6173
160	20	7	136.467
150	20	8	162.052
215	10	1	47.2035
210	10	2	71.0227
205	10	3	89.865
200	10	4	123.834
195	10	5	144.17101
190	10	6	99.21
185	10	7	77.1366
180	10	8	57.4033
180	20	4	62.7813
170	20	5	72.7748
160	20	6	100.387
150	20	7	150.821
140	20	8	159.91901
130	30	6	182.218
205	10	1	68.9509
200	10	2	101.481
195	10	3	150.998

190	10	4	185.532
185	10	5	130.05299
180	10	6	96.7632
175	10	7	73.4649
170	10	8	92.2867
170	20	4	77.7974
160	20	5	98.8156
150	20	6	155.224
140	20	7	173.44
130	20	8	189.728
120	30	6	219.25301
195	10	1	70.4095
190	10	2	129.101
185	10	3	173.96001
180	10	4	128.604
175	10	5	98.9811
170	10	6	75.5947
165	10	7	76.0805
160	10	8	83.0181
160	20	4	93.0543
150	20	5	130.745
140	20	6	199.30901
130	20	7	208.19901
120	20	8	241.326
185	10	1	97.775
180	10	2	151.216
175	10	3	118.554
170	10	4	87.1518
165	10	5	66.6766
160	10	6	78.0072
155	10	7	77.9066
150	10	8	99.7769
150	20	4	107.954
140	20	5	172.84599
130	20	6	200.036
120	20	7	215.229
175	10	1	103.346
170	10	2	84.2562
165	10	3	61.0887
160	10	4	47.4656
155	10	5	54.5223
150	10	6	55.9208
145	10	7	77.1621
140	10	8	85.5823
140	20	4	106.882
130	20	5	169.27901

120	20	6	180.533
110	20	7	212.3
100	20	8	234.371
165	10	1	106.604
160	10	2	65.29
155	10	3	46.0945
150	10	4	50.6615
145	10	5	52.0677
140	10	6	71.9086
135	10	7	78.8268
130	10	8	110.516
130	20	4	125.113
120	20	5	141.739
110	20	6	170.66299
100	20	7	200.263
155	10	1	72.5615
150	10	2	54.2369
145	10	3	55.1287
140	10	4	56.0619
135	10	5	77.2917
130	10	6	84.4563
125	10	7	115.152
120	10	8	160.44501
120	20	4	149.38699
110	20	5	157.758
100	20	6	176.328
90	20	7	212.43201
145	10	1	32.9637
140	10	2	35.2917
135	10	3	36.0817
130	10	4	50.2729
125	10	5	55.7817
120	10	6	80.762
115	10	7	100.526
110	10	8	116.907
110	20	4	131.22301
100	20	5	135.758
135	10	1	25.9734
130	10	2	26.8137
125	10	3	39.5823
120	10	4	46.6252
115	10	5	62.2015
110	10	6	95.4112
105	10	7	72.6086
100	10	8	98.2785
100	20	4	103.568

90	20	5	129.584
80	20	6	123.147
125	10	1	14.9493
120	10	2	22.0419
115	10	3	29.0977
110	10	4	38.8927
105	10	5	56.7096
100	10	6	62.6327
95	10	7	58.9028
90	10	8	72.1182
90	20	4	83.6736
80	20	5	107.271
115	10	1	18.7588
110	10	2	23.773
105	10	3	35.21
100	10	4	55.9693
95	10	5	53.0853
90	10	6	61.0678
85	10	7	67.9056
80	10	8	71.8409
80	20	4	79.573
70	20	5	90.3364
105	10	1	19.0331
100	10	2	32.1674
95	10	3	49.9277
90	10	4	48.2493
85	10	5	52.4947
80	10	6	57.6759
75	10	7	62.8663
70	10	8	73.8776
70	20	4	81.6091
95	10	1	31.8922
90	10	2	60.918
85	10	3	60.6752
80	10	4	65.2851
75	10	5	71.4538
70	10	6	77.901
65	10	7	99.5442
60	10	8	100.428
60	20	4	90.119
85	10	1	43.0015
80	10	2	52.4568
75	10	3	59.4058
70	10	4	65.3185
65	10	5	70.532
60	10	6	95.4542

55	10	7	89.1906
50	10	8	85.186
75	10	1	52.0688
70	10	2	64.3795
65	10	3	78.0292
60	10	4	84.3338
55	10	5	121.583
50	10	6	119.072
45	10	7	114.421
65	10	1	54.2433
60	10	2	73.629
55	10	3	90.9846
50	10	4	132.162
45	10	5	138.032
40	10	6	134.56
55	10	1	52.1671
50	10	2	69.8438
45	10	3	112.101
40	10	4	122.135
35	10	5	120.315
45	10	1	51.3478
40	10	2	100.575
35	10	3	117.863
30	10	4	124.237
35	10	1	71.2758
30	10	2	102.304
25	10	3	120.221
25	10	1	72.4554
20	10	2	100.266
15	10	1	95.8712
0			
0			
0			

Sting/Swift prg: COL11

10

3

757

1

0

615	10	1	23.2414
610	10	2	25.5368
605	10	3	24.3295
600	10	4	22.7113
595	10	5	29.3425
590	10	6	34.0692

585	10	7	39.872
580	10	8	55.7769
605	10	1	21.4021
600	10	2	22.4813
595	10	3	20.5227
590	10	4	23.6276
585	10	5	28.6257
580	10	6	32.2328
575	10	7	43.4761
570	10	8	35.8258
570	20	4	40.9513
560	20	5	35.4837
550	20	6	32.426
540	20	7	17.1897
530	20	8	27.9728
595	10	1	26.5747
590	10	2	22.7488
585	10	3	22.1863
580	10	4	26.0822
575	10	5	28.5789
570	10	6	37.8522
565	10	7	37.4426
560	10	8	34.4813
560	20	4	35.3925
550	20	5	45.6644
540	20	6	31.6063
530	20	7	42.4701
520	20	8	37.4947
585	10	1	43.1092
580	10	2	34.6009
575	10	3	30.2077
570	10	4	30.3178
565	10	5	39.676
560	10	6	32.6168
555	10	7	33.0516
550	10	8	38.7899
550	20	4	40.7799
540	20	5	39.5798
530	20	6	45.4661
520	20	7	40.9163
470	30	8	54.9711
470	40	6	55.1021
430	40	8	52.74
575	10	1	37.5394
570	10	2	29.0368
565	10	3	26.4687

560	10	4	31.3819
555	10	5	27.6506
550	10	6	28.7741
545	10	7	32.011
540	10	8	37.7968
540	20	4	40.9978
530	20	5	34.3736
520	20	6	47.5358
510	20	7	38.3741
500	20	8	38.1547
490	30	6	47.3564
405	50	7	67.3118
565	10	1	39.8272
560	10	2	32.3617
555	10	3	34.3474
550	10	4	29.5888
545	10	5	31.708
540	10	6	32.233
535	10	7	42.6131
530	10	8	37.6655
530	20	4	35.1723
510	20	6	39.1031
450	30	8	57.8624
370	50	8	90.3319
555	10	1	40.9436
550	10	2	41.0139
545	10	3	34.0644
540	10	4	37.2601
535	10	5	37.023
530	10	6	49.2172
525	10	7	47.0673
520	10	8	37.0801
520	20	4	37.012
510	20	5	52.2569
500	20	6	41.2859
470	30	6	56.8107
440	40	6	62.5463
420	40	7	54.4072
400	40	8	63.9182
320	60	8	113.163
545	10	1	46.4834
540	10	2	37.6028
535	10	3	39.7911
530	10	4	44.0179
525	10	5	54.752
520	10	6	52.0296

515	10	7	39.6891
510	10	8	48.0095
510	20	4	53.0185
500	20	5	50.4691
490	20	6	54.0178
480	20	7	36.9002
470	20	8	71.3222
445	30	7	63.9239
430	30	8	53.9111
410	40	7	55.8913
375	50	7	92.2255
350	50	8	108.433
340	60	7	113.253
310	60	8	122.311
535	10	1	37.0349
530	10	2	41.4817
525	10	3	47.2324
520	10	4	58.642
515	10	5	55.8276
510	10	6	43.9101
505	10	7	51.5533
500	10	8	67.5945
500	20	4	62.4549
490	20	5	49.8213
480	20	6	47.3577
470	20	7	50.7236
460	20	8	72.9577
450	30	6	60.7661
435	30	7	75.1284
400	40	7	60.0574
300	60	8	122.244
525	10	1	46.4864
520	10	2	53.505
515	10	3	75.932
510	10	4	71.8245
505	10	5	57.2448
500	10	6	64.4943
495	10	7	89.5667
490	10	8	81.0626
490	20	4	65.3844
480	20	5	68.1273
470	20	6	44.9842
460	20	7	80.9222
450	20	8	79.636
440	30	6	70.2311
515	10	1	36.3723

510	10	2	54.8801
505	10	3	54.5326
500	10	4	44.0582
495	10	5	51.1131
490	10	6	57.5708
485	10	7	81.8382
480	10	8	48.2519
480	20	4	61.0465
470	20	5	57.6156
400	30	8	64.1532
400	40	6	64.3489
380	40	7	79.5228
360	40	8	124.96
310	60	7	159.81
505	10	1	43.0517
500	10	2	53.6862
495	10	3	43.1126
490	10	4	47.0834
485	10	5	68.1791
480	10	6	40.6893
475	10	7	43.4485
470	10	8	44.219
470	20	4	54.4699
460	20	5	35.6615
450	20	6	62.2251
440	20	7	61.4525
430	20	8	59.6954
420	30	6	72.3081
405	30	7	63.0734
390	30	8	58.1784
495	10	1	66.4261
490	10	2	55.1422
485	10	3	58.9066
480	10	4	87.3258
475	10	5	84.7516
470	10	6	68.1927
465	10	7	80.4506
460	10	8	82.976
460	20	4	57.3654
450	20	5	57.0441
440	20	6	79.9772
430	20	7	85.1549
420	20	8	58.5022
380	40	6	67.0968
360	40	7	113.96
485	10	1	52.6445

480	10	2	54.8827
475	10	3	74.9606
470	10	4	69.1547
465	10	5	55.6859
460	10	6	63.2406
455	10	7	65.8373
450	10	8	37.5516
450	20	4	46.0527
430	20	6	78.8663
420	20	7	73.9866
410	20	8	84.357
400	30	6	66.9694
385	30	7	55.5298
370	40	6	66.871
350	40	7	108.553
330	40	8	91.808
280	60	7	158.153
475	10	1	48.8901
470	10	2	75.9824
465	10	3	75.9461
460	10	4	62.0322
455	10	5	70.3879
450	10	6	72.3095
445	10	7	43.9663
440	10	8	47.7044
440	20	4	58.2265
430	20	5	79.4607
420	20	6	66.0922
410	20	7	67.2789
400	20	8	70.5074
390	30	6	67.1151
375	30	7	58.942
360	30	8	70.1818
360	40	6	69.8528
340	40	7	107.526
465	10	1	41.8133
460	10	2	50.1901
455	10	3	44.0085
450	10	4	51.4296
445	10	5	52.8107
440	10	6	32.437
435	10	7	38.1973
430	10	8	55.1455
430	20	4	68.2832
420	20	5	67.6887
410	20	6	62.7549

400	20	7	70.592
350	30	8	61.1267
350	40	6	73.1168
330	40	7	99.1034
270	50	8	143.467
455	10	1	54.3787
450	10	2	54.2558
445	10	3	65.3283
440	10	4	64.4927
435	10	5	37.8715
430	10	6	45.0602
425	10	7	68.1618
420	10	8	78.4656
420	20	4	71.293
410	20	5	64.5942
400	20	6	68.7822
390	20	7	73.8497
380	20	8	64.0865
340	40	6	86.4061
320	40	7	78.794
300	40	8	115.191
445	10	1	48.5404
440	10	2	68.4157
435	10	3	68.1208
430	10	4	40.7403
425	10	5	48.5591
420	10	6	73.2751
415	10	7	85.9053
410	10	8	83.4805
410	20	4	78.301
400	20	5	74.3606
390	20	6	83.5369
360	30	6	56.9374
345	30	7	67.4214
330	40	6	104.89
310	40	7	87.9004
290	40	8	127.738
275	50	7	142.51401
435	10	1	41.1125
430	10	2	43.3641
425	10	3	26.0109
420	10	4	32.2439
415	10	5	48.2243
410	10	6	55.8593
405	10	7	54.994
400	10	8	51.4019

400	20	4	62.1807
390	20	5	65.1326
380	20	6	69.9952
370	20	7	59.6604
360	20	8	53.0484
350	30	6	59.0666
335	30	7	66.8771
320	40	6	98.1467
280	40	8	120.597
265	50	7	136.311
425	10	1	63.2093
420	10	2	31.3034
415	10	3	32.5622
410	10	4	45.2076
405	10	5	48.0076
400	10	6	46.7266
395	10	7	44.3383
390	10	8	43.2366
390	20	4	46.8125
380	20	5	51.3957
340	30	6	50.6725
325	30	7	64.0307
310	40	6	88.111
290	40	7	95.1189
270	40	8	115.58
415	10	1	55.7753
410	10	2	56.5196
405	10	3	75.0996
400	10	4	70.785
395	10	5	66.5548
390	10	6	59.685
385	10	7	58.8905
380	10	8	57.442
380	20	4	52.509
370	20	5	55.0269
360	20	6	46.1173
350	20	7	40.6675
340	20	8	41.4308
330	30	6	46.7253
315	30	7	70.0688
300	30	8	60.5986
300	40	6	66.8805
280	40	7	98.2736
260	40	8	112.82
245	50	7	122.503
405	10	1	58.4905

400	10	2	97.1233
395	10	3	89.804
390	10	4	85.4434
385	10	5	78.7655
380	10	6	77.4241
375	10	7	76.7185
370	10	8	77.6007
370	20	4	71.6899
340	20	7	50.3265
320	30	6	52.573
305	30	7	84.97
290	40	6	65.6535
270	40	7	93.7697
250	40	8	111.31
395	10	1	43.2993
390	10	2	48.4745
385	10	3	49.9425
380	10	4	48.0076
375	10	5	49.0891
370	10	6	48.9555
365	10	7	50.6225
360	10	8	53.8109
360	20	4	63.6027
350	20	5	52.717
340	20	6	45.7944
320	20	8	48.0773
310	30	6	57.7589
295	30	7	82.3102
385	10	1	51.9055
380	10	2	62.436
375	10	3	63.3208
370	10	4	68.0518
365	10	5	69.637
360	10	6	72.6833
355	10	7	77.6585
350	10	8	72.7294
330	20	6	44.0854
320	20	7	49.8695
310	20	8	46.9889
285	30	7	63.944
270	30	8	77.6299
250	40	7	96.4311
375	10	1	66.7698
370	10	2	78.7722
365	10	3	93.1352
360	10	4	100.865

355	10	5	109.072
350	10	6	119.207
345	10	7	113.782
340	20	4	83.6841
330	20	5	71.4857
320	20	6	68.9177
310	20	7	73.86
300	20	8	87.0427
290	30	6	107.188
275	30	7	65.4566
260	40	6	105.816
240	40	7	119.039
220	40	8	116.052
365	10	1	64.1086
360	10	2	89.3143
355	10	3	105.122
350	10	4	120.046
345	10	5	135.44099
340	10	6	133.513
320	20	5	91.046
310	20	6	103.367
300	20	7	96.0229
290	20	8	129.98399
280	30	6	149.47701
355	10	1	50.4853
350	10	2	71.9161
345	10	3	90.8856
340	10	4	108.452
335	10	5	110.918
320	10	8	91.0459
320	20	4	95.3643
310	20	5	94.2289
300	20	6	102.684
290	20	7	117.612
280	20	8	177.88499
270	30	6	122.532
255	30	7	145.188
240	30	8	163.92599
240	40	6	152.89101
345	10	1	42.845
340	10	2	65.6509
335	10	3	85.0542
330	10	4	91.4758
315	10	7	77.4915
310	10	8	75.7894
310	20	4	80.8608

300	20	5	92.3438
290	20	6	83.51
280	20	7	109.125
260	30	6	96.4167
245	30	7	155.797
230	30	8	170.886
230	40	6	163.578
210	40	7	184.026
335	10	1	44.3896
330	10	2	66.4597
325	10	3	79.9558
310	10	6	72.9861
305	10	7	72.4441
300	10	8	72.5902
300	20	4	76.4397
290	20	5	81.4472
280	20	6	88.422
270	20	7	125.572
260	20	8	106.337
250	30	6	95.9794
235	30	7	135.334
220	30	8	145.739
325	10	1	49.69
320	10	2	72.0174
305	10	5	74.467
300	10	6	75.0599
295	10	7	76.1452
290	10	8	82.2074
290	20	4	86.0689
280	20	5	75.8833
270	20	6	96.0698
260	20	7	143.855
210	40	6	160.401
190	40	7	138.114
315	10	1	52.3737
300	10	4	70.1358
295	10	5	72.8589
290	10	6	74.3791
285	10	7	81.7033
280	10	8	96.6885
280	20	4	85.6804
270	20	5	89.3916
260	20	6	133.77901
250	20	7	113.725
240	20	8	75.9324
230	30	6	131.224

215	30	7	140.237
200	30	8	149.994
200	40	6	147.563
180	40	7	120.43
295	10	3	67.2796
290	10	4	71.8926
285	10	5	74.9833
280	10	6	82
275	10	7	100.047
270	10	8	73.013
270	20	4	77.9363
260	20	5	103.336
250	20	6	158.22501
240	20	7	88.3926
230	20	8	121.108
220	30	6	137.645
190	40	6	156.358
290	10	2	48.0709
285	10	3	54.2122
280	10	4	57.7535
275	10	5	64.0496
270	10	6	79.2937
265	10	7	58.616
260	10	8	64.79
260	20	4	80.3357
250	20	5	127.713
240	20	6	111.096
230	20	7	74.283
220	20	8	140.05299
210	30	6	130.17101
195	30	7	144.37
180	30	8	148.644
240	20	4	96.1947
230	20	5	85.5372
220	20	6	57.4823
210	20	7	110.724
200	20	8	101.721
190	30	6	113.538
175	30	7	109.936
160	30	8	141.386
160	40	6	131.879
265	10	1	23.0648
250	10	4	34.8371
245	10	5	40.1182
240	10	6	50.1936
235	10	7	59.8931

230	10	8	100.104
180	30	6	112.551
165	30	7	109.26
150	30	8	94.3499
255	10	1	24.5319
245	10	3	29.2024
240	10	4	36.6465
235	10	5	46.1221
230	10	6	52.7826
225	10	7	91.0611
220	10	8	71.1956
220	20	4	66.1264
210	20	5	43.7096
200	20	6	88.4349
190	20	7	80.9453
180	20	8	94.299
245	10	1	27.5134
240	10	2	24.1591
235	10	3	32.3845
230	10	4	41.0241
225	10	5	48.7268
220	10	6	85.6838
215	10	7	66.6544
210	10	8	50.6019
210	20	4	44.9162
200	20	5	62.0154
190	20	6	76.2493
180	20	7	84.635
170	20	8	88.5055
160	30	6	127.523
145	30	7	54.3167
235	10	1	18.5937
230	10	2	28.5933
225	10	3	38.7058
220	10	4	46.7895
215	10	5	84.9169
210	10	6	67.3411
205	10	7	50.2636
200	10	8	33.7437
200	20	4	39.5989
190	20	5	77.3752
180	20	6	76.3303
170	20	7	88.4274
160	20	8	97.6858
150	30	6	97.2118
135	30	7	85.3142

225	10	1	23.5257
220	10	2	35.3098
215	10	3	44.3978
210	10	4	84.6758
205	10	5	68.9207
200	10	6	51.4476
195	10	7	34.7461
190	10	8	46.5464
190	20	4	60.8653
180	20	5	78.3018
170	20	6	88.5106
160	20	7	93.0817
140	30	6	95.2813
215	10	1	25.7634
210	10	2	32.4106
205	10	3	61.2458
200	10	4	48.9823
195	10	5	37.1467
190	10	6	24.7506
185	10	7	34.1005
180	10	8	58.7455
180	20	4	69.2353
170	20	5	67.562
160	20	6	80.1968
150	20	7	85.8787
140	20	8	95.6439
130	30	6	81.9858
205	10	1	33.4335
200	10	2	66.7486
195	10	3	54.1547
190	10	4	42.7
185	10	5	28.5831
180	10	6	38.8709
175	10	7	68.8887
170	10	8	73.1984
170	20	4	62.7148
160	20	5	64.5099
150	20	6	66.753
140	20	7	84.5224
130	20	8	71.6221
120	30	6	72.728
195	10	1	61.3261
190	10	2	54.4997
185	10	3	42.2849
180	10	4	28.0113
175	10	5	40.0381

170	10	6	71.0134
165	10	7	72.4508
160	10	8	64.2895
160	20	4	66.1852
150	20	5	76.1594
140	20	6	80.4794
130	20	7	88.2799
120	20	8	76.5509
185	10	1	37.6811
180	10	2	33.6903
175	10	3	23.7175
170	10	4	33.2628
165	10	5	64.0751
160	10	6	71.444
155	10	7	65.8911
150	10	8	75.346
150	20	4	76.4988
140	20	5	83.648
130	20	6	109.951
120	20	7	92.7871
110	20	8	89.4966
175	10	1	32.2767
170	10	2	24.1154
165	10	3	37.2726
160	10	4	76.8679
155	10	5	91.7388
150	10	6	86.2472
145	10	7	105.586
140	10	8	113.131
140	20	4	106.908
130	20	5	121.168
120	20	6	140.728
110	20	7	125.793
100	20	8	122.8
165	10	1	13.4194
160	10	2	19.3073
155	10	3	42.3983
150	10	4	54.9785
145	10	5	53.4594
140	10	6	67.0508
135	10	7	73.3181
130	10	8	90.0277
130	20	4	101.326
120	20	5	141.57201
110	20	6	127.617
100	20	7	123.29

155	10	1	12.0616
150	10	2	25.5382
145	10	3	36.6712
140	10	4	37.0465
135	10	5	47.9114
130	10	6	53.9386
125	10	7	67.3998
120	20	4	82.181
110	20	5	101.397
100	20	6	88.9113
90	20	7	97.7868
145	10	1	11.0219
140	10	2	19.0296
135	10	3	20.004
130	10	4	26.182
125	10	5	30.1987
120	10	6	39.6639
115	10	7	33.5802
110	10	8	57.2185
110	20	4	72.5743
100	20	5	67.2803
90	20	6	68.8482
135	10	1	17.1726
130	10	2	19.9293
125	10	3	27.0346
120	10	4	32.4218
115	10	5	42.8231
110	10	6	39.1163
105	10	7	59.4874
100	10	8	66.4367
100	20	4	60.7408
90	20	5	61.915
80	20	6	56.2054
125	10	1	24.0085
120	10	2	29.2722
115	10	3	37.6204
110	10	4	51.543
105	10	5	47.5661
100	10	6	81.5607
95	10	7	83.0308
90	10	8	86.7945
90	20	4	74.2135
80	20	5	77.7938
115	10	1	28.5895
110	10	2	24.4716
105	10	3	31.9081

100	10	4	31.1711
95	10	5	53.4828
90	10	6	58.8394
85	10	7	61.0058
80	10	8	58.8016
80	20	4	71.2199
70	20	5	76.4679
105	10	1	30.8979
100	10	2	28.3875
95	10	3	25.2735
90	10	4	42.3497
85	10	5	47.6757
80	10	6	49.7096
75	10	7	50.5673
70	10	8	52.3705
70	20	4	59.6599
95	10	1	34.4784
90	10	2	30.1353
85	10	3	46.5269
80	10	4	53.0406
75	10	5	56.0373
70	10	6	57.1922
65	10	7	63.1184
60	10	8	60.9614
60	20	4	60.6775
85	10	1	25.3775
80	10	2	36.5919
75	10	3	44.0213
70	10	4	48.4456
65	10	5	51.3903
60	10	6	57.3535
55	10	7	55.6925
50	10	8	61.2813
75	10	1	27.4467
70	10	2	35.3637
65	10	3	41.8823
60	10	4	45.7389
55	10	5	53.6775
50	10	6	54.4664
45	10	7	60.4619
65	10	1	28.604
60	10	2	32.6177
55	10	3	35.2097
50	10	4	41.9035
45	10	5	43.8553
40	10	6	48.6414

55	10	1	36.0947
50	10	2	38.4147
45	10	3	47.6266
40	10	4	52.8377
35	10	5	60.6009
45	10	1	33.7416
40	10	2	36.9393
35	10	3	41.0343
30	10	4	47.6187
35	10	1	32.9282
30	10	2	35.2261
25	10	3	38.144
25	10	1	36.377
20	10	2	34.5574
15	10	1	35.4477
0			
0			
0			

Sting/Swift prg: COL12

1.00000			
3			
313			
1			
0			
61.50000	1.00000	1.00000	23.05230
60.00000	1.00000	4.00000	50.70630
59.50000	1.00000	5.00000	55.25680
60.50000	1.00000	1.00000	29.36170
59.00000	1.00000	4.00000	29.93220
55.00000	2.00000	6.00000	94.91000
59.50000	1.00000	1.00000	18.37320
59.00000	1.00000	2.00000	15.35340
58.50000	1.00000	3.00000	25.06810
58.00000	1.00000	4.00000	25.85010
57.50000	1.00000	5.00000	31.40620
57.00000	1.00000	6.00000	31.10460
55.00000	2.00000	5.00000	59.39750
54.00000	2.00000	6.00000	76.73100
53.00000	2.00000	7.00000	65.88040
58.50000	1.00000	1.00000	31.83550
57.50000	1.00000	3.00000	22.28000
57.00000	1.00000	4.00000	28.74170
56.50000	1.00000	5.00000	31.41540
56.00000	1.00000	6.00000	31.12690
55.50000	1.00000	7.00000	33.55740

57.50000	1.00000	1.00000	56.33680
56.50000	1.00000	3.00000	28.33140
56.00000	1.00000	4.00000	30.57000
55.50000	1.00000	5.00000	31.23190
57.00000	1.00000	2.00000	15.46440
54.00000	1.00000	8.00000	64.80120
56.50000	1.00000	1.00000	61.83360
55.50000	1.00000	3.00000	35.71630
55.00000	1.00000	4.00000	37.18060
56.00000	1.00000	2.00000	24.28040
55.50000	1.00000	1.00000	55.88510
54.50000	1.00000	3.00000	26.40590
54.00000	1.00000	4.00000	29.15050
53.50000	1.00000	5.00000	60.31150
53.00000	1.00000	6.00000	65.24190
52.50000	1.00000	7.00000	66.15920
52.00000	1.00000	8.00000	86.99190
54.50000	1.00000	1.00000	57.74620
53.50000	1.00000	3.00000	22.03960
53.00000	1.00000	4.00000	46.42010
52.50000	1.00000	5.00000	49.98270
51.00000	2.00000	4.00000	91.89260
50.00000	2.00000	5.00000	74.73360
49.00000	2.00000	6.00000	82.96430
47.00000	2.00000	8.00000	50.56970
35.00000	5.00000	8.00000	834.04999
53.50000	1.00000	1.00000	51.58020
52.50000	1.00000	3.00000	53.45750
52.00000	1.00000	4.00000	56.07100
50.00000	2.00000	4.00000	86.07060
49.00000	2.00000	5.00000	66.41330
45.00000	3.00000	6.00000	94.26580
51.50000	1.00000	3.00000	57.89970
52.00000	1.00000	2.00000	30.91860
50.00000	1.00000	6.00000	75.69240
49.50000	1.00000	7.00000	96.04860
49.00000	1.00000	8.00000	74.49200
49.00000	2.00000	4.00000	72.86090
32.00000	6.00000	7.00000	1200.68994
50.50000	1.00000	3.00000	42.76790
50.00000	1.00000	4.00000	63.24660
48.00000	1.00000	8.00000	53.50960
50.50000	1.00000	1.00000	51.62240
50.00000	1.00000	2.00000	24.87520
49.50000	1.00000	3.00000	59.17080
49.00000	1.00000	4.00000	63.59340

48.50000	1.00000	5.00000	94.41650
48.00000	1.00000	6.00000	42.51820
47.50000	1.00000	7.00000	52.48340
46.00000	2.00000	5.00000	71.89220
43.00000	2.00000	8.00000	53.48380
49.50000	1.00000	1.00000	68.67660
48.50000	1.00000	3.00000	94.73050
48.00000	1.00000	4.00000	112.46600
47.50000	1.00000	5.00000	89.01150
47.00000	1.00000	6.00000	74.45890
48.50000	1.00000	1.00000	76.95530
48.00000	1.00000	2.00000	55.55410
47.50000	1.00000	3.00000	101.51600
47.00000	1.00000	4.00000	82.97830
46.50000	1.00000	5.00000	66.45560
46.00000	1.00000	6.00000	87.09130
45.00000	2.00000	4.00000	112.14400
44.00000	2.00000	5.00000	62.15720
47.50000	1.00000	1.00000	73.45020
46.50000	1.00000	3.00000	69.80700
39.00000	3.00000	6.00000	97.38820
46.50000	1.00000	1.00000	98.11390
46.00000	1.00000	2.00000	55.29000
45.50000	1.00000	3.00000	74.83960
45.00000	1.00000	4.00000	91.12980
44.50000	1.00000	5.00000	112.38900
44.00000	1.00000	6.00000	140.20599
43.50000	1.00000	7.00000	125.95800
35.00000	3.00000	8.00000	89.85570
35.00000	4.00000	6.00000	123.21500
33.00000	4.00000	7.00000	140.30200
31.00000	4.00000	8.00000	154.00000
45.50000	1.00000	1.00000	69.55230
44.50000	1.00000	3.00000	84.43740
44.00000	1.00000	4.00000	102.54400
42.00000	2.00000	4.00000	45.04940
39.00000	2.00000	7.00000	106.86700
44.50000	1.00000	1.00000	60.46500
44.00000	1.00000	2.00000	53.94410
43.50000	1.00000	3.00000	109.90100
43.00000	1.00000	4.00000	127.14100
42.50000	1.00000	5.00000	123.34000
42.00000	1.00000	6.00000	86.07940
41.50000	1.00000	7.00000	46.24570
41.00000	1.00000	8.00000	50.38080
39.00000	2.00000	6.00000	110.41600

40.00000	2.00000	5.00000	96.86620
34.50000	3.00000	7.00000	149.42101
43.50000	1.00000	1.00000	41.54410
40.00000	2.00000	4.00000	73.46430
42.50000	1.00000	1.00000	36.68540
42.00000	1.00000	2.00000	32.52190
41.50000	1.00000	3.00000	50.24630
25.50000	5.00000	7.00000	540.89502
41.50000	1.00000	1.00000	32.79990
41.00000	1.00000	2.00000	35.87250
40.50000	1.00000	3.00000	35.39480
40.00000	1.00000	4.00000	21.33060
39.50000	1.00000	5.00000	21.66420
39.00000	1.00000	6.00000	32.59920
33.00000	3.00000	6.00000	91.18360
31.50000	3.00000	7.00000	83.28990
30.00000	4.00000	6.00000	127.54600
26.00000	4.00000	8.00000	208.66701
24.50000	5.00000	7.00000	611.48199
40.50000	1.00000	1.00000	39.01990
40.00000	1.00000	2.00000	32.86900
39.50000	1.00000	3.00000	21.88330
39.00000	1.00000	4.00000	20.62280
38.50000	1.00000	5.00000	37.28000
38.00000	1.00000	6.00000	51.33710
27.00000	4.00000	7.00000	148.49200
39.50000	1.00000	1.00000	26.78240
39.00000	1.00000	2.00000	16.43470
38.50000	1.00000	3.00000	16.08130
38.00000	1.00000	4.00000	28.33710
31.00000	3.00000	6.00000	84.80210
29.50000	3.00000	7.00000	108.02800
28.00000	3.00000	8.00000	190.78700
26.00000	4.00000	7.00000	293.98300
38.50000	1.00000	1.00000	11.95160
38.00000	1.00000	2.00000	9.61622
37.50000	1.00000	3.00000	20.66550
37.00000	1.00000	4.00000	32.72400
37.50000	1.00000	1.00000	5.48144
36.00000	1.00000	4.00000	15.62910
35.50000	1.00000	5.00000	23.86300
35.00000	1.00000	6.00000	17.97100
34.50000	1.00000	7.00000	20.83360
34.00000	2.00000	4.00000	37.02770
33.00000	2.00000	5.00000	78.21840
32.00000	2.00000	6.00000	91.79860

31.00000	2.00000	7.00000	80.06620
30.00000	2.00000	8.00000	70.84310
27.50000	3.00000	7.00000	71.94910
24.00000	4.00000	7.00000	353.99701
22.00000	4.00000	8.00000	520.57703
36.00000	1.00000	2.00000	6.79470
32.00000	2.00000	5.00000	66.33350
35.50000	1.00000	1.00000	12.96360
32.00000	2.00000	4.00000	39.18590
30.00000	2.00000	6.00000	43.08250
34.50000	1.00000	1.00000	24.29080
31.00000	2.00000	4.00000	62.26250
30.00000	2.00000	5.00000	63.49010
29.00000	2.00000	6.00000	49.93470
28.00000	2.00000	7.00000	55.56460
33.50000	1.00000	1.00000	21.05690
32.50000	1.00000	3.00000	17.81610
31.00000	1.00000	6.00000	45.86620
30.50000	1.00000	7.00000	66.31580
20.00000	4.00000	7.00000	633.12701
30.50000	1.00000	5.00000	32.10780
30.00000	1.00000	6.00000	47.09180
29.00000	1.00000	8.00000	44.41700
29.00000	2.00000	4.00000	58.17230
27.00000	2.00000	6.00000	49.74780
21.00000	4.00000	6.00000	168.16200
31.50000	1.00000	1.00000	14.86260
29.50000	1.00000	5.00000	61.08410
29.00000	1.00000	6.00000	62.34200
28.50000	1.00000	7.00000	61.75660
28.00000	1.00000	8.00000	72.19810
28.00000	2.00000	4.00000	56.08140
27.00000	2.00000	5.00000	52.33670
26.00000	2.00000	6.00000	55.85650
25.00000	2.00000	7.00000	73.08330
24.00000	2.00000	8.00000	62.33570
28.50000	1.00000	3.00000	18.74880
26.00000	2.00000	4.00000	29.86000
25.00000	2.00000	5.00000	38.68810
23.00000	2.00000	7.00000	47.02030
20.00000	2.00000	8.00000	62.60830
17.50000	3.00000	7.00000	335.92899
26.50000	1.00000	1.00000	33.10190
24.00000	1.00000	6.00000	31.99160
23.50000	1.00000	7.00000	32.19930
23.00000	1.00000	8.00000	47.05580

25.50000	1.00000	1.00000	33.39270
25.00000	1.00000	2.00000	22.13470
24.00000	1.00000	4.00000	26.15030
23.50000	1.00000	5.00000	32.47370
23.00000	1.00000	6.00000	35.27050
22.50000	1.00000	7.00000	47.95000
22.00000	1.00000	8.00000	66.99050
19.00000	2.00000	7.00000	104.67700
18.00000	2.00000	8.00000	180.60699
24.50000	1.00000	1.00000	25.61950
23.50000	1.00000	3.00000	19.26270
23.00000	1.00000	4.00000	21.92210
22.50000	1.00000	5.00000	27.47130
22.00000	1.00000	6.00000	35.80520
21.50000	1.00000	7.00000	48.62970
21.00000	1.00000	8.00000	38.69730
21.00000	2.00000	4.00000	41.12230
20.00000	2.00000	5.00000	76.31670
19.00000	2.00000	6.00000	67.60200
17.00000	2.00000	8.00000	172.39700
22.50000	1.00000	3.00000	19.68330
22.00000	1.00000	4.00000	18.23900
21.50000	1.00000	3.00000	12.93290
19.50000	1.00000	7.00000	22.20720
19.00000	1.00000	8.00000	31.46160
17.00000	2.00000	6.00000	53.82090
16.00000	2.00000	6.00000	53.79790
15.00000	2.00000	7.00000	47.77440
19.50000	1.00000	3.00000	22.47720
20.00000	1.00000	2.00000	6.27454
13.00000	2.00000	8.00000	144.19200
12.00000	3.00000	6.00000	126.23200
17.00000	1.00000	6.00000	35.21460
16.00000	2.00000	4.00000	24.69730
15.00000	2.00000	5.00000	63.81460
14.00000	2.00000	6.00000	21.25350
18.50000	1.00000	1.00000	23.84650
17.50000	1.00000	3.00000	15.63860
17.00000	1.00000	4.00000	19.33690
16.50000	1.00000	5.00000	34.15100
15.00000	2.00000	4.00000	30.56690
11.00000	2.00000	8.00000	161.67101
16.50000	1.00000	3.00000	24.79690
17.00000	1.00000	2.00000	10.76830
15.50000	1.00000	5.00000	31.60260
16.50000	1.00000	1.00000	17.67060

15.50000	1.00000	3.00000	40.27150
15.00000	1.00000	4.00000	33.45010
14.50000	1.00000	5.00000	26.83370
14.00000	1.00000	6.00000	37.54280
13.50000	1.00000	7.00000	39.15800
13.00000	2.00000	4.00000	70.54220
15.50000	1.00000	1.00000	19.57000
15.00000	1.00000	2.00000	25.71770
14.50000	1.00000	3.00000	22.86560
14.50000	1.00000	1.00000	24.71110
13.50000	1.00000	3.00000	15.26350
13.50000	1.00000	1.00000	32.53320
12.50000	1.00000	3.00000	30.37130
11.50000	1.00000	5.00000	69.12610
13.00000	1.00000	2.00000	17.27730
11.50000	1.00000	3.00000	40.80420
11.00000	1.00000	4.00000	105.64400
12.00000	1.00000	2.00000	21.37500
9.00000	2.00000	4.00000	214.49200
8.00000	2.00000	5.00000	201.35699
10.50000	1.00000	3.00000	52.90320
8.00000	1.00000	8.00000	200.08000
8.00000	2.00000	4.00000	195.36200
9.50000	1.00000	3.00000	33.18820
8.50000	1.00000	5.00000	44.01250
8.00000	1.00000	6.00000	91.43730
7.00000	2.00000	4.00000	116.84200
9.50000	1.00000	1.00000	35.23190
9.00000	1.00000	2.00000	24.37000
7.00000	1.00000	6.00000	179.26900
6.00000	2.00000	4.00000	127.10900
8.50000	1.00000	1.00000	29.87930
7.50000	1.00000	3.00000	38.38220
7.00000	1.00000	4.00000	90.62950
6.50000	1.00000	5.00000	148.21600
6.00000	1.00000	6.00000	109.38100
6.50000	1.00000	3.00000	99.37060
5.50000	1.00000	5.00000	140.28999
4.50000	1.00000	7.00000	174.78300
7.00000	1.00000	2.00000	22.13870
6.00000	1.00000	4.00000	241.28500
5.00000	1.00000	6.00000	200.35400
6.50000	1.00000	1.00000	26.18480
6.00000	1.00000	2.00000	34.72190
5.50000	1.00000	3.00000	98.91650
4.50000	1.00000	5.00000	93.13360

5.00000	1.00000	4.00000	82.93940
4.00000	1.00000	6.00000	107.32400
5.50000	1.00000	1.00000	58.46280
4.50000	1.00000	3.00000	58.52560
4.00000	1.00000	4.00000	87.43040
3.50000	1.00000	5.00000	80.64440
4.50000	1.00000	1.00000	152.97501
4.00000	1.00000	2.00000	44.22500
3.50000	1.00000	3.00000	132.20799
3.00000	1.00000	4.00000	153.58701
3.50000	1.00000	1.00000	78.24560
3.00000	1.00000	2.00000	97.18240
2.50000	1.00000	3.00000	152.83600
2.50000	1.00000	1.00000	124.53900
2.00000	1.00000	2.00000	141.86099
1.50000	1.00000	1.00000	77.99390

0
0
0

Sting/Swift prg: COL13

10
3
348
1
0

615	10	1	52.9092
610	10	2	28.757
605	10	3	22.6896
605	10	1	57.6027
600	10	2	48.4053
595	10	3	39.2386
585	10	5	18.8215
595	10	1	44.5034
590	10	2	38.3677
520	20	8	47.9385
585	10	1	35.3372
580	10	2	29.3243
575	10	1	35.556
570	10	2	15.2413
540	20	4	15.2067
530	20	5	28.3796
510	20	7	48.612
500	20	8	59.6055
565	10	1	16.16
560	10	2	27.6382

490	20	8	87.8514
465	30	7	61.8168
360	60	7	119.65
555	10	1	17.8359
550	10	2	13.1851
545	10	3	9.65608
540	10	4	8.60024
535	10	5	13.2929
530	10	6	18.3646
525	10	7	20.2209
520	20	4	34.8743
510	20	5	41.702
440	40	6	61.9264
420	40	7	41.5769
545	10	1	12.82
540	10	2	6.13392
535	10	3	4.44809
520	10	6	9.7545
515	10	7	13.4418
530	10	4	7.75551
510	10	8	20.1802
490	20	6	52.3452
535	10	1	8.02797
500	20	4	23.5065
490	20	5	34.4832
525	10	1	9.22259
520	10	2	13.719
515	10	3	18.7132
510	10	4	16.9766
505	10	5	22.4665
495	10	7	30.2957
480	20	5	53.8464
440	30	6	31.3189
515	10	1	9.97377
510	10	2	11.5464
480	20	4	30.8388
470	20	5	46.5568
505	10	1	16.096
500	10	2	9.14614
460	20	5	33.8202
450	20	6	38.7368
420	30	6	33.2522
390	30	8	36.8892
495	10	1	17.0575
490	10	2	12.5011
485	10	3	13.145

480	10	4	12.7605
475	10	5	12.2688
465	10	7	21.8578
460	20	4	26.8039
485	10	1	24.5903
480	10	2	14.6405
475	10	3	12.9659
470	10	4	11.7193
465	10	5	14.2515
460	10	6	21.5203
455	10	7	26.2803
450	20	4	32.5267
315	50	7	112.245
475	10	1	22.933
470	10	2	14.0449
465	10	3	12.038
460	10	4	12.7287
455	10	5	17.5195
450	10	6	22.1182
445	10	7	25.4705
440	10	8	31.4985
360	30	8	63.9509
465	10	1	29.5692
460	10	2	19.2869
455	10	3	19.749
450	10	4	26.1048
445	10	5	32.4231
440	10	6	35.8515
435	10	7	46.2119
430	20	4	41.9353
420	20	5	38.434
455	10	1	27.3327
450	10	2	19.8527
445	10	3	33.1191
440	10	4	41.7093
435	10	5	45.9145
430	10	6	61.042
420	20	4	62.8984
355	30	7	38.4789
445	10	1	17.0803
435	10	3	27.076
430	10	4	31.7428
425	10	5	43.6138
400	20	5	27.0716
390	20	6	43.5981
435	10	1	25.2722

430	10	2	20.3775
425	10	3	26.0041
420	10	4	35.1228
415	10	5	38.1495
405	10	7	48.9859
400	10	8	35.2483
370	20	7	51.9794
335	30	7	56.3119
320	30	8	129.44701
425	10	1	33.5928
420	10	2	29.2718
415	10	3	47.1268
410	10	4	50.4308
405	10	5	54.52
400	10	6	61.3041
390	20	4	20.8563
380	20	5	33.6827
310	40	6	92.6683
415	10	1	41.9299
410	10	2	51.2474
405	10	3	64.3149
400	10	4	69.7501
395	10	5	78.3498
390	10	6	56.1203
380	20	4	38.7212
330	30	6	76.6619
315	30	7	113.424
300	30	8	209.71899
280	40	7	120.786
405	10	1	59.9803
400	10	2	63.8203
395	10	3	82.468
390	10	4	95.2915
395	10	1	52.2092
390	10	2	59.3441
385	10	3	84.3204
380	10	4	65.8849
375	10	5	22.669
370	10	6	32.9794
365	10	7	46.6655
360	10	8	40.331
360	20	4	45.2031
350	20	5	73.6365
340	20	6	45.581
280	40	6	124.035
260	40	7	236.992

385	10	1	55.1253
380	10	2	70.5799
375	10	3	69.7278
370	10	4	23.3987
365	10	5	33.8411
320	20	7	92.263
375	10	1	54.3027
370	10	2	51.357
360	10	4	27.3432
355	10	5	40.3661
345	10	7	43.7917
365	10	1	45.7
350	10	4	32.3746
345	10	5	30.9419
340	10	6	37.6972
320	20	5	55.7821
300	20	7	65.5523
250	40	6	220.11099
355	10	1	12.6854
350	10	2	14.6291
345	10	3	25.0149
340	10	4	25.2622
335	10	5	31.5877
290	20	7	86.3904
280	20	8	162.17101
255	30	7	83.7159
345	10	1	8.36315
340	10	2	12.8295
335	10	3	14.4998
330	10	4	18.5755
315	10	7	18.8276
300	20	5	56.4901
290	20	6	53.7829
280	20	7	83.587
335	10	1	8.14265
330	10	2	10.116
325	10	3	14.0839
310	10	6	14.7565
305	10	7	18.8937
325	10	1	11.9822
320	10	2	15.1381
305	10	5	17.7524
300	10	6	24.0123
295	10	7	41.2247
290	10	8	30.405
290	20	4	39.1063

280	20	5	38.2335
270	20	6	59.9156
260	20	7	131.464
250	20	8	142.82899
315	10	1	21.3731
290	10	6	52.3898
285	10	7	38.1822
295	10	3	20.1252
290	10	2	17.201
265	10	7	35.1197
260	20	4	55.4004
250	20	5	113.665
230	20	7	120.437
220	20	8	86.477
210	30	6	305.371
195	30	7	226.57201
240	20	4	130.058
230	20	5	237.993
220	20	6	158.806
265	10	1	10.9516
260	10	2	10.4399
250	10	4	14.4208
180	30	6	174.02901
255	10	1	13.8446
250	10	2	27.5066
245	10	3	20.7977
240	10	4	35.2891
235	10	5	39.9831
230	10	6	60.794
220	20	4	124.82
245	10	1	18.1842
240	10	2	18.0567
235	10	3	34.5276
230	10	4	43.032
225	10	5	68.7779
235	10	1	7.63255
230	10	2	14.8731
225	10	3	21.5101
220	10	4	33.5473
215	10	5	58.2663
210	10	6	98.9817
200	10	8	118.638
180	20	6	214.815
170	20	7	246.731
160	20	8	232.69901
225	10	1	15.4579

220	10	2	26.3747
215	10	3	42.3425
210	10	4	77.6619
205	10	5	136.59
200	10	6	139.12199
195	10	7	178.858
190	20	4	48.8506
180	20	5	173.64101
170	20	6	259.634
160	20	7	268.50299
215	10	1	9.81577
210	10	2	12.4003
205	10	3	24.9742
200	10	4	47.5443
195	10	5	50.521
190	10	6	67.1962
185	10	7	21.8768
180	20	4	73.4659
205	10	1	13.7944
200	10	2	26.113
195	10	3	53.321
190	10	4	58.7928
185	10	5	81.5233
180	10	6	26.772
175	10	7	35.2567
170	10	8	100.878
195	10	1	15.4975
190	10	2	30.9016
185	10	3	36.8089
180	10	4	53.5317
175	10	5	22.4015
170	10	6	23.5847
160	20	4	124.382
185	10	1	39.6302
180	10	2	55.9941
175	10	3	81.5509
170	10	4	38.5623
165	10	5	37.986
160	10	6	105.057
155	10	7	157.58099
150	10	8	205.651
175	10	1	46.3716
170	10	2	68.7536
165	10	3	38.1232
160	10	4	40.0967
155	10	5	117.673

165	10	1	52.2577
160	10	2	35.2214
155	10	3	35.3806
150	10	4	105.991
145	10	5	162.465
140	10	6	221.66
135	10	7	268.94901
130	10	8	252.121
155	10	1	21.5655
150	10	2	19.8455
145	10	3	61.3373
140	10	4	93.8864
135	10	5	129.894
130	10	6	161.985
125	10	7	157.935
120	10	8	197.457
145	10	1	20.3388
140	10	2	69.7268
135	10	3	116.147
130	10	4	170.08701
125	10	5	221.72099
120	10	6	209.20599
115	10	7	282.72101
110	10	8	213.34
135	10	1	22.297
130	10	2	40.7145
125	10	3	66.3645
120	10	4	92.2401
115	10	5	96.1758
110	10	6	129.297
105	10	7	87.0694
125	10	1	60.9663
120	10	2	92.8035
115	10	3	126.715
110	10	4	117.51
105	10	5	153.933
100	10	6	116.92
115	10	1	109.198
110	10	2	152.83099
105	10	3	179.437
100	10	4	253.14101
95	10	5	196.62399
105	10	1	125.703
100	10	2	120.841
95	10	3	203.78
90	10	4	166.049

95	10	1	93.6619
90	10	2	115.815
85	10	3	125.009
85	10	1	83.4273
80	10	2	52.1199
75	10	1	56.3717
0			
0			
0			

Sting/Swift prg: COL1 3WN

10		
1		
427		
1		
0		
420	140	82.0992
435	130	70.7
450	120	56.1753
465	110	44.5402
480	100	33.0649
495	90	29.9946
510	80	29.4293
525	70	28.3029
540	60	29.3145
555	50	31.2966
585	30	21.4488
600	20	27.546
615	10	56.2204
410	140	44.7404
425	130	25.8231
440	120	31.2631
500	80	1.40246
530	60	24.2601
545	50	27.6765
560	40	24.7265
575	30	21.4127
590	20	20.2563
605	10	43.4442
400	140	87.2815
415	130	68.4955
430	120	56.6828
445	110	47.2117
460	100	36.6244
475	90	26.6007
490	80	23.401

505	70	21.9592
520	60	24.3209
535	50	23.4333
550	40	26.997
565	30	22.284
580	20	28.205
595	10	38.3217
390	140	81.3885
405	130	76.8351
420	120	69.2276
435	110	58.3669
450	100	46.9889
480	80	26.384
495	70	26.5861
510	60	22.9357
525	50	24.3113
555	30	22.5179
570	20	25.4563
585	10	35.2321
380	140	93.6257
395	130	82.3941
410	120	75.1464
425	110	66.0481
455	90	41.7
470	80	30.2361
485	70	28.117
500	60	23.0301
515	50	21.2558
530	40	22.4199
545	30	20.8077
560	20	18.0653
575	10	26.7975
370	140	95.7259
385	130	124.127
400	120	78.0088
415	110	72.0374
430	100	60.2728
445	90	48.3627
460	80	35.7395
475	70	29.3504
490	60	27.3416
505	50	18.8825
520	40	18.9486
535	30	21.138
550	20	14.5192
565	10	24.9673

375	130	101.084
390	120	85.9113
405	110	78.3669
420	100	68.3642
435	90	57.9863
450	80	43.0593
465	70	32.2982
480	60	31.6556
510	40	16.8654
525	30	17.6011
540	20	21.128
555	10	13.319
350	140	115.385
365	130	103.175
380	120	98.7997
395	110	79.5795
410	100	74.4044
440	80	51.4082
455	70	36.9753
470	60	32.7308
485	50	29.5764
500	40	17.5543
515	30	14.6855
530	20	16.0397
545	10	14.7473
340	140	114.086
370	120	129.491
385	110	85.4627
400	100	77.2522
415	90	66.5478
430	80	57.0516
445	70	43.7234
460	60	33.9328
475	50	31.6479
490	40	21.3111
505	30	13.8559
520	20	10.4415
535	10	13.1996
345	130	110.036
360	120	108.386
375	110	92.3525
390	100	79.9008
405	90	72.505
420	80	62.2983
435	70	48.9301
450	60	37.6409

465	50	32.238
480	40	27.8426
495	30	15.5206
510	20	11.3858
525	10	9.59913
320	140	122.16
335	130	111.806
365	110	102.244
380	100	84.802
395	90	79.2736
425	70	54.7118
440	60	41.6982
455	50	36.1335
470	40	31.1016
485	30	20.3441
500	20	14.9119
515	10	11.2638
310	140	115.707
340	120	111.4
355	110	121.904
370	100	87.7652
385	90	77.232
400	80	69.7598
415	70	59.3281
430	60	45.1463
445	50	39.1928
475	30	25.5106
490	20	14.6708
505	10	13.3625
300	140	114.061
315	130	119.461
330	120	98.2895
360	100	93.5877
375	90	78.3161
390	80	71.9595
405	70	63.6769
420	60	49.3113
435	50	38.2212
450	40	33.8102
465	30	27.9985
480	20	16.7218
495	10	17.9497
320	120	106.272
350	100	101.094
365	90	81.5194
380	80	70.2678

410	60	54.4712
425	50	38.3838
440	40	35.4788
455	30	27.5688
470	20	22.2575
485	10	16.9775
280	140	99.4174
295	130	114.04
325	110	98.3513
355	90	86.3189
370	80	69.8924
385	70	64.3
400	60	58.3247
415	50	45.436
430	40	39.5927
445	30	29.491
460	20	23.8499
475	10	23.2547
270	140	98.2434
300	120	110.872
315	110	94.6519
330	100	110.177
345	90	88.8275
360	80	74.0053
375	70	61.6315
390	60	60.94
405	50	50.3852
420	40	39.048
435	30	34.0689
450	20	21.5053
465	10	23.2718
275	130	103.653
350	80	76.1827
365	70	63.658
395	50	53.2239
410	40	41.2408
425	30	42.8364
440	20	26.9304
455	10	21.2055
265	130	103.311
280	120	114.189
295	110	111.795
310	100	93.0038
325	90	114.524
340	80	81.4171
355	70	67.2119

370	60	57.6141
385	50	57.8142
400	40	48.0221
415	30	47.9988
430	20	37.8123
445	10	23.1564
255	130	101.553
285	110	124.15
300	100	96.7971
315	90	99.1633
345	70	71.5293
360	60	57.3849
375	50	57.5657
390	40	50.2998
405	30	45.4255
420	20	46.1217
435	10	24.9718
290	100	103.617
305	90	95.5682
320	80	98.1196
335	70	71.1465
350	60	60.7402
395	30	39.6444
410	20	47.2147
425	10	33.5573
250	120	107.786
265	110	113.48
280	100	122.842
295	90	102.505
310	80	96.592
340	60	62.0469
355	50	48.94
385	30	45.0613
400	20	50.0564
415	10	43.5005
255	110	107.194
270	100	119.013
285	90	98.0998
300	80	101.425
315	70	89.4136
330	60	63.5489
345	50	53.288
360	40	47.6883
375	30	49.77
390	20	49.9964
405	10	44.1005

245	110	118.708
260	100	118.886
275	90	113.863
290	80	106.82
305	70	93.7228
335	50	54.8838
365	30	51.3331
380	20	46.9244
395	10	54.3535
250	100	114.161
265	90	117.11
280	80	99.117
295	70	102.496
310	60	86.0752
325	50	55.8951
340	40	43.701
355	30	45.9471
370	20	49.6218
385	10	50.945
225	110	122.128
255	90	122.599
270	80	106.592
285	70	108.054
300	60	87.5035
330	40	45.2458
345	30	38.6538
360	20	48.5097
375	10	47.1147
230	100	118.44
260	80	108.101
275	70	102.364
305	50	78.1706
320	40	54.394
350	20	32.8329
365	10	39.1559
220	100	130.80099
235	90	116.252
265	70	110.925
280	60	106.188
295	50	75.5512
325	30	39.6871
340	20	22.4382
355	10	30.5392
210	100	133.93401
225	90	127.445
240	80	110.507

270	60	102.284
285	50	80.1712
300	40	68.9551
315	30	44.7117
330	20	31.5231
345	10	12.3373
215	90	139.23199
230	80	119.281
245	70	97.0241
275	50	91.2502
290	40	61.1494
335	10	14.3229
205	90	130.517
220	80	128.52499
235	70	104.535
250	60	86.1542
280	40	64.152
295	30	52.6026
310	20	27.9971
325	10	19.7626
195	90	143.582
210	80	134.81799
225	70	115.759
240	60	85.7746
255	50	91.326
285	30	49.0363
315	10	20.7371
200	80	139.35001
215	70	126.366
230	60	91.6676
245	50	85.1932
260	40	67.1471
290	20	45.4006
190	80	144.06799
205	70	144.35201
220	60	104.735
235	50	85.4348
250	40	88.0177
265	30	51.0698
180	80	147.123
195	70	138.297
210	60	126.292
225	50	74.7873
240	40	81.9124
255	30	56.9159
270	20	30.0107

175	70	154.017
190	60	151.847
205	50	112.631
220	40	73.8932
235	30	64.2609
250	20	43.7977
265	10	19.8076
165	70	156.79401
180	60	163.161
195	50	140.282
210	40	68.4876
225	30	64.2701
240	20	44.6206
255	10	24.6449
185	50	148.22301
200	40	95.4068
215	30	50.7187
230	20	42.8613
245	10	16.4699
160	60	153.519
175	50	175.341
190	40	130.778
205	30	67.3516
220	20	39.2996
235	10	27.6279
150	60	175.745
180	40	144.049
195	30	76.1639
210	20	41.1922
225	10	14.412
155	50	154.039
170	40	171.634
185	30	107.574
200	20	52.9242
215	10	22.2623
145	50	153.41499
160	40	144.13901
175	30	119.336
190	20	67.0645
205	10	21.6951
135	50	172.41299
150	40	122.424
165	30	137.077
180	20	74.354
195	10	35.8696
140	40	141.687

155	30	108.058
170	20	74.2866
185	10	42.7314
130	40	144.173
145	30	105.345
160	20	94.077
175	10	53.7435
120	40	183.847
135	30	117.554
150	20	86.1497
165	10	43.099
125	30	155.86501
140	20	71.9158
155	10	58.8041
115	30	178.405
130	20	115.479
145	10	31.615
105	30	196.388
120	20	148.798
135	10	50.73
110	20	146.88699
125	10	88.9646
100	20	142.293
115	10	105.414
90	20	153.33501
105	10	110.712
95	10	115.643
85	10	91.88
75	10	87.7815
0		
0		
0		

Sting/Swift prg: COL14

10			
3			
442			
1			
0			
615	10	1	125.404
610	10	2	159.67
605	10	3	123.077
600	10	4	184.047
595	10	5	243.327
590	10	6	91.3243
585	10	7	135.492

580	10	8	219.94
605	10	1	147.211
600	10	2	102.54
595	10	3	176.619
590	10	4	230.80901
585	10	5	75.7312
580	10	6	105.189
575	10	7	135.748
570	10	8	130.155
595	10	1	125.84
590	10	2	246.92101
585	10	3	364.14999
580	10	4	116.734
575	10	5	149.76401
570	10	6	175.90601
565	10	7	200.392
560	10	8	144.685
560	20	4	125.075
550	20	5	124.899
585	10	1	214.183
580	10	2	411.082
575	10	3	139.81
570	10	4	169.834
565	10	5	193.616
560	10	6	214.56
555	10	7	157.914
550	10	8	157.80901
550	20	4	161.05701
540	20	5	120.223
530	20	6	88.8542
575	10	1	269.82999
570	10	2	110.684
565	10	3	129.94
560	10	4	158.319
555	10	5	122.2
550	10	6	100.352
545	10	7	106.707
540	10	8	110.988
540	20	4	125.466
530	20	5	84.6172
520	20	6	67.0705
565	10	1	134.396
560	10	2	168.689
555	10	3	231.685
550	10	4	113.555
545	10	5	115.486

540	10	6	125.056
535	10	7	135.48399
530	20	4	91.5095
520	20	5	65.2077
410	40	8	177.23399
555	10	1	169.466
550	10	2	244.965
545	10	3	118.616
540	10	4	124.385
535	10	5	142.89
530	10	6	164.144
525	10	7	129.302
520	10	8	106.154
520	20	4	93.6077
400	40	8	181.42799
385	50	7	219.769
545	10	1	82.6428
540	10	2	41.9307
535	10	3	42.2284
530	10	4	52.8434
525	10	5	65.6508
520	10	6	51.4163
515	10	7	43.7308
510	10	8	38.9338
510	20	4	57.6147
500	20	5	55.7359
430	30	8	127.128
535	10	1	60.7492
530	10	2	58.0269
525	10	3	82.4713
520	10	4	109.193
515	10	5	89.2906
510	10	6	78.5197
505	10	7	70.2582
500	10	8	62.7119
490	20	5	52.5967
420	40	6	115.224
400	40	7	136.14
525	10	1	35.2795
520	10	2	58.8286
515	10	3	80.8808
510	10	4	71.7442
505	10	5	66.3167
500	10	6	59.7559
495	10	7	55.7042
490	10	8	58.7076

490	20	4	63.0041
320	60	7	82.7727
515	10	1	55.4285
510	10	2	86.9933
505	10	3	89.7753
500	10	4	88.9221
495	10	5	86.1104
490	10	6	79.2971
485	10	7	90.3956
480	10	8	96.0328
505	10	1	36.3419
500	10	2	40.2355
495	10	3	43.5608
490	10	4	45.0592
485	10	5	44.9799
480	10	6	47.8646
475	10	7	54.336
470	10	8	48.8337
390	40	6	140.412
495	10	1	27.0694
490	10	2	30.5857
485	10	3	34.1532
480	10	4	35.7952
475	10	5	41.1568
450	20	5	51.2273
430	20	7	98.381
485	10	1	24.9334
480	10	2	29.4058
475	10	3	32.8362
470	10	4	41.0967
465	10	5	49.8047
460	10	6	49.9444
450	20	4	50.8034
440	20	5	65.7279
430	20	6	88.8259
420	20	7	113.86
410	20	8	119.057
385	30	7	133.205
370	30	8	166.12801
350	40	7	168.05701
475	10	1	19.032
470	10	2	19.1792
465	10	3	25.0679
460	10	4	31.9341
455	10	5	32.3529
450	10	6	31.5999

445	10	7	34.7977
440	10	8	32.9976
360	40	6	173.67599
340	40	7	152.672
465	10	1	14.0356
460	10	2	18.0288
455	10	3	24.2522
450	10	4	25.3083
445	10	5	25.749
440	10	6	29.424
430	20	4	42.3793
420	20	5	55.375
410	20	6	75.7381
400	20	7	79.3963
365	30	7	127.16
350	30	8	151.45599
350	40	6	155.269
330	40	7	174.616
270	50	8	94.5168
455	10	1	12.0556
450	10	2	16.8884
435	10	5	20.6171
430	10	6	23.1552
425	10	7	27.7785
420	20	4	39.8997
410	20	5	60.3832
355	30	7	125.76
340	30	8	125.734
340	40	6	145.257
445	10	1	14.4309
440	10	2	14.4341
430	10	4	16.0581
330	40	6	128.541
290	40	8	135.90401
435	10	1	12.2996
430	10	2	12.4556
425	10	3	14.1633
400	20	4	49.3403
390	20	5	57.4695
360	20	8	99.46
350	30	6	93.9902
335	30	7	115.318
425	10	1	10.8538
420	10	2	12.8129
415	10	3	14.7225
410	10	4	18.0732

405	10	5	25.8546
325	30	7	132.30099
415	10	1	10.6598
410	10	2	11.8973
405	10	1	9.78377
400	10	2	11.7478
390	10	4	17.2013
395	10	1	9.38985
390	10	2	11.7828
380	10	4	21.1659
385	10	3	12.4148
310	30	6	138.536
280	30	8	179.72301
385	10	1	8.48931
380	10	2	10.0077
360	10	6	27.3902
355	10	7	36.4464
350	10	8	40.8319
330	20	6	79.894
310	20	8	127.894
375	10	1	7.83713
300	20	8	120.256
365	10	1	8.63159
360	10	2	14.6523
355	10	3	19.4034
300	20	7	111.164
250	30	8	211.996
355	10	1	8.5262
350	10	2	13.0955
345	10	3	14.4002
340	10	4	22.2991
335	10	5	27.7782
320	20	4	55.1172
310	20	5	68.3395
300	20	6	100.347
290	20	7	104.211
345	10	1	10.6969
340	10	2	11.71
260	30	6	128.881
245	30	7	176.14301
230	30	8	137.591
230	40	6	140.562
210	40	7	115.764
335	10	1	6.93136
330	10	2	13.6452
325	10	3	20.2168

310	10	6	41.0376
305	10	7	51.3268
300	10	8	56.3455
300	20	4	65.8651
290	20	5	101.338
280	20	6	109.78
220	40	6	120.376
200	40	7	104.345
325	10	1	7.01361
320	10	2	11.5576
240	30	6	173.99899
225	30	7	164.95
210	30	8	117.746
190	40	7	91.6385
315	10	1	15.2971
300	10	4	39.3634
295	10	5	51.9968
290	10	6	59.3693
280	10	8	100.28
280	20	4	88.448
270	20	5	98.3178
260	20	6	132.798
250	20	7	150.258
240	20	8	138.599
295	10	3	34.4193
290	10	4	47.9186
285	10	5	47.4397
280	10	6	74.2894
275	10	7	88.1652
270	10	8	123.034
270	20	4	118.424
260	20	5	123.52
250	20	6	148.66
240	20	7	176.97301
230	20	8	161.804
290	10	2	20.9453
285	10	3	33.7554
280	10	4	45.1368
275	10	5	58.6466
270	10	6	91.8595
265	10	7	92.558
260	10	8	112.892
260	20	4	115.313
240	20	4	105.779
190	30	6	96.7279
175	30	7	107.729

160	30	8	100.432
265	10	1	11.2096
260	10	2	18.5276
255	10	3	37.682
250	10	4	48.7312
245	10	5	63.7632
240	10	6	64.6734
235	10	7	87.5827
230	10	8	110.301
255	10	1	12.9615
250	10	2	24.3515
245	10	3	37.9275
240	10	4	53.2014
235	10	5	56.3589
230	10	6	76.2882
245	10	1	14.7952
240	10	2	21.4246
235	10	3	38.1458
230	10	4	43.6535
225	10	5	63.6585
220	10	6	83.0635
210	20	4	87.761
200	20	5	100.591
190	20	6	112.431
180	20	7	100.901
170	20	8	74.3318
235	10	1	14.3191
230	10	2	23.1417
225	10	3	33.21
220	10	4	51.8893
215	10	5	71.5907
210	10	6	91.659
205	10	7	81.3488
200	10	8	74.6797
225	10	1	19.7452
220	10	2	25.7742
215	10	3	50.7549
210	10	4	71.9294
205	10	5	97.1091
200	10	6	90.0207
215	10	1	15.6993
210	10	2	28.4517
205	10	3	48.8754
200	10	4	72.0573
195	10	5	68.2705
205	10	1	19.5242

200	10	2	28.6461
195	10	3	54.7709
190	10	4	57.2032
195	10	1	17.2405
190	10	2	30.9726
185	10	3	37.3389
180	10	4	39.1317
175	10	5	49.7889
170	10	6	52.6166
160	20	4	65.9874
150	20	5	61.3855
140	20	6	62.8614
130	20	7	76.4181
120	20	8	74.8144
185	10	1	26.6075
180	10	2	36.7656
175	10	3	41.1044
170	10	4	52.6293
165	10	5	55.897
160	10	6	62.4753
155	10	7	57.1381
175	10	1	27.7828
170	10	2	38.2331
165	10	3	56.3956
160	10	4	62.6867
150	10	6	61.4321
145	10	7	72.8154
140	10	8	65.8079
110	20	7	83.9084
100	20	8	167.298
165	10	1	22.4317
160	10	2	40.0862
155	10	3	49.6021
150	10	4	56.8106
145	10	5	49.7505
140	10	6	61.0862
130	20	4	52.7303
155	10	1	21.638
150	10	2	30.6818
145	10	3	36.5783
140	10	4	32.5919
135	10	5	40.5008
130	10	6	37.4218
125	10	7	36.3373
120	10	8	32.9991
145	10	1	24.7672

140	10	2	28.5455
135	10	3	26.4512
130	10	4	33.6111
125	10	5	31.8482
120	10	6	31.1683
110	10	8	45.6264
135	10	1	25.2411
130	10	2	25.3782
125	10	3	34.5631
100	20	4	50.8884
90	20	5	55.7304
80	20	6	114.581
125	10	1	17.3327
120	10	2	27.5893
115	10	3	29.3859
110	10	4	29.5461
105	10	5	26.1536
100	10	6	45.3917
95	10	7	52.1359
90	10	8	49.3833
90	20	4	48.7513
80	20	5	84.5661
115	10	1	16.3455
110	10	2	21.2678
105	10	3	23.0706
100	10	4	20.8889
95	10	5	37.0364
90	10	6	45.6004
80	20	4	52.5991
70	20	5	117.576
105	10	1	8.76607
100	10	2	11.2622
95	10	3	10.1764
90	10	4	19.3233
85	10	5	25.9298
70	10	8	35.9172
70	20	4	60.0575
95	10	1	6.67054
90	10	2	6.95808
60	20	4	66.6571
85	10	1	3.70655
80	10	2	8.11149
55	10	7	37.144
50	10	8	48.4623
75	10	1	4.02533
70	10	2	7.40762

65	10	3	8.56242
65	10	1	4.17638
60	10	2	5.65652
55	10	3	6.68292
50	10	4	9.9505
45	10	5	19.8358
55	10	1	5.60247
50	10	2	7.91323
45	10	3	12.0824
40	10	4	24.3997
35	10	5	34.4169
45	10	1	4.41587
40	10	2	8.11562
35	10	3	17.5562
30	10	4	26.4103
35	10	1	4.23709
30	10	2	10.3668
25	10	3	16.7884
25	10	1	5.89226
20	10	2	10.5232
15	10	1	7.77733
0			
0			
0			

Sting/Swift	prg:	COL	14WN
10			
1			
520			
1			
0			
420	140	102.024	
435	130	108.023	
450	120	79.5929	
465	110	121.674	
480	100	142.011	
495	90	140.789	
510	80	142.37	
525	70	131.73801	
540	60	146.942	
555	50	138.524	
570	40	145.313	
585	30	192.183	
600	20	250.144	
615	10	135.07201	
410	140	98.9533	

425	130	96.2116
440	120	103.994
470	100	116.686
485	90	133.985
500	80	136.162
515	70	134.455
530	60	120.933
545	50	141.55499
560	40	144.452
575	30	155.76199
590	20	165.686
605	10	155.964
400	140	94.2523
415	130	90.387
430	120	90.943
445	110	98.0532
460	100	107.142
475	90	107.531
490	80	127.534
505	70	125.903
520	60	123.29
535	50	110.685
550	40	125.31
565	30	139.177
580	20	149.448
595	10	202.12399
390	140	95.6209
405	130	92.0773
420	120	90.2848
435	110	92.0753
450	100	98.9225
465	90	101.325
480	80	106.245
495	70	124.36
510	60	124.169
525	50	121.46
540	40	110.389
555	30	146.507
570	20	211.09599
585	10	170.58501
380	140	97.1555
395	130	94.3459
410	120	90.2538
425	110	90.3965
455	90	98.2413
470	80	101.261

485	70	105.819
500	60	123.708
515	50	127.065
530	40	123.206
545	30	105.419
560	20	173.76601
575	10	178.763
385	130	96.9136
400	120	89.9937
415	110	86.2456
430	100	85.4346
445	90	87.564
460	80	92.353
475	70	95.3344
490	60	98.6925
505	50	115.567
520	40	116.631
535	30	121.772
550	20	93.3473
565	10	233.103
390	120	91.3571
405	110	88.5016
420	100	84.2009
435	90	82.7349
450	80	82.3201
465	70	89.1166
480	60	91.1259
495	50	95.3407
510	40	111.001
525	30	120.255
540	20	119.371
555	10	97.7816
365	130	101.5
380	120	92.1705
395	110	88.101
410	100	82.3482
440	80	79.1926
455	70	79.9064
470	60	86.045
485	50	89.3864
500	40	95.0168
515	30	100.806
530	20	138.43401
545	10	113.479
340	140	91.0169
370	120	95.5532

385	110	83.2425
400	100	80.9354
415	90	76.2473
430	80	75.5101
445	70	69.5074
460	60	71.0529
475	50	73.9514
490	40	77.8903
505	30	78.1507
520	20	78.2755
535	10	85.0313
330	140	92.26
360	120	98.3475
375	110	87.5735
390	100	85.0832
405	90	77.3248
420	80	73.0541
435	70	67.643
450	60	66.8363
465	50	64.2285
480	40	71.2513
495	30	75.4018
510	20	62.0958
525	10	68.9369
320	140	94.7781
335	130	96.0028
365	110	95.2992
395	90	81.9877
425	70	68.8011
440	60	63.8093
455	50	60.6097
470	40	58.1331
485	30	67.5376
500	20	63.6374
515	10	43.8609
310	140	98.9513
325	130	92.4223
340	120	100.28
355	110	103.398
370	100	87.1
385	90	82.6208
400	80	75.8979
415	70	73.6089
430	60	64.3529
445	50	61.7167
460	40	55.6676

475	30	57.3699
490	20	63.6591
505	10	46.3514
300	140	101.526
315	130	101.743
330	120	100.017
360	100	92.9329
375	90	82.3501
390	80	76.5376
405	70	71.1835
420	60	63.1594
435	50	58.1136
450	40	51.038
465	30	45.6441
480	20	46.4776
495	10	42.2859
290	140	112.655
320	120	102.115
335	110	104.59
350	100	101.135
365	90	85.1883
380	80	80.4566
410	60	63.8149
425	50	57.016
440	40	49.9366
455	30	39.9681
470	20	36.6759
485	10	30.5228
280	140	116.855
295	130	109.028
325	110	104.989
355	90	95.3353
370	80	82.1103
385	70	72.7581
400	60	65.8202
415	50	56.9917
430	40	50.035
445	30	39.7833
460	20	31.1292
475	10	25.1348
270	140	116.747
285	130	108.734
300	120	104.685
315	110	101.215
330	100	106.052
345	90	98.284

360	80	85.1934
375	70	75.017
390	60	62.6842
405	50	52.8712
435	30	38.9277
450	20	26.8558
465	10	20.552
260	140	110.828
275	130	112.779
290	120	107.554
305	110	107.881
320	100	105.494
350	80	94.2305
365	70	78.4989
395	50	54.4836
410	40	45.1676
425	30	37.5727
440	20	27.3091
455	10	17.7398
250	140	130.75301
265	130	113.184
280	120	105.471
295	110	101.849
310	100	100.734
325	90	106.34
340	80	97.011
355	70	80.7513
370	60	68.1758
385	50	54.4393
400	40	41.9125
415	30	33.7536
430	20	26.0885
445	10	15.9297
240	140	139.651
255	130	115.29
270	120	107.099
300	100	100.336
315	90	102.705
345	70	88.6274
360	60	68.1871
375	50	55.7663
390	40	42.1969
405	30	31.7962
420	20	23.1602
435	10	16.2673
230	140	146.034

245	130	122.55
260	120	106.853
275	110	101.592
290	100	94.5856
305	90	98.7629
320	80	96.1528
335	70	86.5162
350	60	72.0801
380	40	42.8929
395	30	31.0226
410	20	21.247
425	10	14.5309
235	130	133.709
250	120	110.135
265	110	103.485
280	100	94.6692
310	80	98.3268
340	60	76.4476
355	50	59.3193
370	40	46.9542
385	30	31.9305
400	20	21.1843
415	10	13.0108
210	140	157.10899
240	120	120.587
255	110	100.551
270	100	98.2238
285	90	92.0244
300	80	92.2207
315	70	86.9256
330	60	80.7703
345	50	62.9156
360	40	49.3236
375	30	31.7557
390	20	20.7798
405	10	12.8551
215	130	150.64301
245	110	105.192
260	100	96.2831
275	90	94.5214
290	80	94.8941
305	70	86.7186
335	50	70.5906
365	30	35.9676
380	20	22.4033
395	10	12.1127

205	130	154.942
220	120	138.83701
250	100	100.263
265	90	98.0243
280	80	90.6931
295	70	92.2282
310	60	82.7461
325	50	76.2183
340	40	55.4892
355	30	38.7072
370	20	22.3579
385	10	11.8515
195	130	160.8
210	120	144.172
225	110	128.502
255	90	97.8425
285	70	89.7124
300	60	83.4582
330	40	60.5341
345	30	38.9461
360	20	22.95
375	10	12.597
200	120	151.83501
215	110	134.70599
230	100	114.015
260	80	95.2598
290	60	86.0684
305	50	77.0283
320	40	64.4272
350	20	26.7587
365	10	11.5845
190	120	157.578
205	110	137.938
220	100	124.421
235	90	101.363
265	70	88.3399
280	60	85.731
295	50	77.6121
325	30	47.8795
340	20	26.5841
355	10	13.7989
180	120	163.118
195	110	145.631
210	100	128.448
225	90	109.003
240	80	94.2703

270	60	81.3707
285	50	73.446
300	40	66.5153
315	30	51.753
330	20	28.6213
345	10	13.2394
185	110	156.119
200	100	132.42101
215	90	118.323
230	80	97.6395
245	70	91.9459
275	50	74.2192
290	40	63.4063
335	10	13.0186
175	110	160.90401
190	100	139.847
205	90	125.187
220	80	104.753
235	70	92.1784
250	60	85.9357
280	40	63.5335
295	30	51.2642
310	20	36.7306
325	10	16.694
165	110	158.024
180	100	144.61
195	90	126.476
210	80	112.616
225	70	92.3051
240	60	87.0377
255	50	79.5984
285	30	49.7088
315	10	17.5798
170	100	155.395
185	90	130.45799
200	80	119.026
215	70	102.362
230	60	88.465
245	50	83.2129
260	40	68.848
290	20	34.5583
160	100	156.92599
175	90	139.85899
190	80	122.36
205	70	111.151
220	60	94.4446

235	50	86.0541
250	40	78.3051
265	30	58.0477
150	100	158.603
165	90	149.60699
180	80	127.431
195	70	114.112
210	60	102.437
225	50	87.9982
240	40	80.4322
255	30	59.1105
270	20	41.0214
145	90	152.16701
160	80	140.214
175	70	117.045
190	60	104.189
205	50	92.1067
220	40	78.1943
235	30	68.386
250	20	40.397
265	10	19.6608
135	90	141.50999
150	80	141.463
165	70	123.879
180	60	102.194
195	50	95.2068
210	40	77.4507
225	30	70.6378
240	20	46.2224
255	10	19.4411
140	80	139.645
155	70	128.077
170	60	108.103
185	50	94.1
200	40	81.8628
215	30	63.5634
230	20	51.4309
245	10	20.4081
130	80	129.064
145	70	124.812
160	60	112.304
175	50	93.9949
190	40	83.5424
205	30	63.0039
220	20	49.36
235	10	25.755

120	80	121.101
135	70	119.92
150	60	111.346
165	50	93.9502
180	40	83.6125
195	30	67.7317
210	20	45.8132
225	10	23.4986
125	70	117.928
140	60	106.362
155	50	94.657
170	40	82.8223
185	30	76.2198
200	20	47.49
215	10	26.4418
115	70	113.409
130	60	105.447
145	50	93.5013
160	40	79.18
175	30	72.7988
190	20	55.4472
205	10	23.232
105	70	101.645
120	60	104.373
135	50	91.2048
150	40	74.7406
165	30	64.9987
180	20	59.4784
195	10	30.0185
110	60	96.6916
125	50	89.6769
140	40	74.4614
155	30	58.0131
170	20	52.1503
185	10	31.944
100	60	85.3777
115	50	84.5218
130	40	76.3734
160	20	44.4273
175	10	33.8741
90	60	77.3644
105	50	78.4626
120	40	74.3197
135	30	63.4623
150	20	45.1493
165	10	30.8237

95	50	67.7843
110	40	67.1488
125	30	59.0213
140	20	48.8069
155	10	29.1039
85	50	63.7668
100	40	55.9603
115	30	53.6589
130	20	45.0524
145	10	30.4544
75	50	57.8558
90	40	49.2776
105	30	44.0236
120	20	37.0408
135	10	28.1309
80	40	48.0136
95	30	40.0684
110	20	31.4016
125	10	26.7989
70	40	47.9653
85	30	33.4018
100	20	30.0804
115	10	18.0445
60	40	46.5041
75	30	34.4284
90	20	24.8423
105	10	17.1435
65	30	35.7782
80	20	18.9772
95	10	11.9493
55	30	36.5929
70	20	19.8346
85	10	9.69056
45	30	31.4042
60	20	23.3156
75	10	7.09866
50	20	21.2323
65	10	9.74069
40	20	17.6115
55	10	9.25456
30	20	18.0136
45	10	8.68424
35	10	8.51842
25	10	9.74061
15	10	13.5221
0		

0
0

Sting/Swift prg: COL15

10

3

212

1

0

615	10	1	8.65297
605	10	3	12.0888
595	10	5	19.4018
605	10	1	5.38023
600	10	2	13.7204
590	10	4	22.2318
585	10	5	25.9343
580	10	6	31.5579
575	10	7	31.2963
570	10	8	19.4409
585	10	3	12.1706
560	10	6	13.148
575	10	1	4.01446
530	20	5	53.0399
520	20	6	49.7162
550	10	4	8.50586
545	10	5	7.63392
555	10	1	6.79701
550	10	2	7.94051
525	10	7	28.6171
525	10	5	14.024
510	20	4	43.8085
500	20	5	75.9078
490	20	6	81.9806
480	20	7	102.016
535	10	1	4.35882
495	10	5	9.68594
485	10	7	24.4207
390	40	6	70.9271
370	40	7	245.744
370	40	6	49.6558
475	10	1	9.9382
465	10	3	20.0837
440	20	4	54.2422
430	20	5	62.9458
420	20	6	62.2622
410	20	7	68.1662

360	30	8	107.637
375	30	7	77.9475
320	40	8	148.24001
350	40	6	193.347
330	40	7	632.94501
295	50	7	396.49899
450	10	2	7.23669
320	40	7	473.797
340	40	6	319.396
445	10	1	18.4031
435	10	1	21.4456
430	10	2	12.278
415	10	5	42.8895
410	10	6	50.6528
370	20	7	80.7992
425	10	1	19.1292
420	10	2	15.4592
415	10	3	24.0801
410	10	4	29.3694
325	30	7	315.50601
270	40	8	198.351
415	10	1	29.1544
410	10	2	20.8849
405	10	3	29.2404
400	10	4	31.7356
395	10	5	36.8241
380	20	4	40.7826
245	50	7	132.07001
405	10	1	32.3678
400	10	2	25.8445
395	10	3	32.9096
390	10	4	33.1289
385	10	5	31.3052
290	40	6	162.28999
270	40	7	181.72701
395	10	1	47.934
340	20	6	64.7489
385	10	1	48.0452
380	10	2	44.9962
375	10	3	47.8249
370	10	4	45.6032
375	10	1	47.9991
370	10	2	39.2816
300	20	8	51.7225
365	10	1	40.0142
360	10	2	36.4156

355	10	3	45.8182
250	30	8	99.3085
355	10	1	39.21
350	10	2	31.2907
345	10	3	45.7328
340	10	4	37.4418
345	10	1	35.338
340	10	2	27.6758
335	10	3	34.2887
330	10	4	40.6634
335	10	1	36.3825
325	10	3	38.8801
310	10	6	39.6588
300	10	8	18.3255
325	10	1	32.5444
315	10	1	38.6988
300	10	4	39.4466
295	10	5	45.915
295	10	3	35.4703
290	10	4	36.7278
270	20	4	23.3273
190	40	6	40.5804
285	10	3	50.2153
280	10	4	15.395
275	10	5	9.33738
260	20	4	28.4757
240	20	4	61.9277
220	20	6	50.8788
200	20	8	84.2343
190	30	6	94.123
160	40	6	63.2658
265	10	1	24.6312
255	10	3	25.8753
250	10	4	47.1303
245	10	5	40.2205
240	10	6	36.1952
255	10	1	22.8203
245	10	3	110.615
240	10	4	71.241
235	10	5	41.3053
200	20	6	80.3035
245	10	1	14.7542
235	10	3	13.6845
190	20	6	51.1696
145	30	7	82.5018
235	10	1	31.1614

230	10	2	16.6976
225	10	1	50.2046
220	10	2	22.7483
215	10	3	29.4153
170	20	6	50.5117
205	10	3	25.5899
200	10	4	58.6581
195	10	5	28.2924
190	10	6	49.4457
185	10	7	28.0135
180	20	4	73.1871
150	20	7	108.446
205	10	1	49.066
195	10	3	23.8592
185	10	5	20.6708
170	10	8	72.4081
180	10	6	37.2696
120	30	6	79.4676
195	10	1	38.194
185	10	3	20.5173
170	10	6	39.8905
160	20	4	45.7398
185	10	1	40.0562
175	10	3	20.4141
175	10	1	36.5955
165	10	3	19.519
155	10	5	26.3125
120	20	6	62.1143
165	10	1	28.4957
155	10	3	21.3663
135	10	7	25.1398
100	20	7	52.9526
145	10	3	19.7179
125	10	7	19.6281
155	10	1	22.8621
120	10	8	50.1423
100	20	6	47.4652
120	20	4	43.5686
145	10	1	24.1796
135	10	3	18.7364
125	10	3	15.6727
110	10	6	49.3417
105	10	7	26.9247
100	20	4	39.1206
115	10	3	23.3782
95	10	7	46.9377

110	10	4	34.7901
105	10	5	51.0192
90	10	8	47.4886
90	20	4	45.2253
115	10	1	10.9076
110	10	2	32.4831
105	10	3	29.2093
100	10	4	53.8608
90	10	6	45.1779
105	10	1	14.4501
100	10	2	37.8282
90	10	4	33.49
80	10	6	43.5195
70	10	8	46.924
70	20	4	48.307
95	10	1	15.8368
90	10	2	22.5076
60	10	8	26.1219
60	20	4	32.336
85	10	1	20.3708
65	10	5	26.1395
75	10	3	19.288
55	10	7	27.3688
65	10	3	15.7979
50	10	6	17.9631
55	10	5	21.4193
65	10	1	29.3798
55	10	3	42.0435
55	10	1	18.3098
45	10	3	22.0993
40	10	4	20.4498
45	10	1	15.9981
35	10	3	21.9196
35	10	1	15.1574
25	10	3	13.4338
25	10	1	13.9625
15	10	1	8.31694
0			
0			
0			