

**Development of a Computerized Version  
of the Universal Soil Loss Equation  
and the USGS Pollutant Loading Functions**

by

Kenneth Espiritu

Project submitted to the Faculty of the  
Virginia Polytechnic Institute and State University  
in partial fulfillment of the requirements for the degree of

Master of Engineering

in

Civil Engineering

David F. Kibler, Chairman

06/18/97  
Blacksburg, Virginia

**Development of a Computerized Version  
of the Universal Soil Loss Equation  
and the USGS Pollutant Loading Functions**

by

Kenneth Espiritu

Dr. David F. Kibler, Chairman

**(ABSTRACT)**

A computerized program of soil loss and pollutant loading equations was developed in a Windows PC environment. The program implements the Universal Soil Loss Equation (USLE), the Modified Universal Soil Loss Equation (MUSLE), Roehl's sediment delivery ratio equation, and a sediment delivery ratio equation based on both the USLE and the MUSLE. Also implemented into the program were ten pollutant loading equations based on the USGS Nationwide Regression Equations (NRE) for predicting water quality in urban runoff. The programs developed here will become a part of the Virginia Tech/Penn State Urban Hydrology Model (VT-PSUHM).

## **Acknowledgments**

First, I would like to thank my advisor Dr. David Kibler for giving me this opportunity to work on this project. His guidance, support, and encouragement helped me finish this project on time. Next, I would like to thank Dr. G.V. Loganathan for offering financial aid and advice during graduate school and to Dr. Panayiotis Diplas for providing me a well rounded education in the classroom. I would also like to extend thanks to Dr. Theo Dillaha for being a part of my examining committee and for critiquing my report. Finally, I would like to thank Dr. William Cox for his support and guidance throughout my graduate career.

During my undergraduate years, I would like to thank Dr. Joseph Sherrard for his suggestions and advice while I was a undergraduate at Mississippi State University. In addition, I would especially want to express my gratefulness to Dr. Victor Zitta for inspiring me to specialize in water resources. His classes were influential in making my decision.

Thanks go to Thanasis Papanicolaou and Newland Agbenowisi for their insight and friendship throughout my graduate career. I would also like to thank all of the Hydrosystems graduate students I have met during graduate school for their support and encouragement.

Finally, special thanks go to my parents for which none of this would have been possible without their support and love. They have always been there in my time of need and have always encouraged me in my endeavors.

## Table of Contents

Abstract .....	ii
Acknowledgments .....	iii
Table of Contents .....	iv
List of Figures.....	v
List of Tables.....	vi
Chapter 1 Introduction.....	1
1.1 Problem Statement.....	1
1.2 Goals and Objectives .....	2
Chapter 2 Background and Development of the Universal Soil Loss Equation .....	3
2.1 Universal Soil Loss Equation (USLE).....	3
2.1.1 Rainfall-Runoff Erosivity Index, R .....	3
2.1.2 Soil-erodibility Factor, K.....	5
2.1.3 Length-slope Factor, LS.....	7
2.1.4 Cropping and Management Factor, C.....	9
2.1.5 Conservation Practice Factor, P.....	11
2.1.6 Universal Soil Loss Equation Limitations.....	12
2.2 Modified Universal Soil Loss Equation (MUSLE).....	12
2.3 Sediment Delivery Ratio.....	13
2.4 Roehl's Sediment Delivery Ratio Equation.....	13
2.5 Pollutant Load Equations - USGS Nationwide Regression Equations Method (NRE).....	14
Chapter 3 Computer Program Development.....	18
3.1 Program Overview .....	18
3.1.1 Program Features .....	18
3.1.2 Program Constraints and Limitations .....	18
3.2 Program Modules.....	18
3.2.1 Universal Soil Loss Equation Module.....	19
3.2.3 Roehl's Sediment Delivery Ratio Module.....	31
3.2.4 Sediment Delivery Ratio Module.....	32
3.2.5 Pollutant Loading Equations Module.....	35
Chapter 4 Program Verification .....	36
4.1 Universal Soil Loss Equation Verification .....	36
4.2 Modified Universal Soil Loss Equation Verification.....	37
4.3 Roehl's Sediment Delivery Ratio Verification.....	39
4.4 Sediment Delivery Ratio Verification.....	39
4.5 Pollutant Loading Verification.....	41
Appendix A Regression Equations Used in the Program for the Soil-erodibility Factor .....	43
References .....	48
Vita .....	50

## List of Figures

Figure 1 - Iso-erodent Map of the Annual Rainfall Energy Factor .....	4
Figure 2 - Soil Erodibility Nomograph for Determining (K) Factor for U.S. Soils.....	6
Figure 3 - Length-slope Factor (LS) for Different Slopes.....	8
Figure 4 - Fifteen Rainfall Zones in the United States.....	16
Figure 5 - Screenshot of Startup Menu.....	19
Figure 6 - Program Flowchart for USLE Module .....	19
Figure 7 - Screenshot of USLE Module Input Form.....	20
Figure 8 - Screenshot of USLE Module Output Form .....	21
Figure 9 - Screenshot of R Sub-module .....	22
Figure 10 - Screenshot of K Sub-module, Five Parameters .....	23
Figure 11 - Screenshot of K Sub-module, Two Parameters.....	23
Figure 12 - Screenshot of LS Sub-module .....	24
Figure 13 - Screenshot of C Sub-module, Agriculture.....	25
Figure 14 - Screenshot of C Sub-module, Construction .....	26
Figure 15 - Screenshot of P Sub-module, Agriculture .....	27
Figure 16 - Screenshot of P Sub-module, Construction.....	27
Figure 17 - Program Flowchart for MUSLE Module.....	28
Figure 18 - Screenshot of MUSLE Module Input Form .....	29
Figure 19 - Screenshot of (Q-q <sub>p</sub> ) Sub-module .....	29
Figure 20 - Screenshot of MUSLE Module Output .....	30
Figure 21 - Program Flowchart for Roehl's Equation.....	31
Figure 22 - Screenshot of Roehl's Sediment Delivery Ratio Module.....	32
Figure 23 - Program Flowchart for Sediment Delivery Ratio Module.....	32
Figure 24 - Screenshot of Sediment Delivery Ratio Input Form.....	33
Figure 25 - Screenshot of Sediment Delivery Ratio Output Form.....	34
Figure 26 - Program Flowchart for Pollutant Loading Module.....	35
Figure 27 - Screenshot of NRE Pollutant Loading Module .....	35
Figure 28 - Hydrograph for MUSLE Example.....	38
Figure 29 - Storm Hyetograph for SDR Example.....	40
Figure 30 - Storm Hydrograph for SDR Example.....	40

## **List of Tables**

Table 1 - Magnitude of Soil Erodibility Factor, K.....	7
Table 2 - Slope Factor Dependent on Field Slope.....	8
Table 3 - Values of C for Cropland, Pasture, and Woodland.....	9
Table 4 - C-Values and Slope-Length Limits (LS) for Construction Sites.....	10
Table 5 - Values of P for Agricultural Lands.....	11
Table 6 - Values of P for Construction Sites.....	11
Table 7 - Regression Coefficients for Indicated Explanatory Variables.....	14
Table 8 - Annual and Individual Storm Statistic Typical Values for Fifteen Rainfall Zones in the United States.....	17

# Chapter 1 Introduction

## 1.1 Problem Statement

Soil erosion has become one of the most damaging water quality problems in the world today. This is largely produced by man's continuing impact on the natural landscape as undeveloped watersheds change to agricultural fields and pastures, thereby increasing soil erosion due to the land disturbing effects of cultivation. Urbanization has also led to more soil erosion from construction sites where there are exposed soils. Such land-disturbing activities can be quite damaging to the aquatic ecosystem and can carry major pollutants to receiving water bodies (Novotony, 1993).

Water and wind are the predominate causes of soil erosion. In most areas, water is the primary cause of erosion. Erosion by rainfall is caused when there is no vegetative cover to dissipate the kinetic energy in a raindrop. Soil particles are then dislodged when the raindrop impacts the soil. The dislodged soil particles then either runoff into streams and rivers or are redeposited onto the field. Also, vegetative roots resist the shearing effects on the soil due to rainfall runoff reducing soil erosion. Soil loss is defined as the total amount of soil eroded, but may be redeposited onto the field. In contrast, sediment yield is the sum of eroded soil minus the sediment which is deposited into depressions or along the boundaries of the field.

Erosion prediction measurements started in the U.S. after the "dust bowl" erosion in the 1930's. In 1965, the U.S. Department of Agriculture (USDA) developed the well-known Universal Soil Loss Equation (USLE). Requirements for the USLE were that it had to be simple to solve and used factors which were readily available for a particular site (Wischmeier, 1976). Later, the USLE was modified and extended to allow for calculations of sediment yield which lead to the development of the Modified Universal Soil Loss Equation (MUSLE) (Williams, 1977). In the 1990's the USLE was upgraded again to the Revised Universal Soil Loss Equation (RUSLE) (Renard et al., 1991). Development of an erosion prediction model based on physically based equations has lead to the introduction of the Water Erosion Prediction Project (WEPP) (Foster, 1991). Today, although the USLE is an empirical equation, it is used because of the simple calculations required and the factors which are readily available for a site. Because of this, the USLE is still widely popular today.

## **1.2 Goals and Objectives**

The primary objective of the project was to implement the universal soil loss equations into a user-friendly program. Visual Basic 4.0 was chosen as the programming language because the programs from this project will become a part of Virginia Tech/Penn State Urban Hydrology Model (VT-PSUHM) which was also written in Visual Basic. In addition, data files from VT-PSUHM were integrated into the project to allow use of hyetographs and hydrographs in the sediment yield and sediment delivery equations. Later in the project development, the USGS pollutant loading equations were added to the project.



## **Chapter 2 Background and Development of the Universal Soil Loss Equation**

### **2.1 Universal Soil Loss Equation (USLE)**

The universal soil loss equation was developed by the Agricultural Research Service of the USDA and Purdue University (Novotony, 1993). It is used to estimate long-term annual soil loss caused by water erosion. The USLE predicts soil loss based on rainfall patterns, soil type, cropping management, length and slope of the area in question, and conservation practices. The USLE is used primarily to calculate sheet and rill erosion it does not predict soil loss from gully, channel, or wind erosion. Nor does the USLE provide direct sediment yield estimates (Novotony, 1993). Since, the USLE was based on plot lengths of 22 meters, extrapolation to larger lengths was not recommended by the authors. The original equation is:

$$A = R \cdot K \cdot L \cdot S \cdot C \cdot P \quad (1)$$

where:

A = Average soil loss in tonnes/ha for a given storm or annual period

R = Rainfall and runoff erosivity index factor

K = Soil-erodibility factor, tonnes/ha (per unit of the erosion index)

L = Slope length factor, dimensionless

S = Slope factor, dimensionless

C = Cropping management (vegetative cover) factor, dimensionless

P = Conservation (erosion-control) practice factor, dimensionless

#### **2.1.1 Rainfall-Runoff Erosivity Index, R**

The rainfall-runoff erosivity index describes the erosion due to both rainfall and surface runoff. Average annual R factors can be obtained from a iso-erodent map given by Figure 1.

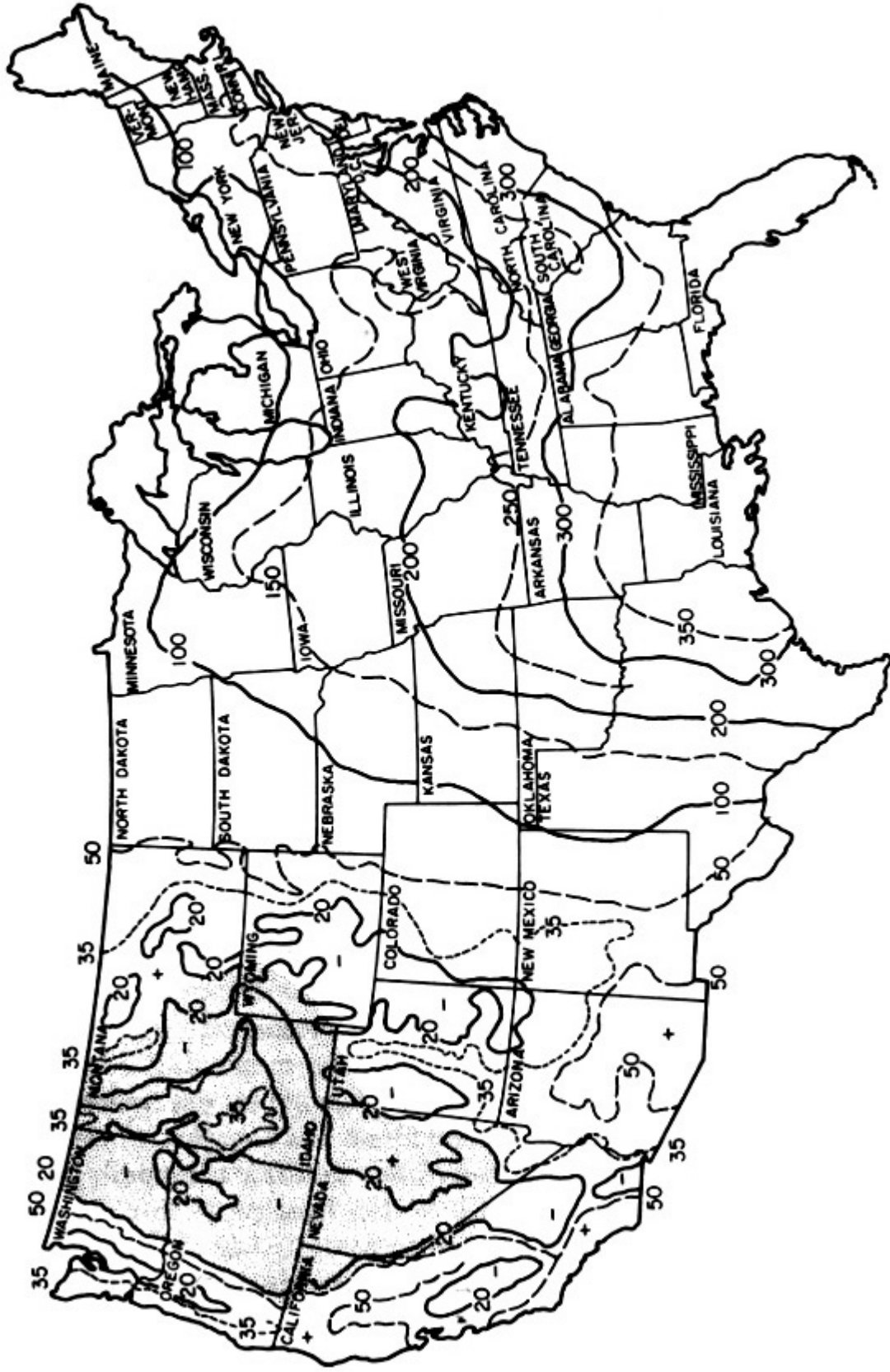

Figure 1 - Iso-erodent Map of the Annual Rainfall Energy Factor in (tons/acre) (Stewart et al., 1975).

Rainfall erosivity index, R, is calculated for a single storm from the sum of all E·D products in each rainfall period in a given storm.

$$R_r = \frac{\sum_{i=1}^n (E_i D_i)}{100} I_{30} \quad (2)$$

where:

$R_r$  = rainfall energy factor for a single storm, tonnes/ha

$E_i$  = kinetic energy of rainfall during the I-th portion of a storm, tonnes-m/ha-cm

$E_i = 210 + 89 \log_{10} (I_i)$  for  $I_i < 7.72$  cm/hr

$E_i = 289$  for  $I_i > 7.72$  cm/hr

$I_i$  = rainfall intensity during the I-th period of the storm, cm/hr

$D_i$  = rainfall during the time interval I, cm

$I_{30}$  = maximum 30-minute rainfall intensity for the storm, cm/hr

i = rainfall hyetograph time interval

n = number of rainfall hyetograph time intervals

### 2.1.2 Soil-erodibility Factor, K

The soil erodibility factor, K, represents the inherent erodibility of the soil and the units are tonnes/per unit of the rainfall erosivity index. Wischmeier determined that there are five soil parameters that affect the soil erodibility factor for soils. These were: percent silt plus very fine sand, percent sand greater than 0.10 mm and less than 2.0 mm, percent organic matter, soil structure, and soil permeability. A soil erodibility nomograph (Figure 2) was created from which K can be obtained. Also, Stewart provided a table (Table 1) which listed various magnitudes of soil erodibility based on soil type and organic matter content.

#### Procedure for Figure 2:

With appropriate data, enter scale at left and proceed to points representing the soil's percent sand (0.10-2.0 mm), percent organic matter, structure, and permeability, in that sequence. Interpolate between plotted curves. The dotted line illustrates procedure for a soil having:

silt+very fine sand 65%

sand 5%

organic matter 2.8%

structure 2

permeability 4

Solution:  $K=0.31$ .

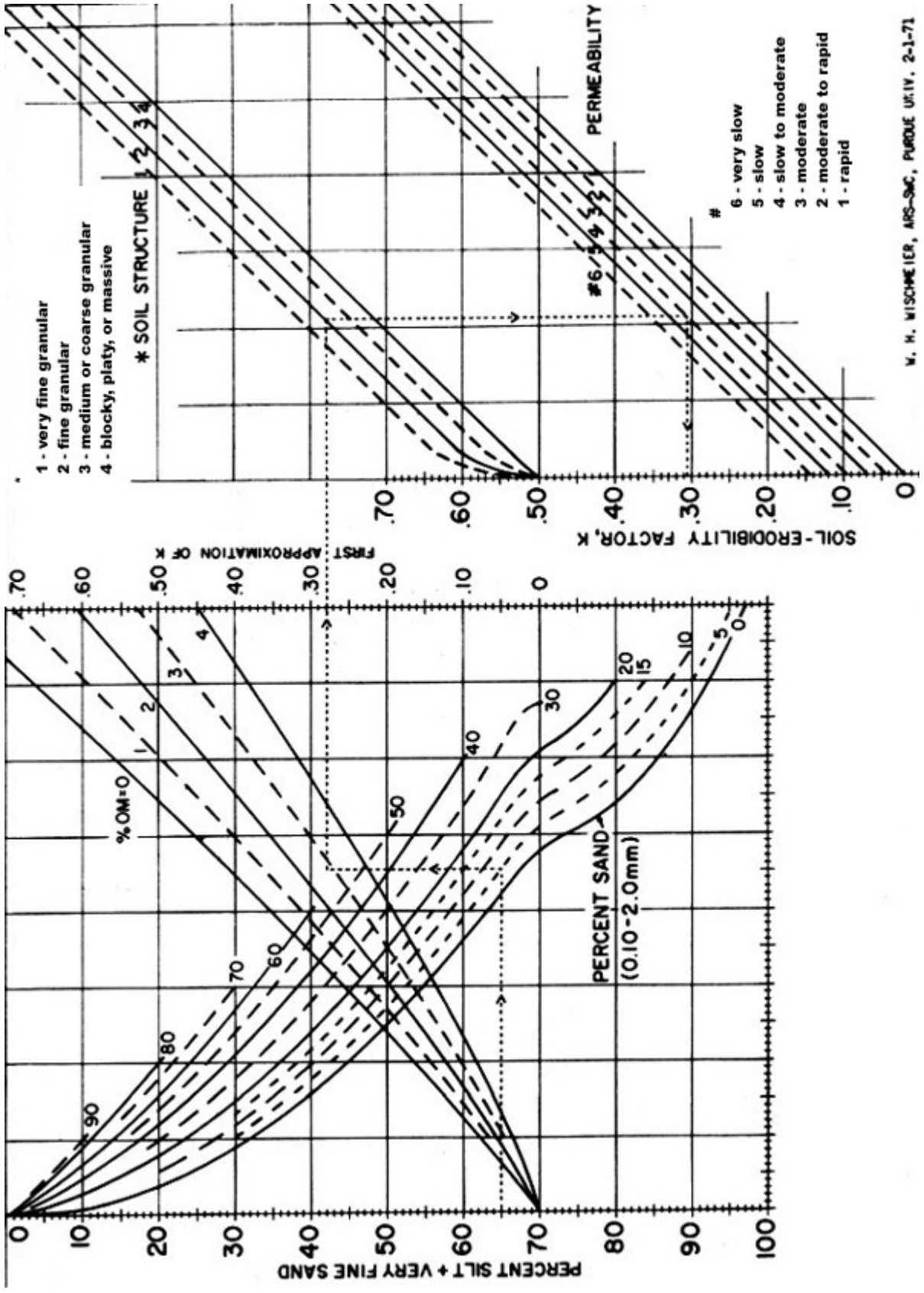

Figure 2 - Soil Erodibility Nomograph for Determining (K) Factor for U.S. Soils (Wischmeier et al., 1971).

**Table 1 - Magnitude of Soil Erodibility Factor, K (Stewart et al., 1975).**

Technical Class	K for Organic Matter Content (%)		
	0.5	4	2
Sand	0.05	0.03	0.02
Fine sand	0.16	0.14	0.10
Very fine sand	0.42	0.36	0.28
Loamy sand	0.12	0.10	0.16
Loamy fine sand	0.24	0.20	0.16
Loamy very fine sand	0.44	0.38	0.30
Sandy loam	0.27	0.24	0.19
Fine sandy loam	0.35	0.30	0.24
Very fine sandy loam	0.47	0.41	0.35
Loam	0.38	0.34	0.29
Silt loam	0.48	0.42	0.33
Silt	0.60	0.52	0.42
Sandy clay loam	0.27	0.25	0.21
Clay loam	0.28	0.25	0.21
Silty clay loam	0.37	0.32	0.26
Sandy clay	0.14	0.13	0.12
Silty clay	0.25	0.23	0.19
Clay		0.13-0.20	

### 2.1.3 Length-slope Factor, LS

The length-slope factor is adjusted for field lengths which deviates from the standard to 22.1 m (72.6 ft) with Equation 3. LS is affected by the length of the field and the slope of the field. The length-slope factor is given by:

$$LS = \left( \frac{L}{22.1} \right)^M (0.065 + 0.0454 S + 0.0065 S^2) \quad (3)$$

where:

L = field slope length, meters

S = field slope, %

M = slope factor based on field slope percent, Table 2

**Table 2 - Slope Factor Dependent on Field Slope**

Slope %	M
<1	0.2
1 to 3	0.3
3 to 5	0.4
>5	0.5

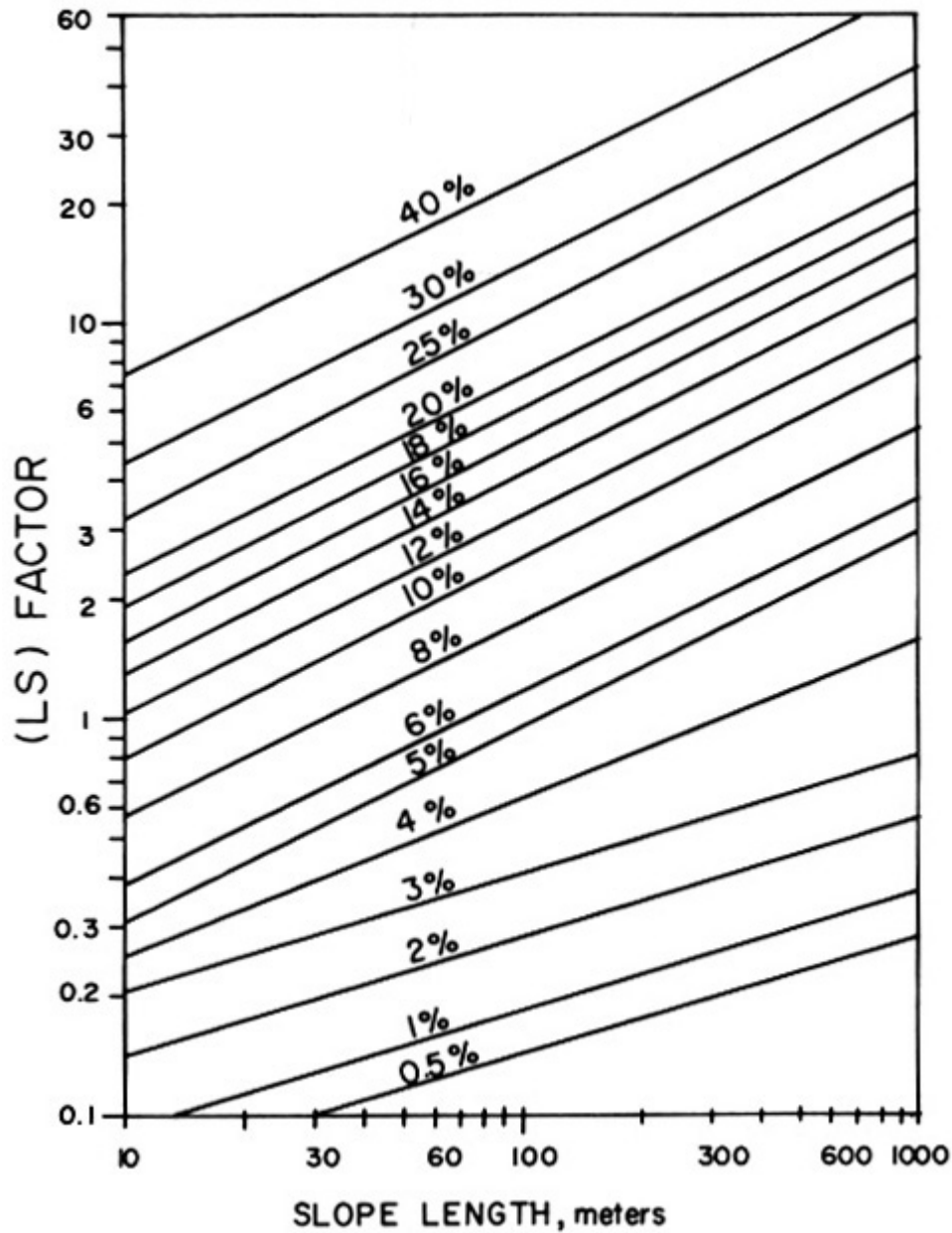

**Figure 3 - Length-slope Factor (LS) for Different Slopes (Stewart et al., 1975).**

### 2.1.4 Cropping and Management Factor, C

The crop management factor, C, is used to describe conservation practices such as crop rotation, tillage practice, residue management, crop cover and crop productivity. In general, C is used for management techniques which protect the exposed soil surface from raindrop impact. Tables 3 and 4 show typical C values for agricultural and construction land-uses respectively.

**Table 3 - Values of C for Cropland, Pasture, and Woodland (Stewart et al., 1975; Wischmeier and Smith, 1965; and Wischmeier, 1972).**

Land Cover or Land Use	C
Continuous fallow tilled up and down slope	1.0
Shortly after seeding prior to harvesting	0.3-0.8
For crops during main part of growing season	
Corn	0.1-0.3
Wheat	0.05-0.15
Cotton	0.4
Soybean	0.2-0.3
Meadow	0.01-0.02
For permanent pasture, idle land, unmanaged woodland	
Ground cover 85% - 100%	
As grass	0.003
As weeds	0.01
Ground cover 80%	
As grass	0.01
As weeds	0.04
Ground cover 60%	
As grass	0.04
As weeds	0.09
For managed woodland	
Tree canopy of 75% - 100%	0.001
Tree canopy of 40% - 75%	0.002-0.004
Tree canopy of 20% - 40%	0.003-0.01

**Table 4 - C-Values and Slope-Length Limits (LS) for Construction Sites (Ports, 1975).**

Mulch				
Type	Application (Mg/ha)	Slope (%)	C	LS
No mulch or seeding		All	1.0	
Straw or hay tied down by anchoring and tracking equipment on slope	2.25	<5	0.2	60
	2.25	6-10	0.2	30
	3.4	<5	0.12	90
	3.4	6-10	0.12	45
	4.5	<5	0.06	100
	4.5	6-10	0.06	60
	4.5	11-15	0.07	45
	4.5	16-20	0.11	30
	4.5	21-25	0.14	23
	Crushed stone	300	<15	0.05
300		16-20	0.05	45
300		21-33	0.05	30
540		<20	0.02	90
540		21-35	0.02	60
Wood chips	15	<15	0.08	23
	15	16-20	0.08	15
	27	<15	0.05	45
	27	16-20	0.05	23
	56	<15	0.02	60
	56	16-20	0.02	45
	56	21-33	0.02	30
Asphalt emulsion 12 m <sup>3</sup> /ha			0.03	
Temporary seeding with grain or fast-growing grass with		During first 6 weeks of growth	After the 6 <sup>th</sup> week of growth	
No mulch		0.70	0.10	
Straw	2.25	0.20	0.07	
Straw	3.4	0.12	0.05	
Stone	300	0.05	0.05	
Stone	540	0.02	0.02	
Wood chips	15	0.08	0.05	
Wood chips	27	0.05	0.02	
Wood chips	56	0.02	0.02	
Sod		0.01	0.01	



### 2.1.5 Conservation Practice Factor, P

The conservation factor, P is used to represent erosion control land practices. The P factor is described as a practice which prevents dislodged soil particles from leaving the field. This type of protection would include terracing, contour farming, strip cropping, and sedimentation basins. Tables 5 and 6 give values of P for agriculture and construction land-uses.

**Table 5 - Values of P for Agricultural Lands (Wischmeier and Smith, 1965).**

Slope (percent) Crops	Contouring	Strip Cropping and Terracing	
		Alternate Meadows	Closegrown
0-2.0	0.6	0.30	0.45
2.1-7.0	0.5	0.25	0.40
7.1-12.0	0.6	0.30	0.45
12.1-18.0	0.8	0.40	0.60
18.1-24.0	0.9	0.45	0.70
>24		-1.0-	

**Table 6 - Values of P for Construction Sites (Ports, 1973).**

Erosion Control Practice	P
Surface Condition with No Cover	
Compact, smooth, scraped with bulldozer or scraper up and down hill	1.30
Same as above, except raked with bulldozer and root-raked up and down hill	1.20
Compact, smooth, scraped with bulldozer or scraper across slope	1.20
Same as above, except raked with bulldozer and root raked across slope	0.90
Loose as a disked plow layer	1.00
Rough irregular surface, equipment tracks in all directions	0.90
Loose with rough surface >0.3 meter depth	0.80
Loose with smooth surface <0.3 meter depth	0.90
Structures	
Small sediment basins	
0.09 ha basin/ha	0.50
0.13 ha basin/ha	0.30
Downstream sediment basin	
With chemical flocculants	0.10
Without chemical flocculants	0.20
Erosion control structures	
Normal rate usage	0.50
High rate usage	0.40
Strip building	0.75

### 2.1.6 Universal Soil Loss Equation Limitations

Wischmeier gave several warnings on the applicability and limitations of the USLE (Wischmeier, 1976). Because the USLE is an empirical equation, there are experimental and prediction errors inherent in it. In addition, the factors involved in the USLE do not represent real physical processes. Since the USLE was developed from cropland data, extensions to range land, forest land and construction sites should be done with caution. Also, Wischmeier warned against using just one length slope factor for a complex watershed. He suggested that the watershed should be divided into appropriate subareas for a proper analysis.

Primarily, the USLE was designed to be used by soil conservation planners and technicians. But, it has been extended and updated by both the Modified Universal Soil Loss Equation (MUSLE) and the Revised Universal Soil Loss Equation (RUSLE) (Renard, 1991). These modifications are described below.

### 2.2 Modified Universal Soil Loss Equation (MUSLE)

This equation is a modification of the USLE by replacing the rainfall-runoff erosivity factor  $R$ , with a runoff factor  $(Q \times q_p)^{0.56}$ . This allows the use of a hydrological model for simulating runoff. Thus, the MUSLE improves sediment yield estimates and eliminates the need for delivery ratios required by the USLE. The USLE requires delivery ratios because the rainfall-runoff erosivity factor represents soil detachment only and not soil transport. The runoff factor of the MUSLE, in contrast, represents the energy for both soil detachment and sediment transport. The basic MUSLE equation is:

$$Y = C_1 (Q q_p)^{0.56} K L S C P \quad (4)$$

where:

$Y$  = total sediment yield from an individual storm, tons or tonnes

$C_1$  = conversion factor of 95 or 11.8 for English or S.I. units respectively

$Q$  = storm runoff volume, ac-ft or  $m^3$

$q_p$  = peak runoff rate, cfs or  $m^3/s$

$K$  = soil-erodibility factor, tons/acre (per unit of the erosion index)

$L$  = slope length factor, dimensionless

$S$  = slope factor, dimensionless

$C$  = cropping management (vegetative cover) factor, dimensionless

$P$  = conservation (erosion-control) practice factor, dimensionless

In tests with data from Texas, Oklahoma, Mississippi, Iowa, Nebraska, and Idaho. The MUSLE usually explained 80 percent or more of the variation in individual storm sediment yield for each watershed. The sites used in developing the MUSLE ranged from areas of 0.01 to 234  $km^2$  and slopes ranged from less than 1 to about 30 percent (Williams, 1977).

### 2.3 Sediment Delivery Ratio

The sediment delivery ratio is the percentage of eroded soil which enters a water body at the bottom of the area under analysis. Estimates from the delivery ratio can be used in planning both control and water utilization structures such as dams, diversion channels, and debris basins (Vanoni, 1975). The delivery ratio can be estimated by substituting the USLE and the MUSLE into the delivery ratio equation.

$$DR = \frac{Y}{AW} = \frac{95(Qq_p)^{0.56} KLSCP}{RKLSCPW} = \frac{95(Qq_p)^{0.56}}{RW} \quad (5)$$

where:

DR = delivery ratio

Q = storm runoff volume, ac-ft

q<sub>p</sub> = peak runoff rate, cfs

R = rainfall-runoff erosivity index factor, tons/acre

W = watershed area, acres

### 2.4 Roehl's Sediment Delivery Ratio Equation

Based on 15 reservoirs in the Piedmont of Georgia and North and South Carolina, Roehl measured the sediment delivery in these regions (Roehl, 1962). The resulting statistical equation is based on geomorphological parameters of the watershed which include watershed area, watershed relief and length, and the stream bifurcation ratio. Roehl estimated erosion with the USLE and developed the following sediment delivery ratio equation:

$$\log_{10} DR = 4.5 - 0.23 \log_{10} 10W - 0.51 \log_{10} \left( \frac{L}{R} \right) - 2.79 \log_{10} BR \quad (6)$$

where:

DR = sediment delivery ratio, %

W = watershed drainage area, km<sup>2</sup>

L/R = watershed length to relief ratio (the watershed length measured from parallel to the main drainageway divided by elevation difference from drainage divide to outlet)

BR = the weighted mean bifurcation ratio, ratio of number of streams of a given order to the number in the next higher order within the study area

## 2.5 Pollutant Load Equations - USGS Nationwide Regression Equations Method (NRE)

The NRE is a set of regression equations which were developed from water quality data collected across the U.S. in the Nationwide Urban Runoff Program (Athayde, 1983) and analyzed by Tasker and Driver of the U.S. Geological Survey in 1988. These equations include in drainage area, basin imperviousness, mean annual rainfall, mean minimum January temperature, and general land use categories (Debo and Reese, 1995). The NRE can estimate mean loads for chemical oxygen demand, suspended solids, dissolved solids, total nitrogen, total ammonia plus nitrogen, total phosphorus, dissolved phosphorous, total copper, total lead, and total zinc (Tasker and Driver, 1988). The equation is

$$M = 10^{[a+b\sqrt{DA}+cIA+dMAR+eMJT+fX^2]} BCF \quad (7)$$

where:

M = mean load associated with a runoff event, pounds

DA = total contributing drainage area, square miles

IA = percent of total contributing drainage area, %

MAR = Mean annual rainfall, inches

MJT = Mean minimum January temperatures, degrees Fahrenheit

BCF = Bias Correction Factor

a, b, c, d, e, and f are coefficients from Table 7.

**Table 7 - Regression Coefficients for Indicated Explanatory Variables (Tasker and Driver, 1988).**

Dependent Variable	Regression Constant	$\sqrt{DA}$	IA	MAR	MJT	X2	Bias Correction Factor
W	a	b	c	d	e	f	(BCF)
COD	1.1174	2.0069	0.0051				1.298
SS	1.5430	1.5906		0.0264	-0.0297		1.521
DS	1.8449	2.5468			-0.0232		1.251
TN	-0.2433	1.6383	0.0061			-0.4442	1.345
AN	-0.7282	1.6123	0.0064	0.0226	-0.0210	-0.4345	1.277
TP	-1.3884	2.0825		0.0234	-0.0213		1.314
DP	-1.3661	1.3955					1.469
CU	-1.4824	1.8281					1.403
PB	-1.9679	1.9037	0.0070	0.0128	-0.0141		1.365
ZN	-1.6302	2.0392	0.0072				1.322

Dependent Variables:

COD = Chemical Oxygen Demand, lbs

SS = Suspended Solids, lbs

DS = Dissolved Solids, lbs

TN = Total Nitrogen, lbs

AN = Total Ammonia plus Nitrogen, lbs

TP = Total Phosphorous, lbs

DP = Dissolved Phosphorus, lbs

CU = Total Copper, lbs

PB = Total Lead, lbs

ZN = Total Zinc, lbs

These equations can be used to predict mean annual or storm loads in areas ranging from 0.015 to 1 mi<sup>2</sup> (Tasker and Driver, 1988). Also during winter months, there will usually be very little runoff due to snowfall. So, the regression equations are valid only during the April through October season in places with significant snowfall.

Mean annual pollutant load can be estimated by locating the site in question on the map of Figure 4 and identifying the rainfall zone. Next, Table 8 is used to determine the expected number of storms/year in the rainfall zone. The total annual pollutant loading is then calculated as:

$$\text{Mean Annual Load} = (M) (\text{Annual No. of Storms}) \quad (8)$$

where:

Mean Annual Load = the annual pollutant loading, lbs/yr.

M = the mean pollutant loading, lbs/storm

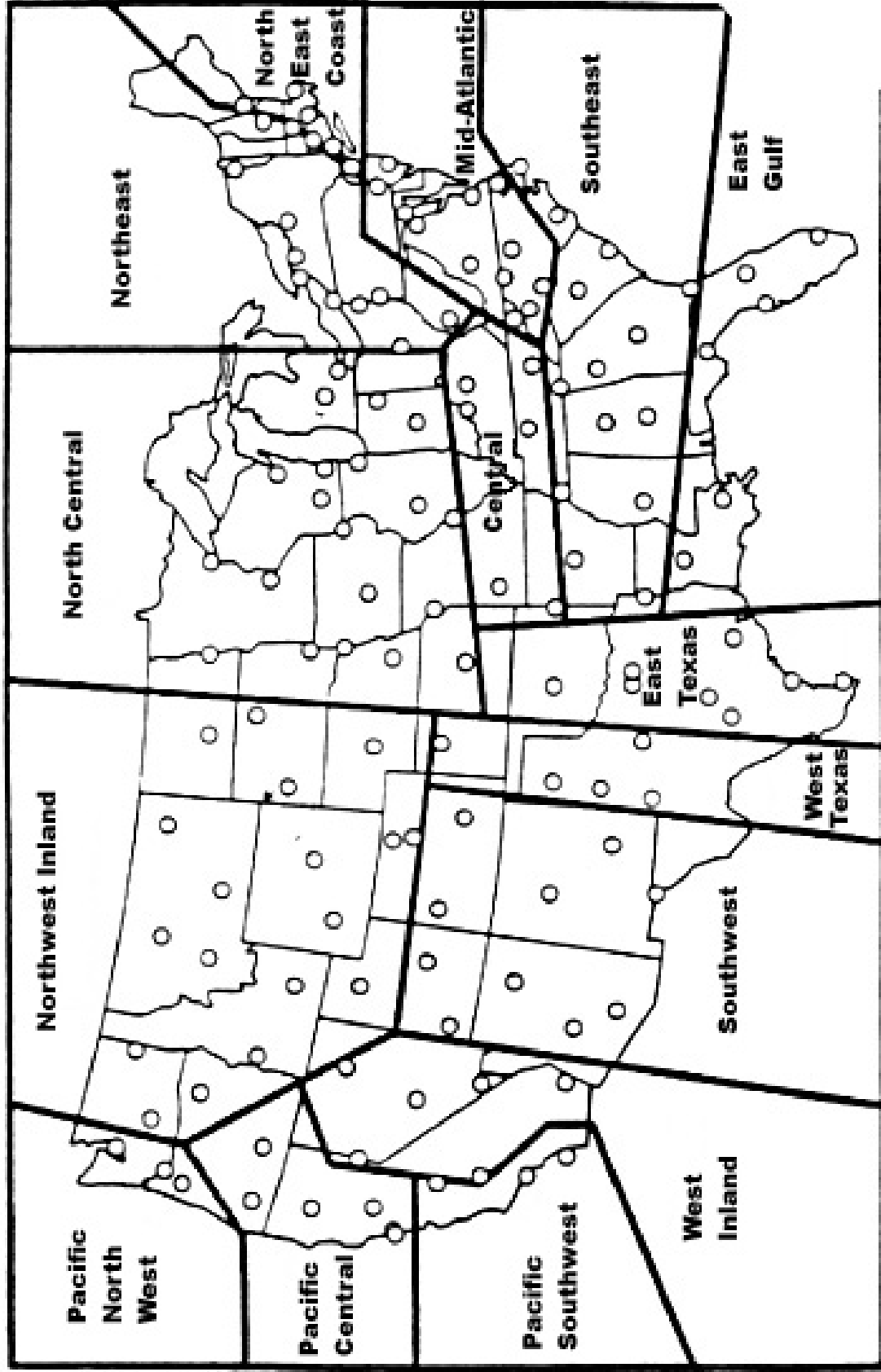

Figure 4 - Fifteen Rainfall Zones in the United States (From Driscoll et al, 1989).

**Table 8 - Annual and Individual Storm Statistic Typical Values for Fifteen Rainfall Zones in the United States (From Driscoll et al., 1989).**

Rainfall Zone	Annual Storm Depth (in)		Annual No. of Storms		Storm Separation (hours)		Duration (hours)		Intensity (in/hr)		Volume (inches)	
	Avg	CV	Avg	CV	Avg	CV	Avg	CV	Avg	CV	Avg	CV
Northeast	34.6	0.18	70	0.13	126	0.94	11.2	0.81	0.067	1.23	0.50	0.95
Northeast coastal	41.4	0.21	63	0.12	140	0.87	11.7	0.77	0.071	1.05	0.66	1.03
Mid-Atlantic	39.5	0.18	62	0.13	143	0.97	10.1	0.84	0.092	1.20	0.64	1.01
Central	41.9	0.19	68	0.14	133	0.99	9.2	0.85	0.097	1.09	0.62	1.00
North Central	29.8	0.22	55	0.16	167	1.17	9.5	0.83	0.087	1.20	0.55	1.01
Southeast	49.0	0.20	65	0.15	136	1.03	8.7	0.92	0.122	1.09	0.75	1.10
East Gulf	53.7	0.23	68	0.17	130	1.25	6.4	1.05	0.178	1.03	0.80	1.19
East Texas	31.2	0.29	41	0.22	213	1.28	8.0	0.97	0.137	1.08	0.76	1.18
West Texas	17.3	0.33	30	0.27	302	1.53	7.4	0.98	0.121	1.13	0.57	1.07
Southwest	7.4	0.37	20	0.30	473	1.46	7.8	0.88	0.079	1.16	0.37	0.88
West inland	4.9	0.43	14	0.38	786	1.54	9.4	0.75	0.055	1.06	0.36	0.87
Pacific Southwest	10.2	0.42	19	0.36	476	2.09	11.6	0.78	0.054	0.76	0.54	0.98
Northwest inland	11.5	0.29	31	0.23	304	1.43	10.4	0.82	0.057	1.20	0.37	0.93
Pacific Central	18.4	0.33	32	0.25	265	2.00	13.7	0.80	0.048	0.85	0.58	1.05
Pacific Northwest	35.7	0.19	71	0.15	123	1.50	15.9	0.80	0.035	0.73	0.50	1.09

## **Chapter 3 Computer Program Development**

### **3.1 Program Overview**

A computer program has been developed for the USLE, the MUSLE, and the USGS pollutant loading equations described in Chapter 2. The program was developed in Visual Basic 4.0 and runs on PCs using Windows 95 and Windows NT. Program algorithm development and program conceptualization time was around 500 hours. The approximate time to develop the source code was over 400 hours. Debugging and program verification involved close to 300 hours.

#### **3.1.1 Program Features**

The program is divided into five modules. Four of these modules are based on soil erosion equations (USLE, MUSLE) and the sediment delivery ratio (SDR, Roehl's equation), while the fifth is a pollutant loading equation module (NRE). Also, data for the soil loss/erosion equations and sediment delivery ratio modules can be saved and loaded in the program. Multiple areas and land types can be handled by the program and total soil loss and averages of the total subareas can be calculated. In addition, the program modules handle both U.S. and S.I. units.

Since this program will eventually become a part of VT-PSUHM, integrating components of VT-PSUHM was of major importance. Integration in VT-PSUHM was achieved by allowing hyetographs created in VT-PSUHM to be used for calculating the rainfall erosivity factor,  $R$ . The user can create a hyetograph based on the rainfall in a certain location and calculate the corresponding rainfall erosivity for that particular storm event. In addition, hydrographs created by VT-PSUHM can be loaded into the program for calculating the expression  $(Q \times q_p)$  in the MUSLE in order to calculate sediment yield from a particular storm

#### **3.1.2 Program Constraints and Limitations**

A smaller rainfall-runoff erosivity factor map was used because of screen size limitations. This smaller figure shows most of the U.S. east coast. The maximum size for hyetograph and hydrograph data files are limited to 100 data points and 200 data points respectively. The program is limited to 1000 subareas.

### **3.2 Program Modules**

The program utilizes various sub-modules for each of the parameters in the soil loss equations. Each parameter in the soil loss equation was broken into individual sub-modules to allow for code to be reused and easily modified. Each sub-module allows for many various types of data based on the variable used. These include both qualitative and quantitative variables depending on the particular soil loss factor. Equations 1 through 8 were used within the sub-modules. Each sub-module usually requires more data in order to calculate the final value of the parameter. So internally, the program keeps track of



these variables even if the data are saved. Upon reloading of the data, the previously saved parameters for each sub-module are retained. Since the MUSLE and sediment delivery ratio are extensions of the USLE, most of the parameter code is reused in order to keep the program size small. The startup screen is shown in Figure 5.

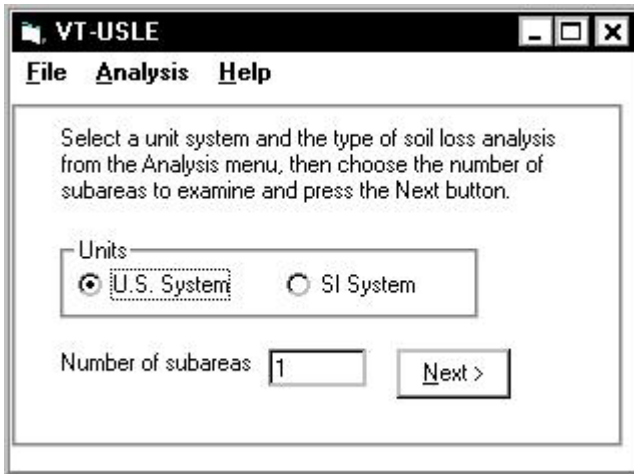

**Figure 5 - Screenshot of Startup Menu**

### 3.2.1 Universal Soil Loss Equation Module

The USLE implemented into the program is based on equation 1. Data required include the rainfall-runoff erosivity factor, the soil-erodibility factor, the slope-length factor, the crop management factor and the conservation practice factor. The flowchart for the USLE is shown in Figure 6. Also required are the impervious percentage of area and the watershed area for total soil loss. An example is given in Figures 7 and 8.

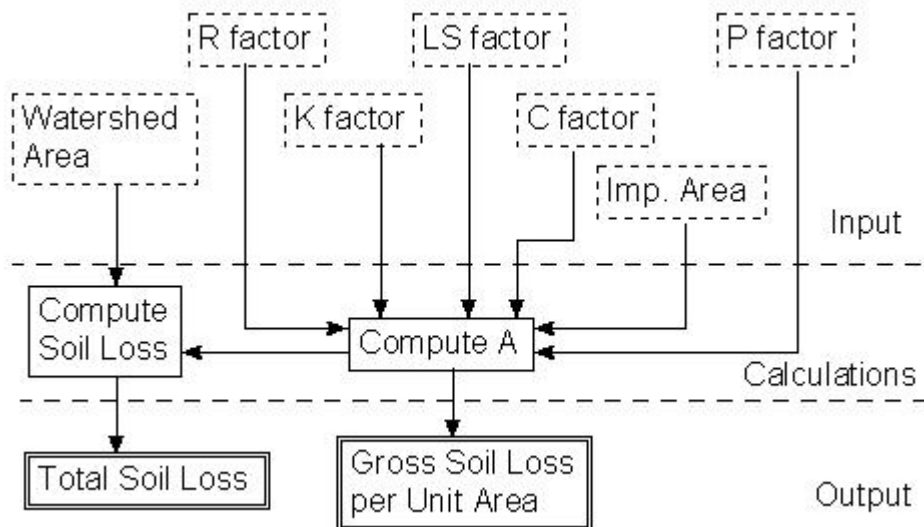

**Figure 6 - Program Flowchart for USLE Module**

**Data Entry**

To change a cell: double-click on the cell, press Edit Current Cell button, or press Return on the cell to be changed.  
 Press Save to save the data to a file  
 Press Back to return to the main page or Next to view the output

	Land Use	R <sub>i</sub> , tons/acre	K factor	LS factor	C factor	P factor	% imperv
Subarea 1	Agriculture	150	0.392	2.387	0.4	0.5	0
Subarea 2	Construction	150	0.392	0.3245	1.0	1	0
Subarea 3	Agriculture	150	0.392	0.5618	0.25	0.25	0

**Figure 7 - Screenshot of USLE Module Input Form**

**Final Output**

Select Back to return to the data entry sheet.

	Soil Loss tons	A, tons/acre	R, tons/acre	K factor	LS factor	C factor	P factor
Subarea 1	336.85	28.07	150	0.392	2.387	0.4	0.5
Subarea 2	57.24	19.08	150	0.392	0.3245	1.0	1
Subarea 3	8.26	2.06	150	0.392	0.5618	0.25	0.25
Totals	402.35	49.21	450.0	1.18	3.27	1.65	1.75
Averages	134.12	16.4	150.0	0.39	1.09	0.55	0.58

< Back      Quit

**Figure 8 - Screenshot of USLE Module Output Form**

## R Sub-module

There are three ways of inputting data for the rainfall-runoff erosivity factor. The first approach is by selecting the location and state in a drop-down box. This method can be customized for different locations by modifying a data file. The next method is to compute R from a hyetograph data file generated by VT-PSUHM. The rainfall erosivity factor is calculated from equation 2. The last method is from an iso-erodent map in which R values can be picked from a chart via a mouse. Programming for the iso-erodent chart involved a modified finite-difference method to provide adequate linear interpolation between the data points. Figure 9 shows the R factor module.

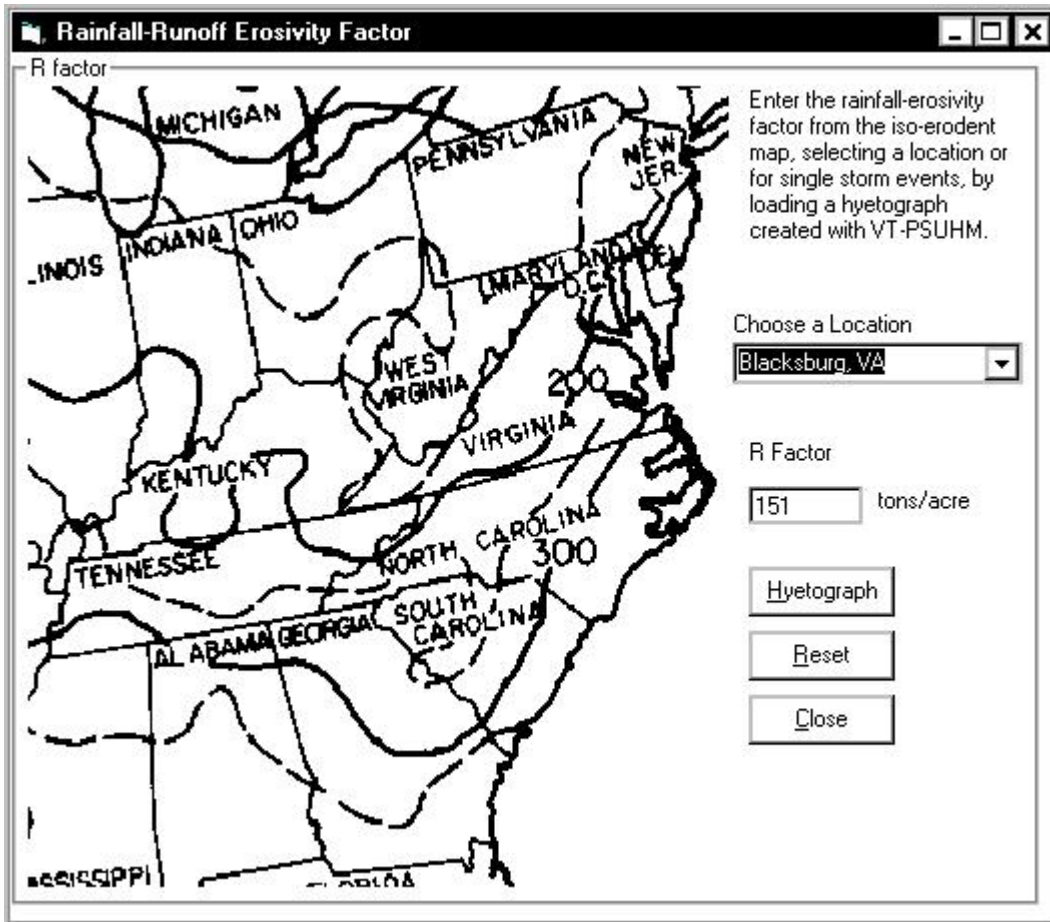

Figure 9 - Screenshot of R Sub-module

## K Sub-module

For the soil erodibility factor, Wischmeier developed a nomograph which required five soil parameters to determine K. The author of this report has transferred the nomograph data points into a spreadsheet and a regression equation has been created for each curve. These regression equations were then utilized in the program. Refer to Appendix A for the regression equations.

Also, a simpler method of calculating the soil erodibility factor which requires the soil type and the percent organic matter content was implemented in the program. Figures 10 and 11 show both the five parameter and two parameter K forms.

**Soil Erodibility Factor**

K factor, 5 parameters

Enter data for the soil properties below. The first K approximation can be used if there is no soil structure or soil permeability data. Or select the Descriptive K button for the 2 parameter K values.

Percent silt + very fine sand: 35      Soil structure: Fine Granular

Percent sand (0.1-2.0 mm): 24      Permeability: Moderate

Percent organic matter: 2.5

M factor: 2029.54

First approximation of K: 0.1179

M2 factor: 387.82

Soil-erodibility factor, K: 0.108782

Descriptive K    Reset    Close

Figure 10 - Screenshot of K Sub-module, Five Parameters

**Soil Erodibility Factor**

K factor, 2 parameters

Select a soil type and enter the organic matter percentage of the soil.

Soil type: Silt loam

Organic matter content, %: 2.5

K factor: 0.3988

Reset    Close

Figure 11 - Screenshot of K Sub-module, Two Parameters

## Length Slope Sub-module

The length slope factor is based on equation 3. Data required include the field slope length and field slope of the subarea. The slope factor M is calculated from the given field slope with Table 2. See Figure 12 for a screenshot of the LS factor.

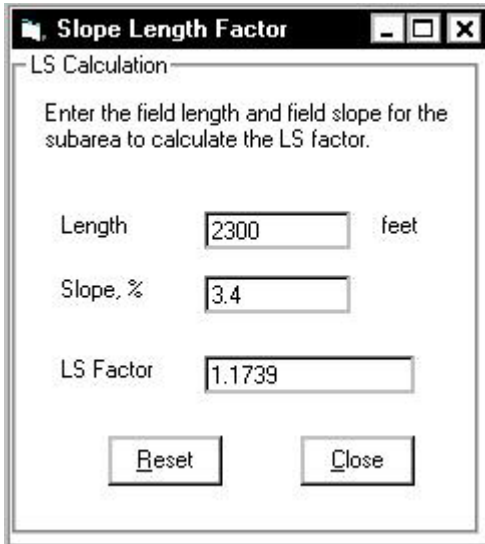

The screenshot shows a window titled "Slope Length Factor" with a standard Windows-style title bar (minimize, maximize, close buttons). The window content is titled "LS Calculation" and contains the following text: "Enter the field length and field slope for the subarea to calculate the LS factor." Below this text are three input fields: "Length" with the value "2300" and the unit "feet" to its right; "Slope, %" with the value "3.4"; and "LS Factor" with the value "1.1739". At the bottom of the window are two buttons: "Reset" and "Close".

**Figure 12 - Screenshot of LS Sub-module**

## Cropping and Management Sub-module

This sub-module has different menus depending on the type of land-use chosen by the user. The land-use type can either be agriculture or construction and the appropriate menu will be shown. Figures 13 and 14 show the C factor screens of the program.

**C factor, Agriculture**

Agriculture

Select a crop management factor below:

Land Cover or Land Use	C
<input checked="" type="radio"/> Continuous fallow tilled up and down slope	1.0
<input type="radio"/> Shortly after seeding prior to harvesting	0.3-0.8
For Crops during main part of growing season	
<input type="radio"/> Corn	0.1-0.3
<input type="radio"/> Wheat	0.05-0.15
<input type="radio"/> Cotton	0.4
<input type="radio"/> Soybean	0.2-0.3
<input type="radio"/> Meadow	0.01-0.02
For permanent pasture, idle land, unmanaged woodland	
Ground cover 85%-100%	
<input type="radio"/> As grass	0.003
<input type="radio"/> As weeds	0.01
Ground cover 80%	
<input type="radio"/> As grass	0.01
<input type="radio"/> As weeds	0.04
Ground cover 60%	
<input type="radio"/> As grass	0.04
<input type="radio"/> As weeds	0.09
For managed woodland	
<input type="radio"/> Tree Canopy of 75%-100%	0.001
<input type="radio"/> Tree Canopy of 40%-75%	0.002-0.004
<input type="radio"/> Tree Canopy of 20%-40%	0.003-0.01

C Factor

Figure 13 - Screenshot of C Sub-module, Agriculture

**C factor, Construction**

C-Values and Slope-Length Limits (LS) for Construction Sites

Select a crop management factor below:

Mulch Type	Application (tonnes/ha)	Slope (%)	C	LS
<input checked="" type="radio"/> No Mulch or Seeding		All	1.0	
<input type="radio"/> Straw or hay tied down by anchoring and tracking equipment used on slope	<input type="radio"/> 2.25	<5	0.2	60
	<input type="radio"/> 2.25	6-10	0.2	30
	<input type="radio"/> 3.4	<5	0.12	90
	<input type="radio"/> 3.4	6-10	0.12	45
	<input type="radio"/> 4.5	<5	0.06	100
	<input type="radio"/> 4.5	6-10	0.07	60
<input type="radio"/> Crushed Stone	<input type="radio"/> 300	<15	0.05	60
	<input type="radio"/> 300	16-20	0.05	45
	<input type="radio"/> 540	<20	0.02	90
	<input type="radio"/> 540	21-35	0.02	60
<input type="radio"/> Wood Chips	<input type="radio"/> 15	<15	0.08	23
	<input type="radio"/> 15	16-20	0.08	15
	<input type="radio"/> 27	<15	0.05	45
	<input type="radio"/> 27	16-20	0.05	23
<input type="radio"/> Asphalt Emulsion 12 m <sup>3</sup> /ha			0.03	
<input type="radio"/> Temporary seeding with grain or fast-growing grass with:			During First 6 weeks of growth	
<input type="radio"/> No mulch				0.70
<input type="radio"/> Straw	2.25			0.20
<input type="radio"/> Stone	300			0.05
<input type="radio"/> Wood Chips	15			0.08
<input type="radio"/> Sod				0.01

C Factor

Figure 14 - Screenshot of C Sub-module, Construction



## Conservation Practice Factor Sub-module

This sub-module also uses the land-type for determining what menu to show. P values for either agriculture or construction can be chosen. Refer to Figures 15 and 16 for the appropriate screens.

**P factor, Agriculture**

Agricultural Lands  
Enter a field slope percentage the crop is grown on and select the type of land treatment below:

Slope (%) Crops:

**Strip Cropping and Terracing**

Contouring       Alternate Meadows       Close Grown

P Factor:            

**Figure 15 - Screenshot of P Sub-module, Agriculture**

**P factor, Construction**

Construction Sites  
Select an urban conservation practice below:

Erosion Control Practice	P	Erosion Control Practice	P
<b>Surface Condition with No Cover</b>			
<input checked="" type="radio"/> Compact, smooth, scraped with bulldozer or scraper up and down hill	1.30	<b>Structures</b>	
<input type="radio"/> Same as above, except raked with bulldozer or scraper up and down hill	1.20	<input type="radio"/> Small sediment basins	
<input type="radio"/> Compact, smooth, scraped with bulldozer	1.20	<input type="radio"/> 0.09 ha basin/ha	0.50
<input type="radio"/> Same as above, except raked with bulldozer and root raked across the slope	0.90	<input type="radio"/> 0.13 ha basin/ha	0.30
<input type="radio"/> Loose as a disked plow layer	1.00	<b>Downstream sediment basins</b>	
<input type="radio"/> Rough irregular surface, equipment tracks in all directions	0.90	<input type="radio"/> With chemical flocculants	0.10
<input type="radio"/> Loose with rough surface >0.3-m depth	0.80	<input type="radio"/> Without chemical flocculants	0.20
<input type="radio"/> Loose with smooth surface <0.3-m depth	0.90	<b>Erosion-control structures</b>	
		<input type="radio"/> Normal rate usage	0.50
		<input type="radio"/> High rate usage	0.40
		<input type="radio"/> Strip building	0.75

P Factor:            

**Figure 16 - Screenshot of P Sub-module, Construction**

### 3.2.2 Modified Universal Soil Loss Equation Module

Most of the sub-modules used in this MUSLE module are the same as the USLE module except for the substitution of the runoff volume and the runoff peak expression ( $Q \times q_p$ ) for R. Data for ( $Q \times q_p$ ) can be entered in one of two ways. The first approach is by entering the runoff volume and runoff directly. The second method is to load a hydrograph data file created by VT-PSUHM. The runoff volume is calculated by computing the area under the hydrograph curve. Next, the runoff peak is obtained from the peak in the hydrograph curve. The data required for the MUSLE include the rainfall volume, peak runoff, soil-erodibility factor, slope-length factor, crop management factor, and conservation practice factor. The flowchart for the MUSLE module is given in Figure 17. Figures 18, 19 and 20 show some example screens of MUSLE.

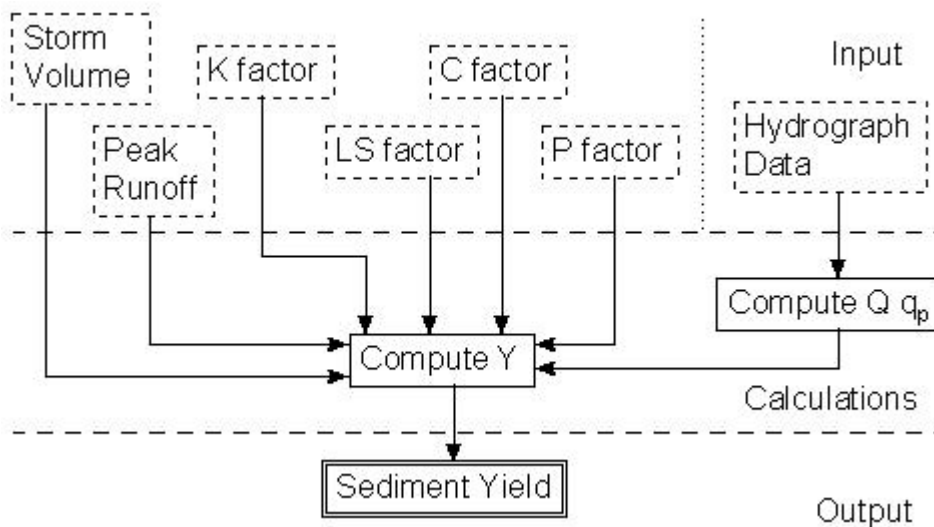

Figure 17 - Program Flowchart for MUSLE Module

**Data Entry**

To change a cell: double-click on the cell, press Edit Current Cell button, or press Return on the cell to be changed.  
 Press Save to save the data to a file  
 Press Back to return to the main page or Next to view the output

	Q, acre-feet	qp, cfs	K factor	LS factor	C factor	P factor
Subarea 1	5	124	0.392	2.5036	1.0	0.3
Subarea 2	4	109	0.392	0.4511	0.1	0.5
Subarea 3	7	107	0.392	1.467	1.0	1.0

**Figure 18 - Screenshot of MUSLE Module Input Form**

**Runoff Energy Factor**

Q and qp expression

Enter the storm runoff volume and peak storm runoff below or load a hydrograph created with VT-PSUHM.

Storm runoff volume, Q  acre-feet

Peak runoff rate, qp  cfs

**Figure 19 - Screenshot of (Q·qp) Sub-module**

**Final Output**

Select Back to return to the data entry sheet.

	Y, tons	Q, acre-feet	qp, cfs	K factor	LS factor	C factor	P factor
Subarea 1	1024.32	5	124	0.392	2.5036	1.0	0.3
Subarea 2	25.26	4	109	0.392	0.4511	0.1	0.5
Subarea 3	2224.08	7	107	0.392	1.467	1.0	1.0
Totals	3273.66	16.0	340.0	1.18	4.42	2.1	1.8
Averages	1091.22	5.33	113.33	0.39	1.47	0.7	0.6

< Back      Quit

**Figure 20 - Screenshot of MUSLE Module Output**

### 3.2.3 Roehl's Sediment Delivery Ratio Module

This module is based on equation 6. The user inputs the watershed parameters and the sediment delivery ratio is calculated. Data required include the watershed area, the watershed relief and length ratio and the bifurcation ratio of the stream. Figure 21 displays the flowchart for Roehl's equation. See Figure 22 for a screenshot of Roehl's delivery ratio.

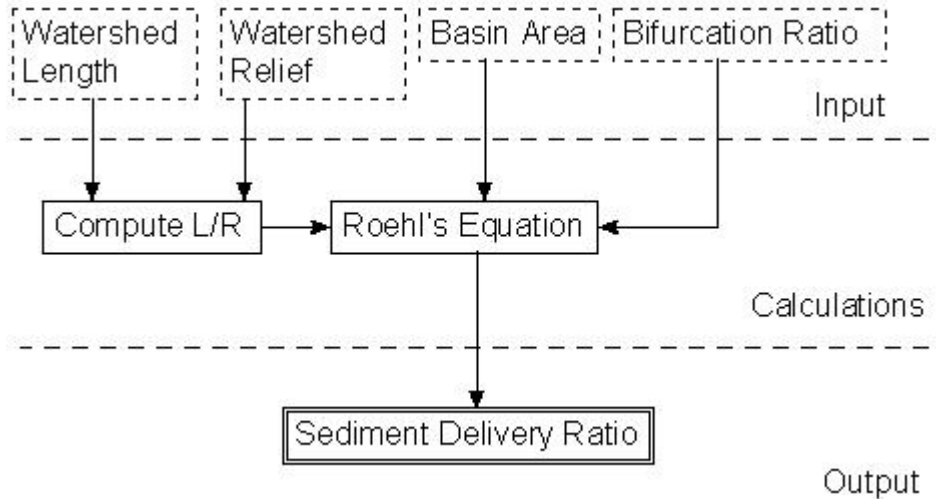

Figure 21 - Program Flowchart for Roehl's Equation

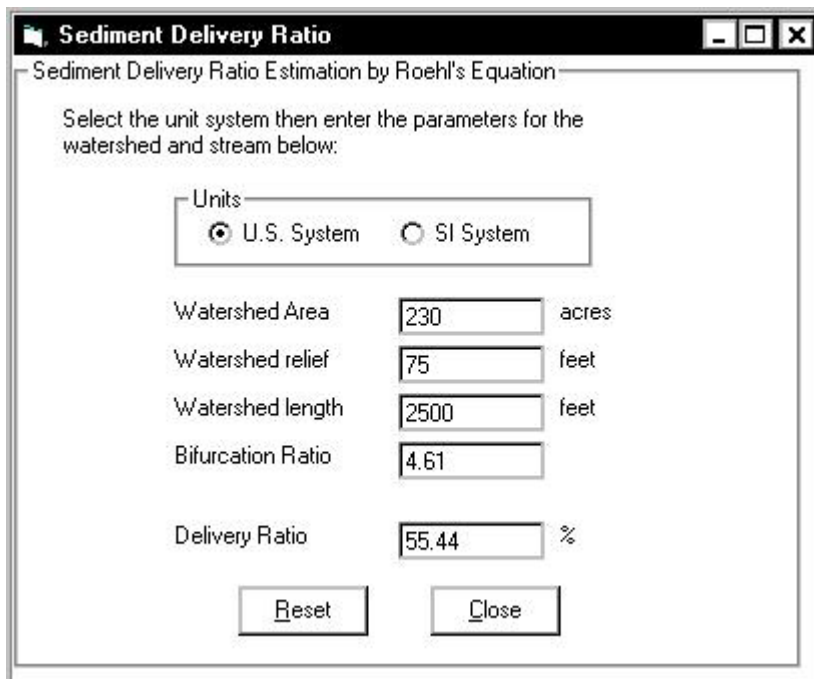
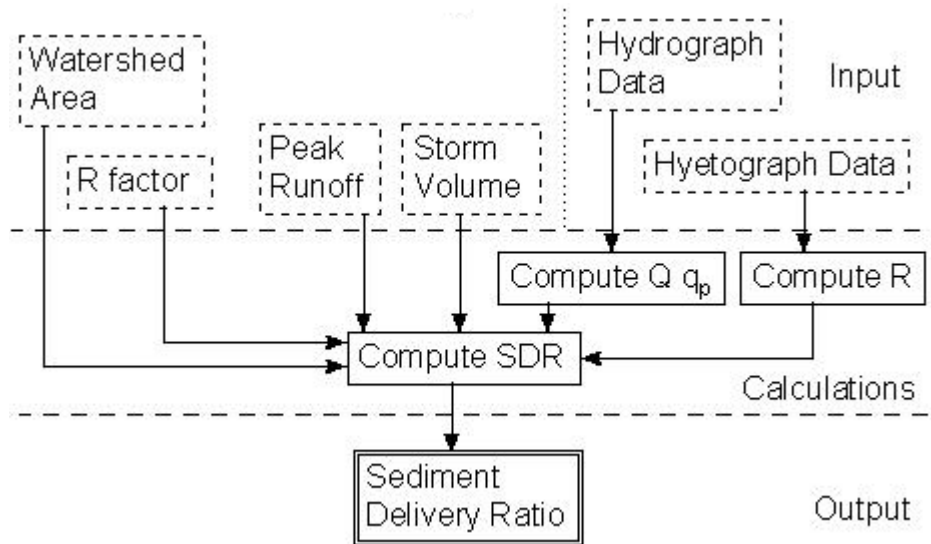

Figure 22 - Screenshot of Roehl's Sediment Delivery Ratio Module

### 3.2.4 Sediment Delivery Ratio Module

Because this equation is an extension of the USLE and MUSLE, the earlier program sub-modules were reused. Data required include the  $(Q \times q_p)$  expression, the rainfall-runoff erosivity factor, and the watershed area. Figure 23 displays the flowchart for the module. Both Figures 24 and 25 show screenshots of the data entry and final output of the sediment delivery ratio program.



**Figure 23 - Program Flowchart for Sediment Delivery Ratio Module**

**Data Entry**

To change a cell: double-click on the cell, press Edit Current Cell button, or press Return on the cell to be changed.  
 Press Save to save the data to a file  
 Press Back to return to the main page or Next to view the output

	Q, acre-feet	qp, cfs	R, tons/acre	W Area, acres
Subarea 1	5.01	124	117.54	32
Subarea 2	3.29	70	117.54	10
Subarea 3	4.30	54	117.54	24

**Figure 24 - Screenshot of Sediment Delivery Ratio Input Form**

**Final Output** [min] [max] [close]

Select Back to return to the data entry sheet.

	SDR, %	Q, acre-feet	qp, cfs	R, tons/acre	W Area, acres
Subarea 1	92.6	5.01	124	117.54	32
Subarea 2	169.99	3.29	70	117.54	10
Subarea 3	71.16	4.30	54	117.54	24
Totals	333.75	12.6	248.0	352.62	66.0
Averages	111.25	4.2	82.67	117.54	22.0

**Figure 25 - Screenshot of Sediment Delivery Ratio Output Form**



### 3.2.5 Pollutant Loading Equations Module

The data required for calculating the pollutant load varies depending on the specific pollutant. The coefficients used in the USGS Nationwide Regression Equation are given in Table 7. The number of annual storms can be retrieved from a screen in the program which is based on Figure 4 and Table 8. The flowchart is given in Figure 26. Figure 27 shows an example for total ammonia plus nitrogen load calculation.

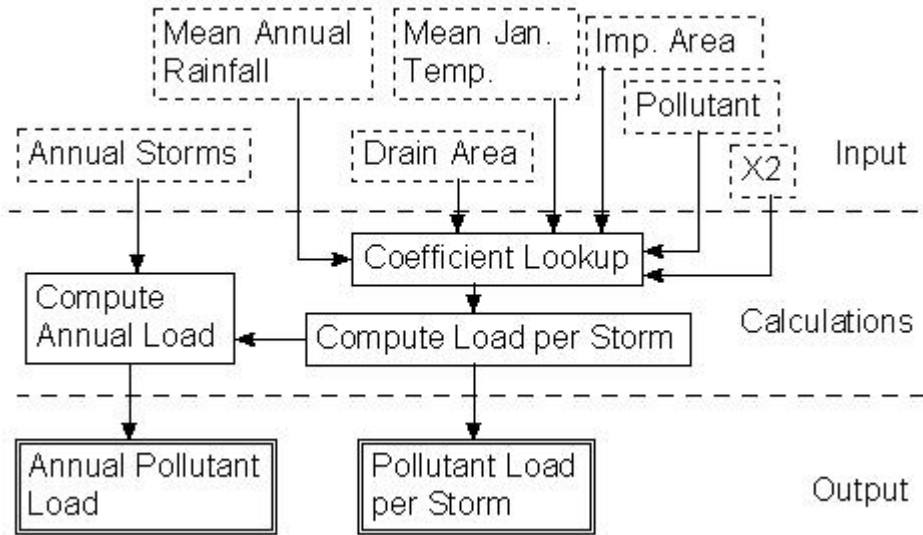

**Figure 26 - Program Flowchart for Pollutant Loading Module**

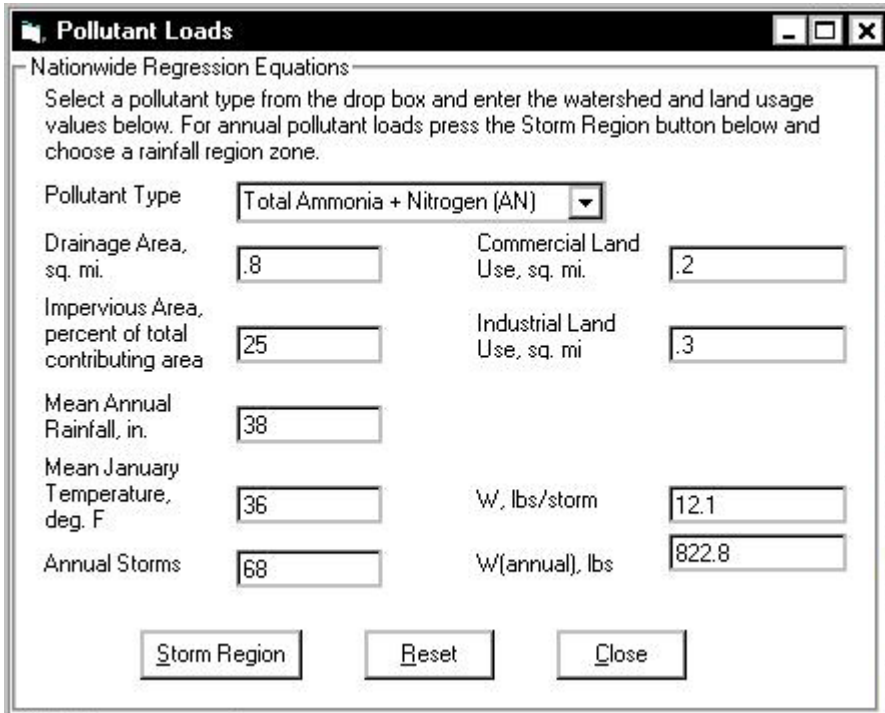

**Figure 27 - Screenshot of NRE Pollutant Loading Module**

## Chapter 4 Program Verification

### 4.1 Universal Soil Loss Equation Verification

An erosive 100-ha farm field in Blacksburg, Virginia is situated on silt loam soil with a slope classification B (3% to 6% slope). The farmer is growing corn. Estimate the average annual soil loss per hectare with contour plowing. The field has a square shape with a drainage ditch located on the side of the field. The overland slope is toward the drainage ditch (Problem is adapted from Novotony, 1993, p. 265).

#### Given Solution:

From Figure 1, for Blacksburg, Virginia,  $R = 125 \text{ tons/acre} = 280 \text{ tonnes/ha}$

Soil type is silt loam

Assume soil has 2% organic matter content

$K = 0.42 \text{ tons/acre}$

Assume rectangular field

$A = 100 \text{ ha} = 1000000 \text{ m}^2$

$L = \sqrt{1000000} = 1000 \text{ m}$

$S = 4.5\%$

From Table 2, for 4.5% field slope,  $M = 0.4$

$$LS = \left( \frac{1000}{22.1} \right)^{0.4} (0.065 + 0.454 \cdot 4.5 + 0.0065 \cdot 4.5^2) = 1.842$$

For corn growing during main part of growing season, Table 3 gives  $C = 0.3$

From Table 5, for a slope of 4.5%,  $P = 0.5$

$$\begin{aligned} A &= R K LS C P \\ &= (280)(0.42)(1.842)(0.3)(0.5) \\ &= 32.49 \text{ tonnes/ha} \end{aligned}$$

### Program Solution:

From iso-erodent map,

R = 263.98 tonnes/ha

K = 0.4202

L = 1000 m

S = 4.5%

LS = 1.8421

C = 0.3

slope = 4.5%

P = 0.5 (contouring)

% impervious = 0%

W = 1 ha

A = 30.65 tonnes/ha

### **4.2 Modified Universal Soil Loss Equation Verification**

A 0.193 mi<sup>2</sup> (50-ha) land area is to be developed into a single family residential area. The soil map indicates that the soil is loam with the following composition (Adapted from Novotony, 1993, p. 266):

Clay 20%

Silt 35%

Fine sand 20%

(Silt + very fine sand) 55%

Coarse sand and gravel 25%

The organic matter content of the soil is 1.5%. The soil is fine grained and the permeability is moderate. The lot has a square shape with a drainage ditch in the center. It has been proposed to replace the ditch with a storm sewer. The average slope of the lot toward the ditch is 2.4%.

Determine sediment yield for a storm for which the hydrograph is given in Figure 28. Sediment yield should be determined from the pervious areas for two different periods, namely, during construction when all vegetation is stripped from the soil surface (100% pervious) and subsequent to construction when 25% of the area is impermeable (streets, roofs, driveways, etc.)

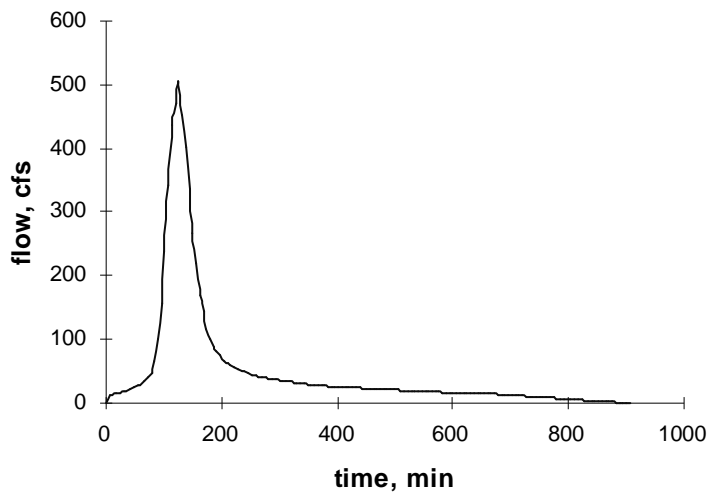

**Figure 28 - Hydrograph for MUSLE Example**

Given Solution:

$$L = \frac{2319.5 \text{ ft}}{2} = 1159.8 \text{ ft}$$

$$Q = 2710620 \text{ ft}^3 = 62.227 \text{ acre-feet (Calculated by computing area under hydrograph)}$$

$$q_p = 504.2 \text{ cfs}$$

$$K = 0.34 \text{ (From Figure 2)}$$

$$LS = \left( \frac{353.5}{22.1} \right)^{0.3} (0.065 + 0.0454 \cdot 2.4 + 0.0065 \cdot 2.4^2) = 0.4856$$

$$C = 1 \text{ (bare fallow ground)}$$

$$P = 1 \text{ (no erosion control practices)}$$

$$Y = 95 \cdot (62.227 \cdot 504.2)^{0.56} \cdot 0.34 \cdot 0.4856 \cdot 1 \cdot 1 = 5170.9 \text{ tons (for 100\% pervious)}$$

$$Y = (5170.9)(0.75) \text{ (25\% impervious)} = 3877.5 \text{ tons}$$

Program Solution:

$$Q = 62.18 \text{ acre-feet}$$

$$q_p = 504.2$$

$$K = 0.3533$$

$$LS = 0.4856$$

$$C = 1$$

$$P = 1$$

$$Y = 5082.2 \text{ tons (100\% pervious)}$$

$$Y = (5082.2 \text{ tons})(0.75) \text{ (25\% impervious)} = 3877.5 \text{ tons}$$

### 4.3 Roehl's Sediment Delivery Ratio Verification

A watershed with an area of 2.2 mi<sup>2</sup>, with a basin relief of 60.1 ft and a watershed length of 1.99 miles has a bifurcation ratio of 4.61. What is the sediment delivery ratio?

#### Given Solution:

$$W = 2.2 \text{ mi}^2$$

$$R = 60.1 \text{ ft}$$

$$L = 1.99 \text{ mi} = 10507.2 \text{ ft}$$

$$L/R = 10507.2/60.1 = 174.829$$

$$BR = 4.61$$

$$DR = 10^{4.5 - 0.23 \log(10 \cdot 2.2) - 0.51 \log 174.829 - 2.79 \log 4.61} = 15.696 \%$$

#### Program Solution:

##### Input Data:

$$W = 2.2 \text{ mi}^2 = 1407.99 \text{ acres}$$

$$R = 60.1 \text{ ft}$$

$$L = 10507.2 \text{ ft}$$

$$BR = 4.61$$

##### Output Data:

$$DR = 15.7 \%$$

### 4.4 Sediment Delivery Ratio Verification

Find the sediment delivery ratio for a 25 year storm, with a duration of 60 minutes. The watershed area is 0.193 mi<sup>2</sup> (123.5 acres) and the curve number is 70. The time of concentration is 12 minutes.

Hyetograph and hydrograph generation from VT-PSUHM:

The hyetograph was created using the Virginia Department of Transportation (VDOT) Intensity Duration and Frequency (IDF) method for Blacksburg, VA in VT-PSUHM. Zone 6 was used and Montgomery county was chosen. Next, a 25 year design storm was used with a duration of 60 minutes. This produced the hyetograph given by Figure 29. The hyetograph data was then saved to a file.

The SCS curvilinear hydrograph method was used with data from the previous hyetograph. The watershed area chosen was 0.193 mi<sup>2</sup>, the runoff curve number was 70, the time of concentration was 0.20 hours, and the hydrograph K-factor was left at the default of 484. Figure 30 shows the hydrograph generated. The hydrograph data was also saved to a file.

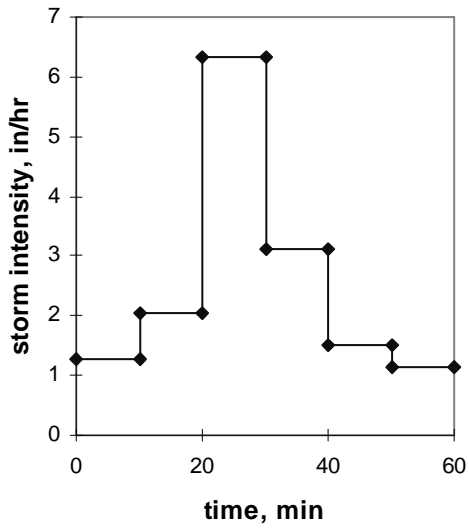

**Figure 29 - Storm Hyetograph for SDR Example**

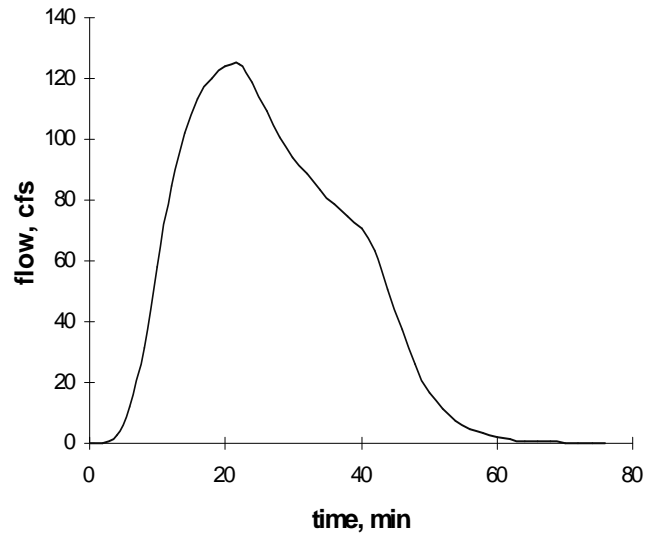

**Figure 30 - Storm Hydrograph for SDR Example**

Given Solution:

$$DR = \frac{95(Qq_p)^{0.56}}{RW}$$

$$R = 529.27 \text{ tonnes/ha} = 236.1 \text{ tons/acre}$$

$$Q = 218238 \text{ ft}^3 = 5.01 \text{ acre-feet}$$

$$q_p = 124.65 \text{ cfs}$$

$$W = 0.193 \text{ mi}^2 = 123.5 \text{ acres}$$

$$DR = \frac{95(5.01 \cdot 124.65)^{0.56}}{236.103 \cdot 123.5}$$

$$= 0.1197$$

$$= 11.979\%$$

Program Solution:

Input data:

Data from these two files were then put into the sediment delivery ratio program and the following additional data was added:

Watershed area = 123.5 acres

Output data:

Q = 5.01 acre-feet

$q_p = 124.65$  cfs

R = 236.1 tons/acre

W =  $0.193 \text{ mi}^2 = 123.5$  acres

SDR = 11.98%

**4.5 Pollutant Loading Verification (Tasker and Driver, 1988)**

Given Solution:

Find the mean annual load of total nitrogen (TN), in pounds, for a  $0.5 \text{ mi}^2$  basin which is 90 percent residential with an impervious area of 30 percent and in a region where the mean number of storms per year is 79. First compute the mean load for a storm, M, using Equation 7. Then multiply the mean storm load by the average number of storms in a year for the location.

$$M = 10^{(X)} \cdot \text{BCF}$$

where:

$$X = [ a + b (\text{DA})^{0.5} + c \text{IA} + f \text{X2} ] = [-0.2433 + 1.6383(0.5)^{0.5} + 0.0061(30) - 0.4442(0) ]$$

$$M = 16.9 \text{ lbs}$$

The mean annual load is then:

$$\begin{aligned} \text{mean annual load of TN} &= (\text{Average No. of Storms}) (M) \\ &= (79) (16.9 \text{ lbs}) \\ &= 1335 \text{ lbs} \end{aligned}$$

Program Solution:

Input Data:

Pollutant Type = Total Nitrogen

Drainage Area = 0.5 mi<sup>2</sup>

Output Data:

M = 16.86 lbs

mean annual load of TN = 1331.94 lbs



## Appendix A Regression Equations Used in the Program for the Soil-erodibility Factor

These equations are based on Figure 2. Data points from each individual curve were imported into Excel spreadsheet and were regressed to give the best possible fit.

### Percent sand and very fine silt

y = M factor, x = % silt + % very fine sand

#### 0% sand

60%-97.5% silt and very fine sand

$$y = 0.1232x^3 - 27.603x^2 + 2137.2x - 51903$$
$$R^2 = 0.9984$$

0%-60% silt and very fine sand

$$y = 0.0023x^3 + 0.8091x^2 + 3.4856x$$
$$R^2 = 0.9993$$

0%-97.5% silt and very fine sand

$$y = -0.0038x^3 + 1.1449x^2 + 4.7914x - 110.91$$
$$R^2 = 0.9951$$

#### 90% sand

0%-10.9% silt and very fine sand

$$y = -0.1164x^3 + 2.2439x^2 + 89.803x$$
$$R^2 = 0.9997$$

$$y = 99.917x$$

$$R^2 = 0.9992$$

#### 80% sand

$$y = -0.0916x^3 + 4.2735x^2 + 49.394x$$
$$R^2 = 0.9976$$

#### 70% sand

$$y = -0.0451x^3 + 3.3743x^2 + 38.234x$$
$$R^2 = 0.9984$$

#### 60% sand

$$y = -0.0039x^3 + 1.375x^2 + 51.691x$$
$$R^2 = 0.9992$$

50% sand

$$y = -0.0042x^3 + 1.3307x^2 + 43.387x$$
$$R^2 = 0.9995$$

40% sand

$$y = -0.002x^3 + 1.1556x^2 + 36.442x$$
$$R^2 = 0.9995$$

30% sand

$$y = -0.0043x^3 + 1.402x^2 + 20.328x$$
$$R^2 = 0.9995$$

20% sand

0%-80% silt and very fine sand

$$y = -0.0117x^3 + 2.083x^2 - 3.4629x$$
$$R^2 = 0.9984$$

0%-61.5% silt and very fine sand

$$y = -0.0022x^3 + 1.2424x^2 + 13.439x$$
$$R^2 = 0.9995$$

61.5%-80% silt and very fine sand

$$y = 0.0344x^4 - 9.4535x^3 + 969.35x^2 - 43830x + 741280$$
$$R^2 = 0.998$$

15% sand

0%-84% silt and very fine sand

$$y = -0.0125x^3 + 2.1862x^2 - 11.804x$$
$$R^2 = 0.9981$$

0%-64%

$$y = -0.0011x^3 + 1.1603x^2 + 9.1506x$$
$$R^2 = 0.9996$$

64%-84%

$$y = -0.009x^4 + 2.8848x^3 - 345.44x^2 + 18321x - 358591$$
$$R^2 = 0.9982$$

10% sand

0%-90%

$$y = -0.0114x^3 + 2.0698x^2 - 13.833x$$
$$R^2 = 0.9982$$

0%-62.5%

$$y = -0.0025x^3 + 1.2853x^2 + 1.9186x$$
$$R^2 = 0.9992$$

62.5%-90%

$$y = -0.0059x^4 + 1.9302x^3 - 235.5x^2 + 12714x - 252051$$
$$R^2 = 0.9989$$

5% sand

0%-96%

$$y = -0.0068x^3 + 1.5301x^2 - 5.0351x$$
$$R^2 = 0.9954$$

0%-61%

$$y = 0.0009x^3 + 0.9975x^2 + 1.9265x$$
$$R^2 = 0.9994$$

61%-96%

$$y = -0.0005x^4 + 0.2618x^3 - 43.184x^2 + 2899.6x - 65306$$
$$R^2 = 0.9991$$

### **Percent organic matter content**

y = first K approximation, x = M factor

0% organic matter

$$y = -5E-14x^3 + 2E-09x^2 + 8E-05x$$
$$R^2 = 0.9998$$

1% organic matter

$$y = -2E-13x^3 + 4E-09x^2 + 7E-05x$$
$$R^2 = 0.9998$$

2% organic matter

$$y = -2E-13x^3 + 4E-09x^2 + 6E-05x$$
$$R^2 = 0.9997$$

3% organic matter

$$y = -3E-13x^3 + 5E-09x^2 + 4E-05x$$
$$R^2 = 0.9997$$

4% organic matter

$$y = -2E-13x^3 + 4E-09x^2 + 3E-05x$$
$$R^2 = 0.9997$$

## Soil Structure

x = first K approximation, y = M2 factor

### 1 - very fine granular

0.2-0.7 approx. K range

$$y = 10000x - 1000$$

$$R^2 = 1$$

0-0.2 approx. K range

$$y = -59524x^3 + 17857x^2 + 809.52x$$

$$R^2 = 1$$

### 2 - fine granular

0.2-0.7 approx. K range

$$y = 9999.7x - 606.54$$

$$R^2 = 1$$

0-0.2 approx. K range

$$y = 238095x^3 - 35714x^2 + 4190.5x$$

$$R^2 = 1$$

### 3 - medium or coarse granular

0-0.2 approx. K range

$$y = 423280x^3 - 68783x^2 + 7603.2x$$

$$R^2 = 1$$

0.2-0.7 approx. K range

$$y = 10000x - 300$$

$$R^2 = 1$$

### 4 - blocky, platy, or massive

0-0.7 approx. K range

$$y = 10000x$$

$$R^2 = 1$$

## Permeability

x = M2 factor, y = soil-erodibility factor, K

6 - very slow

$$y = 0.0001x + 0.04$$

$$R^2 = 1$$

5 - slow

$$y = 0.0001x + 0.02$$

$$R^2 = 1$$

4 - slow to moderate

$$y = 0.0001x$$

$$R^2 = 1$$

3 - moderate

$$y = 0.0001x - 0.03$$

$$R^2 = 1$$

2 - moderate to rapid

$$y = 0.0001x - 0.06$$

$$R^2 = 1$$

1 - rapid

$$y = 0.0001x - 0.08$$

$$R^2 = 1$$

## References

- Athayde, D.N., P.E. Shelly, E.D. Driscoll, D. Gaboury, and G.B. Boyd. 1983. Results of the Nationwide Urban Runoff Program. Vol 1. Final Report. USEPA. Washington, DC.
- Debo, T.N. and A.J. Reese. 1995. Municipal Storm Water Management. CRC Press. Boca Raton, FL.
- Dillaha, T. 1996. Course Notes. BSE 4324 Non-point Source Pollution Control.
- Driscoll, E.D., G.E. Palhegyi, E.W. Strecker, and P.E. Shelly. 1989. Analysis of Storm Event Characteristics for Selected Rainfall Gages Throughout the United States. Woodward-Clyde Consultants, prepared for USEPA. Washington, DC.
- Foster, G.R. 1991. Advances in Wind and Water Erosion Prediction. *J. Soil Water Conserv.* 46:27-29.
- Novotony, V. 1993. Water Quality: Prevention, Identification, and Management of Diffuse Pollution. Van Nostrand Reinhold. New York, NY.
- Ports, M.A. 1973. Use of Universal Soil Loss Equation as a Design Standard. Water Resources Engineering Meeting, ASAE. Washington, DC.
- Ports, M.A. 1975. Urban Sediment Control Design Criteria and Procedures, paper presented at the Winter Meeting, ASAE. Chicago, IL.
- Renard, K.G., G.R. Foster, G.A. Weesies, and J.P. Porter. 1991. RUSLE: Revised Universal Soil Loss Equation. *J. Soil Water Conserv.* 46:30-33.
- Roehl, J.W. 1962. Sediment Source Areas, Delivery Ratios and Influencing Morphological Factors. Publication 59. International Association of Scientific Hydrology. Commission of Land Erosion.
- Stewart, B.A., D.A. Woolhiser, W.H. Wischmeier, J.H. Caro, and M.H. Frere. 1975. Control of Pollution from Cropland. U.S. EPA Report No. 600/2-75-026 or U.S.D.A. Rep No. ARS-H-5-1. Washington, DC.
- Tasker, D.T. and N.E. Driver. 1988. Nationwide Regression Models for Predicting Urban Runoff Water Quality at Unmonitored Sites. *Water Res. Bulletin.* Vol. 24, No. 5, October 1988.
- Vanoni, V.A. 1975. Sedimentation Engineering. ASCE. New York, NY.

Williams, J.R. and H.D. Berndt. 1977. Sediment Yield Prediction Based on Watershed Hydrology. *Trans. ASAE*. 20:1100-2204.

Wischmeier, W.H., Johnson, C.B., and B.V. Cross. 1971. A Soil Erodibility Nomograph for Farmland and Construction Sites. *J. Soil Water Conserv.* 26:189-193.

Wischmeier, W.H. 1976. Use and Misuse of the Universal Soil Loss Equation. *J. Soil Water Conserv.* 31(1):5-9.

## **Vita**

### **Kenneth Tolentino Espiritu**

Kenneth Tolentino Espiritu, son of Amado and Lilia Espiritu, was born on February 19, 1972, in Pensacola, Florida. After graduation from Salem High School, Virginia Beach, Virginia, in 1990, Kenneth went on to obtain a Bachelor's Degree in Civil Engineering from Mississippi State University in December of 1994. Kenneth then continued his education at Virginia Polytechnic Institute and State University towards a Master's Degree. He received his Master's Degree in Civil Engineering in June, 1997.