

OBSERVATIONS AND IMPLICATIONS OF SEDIMENT-
WATER INTERACTIONS IN THE NIAGARA IMPOUNDMENT
OF SOUTHWEST VIRGINIA

by

Thomas J. Grizzard, Jr.

Thesis submitted to the Graduate Faculty of the
Virginia Polytechnic Institute and State University
in partial fulfillment of the requirements for the degree of
DOCTOR OF PHILOSOPHY
in
Civil Engineering

APPROVED:

C. W. Randall
C. W. Randall, Co-Chairman

E. M. Jennelle
E. M. Jennelle, Co-Chairman

Paul H. King
P. H. King

John Cairns, Jr.
J. Cairns, Jr.

R. C. Hoehn
R. C. Hoehn

October, 1977

Blacksburg, Virginia

LD
5655
Y856
1977
G74
c.2

12/18/77
MTD/mey

ACKNOWLEDGMENTS

The author wishes to extend his sincere appreciation to Co-Chairman Ernest M. Jennelle for his continuing friendship, advice, and concern through the course of an extended graduate program. In addition, thanks are due to Dr. Paul H. King, who prodded when necessary, and simply encouraged when that was required.

Thanks are due to Dr. John Cairns, who through the years never forgot that the author's graduate committee still existed.

Two members of the graduate committee, Chairman Clifford W. Randall and Dr. Robert C. Hoehn, are due special thanks for serving in dual roles - first as instructors, and later as colleagues and friends during the author's current employment.

Mr. Glenn Willard, who is acknowledged on this page in countless theses, but whose aid can never be fully appreciated, is due special thanks again for his invaluable help and incredible scrounging talents in and around the laboratory.

The staff members of the Occoquan Watershed monitoring laboratory are also due recognition for their endurance in being exposed daily for a period of three years to a terminal Ph.D. candidate in the throes of dissertation completion. Holly Deese a former member of that staff, and a friend, deserves recognition for her preparation of this manuscript from an illegible draft.

Two special people in the author's life deserve individual thanks. Marilyn White Grizzard, his wife, has survived seven years of graduate school in an eight year marriage, while keeping both her sanity and

sense of humor. She provided encouragement and understanding when it was most needed and in the process contributed enormously to the completion of this work.

Finally, Jennifer, the author's daughter, has displayed patience and understanding far beyond her five years, as she waited for "daddy to finish his important note."

TABLE OF CONTENTS

Page

ACKNOWLEDGEMENTS		
LIST OF FIGURES		
LIST OF TABLES		
I INTRODUCTION		1
II REVIEW OF THE LITERATURE		7
Plant Nutrients and Eutrophication		7
Sediment Production		8
Plant Nutrient Occurrence in Sediments		10
Phosphorus		10
Nitrogen		15
Plant Nutrient Exchange Reactions		16
General		16
Phosphorus		16
Nitrogen		22
Microcosm Studies		25
Special Analytical Needs		30
III EXPERIMENTAL METHODS		35
Sample Collection		35
Water Samples		35
Surface Sediment		35
Sediment Cores		35
Analytical Procedures - Water		38
Phosphorus		38
Nitrogen		40
Dissolved Oxygen		40
Iron and Aluminum		40
Analytical Procedures - Sediment		41
General		41
Gravimetry		42
Phosphorus		42
Nitrogen		45
Extractable Metals		45
Microcosm Studies		45
Equipment		45
Analyses		48
Microcosm Operation		48
Batch Sorption Studies		50
IV RESULTS AND DISCUSSION		52
Evaluation of Sediment Analysis Techniques		52

TABLE OF CONTENTS - Cont.

	Page
Surficial Sediment Characterization-Longitudinal Variation	58
Volatile Solids	58
Nitrogen	60
Inorganic Phosphorus	61
Extractable Cations	65
Summary	67
Surficial Sediments-Constituent Correlations	67
Volatile Solids Relationships	67
Extractable Metals Relationships	72
Surficial Sediments-Temporal Characterization	72
Inorganic Phosphorus	74
Extractable Cations	79
Nitrogen	79
Sediment Characterization-Vertical Stratigraphy	83
Volatile Solids	83
Phosphorus	83
Nitrogen	95
Water Quality Characterization	101
Phosphorus and Iron	102
Aluminum	107
Nitrogen	107
Batch Adsorption Studies	109
Effects of Reaction Time	111
pH Effects	111
Isotherm Experiments	114
Saloid-P Adsorption	118
Aluminum-P Adsorption	120
Iron Phosphorus Adsorption	120
Non-Adsorbing Fractions	124
Adsorption Maxima Correlations	124
Batch Adsorption Model	128
Microcosm Studies	129
Phosphorus	129
Nitrogen	140
ORP	142
V SUMMARY	145
Methods Development	145
Assessment of In Situ Conditions	145
Sediments	145
Water	147
Development of Adsorption Isotherms	147
Microcosm Studies	148
Recommendations	149

TABLE OF CONTENTS - Cont.

	Page
VI CONCLUSIONS	
VII LITERATURE CITED	155
VITA	
ABSTRACT	

LIST OF FIGURES

<u>Figure</u>	<u>Title</u>	<u>Page</u>
1	Study Area in Profile	5
2	Schematic of Sediment Flux in an Impounded Body	11
3	Stability Relationships of Discrete Oxidized Phosphorus Species	19
4	Schematic of Phosphorus Transformations in an Impounded Body	23
5	Schematic of Nitrogen Transformations in an Impounded Body	26
6	Roanoke River Basin	36
7	Study Area	37
8	Schematic of Piston Corer Operation	39
9	Schematic of the Chang-Jackson Fractionation	44
10	Schematic of Microcosm Reactor	47
11	Variation in Potential Analytical Error with Mean Phosphorus Concentration	57
12	Variation of Sediment Volatile Solids and Nitrogen with Distance Above Dam	59
13	Variation of Ratio of Sediment Organic to Ammonia Nitrogen with Distance above Dam	62
14	Variation in Sediment Inorganic Phosphorus with Distance above Dam	63
15	Variation in Sediment Extractable Metals with Distance above Dam	66
16	Variation of Total Inorganic Phosphorus with Sediment Volatile Solids	68
17	Variation of Iron and Aluminum Phosphorus Fractions with Sediment Volatile Solids	70
18	Variation of Extractable Metals with Sediment Volatile Solids	71

LIST OF FIGURES, Cont.

<u>Figure</u>	<u>Title</u>	<u>Page</u>
19	Variation of Inorganic Phosphorus Fraction with Extractable Metal Content	73
20	Temporal Variation in Surficial Sediment Aluminum and Iron Phosphorus Fractions	75
21	Temporal Variation in Surficial Sediment Reductant Soluble and Calcium Phosphorus	77
22	Temporal Variation in Surficial Saloid and Occluded Phosphorus Fractions	78
23	Temporal Variation in Surficial Sediment Cation Concentration	80
24	Temporal Variation in Surficial Sediment Nitrogen Forms	81
25	Vertical Gradation of Sediment Volatile Solids	84
26	Vertical Gradation of Saloid-P	86
27	Vertical Gradation of Aluminum Phosphorus	87
28	Vertical Gradation of Sediment Extractable Aluminum ..	89
29	Vertical Gradation of Iron Phosphorus	91
30	Vertical Gradation of Sediment Extractable Iron	92
31	Vertical Gradation of Reductant Soluble Phosphorus ...	93
32	Vertical Gradation of Occluded Phosphorus	96
33	Vertical Gradation of Calcium-P	97
34	Vertical Gradation of Sediment Ammonia Nitrogen	98
35	Vertical Gradation of Sediment TKN	100
36	Observed Variation in Iron and Phosphorus in Niagara Impoundment Waters	103
37	Observed Variations in Nitrate and Dissolved Oxygen in Niagara Impoundment Water	104

LIST OF FIGURES, Cont.

<u>Figures</u>	<u>Title</u>	<u>Page</u>
38	Variation of Phosphorus Difference with Bottom Water D. O.	106
39	Relationship Between Iron Change and Phosphorus Change through Niagara Impoundment	108
40	Observed Variations in Ammonia and TKN in Niagara Impoundment Waters	110
41	Effect of Reaction Time on Phosphorus Adsorption Equilibrium	112
42	Effect of pH on Adsorption at 2 mg/g Added P	113
43	Solution Adsorption Isotherms for All Stations	115
44	Essentials of the Langmuir Isotherm for Solution Adsorption	116
45	Double Reciprocal Plots of Isotherms for All Stations	117
46	Saloid Phosphorus Isotherm, All Stations	119
47	Characteristic Isotherms for Adsorption of Al-P	121
48	Characteristic Adsorption Isotherms for Fe-P	123
49	Non-Adsorbing Phosphorus Forms at Station One	125
50	Relationship Between Extractable Cations and Fraction Adsorption Maxima	126
51	Relationship Between Volatile Solids and Al-P Adsorption Maxima	127
52	Microcosm Data, 3.0 mg/1 Added P, Station 1	131
53	Microcosm Data, 3.0 mg/1 Added P, Station 2	132
54	Microcosm Data, 3.0 mg/1 Added P, Station 3	133
55	Microcosm Data, 3.0 mg/1 Added P, Station 4	134
56	Effect of Changing Surficial Sediment Area on Phosphorus Sorption	141

LIST OF TABLES

<u>Table</u>	<u>Title</u>	<u>Page</u>
I.	Operational Definitions of Soil Inorganic Phosphorus Fractions According to the Procedures of Chang and Jackson (70)	32
II.	Sample Collection Schedule	53
III.	Replicate Analysis Summary - Inorganic Phosphorus ...	55
IV.	Replicate Analysis Summary - Nitrogen, Metals and Solids	56
V.	Surficial Sediment Inorganic Phosphorus Fractionation- 13 April, 1973	64
VI.	Extractable Iron and Iron Phosphorus Regression Parameters	94
VII.	Langmuir Isotherm Constants for Aluminum and Iron Fraction Phosphorus Adsorption	122
VIII.	Aerobic Microcosm Summary - Water Column Phosphorus	135
IX.	Anaerobic Microcosm Summary - Water Column Phosphorus	137
X.	Microcosm Summary - Sediment Phosphorus	139
XI.	Microcosm Summary - Water Column Nitrogen	143

I. INTRODUCTION

Surface water degradation has become a matter of increasing national and global concern as the impacts of culturally-induced eutrophication continue to render vital water resources marginal or unsuitable for their intended uses. The experience of the preceding decade has shown that the acceleration of the maturation process in impounded waters is truly a cultural phenomenon in that the by-products of human activity are the same materials, which when introduced into the aquatic environment, are the causal agents of the resulting water quality decline.

The materials most often identified as playing a central role in the lake enrichment process are compounds of nitrogen and phosphorus (1). These were found repeatedly in early research to be the essential plant nutrients responsible for producing algal over-production in lentic waters, when supplied at levels sufficiently above the limiting values (2)(3).

Nitrogen and phosphorus compounds, as well as many others of less environmental importance find their way into receiving waters from a number of sources, most of which are affected to some degree by human activity. Fruh (1) and Jaworski et al.(4) suggest that a nutrient source budget constructed for any receiving water should include the following general categories:

1. Atmospheric sources
2. Groundwater sources
3. Wastewater discharges
4. Surface drainage
5. Internal sources

Atmospheric sources, including dustfall and precipitation, have

been recently identified in one study as major contributors to the total watershed nutrient supply (5), and to a certain extent may affect the concentrations found in groundwater and surface drainage.

Defined discharge of wastewaters treated to varying degrees have historically constituted the nutrient sources considered to be most responsible for lake enrichment, and the management of receiving water waste input has reflected this philosophy. Current improvement efforts center around the upgrading or replacement of existing treatment facilities to effect high level organic removals, as well as removal of nitrogen and phosphorus compounds.

Groundwater and surface drainage, taken together, have been shown in several instances, depending upon watershed land use, to be the greatest single contributors to the available nutrient supply in a receiving water (6)(7). The recognition of the potential seriousness of the diffuse source pollutant problem has prompted the Environmental Protection Agency to require the inclusion of such sources in the development of basin-wide water quality management plans under Section 208 of the Water Pollution Control Act Amendments of 1972 (P.L. 92-500).

The sources described thus far, and the management plans designed to deal with them, are external to the ultimate receiving water, and, as such, it has been generally felt that institution of controls would bring about immediate benefits in terms of water quality improvement. Such a philosophy, however, does not recognize the potential internal nutrient sources of lenitic waters, or the impact of the annual cycling mechanism that affects most lakes in the temperate latitudes. Fruh (1) speculates that nutrient cycling coupled with the annual mixing-strati-

fication process may be sufficient to maintain high productivity levels for a period of years following termination of the external sources. It appears, then, that control of nutrient inputs from sources external to the aquatic environment may not alone constitute a sufficient solution to the problem of plant nutrient over-supply. The potential for internal nutrient regeneration, particularly from the sediments, has been recognized for many years (1), but a more thorough understanding now seems imperative if investment in capital-intensive control programs centered around external sources are to be protected.

It was the general purpose of this research to examine a major internal source of plant nutrients common to most impounded waters - the deposited sediments. Further, a specific investigation was made, through field surveys and controlled laboratory studies, to define the role of the deposited sediments in regulating the plant nutrient supply in the overlying water column. The Niagara Impoundment of southwestern Virginia was selected as the site of the study.

The Niagara Impoundment is located below the City of Roanoke, Virginia above the headwaters of Smith Mountain Lake. The impoundment drains an area of 511 square miles and has a full pool water surface elevation of 890 ft., m.s.l. (8). The lake is approximately 2.5 miles long with a mean depth of 10 feet. The original storage exceeded 300 AF (9).

Impounded in the 1930's, the impoundment originally served as a low head hydroelectric facility, and a portion of that capacity is still used today. In the early years of the operation of the facility, a tour boat service was run between Roanoke and the dam, but declining water

quality eventually made the recreational use of the impoundment unattractive. The character of the upstream drainage area is varied, ranging from undeveloped forest to stabilized high density urban development in the Roanoke Metropolitan Area. A 30 MGD secondary wastewater treatment plant discharges to the headwaters of the reservoir. In an effort to effect a recovery of downstream water quality, the plant, which discharges 64 percent of the phosphorus and 72 percent of the nitrogen entering the basin (10), is being upgraded to tertiary treatment standards.

The downstream reservoir, Smith Mountain Lake, is the upstream component of a run-of-the-river pumped storage hydroelectric project developed by the American Electric and Power Company. It too, in recent years, has exhibited an alarming water quality decline. Since approximately half of the surface drainage ultimately reaching Smith Mountain Lake must first pass through the Niagara Reservoir, it is likely that any significant water quality interactions at that location will have an impact on the downstream reservoir. A schematic of the upper two impoundments in the system, with pertinent physical data, is shown in Figure 1.

An excellent opportunity, therefore, exists to first, assess the water quality impact of the presence of the small, upstream impoundment on the large, downstream reservoir, and second, to attempt to assess, a priori, the likely impact of internal nutrient sources in determining impoundment water quality following plant upgrading. A short-term early study of nutrient sources in the basin (10) reported a deficit in nitrogen and phosphorus flux through the reservoir - indicating a level of sediment activity that might have significant impact upon both local and

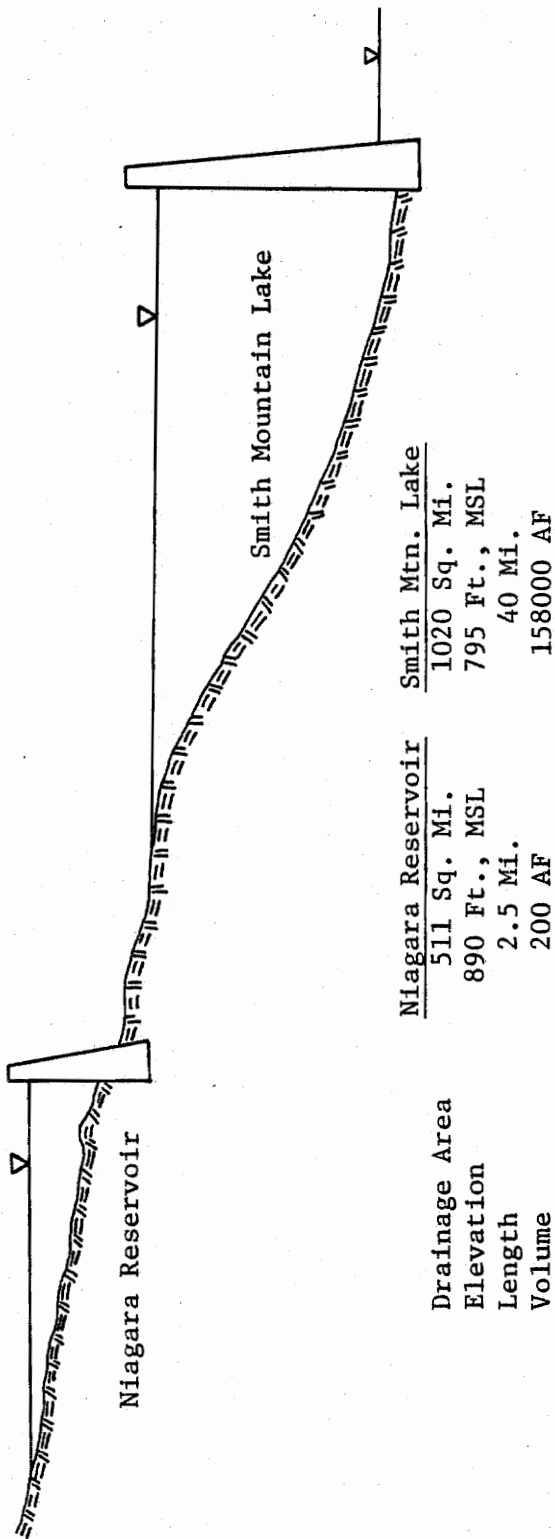

Figure 1. Study Area in Profile

downstream water quality.

II. REVIEW OF THE LITERATURE

Plant Nutrients and Eutrophication

As in terrestrial ecosystems, the stimulation of crop production in aquatic environment is closely linked to the supply of fertilizer materials. In the former case, the application of such materials is performed for a desired purpose - greater crop yield. In the latter case, the nutrient supply is most commonly a side effect of human activity, and the result is the undesirable overenrichment of the receiving water. This may have the effect of causing algal overproduction, and, in time, resulting in the following impacts according to Martin and Weinberger (11):

1. Exertion of a demand on the lake oxygen resources following nighttime shifts to respiration and/or organism death and decay.
2. Return of inorganic nutrients to the water column following decay of the algal biomass.
3. Cause an upset in the food chain, thereby affecting the life cycles of higher species.

Fruh (1) has described nutrients as being any of a number of materials required for organism growth, tissue repair, or energy derivation. Those materials universally required by all organisms for such purposes are carbon, hydrogen, oxygen, sulfur, potassium, calcium, magnesium, nitrogen, and phosphorus. Of these, nitrogen and phosphorus are generally considered to be most often responsible for the stimulation of nuisance algal growth, with the exception that carbon may play an important role in low alkalinity waters.

Of the two major macronutrients, phosphorus is generally considered

to most often be the constituent that limits maximum standing crop in accordance with Von Liebig's Law of the Minimum (12). Weiss (13), however, has proposed that nitrogen plays a more dominant role in the limitation of algal production. In any case, the literature cites a narrow range of concentrations of nitrogen and phosphorus that encompass the limiting values. Sawyer (2), in his classic 1947 study, placed the limiting level at 0.01 mg/l and 0.30 mg/l for phosphorus and nitrogen, respectively. More recently, Sylvester (14) reported observing limiting conditions for the respective nutrients at concentrations of 0.01 mg/l and 0.20 mg/l in Green Lake near Seattle, Washington. It is apparent from the literature that plant nutrient over-supply provides one of the most consistent threats to surface water quality. The maintenance of a given water body in a state of medium productivity, or mesotrophy, demands careful attention to the potential sources of nitrogen and phosphorus. Moreover, as stated earlier, management plans developed to protect vital water resources must have, as an essential program element, a precise evaluation of the receiving water nutrient budget - one which considers all sources, both external and internal.

Sediment Production

For the purposes of this discussion, sediment will be taken to mean the deposited and the streamborne materials that ultimately are deposited in the benthos, and will specifically exclude those suspended materials that reside in the impounded water column. As with all materials present in an impounded body, the sediments may be generally characterized as having arisen from autochthonous or allochthonous sources (15)(16). Autochthonous sources are those which contribute to sediment deposits

as internal watershed processes, such as upstream erosion. Allocthanous sources are those which result in sediment production from sources external to the watershed, such as point source wastewater discharges. Of the processes producing autocthanous sediment from upstream sources, water and wind erosion have been identified as the most significant (17). This process has most often, in the past, been examined as a problem having impact on the productivity of agricultural lands - not as an integral component of the water quality determinant of impounded bodies. The character of sediments contributed by natural land erosion, is, of course, related to the upstream soil types. The rate of upstream sediment production is a function of the type of land-disturbing activity. Agricultural activities cause the acceleration of soil erosion to varying degrees, depending upon the level of conservation practice employed (18). Urban areas undergoing active construction have been shown to produce extremely high sediment export rates, and, although it has generally been supposed to be negligible, stabilized urban areas have recently been shown to generate large sediment loads (19). The organic content of erosion-produced sediments is variable, and generally depends upon both the watershed soils and the use to which the land is put (20).

Allocthanous sediment sources such as wastewater discharges are generally a minute fraction of the total mass loading of suspended sediment to a receiving water (19), but the make-up of such materials differs considerably from eroded terrestrial soils. Suspended solids in the discharges from secondary domestic wastewater treatment plants are generally composed of a large fraction of organic material which is usually nutrient-laden (21). For this reason, the contribution of

such a source to the character of the bottom sediments of a receiving water is likely to be significant. Drawing upon the literature descriptions of sediment flux in watersheds contiguous to an impounded bodies (16)(17)(18), it is possible to construct a schematic of the movement and generation of benthal sediments as shown in Figure 2.

Plant Nutrient Occurrence in Sediments

Phosphorus. Sediment phosphorus may readily be described in terms of its component fractions, postulated by Syers et al.(22), interstitial water phosphorus and particulate phosphorus. The two major compartments may be further subdivided to include organic and inorganic fractions within each. Fillos and Biswas (23) identified the members of the organic and inorganic fractions as follows:

<u>Type</u>	<u>Members</u>
Sediment organic P	Nucleotides, phospholipids, nucleic acids, polyphosphate esters
Sediment inorganic P	calcium, iron, aluminum phosphates, adsorbed or substituted phosphates

The sediment organic phosphorus fractions may be easily recognized as being formed by in situ biological activity or by influx from external sources. These forms may eventually provide an additional inorganic phosphorus reservoir upon death and decomposition of the constituent biomass (24). Sediment inorganic phosphorus forms have been characterized by Williams, et al.(25) as consisting of nonoccluded, occluded, and discrete types. The nonoccluded forms are those described by Hsu (26) as being phosphate groups exchanged for hydroxyl ions on the surface of hydrous oxides of iron and aluminum. That this occurs, also

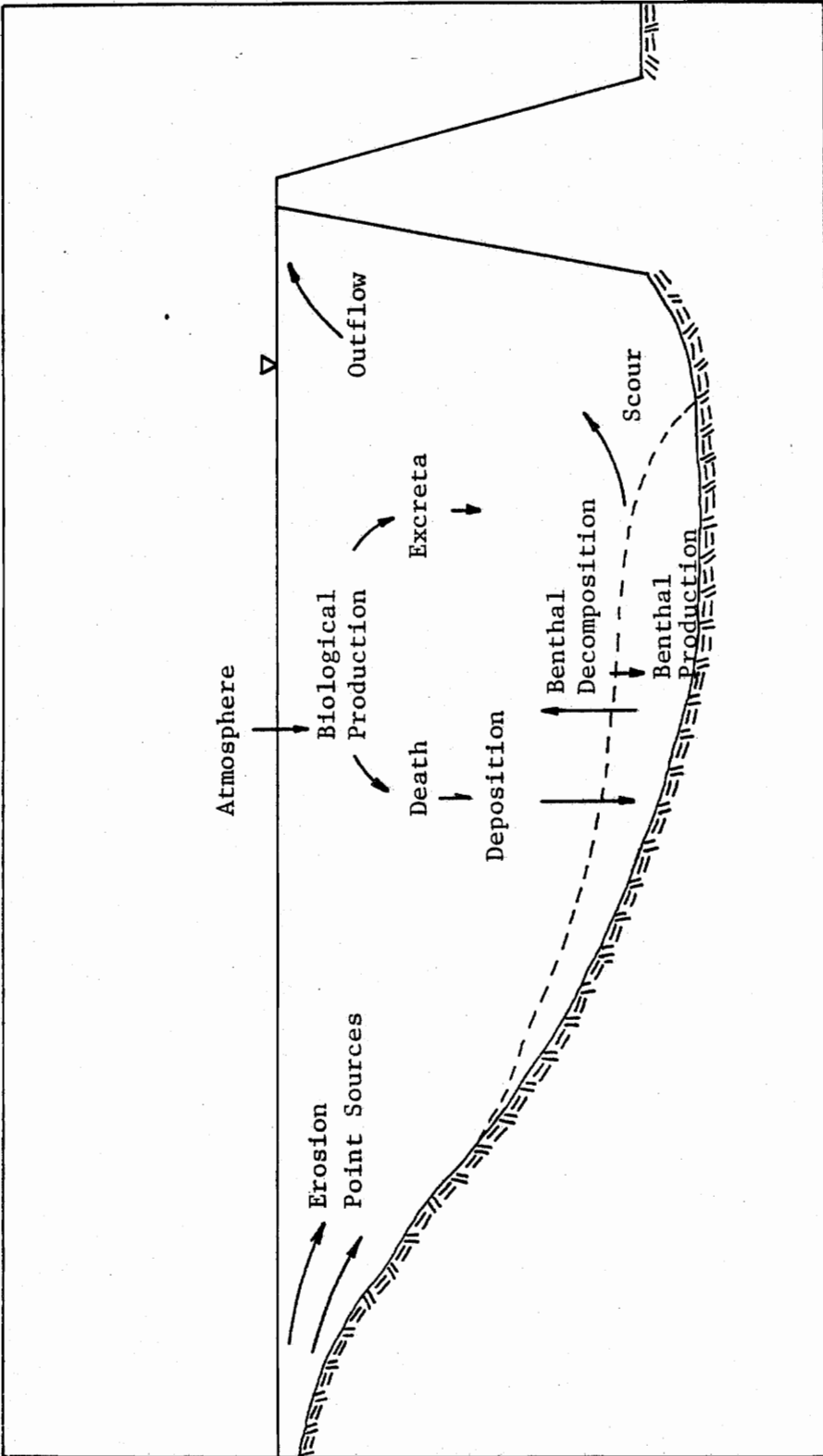

Figure 2. Schematic of Sediment Flux In An Impounded Body

implies that the maximum binding of phosphate to the sediment surface would occur in the pH range of 5 to 7 where the inorganic phosphorus equilibrium is dominated by the monovalent anion H_2PO_4^- . Williams et al. (25) propose that the occluded phosphates include those contained within the matrix of the retaining material. As the term occluded implies, these forms are only slightly available, and include isomorphically substituted species as described by Hsu (26). Discrete phosphates are those associated with defined mineral structures such as apatite, vivianite, and variscite (25).

Surficial lake sediment characterizations with respect to phosphorus content have been conducted globally, and, as might be expected, the variation is great, ranging between reported extremes of 0.58 and 7.0 mg P/g. sediment dry weight in the literature surveyed (25). In general, total phosphorus concentrations have been found to be higher in noncalcareous sediments than in those of calcareous origin (25)(26)(27). Several researchers (28)(29)(30)(25) have investigated the relationships between surficial sediment phosphorus and other sediment parameters. Frink (28), in a study of Bantam Lake in Connecticut, observed a positive relationship between overlying water depth and total sediment phosphorus. He observed that, while most of the sediment phosphorus was bound to calcium and iron, aluminum-bound phosphorus showed an increase with depth and noted that Al-P is generally considered to be more easily exchanged. Delfino et al. (29) found similar correlations between water depth and surficial sediment composition in Lake Mendota, reporting good relationships with not only phosphorus, but iron and manganese as well. In addition, it was found that the Lake Mendota iron and phos-

phorus data correlated more satisfactorily with each other than with any other parameter measured. Williams et al. (25) reported excellent correlations of both total and inorganic phosphorus with citrate-dithionite-bicarbonate extractable iron in a number of noncalcareous Wisconsin lake sediment. Sridharan and Lee (31) in a study of the sediments of Green Bay, Wisconsin, also concluded that sediment phosphorus was most highly correlated with iron, but also noticed a significant correlation with aluminum. Serruya (30), in a study of Lake Kinneret, Israel, reported strong positive correlations between iron, manganese, and phosphorus and water depth. Surprisingly, however, he also observed a negative relationship between phosphorus and organic carbon. This appears to contradict the general findings in the literature that high sediment phosphorus is accompanied by greater water depth. It is reasonable to assume that the type of sediment deposited in the greatest depth of a given water body is a direct function of lake morphology. That is to say, the deeper portions of most lakes lie at a large distance from the entry points of the major tributaries, and the sediment accumulation patterns dictate that the coarser materials will settle into the shallower upstream areas, while the more flocculent organic materials will be deposited in the deeper waters. This sedimentation pattern fits very well with the postulated association of Delfino et al. (29), that iron and phosphorus are both associated with fines in the sediments. The apparent high correlation between sediment manganese and phosphorus reported by two authors (29)(30), is likely to be a coincidence of the similar chemistries of iron and manganese, because Williams et al. (25) showed consistently better evidence of a

relationship with iron.

The occurrence of phosphorus in cores of deposited lake sediments appears to be consistent with the relationships observed in surficial sediments according to several researchers (31)(32)(33). Bortleson and Lee (31), in investigating cores from Lake Mendota were able to identify the point of onset of cultural impact on lake production by comparing the zone of increased phosphorus concentration with zones of Ambrosia pollen stratigraphy. It was noted that prior to the onset of watershed development, the sediment phosphorus concentrations remained low, but following that period significant increases were observed. Shapiro et al. (33) similarly concluded that the vertical profile of the sediments of Lake Washington represented an accurate picture of the phosphorus history. They concluded that, while at the surficial stage, rapid decomposition occurred, releasing phosphorus to become bound to less labile inorganic compounds and thus become part of the permanent sediment record. The work of Sridharan and Lee (32) and Serruya (30) indicated in their respective studies that deep sediment phosphorus shows a close correlation with iron and aluminum, even though the materials to which the phosphorus was originally attached exist in a reduced state. An unusual pattern of vertical distribution of sediment phosphorus was observed by Livingstone and Boykin (34) in interpreting data from Linsley Pond, Connecticut. Instead of relatively low levels of core phosphorus at alower depths, they reported high concentrations which ultimately declined to low levels at the sediment surface. This gradient, they postulated, was due to the influx of large quantities of mineral material which blocked the migration of phosphorus out of the

sediment. The theory is supported by the observation of a layer of low organic content material concomitant with the high phosphorus concentrations.

Nitrogen. Keeney et al. (35), in an investigation of deposited sediments in thirteen hard and soft water Wisconsin lakes, found that the types of nitrogen compounds present were substantially the same as in terrestrial soils. The distribution of nitrogen forms within the organic fraction, however, indicated a much higher rate of biologic activity in the submerged condition. In all the surficial sediments they examined, greater than 98 percent of the total nitrogen present was organic, with the remainder being accounted for by the presence of exchangeable ammonia. The actual forms of organic nitrogen present in deposited lake sediments are not necessary to this discussion, and it will suffice to note that it is important only that they exist in the most reduced state as in amino acid and protein composition, as reported by Kemp and Mudrochova (36). Chen et al. (37) found that nitrate immobilization and denitrification occurred so rapidly in anoxic Lake Mendota sediments that it could not be recovered successfully in analysis, even following the addition of known quantities. Frink (27) and Serruya (30) observed a positive correlation between depth of overlying water and surficial sediment nitrogen. This is similar to the relationship observed for phosphorus in most lakes, and may be explained by the residence of most sediment nitrogen in the organic fraction, which generally migrates to the deeper portions of the lake.

The vertical stratigraphy of sediment nitrogen was observed by

Bortleson and Lee (31) to adhere to the established nitrogen-organic matter correlation to a depth of 100 cm in Lake Mendota cores. Shapiro et al. (33) found a total nitrogen decline with increasing sediment depth in Lake Washington, reflecting in the surficial deposits, they felt, the current high level of productivity of the lake. Kemp and Mudrochova (36) found that ammonium (both fixed and exchangeable) rose with sediment depth in Lake Ontario cores. Organic nitrogen, the major fraction, showed the more common decline with depth. The fixed ammonium fraction, which is generally incorporated into the lattice of expansible clay minerals (35), was found to be substantially related to soil profile at an upstream shore bluff. Konrad et al. (38) found that the exchangeable ammonium level in cores of two Wisconsin lakes also increased with depth, and concluded that this phenomena would effectively preclude the use of dredging as a lake reclamation procedure in nitrogen sensitive bodies.

Plant Nutrient Exchange Reactions

General. Beginning with the classic work of Mortimer (39) in 1941, the deposited sediments of lenitic waters have come to be recognized as vital components of the equilibrium that determines the concentration of many dissolved substances. In more recent years, the primary research in sediment-water chemistry has been performed in the agronomic sciences, because of the many similarities between terrestrial and submerged soils. It is proposed that additional work in the subject area by those doing research in environmental engineering will assist in quantifying the mechanisms involved.

Phosphorus. Mortimer (39), noting the concentration increases of

a number of dissolved substances during hypolimnetic deoxygenation, observed that all were not primary products of reduction. Conducting weekly observations of water quality in Esthwaite Water, he found that during the summer stratification the phosphorus concentration increased two orders of magnitude and was accompanied by a concurrent rise in ferrous iron [iron (II)]. The correlation with oxidation-reduction potential (ORP) was also apparent in that Fe (II) was reduced whenever the ORP fell below $E_7=230$ mv (pH 7 against the hydrogen half-cell). He concluded that the onset of anoxic conditions was responsible for the destruction of insoluble ferric [iron (III)] complexes, and the liberation of attached phosphorus forms. In order to understand the processes involved in the release of sediment phosphorus such as observed by Mortimer (39), it is first necessary to understand the process of fixation.

The fixation processes of phosphorus in terrestrial soils and aerobic lake sediments have been alternately described as anion exchange phenomena, precipitation or adsorption. It is worthwhile to examine each of these proposed mechanisms in detail.

Wiklander (40) states that, at low pH, the soil phosphorus fraction usually termed saloid (or labile) is actually anionically exchanged on hydrous oxides of aluminum and iron. This would explain the relative ease with which some surface phosphorus is released in the presence of some other counterion in high concentration. Harter (41) and Hsu (26) also favored the anion exchange explanation for phosphorus fixation, but for different reasons. The former suggested that exchange with surface hydroxyl ions in organic matter was the mechanism involved,

while the latter favored hydroxyl ion exchange on amorphous oxides of iron and aluminum. Hsu (26) also used the term adsorption to describe the exchange that occurs as described above. Kuo and Lotse (42) proposed that phosphorus in the H_2PO_4^- form exchanged with coordinated water groups on the surface of clay lattice.

Precipitation of variscite (AlPO_4) and strengite (FePO_4) as discrete phase phosphates in aerobic lake sediments has been proposed by McKee et al. (42) and Wiklander (40) as a possible mechanism of phosphorus fixation. However, Syers et al. (22) reported that even when the precipitation of variscite begins at pH 6 and a phosphorus concentration of 0.1 mg/l, a solubility product calculation with strengite shows that the system will support a dissolved phosphorus concentration of 1.0 mg/l. Since aerobic lake sediments appear to be capable of keeping the phosphorus concentration considerably below 1.0 mg/l, it would appear that the precipitation of discrete phase iron and aluminum phosphates would be an unlikely primary mechanism. Kramer et al. (43) dispute this conclusion, noting that the solid phases of oxidized aluminum, iron and fluor-apatite are in equilibrium with solution at a pH of 5.5 while supporting a soluble phosphorus concentration of only 50 ppb, as shown in Figure 3. The data used for constructing the stability diagram assumed typical freshwater lake chemical constituency and oxidizing conditions. In any case, however, removal of soluble phosphorus in conjunction with a precipitation reaction does seem to be consistent with the previously discussed exchange on precipitating oxides of aluminum and iron.

The final binding mechanism to be discussed is adsorption, but it

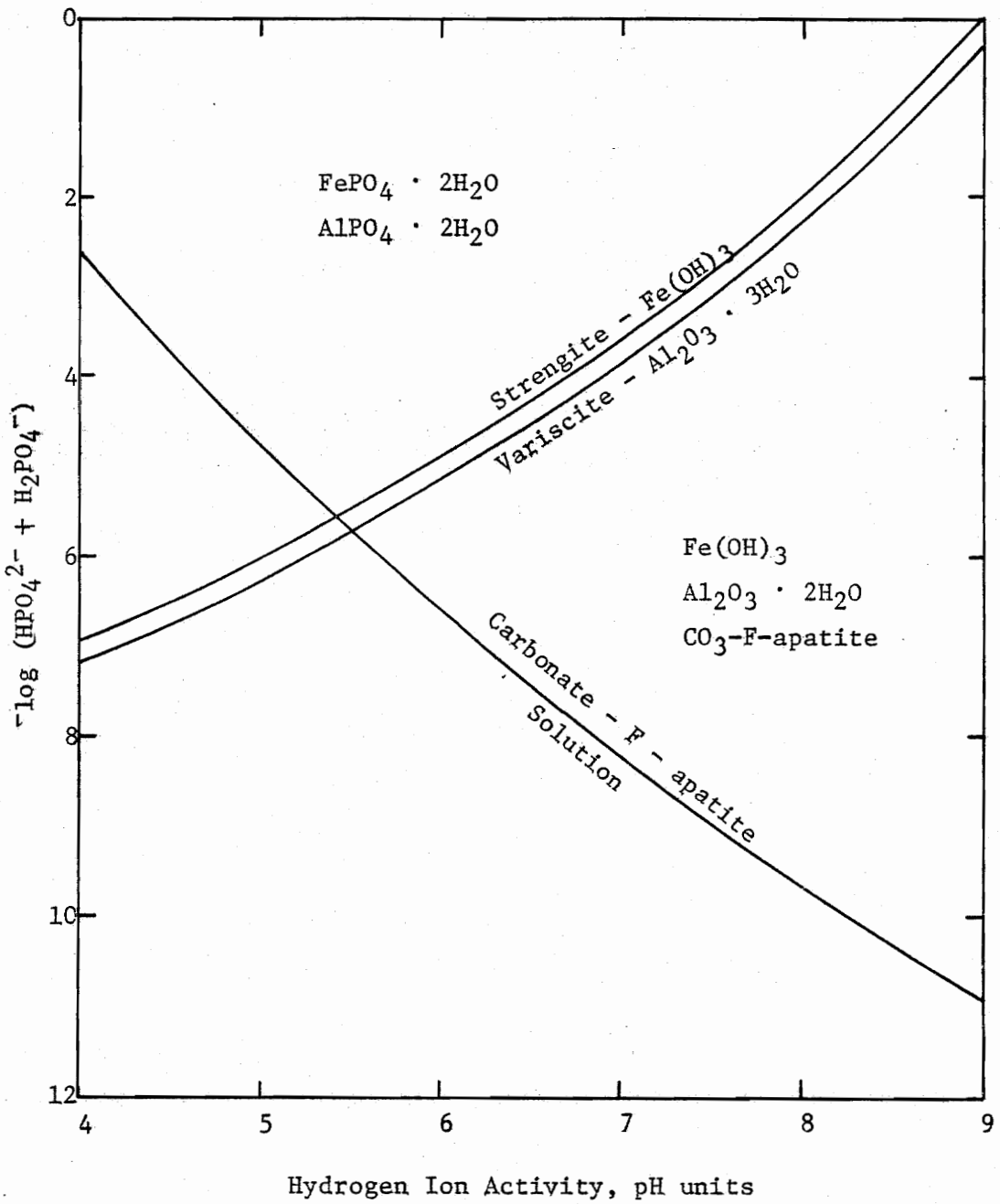

Figure 3. Stability Relationships of Discrete Oxidized Phosphorus Species [after Kramer, et al. (43)]

must be noted that this term is used interchangeably throughout the literature to describe any process by which inorganic phosphorus is immobilized in lake sediments. In light of the disagreements still found in the literature with regard to actual fixation mechanisms, it is proposed that adsorption and/or sorption is, at the present, an adequate descriptor of them all. Hsu (26), however, does make a fine distinction worth noting between precipitation and adsorption. He states that the two mechanisms are similar, but that adsorption is a special case of precipitation, in which phosphorus reacts with the residual charge on the surface of a pre-existing aluminum or iron amorphous hydroxide.

Laboratory studies of phosphorus adsorption by recovered lake sediments and terrestrial soils have shown that in most cases, under aerobic conditions, a considerable quantity may be removed from solution (44)(45)(46). In the case of the work of Weir and Soper (49) and Shukla et al. (47) it appeared that essentially all the phosphorus removal observed was due to binding to the available iron fraction sites. Neither study found the aluminum fraction to be significant. A study by Tandon and Kurtz, however, showed the aluminum fraction to be considerably more active in some terrestrial soils (49). The kinetics of bulk phosphorus adsorption have been shown to follow the Langmuir isotherm by several researchers (44)(45)(48). Einsele (50) felt that the Freundlich isotherm did not function well in describing the adsorption process. This seems evident, because the Freundlich isotherm, which performs well for carbon adsorption of organics, assumes that multi-layer coverage of adsorption sites is permissible, while

the Langmuir model allows only monolayer coverage. Since phosphorus adsorption appears to be a function of the anion being bound to a finite number of active sites, the monolayer model would be expected to perform better.

To a great extent, the release of bound phosphorus appears to be a function of the existence of the compounds to which it binds. The mechanism posed by Mortimer (39) is one in which the onset of reducing conditions, and subsequent destruction of the oxidized iron compounds in the sediment micro-zone, cause the release of bound phosphorus to solution. This hypothesis would perform well regardless of the suggested binding mechanism with iron. If the phosphate were found to be precipitated as strengite, direct solubilization would occur, whereas if immobilization was due to attachment to a hydrous oxide of iron, destruction of the parent compound would result in indirect release. Li et al. (51) found exchange of phosphorus from several Wisconsin lake sediments to be highly sensitive to the existence of such an anaerobic environment.

Williams et al. (46) found that a shift in the established sediment-water concentration gradient was sufficient to promote phosphorus release from the sediments of a number of productive Wisconsin lakes. Sediment samples were allowed to adsorb phosphorus from solution, and subsequently were exposed to a zero phosphorus environment. Regardless of sediment type, all samples showed a desorption response to the change in concentration gradient.

The concept of equilibrium shifts between sediment and water due to pH changes must also be considered in phosphorus release. As

observed by Syers et al. (22) the minimum solubilities of oxidized aluminum and iron compounds occur in the slightly acidic pH range. The increase in solubility with rising pH noted by Tisdale and Nelson (52) and Jackman and Black (53) raises the possibility of phosphorus release in shallow lake waters due to the rise in ambient pH experienced during intense algal activity. This is likely to be a mechanism for the solubilization of aluminum phosphates in particular, because they are relatively unaffected by a reducing environment.

The movement of phosphorus to and from the deposited sediments in lakes appears to be capable of having large impacts on impounded water quality in view of the potential regulation of primary productivity. Examination of the schematic of the phosphorus cycle in Figure 4 shows the potential for an internal process such as sediment diagenesis to have a cyclic effect on the quality of overlying waters even in the absence of other sources, as suggested by Fruh (1).

Nitrogen. Whereas the movement of phosphorus between the sediment and water phases has been shown, to a great extent, to depend upon chemical interaction, albeit governed by biochemical considerations, the movement of nitrogen is more directly dependent upon biological activity. Keeney (54) notes that organic nitrogen makes up the greatest part of the sediment fraction. Wiklander (40) notes that most soils have rather low capacity for anion exchange, and as a result nitrate tends to leach through rapidly. In contrast, ammonium was observed by the same author to bind rather readily, due to the universally higher capacity of most soils to exchange cations. Sediment nitrogen concentration depends upon the rates of ion exchange, assimila-

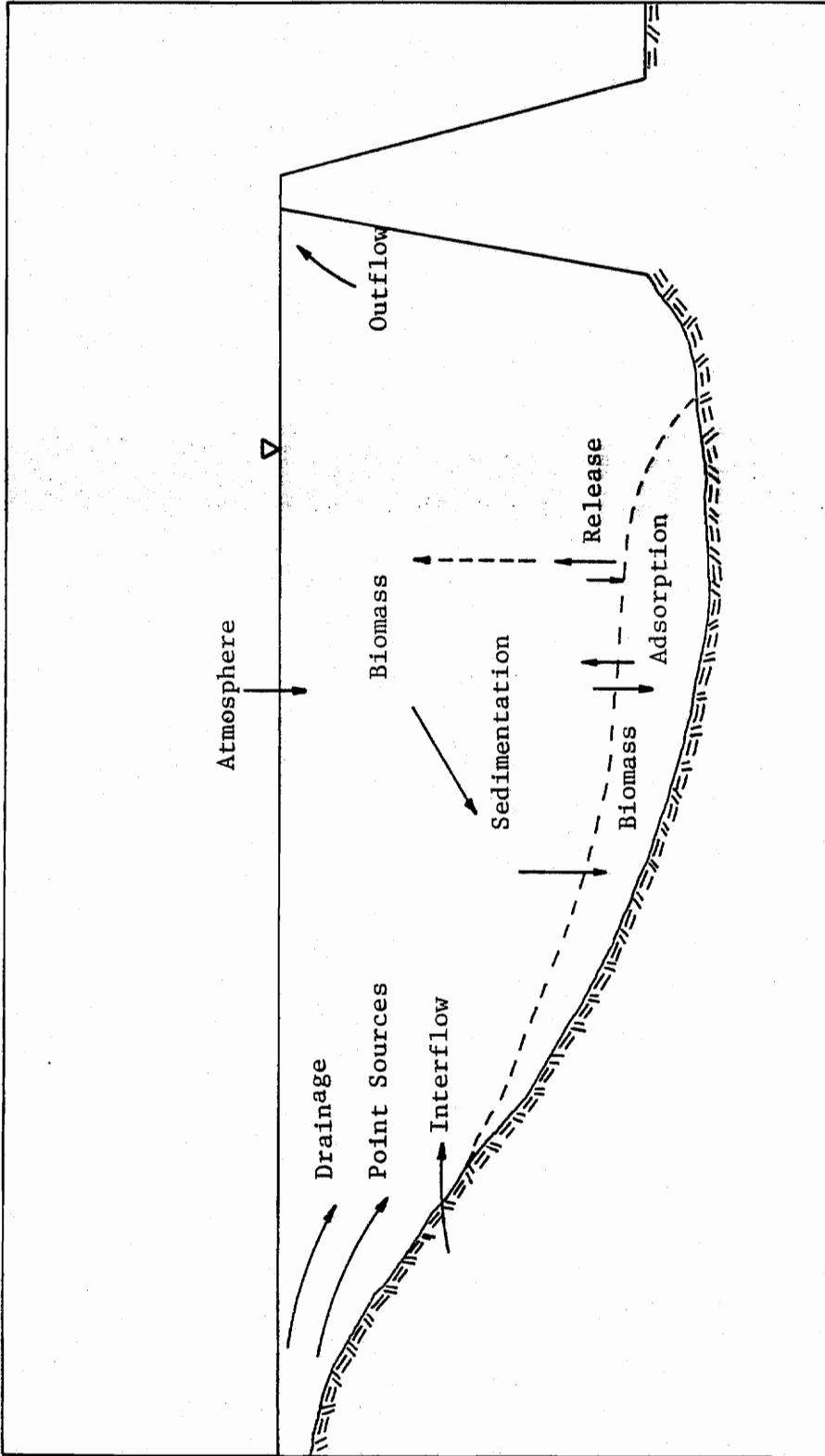

Figure 4. Schematic of Phosphorus Transformations In An Impounded Body

tion, mineralization, nitrification and denitrification. Inorganic nitrogen, as nitrate or ammonia, is the form utilized by benthic organisms to satisfy their metabolic requirements. Autotrophic production and release of nitrate in aerobic lake muds has been observed by Keeney (54). He also noted that all the nitrate produced was not released to the water column, but that significant quantities were being reduced in the anoxic muds directly under the oxidized microzone. Such immobilization of nitrate has been reported by Brezonik and Lee (55) to be a major nitrogen sink in Lake Mendota. Mortimer (39) noted that after the onset of anoxic conditions in Esthwaite water, the concentration of ammonia nitrogen showed an increase similar to that observed for Fe (II) and phosphorus. In addition, he noted that the quantity observed was almost an order of magnitude higher than what could be accounted for by the reduction of hypolimnetic nitrate, implying that a considerable sediment contribution was responsible for the difference. Chen et al. (37) and Patrick and Mikkelsen (56) noted that lake sediments and flood-
ed terrestrial soils, respectively, produced gaseous-end products upon the addition of nitrate during the persistence of anoxic conditions. This seeming paradox may be explained by ion exchange phenomena, whereby adsorbed ammonium is exchanged with soluble cations that arise when discrete precipitated compounds are destroyed at the onset of deoxygenation. Reexamination of Mortimer's data (39) shows that the maximum bottom water ammonia concentration in Esthwaite coincided closely with the Fe (II) concentration peak, whereas it should have occurred at some earlier time if it were a primary product of nitrate reduction. This is because the onset of nitrate reduction has been established to occur

earlier at an E_7 of approximately 225 mv, while the reduction of Fe (III) does not begin until $E_7=125$ mv (54). Figure 5 is a schematic of the nitrogen cycle in aquatic systems, emphasizing the sediment-water interactions that occur in impounded waters.

Microcosm Studies

Studies on sediment-water nutrient interactions carried out by making in situ observations or by doing small scale laboratory experiments have yielded much badly-needed basic information. However, in situ programs leave the researcher at the mercy of the vagaries of natural systems, while small scale experiments tend to be too-far removed from the realities of the aquatic environment. In attempts to address the inadequacies of the foregoing, researchers of late have begun to again work more with microcosm systems in the mold of the original work by Mortimer (39). Abbott (57) concluded that a sufficient degree of replication could be expected in microcosms treated alike to warrant their use in the assessment of water quality impact due to the change of one parameter or another. Microcosm studies have the unique advantage of allowing more successful replication of natural conditions while maintaining the control of bench-scale experiments. In addition, the large water to sediment ratios allow the running of very long experiments without drastically affecting the total mass of water column constituents by periodically withdrawing samples.

Mortimer (39) worked with six liter systems consisting of glass battery jars with a deposited sediment layer and an overlying water column, and provisions for maintaining either aerobic or anaerobic conditions. Under aerobic conditions, he found that the surficial sedi-

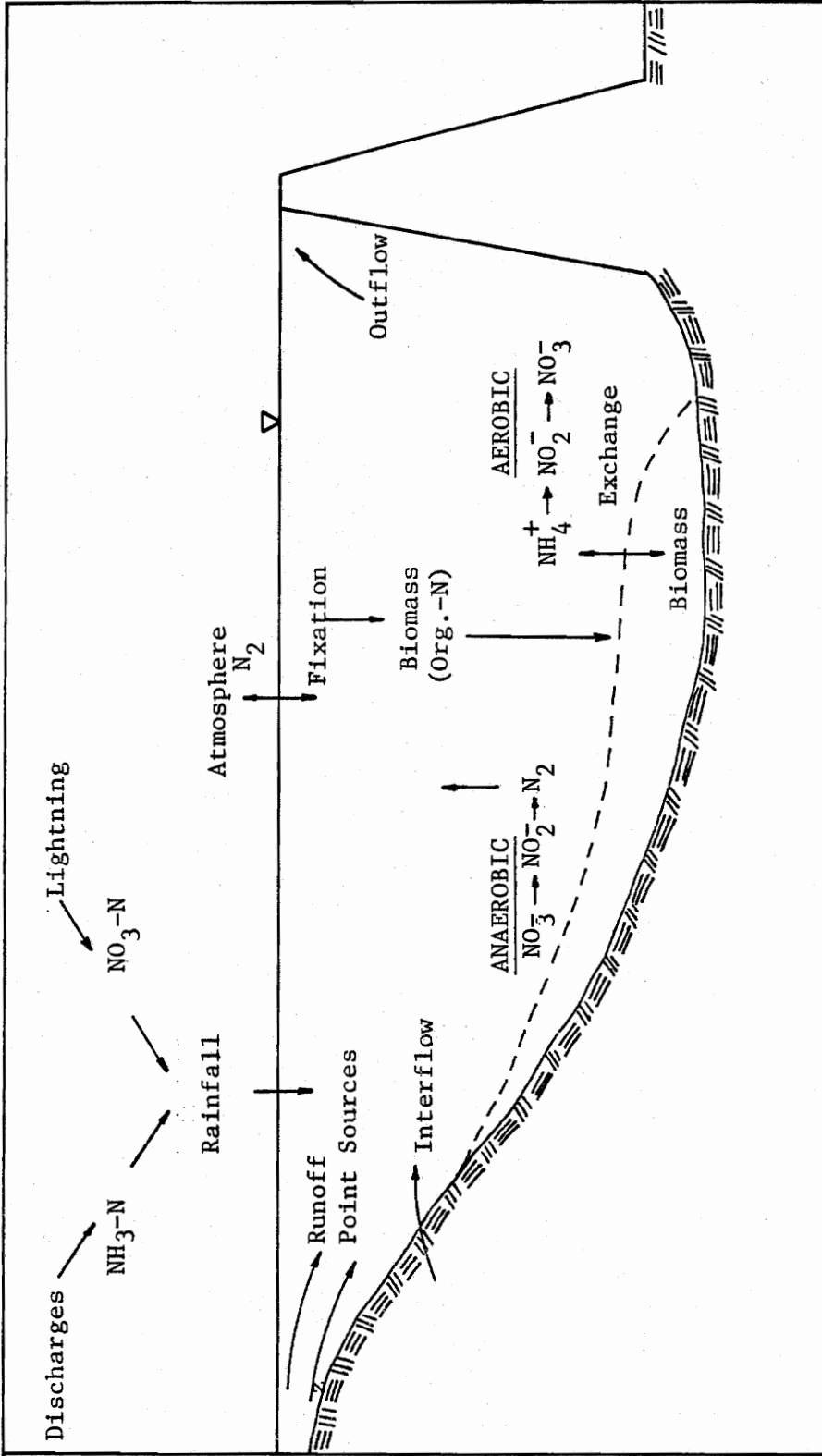

Figure 5. Schematic of Nitrogen Transformations In An Impounded Body

ment layer maintained a brown color characteristic of oxidized iron. The depth of the oxidized layer appeared to coincide closely with an E_7 value of 240 mv. Phosphorus, which was present in low concentrations in the Esthwaite water used, remained low for the duration of the run, as did the iron concentration. Unexpectedly, water column nitrate concentrations also declined under aerobic conditions, prompting Mortimer to speculate that it must diffuse downward into the deposited sediments until it reaches an anaerobic zone and is reduced. He found that the onset of ammonia and phosphorus release coincided closely with the rise of the 0.24 isovolt line to the sediment surface. In addition, the quantity of ammonium nitrogen liberated far exceeded that which could be attributed to nitrate reduction, a phenomenon also observed in situ, as noted earlier. Water column phosphorus concentrations rose sharply when the water column E_7 fell below 180 mv, as did the concentrations of ferrous iron.

Zicker and Berger (58) found that lime treatment of muds from two northern bog lakes placed in aerobic microcosms caused a sharp decline in soluble labelled phosphorus (P^{32}) in the contiguous water column. Postulating that the phosphorus was immobilized in apatite, they investigated the possibility of stimulating release by the acidification of the system, and found that almost 100 per cent regeneration could be expected.

MacPherson et al. (59) found that the distribution of phosphorus between bog lake muds and water in aerobic microcosms could be greatly affected by adjusting the pH of the overlying water. With no added water column phosphorus, adjustment of the pH to a value less than 5.0

or greater than 7.0 resulted in a marked rise in the quantity of phosphorus released from the muds. The minimum release occurred in that pH range where the H_2PO_4^- anion predominates and also where the minimum solubilities of iron and aluminum salts occur. Additionally, they found the entire process of release and adsorption to be reversible by making the appropriate pH changes to either alkaline or strongly acidic regimes.

Fitzgerald (60), in a study of muds from Wisconsin lakes, used microcosm systems in which sediments enclosed in dialysis bags were placed in contact with phosphorus-limited algal cultures. He concluded that less than one per cent of the sediment phosphorus and that none of the nitrogen was available for algal metabolism. In contrast, Harrison et al. (61) concluded that Upper Klamath Lake sediments could liberate inorganic phosphorus when placed in contact with active bacterial cultures. The bacteria produced organic acids as metabolic end-products that, in turn, served to chelate cations associated with inorganic phosphorus, releasing it to solution. Kimmel and Lind (62), working with sediments from Lake Waco, Texas, found that the adsorption of inorganic phosphorus in aerobic microcosms was independent of bacterial activity in the water column. The presence of bacteria promoted neither adsorption nor release and was deemed an insignificant factor in the exchange of sediment phosphorus.

Hannah et al. (63) found that aerobic sediments from Texar Bayou, Florida were capable of acting as a phosphorus buffer in that, at low water column concentrations, the sediments would either adsorb or desorb phosphorus to maintain a level of 0.03 mg/l in the overlying water. This observation implies aerobic release of phosphorus, a phenomenon not

often reported in the literature. Fillos and Swanson (64) observed a slight aerobic release of phosphorus from sediment taken from the Muddy River in Boston, Massachusetts, but it was also at low overlying water concentrations. It may be supposed that, while aerobic release may occur, the quantities of phosphorus liberated are generally not sufficient to have a great effect on the overlying water concentration in natural systems, where the water volume to sediment area ratio is generally much higher than that found in microcosm studies.

Fillos and Swanson (64) also conducted anoxic studies using both Muddy River sediment and muds from Lake Warner, Massachusetts. They, like Mortimer, observed close correlation between the release of benthal iron and the liberation of phosphorus. High anaerobic release rates of ammonia nitrogen were also observed from both sediments, even though essentially no nitrate had been present in the water column. This observation tends to confirm the hypothesis put forth by Mortimer (39) that the ammonia release is due to an ion exchange phenomena rather than the reduction of nitrate. Byrnes et al. (64), in fact, found that a considerable release of ammonia nitrogen was possible from Lake Mendota sediments, even under aerobic conditions. They placed sediments in a microcosm system and observed that diffusion of ammonia from the interstitial water could proceed to a depth as great as 16 cm into the deposited sediment layer. Chen et al. (66), in a study of sediment-water systems from Wisconsin lakes, found that, in contrast to the above, the molar quantities of nitrate and ammonia released from the muds were approximately equal during aerobic and anaerobic conditions, respectively. They did, however, note ammonia nitrogen concentrations in the sediment

interstitial water that were higher than those in the water column by a factor of four. It may be, then, that additional mixing at the interface would have resulted in the additional evolution of ammonia observed by others (39)(64). Austin and Lee (67), working with completely mixed systems of sediment and water from Lake Mendota, noted an approximate molar equality between ammonia destroyed and nitrate produced under aerobic conditions. Under anaerobic conditions, however, a large excess of ammonium was evolved, indicating that the additional mixing had, in fact, liberated quantities exchanged from the sediments that might otherwise have been trapped in interstitial waters.

Hynes and Grieb (68) used microcosm studies to assess the effectiveness of physical barriers in retarding phosphorus release from the bottom sediments of several lakes in the Great Lakes area. They allowed one system to operate without a barrier as a control and used sand and polyethylene sheeting to form the exchange barriers in two other systems. In operation, the bottom sediments slowly became anaerobic and the control system released a large quantity of phosphorus to the overlying water. The systems containing physical barriers both substantially reduced the quantity of phosphorus liberated but the impermeable polyethylene barrier was more effective, achieving a reduction of 79 per cent.

Special Analytical Needs

The analytical procedures developed for chemical determinations in deposited lake sediments have, in general been adapted from procedures known in the fields of water chemistry and wastewater analysis. This has been particularly true in the analysis of nitrogen forms and heavy metals, as will be discussed in the section entitled, Experimental

Methods. The same cannot be said about phosphorus analysis, because of the need to know much more about its availability and exchangeability in limnological studies.

Prior to 1957, the determination of soil inorganic phosphorus was made by performing a digestion of slightly less rigor than one designed to liberate the entire bound phosphorus mass. Standard Methods (69) describes a mild acid hydrolysis step as being adequate to liberate most condensed inorganic phosphates without disturbing the organic fraction. The resulting analysis then measures the sum of soluble reactive phosphorus and condensed phosphorus. This is not the most desirable procedure to use in the analysis of lake sediments, because it does not allow a differentiation to be made between phosphorus forms associated with various mineral fractions. Since it was apparent that such associations have a considerable effect on the exchange of sediment phosphorus, a method designed to quantify the amount in various fractions was needed. Chang and Jackson (70), recognizing that most soil phosphorus is bound to calcium, iron, and aluminum, developed a sequential extraction procedure designed to allow the fractionation of soil inorganic phosphorus into these component forms. Relying on the use of selective solvents applied in a defined sequence, they reported successful liberation of aluminum-bound P, iron-bound P, calcium-bound P, reductant soluble iron P, and occluded aluminum and iron P. Chang and Jackson (70) used mixtures of the discrete phase phosphate minerals strengite, variscite, and apatite in the verification study. Table I gives the operational definitions of the inorganic phosphorus fractions defined by Chang and Jackson (70). A slight modification of the basic

TABLE I

OPERATIONAL DEFINITIONS OF SOIL INORGANIC
PHOSPHORUS FRACTIONS ACCORDING TO THE
PROCEDURE OF CHANG AND JACKSON (70)

<u>Phosphorus Type</u>	<u>Definition(s)</u>
Calcium Phosphate	<ol style="list-style-type: none"> 1. Discrete mineral phosphates such as apatite 2. Phosphates precipitated on calcium carbonate
Aluminum Phosphate	<ol style="list-style-type: none"> 1. Discrete mineral phosphates such as variscite 2. Phosphates precipitated on aluminosilicates or amorphous oxides
Iron Phosphate	<ol style="list-style-type: none"> 1. Discrete mineral phosphates such as strengite 2. Phosphates precipitated on hydrous oxides of iron
Reductant Soluble Iron and Aluminum Phosphate	<ol style="list-style-type: none"> 1. Phosphates occluded internally in reductant soluble oxides of iron
Occluded Iron and Aluminum Phosphate	<ol style="list-style-type: none"> 1. Phosphates occluded internally in oxides of iron

procedure was developed by Petersen and Corey (71) to shorten the time of analysis and to enhance reproducibility. Williams et al. (72) reported a difficulty with resorption of liberated phosphorus in the aluminum and calcium bound phosphorus extraction steps on a selection of terrestrial soils. A standard addition approach was taken to remedy the problem. Harter (45) found that the neutral ammonium fluoride extraction step could, in fact, liberate some iron oxide forms in addition to aluminum phosphorus. It seems possible that this process might well balance off the resorption problem observed by Williams et al. (72) and thus achieve an accurate solubilization of Al-P. Harter (45) also reported that no material change occurred in the saloid and aluminum phosphorus fractions due to drying, but that some increase was observed in the iron fraction. Frink (28) concluded that good operational reliability was inherent in the procedure of Chang and Jackson (70), but that more definitional work was needed on the specific fractions. Harter (41), in a later work, concluded that the ammonium fluoride extractant removed organically bound phosphorus rather than aluminum P, but Frink (27) found that the same fraction exhibited excellent correlation with extractable aluminum in Bantam Lake sediments. This apparent inconsistency bears further work in attempting to elucidate more precisely the actual form of phosphorus solubilized by neutral ammonium fluoride.

It is apparent that, although some disagreements continue to exist in the literature with regard to the operational definitions of the phosphorus fractions liberated by the Chang-Jackson procedure, the methodology has considerable merit. Strong correlation has been shown to exist between some of the phosphorus fractions and other sediment

parameters, such as extractable cations, and organic content (27)(41). It is likely that such sediment characteristics may prove to be good indicator parameters for phosphorus exchange behavior, and, therefore, have value in use in predictive work.

III. EXPERIMENTAL METHODS

This field and laboratory investigation of the sediment-water interactions in the Niagara Impoundment was conducted during the period from Summer, 1971 to Winter, 1974. The lake and its tributary drainage basin are shown in Figure 6. A total of four sediment sampling and five water quality sampling stations were established in the impoundment, as shown in Figure 7. In addition, the Roanoke Sewage Treatment Plant discharge was sampled often enough to permit its characterization.

Sample Collection

Water Samples. Water samples were collected either by sample bottle immersion in the case of surface sampling, or by retrieval of an aliquot from a 1.0 liter Kemmerer Sampler in the case of bottom water samples. The collected samples were placed in acid washed-distilled water rinsed polypropylene bottles and stored in the dark over ice prior to transport back to the Sanitary Engineering Laboratory at V.P.I. & S.U.

Surface Sediments. Surface sediment samples were collected with either Ekman or Petersen dredges. Portions of sediment recovered from the dredge for analysis and use in laboratory studies were taken from the top of the recovered sample to assure that the quantity retained was characteristic of the current sediment-water interface. The retained sediment samples were placed in acid washed-distilled water-rinsed flexible polyethylene bags with a sealable lip. The samples were stored in the dark over ice during transport.

Sediment Cores. Sediment core samples were collected with a coring sampler designed and constructed by the author. A schematic of this

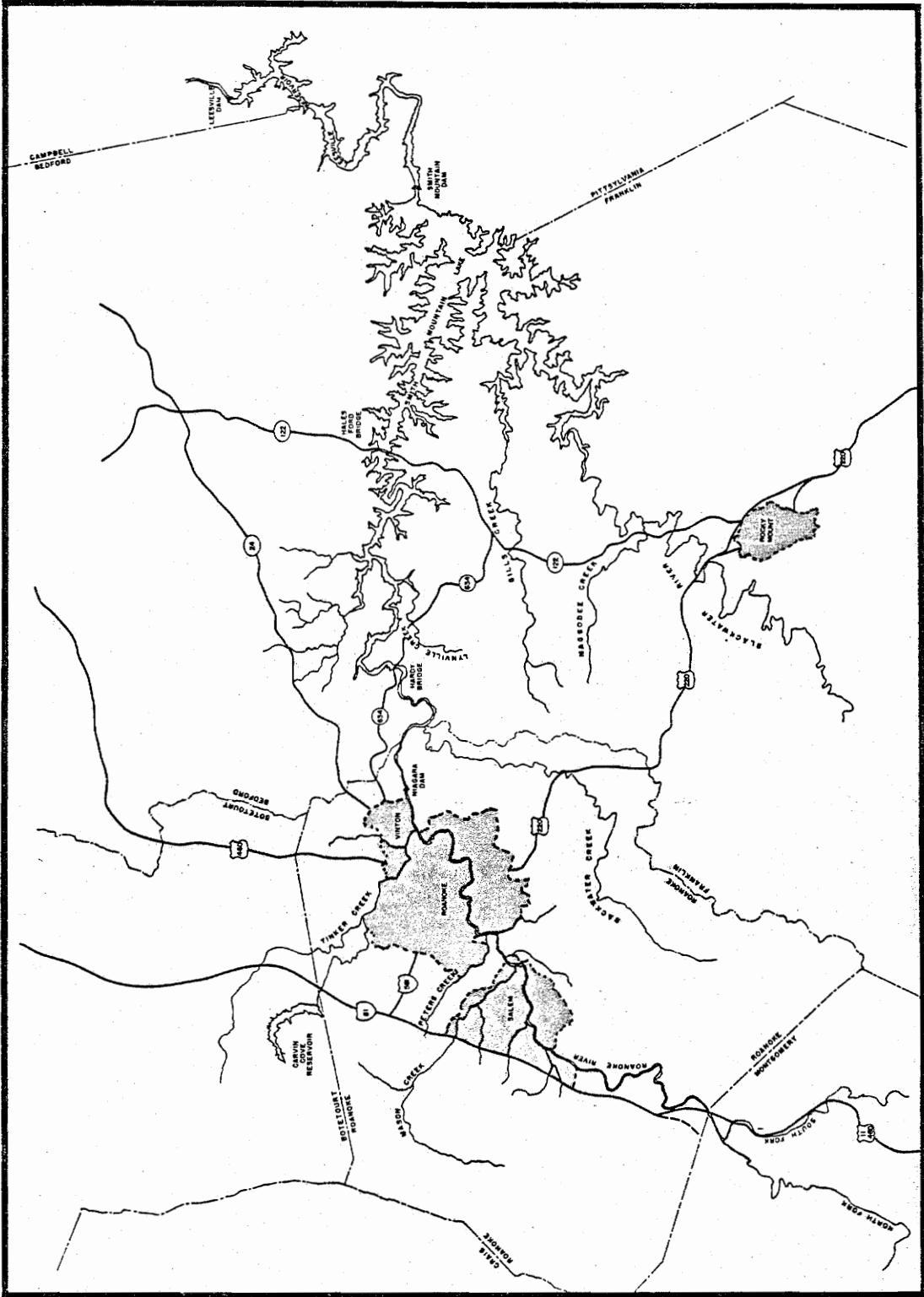

Figure 6. Roanoke River Basin

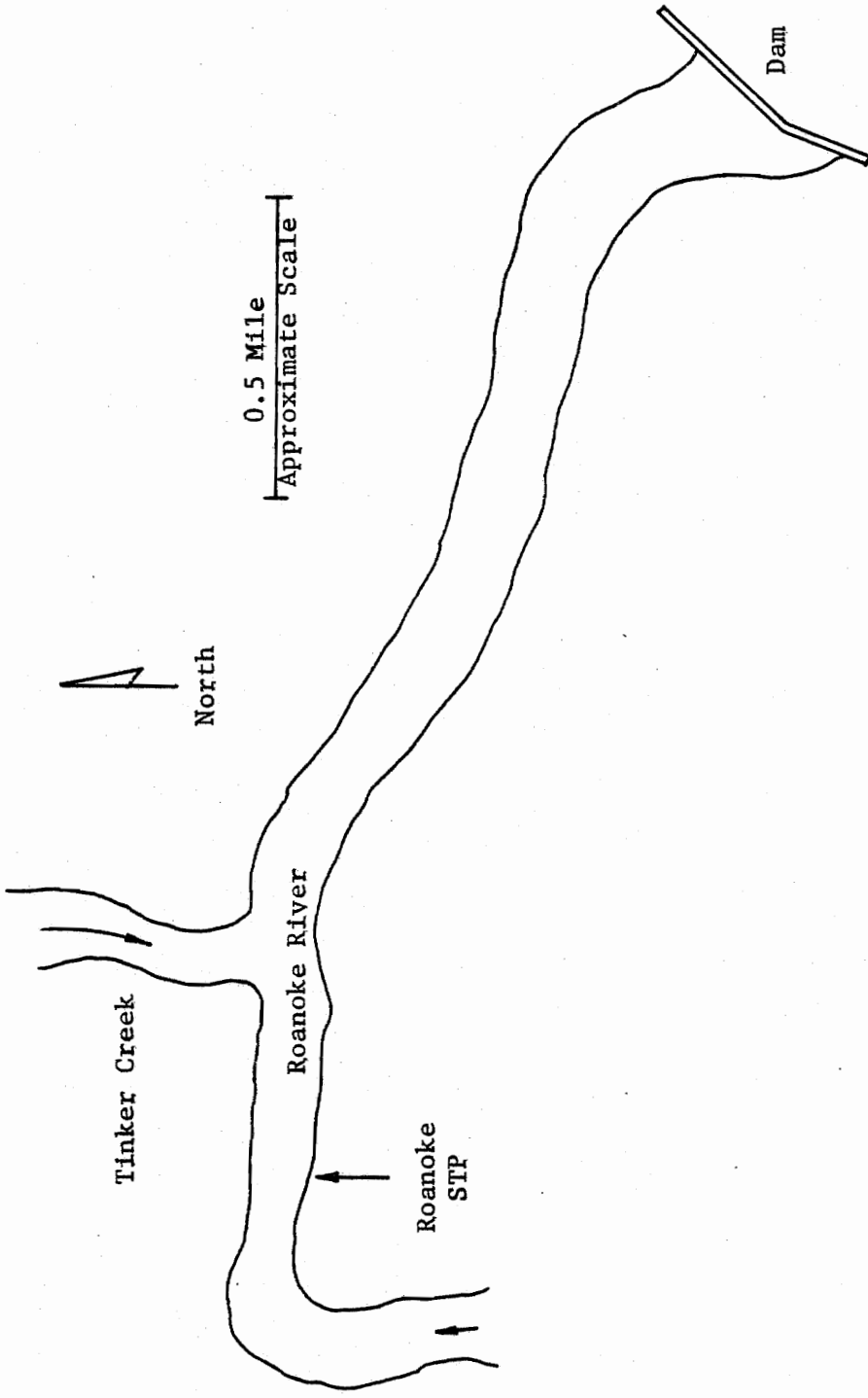

Figure 7. Study Area

piston-type sampler is shown in Figure 8. In operation, the neoprene piston was positioned in contact with the sediment-water interface, and held in that position by fixing a retaining chain to the centerwell of the sampling boat. As the corer was driven into the sediment, the piston remained fixed in position, in contact with the interfacial sediment. For retrieval, the piston, which provided a tight seal, was fixed to the corer body so that no displacement could occur, and the entire assembly withdrawn. The section of corer containing sample was detached, the initial length of core measured, and the entire sample extruded on-site. The individual portions were cut into five to ten centimeter sections, and stored as the surface sediment samples. A linear correction factor was applied to the core segment lengths at the time of analysis, according to the following:

$$L_{us} - L_{es} \times \frac{L_{uc}}{L_{es}}$$

where, L_{us} = length of the undisturbed segment
 L_{es} = length of the extruded segment
 L_{uc} = length of the undisturbed core
 L_{es} = sum of all the extruded segment lengths

Analytical Procedure - Water

Phosphorus. Total phosphorus determinations were made by preliminary hydrolysis using Persulfate digestion, neutralization, and development of a Molybdenum blue complex using stannous chloride [Sn (II) as the reductant, as detailed in Standard Methods (69)]. Orthophosphorus concentrations were made in the same manner, except the digestion step was omitted. Separate standard curves were prepared and carried through all steps of each analysis, since the addition of the digestion

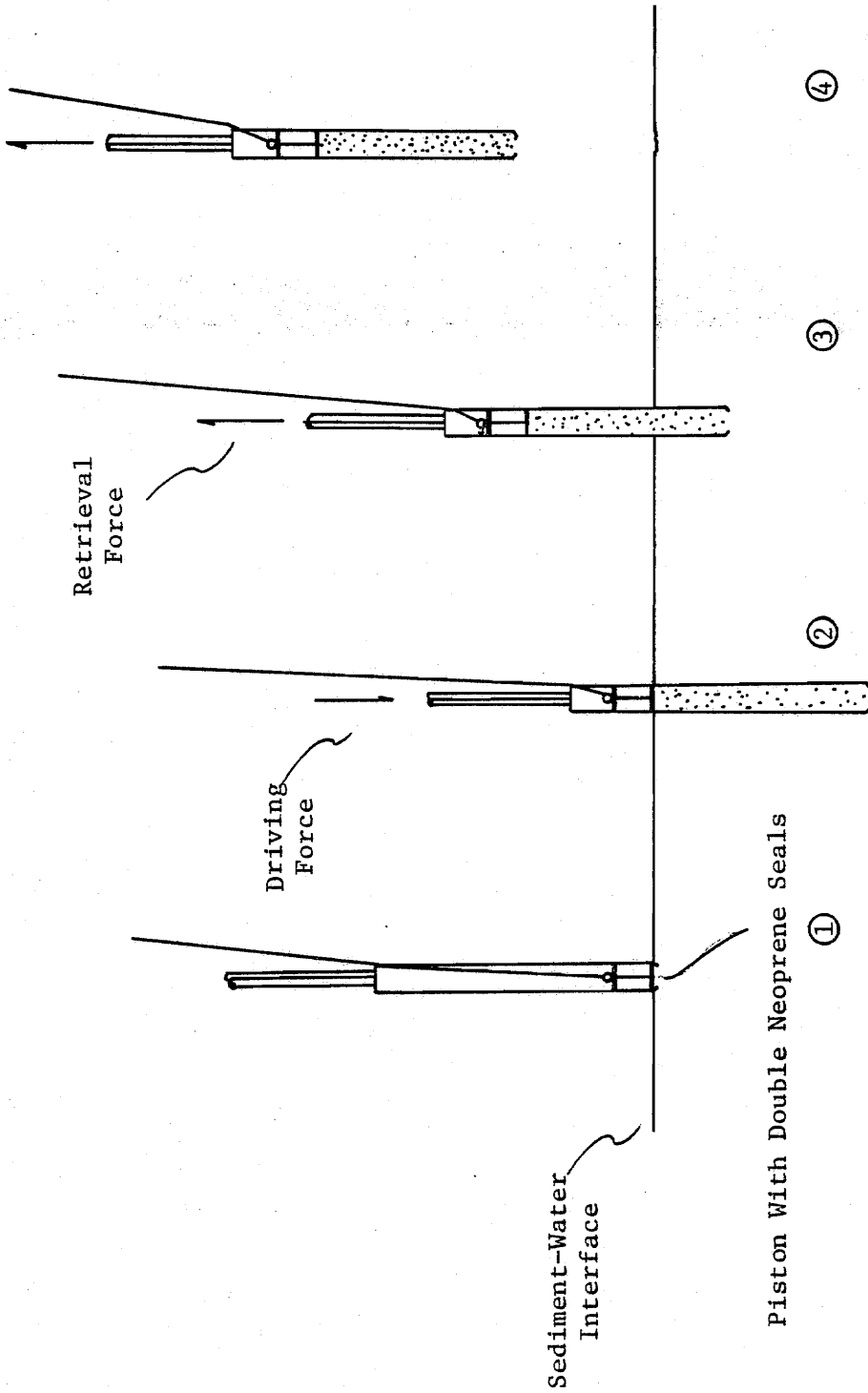

Figure 8. Schematic of Piston Corer Operation

solution was observed to alter the absorbance at the measurement wavelength. A mid-range standard was run with every group of analyses, and if poor agreement with the curve was obtained, a new standard was prepared and analyzed. Contingency plans called for the construction of a new standard curve if poor agreement was obtained with the second standard, but this was not necessary during the study. Concentrations were determined by comparison with the standard curve of readings obtained using a Klett-Summerson Industrial Colorimeter equipped with a 4 cm. light path.

Nitrogen. Ammonia nitrogen measurements were made using a Model 95-10 Orion gas selective electrode connected to an Orion Model 701 digital pH/mu meter. Concentrations were determined by the known addition method on samples adjusted to $\text{pH} > 10$, according to the procedures of the electrode manufacturer (73). Total Kjeldahl nitrogen determinations were made using the ammonia electrode in an aliquot of digestate made basic by addition of 10 N. NaOH. The digestion procedure was a scaled-down version of the method in Standard Methods (69) using electrically-heated 100 ml micro-Kjeldahl flasks.

Nitrate determinations were carried out using an Orion Series 92 liquid junction electrode with a double junction reference. The method of known additions was used in accordance with the manufacturer's instructions in order to account for interference from the presence of bicarbonate species (74).

Dissolved Oxygen. Dissolved oxygen determinations were made using the membrane electrode method as detailed in Standard Methods (69).

Iron and Aluminum. Metal determinations were made with a Perkin-

Elmer Model 403 atomic absorption spectrophotometer, equipped with deuterium background correction. Iron concentrations were measured in the range of linear absorbance response by direct aspiration into an air-acetylene flame, providing a detection limit of about 10 ug/l (75). In order to achieve the analytical sensitivity required for the purposes of this study, aluminum concentrations were measured after chelation and extraction into an organic solvent. The 8-hydroxyquinoline: methyl isobutyl ketone procedure of Fishman (76) was used and the analysis done in a reducing nitrous oxide-acetylene flame, providing a detection limit of 5.0 ug/l.

Analytical Procedures - Sediment

General. Deposited lake sediments in many instances arise from the erosion of terrestrial soils which are transported by tributary stream waters. The other obvious sources, in the case of the Niagara Reservoir, are [1] the solids produced from impervious surface washoff in urban lands, [2] the solid materials which are introduced from wastewater discharges, and, [3] the detritus produced by the life cycles in play in the water column overlying the sediments. Patrick and Mikkelson (56) detail the physical, chemical, and biological changes likely to occur in continuously submerged soils. The literature on soil analysis, however, does not recommend different treatment for partially wetted soils as opposed to those that are saturated (77)(78). Sediment samples, upon receipt in the laboratory, were homogenized and thin-layer spread on glass plates and allowed to air dry. The remaining portions were sealed in filled, air-tight plastic containers and refrigerated at 5 C until needed. Following the completion of the drying cycle, the sediment was

ground in a porcelain mortar, and finally passed through a 2 mm sieve to achieve the particle size range necessary for analysis. There are some indications in the literature that drying tends to shift the phosphorus balance somewhat, however, the air drying procedure employed (25±10) is thought to minimize the effects (79). Other researchers (77)(78) have reported successful results using a more rigorous drying at 110 C. The possibility of using an undried sediment sample for analysis was investigated, but the analytical requirements were such that it was necessary to have excellent precision in weighing out replicate quantities. As the variability in sample moisture and quantity of material >2 mm made it impossible to achieve the precision necessary with undried samples, this procedure was not pursued.

Gravimetry. Moisture content of sediment samples was determined by oven drying a weighed sample at 110 C according to the procedure in Methods of Soil Analysis (77). Percent organic matter was approximated by the volatile residue for semi-solid samples in Standard Methods (69). This method, which involves ignition at 550 C unavoidably involves the loss of volatile inorganic salts, but this was not felt to introduce serious error.

Phosphorus. Sediment inorganic phosphorus determinations were made according to a modification to the procedure of Chang and Jackson (39), which was developed to permit fractionation into discrete phosphorus portions according to reactivity and/or associated cations. Early attempts were made to determine total and organic phosphorus concentrations in the sediments, but due to the high organic contents of the samples retrieved, residual color became a problem even with the most rigorous of

digestions. In addition, safety considerations forced the discontinuation of work with the hydrofluoric and perchloric acids required for complete digestion. Finally, the soil science literature generally documents that the phosphorus fractions determined by the Chang-Jackson procedure are the most chemically active (17)(52). The analytical protocol for the Chang-Jackson fractionation procedure selected for this study involved the solubilization of inorganic phosphorus fractions by exposing the whole sediment sample to selective solvents in a defined sequence. In order, the inorganic phosphorus fractions determined were: [1] saloid-bound, [2] aluminum-bound, [3] iron-bound, [4] reductant soluble iron bound, [5] occluded iron and aluminum bound, and [6] calcium-bound. Figure 9 summarizes the technic developed for this study, which was based on the work of several workers (70)(71)(79). The importance of order of solvent exposure must be emphasized, because, for example, the NaOH extraction would solubilize both aluminum and iron phosphorus, so it must follow the NH_4F extraction of aluminum phosphorus only. The method used for color development for phosphorus concentration estimation in the extracts was designed to use a common molybdate - SnCl_2 reagent set for all six extractions. This necessitated a pH adjustment in the determination of the aluminum fraction, but was otherwise found to be quite satisfactory. The methodology for the modified procedure closely follows Figure 9. Standards were carried through each of the fractionation steps and a calibration curve prepared for each one, because the slopes were found to differ considerably due to the differing optical activities of the extractants. The colorimetric procedures were the same as those detailed earlier for the analysis of aqueous so-

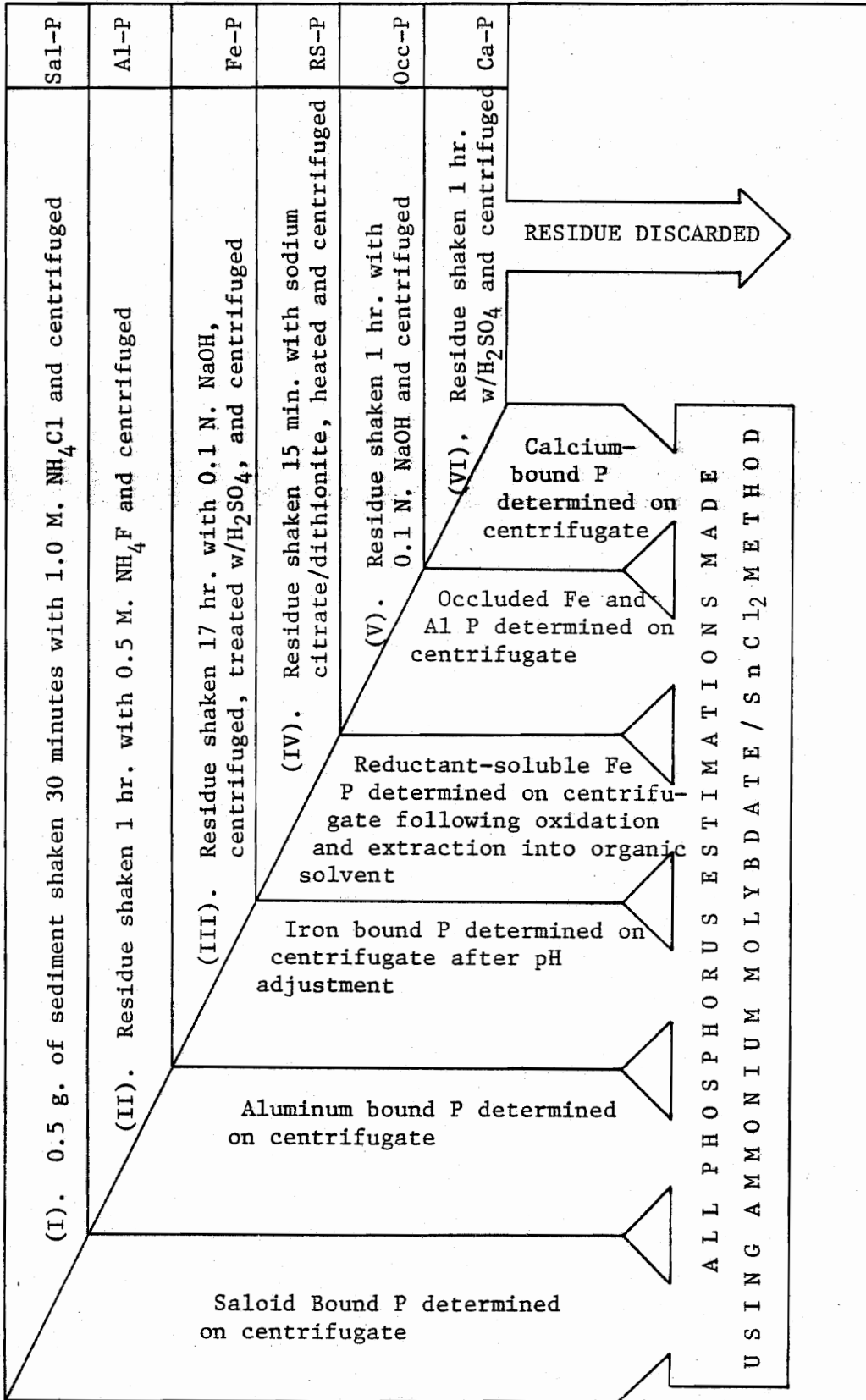

Figure 9. Schematic of the Chang-Jackson Fractionation

lutions.

Nitrogen. Sediment ammonia was determined by suspending a quantity of air-dry sediment in distilled water, adjusting the pH 10, mixing for 1.0 minute, and measuring ammonia as in aqueous solution with an Orion 95-10 gas selective electrode. The method, developed by Banwart, et al. (80) was found to be satisfactory to extract concentrations of 0.1 mg/l as N. Total Kjeldahl Nitrogen in sediments was determined by carrying out a micro-Kjeldahl digestion, making the sediment extract alkaline, and determining the liberated ammonia by the electrode method as proposed by Bremner and Tabatabai (81). Organic nitrogen was then computed by difference.

Extractable Metals. An extraction solution was prepared by mixing 1.0 N. HCL and 1.0 N. H₂SO₄ in a ratio of 2:1 and diluting to 1.0 liter according to Perkin-Elmer (75). The extraction was performed by shaking a quantity of air-dried sediment with an aliquot of the extraction solution for 15 minutes. This procedure has been shown to free bound cations, while leaving those within the soil structure intact. Following filtration to remove solids, the extracts were analyzed by direct flame aspiration on a Perkin-Elmer Model 403 atomic absorption spectrophotometer equipped with deuterium background correction.

Microcosm Studies

Equipment. A series of four reactors were constructed in which long-term observations of sediment-water interaction could be made. Initially, sealed glass reactors were employed for benchtop microcosm studies. Both the location and reactor design, however, soon proved to be unsatisfactory, because the vessels had no provision for continuous

mixing. In addition, the diurnal light cycle in the laboratory allowed considerable algal production to take place - preventing anaerobic conditions from becoming established in the reactors when they were desired.

The second generation reactor design utilized plexiglas as the construction material. Each reactor was constructed from a plexiglas cylinder 7.5 inches in diameter and 15 inches long. The bottom was sealed with a permanent plate, and the upper edge was fitted with a compressible o-ring over which the top could be fitted, providing a gas-tight seal. Ports bored into the fitted top were sealed when not in use with no. 8 neoprene stoppers. Seven ports were provided; one each for sample withdrawal, water column and sediment platinum electrodes, a calomel reference, inert gas sparging, mixing, and venting. A schematic of the reactor design is shown in Figure 10. The platinum electrodes, used with a calomel reference, to provide a measure of the oxidation-reduction potential, E_c , were fabricated in-house. They consisted of a thin platinum wire fused into the end of a pyrex tube, with positive electrical contact being made with the copper lead wire by imbedding both in molded Wood's metal. The electrodes were "aged" with platinum black by passing a direct electric current through a chloroplatinate solution with the electrodes acting as the cathode. One electrode was bent to a horizontal position and allowed to lie in contact with the sediment surface, while the other was allowed to remain in the water column, as shown in Figure 10. This positioning of electrodes allowed simultaneous measurement of water column and surface sediment ORP during the course of microcosm experiments. Continuous

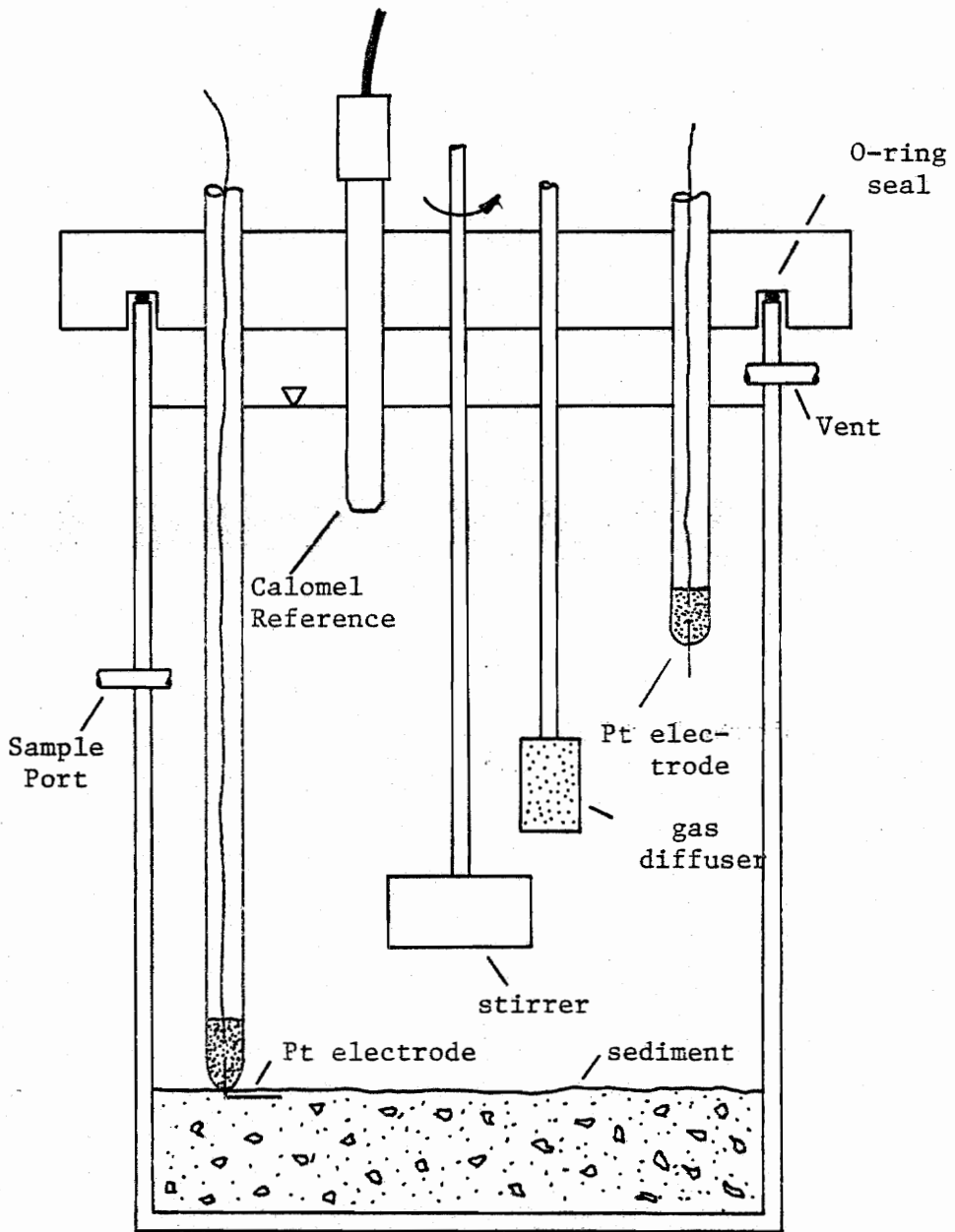

Figure 10. Schematic of Microcosm Reactor

mixing was provided by a 5 r.p.m. gearmotor connected to a paddle located 4 inches above the sediment surface to avoid disturbance. The second generation microcosms were operated in a constant temperature room at 20 C. The reactors remained covered at all times in order to avoid stimulation photosynthetic activity.

Analyses. All chemical and physical analyses were conducted with methods identical to those detailed earlier for sediment and water samples obtained directly from the reservoir, with one exception, oxidation-reduction potential (ORP). These values were reported as E_C , which is the potential measured against a calomel reference. In order to obtain absolute ORP readings, E_7 , the values would require adjustment according to the following (82):

$$E_7 = E_C - 241.5 \text{ mv} \pm 59.2 (7.0\text{-pH})$$

This would give the correct potential against a hydrogen half-cell, which by definition, has a potential of 0.0 mv. Potentials were measured with an Orion Model 401 portable pH/mv meter. Prior to making any measurement, a shorting strap was connected across the reference and measuring terminals on the meter, and the device adjusted to zero potential, to assure that subsequent potentials read with the instrument represented absolutes.

Microcosm Operation. The microcosms were operated in such a way as to make possible assessment of several factors in sediment-water interactions. Specifically, it was desired to assess the effects of the following on plant nutrient behavior:

1. Surficial Sediment constituency
2. Exposed Surficial Sediment Area
3. Water Column and Sediment ORP status

4. Water column phosphorus concentration

In actual operation, 1.0 liter of wet sediment was placed in the bottom of each reactor. During those experiments designed to assess the effect of exposed surface area, the same volume was used, but one to four glass 50 mm Petri dish tops were impressed into the sediment surface to effectively seal the area beneath from direct contact with the water column. Each dish had an area of 19.6 cm², which represents 6.9 percent of the total exposed sediment area in the microcosm. Following sediment placement, the water prepared for the experiment was gently siphoned into each reactor in such a way as to avoid disturbing the sediment surface. The water column consisted of nine liters of water prepared in advance to conform with the objectives of the experiment. In general, however, to maintain conditions similar to those found in situ, the reactor waters were made up from deionized tap water buffered with 75.0 mg/l bicarbonate alkalinity expressed as CaCO₃. The other constituencies of the water, such as initial phosphorus concentration, were varied according to the requirements of the run in progress. When desired, microcosm water column pH was adjusted with dilute HCl or NaOH. When mixing of the surficial sediments was desired, the garmotor was equipped with a larger paddle and operated at a higher r.p.m., which was made possible by connecting the apparatus to a variable voltage transformer. Microcosms runs were conducted for 30 days (720 hours), at 20 C in a darkened constant temperature room during which daily samples were withdrawn through the port provided for that purpose. Immediately following, an equal volume of water, having a constituency identical to that at the beginning of the experiment, was returned to the reactor by gently siphoning

it in through the same port. During anaerobic microcosm runs, a chemical oxygen demand of 20 mg/l was made available by adding a glucose solution to each reactor. The resultant oxygen drawdown made it possible to establish anaerobiosis more rapidly than might have otherwise been possible. In addition, a stock solution of 1,000 mg/l Na_2SO_3 was available to speed oxygen drawdown if needed. Following removal of sample and addition of make-up water during anaerobic runs, the reactors were sparged with N_2 gas at a low rate for two hours. Surficial sediment samples were taken at the beginning and end of a run by scraping the surface with a horizontal razor blade.

Batch Sorption Studies

It was desired to perform a laboratory evaluation that could be used to quantitatively determine the essential elements of the sorption kinetics of inorganic phosphorus on Niagara sediments. Accordingly, a series of batch studies were undertaken to determine the following for both adsorption and subsequent desorption under aerobic and anaerobic conditions:

1. Equilibrium Time
2. Optimum Adsorbate Solution pH and oxidation-reduction state
3. Adsorption Maximum
4. Active Inorganic Phosphorus Fractions

The batch studies were undertaken with 0.5 g. samples of air-dry, 2 mm Niagara sediments, collected and characterized by the procedure of Chang and Jackson (39) as previously described. A series of sediment residues and 30 ml aliquots of KH_2PO_4 solutions of increasing concentration were placed in 100 ml polypropylene centrifuge tubes, sealed, and placed on an oscillating shaker table. Adjustments of initial pH were

made with dilute HCl. Following removal from the shaker table, the tubes were placed on a centrifuge and spun 10 minutes at 20,000 r.p.m. The supernatant was decanted and phosphorus adsorption or desorption measured by loss or gain in solution concentration, respectively. The centrifuged sediment residues were then subjected to an inorganic phosphorus fractionation according to the procedure of Chang and Jackson (39), which enabled the author to identify the active fractions in the exchange process.

IV. RESULTS AND DISCUSSION

Samples were collected from the study area at intervals during the period from 5 September, 1972 to 24 May, 1974. Water samples from the Niagara Impoundment were taken from shore at the dam and at the tail-water site on each visitation. Those trips on which a sampling boat was used were undertaken to retrieve water samples at the remaining reservoir stations, surficial sediments at all four stations, and, on two occasions, core samples at the reservoir stations. Table II shows the dates and types of samples taken for all sampling trips.

Evaluation of Sediment Analysis Techniques

Surficial sediment samples were collected at all stations on 13 April, 1973, and subjected to ten replicate analyses for all parameters that were to be measured on the natural system for the remainder of the study. This was done so as to make possible the evaluation of the methods adopted for sediment analysis. Tables III and IV present summaries of results obtained from the analysis of the replicates of surficial sediment samples from each of the four stations in the impoundment. Using the computed samples mean, \bar{x} , and standard deviation, s , as estimates of the population parameters, the limits of error in estimating the population mean at a 90 percent level of significance were computed for an analytical protocol using three replicates. The value, E_{90} , the predicted error maximum at 90 percent significance, was computed by the following:

$$E = \mu - \bar{x} = \frac{ts}{\sqrt{n}}$$

where: μ = population mean

TABLE II
SAMPLE COLLECTION SCHEDULE

DATE	WATER SAMPLES		SEDIMENT SAMPLES	
	<u>Dam and Tailwater</u>	<u>All Stations</u>	<u>Surficial</u>	<u>Cores</u>
5 September 1972	X	X	X*	
14 September 1972	X			
25 September 1972	X			
7 October 1972	X			
27 October 1972	X			
16 November 1972	X			
14 December 1972	X			
19 January 1973	X	X	X*	
16 February 1973	X			
14 March 1973	X	X	X	
13 April 1973	X	X	X	X*
11 May 1973	X			
25 May 1973	X	X	X	
6 June 1973	X			
15 June 1973	X			
29 June 1973	X	X	X	
7 July 1973	X	X	X	X
17 July 1973	X			
26 July 1973	X	X	X	
22 October 1973	X			
16 November 1973	X	X	X	
15 December 1973	X			
19 January 1973	X			
4 February 1974	X	X	X	
12 March 1974	X			
2 April 1974	X			
10 May 1974	X			
24 May 1974	X	X	X	

*Samples Discarded

\bar{x} =sample mean
 t =Student's t @ $\alpha=0.05$
 s =sample standard deviation
 n =number of replicates = 3

The percentage of error in estimating the value of \bar{x} was computed by:

$$\% \text{ Error} = \frac{E_{90}}{\bar{x}} \times 100$$

The values in Table III indicate that the adopted inorganic phosphorus fractionation procedure of Chang and Jackson (39) produced acceptable replication, except in those instances where fraction concentrations were relatively low. In general, the low fraction concentrations were found in those sediments having a higher fraction of sandy material. These were located in the headwater areas of the reservoir, at stations three and four. The saloid and occluded phosphorus fractions were found to be relatively low in all the samples, and, as a result, the potential error was generally the highest in them. Figure 11 is a plot of the potential percent error against individual fraction concentration. As may be seen, when the phosphorus fraction concentration exceeds 0.12 mg/g the mean estimate error using three replicates drops below 15 percent at a significance level of 90 percent. Because of the relatively good fit obtained for a power curve ($r=0.74$) using data from all fractions, it is thought that the precision of the analysis is more a function of the limitations imposed by sample preparation rather than of the colorimetric analysis. This observation is born out by the fact that the greatest variability in results occurred in samples from the upstream stations. The finer material from stations one and two made it possible to prepare more homogeneous quantities of sample, while the coarser material from stations three and four

TABLE III
 REPLICATE ANALYSIS SUMMARY - INORGANIC PHOSPHORUS

<u>Station: Fraction</u>	<u>n</u>	<u>\bar{x}</u> <u>mg/g</u>	<u>s</u> <u>mg/g</u>	<u>E₉₀*</u> <u>mg/g</u>	<u>% of \bar{x}</u>
1: Saloid-P	10	0.046	0.004	0.007	14.7
2:	10	0.038	0.005	0.008	22.2
3:	10	0.028	0.003	0.005	18.1
4:	10	0.011	0.002	0.003	30.7
1: Aluminum-P	10	0.330	0.003	0.005	1.5
2:	10	0.275	0.006	0.010	3.7
3:	10	0.124	0.008	0.013	10.9
4:	10	0.042	0.003	0.005	12.0
1: Iron-P	10	0.255	0.005	0.008	3.3
2:	10	0.200	0.008	0.013	6.7
3:	10	0.015	0.004	0.007	45.0
4:	10	0.010	0.002	0.003	33.7
1: Reductant Soluble-P	10	0.670	0.004	0.007	1.0
2:	10	0.470	0.005	0.008	1.8
3:	10	0.239	0.003	0.005	2.1
4:	10	0.145	0.003	0.005	3.5
1: Occluded-P	10	0.025	0.006	0.010	40.5
2:	10	0.020	0.006	0.010	50.6
3:	10	0.018	0.007	0.012	65.6
4:	10	0.012	0.009	0.015	126.4
1: Calcium-P	10	0.492	0.002	0.003	0.7
2:	10	0.454	0.004	0.007	1.5
3:	10	0.280	0.006	0.010	3.6
4:	10	0.158	0.005	0.008	5.3

*Predicted error using triplicate analyses

TABLE IV

REPLICATE ANALYSIS SUMMARY - NITROGEN, METALS, AND SOLIDS

Station:	Analysis	n	\bar{x}	s	E_{90}^*	% of \bar{x}
1:	NH ₃ -N, mg/g	10	0.25	0.015	0.03	10.1
2:		10	0.37	0.014	0.02	6.4
3:		10	0.45	0.020	0.03	7.5
4:		10	0.50	0.031	0.05	10.4
1:	TKN, mg/g	10	7.61	0.06	0.10	1.3
2:		10	8.17	0.06	0.10	1.2
3:		10	4.42	0.05	0.08	1.9
4:		10	1.08	0.06	0.10	9.4
1:	Extractable Al, mg/g	10	11.05	0.35	0.59	5.3
2:		10	4.05	0.27	0.46	11.2
3:		10	2.25	0.22	0.37	16.5
4:		10	3.25	0.23	0.39	11.9
1:	Extractable Fe, mg/g	10	10.72	0.25	0.42	3.9
2:		10	8.07	0.15	0.25	3.1
3:		10	2.59	0.40	0.67	26.0
4:		10	1.07	0.17	0.29	26.8
1:	Volatile Solids, %	10	19.75	0.41	0.69	3.5
2:		10	15.80	0.58	0.98	6.2
3:		10	12.50	0.94	1.58	12.7
4:		10	5.25	0.89	1.50	28.6

* Predicted error using triplicate analyses

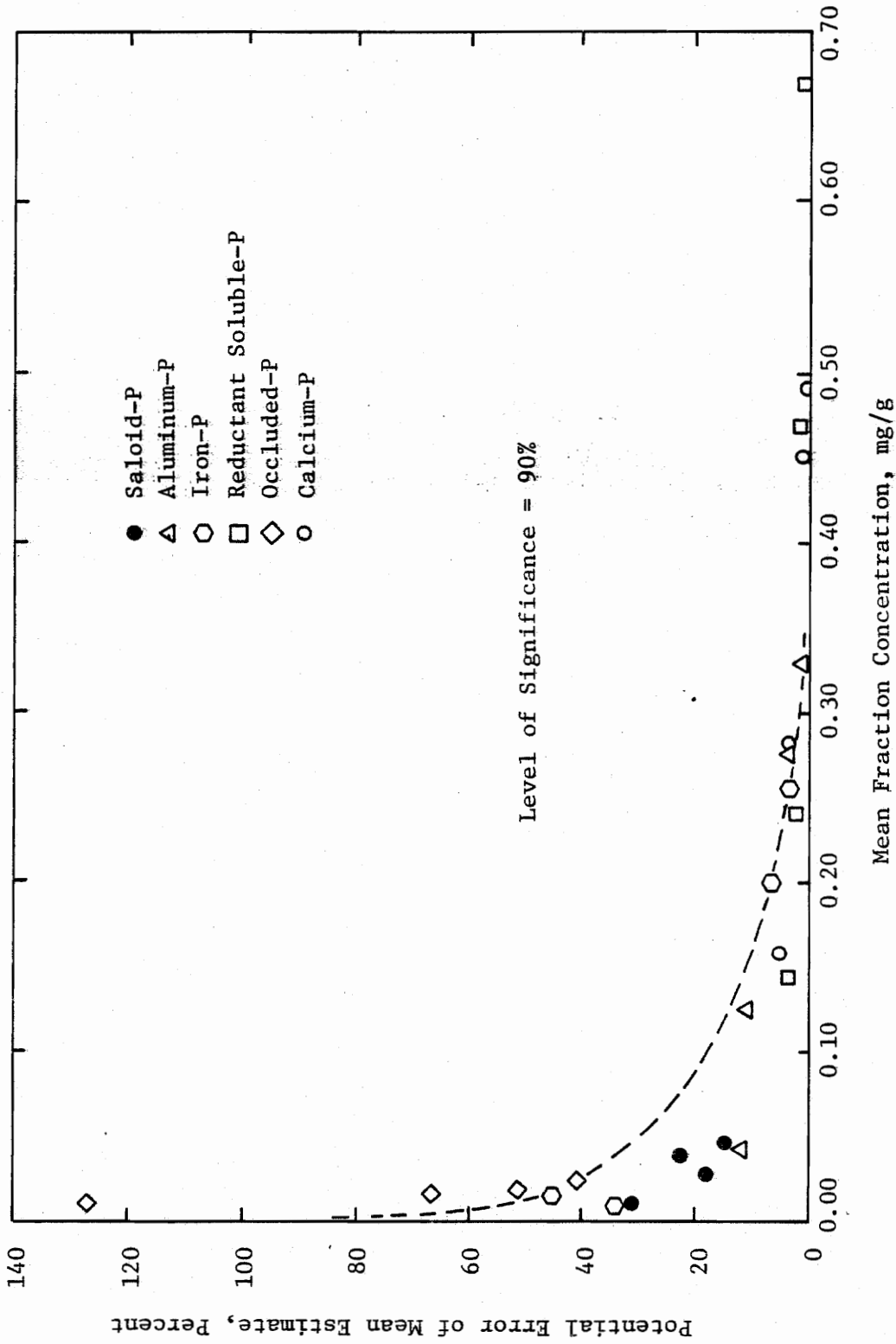

Figure 11. Variation in Potential Analytical Error with Mean Phosphorus Fraction

made such homogeneity more difficult to obtain. In addition, the lower concentrations at these stations were closer to the detection limit of the analysis, and, for that reason, greater variability was to be expected.

The values in Table IV show that a satisfactory degree of precision was obtained in samples from all stations by doing triplicate analyses of nitrogen forms. Satisfactory results were likewise obtained for extractable metals, with the exception of iron at stations three and four, where the ninety percent confidence interval using triplicate analyses ranged, respectively, between ± 26 and ± 27 percent of the estimated mean. This was again thought to be a function of the difficulty in obtaining a homogeneous sample of the more granular material. The analysis of volatile solids at each station showed adequate precision, with the exception of that for station four, probably for the same reason previously observed.

Surficial Sediment Characterization-Longitudinal Variation

The surficial sediment samples collected on 13 April, 1973 were analyzed for volatile solids, nitrogen and phosphorus forms, and extractable iron and aluminum. The variations in surficial sediment concentrations for these parameters with distance above the Niagara Dam were examined.

Volatile Solids. The variation in surficial sediment volatile solids with distance above Station 1 is shown in Figure 12. It is apparent that the volatile solids concentration rose as the distance from the spillway decreased. This may be adequately explained by visual observation of the retrieved sediment samples, and by considera-

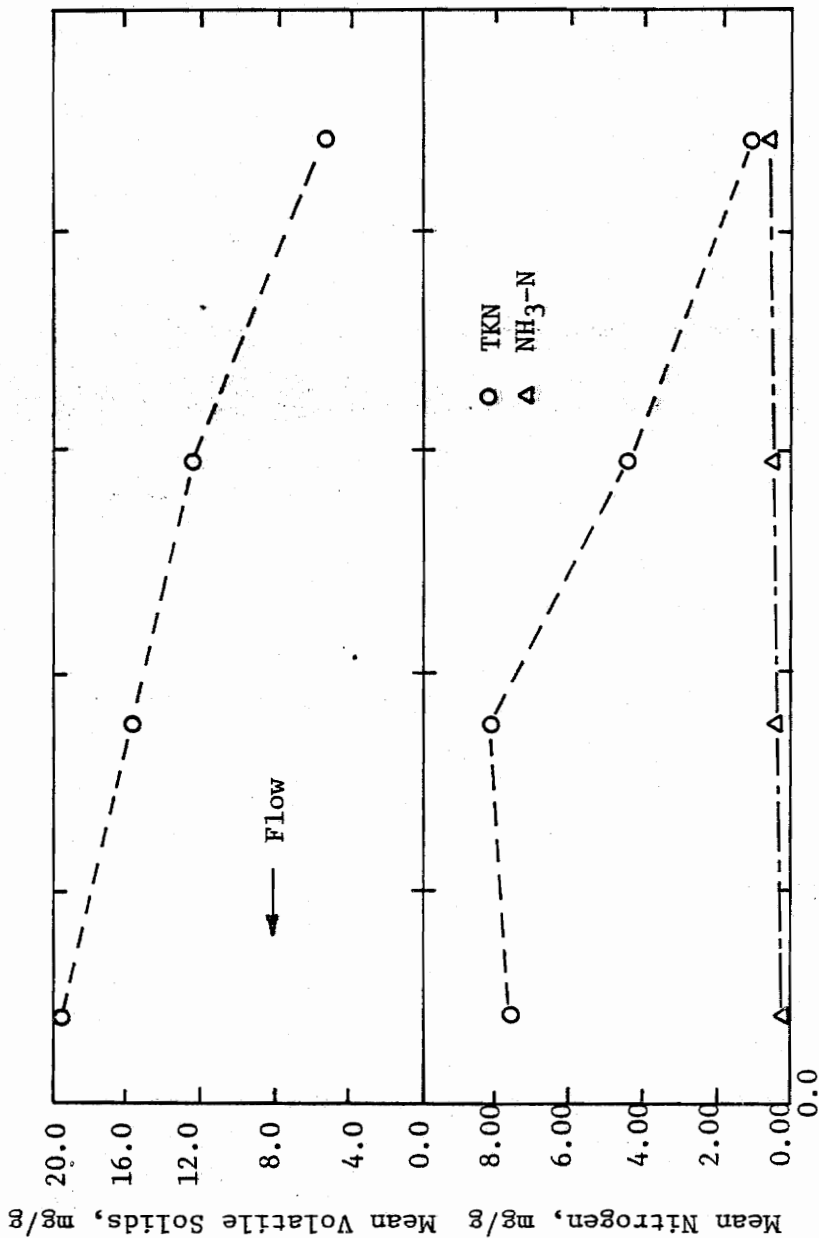

Distance Above Dam, miles

Figure 12. Variation of Sediment Volatile Solids and Nitrogen with Distance Above Dam (13 April, 1973)

tion of the hydraulics of the impoundment. The sediment samples collected from the upper end of the impoundment tended to contain more coarse, sandy material than those from the lower end, which were finer and more odiferous. As observed by Serruya (30) in his study of Lake Kinneret, the more flocculent, organic sediments tended to migrate to the deeper areas. This observation applies to the Niagara Reservoir also, and may be used to explain the observed distribution of volatile solids in the impoundment. The sediments are deposited in order of decreasing settling velocity as the free river flow enters the tailwaters of the impoundment. This causes the placement of the rapidly settling, coarse, inorganic matter in the upstream areas, and the flocculent, organic materials in the downstream areas. As may be seen from the data in Figure 12, the material at station 4 was of a sandy constituency, containing in excess of 94 percent non-volatile material. The organic fraction rose to almost 20 percent in the dam station sample, which could be characterized as an organic muck. The decrease in sediment volatile solids with longitudinal distance above the dam could be generally characterized by a declining linear relationship.

Nitrogen. The trend in total Kjeldahl nitrogen variation was similar to that observed for volatile solids: values tended to decrease with distance above the dam. The TKN value of 7.61 mg/g of sediment (dry weight) in the vicinity of the dam declined to 1.08 mg/g at Station 4. Again, as with volatile solids, it was observed to be an approximately linear decline. The sediment concentration of ammonia nitrogen, by contrast, exhibited an increase with distance from Station 1, as shown in Figure 12. The likely explanation for the increase is

that ammonium ion in contact with the sediments near the dam is fixed in the organic matter present, and therefore does not show up in the ammonium analysis. The higher sediment ammonium quantities observed near the upper end of the impoundment are probably fixed by cation exchange phenomena, and are readily released at the high pH of the ammonium analysis. It would appear that, while the organic nitrogen fraction declines with distance from the dam, the ammonia fraction increases because of the presence of materials having less organic matter. The fixation in such materials is more likely due to cation exchange, and, as a result, the sediment ammonia appears in the inorganic form during analysis, instead of as a part of the organic nitrogen fraction. The declining ratio of sediment organic nitrogen to sediment ammonia with distance above the dam displayed on almost perfect linear relationship, as shown in Figure 13. This relationship supports the hypothesis that the ammonia fixation mechanism is governed by organic immobilization at the downstream sites and by cation exchange at the upstream sites.

Inorganic Phosphorus. Variations in sediment inorganic phosphorus fractions with distance above the Niagara Dam are shown in Figure 14. The concentration of each fraction was generally observed to decline with distance above the dam, with the reductant soluble and iron phosphorus fractions exhibiting the most rapid decrease. The occluded phosphorus fraction showed only a minor decline. The declines in fraction concentrations shown in Figure 14 are probably closely related to the changes in the sediment composition observed with distance above the dam. The data in Table V show the fractional composition of the

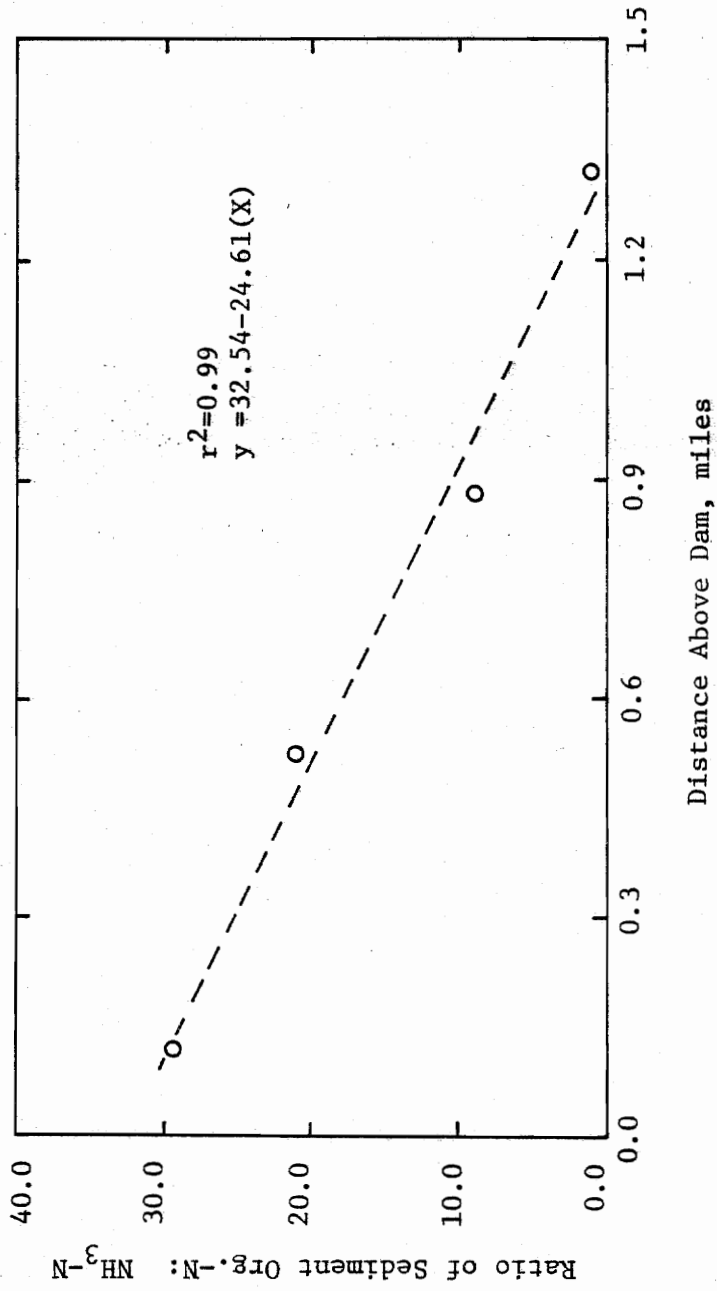

Figure 13. Variation of Ratio of Sediment Organic to Ammonia Nitrogen with Distance Above Dam (13 April, 1973)

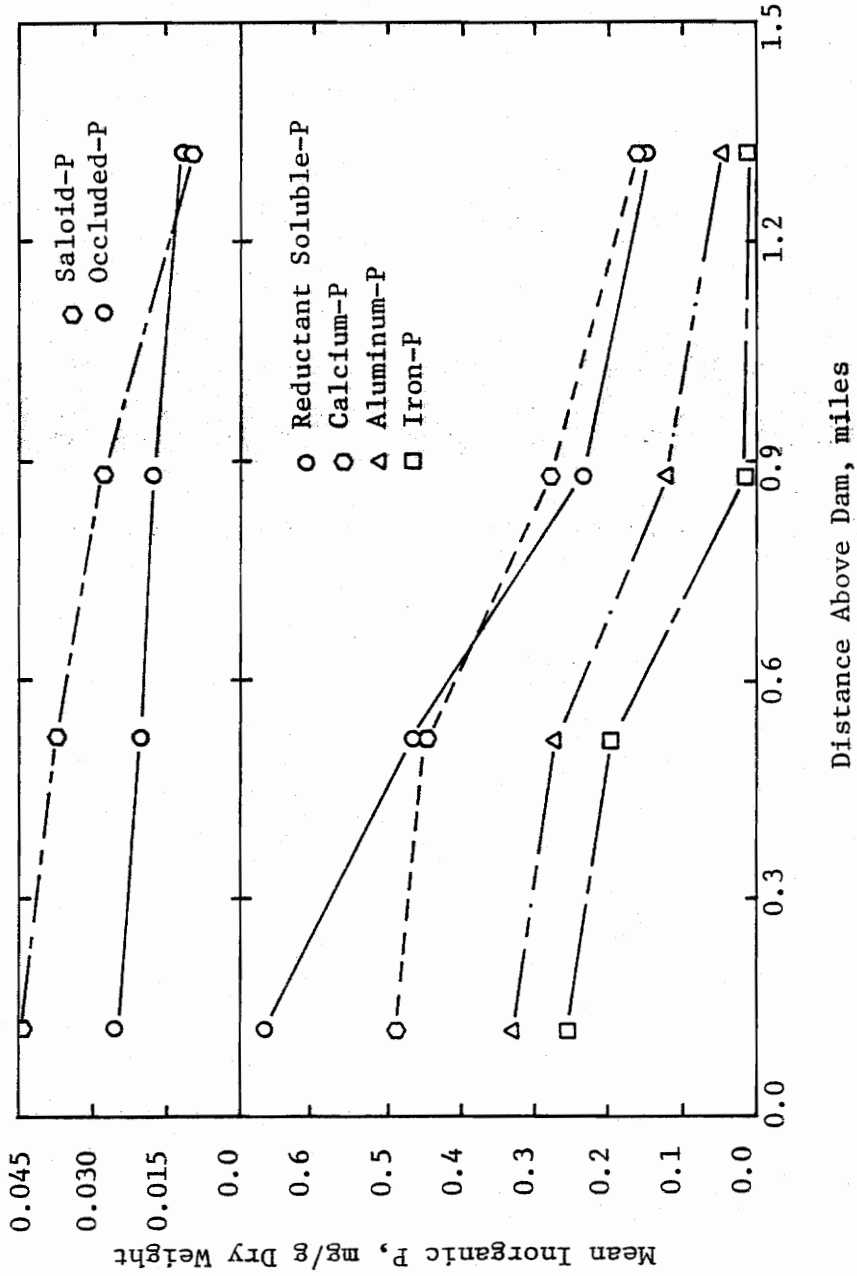

Figure 14. Variation in Sediment Inorganic Phosphorus with Distance Above Dam, 13 April 1973

TABLE V
 SURFICIAL SEDIMENT INORGANIC PHOSPHORUS
 FRACTIONATION - 13 APRIL, 1973

Fraction	Station Number			
	1	2	3	4
Saloid-P, mg/g	0.046	0.038	0.028	0.011
% of Total	2.5	2.6	4.0	2.9
Aluminum-P, mg/g	0.330	0.275	0.124	0.042
% of Total	18.2	18.9	17.6	11.1
Iron-P, mg/g	0.255	0.200	0.015	0.010
% of Total	14.0	13.7	2.1	2.6
Reductant Soluble-P, mg/g	0.670	0.470	0.239	0.145
% of Total	36.9	32.2	33.9	38.4
Occluded-P, mg/g	0.025	0.020	0.018	0.012
% of Total	1.4	1.4	2.6	3.2
Calcium-P, mg/g	0.492	0.454	0.280	0.158
% of Total	27.0	31.2	39.8	41.8
Total Inorganic-P, mg/g	1.818	1.457	0.704	0.378
% of Total	100.0	100.0	100.0	100.0

sediments from each station on a percentage basis. While the data in Figure 14 show a decline in each fraction concentration in an absolute sense, the percentage computations in Table V make it possible to examine the relative changes in phosphorus fractions at each station with respect to the total. The saloid, reductant soluble, and occluded sediment phosphorus fractions showed relatively little deviation from station to station on a percentage basis. The aluminum phosphorus fraction displayed a moderate decline in percentage of total from stations 1 to 4, dropping from 18.2 to 11.1 percent. The iron phosphorus fraction percentage, however, displayed a much larger decrease between the same stations, dropping from 14.0 to 2.6 percent. The observed absolute and relative decreases in iron and aluminum phosphorus fractions with distance upstream leads to the preliminary conclusion that the tailwater sediments are not likely to be as active in phosphorus exchange, because of the assumed importance of iron and aluminum in regulating phosphorus mobility.

Extractable Cations. Figure 15 shows the variation in sediment extractable aluminum and iron with distance above the Niagara Dam. Both cations displayed a decline in concentration with increasing distance upstream. The aluminum concentration drop between Stations 1 and 2 was considerably greater than that observed for iron, indicating that the aluminum tended to be more closely associated with the fines found in the Station 1 sediments. The extractable aluminum and iron concentrations dropped to 3.25 and 1.07 mg/g, respectively, at Station 4. The total cation concentrations were doubtless considerably higher, but the mild acid extraction employed does not disturb the internal struc-

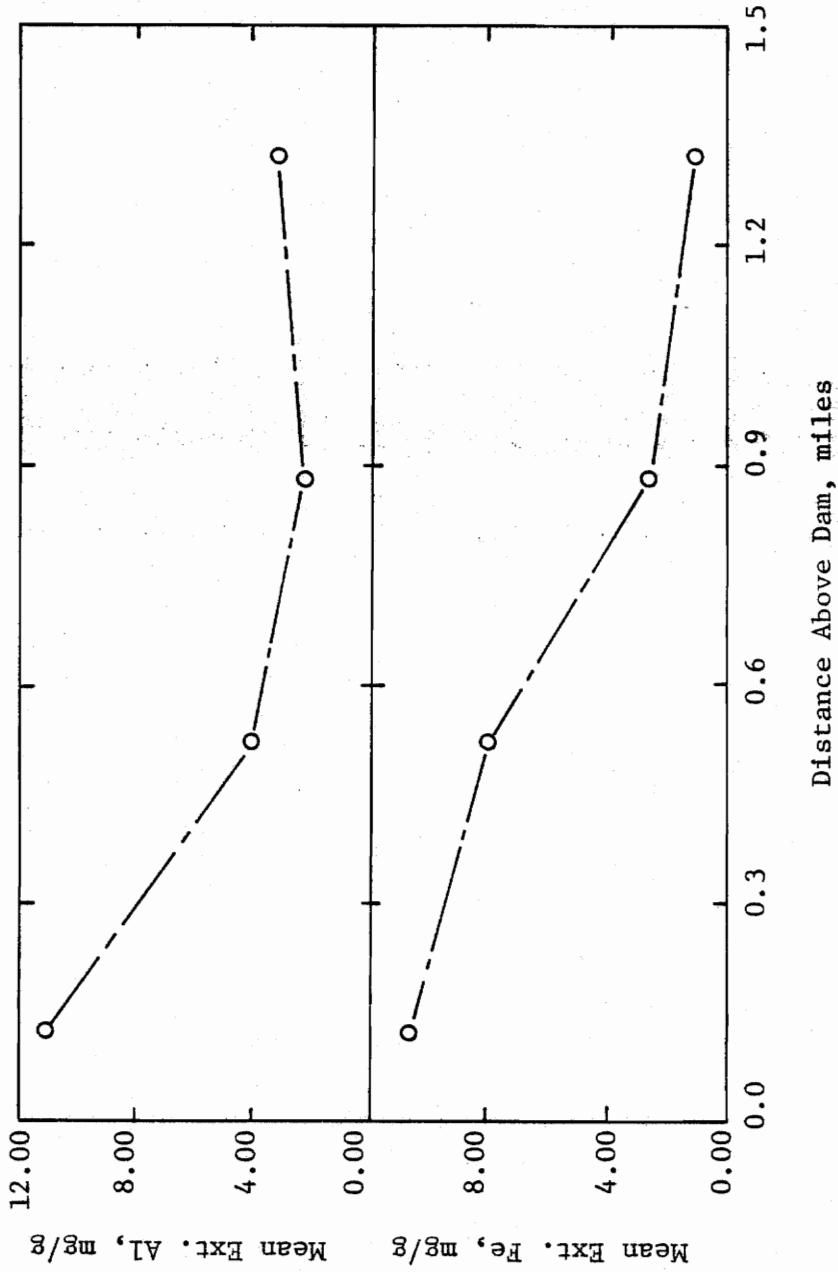

Figure 15. Variation in Sediment Extractable Metals with Distance Above Dam, 13 April 1973

ture of the minerals present, freeing only exchanged, adsorbed, or precipitated species.

Summary. In summary, it would appear that the organic sediments present in the vicinity of the dam would prove to be of more interest in the study of sediment-water interaction than the sandy, inorganic sediments from the tailwater areas of the impoundment. The sediments of Station 1 displayed values of total kjeldahl nitrogen, total inorganic phosphorus, extractable aluminum, extractable iron, and volatile solids that exceeded those of Station 4 by ratios of 7.05, 4.81, 3.40, 10.02, and 3.76, respectively. In addition, the finer material present in the organic sediments would likely afford more opportunity for physical-chemical interaction, based upon the greater surface area presented to the solution interface.

Surficial Sediments - Constituent Correlations

After observing the close correlation that several parameters exhibited with longitudinal position in the impoundment, it was decided to investigate inter-parameter correlations that might exist in the surficial sediments.

Volatile Solids Relationships. Figure 16 shows the relationship between sediment inorganic phosphorus and sediment volatile solids. The relationship observed was a positive one, displaying a coefficient of determination of 0.87, which indicated that a large part of the inorganic phosphorus variation could be explained by variation in sediment volatile solids. This observation prompted the scrutiny of the relationship, if any, between the sediment aluminum and iron phosphorus

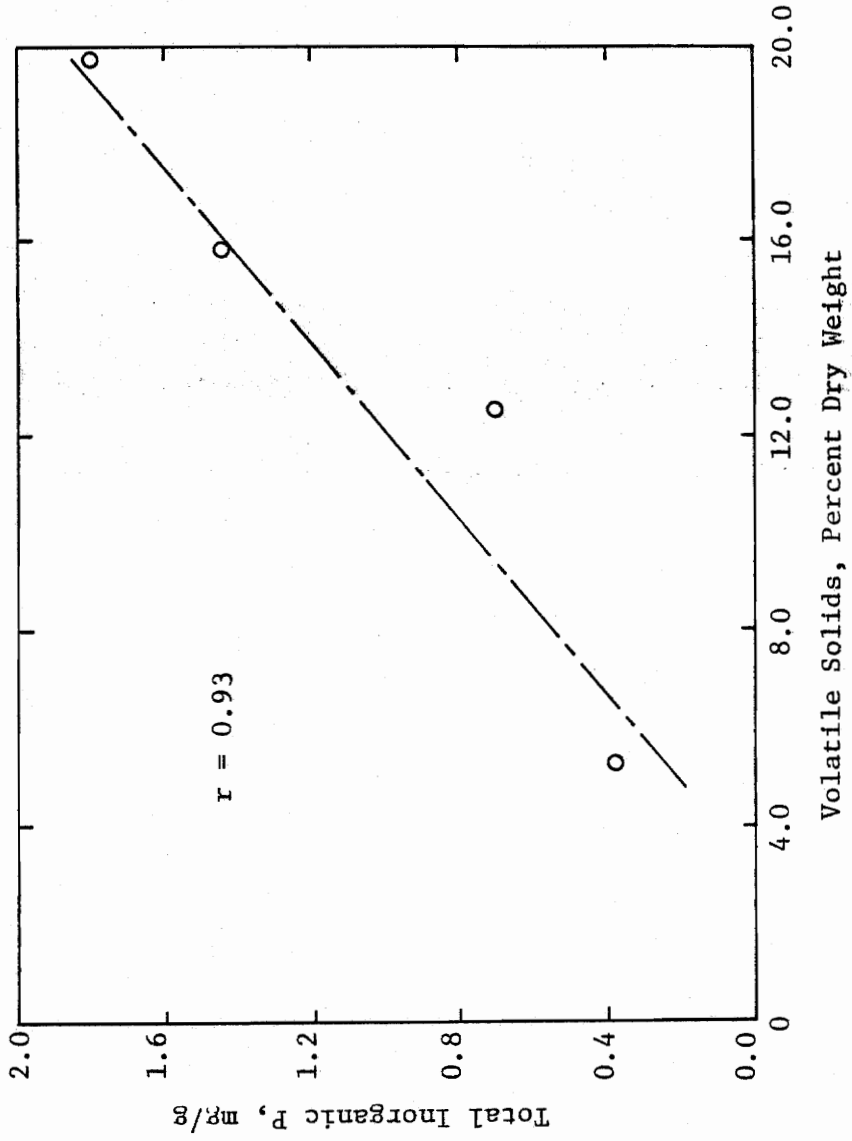

Figure 16. Variation of Total Inorganic Phosphorus with Sediment Volatile Solids, 13 April 1973

fractions and volatile solids. Figure 17 shows the relationship between aluminum-P, iron-P, and sediment volatile solids. The correlation is positive in both cases, but a linear regression analysis indicated that the fit was far better for aluminum-P ($r^2=0.92$) than for iron-P ($r^2=0.77$). This observation tends to support the conclusion of Harter (41) that the neutral ammonium fluoride extractant is the Chang-Jackson phosphorus fractionation (70) liberated organically bound phosphorus, rather than aluminum bound phosphorus, as supposed by the latter. Figure 18 shows the correlation between sediment extractable cations and volatile solids. The relationship for aluminum is tenuous at best, with a coefficient of determination of 0.52. These two observations tend to cast some doubt on the possibility that the so-called aluminum phosphorus fraction might be jointly related to both volatile solids and extractable aluminum, and they tend to confirm Harter (41). The relatively poor correlation between the iron-phosphorus fraction and volatile solids ($r^2=0.77$) seems to preclude the existence of a relationship similar to that observed for aluminum. It is apparent that the good correlation observed between total inorganic sediment phosphorus and sediment volatile solids observed earlier from the data plotted in Figure 16 is attributable to the influence of the "aluminum-phosphorus" fraction.

The investigation of the existence of a correlation between sediment nitrogen forms and volatile solids produced evidence of strong relationships, with both ammonia and TKN exhibiting coefficients of determination of 0.88 in linear regression analyses.

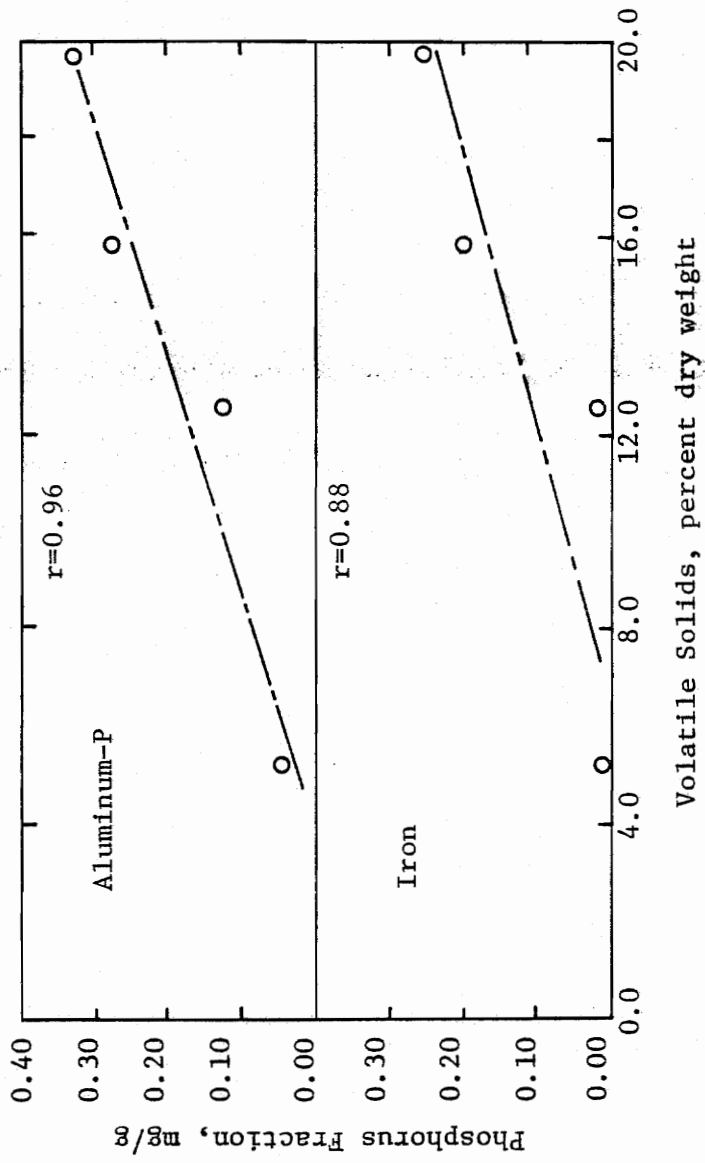

Figure 17. Variation of Iron and Aluminum Phosphorus Fractions with Sediment Volatile Solids

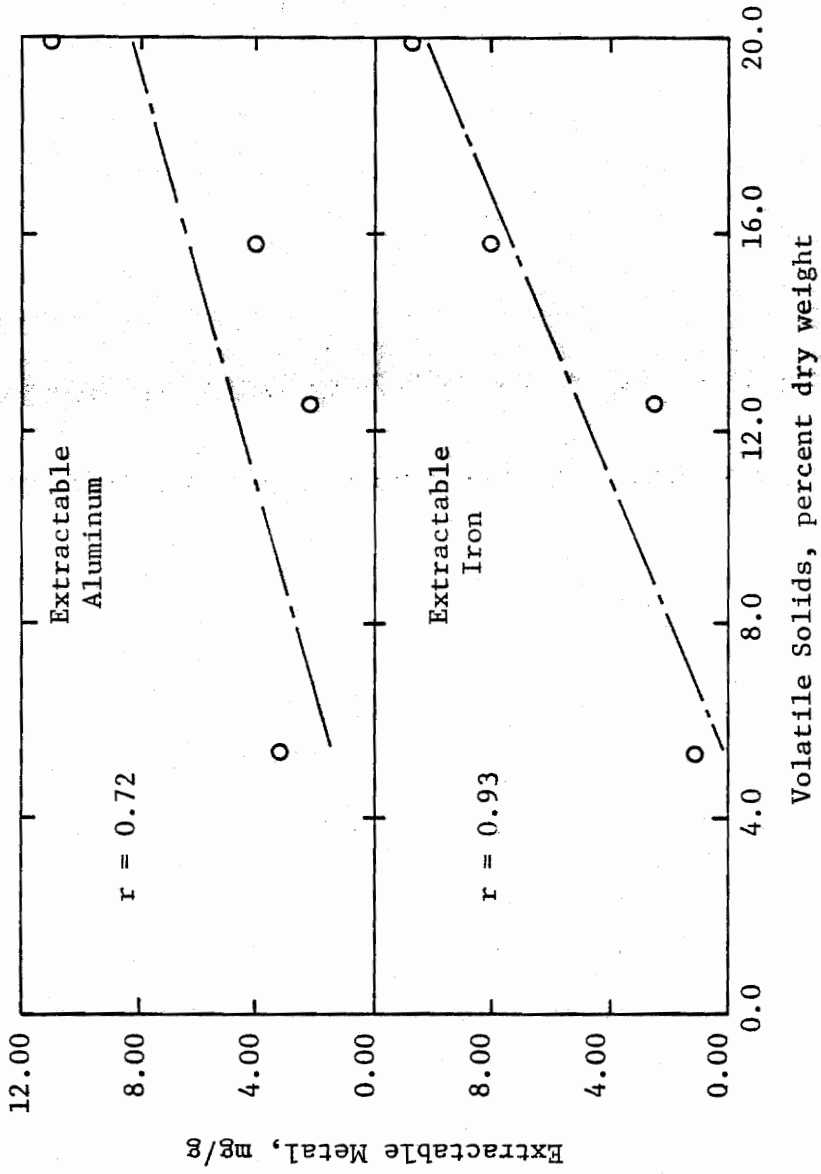

Figure 18. Variation of Extractable Metals with Sediment Volatile Solids

Extractable Metals Relationships. As stated earlier, excellent correlation was observed between the "aluminum-phosphorus" fraction and sediment volatile solids. At the same time, extractable aluminum exhibited a poor correlation with sediment volatile solids, prompting the speculation that Harter (41) may have been correct in his thesis that the aluminum bound phosphorus fraction might more correctly be termed organically bound phosphorus. The data plotted in Figure 19 are viewed as confirming Harter's hypothesis for Niagara sediments. A coefficient of determination of 0.56 was observed in the aluminum phosphorus-extractable aluminum linear regression analysis, indicating a weak relationship. Both the iron phosphorus and reductant soluble iron phosphorus fractions were found to correlate well with extractable iron, indicating that the Chang-Jackson fractionation (70) provides adequate operational definitions of both. The operational definition of the fraction extracted by neutral ammonium fluoride should properly be changed to conform with the performance of the analysis, but, for the remainder of this work, the aluminum phosphorus terminology will be retained to assure consistency with the existing literature.

Surficial Sediments - Temporal Characterization

Seasonal changes in the character of surficial sediments of the Niagara Impoundment were observed through the analysis of sample sets collected according to the schedule in Table II. On each visit to the impoundment, several dredge loads of sample were collected at each station, composited and mixed on-site, in order to avoid the problems associated with attempting to sample at precisely the same bottom location each time.

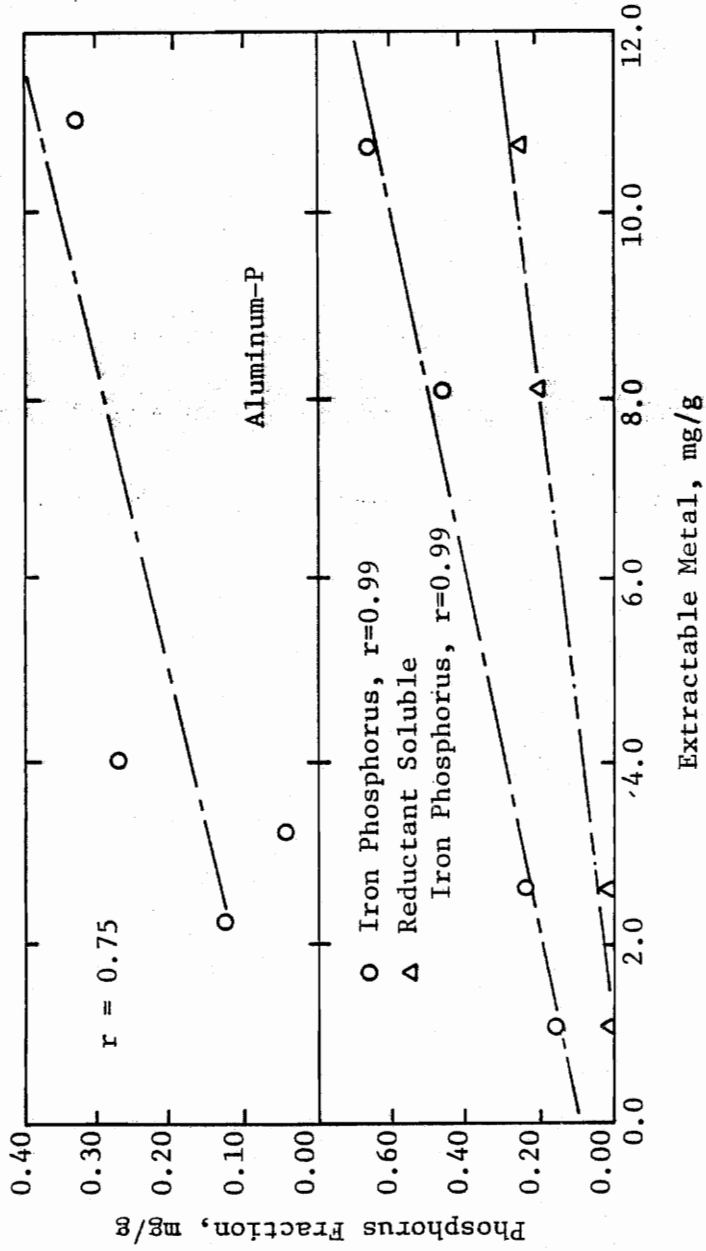

Figure 19. Variation of Inorganic Phosphorus Fraction with Extractable Metal Content, 13 April 1973

Inorganic Phosphorus. The seasonal changes in surficial sediment phosphorus fractions from March 1973 to June 1974 are shown in Figures 20, 21, and 22.

In Figure 20, the changes in the iron and aluminum fractions may be observed. Beginning with the onset of warm weather, the aluminum phosphorus fraction displayed a gradual decline at all stations, reaching a minimum concentration near the end of July, 1973. Following that, a gradual rise was observed which culminated in a set of high values in spring, 1974. The period of minimum sediment Al-P coincides with the period of reducing conditions in the impoundment bottom waters. The reduction of aluminum does not occur, in the range of neutral pH and moderate temperature until a potential of -1662 mv is reached (83), a far stronger reducing environment than is typically experienced in aquatic systems. It is apparent, then, that the liberation of sediment Al-P is not caused by the destruction of sorbate species composed of hydrous aluminum oxides. This is in agreement with the earlier conclusion that the Al-P analysis does not even liberate sediment phosphorus which is bound to aluminum but rather that which is attached to sediment organic matter. In view of the decline observed, it seems likely that the liberation is caused by the accelerated destruction of benthic organic matter brought on by the warmer temperatures of the summer months. This hypothesis is supported by the observation that those sediments containing relatively little volatile matter (Stations 3 and 4) showed less change in the Al-P fraction.

The iron phosphorus fractions, by contrast, displayed a relatively rapid decline which reached a general minimum near the beginning of

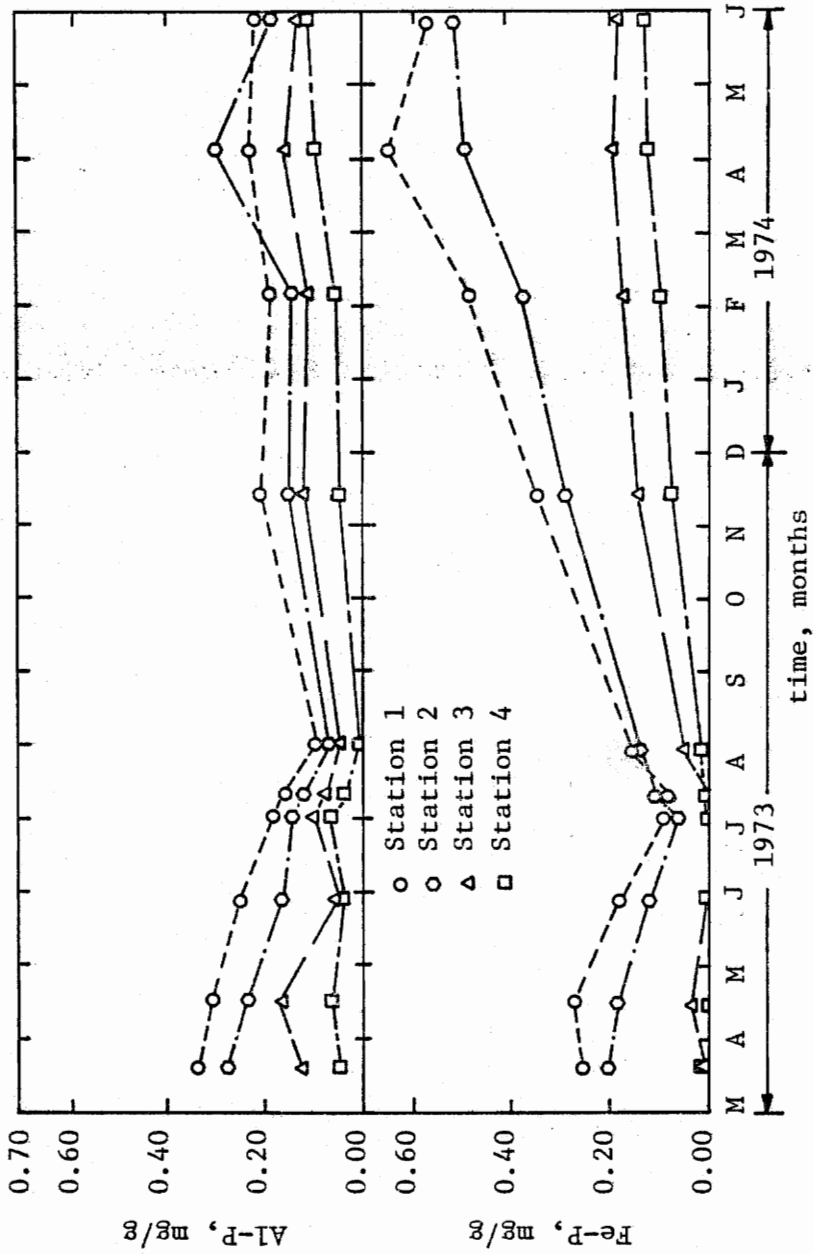

Figure 20. Temporal Variation in Surficial Sediment Aluminum and Iron Phosphorus Fractions

July, 1973. Mortimer (39) has reported that the reduction of ferric oxides begins at an E_7 of approximately 300 mv. The destruction of discrete ferric phosphates and hydrous iron oxides with adsorbed phosphates would account for the early decline in sediment iron phosphorus. The data for the liberation of sediment reductant soluble iron phosphorus are shown in Figure 21, and indicate that the minimum was generally reached at the end of July. The destruction of parent compounds consistency of iron oxides, and the subsequent liberation of internally occluded phosphates probably required a more negative ORP than had been reached at the beginning of the month.

The lower portions of Figure 21 and the first part of Figure 22 show, respectively, the temporal variation in surficial sediment calcium and occluded phosphorus at all stations. As may be seen, there is little seasonal change indicated in either fraction at any station during the fifteen month period. It is not likely, therefore, that either fraction represents a viable sink or source for phosphorus exchange reactions. The potential required for the reduction of calcium is even more severe than that for aluminum and would not be expected to occur in a natural system, therefore rendering both phosphorus fractions essentially immobile.

The lower part of Figure 22 shows a slight increase in the saloid-P fraction at all locations but Station 4 during the summer months. It is likely that phosphorus liberated from the other fractions becomes loosely bound in the interstitial waters of the interface and subsequently appears in the saloid-P analysis, accounting for the slight summer month increase.

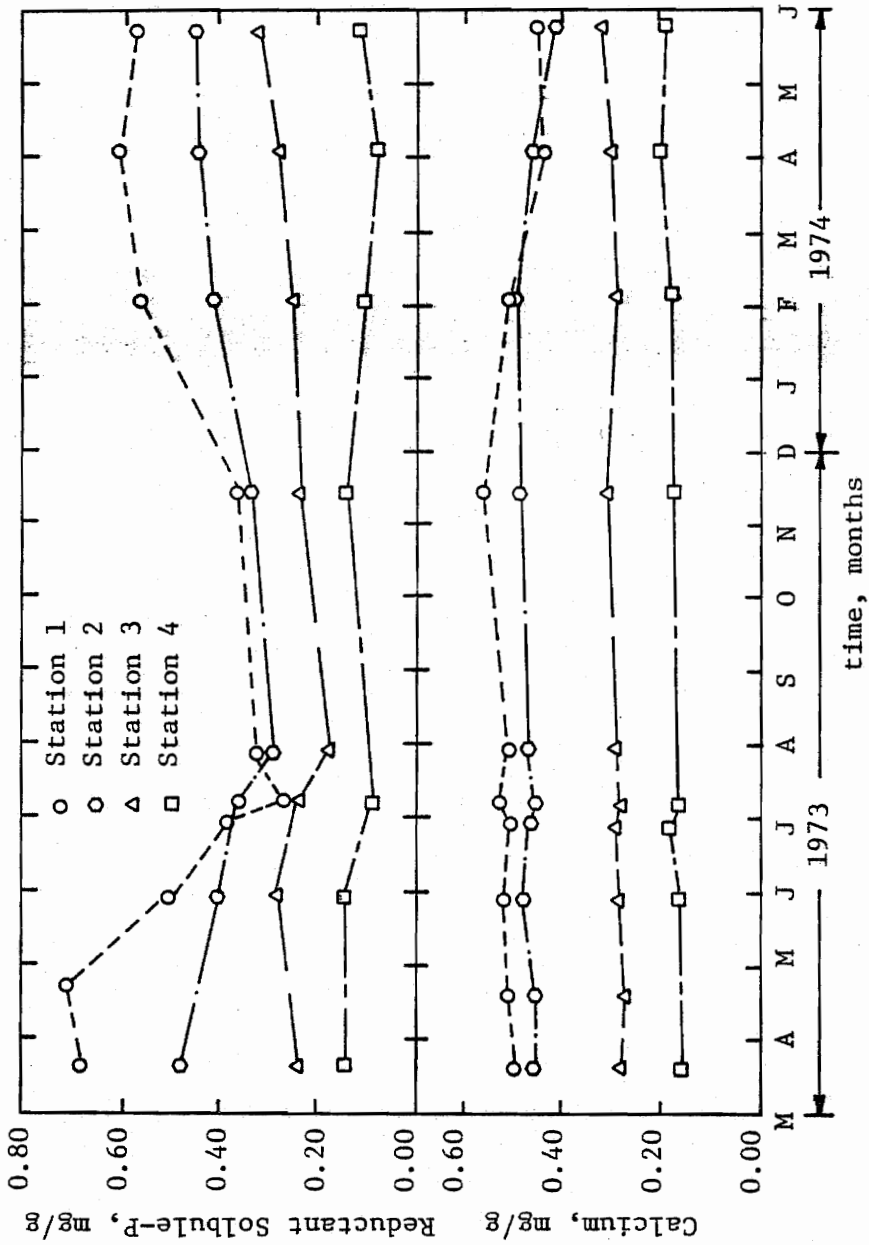

Figure 21. Temporal Variation in Surficial Sediment Reductant Soluble and Calcium Phosphorus

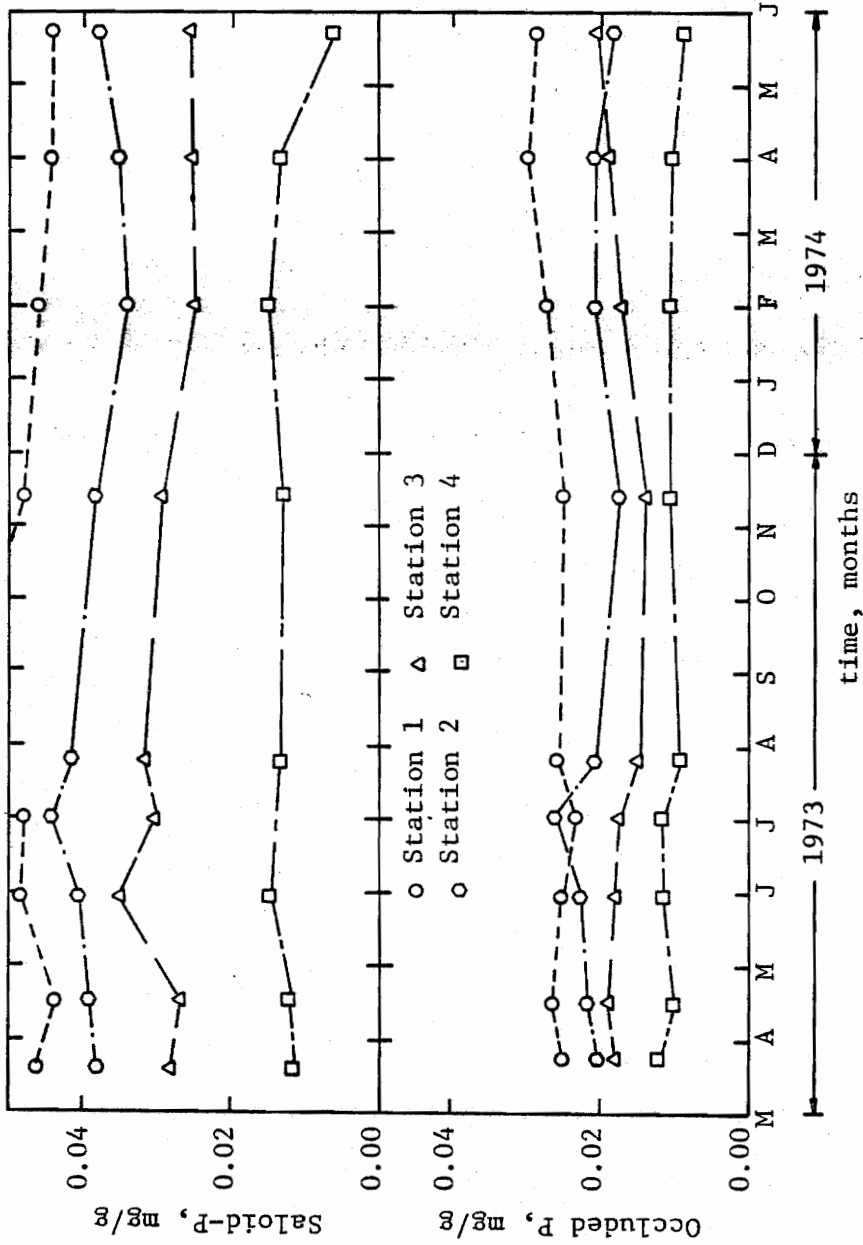
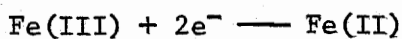

Figure 22. Temporal Variation in Surficial Sediment Saloid and Occluded Phosphorus Fractions

Extractable Cations. Figure 23 provides additional evidence of the absence of any control of phosphorus exchange being exerted by aluminum oxides. While they doubtless do have the capacity to remove added phosphorus from solution, the stability of such compounds through a wide range of ORP appears to make the removal all but irreversible. The lack of a quantitative method for determining aluminum bound phosphorus also hampers observations of possible exchanges. In any case, the absence of any appreciable seasonal variation in sediment extractable aluminum tends to confirm the proposed lack of interaction in exchange processes.

In the lower part of Figure 23, a considerable drop in sediment extractable iron may be seen to occur at Stations 1, 2, and 3 in the summer months of 1973. This coincides with the decreases previously noted in the iron and reductant soluble iron phosphorus fractions, as shown in Figures 20 and 21. The rise in extractable iron which may be seen to occur in the winter of 1974 illustrates the cyclic nature of the response of the iron system to changes in the oxidation state of the surficial sediments. The onset of reducing conditions in the summer months causes the couple in the following reaction to shift to the right:



The reduced form, Fe(II), is insoluble in the pH range encountered in most natural systems, and when produced, causes the liberation of associated cations along with any adsorbed species.

Nitrogen. Figure 24 shows the variations in surficial sediment nitrogen forms through the period of the study. The seasonal changes

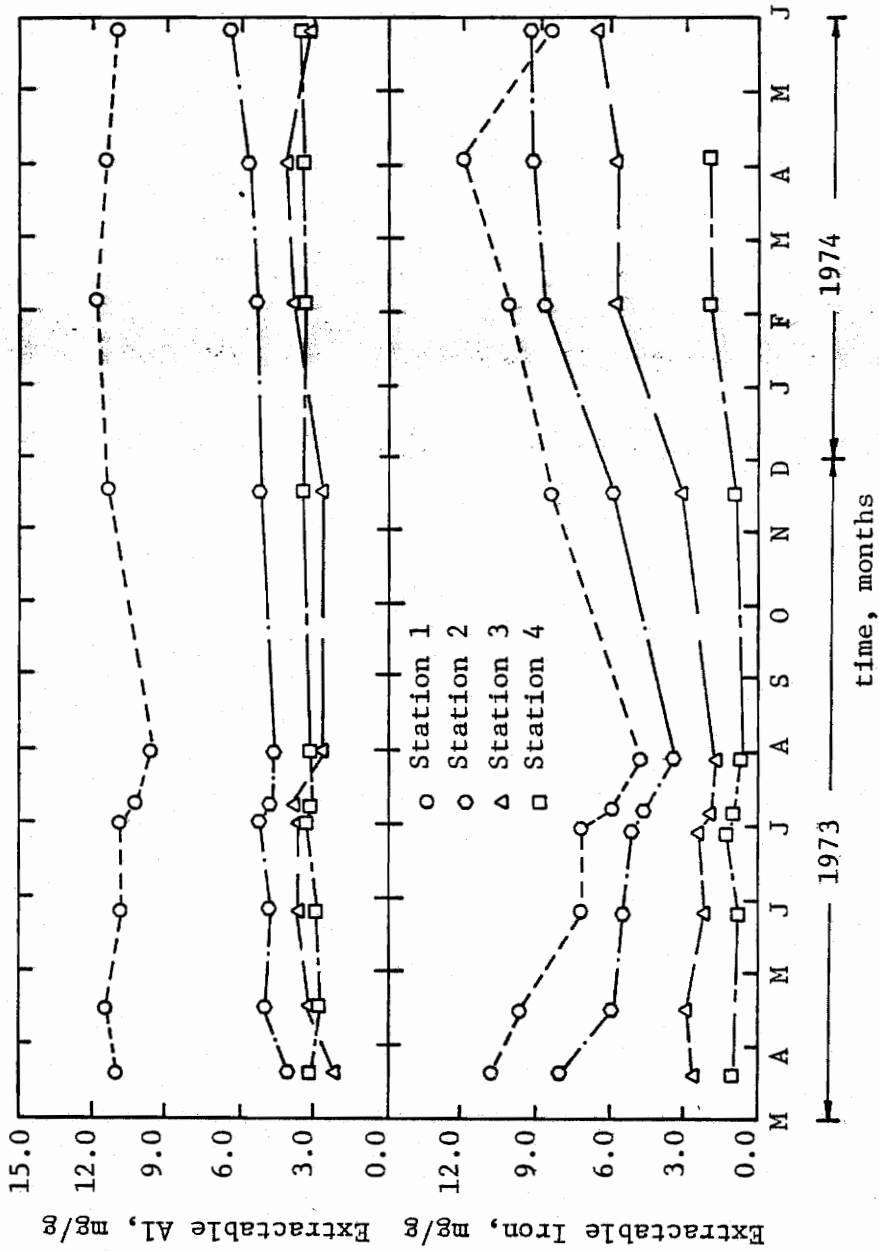

Figure 23. Temporal Variation in Surficial Sediment Cation Concentration

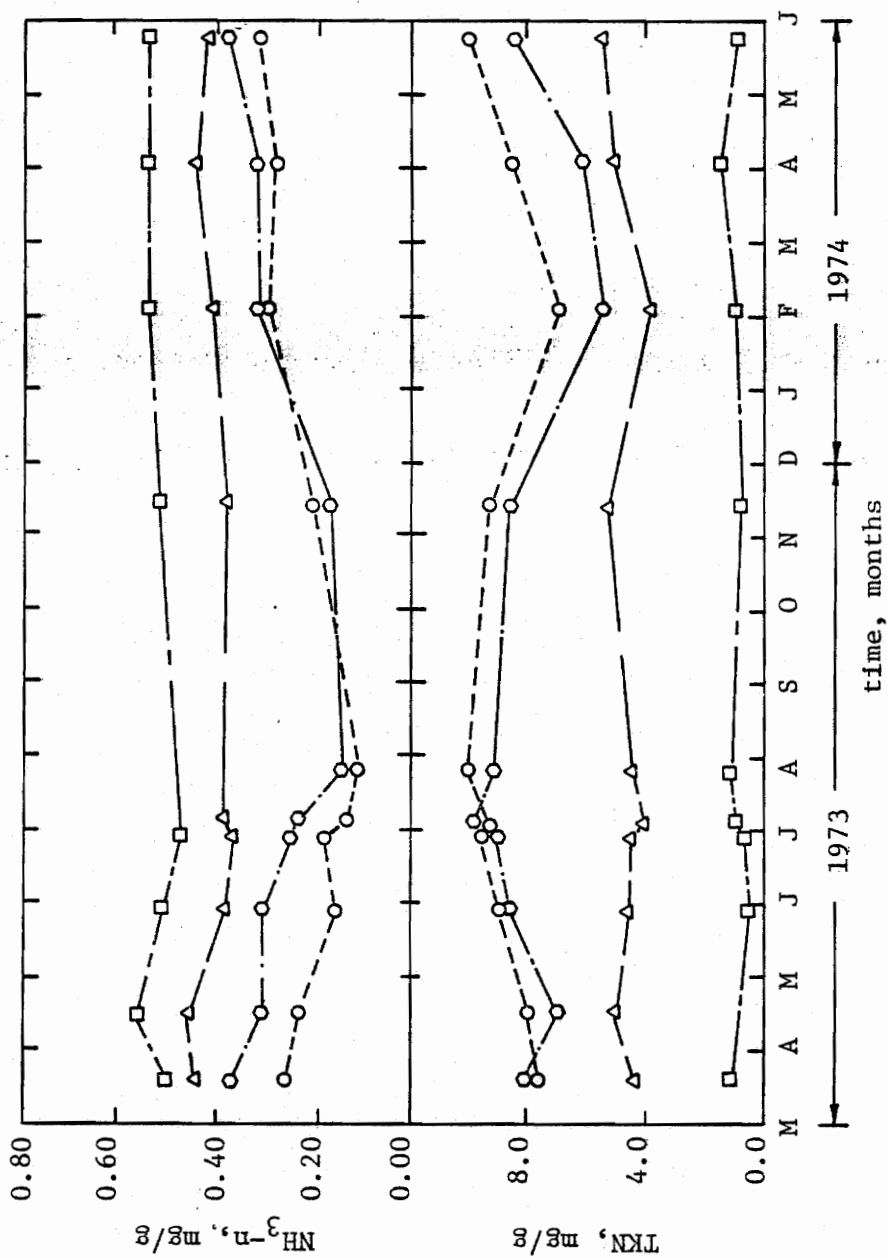

Figure 24. Temporal Variations in Surficial Sediment Nitrogen Forms

in ammonia nitrogen are presented in the upper part of the figure. As may be seen, the sediments of Stations 1 and 2 were considerably more active with respect to ammonia change. The sediment ammonia concentration dropped considerably during the summer months, indicating that an exchange was taking place with the water column. Mortimer (39) noticed this phenomenon in Esthwaite water, but was not able to account for its occurrence. The likely explanation is that reduced cations, principally iron, which are liberated during anoxic conditions at the interface subsequently replaced adsorbed ammonium species on the sediments in a cation exchange reaction. The sediments of Stations 3 and 4 exhibited very little change through the course of the study, even though the concentrations always remained higher than those at Stations 1 and 2. This is probably due to the relative absence of cation exchange activity at the upper stations based upon the sandy nature of the sediments and lack of reduceable iron compounds.

The lower part of Figure 24 shows the seasonal changes in total kjeldahl nitrogen at all stations. The sediments from Stations 1 and 2, which contain more volatile matter also contain considerably more TKN than those from Stations 3 and 4. The lower reservoir stations also exhibited a greater fluctuation in TKN, with a considerable rise in the summer months. This is to be expected, because the anoxic conditions that persist during the summer preclude aerobic respiration, and allow organic detritus to accumulate in the benthos.

Sediment Characterization - Vertical Stratigraphy

Sediment cores were retrieved at all stations on July 7, 1973. The vertical variations in all constituents measured are shown in Figures 25 through 35. The cores varied in length from 80 to 120 cm, the shorter lengths being retrieved from the upper end of the impoundment where the granular material make it more difficult to achieve penetration of the corer into the sediment profile.

Volatile Solids. Figure 25 shows that, while the previously observed decrease in sediment volatile solids with distance above the dam was reflected in the core analyses, the vertical gradation at all sites was only slightly less pronounced. The general trend in volatile solids percentage, except at Station 4, was a gradual decline from the surface value at all stations. Isolated peaks of increased percentage were observed, but the general declining held trend. The percentage at Station 4 remained more constant with depth, probably due to the predominantly granular nature of the material at that site. The decline in volatile solids percentage with depth observed at the other stations indicates that the lower sediments have achieved a slightly more stable condition with respect to the decomposition of organic material. The net volatile solids percentage remained high, however, throughout the core profile at Stations 1 and 2, confirming that the entire 120 cm depth, and likely more, is dominated by organic material, high in nutrients.

Phosphorus. The retrieved core samples were fractionated by the Chang-Jackson procedure (70) to produce the inorganic phosphorus profiles found in Figures 26 through 31. Data on the individual fractions

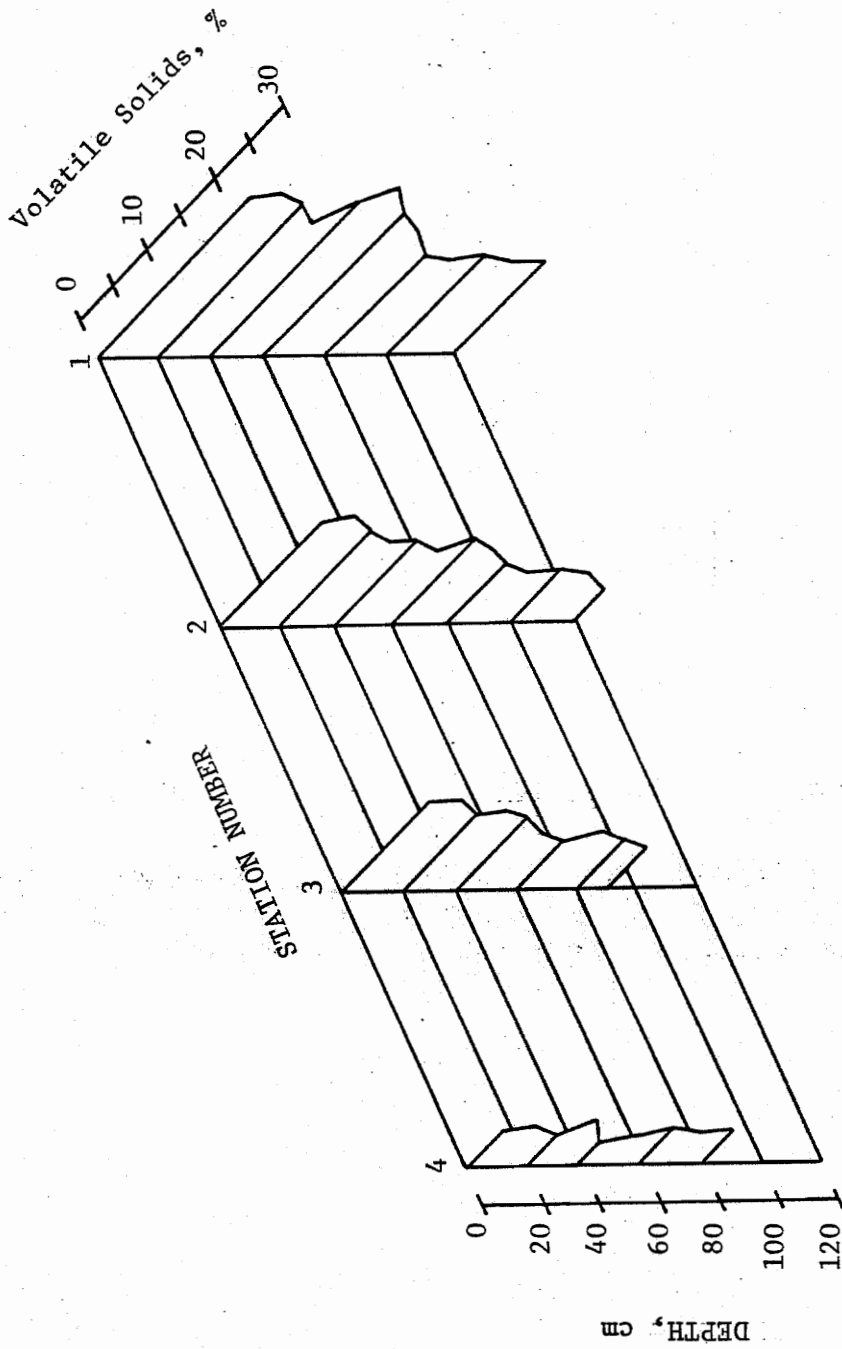

FIGURE 25. Vertical Gradation of Sediment Volatile Solids

is presented in the illustrations in the same order observed in the analytical procedure.

Vertical gradation of saloid-P is shown in Figure 26. A concentration decline with depth may be observed at each station. This is as would be expected, because saloid phosphorus is the most mobile of all the sediment inorganic forms, being only loosely adsorbed or present in the interstitial water of the sediment matrix. It is likely, then, that this form responds rapidly to a concentration gradient towards the water column whenever one exists. In addition, the high mobility of the form makes it likely that some migration occurs in the sediment profile towards the interface with the water column. As may be seen, however, the relatively small quantities present in the saloid-P fraction (<0.03 mg/g) make it unlikely that the fraction is of any critical water quality significance in view of the higher phosphorus concentrations present in other forms.

The vertical gradation of aluminum-P at each station is shown in Figure 27. The general concentration trend from the mud-water interface into the sediment is again negative, but there is a great deal of variation between the individual samples. As has been noted previously, the aluminum-P fraction did not correlate well with the aluminum found in sediment extracts, but, did, however, with the volatile solids percentage. This led to the preliminary conclusion that the aluminum fraction in the surficial sediments was more closely related to organic matter than extractable aluminum. Examination of Figures 25 and 27 tends to confirm this as a general conclusion for all the sediments of the Niagara Reservoir, because a similarity may be observed between the

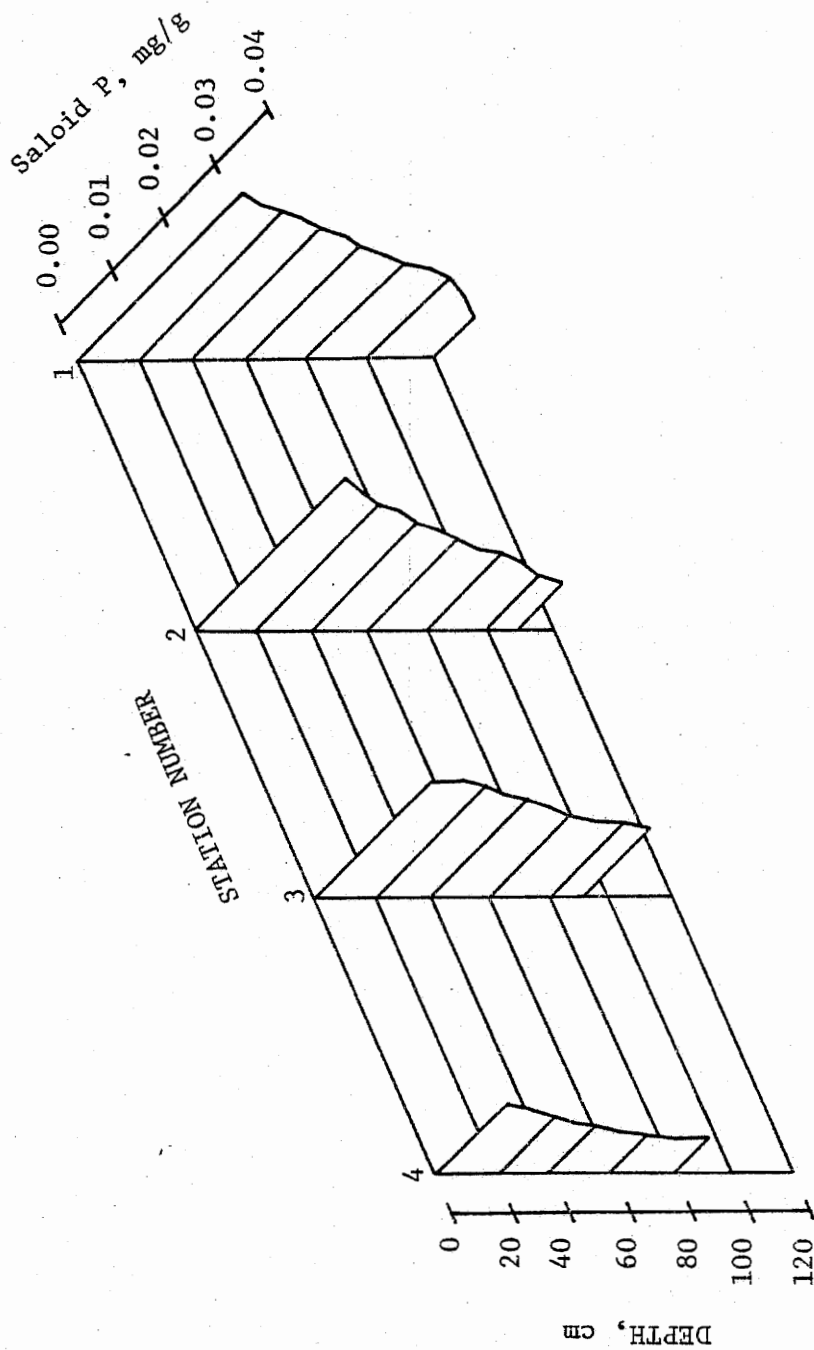

FIGURE 26. Vertical Griddation of Saloid-P (7 July, 1973)

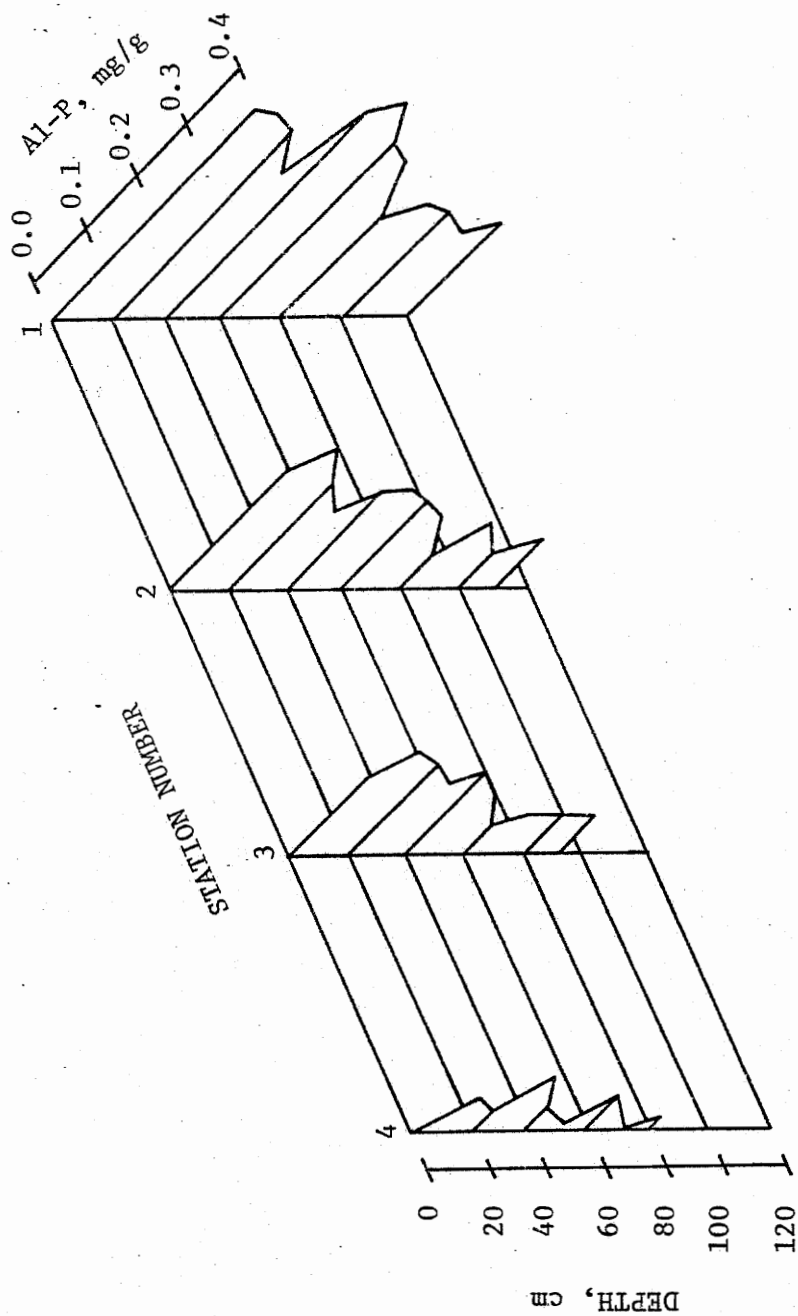

FIGURE 27. Vertical Gradation of Aluminum Phosphorus (7 July, 1973)

volatile solids and aluminum-P profiles at all four stations. Subjecting the individual observations to a linear regression analysis, with the volatile solid percentage as the independent variable, revealed a strong correlation ($r^2=0.98$). With a sample size of 45 observations (3 replicates of each), it may be proposed that the resulting regression equation is a fair representation of the relationship between the two variables:

$$\text{Al-P} = -0.06 + 0.020 (\% \text{ VS}) \quad [1]$$

where: Al-P=aluminum phosphorus, mg/g
% VS=percent volatile solids, %

This relationship is not proposed in the belief that the phosphorus fraction liberated by neutral NH_4F is an organic fraction, but rather that it is an inorganic fraction bound in some way to the sediment organic matter. The relative mobility of the fraction in the NH_4F solvent supports the conclusion that it is an inorganic form, and the likely availability of active surface sites on the organic matter suggests that the attachment may be a chemisorption phenomenon. This would help to explain the relative stability of the aluminum-P fraction observed in the surficial sediments during the course of the study. The data in Figure 28 are the vertical gradation of extractable aluminum in the sediments of the four impoundment stations. As may be seen by comparison with the data of Figure 27, the variation does not match well with that of the Al-P fraction. This conclusion is borne out by the relatively low coefficient of determination ($r^2=0.63$) of a linear regression analysis of the two variables. The extractable aluminum content of the sediment profile is highly variable, but does appear to

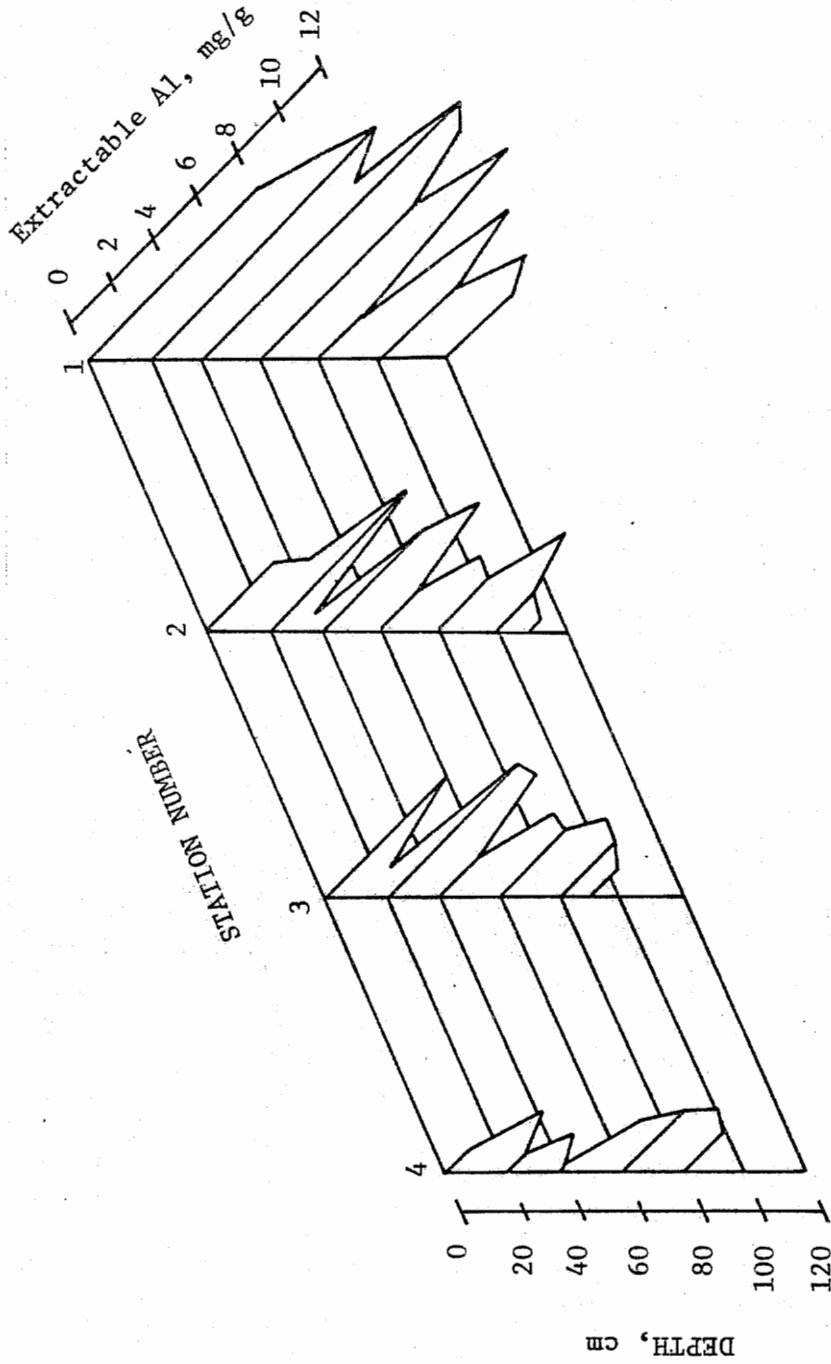

FIGURE 28. Vertical Gradation of Sediment Extractable Aluminum (7 July, 1973)

decline slightly with depth.

The sediment iron-P profile is shown in Figure 29. The Fe-P concentration reached a peak at a sediment depth of 70 cm at Station 1, 50 cm at Station 2, 70 cm at Station 3, and 60 cm at Station 4. These trends towards a peak at some lower depth in the sediment indicate a change in the chemical quality of the deposited sediment at some point in the history of the impoundment. While a general rising or declining concentration trend with depth may just indicate the presence or absence of mobility to upper layers, a mid-depth peak supported by a trend towards it from above and below, definitely indicates a change in the historical quality of sediment. This same general trend is observed with extractable iron in the sediment profile, as shown in Figure 30, and with reductant soluble iron-P, as shown in Figure 31. The high degree of correlation between the phosphorus variables and extractable iron is illustrated in Table VI, which shows the linear regression parameters between each pair. In addition, Table VI shows the relationship between the two iron phosphorus forms, which, although each is closely related independently to extractable iron, do not correlate as well with each other. Based on the large sample size (45 observations X 3 replicates) it may be safely concluded that the iron-phosphorus and the less-mobile reductant soluble iron phosphorus fractions are both highly dependent upon the presence of iron species to bind them to the sediment structure. The very low interfacial concentrations of both iron forms is probably due to the highly reduced condition of the surficial sediments at the time of retrieval. It should also be noted that a considerable iron phosphorus reservoir exists in the sediment profile,

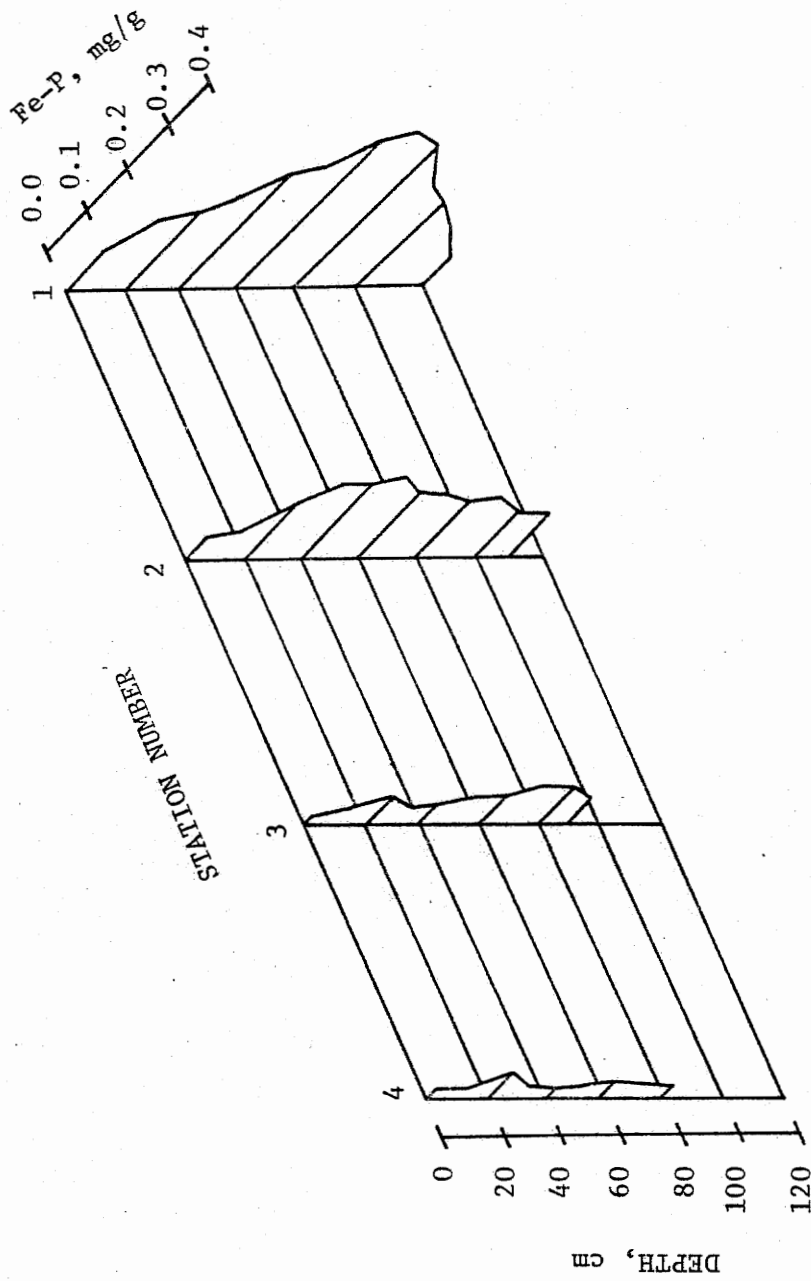

FIGURE 29. Vertical Gradation of Iron Phosphorus (7 July, 1973)

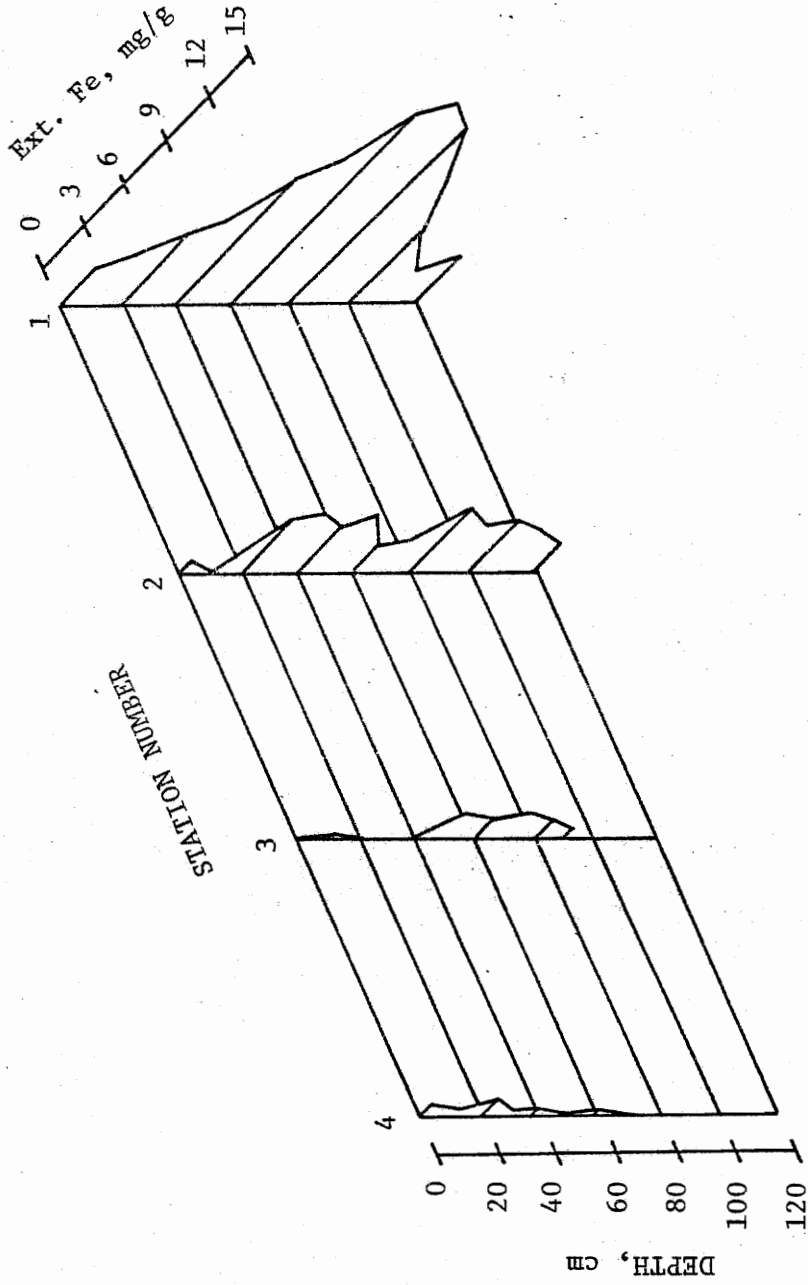

FIGURE 30. Vertical Gradation of Sediment Extractable Iron

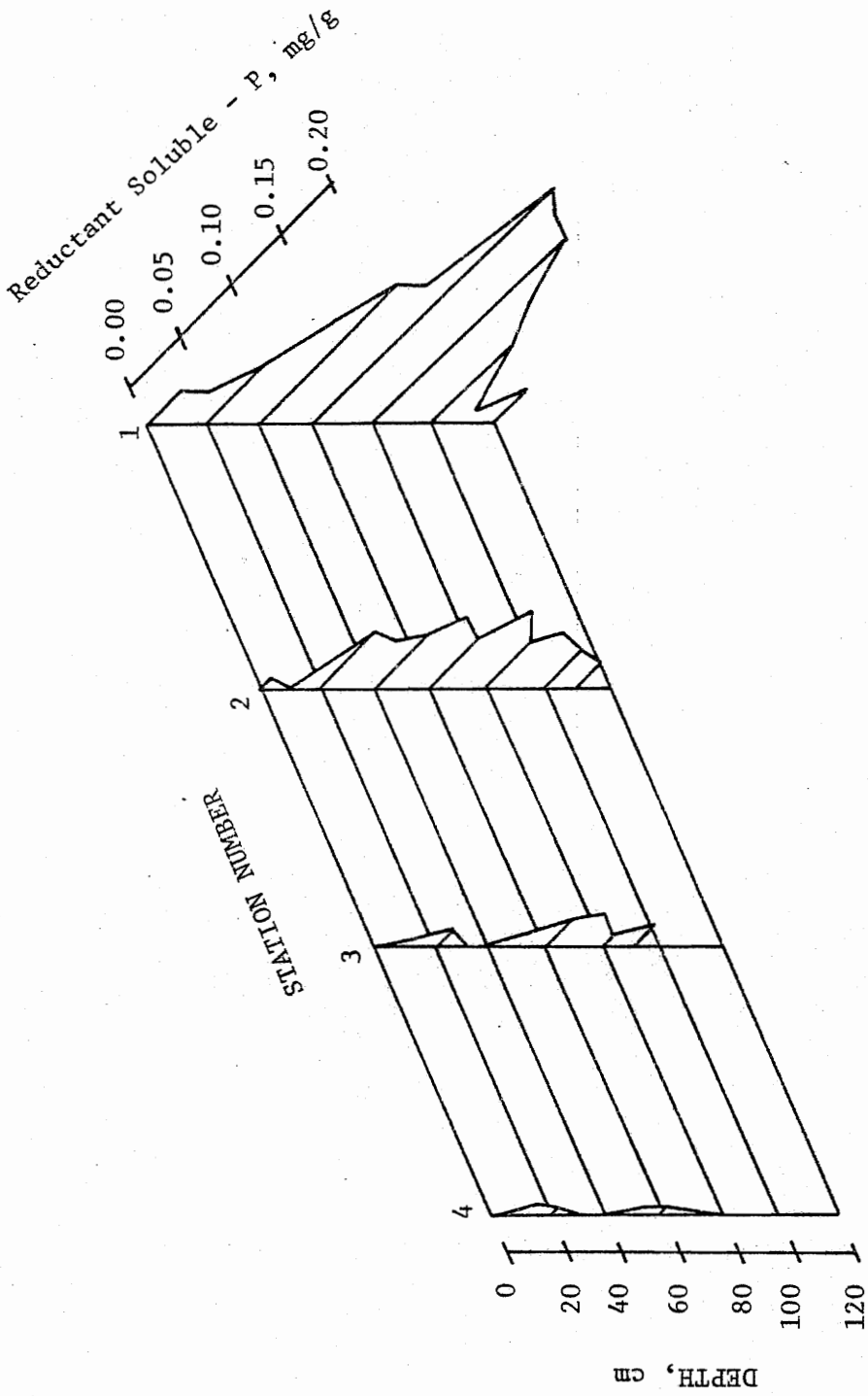

FIGURE 31. Vertical Gradation of Reductant Soluble - P

TABLE VI

Extractable Iron and Iron Phosphorus
Regression Parameters

<u>Dependent Variable</u>	<u>Independent Variable</u>	<u>a</u>	<u>b</u>	<u>r²</u>	<u>n</u>
Fe-P, mg/g	Ext. Fe, mg/g	0.04	0.025	0.97	45
R.S.-P, mg/g	Ext. Fe, mg/g	-0.004	0.016	0.97	45
Fe-P, mg/g	R.S.-P, mg/g	0.047	1.557	0.92	45

and that sufficient disturbance of the deposited mass could bring it into contact with the water column where the bound phosphorus could be mobilized.

As noted in the literature review, occluded phosphorus is the Chang-Jackson (70) procedure consists of iron and aluminum phosphorus bound within stable iron oxides. The data in Figure 32 show that there has been little change in this fraction in the sediment profile at all four stations. The sediment phosphorus in the occluded form is probably present as a result of the erosion and transport of upstream soils into the impoundment. The protective iron oxide coating renders the occluded phosphorus especially immobile, and as a result, no significant change would be expected in the deposited sediments, unless there was an accompanying change in the type of eroded soil entering the impoundment.

This same observation applies to the sediment profiles of calcium-P, which are shown in Figure 33. As noted earlier, the compounds of calcium which bind inorganic phosphorus, such as hydroxy-apatite, are especially stable, and would not be expected to allow solubilization of the attached phosphorus forms. Because such calcium components of the sediments also generally originate from upstream soil erosion, it is not surprising that the calcium fraction in the sediment profile shows little variation at all stations, beyond the longitudinal gradation provided by differential particle settling velocities.

Nitrogen. Ammonia nitrogen in the sediment profile at each station is shown in Figure 34. As may be seen, the concentration is relatively constant with depth, and generally, between stations, bears on direct

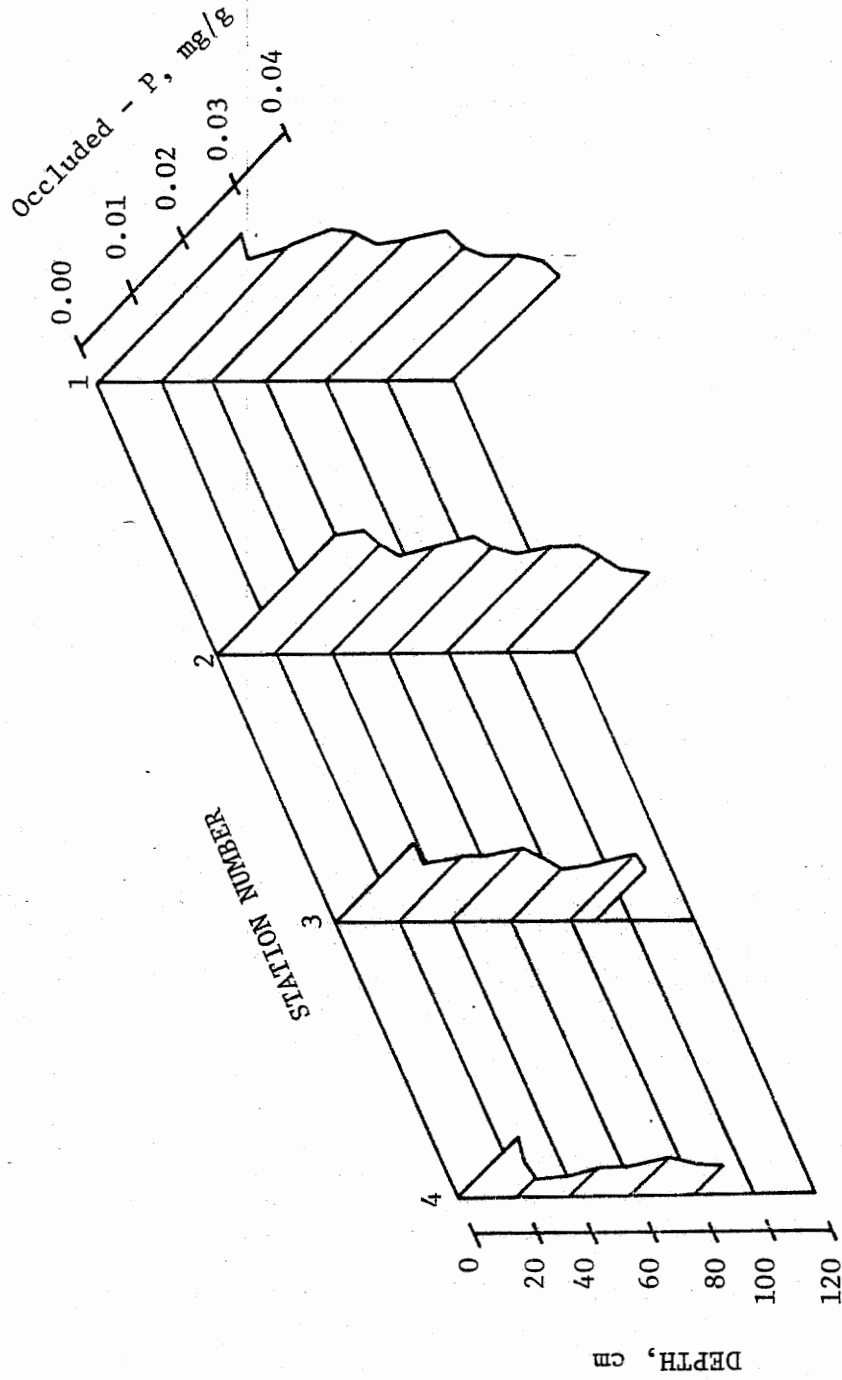

FIGURE 32. Vertical Gradation of Occluded Phosphorus

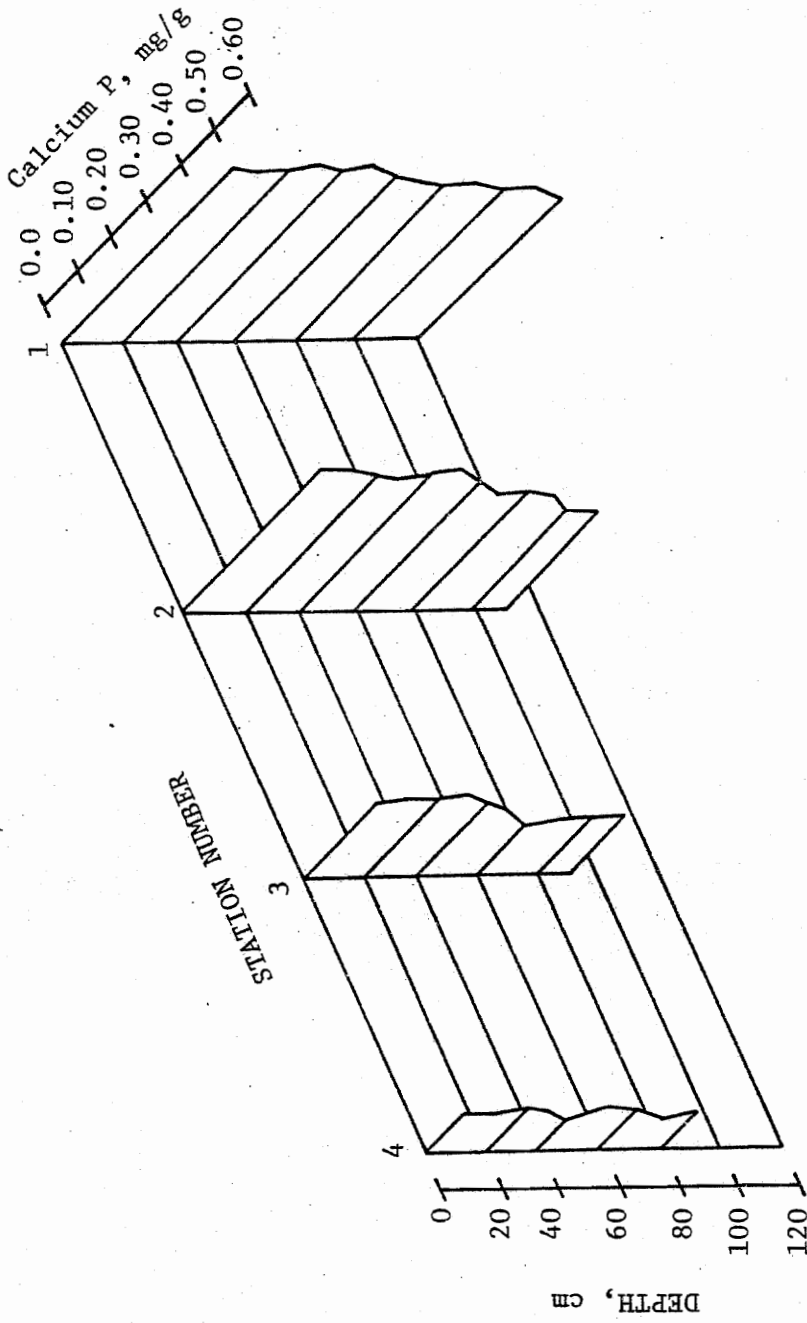

FIGURE 33. Vertical Gradation of Calcium - P

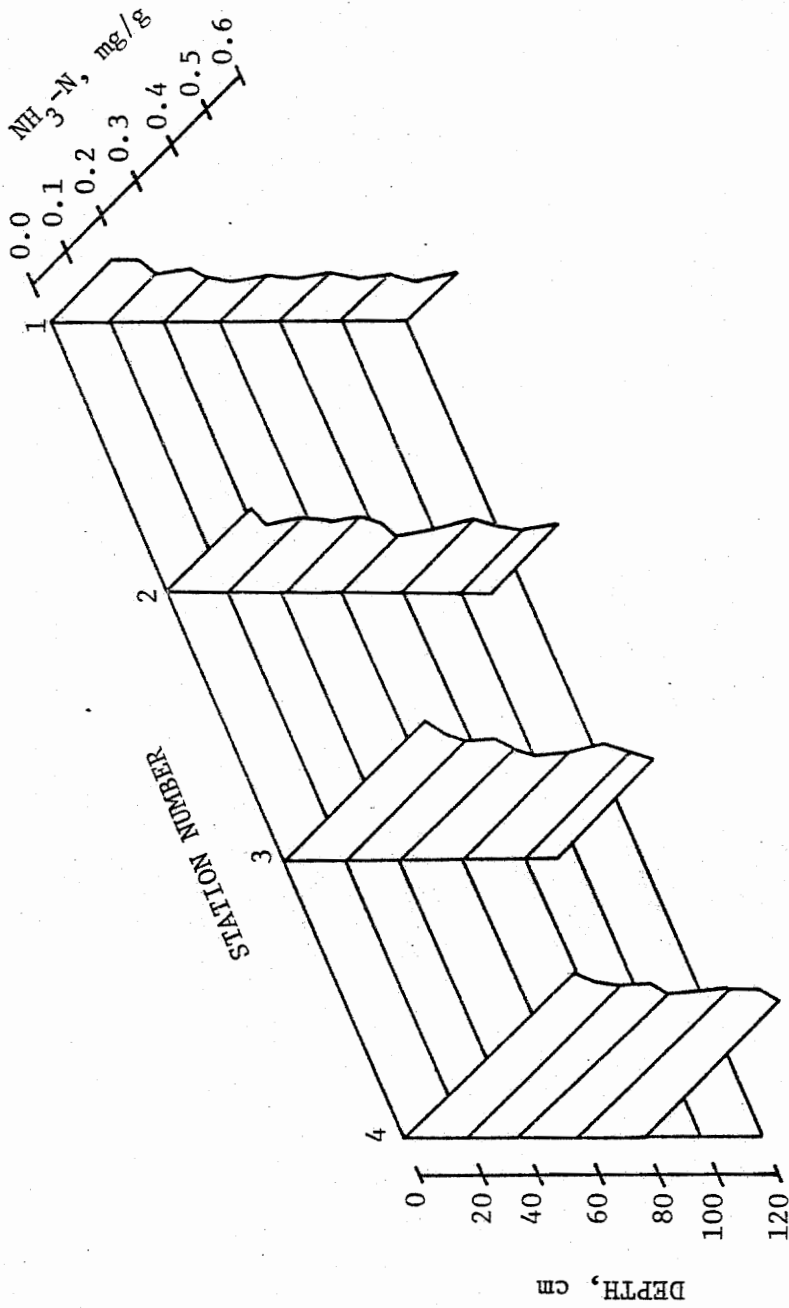

FIGURE 34. Vertical Gradation of Sediment Ammonia Nitrogen

relationship with distance above the dam - an observation noted earlier in the surficial sediment discussion. The TKN profiles, shown in Figure 35, were observed to decline with depth at each station. This is likely a reflection of the dominance of the organic nitrogen fraction in TKN, and the decline is probably a reflection of the degree of stabilization of organic matter with sediment depth. Upon inspection of Figure 25, it may be seen that a similar decline was observed to occur in the volatile solids profile. The relationship between volatile solids and sediment organic nitrogen was inspected by performing a regression analysis on the corresponding data for the two variables. As may be seen in the following equation, a fairly good relationship was observed to exist:

$$\text{Org.-N} = 0.37(\%VS) - 0.38 \quad r^2 = 0.70 \quad [2]$$

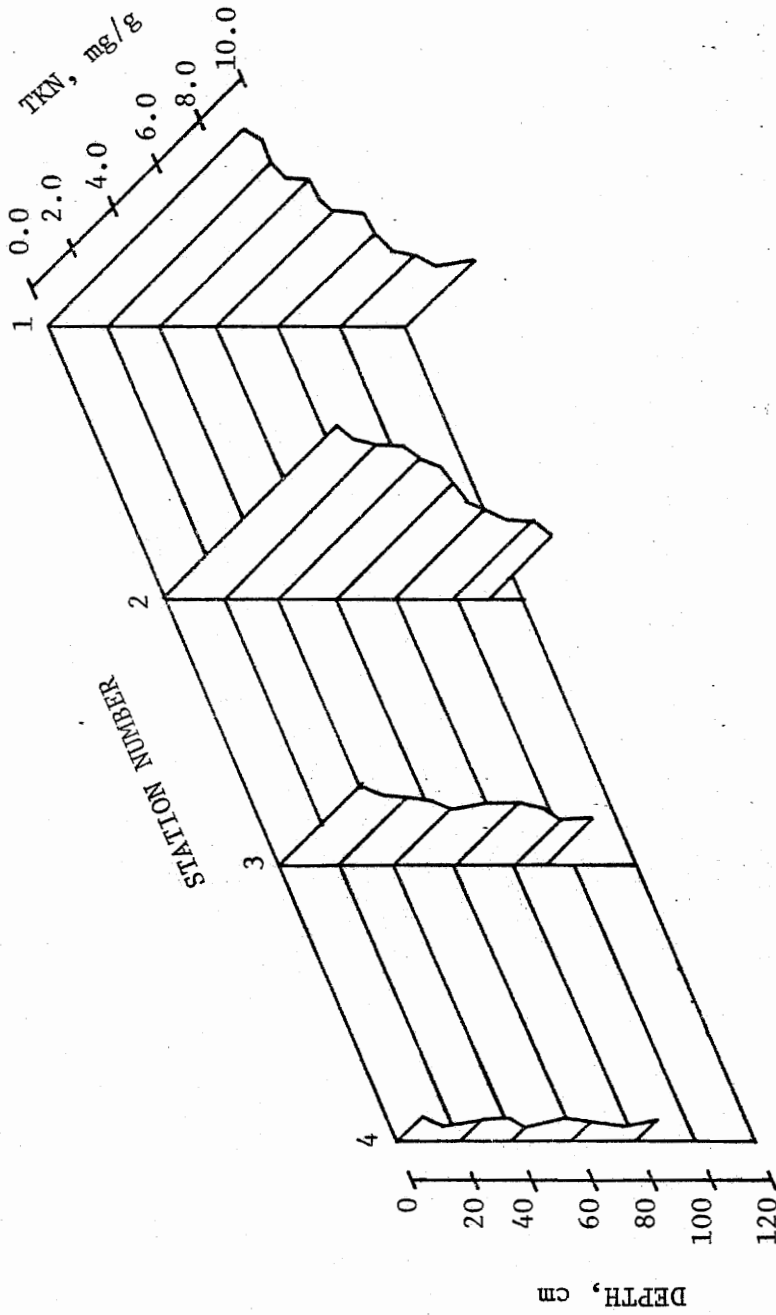

FIGURE 35. Vertical gradation of Sediment TKN

Water Quality Characterizations

As noted in Table II, water samples were taken at Stations 1 and 4 on a periodic basis from September, 1972 to May, 1974. Analysis of these samples permitted the observation of changes in water quality through the impoundment. The drainage area at the Niagara Dam is 512 mi². The drainage area at Station 4 is 501.2 mi². Between Stations 1 and 4, then, the drainage area only increases approximately 11 mi². This is due to the relatively steep slopes of the terrain adjacent to the study area, but it assures that measurable changes in water quality along the length of the impoundment are due to factors other than land drainage inputs. The only point source inputs are upstream of Station 4 a sufficient distance to assure good mixing occurs in the stream prior to that point. It may therefore be assumed, in the absence of point or diffuse source pollutant inputs along the reach encompassed by Stations 1 through 4, that changes in ambient water quality are due to internal processes. These, of course, may be biochemical, physical, chemical, or combinations of the preceding. However, by sampling seasonally during base flow periods, and by analyzing for total constituent concentrations, it was possible to eliminate both the effects of scour during high flow, and the shifts in pollutant balances due to biological activity. The net result being that bulk changes in pollutant concentrations in the water column could be directly related to sediment-water interaction, especially in the case of positive changes through the impoundment. The data displayed in Figures 36 through 38 is for surface samples in the case of Station 4 and for two point

(surface and bottom) depth integrated samples in the case of Station 1. This is because at Station 4, the river flow has just entered the impounded zone, is shallow, and well-mixed, while at Station 1, the water is deeper, and one would expect to find a gradient in constituent concentrations between surface and bottom.

Phosphorus and Iron. Figure 36 shows the changes in ambient concentrations of iron and phosphorus at Stations 1 and 4 during the course of the study. It may be readily seen that a significant difference between tailwater and dam station phosphorus and iron existed during the warm weather months. These two sets observations provide evidence of the role of the deposited sediments in the regeneration of phosphorus bound to insoluble iron species. During the period of time that the Station 4 phosphorus concentration exceeds that at Station 1, it may be noted that the same was observed for total iron, and, moreover, it occurred primarily during the cold periods of the study, indicating oxidizing conditions in the benthos. This may be confirmed by observing the dissolved oxygen data in Figure 37. The larger excesses in the tailwater phosphorus concentrations observed in the summer months suggest that the level of sediment activity may not vary appreciably between the winter and summer months, but the higher flows during the fall and spring probably serve to make similar levels of exchange appear different. That is, a unit weight of phosphorus adsorbed to the sediments during a high flow period would have less impact on the water column concentration than the same unit weight desorbed during a low flow period. This phenomenon has at least one serious consequence with respect to water quality in Smith Mountain Lake, located downstream.

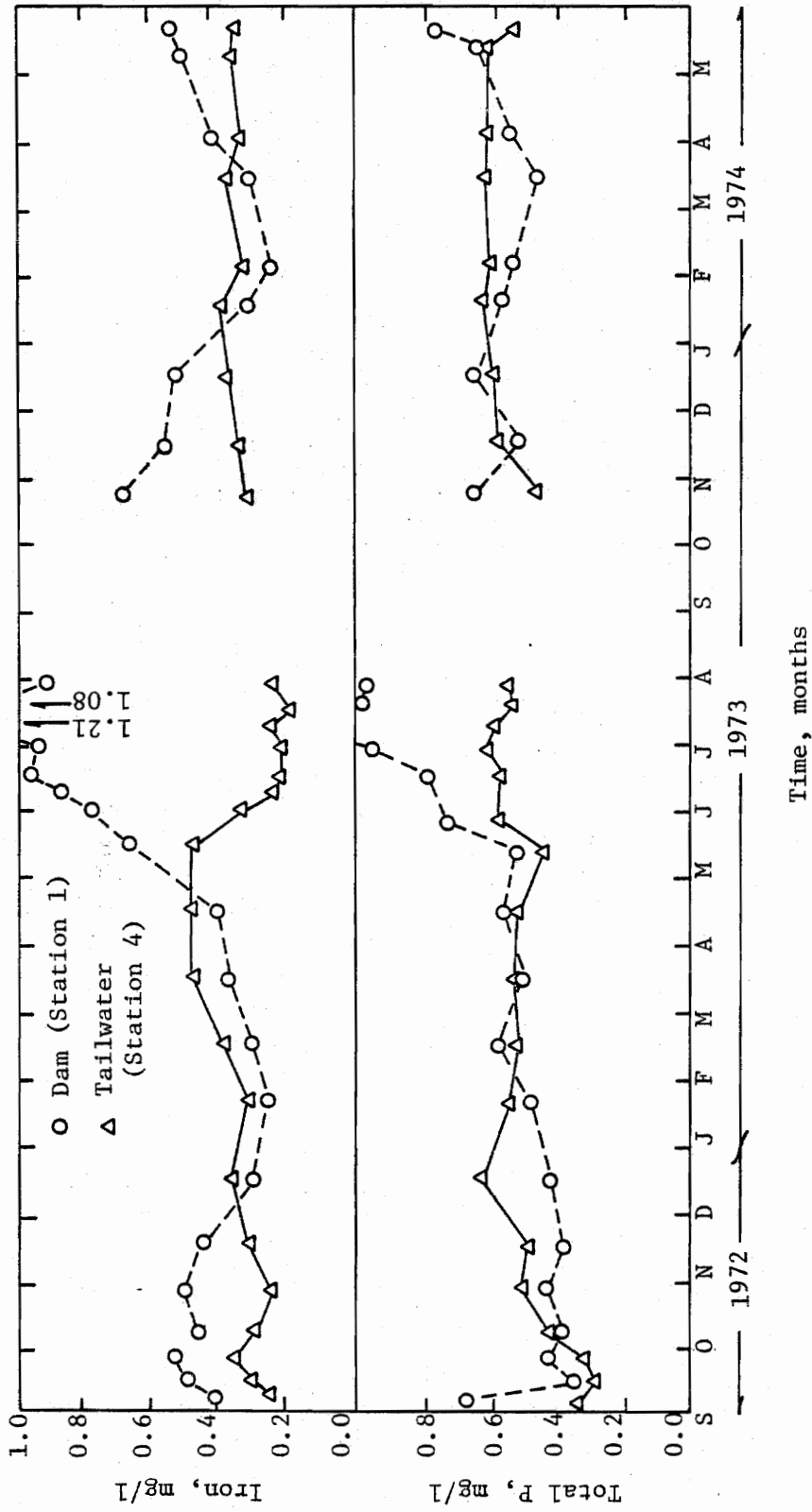

Figure 36. Variations in Iron and Phosphorus in Niagara Impoundment Waters

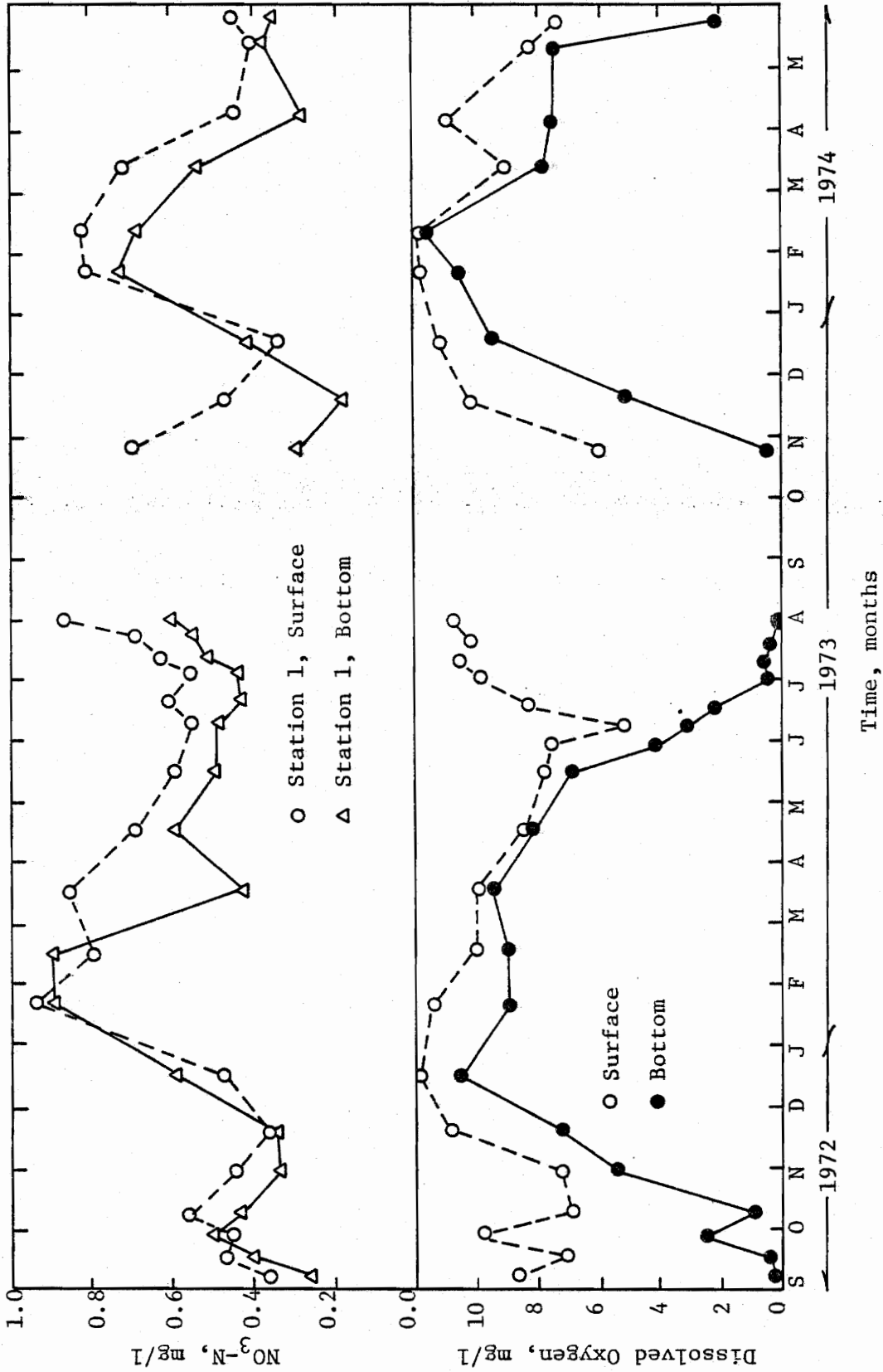

Figure 37. Observed Variations in Nitrate and Dissolved Oxygen in Niagara Impoundment Waters.

While the Niagara sediments need not alter the total annual load of phosphorus delivered downstream, they do appear to reappportion it. Because the flow passing out of Niagara Reservoir into Smith Mountain Lake represents approximately 50 percent of the total inflow, it is apparent that redistributing the phosphorus load it carried could conceivably cause a great impact on the entire lake. It appears that the Niagara act as a winter phosphorus trap - at a time when nutrient oversupply would have little impact on Smith Mountain Lake. In the summer, however, the sediments appear, under the anoxic benthic conditions that occur in Niagara, to regenerate sorbed phosphorus, effectively raising the water column concentration by a factor of as much as two times. This has serious implications, because, while the total annual load may not be enhanced, the summer growing season concentration is raised to a value exceeding the limiting concentration by a ratio of as much as 100 to 1. Such a summer time enhancement could well be an important component of the continuing eutrophication problem in Smith Mountain Lake.

That bottom water dissolved oxygen has an important effect on the ambient phosphorus concentration in the impoundment may be confirmed by referring to Figure 38. The ordinant is calculated by subtracting the Station 1 phosphorus concentration from that at Station 4. The abscissa is the bottom water dissolved oxygen at Station 1. As may be seen, the difference generally rises with a decrease in dissolved oxygen, indicating a liberation of sediment phosphorus. The dividing point between adsorption and desorption appears to lie between dissolved oxygen values of 3 to 6 mg/l, indicating that phosphorus release was taking place even when dissolved oxygen persisted in the bottom waters. It is

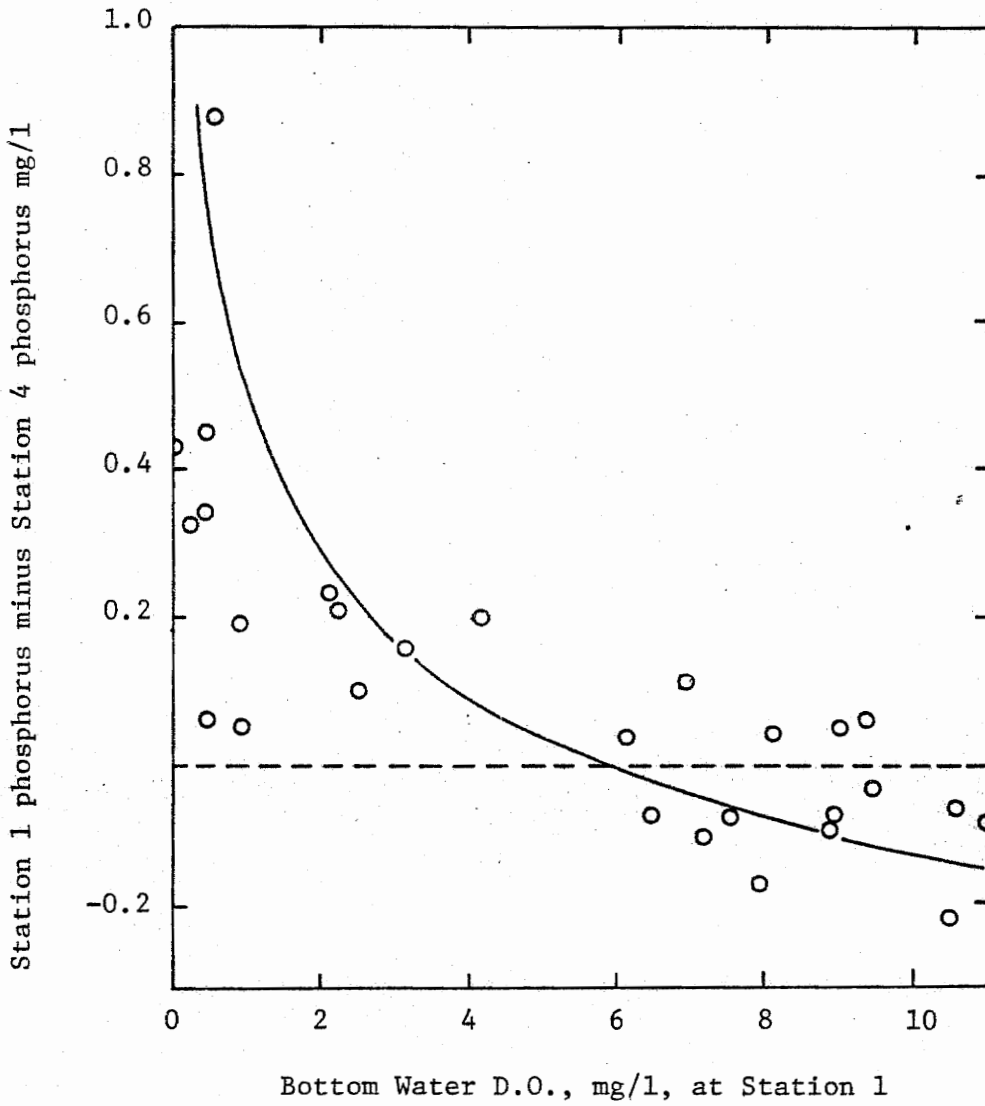

FIGURE 38. Variation of Phosphorus Difference With Bottom Water D.O.

possible, however, that anaerobic conditions existed in the transition zone between water column and sediment even with detectable dissolved oxygen at the lowest point to which the probe could be lowered.

The relationship between ambient phosphorus and iron concentration in the Niagara Impoundment is shown in Figure 39. In order to eliminate the potentially spurious effects of changes in either constituent in the waters entering the impoundment, the data are plotted as differences between the values observed at Stations 1 and 4. A positive relationship ($r=0.81$) was observed to exist between phosphorus and iron, as would be expected in light of the previously discussed relationship between sediment phosphorus and extractable sediment iron. The destruction of sediment iron complexes upon the onset of anoxic conditions results then, not only in the release of bound phosphorus but also the soluble iron component of the parent sorbate compound.

Aluminum. Water column aluminum determinations were made on each sample during the period of the study, but no trend in concentration or relationship to another parameter could be discerned. The values observed ranged from 0.04 to 0.12 mg/l, with a mean of 0.07 mg/l.

Nitrogen. Observation of the Stations 1 and 4 nitrate values, shown earlier in Figure 37, shows that the concentrations tended to peak during the winter months. There appeared to be little difference between the upstream and downstream concentrations during that period of time, indicating only a minimal or non-existent involvement of the sediments during the persistence of aerobic conditions, with respect to nitrate. A drop in total nitrate concentrations occurred at both stations during the summer months, but the concentration remained higher

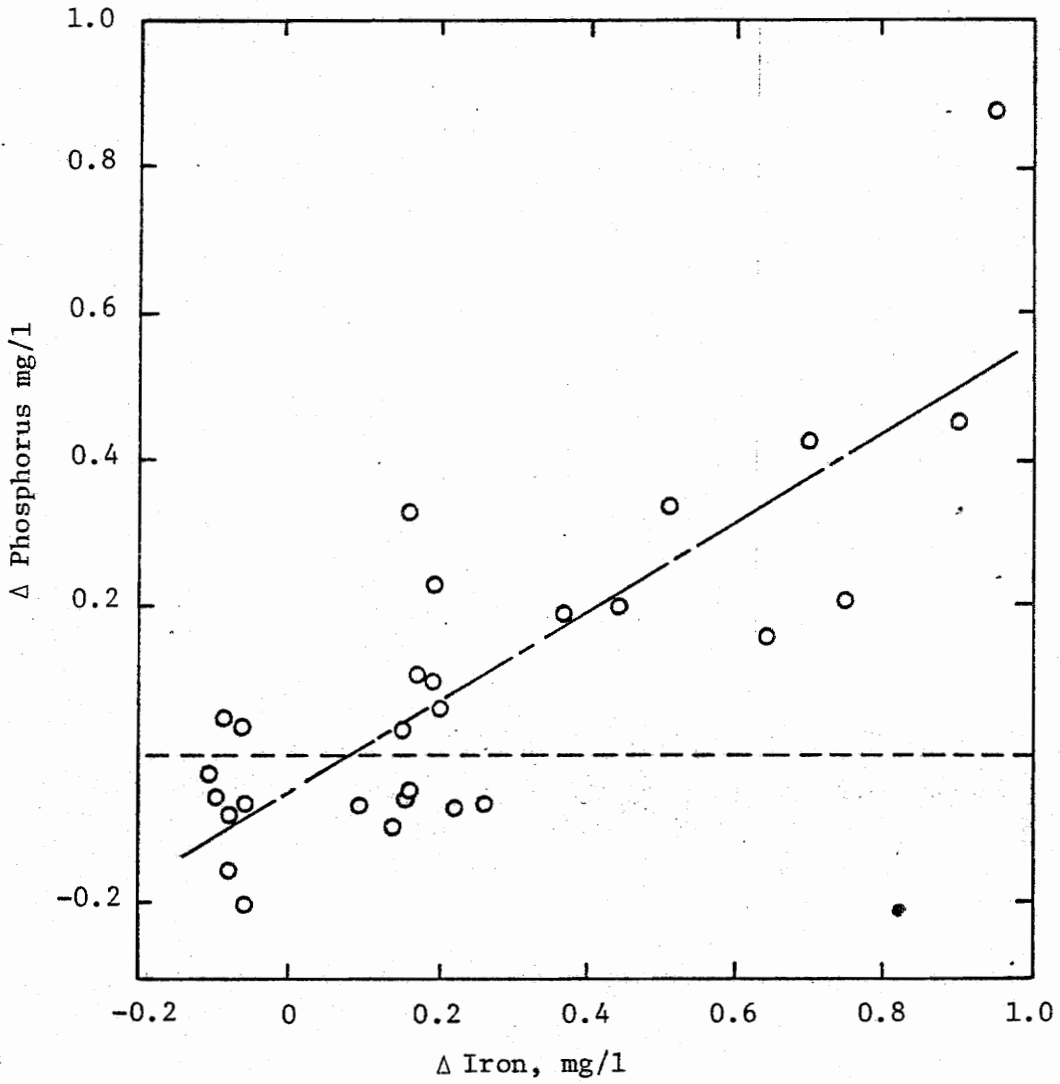

FIGURE 39. Relationship Between Iron Change and Phosphorus Change through Niagara Impoundment

at Station 1, indicating that an enhancement of the water column nitrate occurred through the length of the impoundment. The only possible explanation of this observation is that, in view of the low dissolved oxygen levels at the sediment interface, surficial sediment ammonium was being released and subsequently oxidized to nitrate in the aerobic zone of the water column.

Figure 40 shows the changes in ammonia and TKN at Stations 1 and 4 during the course of the study. The winter month concentrations of both parameters may be observed to change very little through the length of the impoundment, as was observed previously for nitrate. The mid-summer through early fall concentrations of both TKN and ammonia were higher at Station 1 than at Station 4. This is consistent with the earlier observation that the ammonia nitrogen concentration in the surficial sediments tended to drop during the summer months, which was postulated to be an ion exchange phenomenon with dissolved metal species. As stated earlier in the iron discussion, there may well be negative changes in water column concentrations through the impoundment during the winter months, but because the flow rates were generally higher during that period, a given level of sediment activity might not necessarily be reflected in the water column.

Batch Adsorption Studies

The in situ observations of phosphorus interchanges between sediments and water in the Niagara Impoundment prompted the investigation of a quantitative method of describing the removal potential by sediment adsorption. A series of batch, aerobic adsorption studies made it possible to describe the sediment adsorption phenomenon in terms of a

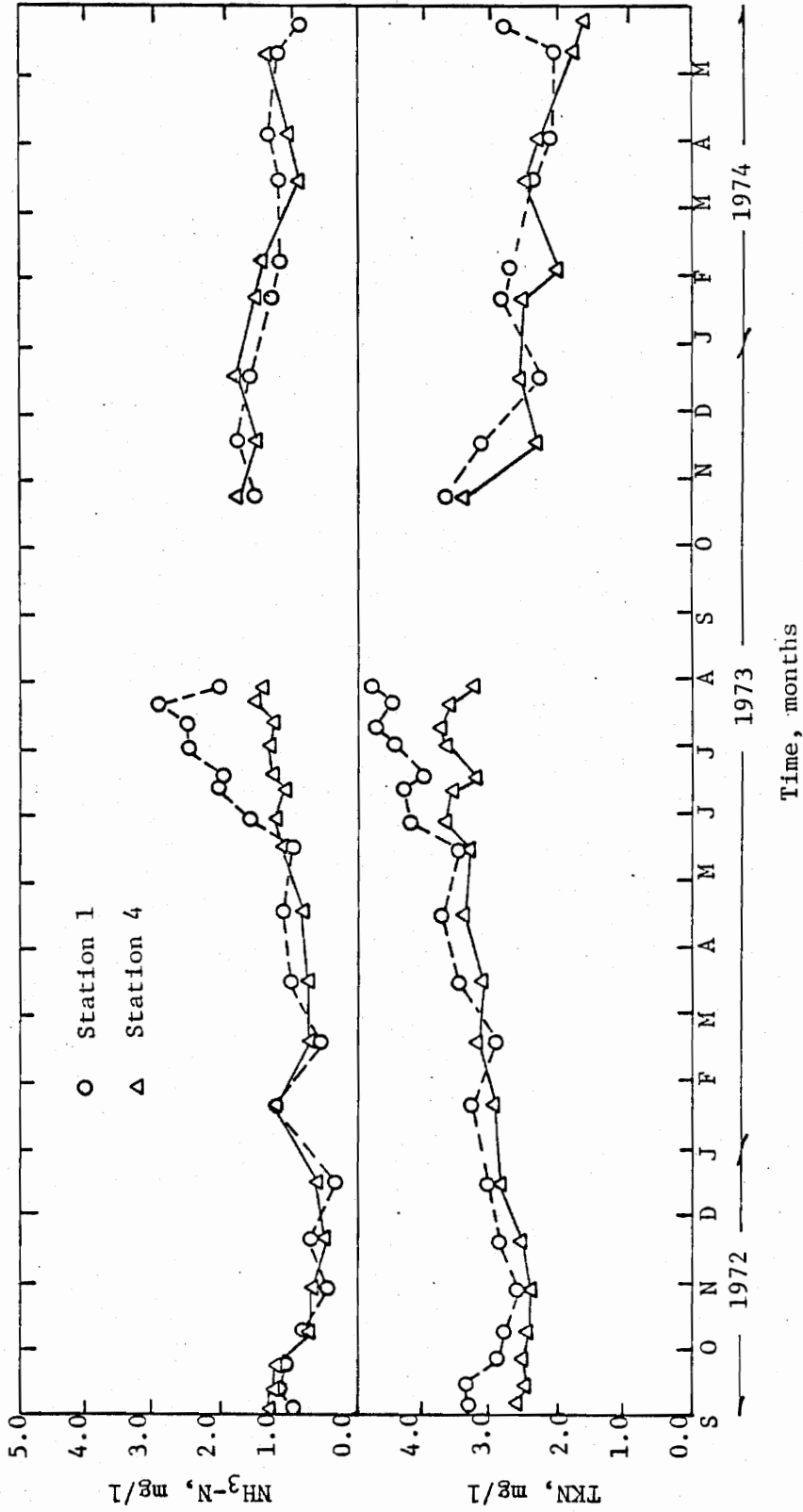

Figure 40. Observed Variations in Ammonia and TKN in Niagara Impoundment Waters

theoretical adsorption isotherm. Samples taken on 2 April, 1974 from all stations were returned to the laboratory and used in the experiments that follow.

Effects of Reaction Time. Figure 41 shows the effect of reaction time on the adsorption of added phosphorus at the rate of 2.0 mg/g with no pH adjustment. Loss from solution was measured periodically and the results plotted against reaction time. From the data in Figure 41, it may be seen that equilibrium was reached at approximately 18 hours. Further experiments were carried out with that reaction time. As a qualitative observation, it may be seen that the maximum adsorption reached at equilibrium was inversely related to distance above the dam.

pH Effects. The optimum pH for phosphorus adsorption was investigated using the same 2.0 mg/g added phosphorus quantity. The pH of each of the sorbent-sorbate systems was adjusted with either HCl or NaOH prior to the eighteen hour agitation. The results plotted in Figure 42 show that the pH of maximum adsorption occurred between 4.0 and 6.0 for the sediments from all stations. Again, the hierarchy of adsorption maxima was directly related to proximity to the dam. Super-imposed upon the data in Figure 42 is the titration curve for phosphoric acid, H_3PO_4 . As may be seen, the zone of adsorption maximum coincided closely with the area where the monovalent anion, $H_2PO_4^-$ is dominant. The $H_2PO_4^-$ form exists between pH 2.0 and 10.0, but the form is dominant in the previously mentioned range. Referring back to the adsorption data, it may be seen that the rate of adsorption decreased dramatically outside the 4.0 to 6.0 pH range, demonstrating that the adsorption phenomenon depends on the form of the phosphate anion.

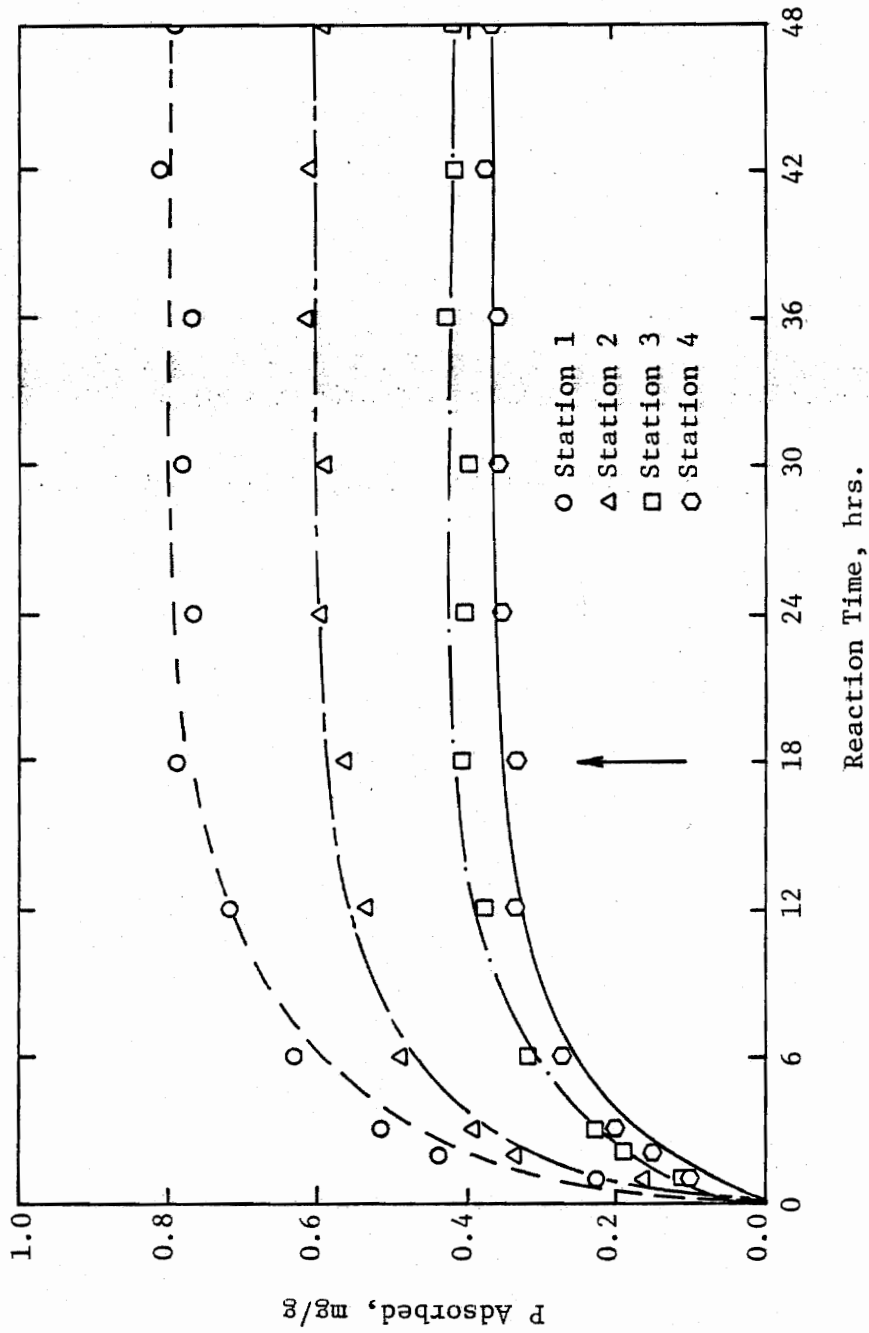

Figure 41. Effect of Reaction Time on Phosphorus Adsorption Equilibrium

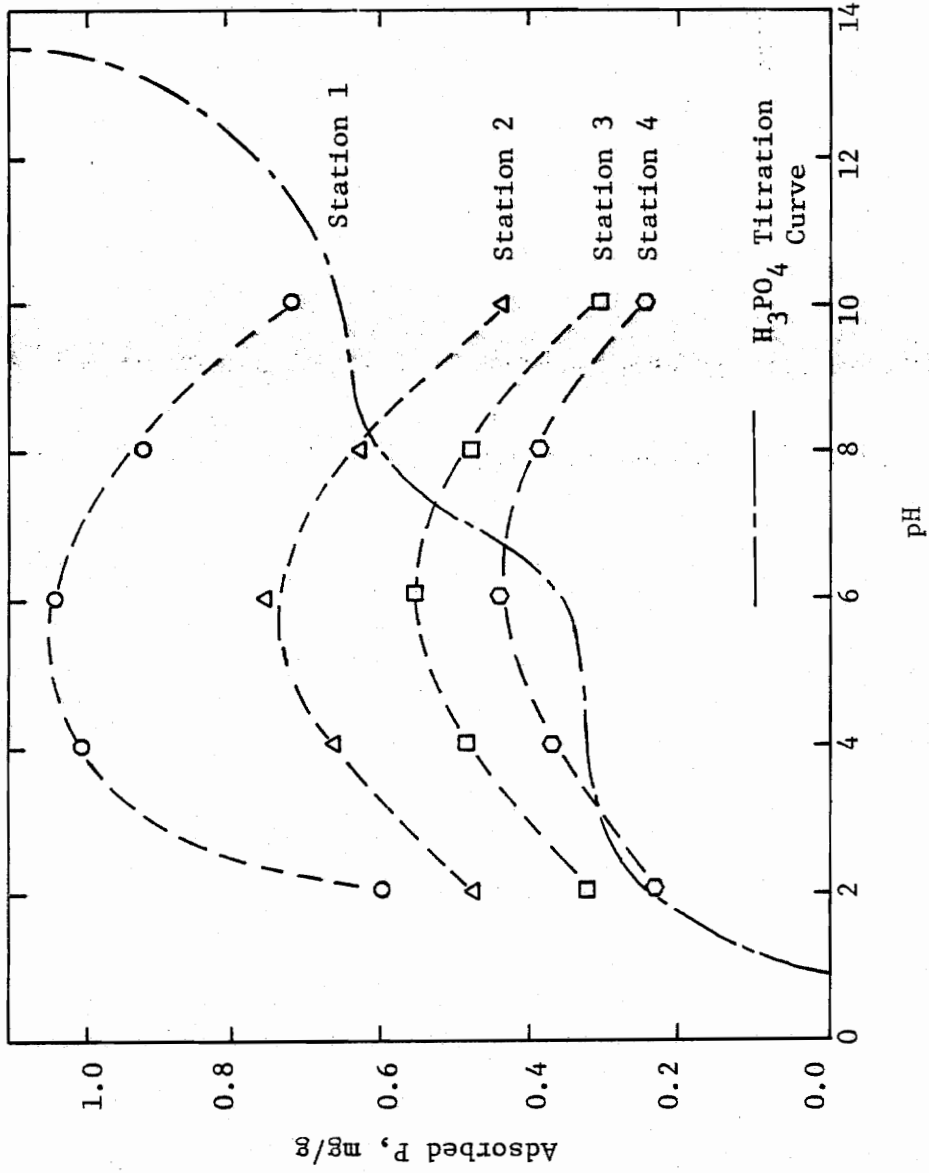

Figure 42. Effect of pH on Adsorption at 2 mg/g Added P

Isotherm Experiments. Adsorption isotherms were constructed by measuring loss from solution during equilibration studies using 0.50, 1.00, 1.50, 2.0, 3.0, 4.0, and 5.0 mg/g added phosphorus. The characteristic isotherms for sediment from each station are shown in Figure 43. The isotherms were constructed from data obtained during equilibration at pH 7.0, which, as stated previously, is not the pH of maximum adsorption, but is however, closer to the pH normally encountered in natural systems. The data in each of the isotherms shown in Figure 43 all appear to adhere to the shape of the classic Type I isotherm (84). That is, the rate of adsorption decreases to zero order at some level of added sorbate. The Type I isotherm is generally considered to depict monolayer adsorption phenomena, where a given sorbate attaches to a finite number of active sites on the sorbent surface, and beyond that point is not capable of binding more. The Langmuir isotherm model (85), was developed originally to describe the adsorption of gases on solid surfaces, but has since been used to describe solution adsorption phenomena. The Langmuir model, the essentials of which are shown in Figure 44, takes the form of a rectangular hyperbola, with the coefficient b and k being, respectively, the adsorption maximum and a measure of the bonding energy of adsorbate for adsorbent. The capability of computing an adsorption maximum gives the Langmuir model an inherent advantage over an empirical model such as the Freundlich isotherm (86), which has no provisions for computing a maximum, but only makes it possible to describe adsorption performance in a narrow range. Figure 45 presents a set of linear plots of the solution adsorption data from Figure 44. A test of adherence to the Langmuir model is the fit of the adsorption

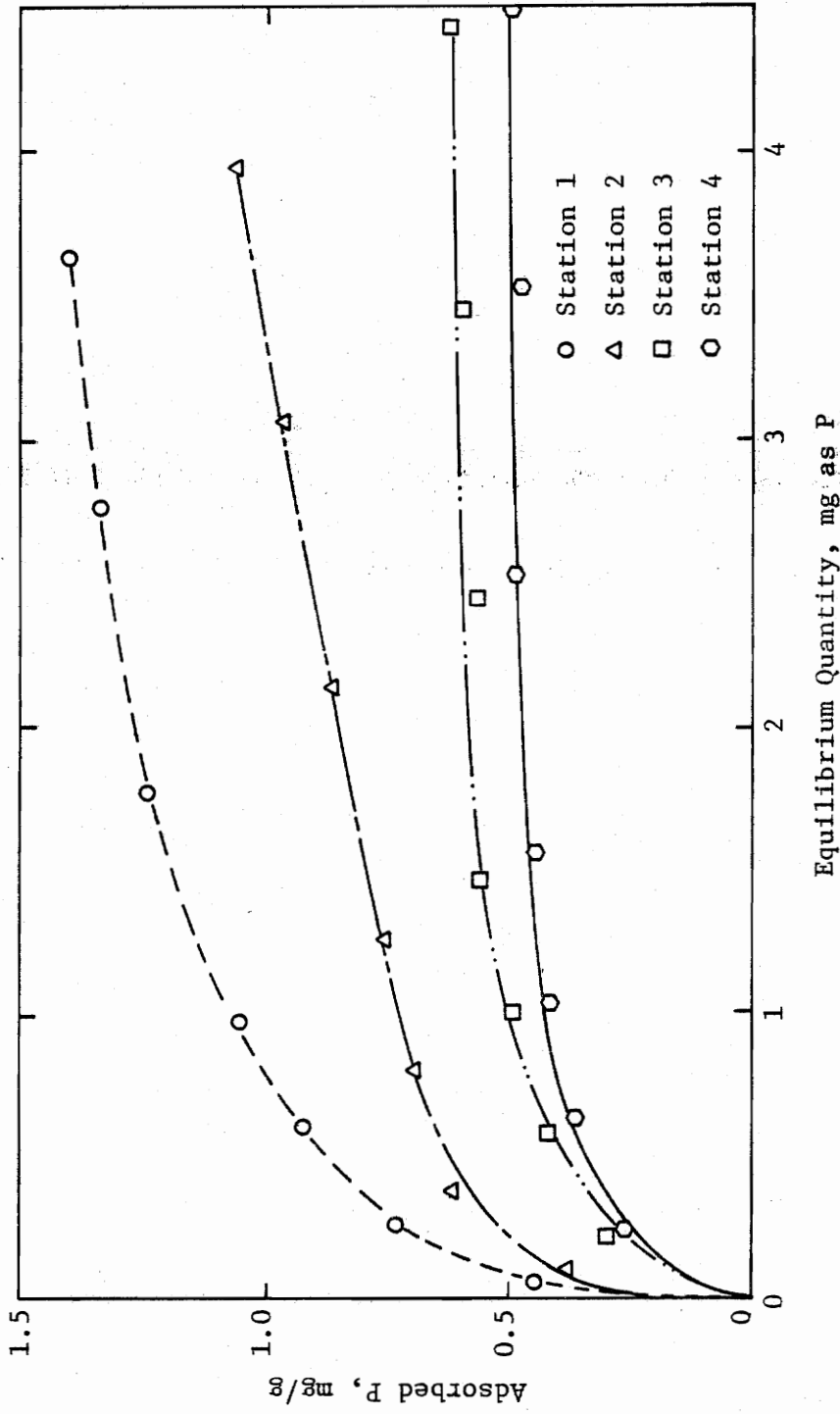
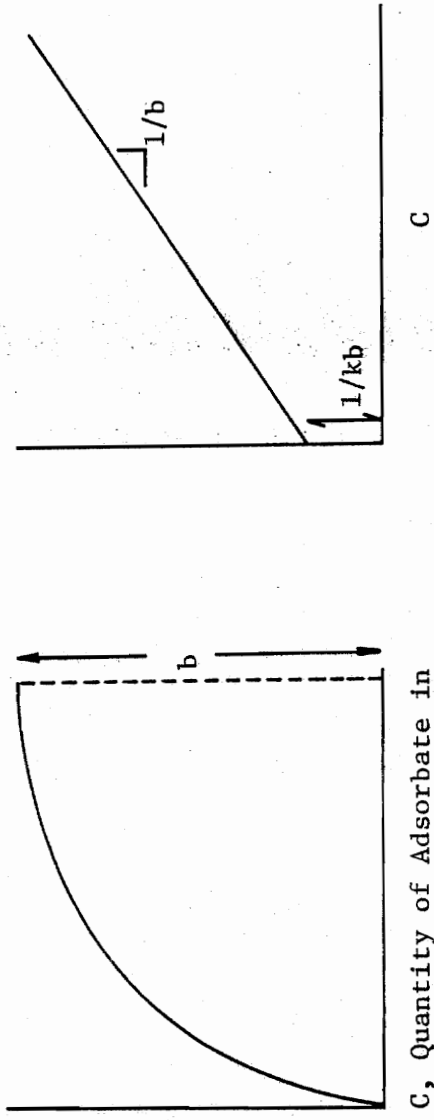

Figure 43. Solution Adsorption Isotherms For All Stations



C, Quantity of Adsorbate in Solution

$$\frac{X}{m} = \frac{bkc}{1+kc}$$

$$\frac{c}{x/m} = \frac{1}{kb} + \frac{c}{b}$$

(Double Reciprocal Plot)

- x/m = Milligrams adsorbate per gram adsorbent
- B = Adsorption Maximum (Monolayer coverage)
- K = Constant related to bonding energy of adsorbate to adsorbent

Figure 44. Essentials of the Langmuir Isotherm For Solution Adsorption

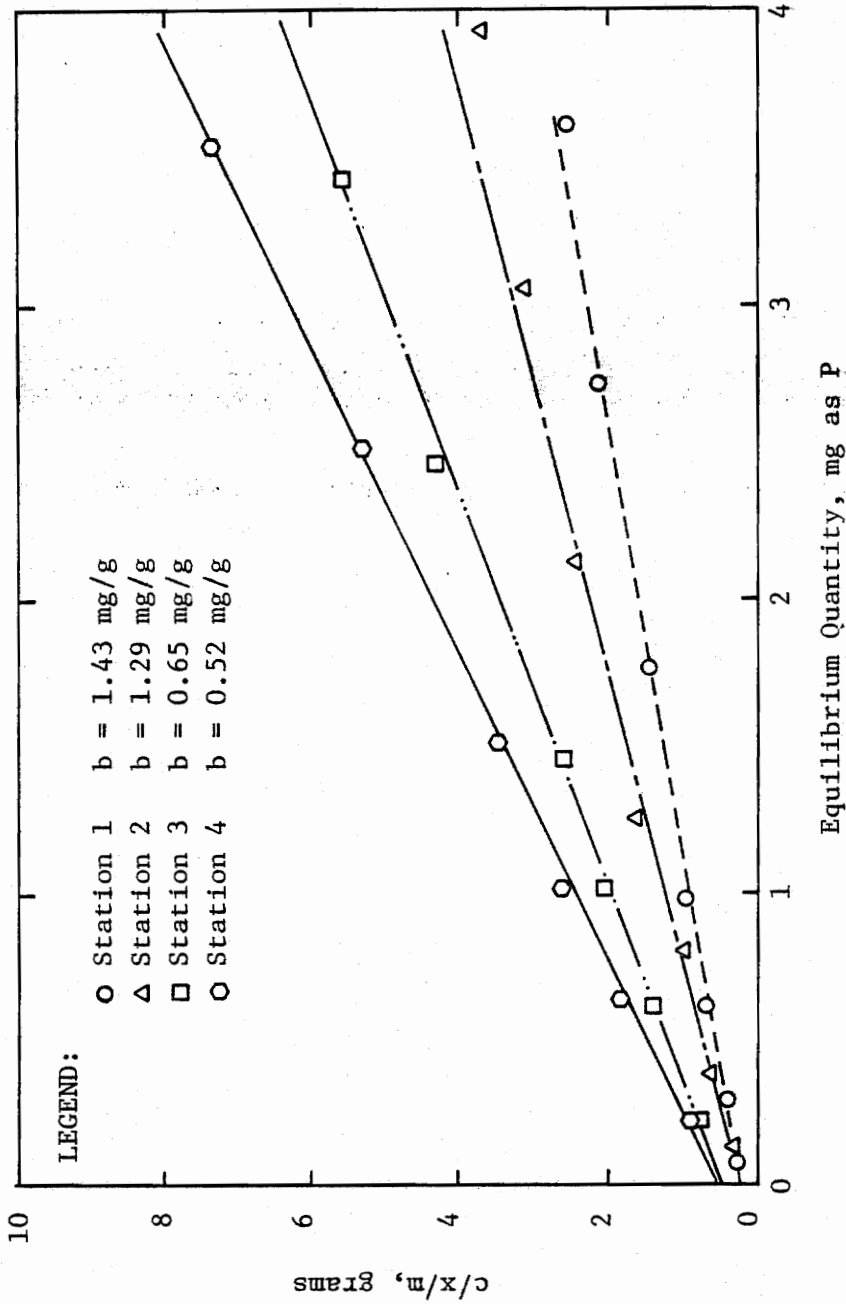

Figure 45. Double Reciprocal Plots of Isotherms For All Stations

data to the linear form given by:

$$\frac{c}{x/m} = \frac{1}{kb} + \frac{c}{b}$$

As may be seen, the data from each station fit the linear model extremely well. The slope of the line in the plot is the reciprocal of b , and therefore, the sediments having the lowest adsorption maximum would be expected to display the highest slopes. This was, in fact, the case, and the data in Figure 44 show that the sediments of Station 1 showed the highest adsorption maximum of 1.43 mg/g. The maximum decreased with distance above the dam to the lowest value at Station 4, 0.52 mg/g. The potential for aerobic phosphorus adsorption is considerable, with even the least active station removing at least 0.50 mg/g.

Saloid P Adsorption. Figure 45 shows the characteristic isotherm data for saloid-P adsorption at all stations. The data were derived by performing the fractionation (70) discussed earlier on the sediment residue remaining following the solution adsorption experiments. As may be seen, the general fit of all the data taken together does not describe the typical Type I, monolayer adsorption isotherm. Rather, the data are more typical of Type II isotherm - most of the models of which allow for the occurrence of multilayer adsorption. That is what appears to be occurring as the curve begins another concave upward turn at an equilibrium P quantity of 3.0 mg. It is thought that this phenomenon is observed because phosphorus entrained in the interstitial waters of the sediments during the solution adsorption experiments is not completely expelled during the centrifugation step used to separate the solid and liquid phases. As a result, a small quantity of the phos-

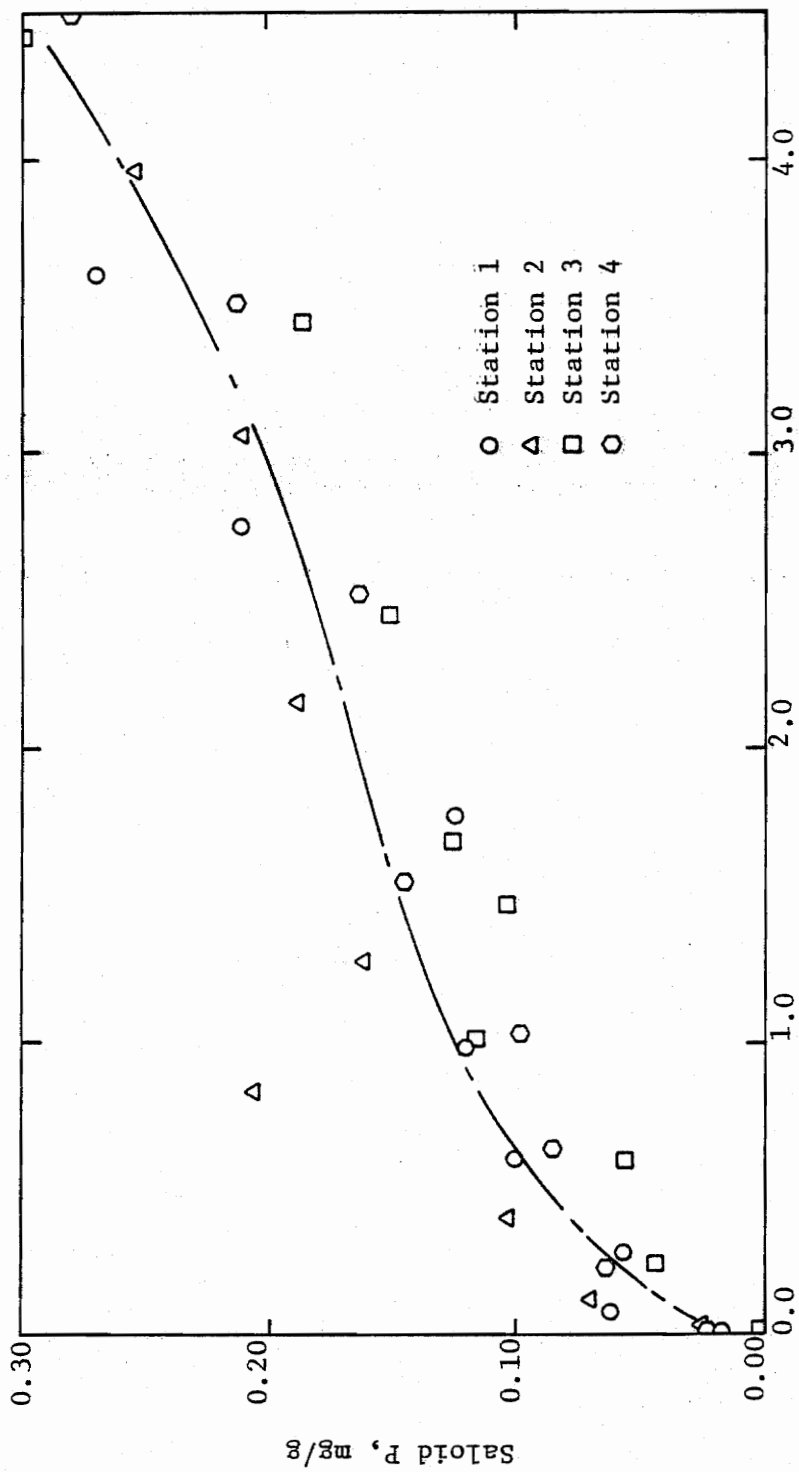

Equilibrium Quantity, mg as P

Figure 46. Saloid Phosphorus Isotherm, All Stations

phorus left in solution at equilibrium showed up in the saloid-P fraction, and caused the curve to resemble a Type II isotherm. The hypothesis that the data do not portray a true adsorption phenomenon is further borne out by the fact that all four stations lie substantially on the same curve, which would indicate no difference in response among the four sediments.

Aluminum P Adsorption. Figure 47 shows the isotherms obtained by measuring the sediment residue changes in the Al-P fraction. The sediment of Station 1 showed the greatest ability to adsorb phosphorus into the aluminum fraction, and that propensity declined with distance upstream of the dam. Table VII shows the coefficients of determination of the regression analyses of linear plots of the data in Figure 48, as well as the Langmuir constants for each analysis. The sediments of Station 1 allowed the highest adsorption into the aluminum fraction, and the other maxima followed the established relationship of decreasing with distance upstream. The fits for the Al-P data were extremely good, with r^2 equalling or exceeding 0.98 in all cases, indicating that the Langmuir model adequately described the adsorption process.

Iron Phosphorus Adsorption. Figure 48 shows the characteristic isotherms for phosphorus adsorption into the iron fraction for sediment from each station. The iron fraction at each station adsorbed a quantity similar to that removed by the aluminum fraction, and the sum of the two accounted for essentially all the phosphorus removed from solution. The sums, in fact, differed from the measured solution loss somewhat, but this is not unexpected because of the differing levels of precision obtained in the solution and sediment phosphorus analyses.

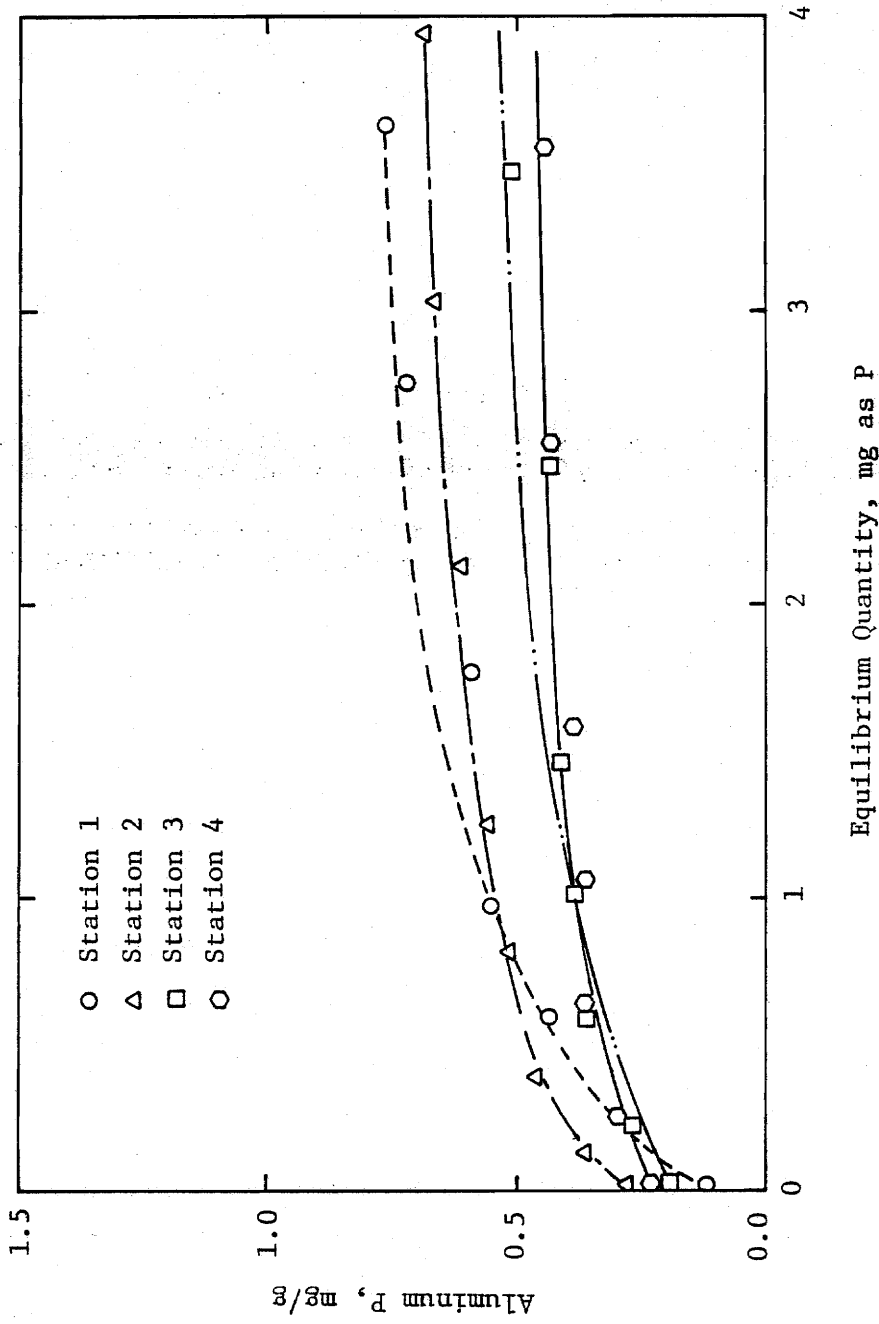

Figure 47. Characteristic Isotherms for Adsorption of Al-P

TABLE VII
 Langmuir Isotherm Constants for Aluminum And Iron
 Fraction Phosphorus Adsorption

Fraction	Station	n	r ²	Adsorption Maximum b, mg/g	Binding Energy Constant k, g
Al-P	1	7	0.98	0.80	3.47
	2	8	0.99	0.70	5.26
	3	7	0.98	0.51	4.45
	4	7	0.99	0.45	6.76
Fe-P	1	8	1.00	0.89	11.20
	2	8	0.99	0.61	18.22
	3	7	0.99	0.51	5.16
	4	7	0.99	0.32	12.48

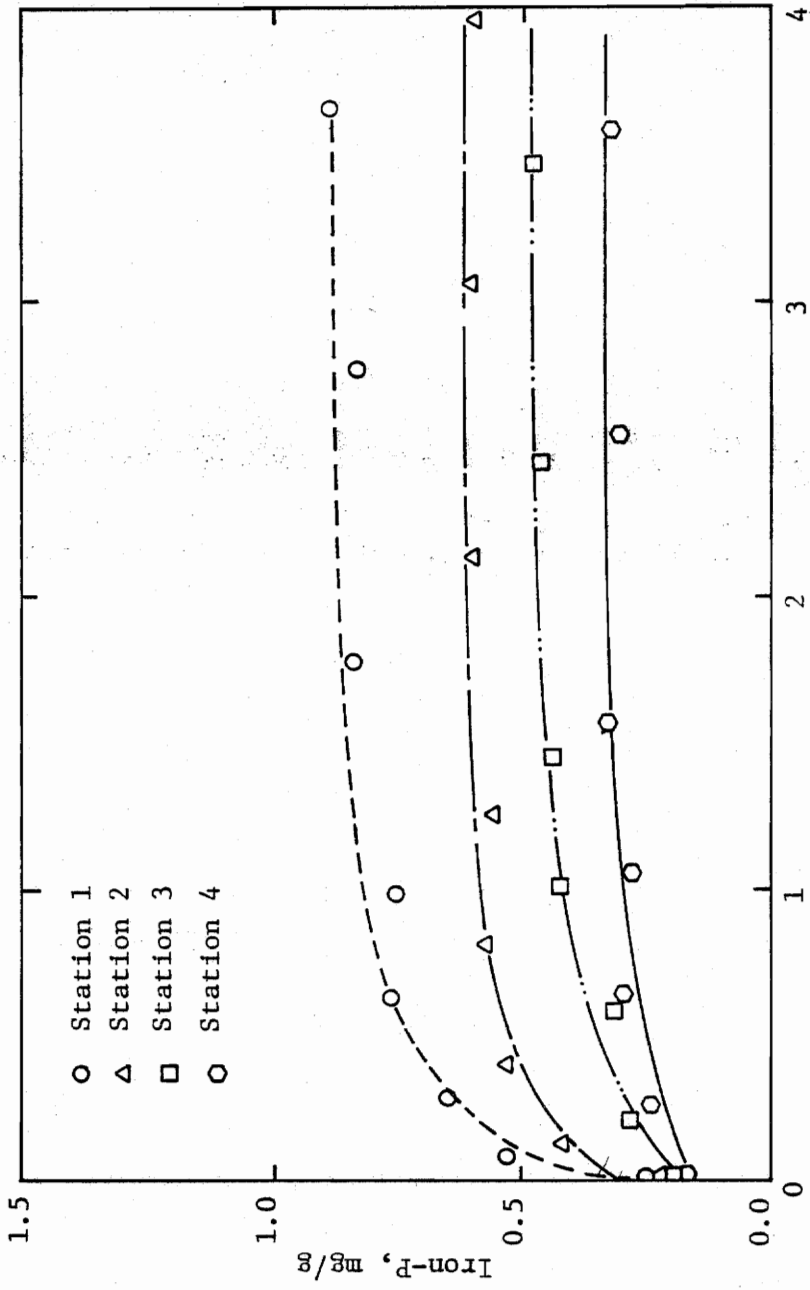

Figure 48. Characteristic Adsorption Isotherms for Fe-P

The iron fraction adsorption at each station also showed excellent linearity, producing values of r^2 of 0.99 or 1.00 in each case. The adsorption maxima, as with the Al-P maxima, declined with distance upstream of the dam, demonstrating the effect of sediment composition.

Non-Adsorbing Fractions. Inorganic phosphorus adsorption was not observed to occur into any other sediment phosphorus fractions, as evidenced by the data for Station 1 in Figure 49. Regardless of the equilibrium quantity of phosphorus, the sediment reductant soluble, occluded, and calcium phosphorus forms remained unchanged. This was to be expected, because the operational definitions of the fractions in the Chang-Jackson fractionation (70) show them to be particularly unreactive, and any adsorption reaction would doubtless require an equilibrium time considerably in excess of 18 hours. The same fractions at Station 2, 3 and 4 showed substantially the same behavior.

Adsorption Maxima Correlations. Figure 50 shows the relationship between the aluminum and iron fraction adsorption maxima and the respective extractable cations. Iron phosphorus has been concluded in earlier sections to be closely related to the phosphorus found in the iron fraction, but it is demonstrated in Figure 50 that the maximum adsorbed into the fraction in a controlled experiment may be predicted by sediment extractable iron observations. Aluminum phosphorus, as concluded earlier, does not show a substantial relationship to extractable aluminum, and the data in Figure 50 confirm that the relationship with adsorption maxima is far weaker than that for iron. Figure 51, however, shows the relationship between adsorption maxima in the Al-P fraction and sediment volatile solids. This observance of a close relationship

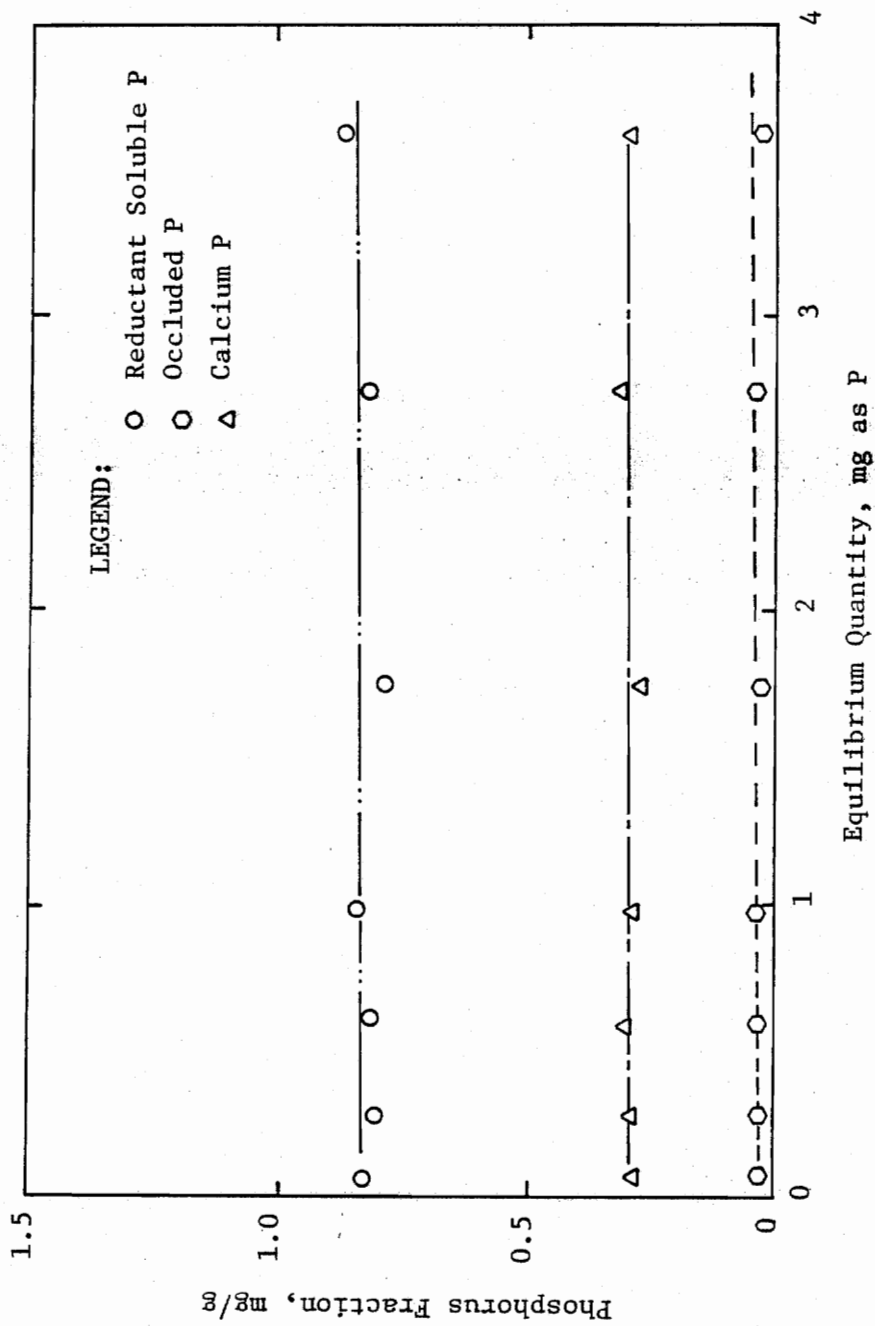

Figure 49. Non-adsorbing Phosphorus Forms at Station One

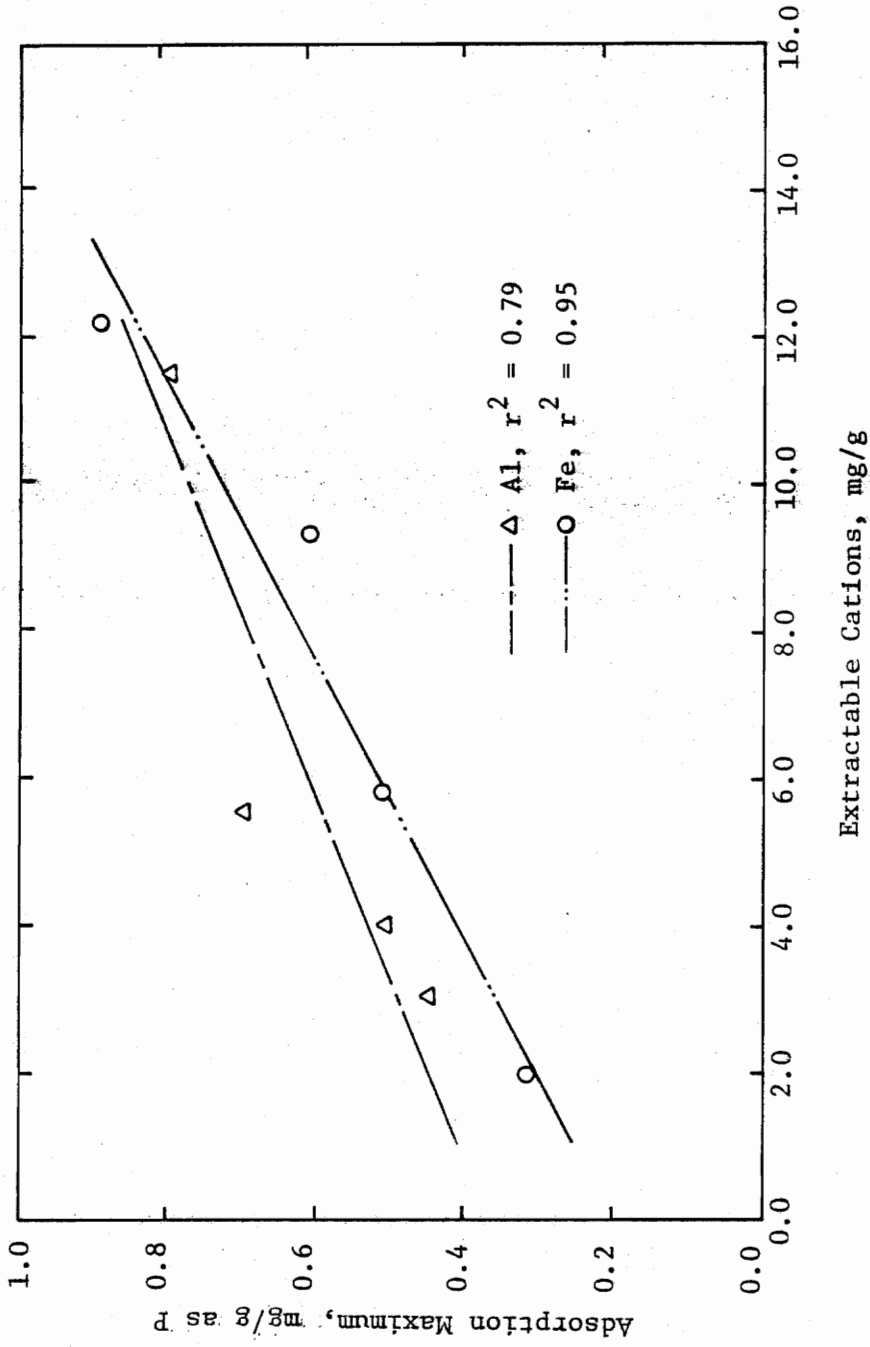

Figure 50. Relationship Between Extractable Cations and Fraction Adsorption Maxima

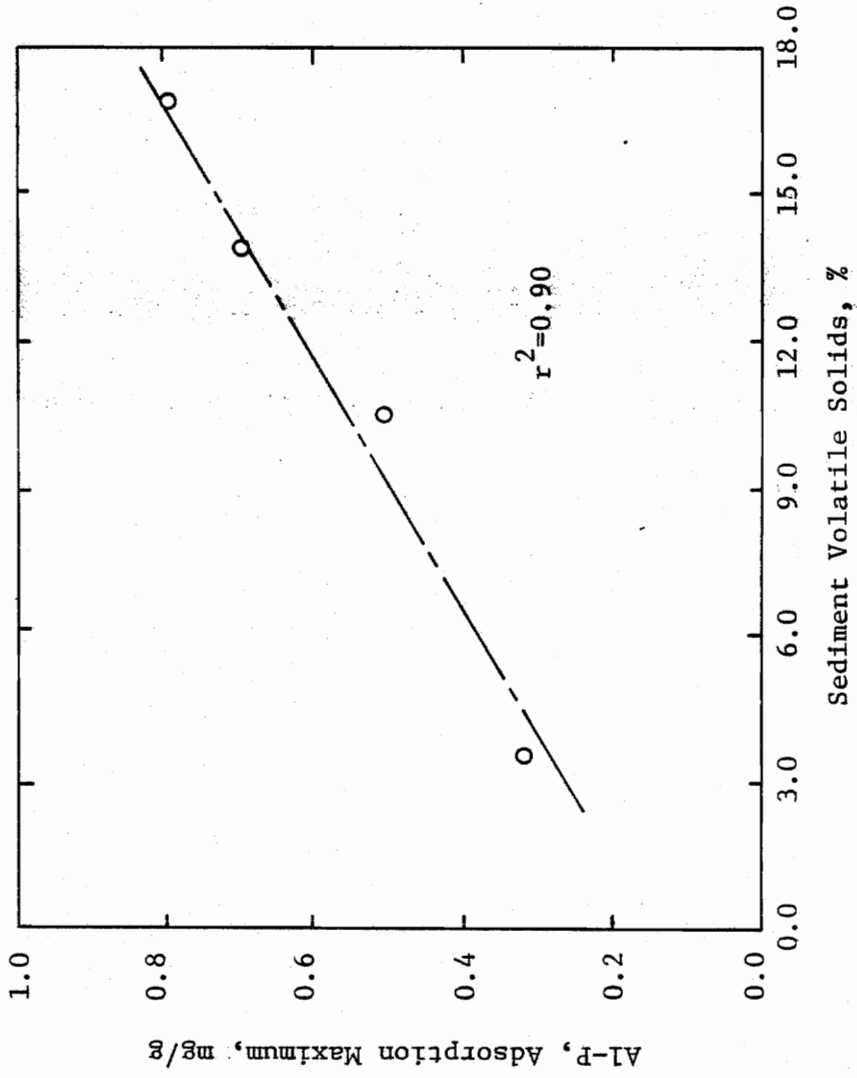

Figure 51. Relationship Between Volatile Solids and Al-P Adsorption Maxima

between Al-P maxima and volatile solids in substantial agreement with the earlier discussed relationship between the two found in the deposited sediments. It appears, therefore, that measurement of extractable iron and volatile solids in Niagara sediments will make possible an a priori assessment of the phosphorus adsorptive capacity of the sediments.

Batch Adsorption Model. It may be postulated from the preceding results that the batch adsorption of phosphorus from solution by Niagara sediment is a function of the extractable iron and volatile matter present in the sediments. Because the removal of phosphorus from solution into the iron and aluminum fractions of sediment phosphorus followed the Langmuir Isotherm, it was decided to adopt that model as the basis for describing phosphorus adsorption by Niagara sediments. A model of the following form is proposed:

$$\frac{x}{m} = \frac{b_i k_i C}{1+k_i C} + \frac{b_a k_a C}{1+k_a C} \quad [3]$$

where, $\frac{x}{m}$ = phosphorus adsorbed per unit weight sediment, mg/g
 $k_i k_a$ = binding coefficients for iron and aluminum phosphorus fractions respectively, mg^{-1}
 $b_i b_a$ = adsorption maxima of iron and aluminum fractions, respectively, mg/g
 C = equilibrium phosphorus remaining, mg

Referring back to Figures 50 and 51, it may be seen that a quantitative expression may be written for the relationship between fraction adsorption maxima and sediment extractable iron and volatile solids as follows:

$$b_a = 0.039 (\% \text{ VS}) + 0.14$$

$$b_i = 0.053 (\text{Ext. Fe}) + 0.20$$

where, % VS = sediment volatile solids, %
 Ext. Fe = extractable sediment iron, mg/g and the Table VII values of k_a and k_i

By substituting the above values of b_A and b_i into the generalized adsorption model, an empirically derived batch adsorption model may be proposed for the surficial sediments of each station. The relationship would appear valid only for relatively short equilibrium times such as found in flowing waters, so as to preclude the possible adsorption into other fractions found to be non-reactive in the 18 hour experiment.

Microcosm Studies

The results of the batch adsorption studies demonstrated the capacity of Niagara sediment to remove phosphorus from solution in a well-mixed system. In order to observe the behavior of the same sediments in systems with a planar interface, a series of microcosm studies were conducted. The only initial nutrient concentration to be varied in the microcosm studies was phosphorus, but the changes in oxidized and reduced nitrogen forms were observed also. The microcosm runs were conducted in a defined sequence with a 30 day anaerobic period following a 30 day aerobic period in order to simulate the spring-summer portion of an annual cycle.

Phosphorus. A series of microcosm studies using three different levels of initial water column phosphorus concentration were conducted, each spanning a 60 day period as described above. The sediment samples from each of the four stations were collected in large quantities on 13 April, 1973. A sufficient quantity to conduct several microcosm runs for each station was retrieved, and the portions not used immediately were frozen until needed. The initial phosphorus concentrations used in the three experiments were 0.0, 1.5, and 3.0 mg/l as P. In each experiment, the water column was prepared so that the initial conditions would

be identical for each reactor. Figures 52-55 show the daily data taken during the 3.0 mg/l initial P experiment. As may be seen, under aerobic conditions, the water column phosphorus concentration declined in all four reactors, indicating that the deposited sediments were removing phosphorus from solution. During the aerobic portion of the study, a crust of reddish-orange color was observed to form on the surface of the sediment mass in each reactor due to the presence of oxidized iron species at the interface. The thickness of the oxidized layer was determined to be 2-4 mm. Assuming that the layer effectively precluded any participation of sub-surface sediments in exchange reactions, it would appear that only a small part of the sediment mass could interact with the water column. The rate of decline and the net removal of water column phosphorus shown in Figures 52-55 appeared to follow the firmly established hierarchy that has shown greater activity to be related to the proximity to the dam. The Station 1 sediments demonstrated a considerable phosphorus removal capacity, reducing an initial water column concentration of 3.0 mg/l to essentially zero in about 20 days. The capacity of the Station 4 sediments was much less, producing a concentration decrease of about 1.0 mg/l in the same period. The data in Table VIII summarize the aerobic performance of the sediment-water microcosms with three different sets of initial conditions. In every case, in all four reactors, the reactors beginning with 3.0 mg/l phosphorus produced slightly lower equilibrium concentrations than those beginning with 15 mg/l. However, because the runs were not conducted simultaneously, it would be difficult to assign much significance to the minor differences observed. In fact, it appeared that, under

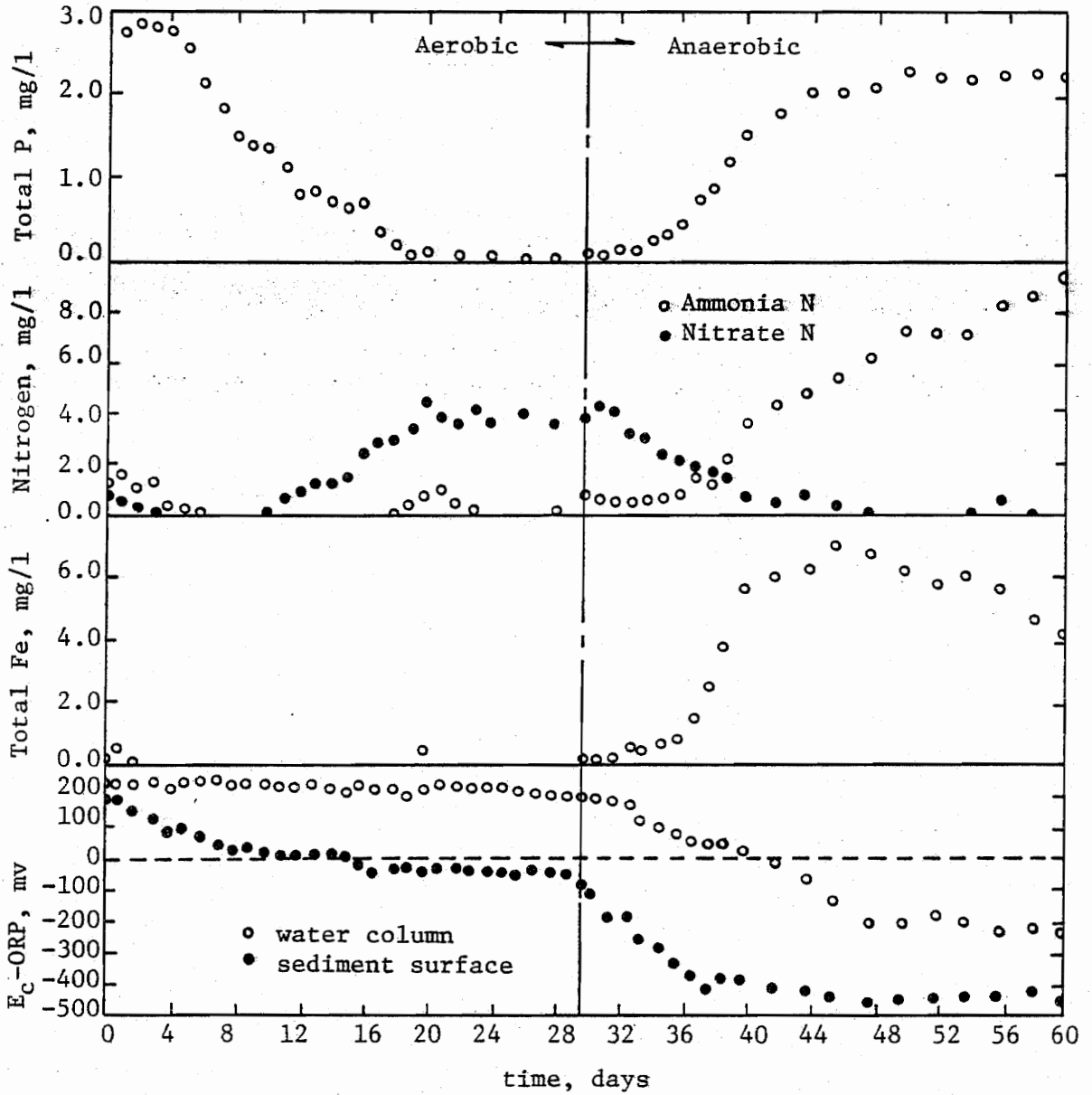

Figure 52. Microcosm Data - 3.0 mg/l added P, Station 1

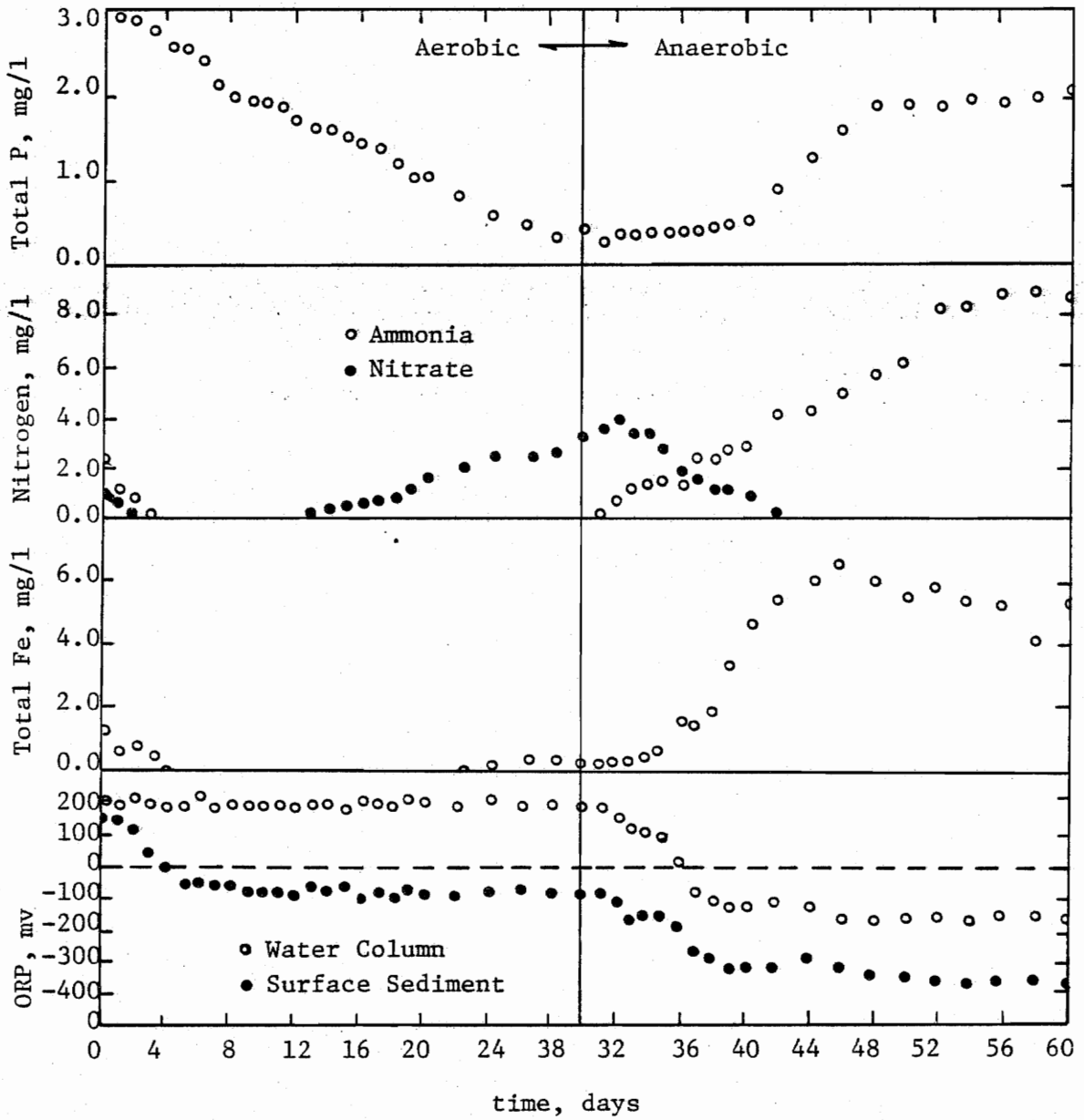

Figure 53. Microcosm Data, 3.0 mg/l Added P, Station 2

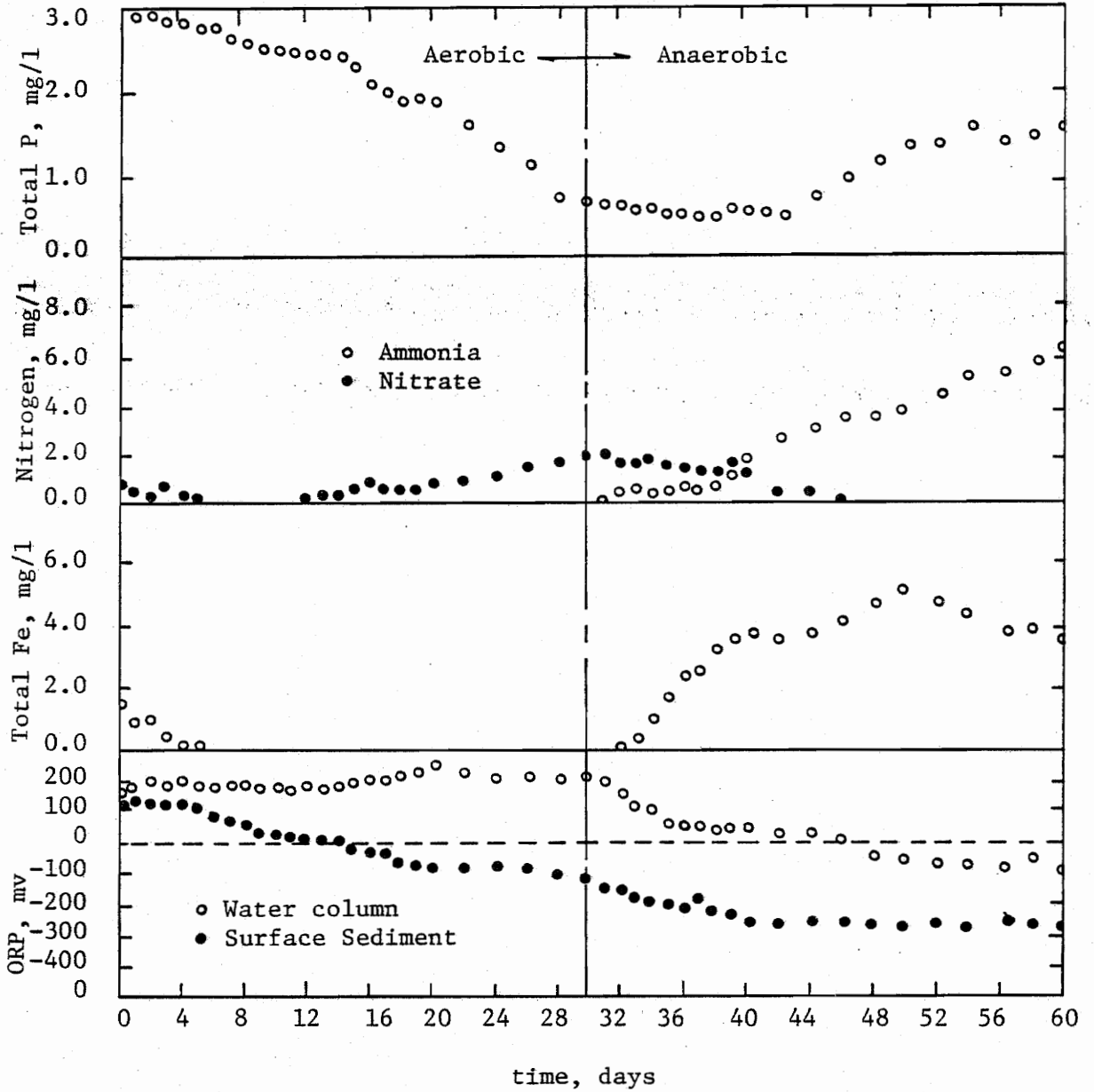

Figure 54. Microcosm Data - 3.0 mg/l Added P, Station 3

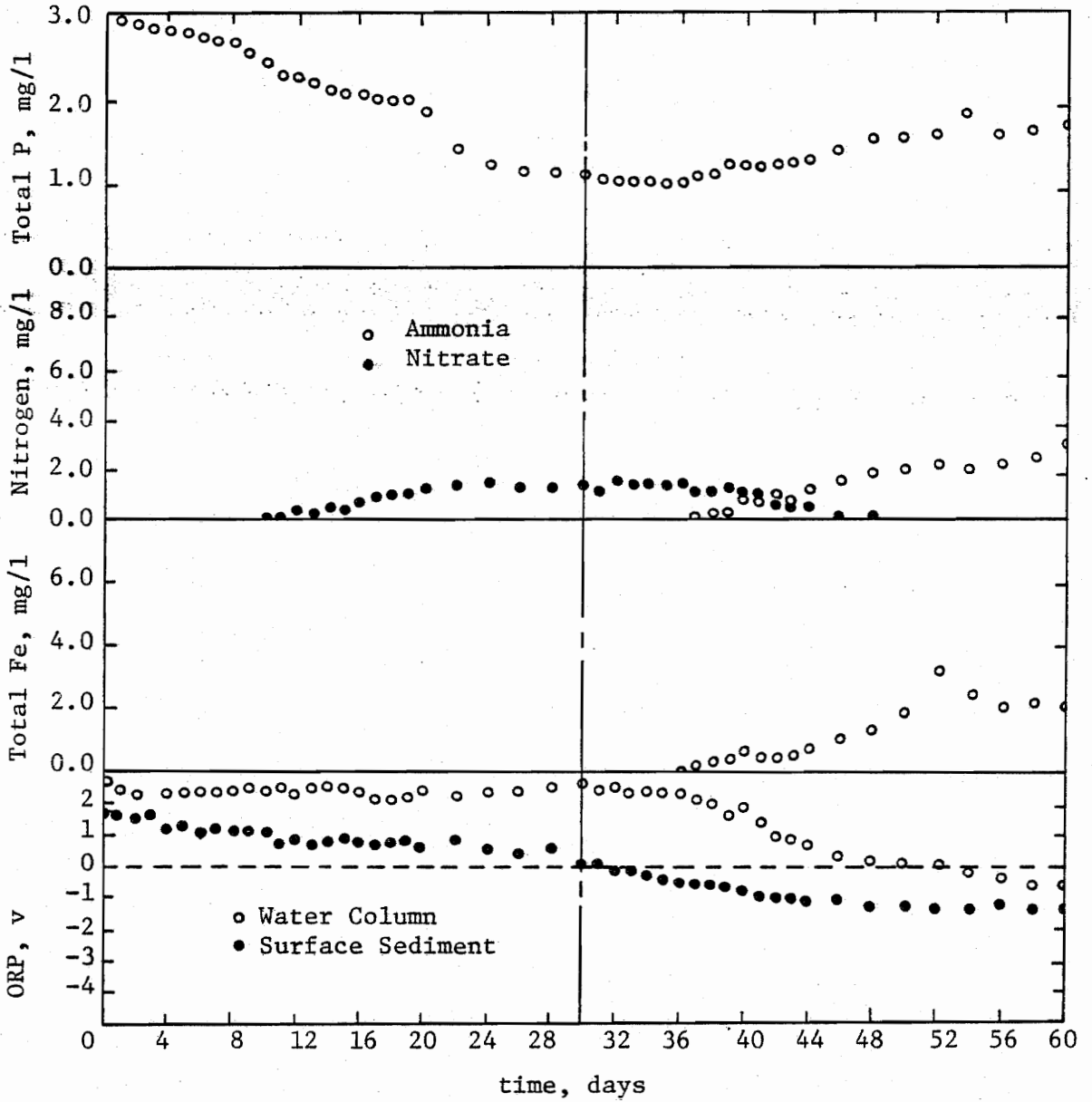

Figure 55. Microcosm Data - 3.0 mg/l Added P, Station 4

TABLE VIII

Aerobic Microcosm Summary - Water Column Phosphorus

Station	Initial P mg/l	Final P mg/l	Equilibrium Time hr.	Mean Adsorption Rate mg/m ² /hr.	Adsorption/Area mg/m ²
1	3.00	0.07	504	1.84	925.3
1	1.50	0.09	672	0.66	445.3
1	0.00	0.07	720	-0.03	- 22.1
2	3.00	0.34	672	1.25	840.8
2	1.50	0.52	624	0.50	309.5
2	0.00	0.05	720	0.02	- 15.8
3	3.00	0.67	672	1.09	735.8
3	1.50	0.87	576	0.35	198.9
3	0.00	0.03	720	-0.01	- 9.5
4	3.00	1.16	624	0.93	582.6
4	1.50	0.95	552	0.31	173.7
4	0.00	0.00	720	0	0

aerobic conditions, in the presence of different levels of added phosphorus, the individual sediments would support similar equilibrium concentrations in the water column. This was not the case, however, when the initial phosphorus concentration was below the equilibrium value. When each of the sediments was placed in an aerobic reactor with no added phosphorus only minor quantities were released to the water column at equilibrium, with the most active sediments at Station 1 desorbing only 0.07 mg/l. The mean adsorption rates shown in Table VIII indicate that the concentration gradient across the sediment-water interface plays an important role in the removal of phosphorus. It appears from the data that halving the initial phosphorus concentration reduced the rate of adsorption by factors averaging about 2.8. This is surely a function of the driving force created by the interfacial concentration gradient.

The second thirty day period of the microcosm runs was conducted with the reactors sealed from the atmosphere under anaerobic conditions induced by the introduction of 20 mg/l COD. Shortly after the beginning of the anaerobic phase, the oxidized zone at the sediment surface began to disappear in all reactors, indicating that the iron oxides were beginning to be reduced. The data for the anaerobic period shown in Figures 52-55 show that, once again, the Station 1 sediments were the most active, returning almost 75% of the adsorbed phosphorus to the water column, while the sediments of Station 4 desorbed only about 0.5 mg/l above the aerobic equilibrium value. The data in Table IX summarize the performance of all four microcosms during the anaerobic phase of the three runs conducted. It is interesting to note that similar sediment,

TABLE IX

Anaerobic Microcosm Summary - Water Column Phosphorus

Station	Initial P mg/l	Final P mg/l	Equilibrium Time hr.	Mean Release Rate mg/m ² /hr.	Release/Area mg/m ²
1	0.07	2.25	480	1.43	688.4
1	0.09	2.35	456	1.57	713.7
1	0.07	2.19	504	1.33	669.5
2	0.34	1.80	432	1.07	461.0
2	0.52	1.72	456	0.83	378.9
2	0.05	1.94	432	1.38	596.8
3	0.67	1.54	432	0.64	274.7
3	0.87	1.32	456	0.31	142.1
3	0.03	1.45	456	0.98	448.4
4	1.16	1.65	432	0.36	154.7
4	0.95	1.26	432	0.23	97.9
4	0.00	1.30	480	0.86	410.5

regardless of initial conditions, regenerated approximately the same level of phosphorus during the three runs. This observation lends further evidence to the conclusion that an interfacial equilibrium helps to establish the sorptive behavior of the sediments. The rates of release declined with distance away from the dam, where they approximated the maximum aerobic removal rate, to a minimum at Station 4, where they were about one-third of the maximum aerobic removal rate.

Examination of the changes in the two active sediment phosphorus fractions at the initial, 30 day, and 60 day points in microcosm runs provided insight into the fate of phosphorus in sediment-water systems. The data in Table X show the changes in the total mass of water column phosphorus, and the concentration changes of sediment iron and aluminum phosphorus during all microcosm runs. During aerobic runs, it may be seen that the Fe-P and Al-P fractions adsorbed phosphorus in almost equal amounts. The exception to this was during the zero added phosphorus runs, when the two active sediment fractions changed only slightly. The equal fraction adsorption is in substantial agreement with what was observed during the batch adsorption studies. In the anaerobic portions of the runs, very little desorption was observed to occur from the Al-P fraction. It therefore appears that the removal of phosphorus by sediment organic matter is not reversible by only changing the ORP status of the system. The majority of the sediment phosphorus regenerated under anaerobic conditions, then, appears to originate from the Fe-P fraction, doubtless resulting from the destruction of oxidized iron forms. Using the net change in solution phosphorus and the active fraction concentration change data, it was possible to calculate the dry

TABLE X
Microcosm Summary - Sediment Phosphorus

Station	Type of Run	Water Column P Change mg	Fe-P Change mg/g	Al-P Change mg/g	Sediment In Exchange Zone, g
1	Aerobic	-26.4	+0.20	+0.19	67.7
1	Aerobic	-12.7	+0.10	+0.08	70.6
1	Aerobic	+ 0.6	+0.05	-0.02	--
1	Anaerobic	+19.6	-0.23	-0.05	70.0
1	Anaerobic	+20.3	-0.25	-0.04	70.0
1	Anaerobic	+19.1	-0.23	-0.03	72.4
2	Aerobic	-23.9	+0.14	+0.16	79.7
2	Aerobic	- 8.8	+0.05	+0.06	80.0
2	Aerobic	+ 0.45	0.0	+0.03	--
2	Anaerobic	+13.1	-0.15	-0.03	72.8
2	Anaerobic	+10.8	-0.12	0.0	90.0
2	Anaerobic	+17.0	-0.20	-0.05	68.0
3	Aerobic	-21.0	+0.11	+0.11	95.4
3	Aerobic	- 5.7	+0.03	+0.05	71.2
3	Aerobic	+ 0.27	+0.02	+0.03	--
3	Anaerobic	+ 7.8	-0.08	-0.01	86.7
3	Anaerobic	+ 4.0	-0.04	-0.01	80.0
3	Anaerobic	+12.8	-0.12	-0.05	75.3
4	Aerobic	-16.6	+0.09	+0.10	87.4
4	Aerobic	- 4.9	+0.04	+0.03	70.0
4	Aerobic	0.0	+0.02	0.0	--
4	Anaerobic	+ 4.4	-0.05	-0.01	73.3
4	Anaerobic	+ 2.8	--	--	--
4	Anaerobic	+11.7	-0.10	-0.03	90.0

weight of sediment involved in the exchange reactions. The mean values within stations were as follows:

<u>Station</u>	<u>Sediment weight</u>
1	70 g.
2	78 g.
3	82 g.
4	80 g.

Assuming a deposited sediment specific gravity of only 1.44 (87), the entire 1.0 liter portion of sediment in the microcosm runs would weigh 1,440 grams. This translates to 41.1 g/mm of sediment depth. The active zone of sediment-water interaction, then, could penetrate no more than approximately 2 mm into the sediment surface, rendering the remaining depth inactive until exposed by hydrodynamic turbulence.

If the active zone of phosphorus exchange is confined to the upper 2 mm of the sediment profile, then adsorption-desorption phenomena would be expected to depend heavily upon exposed surficial sediment area. Small Petri plates were placed in an inverted position over the exposed Station 1 sediments in four reactors, reducing the exposed surface area by 0, 7, 14, and 28 percent. A sixty day run, starting with an initial P concentration of 3.0 mg/l was then conducted as before in order to assess the effect of surface area reduction on phosphorus exchange. The data in Figure 56 demonstrate that such a surface area effect does occur. Both the rate of bulk concentration decrease and the net amount of phosphorus adsorbed decreased with decreasing surface area. Similarly, the rate of regeneration under anaerobic conditions was decreased, as was the net amount regenerated. The rate of aerobic and anaerobic exchange on a unit area basis, however, remained substantially the same.

Nitrogen. Figures 52-55 also show the changes in water column

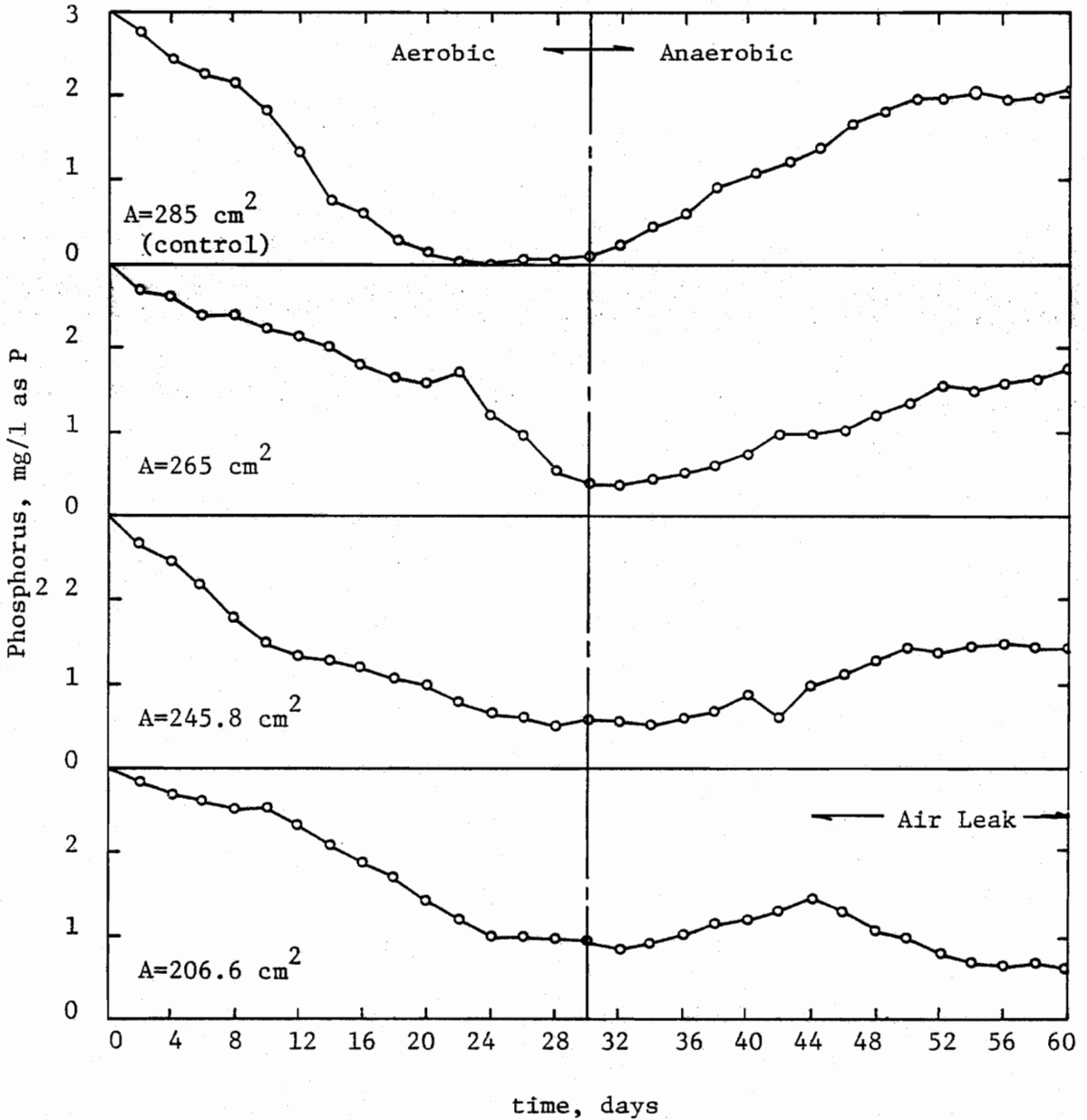

Figure 56. Effect of Changing Surficial Sediment Area on Phosphorus Sorption

nitrogen forms at all stations during the 3 mg/l added phosphorus microcosm runs. Following a brief appearance at all stations on day 0 due to sediment disturbance, no nitrogen forms were observed until the appearance of water column nitrate following the firm establishment of oxidizing conditions by days 8-12. The rate of nitrate generation is shown in Table XI, and may be seen to decrease with distance above the dam, probably due to the concomitant decrease in oxidizable sediment nitrogen. Following the onset of anaerobic conditions in each microcosm, the decline of water column nitrate and the evolution of ammonia nitrogen may be observed in Figures 52-55. The rate of ammonia evolution, however, may be observed to exceed the rate of nitrate reduction in all reactors as shown in Table XI. This may be explained by examination of the water column iron data in Figures 52-55. In each case, the iron reached a peak value, following which a slight decline occurred, accompanied by an increase in the ammonia evolution rate. This indicates the existence of a cation exchange system in which Fe (II) replaces NH_4^+ on active sites in the sediment profile.

ORP. The oxidation-reduction potential data in Figures 52-55 show that while oxidizing conditions may continue to persist in the water column, the sediments may exhibit evidence of a reduced state even in the vicinity of the interface. This tendency towards a reduced state in the sediments makes possible a rapid shift to anaerobic conditions upon the depletion of water column oxygen. As may be seen by comparing ordinate values sharing a common abscissa in Figures 52-55. The rapid decline of sediment ORP below the ± 100 mv. zone signals the onset of the concurrent processes of phosphorus release, nitrate reduction, ammonia

TABLE XI

Microcosm Summary - Water Column Nitrogen

Station	Oxidation State	Mean		Mean	
		Nitrate Evolution mg/m ² /hr.	Nitrate Evolution mg/m ² /hr.	Nitrate Reduction mg/m ² /hr.	Ammonia Evolution mg/m ² /hr.
1	Aerobic	5.86	--	--	--
	Anaerobic	--	3.29	4.12	4.12
2	Aerobic	2.63	--	--	--
	Anaerobic	--	5.00	9.01	9.01
3	Aerobic	1.43	--	--	--
	Anaerobic	--	1.60	2.70	2.70
4	Aerobic	0.93	--	--	--
	Anaerobic	--	1.11	1.72	1.72

Note: Means computed from data taken during 3 microcosm runs performed for phosphorus studies.

liberation, and iron solubilization. It may be possible with the use of permanent ORP monitors to qualitatively identify periods of critical water quality concern in the impoundment, and enable corrective actions to be planned rationally.

V. SUMMARY

This study, which was conducted during the period from the summer of 1972 through the spring of 1974, was designed to assess the water quality significance of the deposited sediments of the Niagara Impoundment. In order to achieve that goal it was necessary to observe conditions in situ in the impoundment over a long period of time and to conduct laboratory studies under controlled conditions to identify specific mechanisms at work.

Methods Development

An adaptation of the Chang-Jackson soil inorganic phosphorus fractionation (70)(71) was developed during the study to provide the capacity to track changes in sediment phosphorus during the course of interaction with the waters of the impoundment. In depth investigation of the operational definitions of the fractions determined by the procedure revealed that the aluminum phosphorus fraction ($\text{NH}_4\text{F-P}$), in fact, is more properly described as inorganic phosphorus sorbed into the organic matrix of the sediment. The remaining fractions of the procedure were found to adhere to the operational definitions assigned in the literature (70)(71).

Assessment of In Situ Conditions

Sediments. The surficial sediments of the Niagara Reservoir were found to vary considerably in chemical constituency - both spatially within the impoundment and temporally during the course of the study. The longitudinal variation in sediment constituency found distance above the dam to be an important descriptor of the changes observed.

The fine, organic material settling in the vicinity of the dam was generally higher in organic content, phosphorus, nitrogen, and metals than the sandy, coarse material at the tailwaters of the impoundment. The Fe-P fraction of sediment inorganic phosphorus was found to be closely related to sediment extractable iron, and, similarly, the Al-P fraction was found to correlate well with sediment organic matter.

The vertical distribution of materials in Niagara lake sediment cores indicated that the patterns currently observed in surficial sediments were adhered to in recent impoundment history. The sediment profile in the impoundment represents a large repository of potential water pollutants. Although the concentrations of most materials declined somewhat through the sediment profile, the potential for considerable water quality impact exists if these materials are allowed to be carried into contact with the impoundment water column.

The temporal changes observed in the constituency of Niagara surficial sediments demonstrated the potential for enhancing the water column pollutant load during periods of sensitivity to pollutant load increases. Al-P, Fe-P, and Reductant Soluble sediment phosphorus were all observed to decline during the summer months, indicating a release to the water column. The dramatic decline in sediment extractable iron at the same time prompted speculation that the primary release mechanism could be anaerobic destruction of insoluble ferric iron compounds, followed by liberation of sorbed and precipitated phosphorus species. The observed slight summer decrease in sediment ammonia prompted speculation that it might enter into a cation exchange reaction with some of the liberated iron forms (Fe^{2+}).

Water. Speculations regarding the effect of the bottom sediments on overlying water quality were borne out by the observation of pollutant concentration changes through a reach of the Niagara Impoundment receiving no point or non-point source inputs. Specifically, summer iron and phosphorus concentrations were seen to rise by over 1.0 and 0.8 mg/l, respectively, between Station 4 and Station 1. Conversely, winter and spring concentrations were observed to decrease through the impoundment. These two observations confirm the aerobic uptake of phosphorus by the lake sediments in conjunction with the formation of insoluble ferric iron complexes, and the anaerobic release of the same phosphorus upon the destruction of the sorbate iron species. In effect, this phenomenon performs a concentrating action, removing phosphorus from solution during the winter and spring, storing it, and subsequently releasing it back to the water column at higher net concentrations during the summer. The net annual load on Smith Mountain Lake is probably unaffected, or actually reduced slightly, but because of the time shift of the peak phosphorus concentrations to the summer months, the downstream water quality impacts are magnified. Stimulation of nuisance algae occurs because of concentration, not load, increases, and the summer release performs just that function. Similar increases in unoxidized nitrogen forms were observed to occur during the summer months, coinciding with the exchange of reduced iron ions for ammonia ions adsorbed to active sites on the sediment.

Development of Adsorption Isotherms

Batch, aerobic phosphorus adsorption studies conducted with the sediments from Niagara Reservoir revealed that the bulk removal from

solution followed the Langmuir Isotherm, as did the adsorption into the individual iron and aluminum phosphorus fractions. The remaining sediment inorganic phosphorus fractions were found to be non-adsorbing, reinforcing the hypothesis that the adsorption depends wholly on iron and organic matter. As was expected the sediments from Station 1 displayed the greatest sorptive capacity, while those from Station 4 displayed the least. The optimum pH range for phosphorus adsorption was found to lie between 4.0 and 6.0 - the range where the H_2PO_4^- anion is dominant. Using the observed correlation of respective fraction adsorption maxima with extractable iron and sediment organic matter, a two-part Langmuir model was proposed for describing aerobic phosphorus adsorption by Niagara sediments.

Microcosm Studies

A series of long-term experiments using sediment-water microcosms under aerobic conditions showed that phosphorus concentration in the water column provides an adsorption driving force as long as it exceeds an equilibrium concentration for the system. If the water column concentration drops below that value, a slight release may occur even under aerobic conditions. In analyzing the sediments following aerobic microcosm runs, it was found that the uptake of solution phosphorus was split almost equally between the Al-P and Fe-P fractions. In the subsequent anaerobic runs, however, very little Al-P was released, while the desorption of Fe-P approached values as high as 75% of the total phosphorus removed from solution during the aerobic phase.

Using an assumed value of sediment specific gravity and the phosphorus quantities adsorbed into the active fractions, it was possible

to compute a depth limit for phosphorus exchange activity in the sediment profile. The 2 mm value coincides closely with the measured depth of the iron oxide crust that formed at the interface during aerobic microcosm runs. Further investigation using parallel microcosms from the same station confirmed this, showing that phosphorus exchange, both aerobic and anaerobic, was essentially a surface phenomenon, and that it could be altered dramatically by changing the available sediment surface area.

The behavior of the nitrogen forms at each station was substantially unchanged in all microcosm runs, regardless of the initial phosphorus values. Aerobic nitrate production rates were highest near the dam and lowest in the microcosm set up on the tailwater station. The anaerobic production of ammonia occurred at a higher rate and in greater quantities than could be accounted for by nitrate reduction at all stations. The additional ammonia appeared to be the result of a cationic exchange with ferrous iron.

Recommendations

Because the sediments of the Niagara Impoundment appear to be capable of concentrating delivery of much of the annual nitrogen and phosphorus load to Smith Mountain Lake into the summer months, the potential for water quality damage is clear. Steps should be taken to inhibit the ability of Niagara sediments to continue to contribute to the problem. Specific methodologies which might be considered are as follows:

1. Removal of deposited sediments
2. Sealing of the sediment surface
3. Growing and harvesting rooted aquatics

4. Maintaining aerobic benthic conditions

Dredging the deposited material does not appear to be a feasible alternative. The rough cost of such a venture would be \$4.00/c.y., exclusive of spoil disposal area acquisition (88). Because the available core data does not go to the original stream bed, the exact quantity of dredge material is unknown. However, it is certain that the entire profile would have to be removed in order to avoid exposing a new nutrient-laden horizon to the water column. In addition, the problem would immediately begin to recur because of new sediment influx and production. Upon the accumulation of as little as several millimeters of deposited sediment, the problem could well revert to its former intensity.

Sealing of the sediment surface would be less costly than the dredge option, but no more effective. New sediment would immediately begin to accumulate on the inert material and the problem would reappear.

The lower end of the Niagara impoundment is too deep to consider the harvesting of rooted aquatics as a sediment nutrient removal plan.

The last alternative, maintenance of aerobic benthic conditions, appears to be the only viable long-term solution. Sufficient power to provide the necessary aeration could be provided by the Niagara hydroelectric facility itself, or by making use of waste digester gas from the Roanoke Sewage Treatment Plant, located upstream. In view of the fact that no benthic oxygen uptake data is available, the exact cost of aeration cannot be determined. The desired level of dissolved oxygen to be maintained, however can be estimated from Figure 38, which shows that below approximately 6.0 mg/l in the bottom waters, the release of phosphorus began to occur. It should be noted that the D.O. data in

Figure 38 was taken approximately 1-2 feet from the mud-water interface, and it is likely that the corresponding interfacial D.O. was considerably lower. It is most probable, then, that maintenance of aerobic benthic conditions will allow the Niagara sediments to withhold phosphorus from the phosphorus limited situation in Smith Mountain Lake.

VI. CONCLUSIONS

1. The replicability of the modified Chang-Jackson phosphorus fractionation (70) is sufficient to warrant its use in characterizing changes in the inorganic phosphorus fractions of deposited Niagara sediments.
2. Surficial sediment volatile solids, nitrogen, inorganic phosphorus, and extractable cations displayed a generally negative relationship with distance above the Niagara Dam, due to the hydraulics of the settling patterns in the impoundment.
3. Organic nitrogen was the major nitrogen form in all Niagara surficial sediments and cores.
4. The aluminum phosphorus fraction in the Chang-Jackson fractionation is not substantially related to sediment aluminum, but rather to inorganic phosphorus adsorbed on sediment organic matter.
5. Both iron and reductant soluble iron phosphorus fractions were found to be closely related to and dependent upon sediment extractable iron.
6. In situ observations of surficial sediment aluminum and iron phosphorus showed substantial decreases during the summer months due to releases to the water column. Similarly, surficial sediment ammonia decreased, but sediment TKN experienced a slight rise in the summer months.
7. Vertical stratigraphy of sediment cores showed a generally declining relationship for most parameters with depth, except the non-adsorbing phosphorus fractions, which remained relatively constant. The sedi-

ment profile, however, continues to represent an untapped nutrient source within the lake.

8. Seasonal water quality data showed extremely high increase in phosphorus and iron through the impoundment due to sediment release in the summer months. Slight decreases due to sediment adsorption in winter and spring were observed.
9. Less pronounced summer increases in nitrate, due to surface water oxidation, and ammonia, due to sediment cation exchange with ferrous iron, were observed through the impoundment.
10. The onset of sediment phosphorus release could be satisfactorily monitored by awaiting the near bottom water D.O. at Station 1 to fall below 6 mg/l.
11. Batch adsorption studies showed that both the bulk solution phosphorus adsorption and adsorption into the Al-P and Fe-P fractions could be described using the Langmuir Isotherm, and adsorption maxima calculated for the sediments of each station.
12. Bulk solution and fractional phosphorus adsorption maxima followed a declining relationship with distance above the Niagara Dam. The adsorption into Al-P and Fe-P fractions was substantially equal.
13. The most active phosphorus species in sediment adsorption is the H_2PO_4^- anion.
14. Sediment adsorption maxima could be predicted a priori using measurements of sediment volatile solids and extractable iron in a two-part Langmuir adsorption model.
15. A series of aerobic-anaerobic microcosm runs demonstrated that high levels of water column phosphorus removal was possible under

aerobic conditions.

16. Phosphorus interactions had no effect on the behavior of nitrogen in microcosm systems. Under aerobic conditions, substantial nitrate was produced. Under anaerobic conditions, the nitrate was reduced to ammonia, and additional ammonia was evolved from cation exchange with ferrous iron.
17. The active portion of the sediment-water interface was found to extend an average of only 2 mm into the sediment profile.
18. Sediment surface area, oxidation-reduction state, and water column nutrient concentration were the major factors affecting the transfer between sediment and water.
19. The sediments of the Niagara Impoundment tend to redistribute the annual nutrient load entering from the Roanoke River Basin, raising the outflow concentrations during the critical summer months, and thereby contributing to water quality degradation in Smith Mountain Lake.
20. Effective reduction of nitrogen and phosphorus oversupply to Smith Mountain Lake could be achieved by maintaining aerobic benthic conditions in the Niagara Impoundment.

VII. LITERATURE CITED

- ✓1. Fruh, E. G., "The Overall Picture of Eutrophication." Journal of the Water Pollution Control Federation, 39, 1449, (1967).
- ✓2. Sawyer, C. N., "Fertilization of Lakes by Agricultural and Urban Drainage." Journal New England Water Works Association, 61, 109, (1947).
3. Hutchison, G. E., "Eutrophication." American Science, 61, 269, (1973).
4. Jaworski, N. A., Villa, O., and Hetling, L. J., "Nutrients in the Potomac River Basin." Proceedings, 24th Conference on Industrial Wastes, Purdue University, Lafayette, Indiana, (1969).
5. Interim Report, Occoquan/Four Mile Run Non-Point Source Correlation Study, Northern Virginia Planning District Commission and Department of Civil Engineering, V.P.I. & S.U. (1977).
- ✓6. Randall, C. W., Grizzard, T. J., and Hoehn, R. C., "Monitoring for Water Quality Control in the Occoquan Watershed of Virginia, USA," Proceedings, International Workshop on Instrumentation and Control for Water and Wastewater Treatment and Transport Systems, International Association on Water Pollution Research, London-Stockholm, (1977).
- ✓7. Colston, N. V., Characterization and Treatment of Urban Land Runoff. Doc. No. EPA-670/2-74/096, U.S.E.P.A., (1974).
8. Water Resources Data for Virginia, United States Department of the Interior, Geological Survey, Richmond, Va., (1970).
9. Bell, John S., "Report on the Proposed Hydroelectric Development on the Roanoke River at Niagara, Virginia," Master's Thesis, V.P.I., (1945).
10. Grizzard, T. J. and Jennelle, E. M. "Will Wastewater Treatment Stop Eutrophication of Impoundments." Proceedings, 27th Conference on Industrial Wastes, Purdue University, Lafayette, Indiana, (1972).
- ✓11. Martin, E. J. and Weinbarger, L. W., "Eutrophication and Water Pollution." Publication No. 15, Great Lakes Research Division, University of Michigan, 451, (1966).
12. "Liebig and After Liebig." Publication No. 18, American Association for the Advancement of Science, Washington, D. C., (1942).

13. Weiss, Charles, "The Relative Significance of Phosphorus and Nitrogen as Algal Nutrients." Report No. 34, Water Resources Research Institute, University of North Carolina, Chapel Hill, North Carolina, (1970).
- ✓14. Sylvester, R. O., "Nutrient Content in drainage from Forested, Urban, and Agricultural Areas." in Algae and Metropolitan Wastes, R. A. Taft Sanitary Engineering Center, Cincinnati, Ohio, (1961).
15. Ruttner, Franz, Fundamentals of Limnology, p. 191, University of Toronto Press, Toronto, Canada, (1953).
16. Wetzel, R. G., Limnology, p. 42, W. B. Saunders Co., Philadelphia, Penn., (1975).
17. Buckman, H. O. and Brady, N. C., The Nature and Properties of Soils, pp. 222-226, The Macmillan Co., London, England, (1969).
18. Sedimentation Engineering. American Society of Civil Engineers, pp. 2-15, (1975).
19. Randall, C. W. and Grizzard, T. J. "The Occoquan Quarterly," 4, No. 2, 1976.
20. First Quarterly Report, Occoquan/Four Mile Run Non-Point Source Correlation Study, Northern Virginia Planning District Commission and Department of Civil Engineering, V.P.I. & S.U., (1977).
21. Steel, E. W., Water Supply and Sewage, p. 446, McGraw-Hill Book Co., New York, N. Y., (1960).
22. Syers, J. K., Harris, R. F, and Armstrong, D. E., "Phosphate Chemistry in Lake Sediments." Journal, Environmental Quality, 2, 1, (1973).
23. Fillos, J. and Biswas, H., "Phosphate Release and Sorption by Lake Mohigan Sediments." Journal, Environmental Engineering Division, ASCE, 102, 239, (1976).
24. Hooper, F. F. and Elliott, A. M., "Release of Inorganic Phosphorus from Extracts of Lake Mud by Protozoa." Transactions American Microscopic Society, 72, 276, (1953).
- ✓25. Williams, J. D. H.; Syers, J. K.; Shukla, S. S.; and Harris, R. F., "Levels of Inorganic and Total Phosphorus in Lake Sediments as Related to other Sediment Parameters." Environmental Science and Technology, 5, p. 1113, (1971).
- ✓26. Hsu, P. H., "Fixation of Phosphate by Aluminum and Iron in Acidic Soils." Soil Science, 99, p. 398, (1965).

27. Frink, C. R., "Chemical and Mineralogical Characteristics of Eutrophic Lake Sediments." Soil Science Society of America, Proceedings, 33, 369, (1969).
28. Frink, C. R., "Nutrient Budget: Rational Analysis of Eutrophication in a Connecticut Lake." Environmental Science and Technology, 1, 425, (1967).
29. Delfino, J. C.; Bortleson, G. C.; and Lee, G. F., "Distribution of Mn, Fe, P, Mg, K, Na, and Ca in the Surface Sediments of Lake Mendota, Wisconsin." Environmental Science and Technology, 3, 1189, (1969).
30. Serruya, C., "Lake Kinneret: The Nutrient Chemistry of the Sediments." Limnology and Oceanography, 16, 510, (1971).
31. Bortleson, G. C., and Lee, G. F., "Recent Sedimentary History of Lake Mendota, Wis." Environmental Science and Technology, 6, 799, (1972).
32. Sridharan, N. and Lee, G. F., "Phosphorus Studies in Lower Green Bay, Lake Michigan." Journal Water Pollution Control Federation, 46, 684, (1974).
33. Shapiro, J.; Edmondson, W. T.; and Allison, D. E., "Changes in the Chemical Composition of Sediments of Lake Washington, 1958-1970." Limnology and Oceanography, 16, 437, (1971).
34. Livingston, D. A. and Boykin, J. C., "Vertical Distribution of Phosphorus in Linsley Pond Mud." Limnology and Oceanography, 7, 57, (1962).
35. Keeney, D. R.; Konrad, J. G.; and Chesters, G., "Nitrogen Distribution in Some Wisconsin Lake Sediment." Journal Water Pollution Control Federation, 42, 411, (1970).
36. Kemp, A. L. W., and Mudrochova, A., "Distribution and Forms of Nitrogen in a Lake Ontario Sediment Core." Limnology and Oceanography, 17, 855, (1972).
37. Chen, R. L.; Keeney, D. R.; Konrad, J. G.; Holding, A. J., and Graetz, D. A., "Gas Production in Sediments of Lake Mendota, Wisconsin," Journal Environmental Quality, 1, 155, (1972).
38. Konrad, J. G.; Keeney, D. R.; Chesters, G.; and Chen, K., "Nitrogen and Carbon Distribution in Sediment Cores of Selected Wisconsin Lakes." Journal Water Pollution Control Federation, 42, 2094, (1970).
39. Mortimer, C. H., "The Exchange of Dissolved Substances Between Mud and Water." Journal of Ecology, 29, 280, (1941).

- ✓40. Wiklander, L., "Cation and Anion Exchange Phenomena." in Chemistry of the Soil, Van Nostrand Reinhold Co., New York, N.Y., (1964).
- ✓41. Harter, R. D., "Phosphorus Adsorption Sites in Soils." Soil Science Society of America Proceedings, 33, 630, (1969).
42. McKee, G. D.; Parrish, L. P.; Hirth, C. R.; MacKenthun, K. M.; and Keup, L. E., "Sediment-Water Nutrient Relationships." Water and Sewage Works, 203, (July, 1970).
43. Kramer, J. R.; Herbes, S. E.; and Allen, H. E., "Phosphorus: Analysis of Water Biomass and Sediment," in Nutrients in Natural Waters, pp. 85-87, John Wiley & Sons, New York, N. Y., (1972).
44. Weir, C. C. and Soper, R. J., "Adsorption and Exchange Studies of Phosphorus in Some Manitoba Soils." Canadian Journal Soil Science, 42, 31, (1962).
45. Harter, R. D., "Adsorption of Phosphorus by Lake Sediment." Soil Science Society of America Proceedings, 32, 514, (1968).
46. Williams, J. D. H., Syers, J. K., and Harris, R. F., "Adsorption and Desorption of Inorganic Phosphorus by Lake Sediments in a 0.1 M. NaCl System." Environmental Science and Technology, 4, 517, (1970).
47. Shukla, S. S.; Syers, J. K.; Williams, J. D. H.; Armstrong, D. E.; and Harris, R. F., "Sorption of Inorganic Phosphorus by Lake Sediments." Soil Science Society of America Proceedings, 35, 244, (1971).
48. Hayes, F. R.; McCarter, J. A.; Cameron, M. L.; and Livingston, D. A., "On the Kinetics of Phosphorus Exchange in Lakes." Journal of Ecology, 40, 202, (1952).
49. Tandon, H. L. S., and Kurtz, L. T., "Isotopic Exchange Characteristics of Aluminum- and Iron-Bound Fractions of Soil Phosphorus." Soil Science Society of America Proceedings, 32, 799, (1968).
50. Einsele, W., Arch. Hydrobiologica Plankt., 33, 361, (1938), quoted in Mortimer (39).
51. Li, W. C. and Armstrong, D. E., "Measurement of Exchangeable Inorganic Phosphorus in Lake Sediments." Environmental Science and Technology, 7, 455, (1973).
- ✓52. Tisdale, S. L. and Nelson, W. L., Soil Fertility and Fertilizers, pp. 199-202, Macmillan Publishing Co., New York, N. Y., (1975).
- ✓53. Jackman, R. H. and Black, C. A., "Solubility of Iron, Aluminum,

Calcium, and Magnesium Inositol Phosphates at Different pH Values." Soil Science, 80, 179, (1951).

54. Keeney, D. R., "The Nitrogen Cycle in Sediment-Water Systems." Journal Environmental Quality, 2, 15, (1973).
55. Brezonick, P. L. and Lee, G. F., "Denitrification as a Nitrogen Sink in Lake Mendota." Environmental Science and Technology, 2, 120, (1968).
56. Patrick, W. H. and Mikkelsen, D. S., "Plant Nutrient Behavior in Flooded Soils." in Fertilizer Technology and Use, pp. 201-203, Soil Science Society of America, (1971).
- ✓57. Abbott, W., "Microcosm Studies on Estuarine Waters I. The Replicability of Microcosms." Journal Water Pollution Control Federation, 38, 258, (1966).
58. Zicker, E. L. and Berger, K. C., "Phosphorus Release from Bog Lake Muds." Limnology and Oceanography, 1, p. 296, (1956).
59. Macpherson, L. B.; Sinclair, N. R., and Hayes, F. R., "The Effect of pH in the Partition of Inorganic Phosphate Between Water and Oxidized Mud or its Ash." Limnology and Oceanography, 3, 318, (1958).
60. Fitzgerald, G. P., "Aerobic Lake Muds for the Removal of Phosphorus from Lake Waters." Limnology and Oceanography, 15, 550, (1970).
61. Harrison, M. J.; Pacha, R. E.; and Morita, R. Y., "Solubilization of Inorganic Phosphorus by Bacteria Isolated from Upper Klamath Lake Sediment." Limnology and Oceanography, 17, 50, (1972).
62. Kimmel, B. I. and Lind, O. T., "Factors Influencing Orthophosphate Concentration Decline in the Water of Laboratory Mud-Water Systems." Texas Journal of Science, 21, 439, (1970).
63. Hannah, R. P.; Simmons, A. T.; and Moshiri, G. A., "Nutrient-Productivity Relationships in a Bay of Estuary." Journal Water Pollution Control Federation, 45, 2508, (1973).
- ✓64. Fillos, J. and Swanson, W. R., "Effect of Benthic Deposits on the Quality of Natural Waters." preprint, Third Annual Environmental Engineering and Science Conference, Louisville, Ky., (1973).
65. Byrnes, B. H.; Keeney, D. R.; and Graetz, D. A., "Release of Ammonium-N from Sediments to Waters." Proceedings 15th Conference on Great Lakes Research, 249, (1972).

66. Chen, R. L.; Keeney, D. R.; Graetz, D. A.; and Holding, A. J., "Dentrification and Nitrate Reduction in Wisconsin Lake Sediments." Journal Environmental Quality, 1, 158, (1972).
67. Austin, E. R. and Lee, G. F., "Nitrogen Release from Lake Sediments." Journal Water Pollution Control Federation, 45, 870, (1973).
68. Hynes, H. B. N. and Greib, B. J., "Experiments on Control of Release of Phosphate from Lake Muds." Proceedings, Tenth Conference on Great Lakes Research, (1967).
69. Standard Methods for the Examination of Water and Wastewater, 13 edition, American Public Health Association, New York, N. Y., (1971).
70. Chang, S. C. and Jackson, M. L., "Fractionation of Soil Phosphorus." Soil Science, 84, 133, (1958).
71. Petersen, G. W. and Corey, R. B., "A Modified Chang and Jackson Procedure for Routine Fractionation of Inorganic Soil Phosphorus." Soil Science Society of America Proceedings, 30, 563, (1966).
72. Williams, J. D. H.; Syers, J. K.; and Walker, T. W., "Fractionation of Soil Inorganic Phosphorus by a Modification of Chang and Jackson's Procedure." Soil Science Society of America Proceedings, 31, 736, (1967).
73. Instruction Manual - Ammonia Electrode Model 95-10, Orion Research, Inc., Cambridge, Mass., (1972).
74. Instruction Manual - Nitrate Electrode Model 92-10, Orion Research, Inc., Cambridge, Mass., (1972).
75. Analytical Methods for Atomic Absorption Spectrophotometry, Perkin-Elmer Corp., Norwalk, Conn., (1972).
76. Fishman, M. J., "Determination of Aluminum in Water." Atomic Absorption Newsletter, 11, 46, (1972).
77. Methods of Soil Analysis, Part I, American Society of Agronomy, Madison Wisc., (1965).
78. Heese, P. R., A Textbook of Soil Chemical Analysis, John Murray, London, (1971).
79. Williams, J. D. H.; Syers, J. K.; Armstrong, D. E.; and Harris, R. F., "Characterization of Inorganic Phosphate in Noncalcareous Lake Sediments." Soil Science Society of America Proceedings, 35, 556, (1971).

80. Banwart, W. L.; Tabatabai, M. A.; and Bremner, J. M., "Determination of Ammonium in Soil Extracts and Water Samples by an Ammonia Electrode," Communications in Soil Science and Plant Analysis, 3, 450, (1972).
81. Bremner, J. M. and Tabatabai, M. A., "Use of an Ammonia Electrode for Determination of Ammonium in Kjeldahl Analysis of Soils." Communications in Soil Science and Plant Analysis, 3, 159, (1972).
- √82. Shocmaker, D. P. and Garland, C. W., Experiments in Physical Chemistry, McGraw-Hill Book Co., New York, N. Y., (1967).
83. Andrews, D. H., Introductory Physical Chemistry, p. 280, McGraw-Hill Book Co., New York, N. Y., (1970).
84. Weber, W. J., Physicochemical Processes for Water Quality Control, Wiley - Interscience, New York, N. Y., (1972).
85. Langmuir, I., "The Adsorption of gases on Plane Surfaces of Glass, Mica, and Platinum." Journal American Chemical Society, 40, 1316, (1918).
86. Freundlich, H., Colloid and Capillary Chemistry, Methuen and Co., Ltd., London, (1926).
87. Manual of Steel Construction, American Institute of Steel Construction, New York, N. Y., (1967).
88. Pruhs, R. A., Personal Communication: U. S. Army Engineer District, Norfolk.

VIII. VITA

Thomas Jefferson Grizzard, Jr. was born in Richmond, Virginia on August 23, 1946. He received his primary and secondary education in the Richmond Public School System, graduating from Thomas Jefferson High School in June, 1964. He entered Virginia Polytechnic Institute in September, 1964, and completed requirements for the B. S. degree in Civil Engineering in July, 1968. The author subsequently accepted a position with the Norfolk District of the U. S. Army Corps of Engineers, which he held until September 1970, at which time he left to enroll in the Sanitary Engineering graduate program at Virginia Polytechnic Institute and State University. After receiving the M. S. degree in 1972, the author elected to pursue the Ph.D. degree in Civil Engineering, which he is currently completing. In the interim, the author has been employed as Director of the Occoquan Watershed Monitoring Laboratory in Manassas, Virginia. He is a licensed professional engineer in the Commonwealth of Virginia, and is listed in Who's Who in Virginia, 1975. In the past four years, he has authored or co-authored ten scientific and engineering publications.

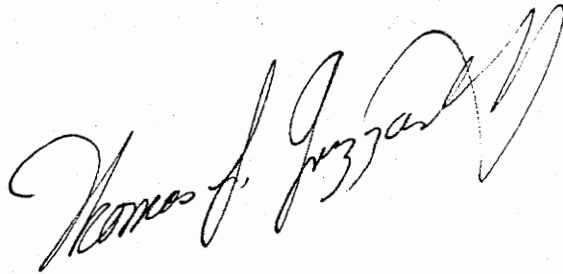
A handwritten signature in black ink, reading "Thomas J. Grizzard, Jr.", written in a cursive style.

OBSERVATIONS AND IMPLICATIONS OF SEDIMENT-WATER
INTERACTIONS IN THE NIAGARA IMPOUNDMENT
OF SOUTHWEST VIRGINIA

by

Thomas J. Grizzard, Jr.

(ABSTRACT)

A program of in situ and laboratory studies was conducted to elucidate the role of the deposited sediments of the Niagara Reservoir in affecting the quality of the flow of the Roanoke River above the headwaters of Smith Mountain Lake. Agronomic analysis techniques were adapted and applied to provide quantitative analysis capability for the sediments.

The surficial sediments were observed to constitute a considerable reservoir of nitrogen and phosphorus, which, during the anoxic bottom conditions occurring during the summer months, caused an enhancement of concentrations in the water column. Conversely, during the winter months, the surficial sediments acted as a phosphorus and nitrogen sink, removing both materials from the water column.

Laboratory batch and microcosm studies made it possible to quantify the release and removal of nitrogen and phosphorus under aerobic and anaerobic conditions, and to elucidate the factors upon which the exchanges depended.

The phosphorus interactions were found to be governed principally by sediment iron and organic matter content. Under aerobic conditions, phosphorus adsorption could be described by the Langmuir Isotherm. The most important nitrogen release mechanism was found to be a cation exchange phenomenon under reducing conditions.

Although the effective zone of exchange was found to extend only about 2 mm into the sediment surface, the analysis of cores showed the existing profile to be rich in both phosphorus and nitrogen forms, which could be exposed to the water column with sufficient mixing.

The deposited sediments of Niagara Impoundment showed a capacity to redistribute the impoundment influent nutrient load, causing an enhancement of the quantities released during the summer months, thus magnifying the impact on the waters of Smith Mountain Lake. The maintenance of aerobic benthic conditions could, at a tremendous energy cost, prevent the sediment releases from occurring. In the long term, sediment nutrients deposited in the past, without proper control, could provide a continuing source of N and P to the waters of Smith Mountain Lake, thereby reducing the effectiveness of upstream control of point and diffuse sources.