

**ANALYSIS OF WOOD PULP EXTRACTS  
UTILIZING GAS CHROMATOGRAPHY-MASS SPECTROSCOPY**

by

Anna J. Sequeira (Queenie)

Dissertation submitted to the Faculty of the  
Virginia Polytechnic Institute and State University  
in partial fulfillment of the requirements for the degree of  
DOCTOR OF PHILOSOPHY  
in  
Chemistry

APPROVED:

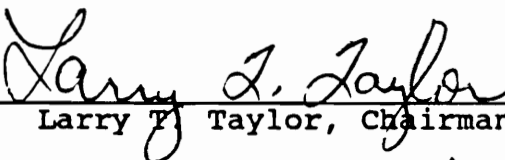
  
Larry T. Taylor, Chairman

  
Mark R. Anderson

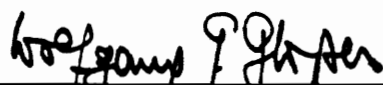
  
Wolfgang G. Grassler

  
John G. Mason

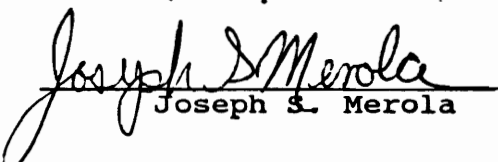
  
Joseph S. Merola

July, 1991

Blacksburg, Virginia

**ANALYSIS OF WOOD PULP EXTRACTS  
UTILIZING GAS CHROMATOGRAPHY-MASS SPECTROSCOPY**

by

ANNA J. SEQUEIRA (QUEENIE)

Committee Chairman: Larry T. Taylor  
Department of Chemistry

(ABSTRACT)

Wood pulp mill effluents continue to attract much attention due to environmental consequences. However, in comparison, very little work has been published on wood pulp extracts themselves.

In this investigation, chemithermomechanical (CTMP) pulps as well as Kraft (BKP) pulps were Soxhlet extracted with solvents of different polarity. These two types of pulp extracts were then compared qualitatively using GC-FID and GC-MSD as well as quantitatively based on the percent of extractives obtained. For all the pulps studied, the percent extractives of water > ethyl acetate > cyclohexane. The CTMP extracts exhibited many more components as compared to BKP extracts for all the extractions solvents. The presence of trace chlorinated phenolics in the above wood pulp extracts was also addressed utilizing GC-ECD, GC-EIMS and GC-NCIMS. 4-MCG, 4,5-DCG, 4,5,6-TCG, 3,4,5-TCG, 2,4,6-TCP, 2,3,4,6-TeCP, PCP and 6-MCVN were discovered. Due to a lack of knowledge of the complete history of the wood pulps studied, the exact causes for their discoveries are unknown.

Attempts were also made to study the feasibility of Supercritical Fluid Extraction of the above mentioned wood pulps due to the difficulties faced with Soxhlet extractions. The percent extractives obtained using SF-CO<sub>2</sub> and cyclohexane were found to be comparable.

## **ACKNOWLEDGEMENTS**

I would like to thank profoundly Prof. L. T. Taylor for his guidance, concern and patience with me. Thanks are also extended to Profs. M. R. Anderson, W. G. Glasser, J. G. Mason and J. S. Merola for being everwilling to preside on my committee and most obliging when approached for any favour or guidance with my research. Special thanks to Carol Haney for aiding me in the high resolution mass spectroscopy work at North Carolina State University, Raleigh, Kim Harich who operates the high resolution mass spectrometer for Virginia Tech, Dr. C. W. Saunders and Dr. J. Rancourt for the valuable discussions and suggestions, Mrs. K. Castagnoli and Dr. L. Hall for letting me use their facilities, and my research group members who have in one way or another influenced my research work. My gratitude also goes to Procter and Gamble, Memphis, TN, for awarding me the Fellowship and the financial assistance that made most of this work possible. I would also like to acknowledge my mother Mrs. R. Saldanha who is no more, but who instilled in me right from young, the value of higher education. Last but not the least, I would like to thank my husband Donald who has stood by me through 'thick and thin' and who 'has held the fort' for the last three and half years, as well as my two sons, Russel and Marlon who have tried to be as cooperative as possible.

**TABLE OF CONTENTS**

**1.0 Chapter 1: Introduction and Research Objective.....1**

1.1 Introduction .....1

1.2 Research Goal.....13

**2.0 Chapter 2: A Comparative Study of CTMP and Kraft Wood  
Pulp Extracts.....15**

2.1 Introduction .....15

2.2 Experimental .....18

    2.2.1 Soxhlet Extraction Procedure .....20

    2.2.2 Analysis by GC/FID and GC/MSD .....22

2.3 Results and Discussion .....25

**3.0 Chapter 3: Identification and Quantification of  
Chlorinated Phenolics by GC/TVSMIM Mass  
Spectra .....43**

3.1 Introduction .....43

3.2 Experimental .....45

    3.2.1 GC/ECD .....49

    3.2.2 GC/TVSMIM .....49

3.3 Results and Discussion .....51

**4.0 Chapter 4: GC/NCIMS of Chlorinated Compounds in Wood  
Pulp Extracts .....68**

4.1 Introduction .....68

4.2 Experimental.....71

4.2.1 GC/EIMS.....	72
4.2.2 GC/NCIMS.....	74
4.3 Results and Discussion .....	76
<b>5.0 Chapter 5: SFE of Wood Pulps.....</b>	<b>96</b>
5.1 Introduction .....	96
5.2 Experimental .....	98
5.2.1 SFE Procedure.....	100
5.3 Results and Discussion .....	105
<b>6.0 Chapter 6: Conclusions &amp; Future Work.....</b>	<b>119</b>
<b>7.0 Chapter 7: References.....</b>	<b>121</b>
<b>Vita .....</b>	<b>129</b>
<b>Presentations.....</b>	<b>130</b>
<b>Publications.....</b>	<b>131</b>

## LIST OF ILLUSTRATIONS

Figure 1.	Prominent structures in softwood lignin.....	3
Figure 2.	Kraft pulp mill with a conventional bleach plant.....	6
Figure 3.	Peroxide bleaching process.....	10
Figure 4.	Reactions between residual lignin in pulp and chlorine.....	12
Figure 5.	Procedure for Soxhlet extraction.....	21
Figure 6.	Procedure for concentrating and drying of the extracts.....	23
Figure 7.	GC/FID of CTMP-II cyclohexane extract.....	29
Figure 8.	GC/FID of UBKP-I cyclohexane extract.....	30
Figure 9.	GC/FID of BKP-I cyclohexane extract.....	31
Figure 10.	GC/MS of CTMP-I ethyl acetate extract.....	32
Figure 11.	GC/MS of BKP-I ethyl acetate extract.....	33
Figure 12.	GC/MS of CTMP-II water extract.....	39
Figure 13.	GC/MS of BKP-I water extract.....	40
Figure 14.	GC/ECD of CTMP-I ethyl acetate extract.....	53
Figure 15.	GC/ECD of UBKP-I ethyl acetate extract.....	54
Figure 16.	GC/ECD of BKP-I ethyl acetate extract.....	55
Figure 17.	Time varied selected multiple ions mass spectrum of UBKP-I water extract.....	58
Figure 18.	EICs of mass ions 158 & 160 amu from UBKP-I water extract.....	59
Figure 19.	Time varied selected multiple ions mass spectrum of BKP-II water extract.....	60

Figure 20. Time varied selected multiple ions mass spectrum of CTMP-I ethyl acetate extract.....	61
Figure 21. EICs of mass ions 196, 198 & 200 amu from CTMP-I ethyl acetate extract.....	62
Figure 22. SIM mass spectrum of BKP-II water extract by GC/EIMS.....	77
Figure 23. SIM mass spectrum of CTMP-I ethyl acetate extract.....	78
Figure 24a. EICs of mass ions 196 & 198 amu from BKP-III ethyl acetate extract by GC/NCIMS.....	86
Figure 24b. TIC of BKP-III ethyl acetate extract by GC/NCIMS.....	86
Figure 25. Mass spectrum of 2,4,6-TCP found in BKP-III ethyl acetate extract.....	87
Figure 26. Mass spectrum of Other-TCG in BKP-I water extract.....	90
Figure 27. Mass spectrum of 2,3,4,6-TeCP in BKP-I water extract.....	92
Figure 28. Mass spectrum of unidentified monochloro compound in BKP-III ethyl acetate extract.....	94
Figure 29. Schematic of HP 7680A Supercritical Fluid Extractor.....	99
Figure 30. SFE conditions.....	101
Figure 31. SFE procedure.....	103
Figure 32. Procedure for drying.....	104
Figure 33. TIC of CTMP-100% SF-CO <sub>2</sub> .....	111
Figure 34. TIC of BKP-100% SF-CO <sub>2</sub> .....	112
Figure 35. TIC of CTMP-2% MeOH modified SF-CO <sub>2</sub> .....	115
Figure 36. TIC of BKP-2% MeOH modified SF-CO <sub>2</sub> .....	116



## LIST OF TABLES

Table 1.	Background of Pulps Studied.....	19
Table 2.	Percent Extractives per Air Dried Wood Pulp.....	26
Table 3.	Major Peak Assignments for Select Extracted Wood Pulp Components.....	34
Table 4.	Chlorinated Phenolic Standards.....	46
Table 5.	Time Varied Selected Multiple Ions Monitored....	48
Table 6.	Chlorinated Phenolics found in Water and Ethyl Acetate Extracts by GC/EIMS.....	63
Table 7.	Quantification of Chlorinated Phenolics Found via GC/EIMS.....	66
Table 8.	Time Varied Selected Ions Monitored by GC/EIMS.....	73
Table 9.	Model Chlorinated Compounds.....	75
Table 10.	Unknown Chlorine-Containing Parent/Fragment Ions found in Water Extracts via Time Varied Selected Ion Monitoring.....	80
Table 11.	Unknown Chlorine-Containing Parent/Fragment Ions found in Ethyl Acetate Extracts via Time Varied Selected Ion Monitoring.....	81
Table 12.	Identification of Chlorinated Compounds by GC/EIMS and GC/NCIMS.....	89
Table 13.	SFE Results using 100% CO <sub>2</sub> .....	108
Table 14.	SFE Results with SF-CO <sub>2</sub> modified with 2% MeOH.....	114

## **1.0 CHAPTER 1: INTRODUCTION AND RESEARCH OBJECTIVE**

### **1.1 INTRODUCTION**

Wood is by far the most important raw material for the production of pulp. It can be classified according to its origin or according to the process of manufacture (1).

Based on its origin, wood is classified into two categories:

a) softwoods, for example pines, balsams, spruces, firs and hemlocks or b) hardwoods, for example yellow birch, beech, oaks, maples, yellow poplar, aspen, cottonwood, magnolias, gums etcetra. In this investigation pulps originating only from softwoods were used. Depending on their process of manufacture, wood pulps can be classified as a) mechanical and b) chemical pulps. For this research, a comparison of Chemithermomechanical (CTMP) pulps with Kraft (Sulphate) pulps was made.

#### **General Wood Pulp Characteristics**

Mechanical pulps have usually been used for their excellent absorbency, bulk and compressibility (1). They have a low shive content, good biodegradable properties and are reasonably cheap. Besides they have a high pulp yield which is mainly because the lignin is hardly removed from the wood.

Chemical pulps, on the other hand, exhibit excellent strength and more colour permanence. Substantial amounts of bark are tolerated in the chips. Their cooking times are shorter than in CTMP pulps and pitch problems are less prevalent. An additional advantage is that the recovery process for spent liquors is well established and valuable by-products are obtained. A great disadvantage of Kraft pulping is the strong odours that emerge from mill effluents mainly due to  $H_2S$ ,  $CH_3SH$ ,  $CH_3SCH_3$  and  $CH_3SSCH_3$ .

The main component groups of wood are cellulose, hemicelluloses, lignin, extractives and mineral matter (2). Cellulose is a linear polysaccharide consisting of  $\beta$ -D-glucopyranose units, which are linked by (1-4)-glucosidic bonds. Wood cellulose in its native state consists of at least 10,000 anhydro glucose units. Hemicelluloses are composed of different carbohydrate units and are branched to various extents. Their molecular masses (degree of polymerization on the order of 200) are much lower than that of cellulose. The content and types of hemicellulose in softwoods differ considerably from those in hardwoods (3).

Lignin is essentially an aromatic polymer. It is formed in wood by an enzyme-initiated dehydrogenative polymerization of a mixture of 3 different 4-hydroxyarylpropenyl alcohols (4). The proportions of these alcohols vary with different wood species. Softwood lignin is largely a polymerization product of coniferyl alcohol. Figure 1 depicts a summary of prominent structures

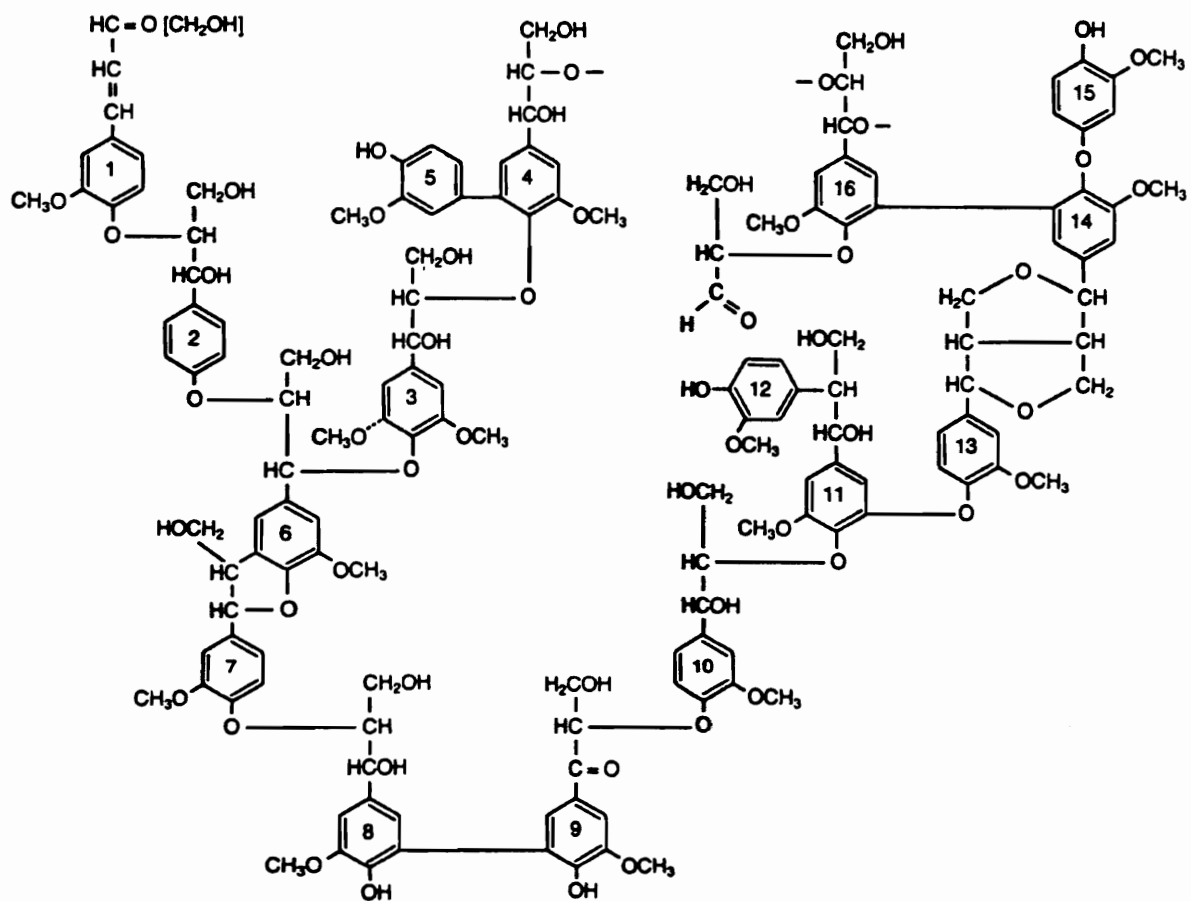

(Source: Ref. 3)

**Figure 1. Prominent structures in softwood lignin.**

in such a lignin as suggested by Adler (4). This scheme indicates only 16 monomeric units without all the structural details. However, it shows that softwood lignin is a branched molecule in which the phenylpropane-based units are linked by different types of bonds. These include ether bonds of alkyl-aryl, alkyl-alkyl and aryl-aryl configurations as well as various types of carbon-carbon bonds. The typical functional groups found in softwood lignins are primary and secondary hydroxyl, free phenolic hydroxyl, ether and various types of carbonyl groups.

All wood contains small amounts of mineral constituents that appear in the ash. Some are essential elements in plant growth, while others appear to be carried along with other soluble material from the soil. The most important cations are those of potassium, calcium and magnesium, but 50 or more elements may be found in trace quantities.

The term 'extractives' is normally used for those components of wood that can be extracted by organic solvents. These were the focal point of our investigation. They include a variety of compounds that may be subdivided into aliphatic extractives consisting mainly of fats and waxes; terpenoid compounds (present only in softwoods) to which class a number of mono-, di- and sesquiterpenes, as well as various resin acids belong; and phenolic extractives, which include hydrolyzable tannins, tropolines, flavonoids, lignans and stilbenes (5).

## Principles of Pulping

The two methods of pulping that are of relevance to this investigation are (1) Chemithermomechanical Pulping (CTMP) process and (2) Kraft (Sulphate) process.

The CTMP process is a relatively new process originating in the late 1950's. Here, the wood chips are first softened by impregnating them with sodium sulphite ( $\text{Na}_2\text{SO}_3$ ) that has been adjusted to a pH of 9-10 with sodium hydroxide. Next, the chips are pretreated in a steaming vessel to 130-170°C and then refined in a steam pressurized or atmospheric disk refiner. Refining involves two basic steps: a) Fiberization (Defibration) which converts the original wood structure into single fibres and b) Fibrillation, which reduces a portion of the fibres into cell-wall fragments. These refined chips are then screened and cleaned giving the unbleached CTMP pulp (6). A variation in the properties of the above pulp can be achieved by varying the preheating temperature, amount of  $\text{Na}_2\text{SO}_3$  consumed, energy input in a refiner or the steaming time.

The Kraft process is a chemical pulping process, in use since 1879 and which is widely used today (7). Figure 2 depicts a typical Kraft mill process including a conventional bleach plant. As opposed to the CTMP process above, it serves to remove the lignin in order to facilitate fibre separation and to improve the papermaking properties of the fibres. The process involves treating wood chips at

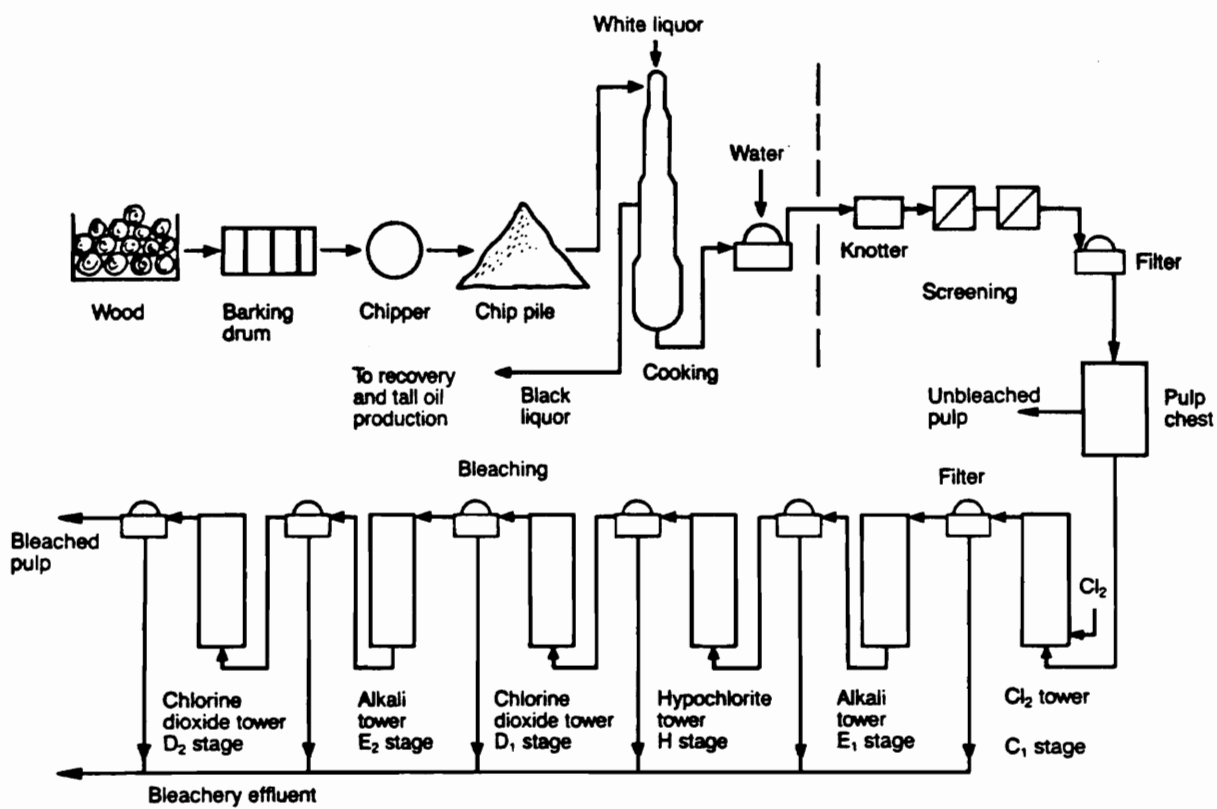

(Source: Ref. 7)

**Figure 2. Kraft pulp mill process with a conventional bleach plant.**

160-180°C with a liquor that contains NaOH and Na<sub>2</sub>S.

Therefore the main reaction in the Kraft pulping process is the hydrolysis of Na<sub>2</sub>S in water as follows:

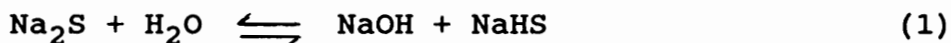

This equilibrium is very rapidly established. Hence the effective alkali in Kraft pulping is NaOH +  $\frac{1}{2}$  Na<sub>2</sub>S (7). This promotes cleavage of the various ether bonds in the lignin. These lignin degradation products so formed dissolve in the alkaline pulping liquor. Depending on pulping conditions, as much as 90-95% of the lignin is removed from wood at this stage. In addition, portions of the wood polysaccharides, specially those of the hemicelluloses are dissolved during the pulping operation due to the fact that cellulose and hemicelluloses are sensitive to alkali through their aldehydic end groups and will thus degrade by a mechanism known as the Peeling reaction (7). Consequently, isosaccharinic acid and a number of other organic acids are formed and dissolved in the pulping liquor.

Wood extractives are also dissolved or dispersed in the kraft pulping liquor. With softwood as the raw material, the extractives are to a large degree recovered as important by-products such as turpentine and tall oil (8). Turpentine contains a mixture of the lower terpenes, whereas raw tall oil consists mainly of fatty and resin acids. The content of residual extractives in unbleached Kraft pulp is low. After separation from the pulp, the spent liquor is



evaporated to a high concentration and then burned to recover energy and inorganic chemicals.

### Principles of Bleaching

The principal objective of bleaching is to whiten and brighten the pulp without damaging its strength characteristics (9). The main light-absorbing substances in wood pulp are derived from the lignin and resin components of the wood. Therefore to make pulp whiter, these substances must either be chemically changed in the solid state to diminish their light absorbing characteristics or be made soluble so that they may be removed in aqueous solution.

The former is the objective of the bleaching of CTMP pulps (without suffering substantial loss of yield) which are mostly bleached by the peroxide process. This process is preferred for major bleaching effects as opposed to sodium hydrosulphite used usually for limited brightness improvement.

### Bleaching Action of Peroxide

The decomposition of hydrogen peroxide is fundamental to this bleaching process (10). The active component in alkaline bleaching with peroxide is hydrogen peroxyanion  $\text{HO}_2^-$ .



with a dissociation constant of  $3.55 \times 10^{-12}$  at  $35^\circ\text{C}$ . Its chemical aspects are discussed in Reference 10 and 11. The flow diagram for a typical peroxide bleaching process is

shown in Figure 3. Sodium silicate ( $\text{Na}_2\text{SiO}_3$ ) has a buffering action in pH ranges where peroxide is most effective. It also serves to inactivate the metal ions. Magnesium sulphate ( $\text{MgSO}_4$ ) is used to stabilize peroxide solution by inhibiting the catalytic effect of  $\text{H}_2\text{O}_2$  decomposition by trace metals such as manganese, copper, nickel, iron, and aluminium. Pentasodium diethylenetriamine pentacetate (DTPA) aids in the removal of metal ions. Generally bleaching is carried out using  $\text{H}_2\text{O}_2$  in NaOH solution for about 2-4 hours at 30-60°C followed by a water dilution to obtain a 3-4% pulp consistency. This oxidative bleaching process has the advantage that the brightness gain is much higher than in the reductive process as well as there is no corrosion of the equipment or pulp degradation. The main disadvantages of the peroxide bleaching are the instability of the bleaching agent and its high price. The decomposition of  $\text{H}_2\text{O}_2$  can be prevented by the addition of stabilizers which generally are not recovered and hence create extra costs.

### Kraft Pulp Bleaching

After the Kraft process, the 5-10% of the original lignin which remains in the pulp is responsible for the dark colour of the Kraft pulp. This calls for a multistage bleaching process (7). For softwood Kraft pulps bleaching is normally accomplished by successive treatments with a mixture of chlorine and chlorine dioxide (C), alkali ( $\text{E}_1$ ), chlorine dioxide ( $\text{D}_1$ ), alkali ( $\text{E}_2$ ) and again chlorine

# PEROXIDE BLEACHING PROCESS

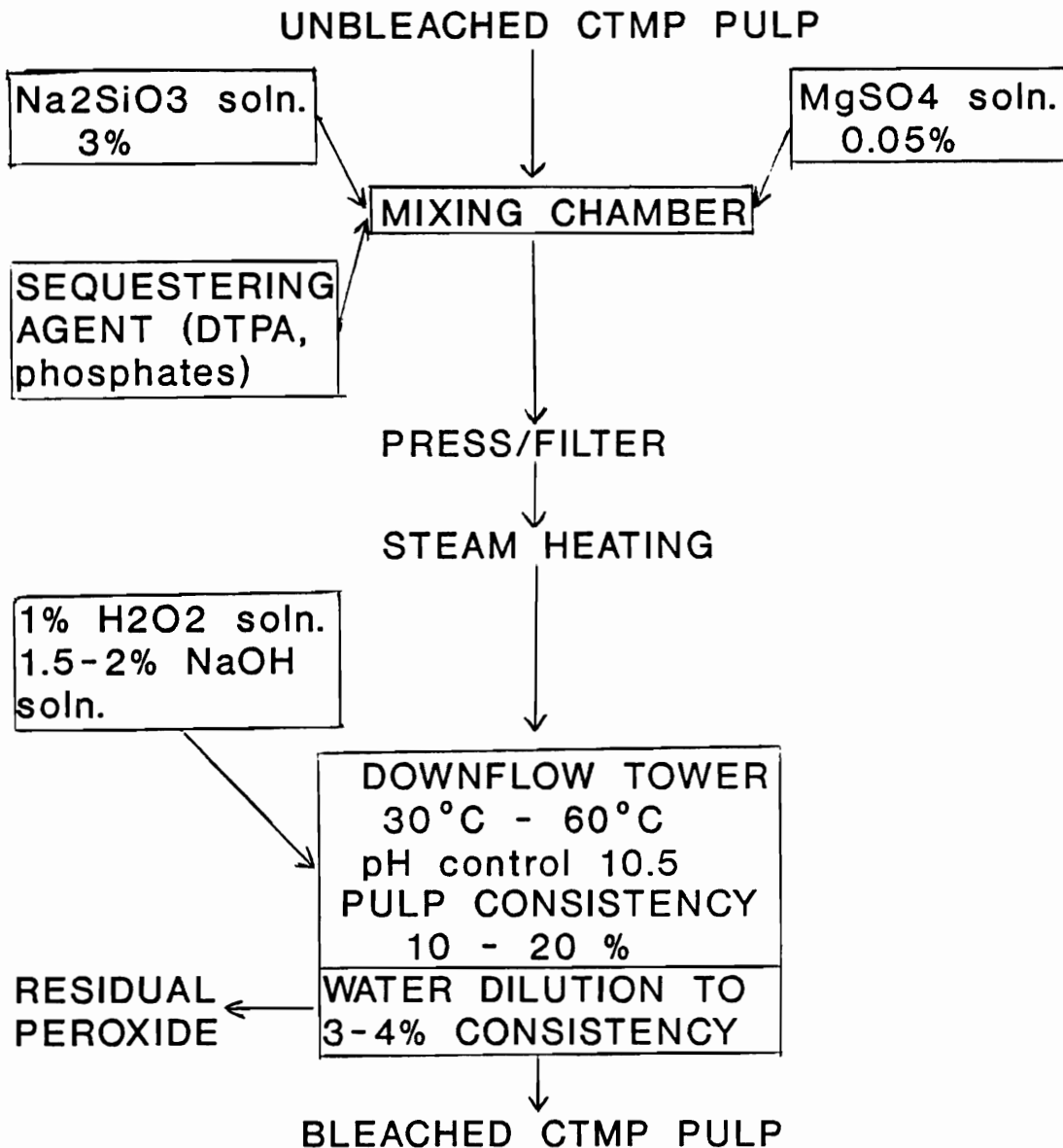
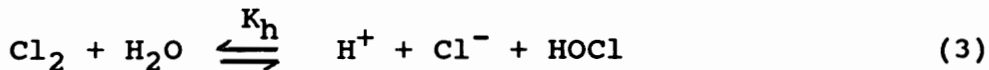

Figure 3. The peroxide bleaching process.

dioxide (D<sub>2</sub>) (Figure 2). Often a hypochlorite stage may be inserted between the E<sub>1</sub> and D<sub>1</sub> stages. Excellent reviews on oxidative bleaching processes can be found in the literature (9,13). The main reactions of chlorine are given below:

When chlorine is dissolved in water, the following equilibria form almost instantaneously.



As the temperature increases, it is observed that the hydrolysis reaction rate (3) also increases. At 25°C, the equilibrium constants are  $K_h = 3.0 \times 10^{-4}$  and  $K_a = 2.9 \times 10^{-8}$ . The equilibrium distribution is affected by the pH of the solution.

At pH = 7.3      [HOCl] ~ [OCl]<sup>-</sup>  
 pH = 1.0      Cl<sub>2</sub> is the dominant component  
 pH = 4.0      the solution contains almost all HOCl  
 pH > 9.0      ~ 100% OCl<sup>-</sup>

Chlorine may react in two different ways with organic material. In one case it reacts as a molecular species and in the other it acts after decomposition into a radical (3). The latter mechanism is believed to be important in reactions with carbohydrates. However during pulp chlorination, chlorine reacts primarily with residual lignin in its molecular form. As summarized in Figure 4, oxidation and substitution by chlorine are important reactions in this

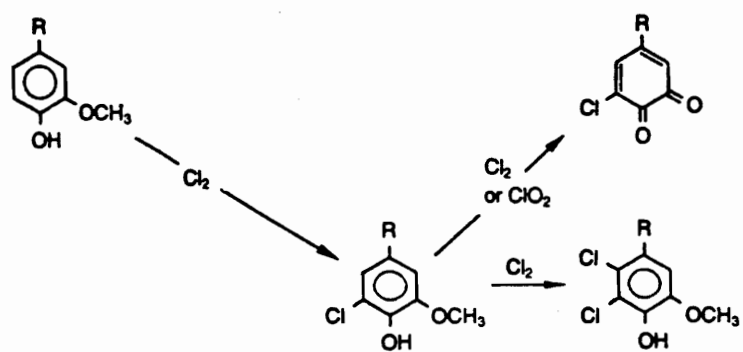

(Source: Ref. 14)

**Figure 4. Reactions between residual lignin in pulp and chlorine.**

stage (14). These reactions lead to a substantial depolymerization of the lignin, as well as to the introduction of chlorine and various acidic groups into its structure. As a result, part of the residual lignin will dissolve in the chlorination liquor. The reactions in the alkali extraction stage  $E_1$  are less understood. Apart from ionizing the acidic groups formed during the C stage, which facilitates the solution of the chlorinated lignin, treatment with alkali will cause a substantial loss of the organically bound chlorine introduced during chlorination (15,16).

## 1.2 RESEARCH GOAL

Today Kraft pulp mills have come under scrutiny by the EPA due to toxic chemicals being released into their waste waters. Chlorinated compounds recovered from various organisms living in these waters were found to possess mutagenic as well as bioaccumulation properties. They were also found to be more generally resistant to biodegradation as compared to non-chlorinated compounds. In addition, the growing environmental awareness and the toxic legacy of dioxins have magnified this problem.

Water was to receive a high priority as an extraction solvent since the finished products from these pulps, for example, tissues, kitchen towels, bathroom rolls, diapers, sanitary napkins, milk cartoons, coffee filters etc. would in the majority of cases come in contact with water rather than other organic solvents.

The predominant wood pulping process in the United States is the Kraft process while the CTMP process is the common pulping process in Europe. Therefore the main goal of this research effort was to compare CTMP to Kraft wood pulp extracts based on percent of extractives obtained as well as on the analysis of the volatile portion of these extracts. This goal was achieved by the following objectives:

1. A comparison of the CTMP and the Kraft pulps extracts obtained by Soxhlet extractions in cyclohexane, ethyl acetate and water.
2. Identification and quantification of trace quantities of chlorinated phenolics in the wood pulp extracts by positive ion electron impact ionization mass spectrometry in the selected ion monitoring mode.
3. Further verification of chlorinated compounds present in the wood pulp extracts using negative ion chemical ionization mass spectroscopy.
4. Supercritical fluid extraction of wood pulps.

## **2.0 CHAPTER 2: A COMPARATIVE STUDY OF CHEMITHERMOMECHANICAL AND KRAFT WOOD PULP EXTRACTS**

### **2.1 INTRODUCTION**

The characterization of wood pulps, like all natural products, is complicated by the complexity and inhomogeneity of the materials. Wood extractives have been found to consist principally of hydrocarbons, alcohols, acids, esters, ketones, lipid substances, waxes, terpenoids and phenolics (2,17,18). Many of these species survive the pulping and bleaching processes and hence are found as wood pulp extractives. The extractive content varies, depending on the pulping process utilized and the method of bleaching employed (5). Furthermore, other factors like the type of tree from which the wood originated, the age of the tree, whether the wood chips were subjected to a pre-hydrolysis step before either pulping or bleaching, the season in which the tree was cut down and if the wood chips were stored before pulping (19) may be important.

Since 1967 there have been a number of articles published on wood extractives as well as pulp mill effluents; but, wood pulp extractives have comparatively received little attention. So far wood pulp extractives



have mainly been studied in order to determine the origin and extent of resin-speck formation as well as color reversion in tropical (20-26) and temperate (27-29) wood Kraft pulps. In another study, Chapman et al. have attempted to examine the non-structural chromophoric substances in a bisulphite pulp (30). Later the gas phase above several pulp samples was analyzed by capillary gas chromatography using Kovats indices (31). In 1967, after stepwise extraction, the resin content of unbleached (UBKP) and bleached pre-hydrolysis Kraft pulp (BKP) was studied. Separation was accomplished on silica gel and subsequent off-line identification by NMR. The UBKP extract contained traces of fatty acids and  $\beta$ -sitosterol; while, the BKP extract contained acids and other oxidized substances. A modified sterol considered to be less hydrophobic than  $\beta$ -sitosterol was also found (32).

The usefulness of thin layer chromatography (TLC) for rapid analysis of non-volatile compounds found in Kraft pulp extractives has been discussed (33). Examples of TLC potential with varying solvent systems were given. In another study involving extractives of Kraft pulps, 14 triterpenoids, 4 steroids and 2 fatty alcohols were isolated by HPLC using a combination of gel permeation, reversed phase and silica gel column (34). Carbon-13 NMR spectroscopy was employed via several pulsed methods to aid in structural identification.

The first studies published regarding the analysis of mechanical pulp extracts by gas chromatography coupled with mass spectroscopy (GC-MS) were as recent as 1989 (35,36). Herein, detailed analysis of the lipophilic and polar pulp extractives was performed using capillary GC-MS. Dichloromethane extraction followed by another extraction with aqueous-acetone (1:9) was performed. The extractant was then derivatized, separated on polymethylsiloxane column with heptadecanoic acid as the internal standard. For all the pulps studied, free and esterified fatty acids, sterols and resin acids together comprised over 80% of all the lipophilic extractive components (35). In study (36), it was discovered that triglycerides, steryl esters, and (free) fatty acids pass through alkaline peroxide bleaching unaltered, while only the conjugated resin acids, lignans, and stilbenes are extensively oxidized or degraded.

From an environmental standpoint, it is of interest to ascertain the nature and abundance of as many compounds present in pulp extracts as possible, bearing in mind that these components occur at low concentrations. To date, the extraction of pulps has been done by either extracting a single sample with different solvents in a stepwise treatment technique (23,25,26,28,32,34) or by performing several extractions with fresh sample of the same pulp each time but with different solvents (20,21,27). The latter method has been adopted in our study of CTMP and Kraft pulps reported here since it was believed that the former

method would be cumbersome, time-consuming and runs the risk of modification of the extractives by virtue of the fact that different solvents would be used with the same pulp sample. Three extracting solvents were selected primarily based on their different solvent strengths with cyclohexane being the least polar ( $\mu \sim 0$  debyes), water being the most polar ( $\mu \sim 1.85$  debyes) and ethyl acetate having an intermediate polarity ( $\mu \sim 1.78$  debyes). Gas chromatography-mass spectroscopy (GC-MS) was next performed on many of the carefully isolated extractant mixtures in order to estimate the chemical differences between volatile components in CTMP and Kraft pulp extracts.

## 2.2 EXPERIMENTAL

The six pulps used for this study are listed in Table 1, together with their backgrounds. CTMP-I and CTMP-II are the pulps bleached by the peroxide process, while BKP-I, BKP-II and BKP-III are pulps bleached by the multistage chlorination process. UBKP-I is the Kraft pulp that was not subjected to the bleaching process.

The extraction solvents used were ethyl acetate, HPLC grade purchased from Burdick & Jackson; cyclohexane, HPLC grade purchased from Fisher Scientific; and, distilled-deionized water. All the glassware used for these extractions were washed well, rinsed three times in distilled water, oven-dried and, where applicable, stored in a grease-free desiccator.

**TABLE 1**

Background Of Pulps Studied

<u>Wood Pulp</u>	<u>Wood Source</u>
CTMP-I <sup>a</sup>	Northern Softwoods
CTMP-II <sup>a</sup>	Northern Softwoods
UBKP-I <sup>b</sup>	Southern Softwoods
BKP-I <sup>c</sup>	Southern Softwoods
BKP-II <sup>c</sup>	Southern Softwoods
BKP-III <sup>c</sup>	Northern Softwoods

- <sup>a</sup> Chemithermomechanical pulp
- <sup>b</sup> Unbleached Kraft pulp
- <sup>c</sup> Bleached Kraft pulp

### 2.2.1 Soxhlet Extraction Procedure

The Pyrex brand glass thimble, with a fritted disc of coarse porosity purchased from Fisher Scientific, together with the magnetic stirring bar and the glass stopper were first pre-extracted in about 300 mL of the respective solvent for about 12 hours. Next, as shown in Figure 5, about 16 gms of the pulp which was previously weighed in an aluminum boat was carefully transferred into this pre-extracted thimble. The aluminum boat was re-weighed to determine the exact weight of the pulp transferred. The pre-extracted flask was rinsed three times with the respective fresh solvent and then exactly 300 mL of the same fresh solvent were added to this flask. Soxhlet extraction for 72 hours was carried out at approximately 77°C for ethylacetate, 81°C for cyclohexane and 100°C for water. During the extraction, the Soxhlet thimble was wrapped in thermal felt in order to maintain a constant temperature. Each subsequent Soxhlet extraction was preceded by a pre-extraction in order to erase any memory effects from the previous extraction. Blank extractions with each solvent using the pre-extracted glassware were carried out following the same procedure as in Figure 5, but without the pulp in order to account for the background by using the following relationship:

$$\% \text{ Pulp Extractives} = \frac{E-B}{P} \times 100 \quad (5)$$

where E is the weight of the extract

B is the weight of the background

## SOXHLET EXTRACTION PROCEDURE

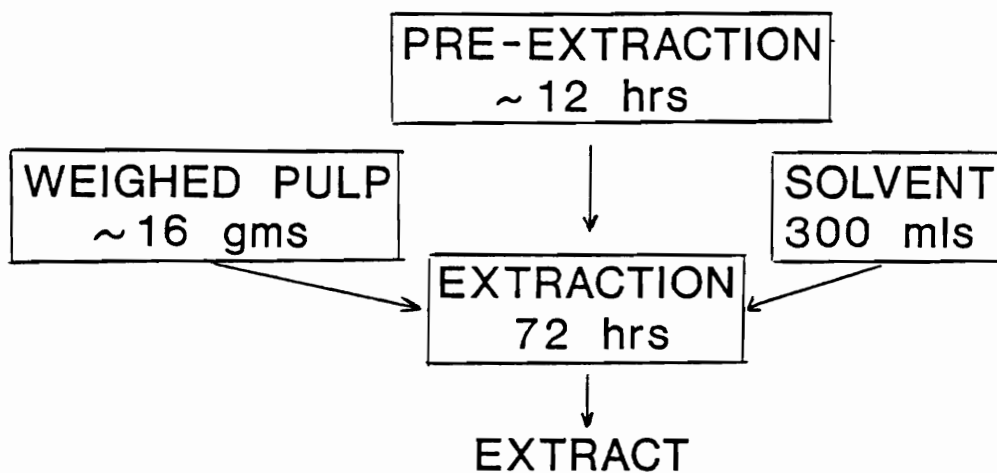

Figure 5. The procedure for Soxhlet extraction.

and P is the weight of the pulp before extraction.

After the extraction was completed, in the case of ethyl acetate and cyclohexane solvents, the extract was concentrated to about 10 mL in a grease-free rotary evaporator under vacuum. With water as the extraction solvent, this step was accomplished by forming an azeotropic mixture with HPLC grade methanol. All concentrated extracts were carefully transferred to previously weighed glass vials and dried with the aid of a slow stream of pre-purified nitrogen. The flow chart regarding this procedure is shown in Figure 6. The dried extract was then accurately weighed on an analytical balance and the percent extractives calculated after subtracting the background. A duplicate extraction was performed for each pulp in each solvent.

### **2.2.2 Analysis**

The dried extracts were dissolved in a small quantity of their extraction solvent, filtered if necessary and the resulting solution was used for analysis by gas chromatography-flame ionization detection (GC/FID) and gas chromatography-mass selective detection (GC/MSD). Only ethyl acetate and cyclohexane extracts were used for analysis by GC/FID; whereas, all the three solvent extracts of the above mentioned pulps were analyzed by GC/MS.

#### **GC/FID**

Separations were performed with a Model 5890A gas chromatograph (Hewlett-Packard) equipped with FID and a

## CONCENTRATION and DRYING

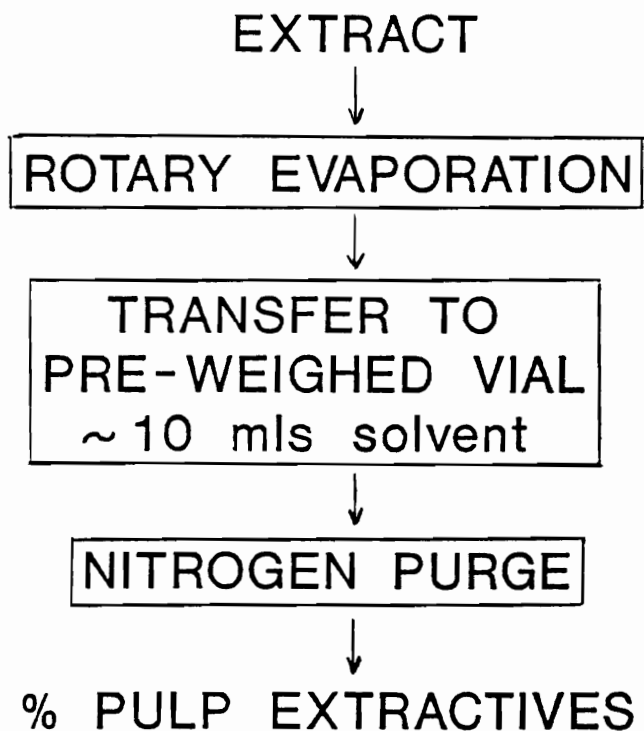

**Figure 6.** The procedure for concentrating and drying of the extracts.



splitless/split capillary column inlet system. A 10 m x 0.2 mm i.d., 0.25  $\mu\text{m}$  film thickness, SE-54 bonded phase fused silica capillary column coated with 5% diphenyl-94% dimethyl-1% vinyl polysiloxane was used. Helium was used as the carrier gas with a linear velocity of 22 cm/sec. Nitrogen served as the make-up gas. The detector and injector were set at 280°C. The temperature program employed was as follows: initial oven temperature 60°C for one minute, ramp at 8°C/min, until 280°C and finally hold at 280°C for 10 minutes. For the ethyl acetate and cyclohexane extracts 1  $\mu\text{L}$  of reconstituted solution was injected. All the injections were done manually with a Hamilton Microliter Syringe. All the data were recorded by a Hewlett-Packard 3392A integrator.

#### GC/MS

Mass spectra were obtained by direct interface of the above gas chromatograph with a Model 5970 (Hewlett Packard) Mass Selective Detector (MSD). The transfer line was maintained at 250°C with helium as the carrier gas. The capillary column, injector temperature of the capillary inlet system and temperature ramp were the same as mentioned previously for the GC/FID. The mass spectra were obtained by Electron Impact (EI) ionization mode at an electron beam energy of 70 eV and quadrupole rods were used for the separation of the ions. The ion source temperature was maintained at 200°C and the mass scan range was 50-450 amu. The volumes of the extracts injected were identical to that

used in GC/FID. All the data were processed using an HP 59970C Chem Station.

### 2.3 RESULTS AND DISCUSSION

Attempts were made to carry out all extractions with utmost care. Glass thimbles and stoppers were washed and rinsed in distilled-deionized water and dried in an oven prior to use. They were carefully wrapped in tissue and stored in a grease-free desiccator with the idea to avoid any dust or grease. After the pre-extractions were completed, care was taken not to touch any of the pre-extracted materials by hand. Extractions were carried out immediately after the pre-extractions were done in order to minimize any contamination due to long standing or storage. The transfer of the pulps into the thimbles was a painstaking task, due to the physical nature of the pulps. Care was taken to pack as much as possible with minimum losses. The pre-extracted flask was rinsed three times with fresh solvent before adding the final 300 mL. Every Soxhlet extraction was preceded by a pre-extraction of the system with the respective extraction solvent. Concerning the extractant concentration and drying procedures, the rotary evaporator used was grease-free.

Duplicate extractions were carried out for each pulp in each solvent with very good reproducibilities (Table 2). Percent water extractives were the highest, followed by ethyl acetate and cyclohexanes extractives. A similar trend

**TABLE 2**

Percent Extractives per Air Dried Wood Pulp

<u>Wood Pulp</u>	<u>EtOAc</u>	<u>C<sub>6</sub>H<sub>12</sub></u>	<u>H<sub>2</sub>O</u>
CTMP-1	0.12 0.14	0.05 0.05	2.58 3.45
CTMP-II	0.13 0.11	0.04 0.06	3.20 4.05
UBKP-1	0.05 0.08	0.05 0.02	1.73 1.57
BKP-I	0.01 0.02	0.01 0.01	0.92 0.74
BKP-II	0.04 0.04	0.03 0.03	0.80 0.83
BKP-III	0.23 0.22	0.13 0.14	0.44 0.44

has been observed for wood extractives of several tropical wood species (37,38). The water extracts were hygroscopic based on the observation that after a span of one month, their weights increased. CTMP water extractives were much higher in content than the Kraft water extractives. A plausible explanation could be a larger amount of polysaccharides, starches etc. which are water soluble. CTMP ethyl acetate extractives were slightly higher than Kraft ethyl acetate extractives with BKP-III being an exception. In the case of the cyclohexane extractives, BKP-III had the highest value; while, the percent extractives of the remaining pulps (CTMP and BKP) were about the same. On comparing the UBKP-I and BKP-I percent extractives, the former was greater in value no matter what solvent was employed. This indicated that the multistage bleaching process reduced the extract content for all polarities.

Analysis by GC/FID was first done to gauge the number of different components in each pulp extract since FID is known to be responsive to most organic materials. Percent extractives does not necessarily indicate a wide variety of components. While an open tubular capillary column was employed, our goal was not to examine thoroughly as many components as possible, but to compare under identical conditions Kraft pulps and CTMP pulps. For this reason, we did not choose to derivatize (e.g. silylation) components to enhance volatility. For example, many more different volatile components are extracted with cyclohexane from

CTMP-II (Figure 7) than from UBKP-I (Figure 8) even though the percent extractives were similar. On the other hand, the number of volatile compounds extracted from BKP-I (Figure 9) with cyclohexane was fewer than those extracted from the UBKP-I (Figure 8) which was similar to our observation regarding the magnitude of percent extractives. Similar trends were observed with ethyl acetate as the extraction solvent. Of course these data preclude our drawing any conclusions concerning semi-volatile and nonvolatile extracted components.

Analysis of the total ion current chromatograms (TICs) obtained under the same GC conditions with mass selective detection for the different extracts reinforced some earlier GC/FID conclusions. Again, our goal was not to perform an exhaustive examination of as many components as possible in these extracts, but rather to show in a qualitative manner the differences and commonality of CTMP and Kraft extracts. Figures 10 and 11 which are for ethyl acetate extracts of CTMP-I and BKP-I are illustrative of these data. Peak number designation is given in Table 3. These assignments were made based on an NBS Library search with a probability match of more than 95% and further confirmation by a manual search (39). As can be observed, it was possible to identify only about 50% of the total peaks detected in the four extracts studied. For the remaining peaks a confident, reasonable assignment was not possible without appropriate standards. However, based upon our interpretation of each

GC/FID of CTMP-II CYCLOHEXANE EXTRACT.

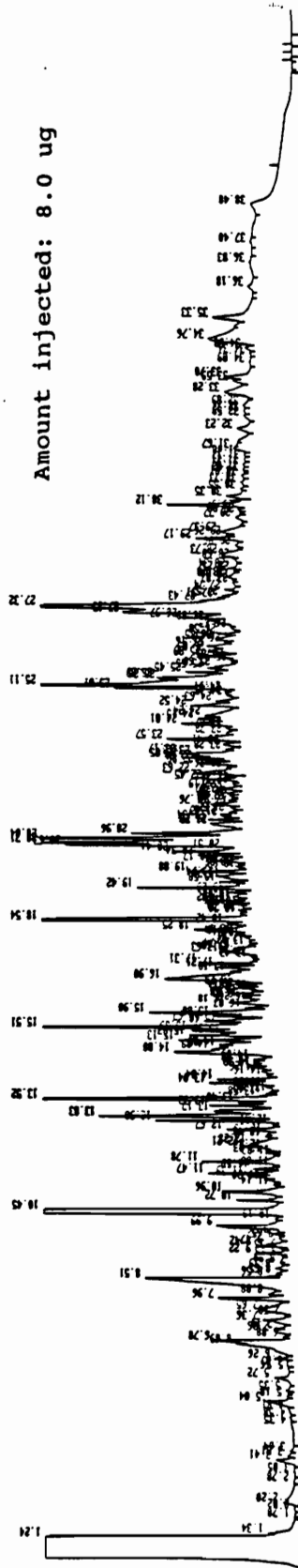

Figure 7. GC/FID of CTMP-II cyclohexane extract: Injector: splitless/split at 280°C; column: SE-54 ( 10 m x 0.2 mm i.d. ), 0.25  $\mu$ m film thickness; Carrier: helium; Make-up gas: nitrogen; Detector: FID at 280°C; Temperature program used was 60°C for 1 min., then a ramp of 8°C/min until 280°C where the temperature was kept constant for 10 min; 1  $\mu$ L injection.

GC/FID of UBKP-I CYCLOHEXANE EXTRACT.

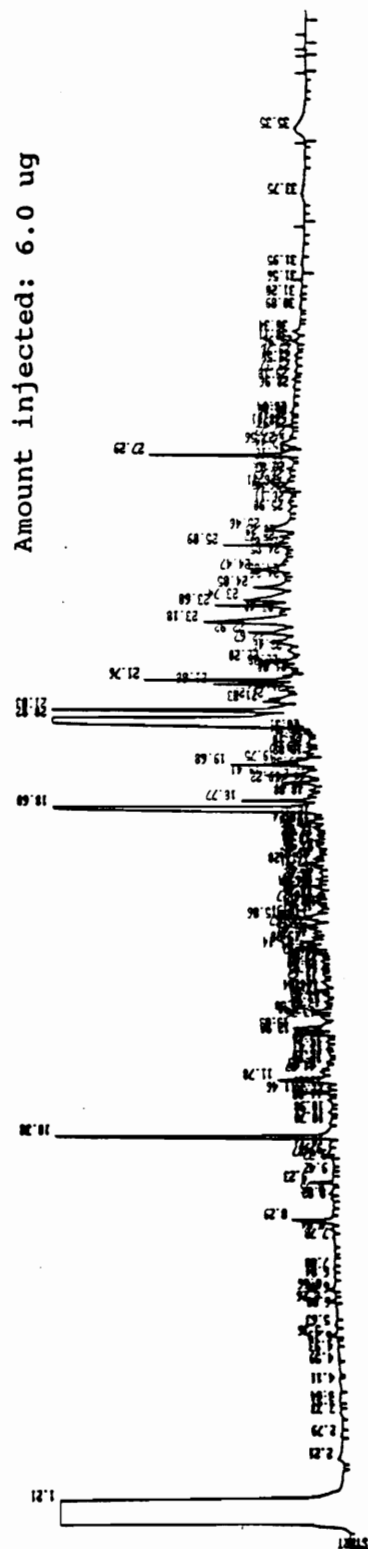

Figure 8. GC/FID of UBKP-I cyclohexane extract: Conditions same as in Figure 7.

GC/FID of BKP-I CYCLOHEXANE EXTRACT.

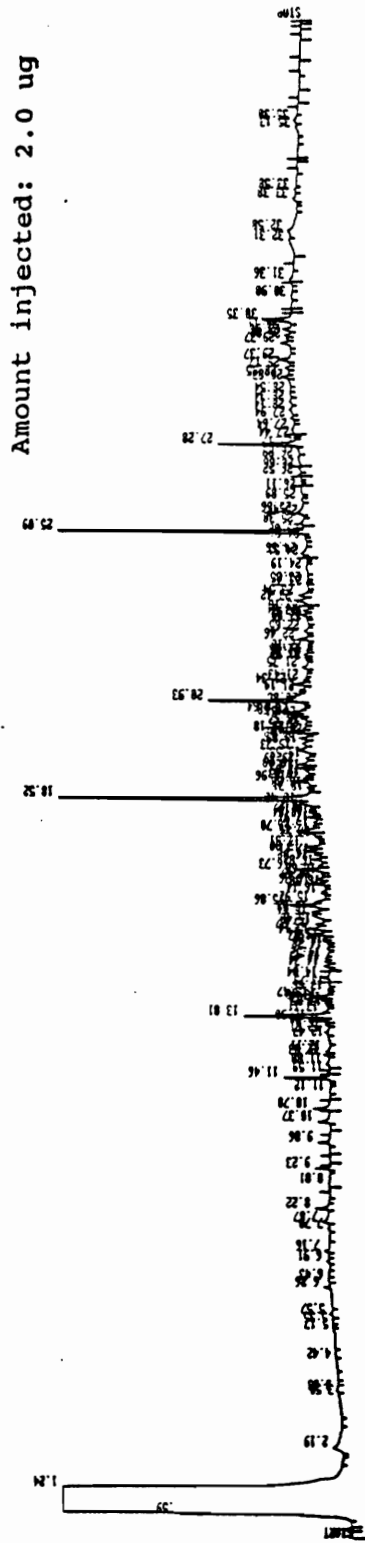
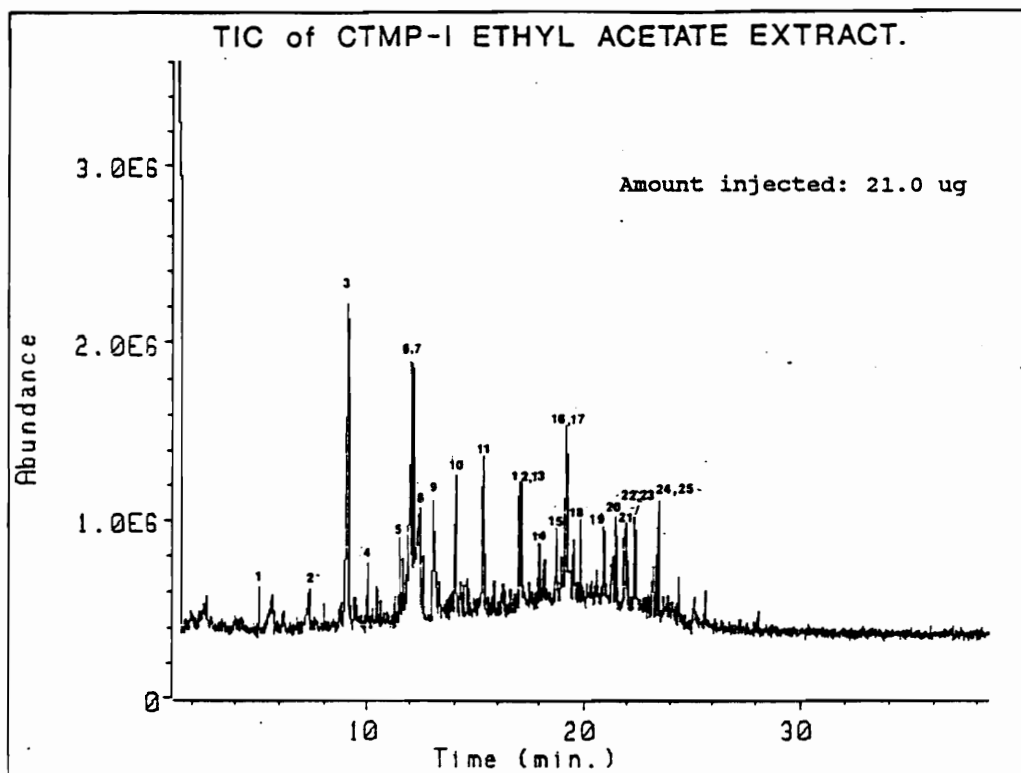

Figure 9. GC/FID of BKP-I cyclohexane extract: Conditions same as in Figure 7.





**Figure 10.** GC/MS of CTMP-I ethyl acetate extract: Conditions of GC same as above. Transfer line: 250°C; Injection: 1 $\mu$ L. Electron impact ionization was used for the ion production. The beam energy was 70 eV; Ion separation was achieved by quadrupole rods and detection of ions by electron multipliers. The mass range monitored was from 50-450 amu.

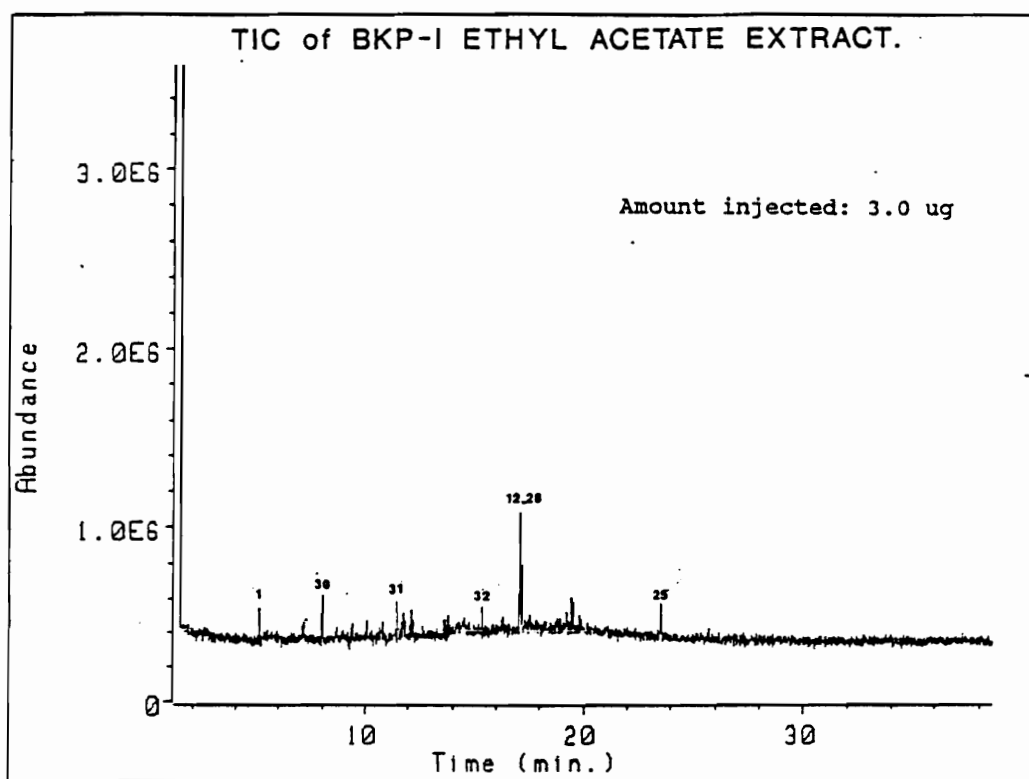

Figure 11. GC/MS of BKP-I ethyl acetate extract: Conditions same as Figure 10.

TABLE 3

Major Peak Assignments for Select Extracted Wood Pulp Components<sup>a</sup>

Peak Number	CTMP-I			CTMP-II			UBKP-I			BKP-I <sup>b</sup>			Assignment
	EA	CH	W	EA	CH	W	EA	CH	W	EA	CH	W <sup>b</sup>	
1	y			y			y			y			Decamethylcyclopentasiloxane
2	x			x									Long chain (fatty) acid <sup>c</sup>
3	x	x	x	x	x	x	x	x					4-Hydroxy-3-methoxy benzaldehyde (Vanillin)
4	x												2-Methoxy-4-propyl phenol
5	x												Phenol <sup>c</sup>
6	x			x									1-Propenone, 3-hydroxy-1-(4-hydroxy-3-methoxyphenyl) <sup>d</sup>
7	x	x		x	x								Ketone <sup>c</sup>
8	x												4-Hydroxy-3-methoxybenzoic acid (Vanillic acid)
9	x		x	x									4-Hydroxy-3-methoxybenzene-acetic acid
10	x	x		x	x								Phenol <sup>c</sup>
11	x			x									1-Propanone, 3-hydroxy-1-(4-Hydroxy-3-methoxyphenyl) <sup>e</sup>
12	y	y		y	y					y	y		1,2 Benzenedicarboxylic acid diisobutyl ester
13	x			x			x	x					Aliphatic ester <sup>c</sup>
14	x												Long chain aliphatic <sup>c</sup>
15	x												Saturated hydrocarbon <sup>c</sup>
16	x												Unsaturated aliphatic ester <sup>c</sup>
17	x	x											9-Octadecenoic acid (oleic)
18	x												Saturated hydrocarbon <sup>c</sup>

<sup>a</sup> x = Component of pulp was found in extract; y = Impurity found in extract

<sup>b</sup> EA = Ethyl acetate extract, CH = cyclohexane extract, W = water extract

<sup>c</sup> Chemical class, specific compound unspecified

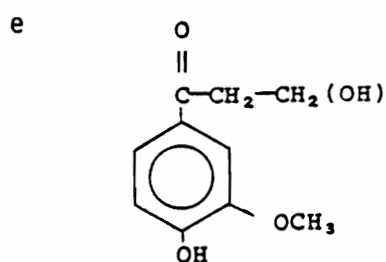
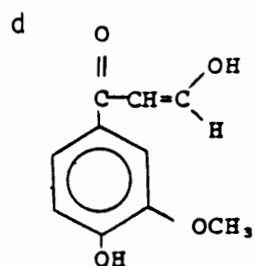

TABLE 3 cont'd

Major Peak Assignments for Select Extracted Wood Pulp Components<sup>a</sup>

Peak Number	CTMP-I			CTMP-II			UBKP-I			BKP-I			Assignment
	EA	CH	W	EA	CH	W	EA	CH	W	EA	CH	W	
19	x												Aliphatic ester <sup>c</sup>
20	x												Hexanedioic acid, dioctyl ester(adipate)
21	x												Sterol <sup>c</sup>
22	x												Phenol <sup>c</sup>
23	x												1-Phenanthrenecarboxylic acid ester
24	x	x											Monoalkyl benzene <sup>c</sup>
25	y	y		y	y		y			y			Dioctyl benzenedicarboxylic ester
26				x									Phenol <sup>c</sup>
27				x									Unknown
28		x		x						x			Octadecenoic acid ester (oleic)
29		x		x	x								Aliphatic ketone <sup>c</sup>
30										y			Dodecamethylcyclohexasiloxane
31										x			Phenyl isoindole dione <sup>c</sup>
32										x			Steroid <sup>c</sup>
33							x	x					Unsaturated fatty acid <sup>c</sup>

<sup>a</sup> x = Component of pulp was found in extract; y = Impurity found in extract  
<sup>b</sup> EA = Ethyl acetate extract, CH = cyclohexane extract, W = water extract  
<sup>c</sup> Chemical class, specific compound unspecified

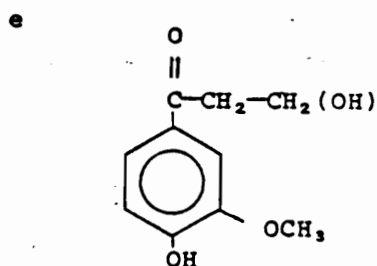
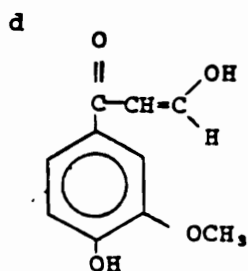

TABLE 3 cont'd

Major Peak Assignments for Select Extracted Wood Pulp Components<sup>a</sup>

Peak Number	CTMP-I			CTMP-II			UBKP-I			BKP-I			Assignment
	EA	CH	W	EA	CH	W	EA	CH	W	EA	CH	W	
34					x		x	x					Long chain aliphatic <sup>c</sup>
35					x		x		x				Unknown
36	x												Sterol <sup>c</sup>
37				x									Long chain aliphatic <sup>c</sup>
38								x					Dehydroabiatic acid
39								x					Methyl 4-methyl-dibenzofuran-1-carboxylate <sup>d</sup>
40								x					1-Hexadecanol
41		x											Formic Acid
42		x			x						x		3-Hydroxy-2-butanone
43		x			x						x		1-Hydroxy-2-propanone
44		x			x						x		Aliphatic compound <sup>c</sup>
45		x			x						x		Aliphatic aldehyde <sup>c</sup>
46		x											2-Furan methanol
47		x			x						x		Ketone <sup>c</sup>
48		x											Cyclohexanone
49		x			x								2-Cyclopenten-1-one, 2,3,4,trimethyl
50		x			x						x		Unknown
51		x			x								4-Hydroxy-3-methyl acetophenone <sup>e</sup>
52					x								Primary alcohol
53					x								1,2,-Cyclopentanedione, 3-methyl
54					x								Cholestane diol <sup>c</sup>

<sup>a</sup> x = Component of pulp was found in extract

<sup>b</sup> EA = Ethyl acetate extract, CH = cyclohexane extract, W = water extract

<sup>c</sup> Chemical class, specific compound unspecified

<sup>d</sup>

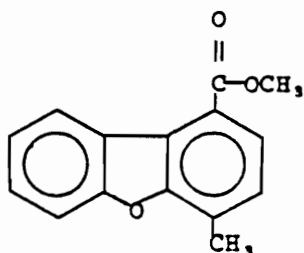

<sup>e</sup>

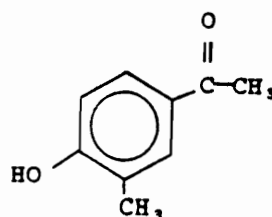

spectrum and the general class of compound indicated as the "best hits" from the computer search, most of these peaks could be given a chemical class designation. A general inspection of the GC/MS results again indicates that CTMP pulp extracts contain appreciably more volatile components than either bleached or unbleached Kraft pulp extracts.

A few of the fully identified peaks turned out to be impurities (designated by "y") which are believed to be due to sample handling. These impurities can be accounted for, but their presence was surprising in light of the extreme care with which the study was undertaken. It is believed that peaks 12 and 25 probably arose from plasticizers in plastic bags that were used for storage of the wood pulps. It is assumed that the source of peaks 1 and 30 could be grease, wax, or rubber tubing used in sample manipulation. Decamethylcyclopentasiloxane (Peak 1) was found in the ethyl acetate extracts of all the pulps. Dodecamethylcyclohexasiloxane (Peak 30) was only observed in the ethyl acetate extract of BKP-I. On the other hand, dioctylbenzenedicarboxylic ester (i.e. dioctylphthalate) (Peak 25) was seen in both the ethyl acetate and cyclohexane extracts of all wood pulps with the exception of the cyclohexane extract of UBKP-I. The same is true for 1,2-dibenzenedicarboxylic acid diisobutyl ester (Peak 12). When these impurity components are discounted, it is striking how few volatile and detectable components are extracted from

both the bleached and unbleached Kraft pulps relative to the CTMP pulps.

It is observed that many more peaks are found in the CTMP-I ethyl acetate extract as compared with the BKP-I ethyl acetate extract in keeping with the fact that percent extractives of the former are 10 times greater than that of the latter. Vanillin, which is basically a degradation product of the lignin from wood, was found in all of the ethyl acetate and cyclohexane extracts with the exception of BKP-I. It was also observed in the water extracts of CTMP-I and CTMP-II. Its oxidation product, vanillic acid, was also found in the ethyl acetate extract of CTMP-I.

Examination of the water extracts via GC/MS (Figures 12 and 13) indicates that analysis of only the volatile fraction of an extract can be misleading. Even though a much larger amount of the extract was used for injection than with the ethyl acetate extract and bearing in mind the much higher percentage of extractives obtained with water, very few different compounds were observed. This is probably due to the fact that the polar compounds extracted, have less vapor pressure and hence GC may not be adequate for their separation. Compounds designated by peak numbers 40 to 54 were uniquely extracted only by water and should constitute the more polar compounds. In addition, only vanillin and 4-hydroxy-3-methoxybenzeneacetic acid which is freely soluble in hot water were identified in the water extracts. It is likely that either supercritical fluid

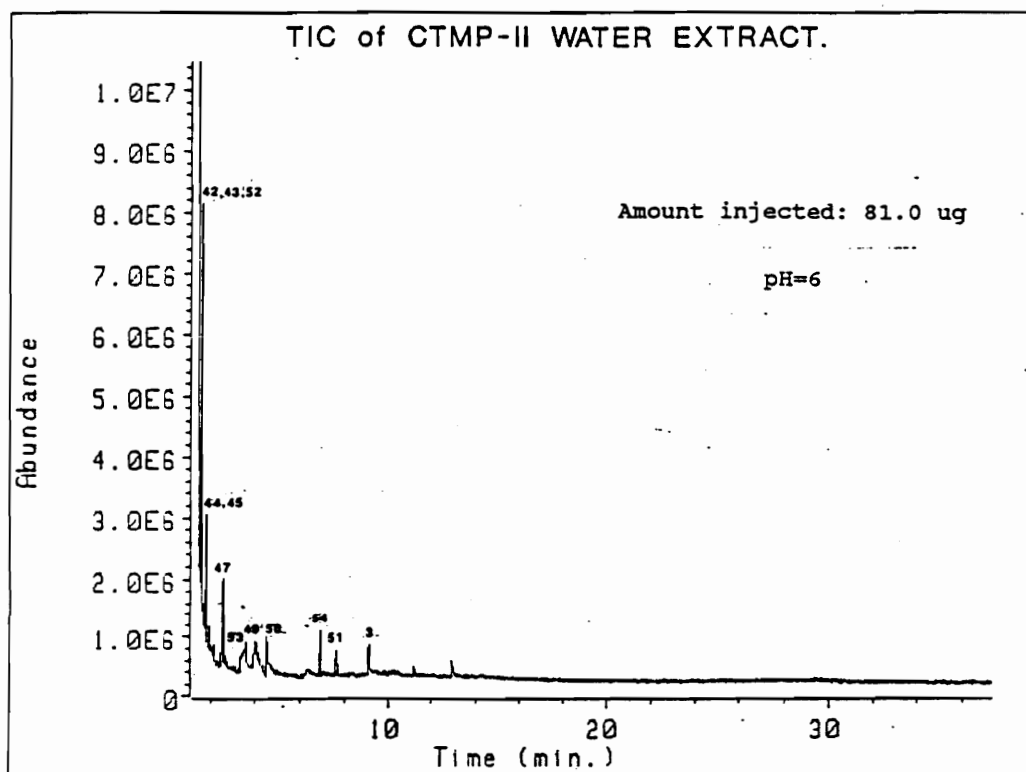

Figure 12. GC/MS of CTMP-II water extract: Conditions same as Figure 10 except 0.5  $\mu$ L injection.



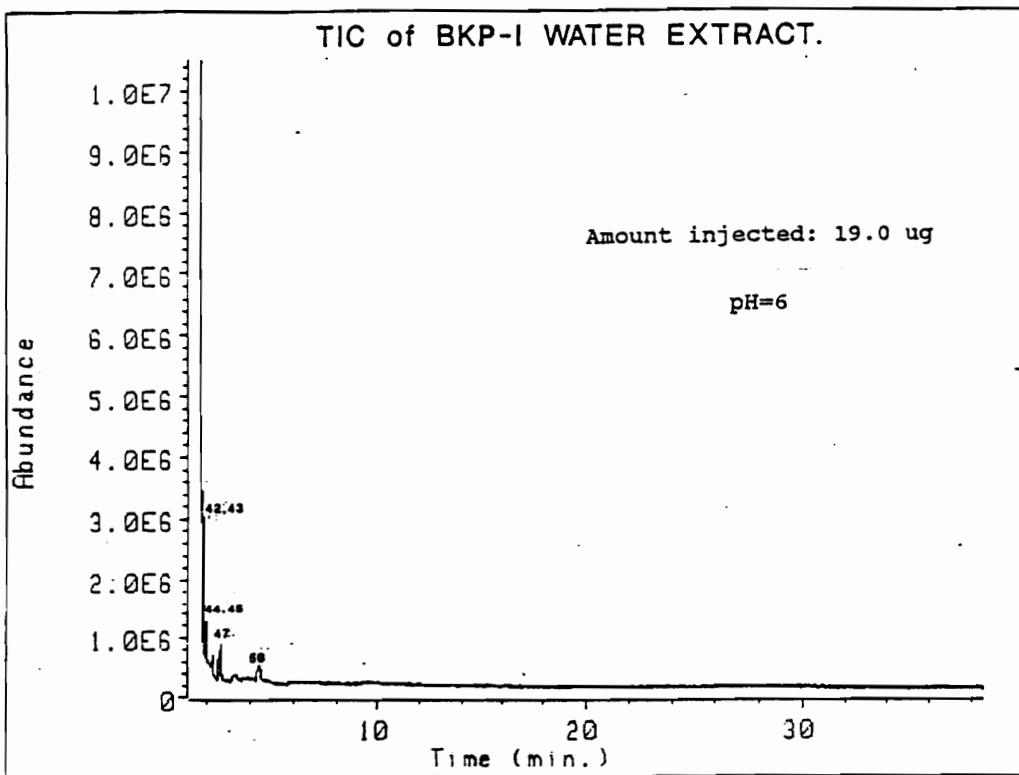

Figure 13. GC/MS of BKP-I water extract: Conditions same as Figure 10.

chromatography or liquid chromatography could give a clearer picture of the water extracts. Another possibility for our failure to observe in these extracts many components by GC/MS, is that the type of column used may not be adequate for separating polar compounds. A more polar column and/or a more efficient column may be the answer to this problem.

As would be expected the least polar compounds were generally extracted by cyclohexane. Of special mention here is dehydroabietic acid. It is a resin acid typically found in pinewoods. Another observation made here is that although the cyclohexane percent extractives of all the pulps were similar, with the exception of BKP-III, the compounds extracted were different. For example, dehydroabietic acid, methyl 4-methyl-dibenzofuran-1-carboxylate and 1-hexadecanol were only found in UBKP-I and not in the other cyclohexane extracts. Also, vanillin was observed in both the CTMP pulps extracted with cyclohexane as well as in UBKP-I but not in the BKP-I cyclohexane extract.

Although it was possible in this research to identify a relatively large number of compounds, no chlorinated material was identified in any of the pulp extracts. This could be due to the fact that the chlorinated material is present in trace quantities, which the full scan mode of the mass spectrometer may not detect due to lack of sensitivity. The next part of this work will concentrate on detecting and identifying these chlorinated species using selected ion

monitoring, negative ion mass spectroscopy and appropriate chlorinated standards.

In summary, based on percent extractives of the pulps studied, the results clearly indicate that: (a) CTMP pulps yield more water extractives than Kraft pulps, (b) ethyl acetate and cyclohexane extracts of the two pulp types are generally similar but lower than water extracts and (c) the unbleached Kraft pulp yielded more extractives than the bleached Kraft pulp. In regard to component identification, (a) chlorinated material was not observed in this survey of compounds possessing molecular weights from 50-450 amu, (b) cyclohexane percent extractives of all the pulps were similar, yet different compounds were extracted and (c) some impurities, probably from handling, were incorporated into each extract.

### **3.0 CHAPTER 3: IDENTIFICATION AND QUANTIFICATION OF SOME CHLORINATED PHENOLICS IN WOOD PULP EXTRACTS BY GAS CHROMATOGRAPHY TIME VARIED SELECTED MULTIPLE IONS MASS SPECTRA**

#### **3.1 INTRODUCTION**

In recent years there has been a growing concern regarding possible adverse effects resulting from the release of pulp mill-derived chlorinated organics into the environment. On the other hand, little is known regarding the ubiquity of chlorinated organics in bleached wood pulp extracts. Previously, we performed Soxhlet extractions on various CTMP and Kraft wood pulps (Ch 2). Volatile components were subjected to GC-MS. While CTMP extracts exhibited more different components than Kraft pulps, all pulps failed to reveal any chlorinated organics under the relatively low sensitivity MS conditions chosen for this study. Nevertheless, chlorinated phenolics were suspected to be present, especially in Kraft bleached pulps. These species are of particular interest because (a) they are lipophilic and have been recovered from various organisms living in the receiving waters, downstream of pulp mills (40,41); (b) some of the phenolics are rather persistent in

nature (42,43) and a knowledge of their relative concentration may be useful when judging possible sources of pollution<sup>a</sup>; (c) they are proven to have bioaccumulation tendencies (44) and are found to exhibit mutagenic activity when subjected to the 'Ames' Salmonella test (45,46); and, (d) they are more generally resistant to biodegradation than are non-chlorinated compounds (47).

Most of the chlorinated phenolics present in bleaching effluents can be grouped into essentially six major classes; namely, vanillins, catechols, phenols, guaiacols, syringols and syringaldehydes. These various compound classes were therefore suspected to reside in wood pulp extracts. Since it is a well-established fact that only hardwood effluents contain chlorinated syringols and syringaldehydes, we concerned ourselves only with the former four categories because we were using softwood pulps. In addition, we searched for veratroles due to their detection in some mill effluents (48). Mass spectrometric data were obtained by monitoring time varied selected multiple ions after open tubular column gas chromatography of the respective Soxhlet extract. Both CTMP and Kraft pulps were examined.

---

<sup>a</sup>The presence of PCP, which is believed not to be formed in the bleaching process, indicates other sources of chlorinated material such as wood preservative, fungicide, etc. (40,43).

### 3.2 EXPERIMENTAL

The six pulps that were utilized for this investigation originated from various softwoods and were provided by an industrial sponsor. CTMP-I and CTMP-II are pulps bleached by the peroxide process. UBKP-I was not subjected to any bleaching process, while BKP-I, BKP-II and BKP-III are derived from the Kraft multistage bleaching process. Extraction solvents were: (a) ethyl acetate, HPLC grade purchased from Burdick and Jackson, (b) cyclohexane, HPLC grade purchased from Fisher Scientific, and (c) distilled/deionized water. The 13 model chlorinated standards were purchased from Helix Biotech Corporation, B.C., Canada. Tables 4 and 5 list the above mentioned standards, together with their chemical structures, retention times, mass ions monitored, times monitored, molecular weights and relative parent ion isotopic abundances. Standards were dissolved in either distilled, deionized water or HPLC grade methanol purchased from Fisher Scientific. Great care was taken to ensure that all glassware for each extraction was free from any contamination from the previous extractions.

Details of the procedure for Soxhlet extraction, concentration and drying can be found in the previous chapter. Each dried extract was dissolved in the respective extraction solvent used earlier and filtered if necessary. The resulting solution was then used for the analysis by both gas chromatography/electron capture detection (GC/ECD)

**TABLE 4**

Chlorinated Phenolic Standards

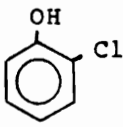
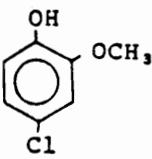
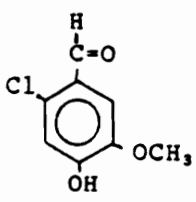
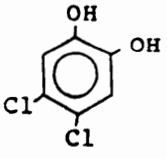
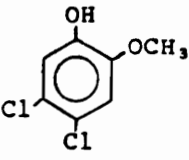
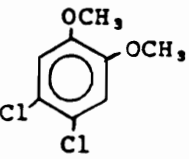
<u>Abbreviation</u>	<u>Structures</u>	<u>Mol. Wt.</u>
2-MCP		128
4-MCG		158
6-MCVN		186
4,5-DCC		178
4,5-DCG		192
4,5-DCV		206

**TABLE 4 cont'd**

Chlorinated Phenolic Standards

<u>Abbreviation</u>	<u>Structures</u>	<u>Mol. Wt.</u>
2,4,6-TCP		196
3,4,5-TCC		212
4,5,6-TCG		226
3,4,5-TCV		240
TeCC		246
TeV		274
PCP		264



TABLE 5

Time Varied Selected Multiple Ions Monitored

GC/MS Run A

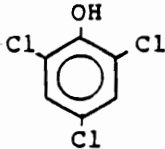
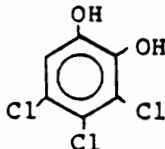
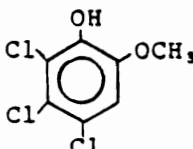
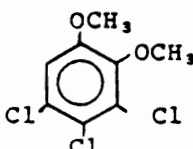
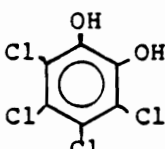
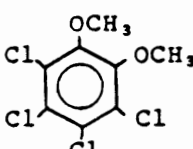
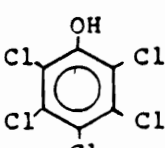
<u>Compound</u>	<u>Retention Time (min)</u>	<u>Mass Ions Monitored (amu)</u>	<u>Time Monitored (min)</u>	<u>Relative Abundance Parent Isotopic Cluster<sup>a</sup></u>
4-MCG	9.5	143,158,160	9.0-12.8	Mono
2,4,6-TCP	10.6	196,198,200	9.0-12.8	Tri
4,5-DCG	13.1	177,192,194	12.8-15.0	Di
3,4,5-TCV	15.5	240,242,244	15.0-16.0	Tri
4,5-DCC	16.3	178,180	16.0-16.5	Di
TeCV	16.6	261,274,276,278	16.5-17.2	Tetra
4,5,6-TCG	16.9	213,226,228	16.5-17.2	Tri
PCP	17.4	264,266,268	>17.2	Penta

GC/MS Run B

<u>Compound</u>	<u>Retention Time (min)</u>	<u>Mass Ions Monitored (amu)</u>	<u>Time Monitored (min)</u>	<u>Relative Abundance Parent Isotopic Cluster<sup>a</sup></u>
2-MCP	4.1	128,130	3.8-13.0	Mono
4,5-DCV	13.5	206,208,210	13.0-14.0	Di
6-MCVN	14.5	185,186,187,188	14.0-14.9	Mono
3,4,5-TCC	15.0	212,214,216	14.9-17.8	Tri
TeCC	18.4	246,248,250	>17.80	Tetra

<sup>a</sup>Mono - 1.00/0.3  
 Di - 1.0/0.65/0.10  
 Tri - 1.00/0.98/0.30/0.03  
 Tetra - 0.80/1.00/0.50/0.10/0.01  
 Penta - 0.60/1.00/0.65/0.20/0.03/0.002

and GC/time varied selected multiple ion mass spectrometry (GC/TVSMIMS). Only the water and ethyl acetate extracts were analysed by GC/TVSMIMS.

### 3.2.1 GC/ECD

Separations were performed with a Model 5890A gas chromatograph (Hewlett-Packard) equipped with a  $^{63}\text{Ni}$  ECD Model 19233 detector and a splitless/split capillary column inlet system. A 30 m x 0.25 mm i.d., 0.25  $\mu\text{m}$  film thickness, SPB-20 bonded phase (20% diphenyl-80% dimethylpolysiloxane) fused silica column (Supelco) was used. Helium was employed as a carrier gas with a linear velocity of 22 cms/sec. The make-up gas was 5% methane in argon. The injector temperature was set at 220°C, while the detector temperature was set at 325°C. The GC temperature program employed was as follows: initial oven temperature 60°C for 1 minute, ramp at 12°C/min until 130°C, hold at 130°C for 2 minutes, ramp at 8°C/min until 280°C, hold at 280°C for 3 minutes, ramp at 5°C/min until 290°C and finally hold at 290°C for 5 minutes. The injection volume was 1  $\mu\text{L}$  of extract solution. All the injections were done manually making use of a Hamilton Microliter Syringe. All the data were recorded by a Hewlett-Packard 3392A integrator.

### 3.2.2 GC/TVSMIM

Mass spectral analysis was performed by directly coupling the above gas chromatograph with a Model 5970 series Mass Selective Detector (MSD). The transfer line was maintained at 260°C with Helium as the carrier gas. The

injector temperature of the capillary inlet system was set at 280°C. The same capillary column as previously used for GC/ECD was utilized. The temperature ramp employed was as follows: initial oven temperature was maintained at 85°C for 1 minute, then ramped at 8°C/min to 260°C and held for 10 minutes. Mass spectra were obtained by electron impact (EI) ionization at an electron beam energy of 70 eV. The ion source temperature was maintained at 200°C. The resulting voltage was 2200 volts and the scan threshold was set at 1000. Data were processed with an HP 59970C Chem Station. The mass spectrometer was operated in the Time Varied Selected Ions Monitoring mode (i.e. with different group ions monitored for various time specific, absolute intervals). This protocol is depicted in Table 5 for the chlorinated standards.

Great care was taken to ensure that the chlorinated standards as well as the extracts were run under identical conditions for the purposes of identification as well as quantification. The peak assignments were made based on (a) a match of the mass obtained of the unknown with that of the respective chemical standard; (b) agreement of the retention time obtained of the unknown with the retention time of the chemical standard and (c) the consistency of the respective chlorinated isotopic pattern (i.e. mono, di, tri, tetra, penta) of the chemical standard's parent ion with that obtained from the extracted ions.

### 3.3 RESULTS AND DISCUSSION

Soxhlet extraction of each of the wood pulps was done using single solvents (i.e. water, cyclohexane or ethyl acetate). This method of extraction was adopted rather than the stepwise extraction technique (e.g. one sample with sequential solvents) in order to eliminate the risk of modification of the extractives by the different solvents utilized. Water, in spite of its bad reputation as a solvent for analysis by GC, received a high priority in our investigation due to the fact that a number of wood pulp finished products usually come in contact with water rather than organic solvents. Hence, it was hoped that this study would throw more light on the consequences of wood pulp usage as far as chlorinated phenolics are concerned.

In our earlier investigation (Ch 2) using GC/MS in the SCAN mode, we were unable to identify any chlorinated material in the wood pulp extracts studied. This led us to believe that if chlorinated materials were present, they were most probably present at extremely low levels. An electron capture detector (ECD) is well-known for its high sensitivity and selectivity (49,50) for halogenated compounds. In fact, a number of investigations (51-53) of pulp mill effluents utilize GC/ECD after derivatization with either diazomethane, acetic anhydride, heptafluorobutyric anhydride or various silanizing agents in conjunction with GC/MS for confirmation. In addition, EPA Test Method 604 (July 1982) for phenols also makes use of GC/ECD.

Figures 14-16 show the GC/ECD traces for ethyl acetate extracts of CTMP-I, UBKP-I and BKP-I. Derivatization was not employed. The greater number of components in the extract of CTMP-I and their greater concentration compared with the other pulps is very striking. As was the case in our earlier GC/FID investigation (Ch 2), BKP-I exhibited the fewest different volatile components. While ECD is highly sensitive for halogenated species, one should not conclude that every peak in Figures 14-16 originates from a compound that contains halogen. In fact, the only halogen associated with CTMP-I should be indigenous to the wood since this process is believed not to involve halogen of any type. Relative attachment coefficients have been reported for different classes of compounds. Many oxygen-containing compounds have high ECD sensitivities as the following ranking of attachment coefficients ( $K'$ ) suggests: chlorobenzene ( $K'=1$ ), acetophenone ( $K'=10$ ), benzaldehyde and benzyl chloride ( $K'=300$ ), cinnamaldehyde ( $K'=1000$ ), carbon tetrachloride and dimethylfumarate ( $K'=10,000$ ) (50). It seems highly probable, therefore, that the peaks seen in Figures 14-16 are not only due to halogenated compounds, but also to oxygenated compounds. Using cyclohexane as the extraction solvent, trends similar to those with ethyl acetate were observed. Since our goal was to compare the relative abundance of halogenated compounds, ECD, therefore, proved to be inadequate for our purposes due to these oxygenated interferences.

GC/ECD of CTMP-I ETHYL ACETATE EXTRACT.

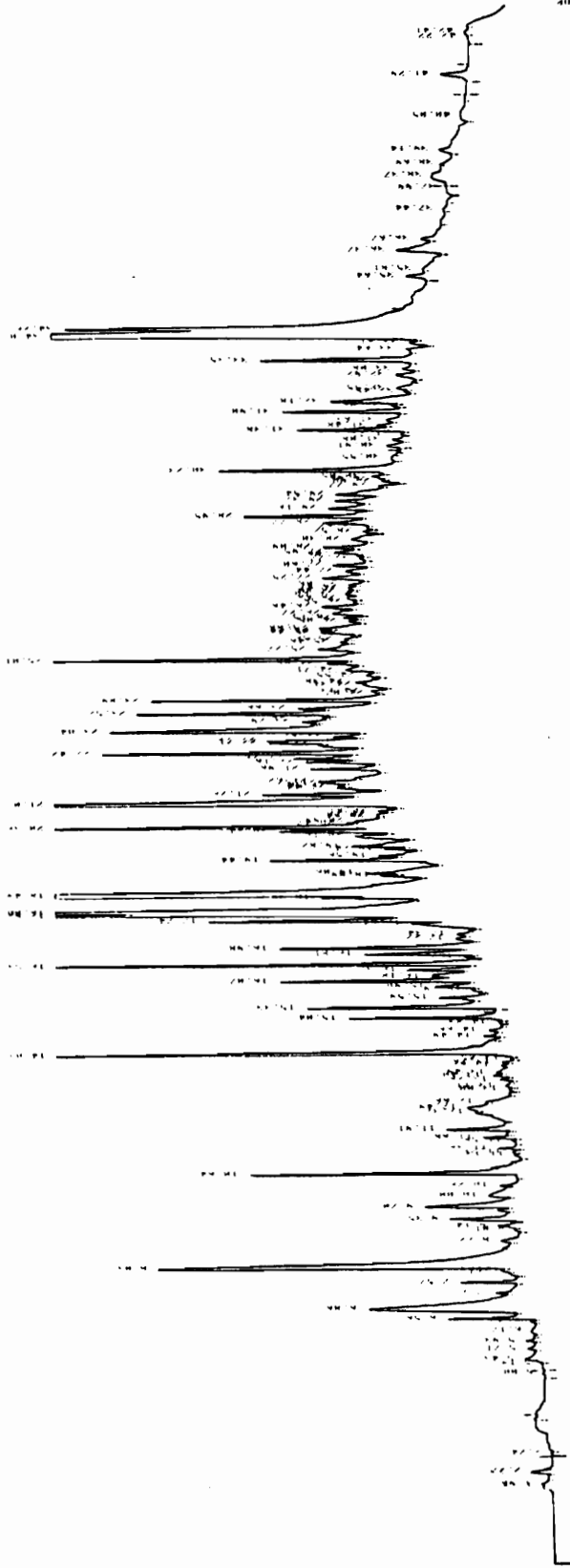

**Figure 14. GC/ECD of CTMP-I ethyl acetate extract:**  
Injector: splitless/split at 220°C; Column: SPB-20 (30 m x 0.25 mm i.d.), 0.25 μm film thickness; Carrier: helium, make-up gas: 5% CH<sub>4</sub> in Argon; Detector: ECD at 325°C; Temperature program used was 60°C for 1 minute, ramp at 12°C/min until 130°C, hold at 130°C for 1 minute, ramp at 8°C/min until 280°C, hold at 280°C for 3 minutes, ramp at 5°C/min until 290°C where the temperature was held constant for 5 minutes.

GC/ECD of UBKP-I ETHYL ACETATE EXTRACT.

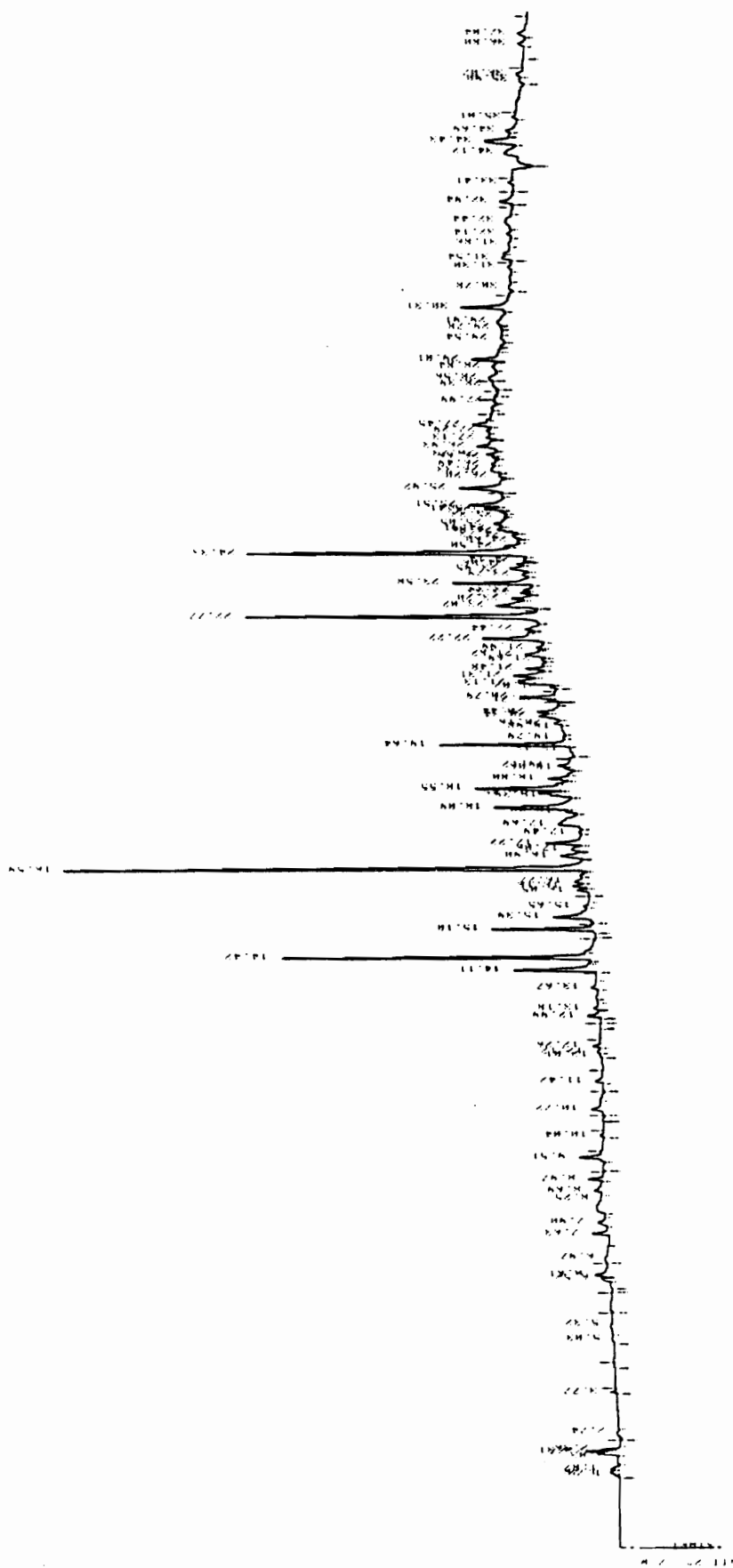

Figure 15. GC/ECD of UBKP-I ethyl acetate extract:  
Conditions same as in Figure 14.

GC/ECD of BKP-I ETHYL ACETATE EXTRACT.

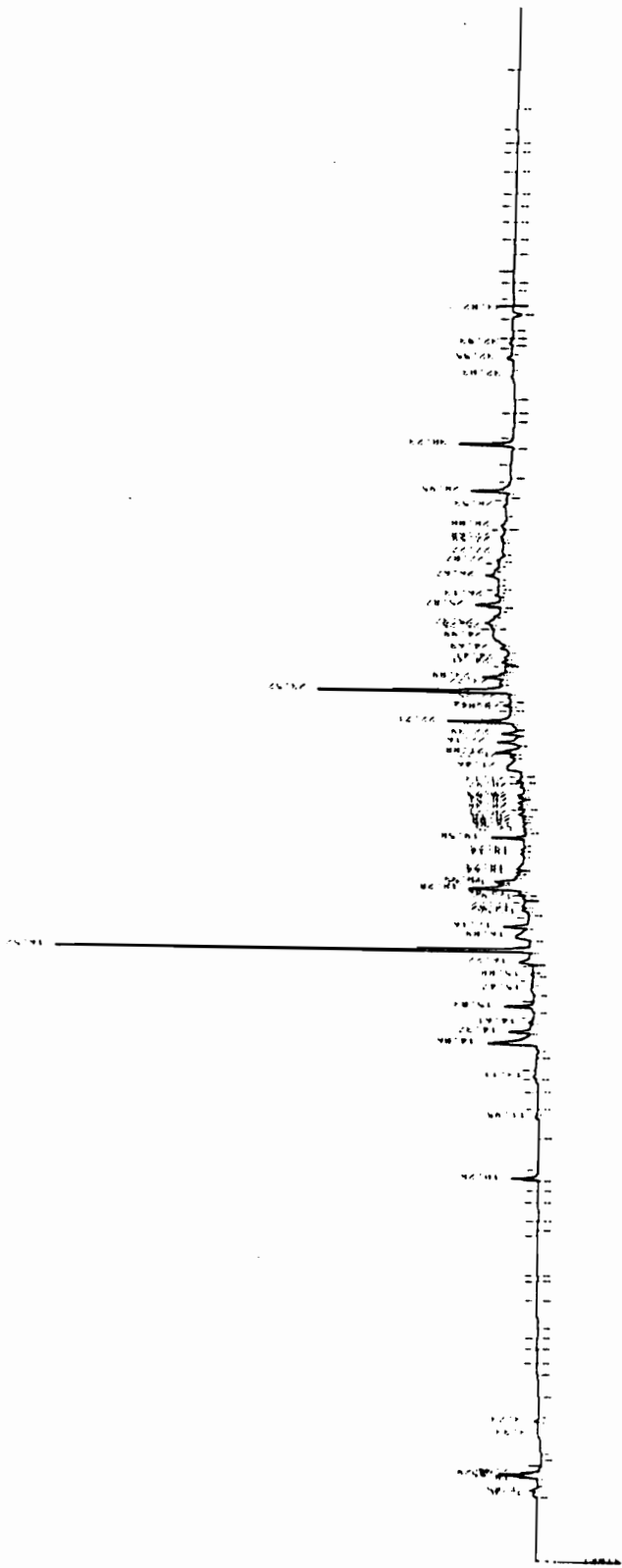

Figure 16. GC/ECD of BKP-I ethyl acetate extract:  
Conditions same as in Figure 14.



Our next effort to identify chlorinated compounds in wood pulp extracts was to compare GC/MS data of standard chlorine-containing phenols with unknown components separated from the pulp extracts. To enhance sensitivity a time varied selected multiple ions mass spectral method was employed wherein different selected mass ions were monitored at different time intervals as depicted in Table 5. Thirteen chlorinated phenolics were selected for monitoring based on their frequent discoveries in wood pulp mill effluents by GC/MS. These can be categorized into five classes of compounds: phenols, catechols, guaiacols, vanillins and veratroles. The relative abundance of the isotopic clusters are shown in the last column of Table 5 which are calculated theoretically using the Binomial Expansion theorem (54).

Solutions of these 13 chlorinated phenolic standards were individually prepared in either water, methanol or ethyl acetate depending on their maximum solubility. Using this basis only TCP and PCP were prepared in methanol, 6-MCVN in ethyl acetate; while, the rest were prepared in water. Each of these chlorinated phenolic standards was run under the previously mentioned GC/MS conditions. Mass spectrum and GC retention time of each were noted. Based on the mass spectrum obtained experimentally, at least two characteristic mass ions were chosen per standard to be monitored during the pulp extract portion of the study. In most cases, these were the molecular ion cluster as

illustrated in Table 5. The 13 chlorinated compounds are divided into Run A and Run B (Table 5) for examination purposes.

Individual wood pulps were next examined by monitoring only those phenolic masses which were expected to appear during a specified GC retention time window. Figure 17 shows the time varied selected ions mass spectrum of the UBKP-I water extract. The extracted ion chromatogram (Figure 18) confirmed that the lone observed peak arose due to the presence of 4-MCG. Similarly, four major peaks were observed in the BKP-II water extract (Figure 19) of which only two could be confidently identified as 4-MCG and 4,5-DCG. On the other hand, it was possible to identify 4-MCG, 2,4,6-TCP, 4,5-DCC and PCP in the CTMP-I ethyl acetate extract (Figure 20). The extracted ion chromatogram for confirmation of 2,4,6-TCP is shown in Figure 21. Of these assignments 4,5-DCC is most questionable since it was discovered independently that 4,5-DCC is unstable and decomposes into a monochlorinated compound.

Table 6 summarizes the various chlorinated phenolics identified in the water and ethyl acetate extracts of all pulps studied. 4-MCG was found in every extract of all the pulps. PCP was found in at least one extract of every pulp studied except BKP-I. Eight of the compounds monitored failed to show up in any pulp extract. While the presence of 6-MCVN could be confidently found in the ethyl acetate extracts of each BKP, its assignment in CTMP-I and CTMP-II

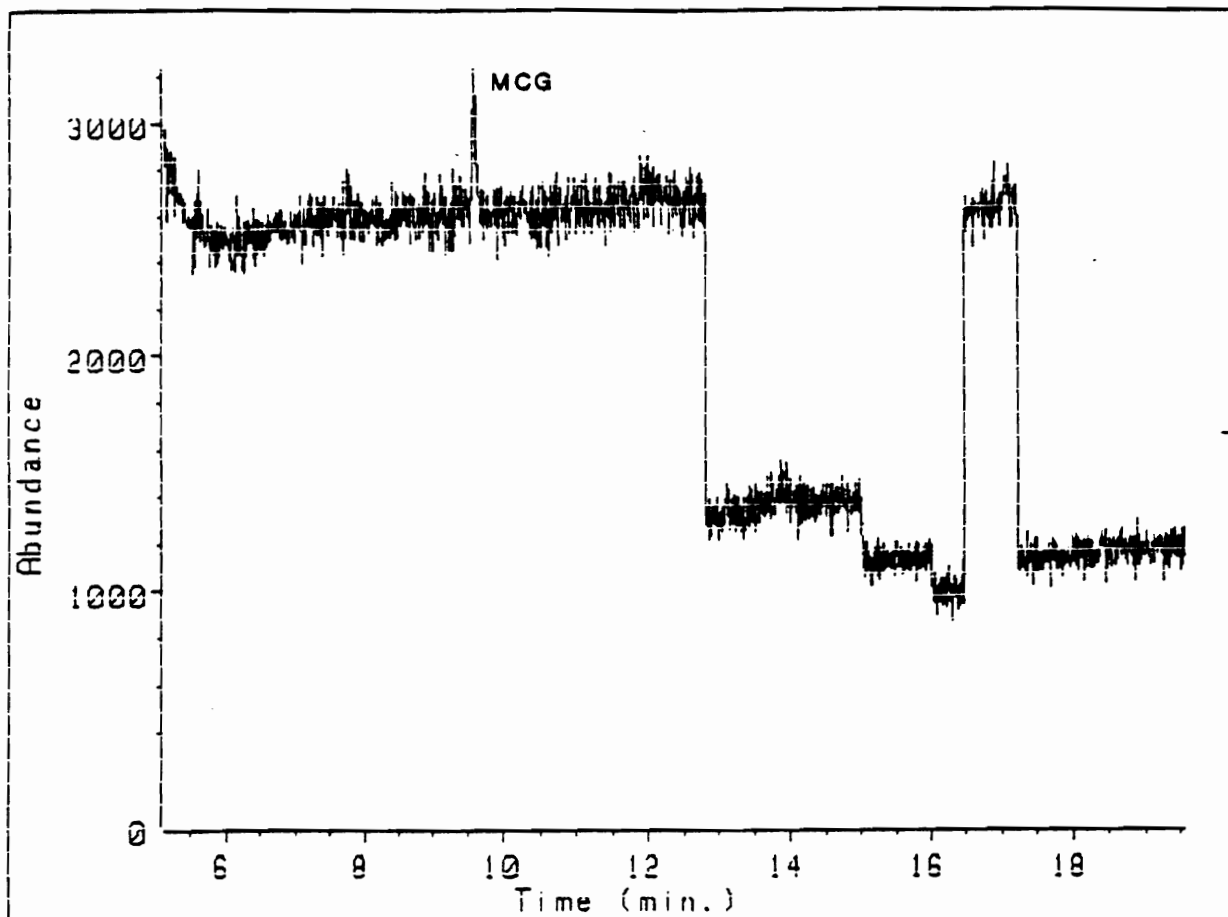

**Figure 17.** Time varied selected multiple ions mass spectrum of UBKP-I water extract: Injector: splitless/split at 280°C; Column: SPB-20 ( 30 m x 0.25 mm i.d. ), 0.25  $\mu$ m film thickness; Carrier: helium; Injection volume: 1  $\mu$ L. Temperature program used 85°C for 1 minute, then a ramp of 8°C/min until 260°C and finally held at 260°C for 10 minutes. Transfer line: 250°C; Ion production: EI; Beam energy: 70 eV; Ion separation: Quadrupole rods; Ion detection: Electron multipliers; Mass range monitored:100-300 amu.

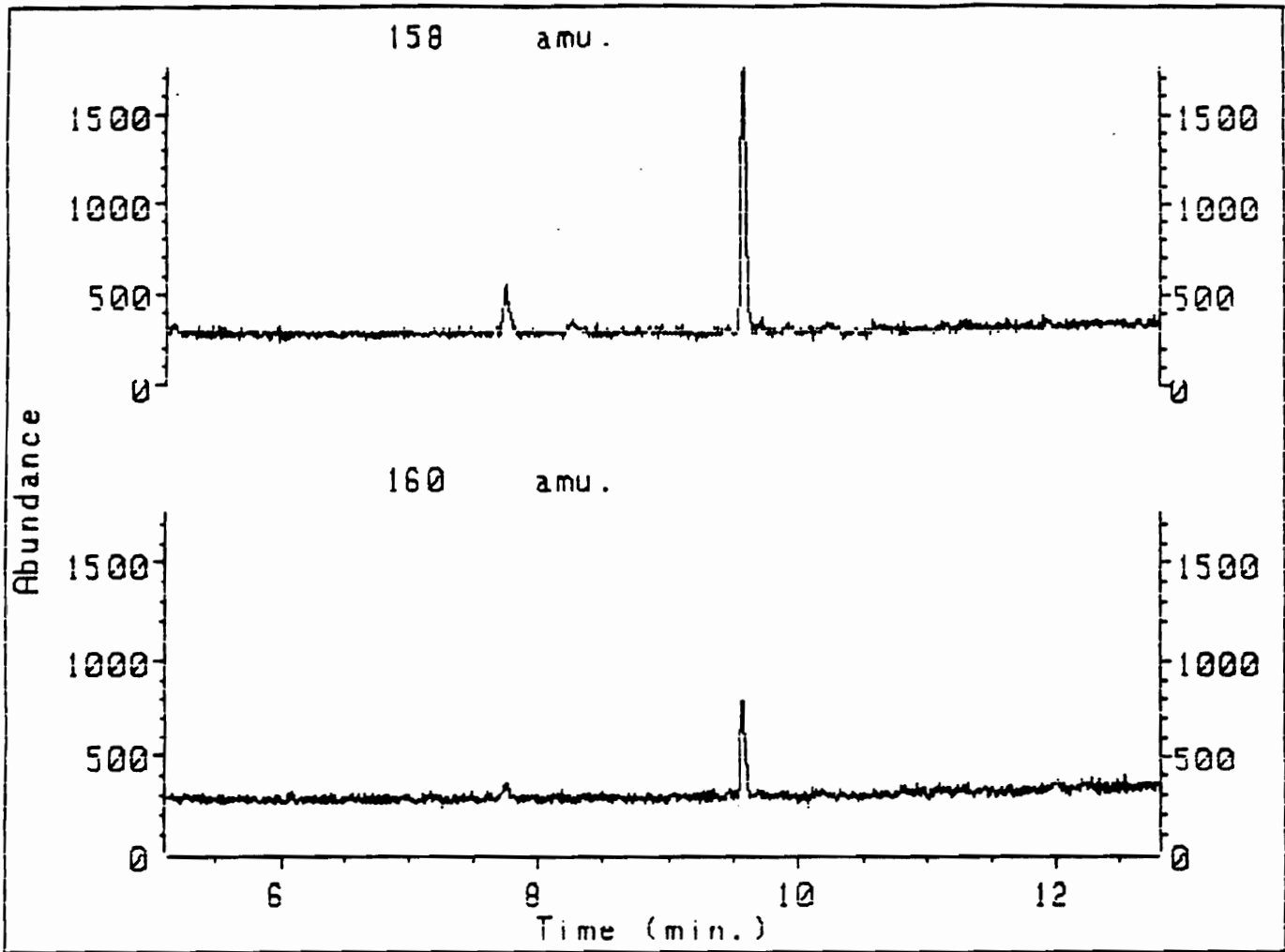

Figure 18. Extracted ion chromatograms of mass ions 158 amu 160 amu between 5.0 and 12.8 minutes from UBKP-I water extract: GC/MS conditions same as in Figure 17.

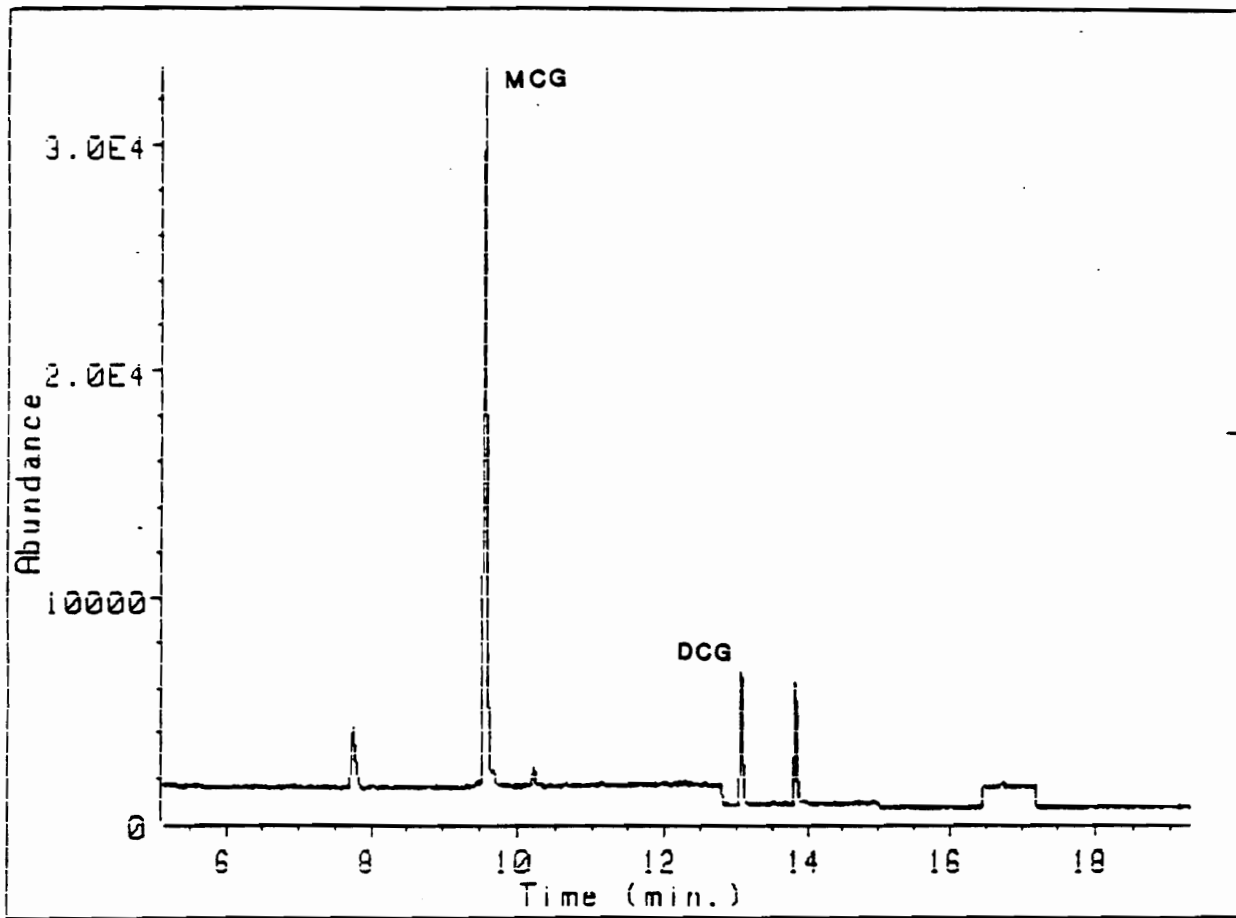
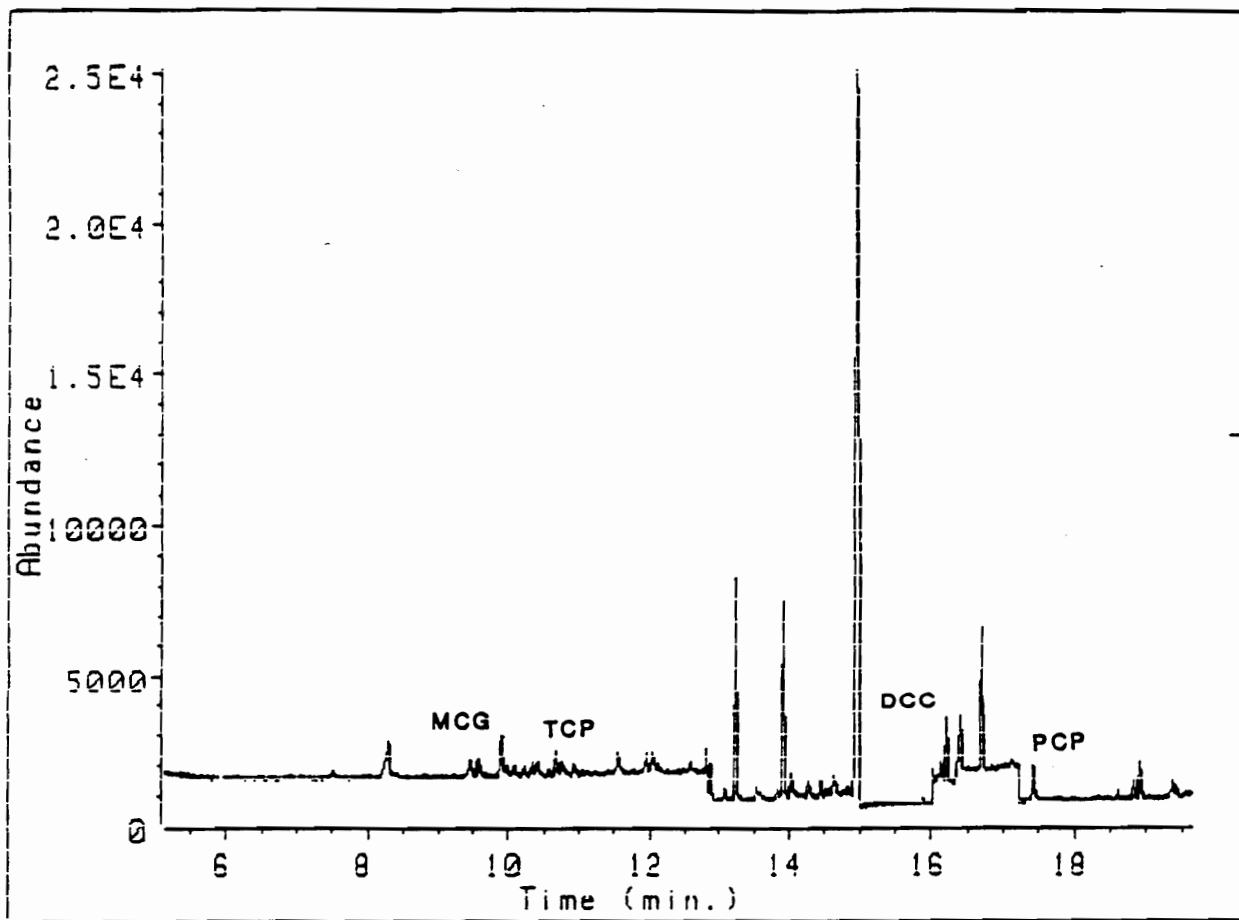

Figure 19. Time varied selected multiple ions mass spectrum of BKP-II water extract: GC/MS conditions same as in Figure 17.



**Figure 20.** Time varied selected multiple ions mass spectrum of CTMP-I ethyl acetate extract: GC/MS conditions same as in Figure 17.

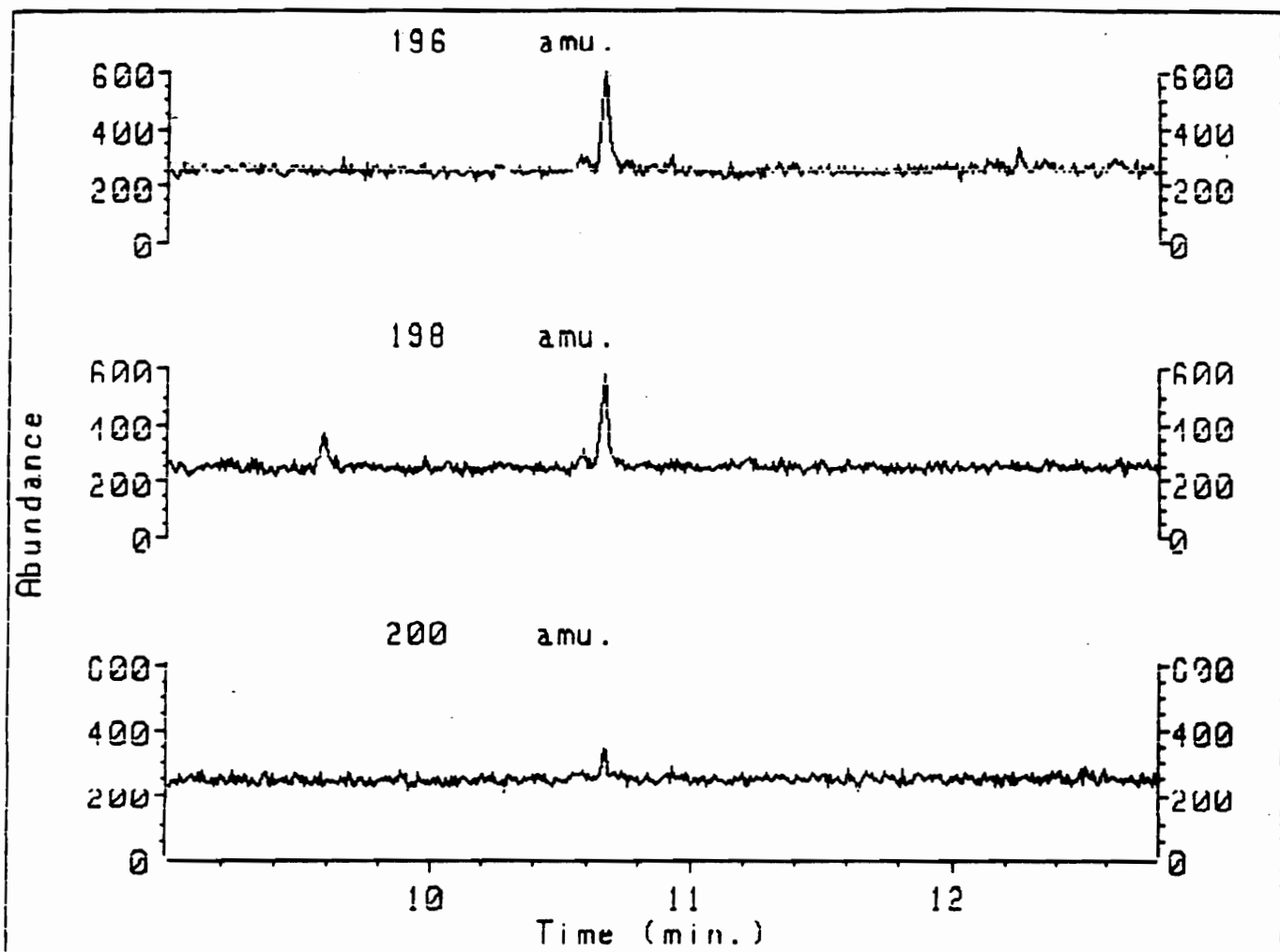

Figure 21. Extracted ion chromatograms of mass ions 196, 198 and 200 amu between 9 and 12.8 minutes from CTMP-I ethyl acetate extract: GC/MS conditions same as in Figure 17.

TABLE 6

Chlorinated Phenolics Found in Water and Ethyl Acetate  
By GC/EIMS

<u>Compounds</u>	<u>CTMP-I</u>		<u>CTMP-II</u>		<u>UBKP-I</u>		<u>BKP-I</u>		<u>BKP-II</u>		<u>BKP-III</u>	
	<u>W</u>	<u>EA</u>	<u>W</u>	<u>EA</u>	<u>W</u>	<u>EA</u>	<u>W</u>	<u>EA</u>	<u>W</u>	<u>EA</u>	<u>W</u>	<u>EA</u>
4-MCG	x	x	x	x	x	x	x	x	x	x	x	x
2,4,6-TCP		x		x								x
4,5-DCG			x				x		x	x	x	x
PCP		x		x	x	x				x		x
6-MCVN		?		?				x		x		x



was questionable. It is generally believed that these compounds result from chlorine-lignin reactions that presumably take place in the bleaching process. This could explain in part the presence of chlorinated phenolics in bleached Kraft pulps; however, the presence of chlorinated phenolics in the CTMP pulps studied which are not subjected to any chlorine treatment or in the UBKP-I pulp studied is unexplained. Some investigations carried out in Germany (55) have shown that lignin has the capability of absorbing chlorine from the environment. This factor would strongly affect the CTMP pulps, whose lignin content remains almost intact after the pulping and bleaching process. In addition, the presence of PCP may arise due to its use as a biocide and wood preservative for timber (40,43). Another strong possibility is that the unexpected chlorinated phenolics observed in the pulps studied, could be the result of contamination from the water used either during the pulping or bleaching processes of these pulps. A debatable possibility is that the plants themselves are capable of synthesizing their own chlorinated compounds in order to serve as in situ insecticides, pesticides, herbicides, etc. (2,56). Due to a lack of knowledge of the complete history of the pulps studied, it is difficult to pinpoint or even narrow down the reasons for the discovery of chlorinated phenolics in the above mentioned pulps.

After identifying the five chlorinated phenolics, an attempt was made to quantitate these compounds. The

conditions for quantitation were maintained identical to those used for qualitative work. For all these compounds the calibration curves appeared to be linear ( $R=0.999$ ) for the range of amount (0.25-3.0 ppm) studied. CTMP pulps and UBKP exhibited the lowest concentration of 4-MCG; whereas, BKP-II showed the highest amount of 4-MCG, 4,5-DCG and 6-MCVN in ethyl acetate extracts, Table 7. On the other hand, BKP-I and BKP-III showed rather low values for the five identified phenols in ethyl acetate extracts. The comparable amount of 2,4,6-TCP and the large quantity of 4,5-DCG in CTMP-II ethyl acetate extracts is striking. Finally, the greater amount of PCP in UBKP-I relative to each Kraft bleached pulp is noteworthy. Although water is ineffective at extracting 2,4,6-TCP, PCP, and 6-MCVN, larger quantities of 4-MCG and 4,5-DCG are extracted with water than with ethyl acetate. Considering the total chlorinated phenolics discovered, all the BKP water extracts contained about ten times more total chlorinated phenolics compared to the UBKP as well as the CTMPs. Therefore, CTMP-I water extract contained  $1.8 \times 10^{-6}$  gm of chlorinated phenolics per gram of extract obtained, while CTMP-II water extract contained  $1.3 \times 10^{-6}$  gm. Similarly, UBKP-I contained  $2.5 \times 10^{-6}$  gm per gram of extract. However,  $3.5 \times 10^{-5}$  gm of chlorinated phenolics studied were found in BKP-I,  $3.1 \times 10^{-5}$  gm in BKP-II and  $3.7 \times 10^{-5}$  gm in BKP-III per gram of water extracts. The corresponding amounts of chlorinated phenolics discovered in the ethyl acetate extracts of all

TABLE 7

Quantification of Chlorinated Phenolics Found  
via GC/EIMS

<u>Compound</u>	<u>Pulp</u>	<u>Water</u>	<u>Ethyl Acetate</u>
		<u>Mass/gm Pulp</u> <u>(ng)</u>	<u>Mass./gm Pulp</u> <u>(ng)</u>
4-MCG	CTMP-I	55	19
	CTMP-II	141	22
	UBKP-I	42	20
	BKP-I	134	41
	BKP-II	169	103
	BKP-III	81	34
2,4,6-TCP	CTMP-I	---	22
	CTMP-II	---	25
	BKP-III	---	22
4,5-DCG	CTMP-II	---	234
	BKP-I	103	---
	BKP-II	81	122
	BKP-III	81	97
PCP	CTMP-I	---	53
	CTMP-II	---	66
	UBKP-I	---	50
	BKP-II	---	38
	BKP-III	---	38
6-MCVN	BKP-I	---	56
	BKP-II	---	125
	BKP-III	---	4

the wood pulps studied, were an order of magnitude lower than in the water extracts.

In conclusion, the time varied selected multiple ion mass spectral approach was found to be reliable and a time-saver for simultaneously monitoring a large number of pre-selected compounds. The extracted ion chromatograms also served as useful confirmatory techniques. Of the 13 chlorinated phenolics monitored, only 4-MCG, 2,4,6-TCP, 4,5-DCG, PCP and 6-MCVN in the wood pulp extracts studied. Surprisingly, chlorinated phenolics are in practically all pulp extracts studied, whether bleached with chlorine or not. Lack of ability to obtain the complete history of the pulps studied, has hindered the pinning down of their exact causes. Nevertheless, these (quantitative and confirmatory) findings cast new light upon the source of chlorinated species in processed wood products. Since we were able to only identify five chlorinated phenolics of the 13 compounds examined by the time varied selected multiple ion mass spectrometry, further study with a more sensitive and selective mode of detection is discussed in the next chapter.

## **4.0 CHAPTER 4: GAS CHROMATOGRAPHY-NEGATIVE CHEMICAL IONIZATION MASS SPECTROMETRY OF CHLORINATED COMPOUNDS IN WOOD PULP EXTRACTS**

### **4.1 INTRODUCTION**

In previous chapters (Ch 2,3) we have discussed both the Soxhlet extraction of bleached CTMP and Kraft wood pulps (BKP & UBKP), as well as the analysis of the extracts by gas chromatography-electron impact ionization mass spectrometry (GC/EIMS). Extractions were individually performed with cyclohexane, ethyl acetate and water. With the former two solvents, less than 0.2% (w/w) could be extracted from any bleached wood pulp. On the other hand, 2-4% was extracted from CTMP's by water but less than 1% was extracted from BKP's by water. In an effort to identify some chlorinated compounds in selected extracts, thirteen known chlorinated compounds were examined using comparable GC/EIMS parameters. The compounds chosen were those which have a high probable occurrence in wood pulp mill effluents, e.g. 4-monochloroguaiacol (MCG); 4,5-dichloroguaiacol (DCG); 4,5,6-trichloroguaiacol (TCG); 2-monochlorophenol (MCP); 2,4,6-trichlorophenol (TCP); pentachlorophenol (PCP); 6-monochlorovanillin (MCVN); 4,5-dichlorocatechol (DCC); 3,4,5-trichlorocatechol (TCC); tetrachlorocatechol (TeCC);

4,5-dichloroveratrole (DCV); 3,4,5-trichloroveratrole (TCV) and tetrachloroveratrole (TeCV). Assignment of a GC/EIMS response from the extract to one of the thirteen standards was based on a match of the (a) mass spectra, (b) retention time and (c) chlorine isotopic pattern of the unknown and standard. The mass selective detector was operated in the single ion monitoring (SIM) mode. At specified time intervals selected ions were monitored as dictated by the retention time of each standard chlorinated compound in order to maximize the sensitivity of the measurement.

This time varied selected ion monitoring mode revealed a number of other responses in addition to the suspected standard material. The question as to whether these additional responses were an indicator of further chlorinated (but unspecified) material is the subject of this manuscript. The investigation had two aspects: (a) attempt further elucidation of chlorine-containing compounds from data obtained by previous time varied selected multiple ion monitoring and (b) confirm the presence of the "suspected" chlorinated compounds by gas chromatography-negative ion chemical ionization mass spectrometry (GC/NCIMS).

The most powerful methods of organic chemical analysis now available for the study of complex mixtures, are based upon the use of chromatography with mass spectrometric detection. NCIMS is a substantially 'milder' form of ionization than corresponding reactions between cations and

molecules (57). It is uniquely suited for screening trace quantities of environmental samples for toxic chemicals, because of its high sensitivity and selectivity for polychlorinated chemicals and its virtual transparency to potentially interfering compounds. This technique has been applied to screen for toxic residues such as chlorinated aromatic pesticides (58-61), chlorinated phenols, 2,4,5-trichlorophenoxy acetic acid (62-65), and polychlorinated biphenyls (65,66). High sensitivity for polychlorinated compounds has been observed (57,67,68). Negative ion CIMS has also been employed by Hass et al to measure polychlorinated dibenzo-p-dioxins in water extracts from municipal incinerator fly ash (64), soil and foam plugs (69) as well as in wood and biological tissues (70). Highest sensitivity was achieved in the latter work by using methane as a reagent gas. Hunt and co-workers (71-73) have reported simultaneous positive and negative ion CIMS using a Townsend discharge ion source and methane, nitrogen, oxygen and methyl nitrite as reagent gases. Their results on aromatic compounds indicated that compared to positive ion CIMS, negative ion CIMS can provide a 100- to 1000-fold increase in sample ion current, unique structural information and confirmation of sample molecular weight. Polyhalogenated aromatic hydrocarbons have been studied using NCIMS with various reagent gases such as methane, methane/methylene chloride and methane/oxygen (74). Excellent reviews on NCIMS have also been published (75,76).

The investigations mentioned above indicate that NCIMS is a technique well suited for providing additional information on xenobiotic chemicals in our environment. Of particular interest here is the capability of detecting and identifying picogram quantities of chlorinated aromatics in wood pulp solvent extracts.

#### **4.2 EXPERIMENTAL**

The extraction solvents used were ethyl acetate, HPLC grade purchased from Burdick & Jackson and distilled-deionized water. The wood pulps employed for this mass spectrometric investigation originated from various softwoods. UBKP-I was a Kraft pulp not subjected to any bleaching process, while BKP-I, BKP-II and BKP-III were derived from the Kraft multistage bleaching process. CTMP-I and CTMP-II are pulps bleached by the peroxide process. Great care was taken to ensure that all the glassware for each extraction was free from any memory effects from previous extractions. Details of the procedure for Soxhlet extraction, concentration and drying can be found in chapter 2. Each dried extract was dissolved in its respective extraction solvent and filtered if necessary. The reconstituted solution was then used for analysis by GC/EIMS and GC/NCIMS.



#### 4.2.1 GC/EIMS

GC/EIMS was performed by directly coupling a Model 5890A gas chromatograph (Hewlett-Packard) with a Model 5970 Series Mass Selective Detector (Hewlett-Packard). The gas chromatograph was equipped with a splitless/split capillary column inlet system. A 30 m x 0.25 mm i.d., 0.25  $\mu$ m film thickness, SPB-20 bonded phase (20% diphenyl - 80% dimethylpolysiloxane) fused silica column was used. The carrier gas was helium and the transfer line was maintained at 250°C. The injector temperature of the capillary inlet system was set at 280°C. The temperature program employed was as follows: initial oven temperature was maintained at 85°C for 1 minute, then ramped at 8°C/min. to 260°C and held there for 10 minutes. The injection volume was 1  $\mu$ L of reconstituted solution. All the injections were done manually making use of a Hamilton Microliter Syringe. Mass spectra were obtained at an electron beam energy of 70 eV. The ion source temperature was maintained at 200°C. The scan threshold was set at 1000 and the resulting voltage was 2200 volts. The mass spectrometer was operated in the SIM mode with a 100 msec. dwell time for each mass ion. Data were processed using an HP 59970 C Chem Station.

The time varied SIM data employed in this study were obtained as described previously (Ch 3). Two GC/EIMS analyses of each extract were necessary in order to eliminate time increment overlaps. Table 8 lists the various mass ions monitored together with the

TABLE 8

Time Varied Selected Ions Monitored By GC/EIMS

Run A

Mass Ions Monitored (amu)	Chrom. Time Monitored (min)
-----	-----
158, 160	0.0-12.8
196, 198, 200	0.0-12.8
192, 194	12.8-15.0
240, 242, 244	15.0-16.0
178, 180	16.0-16.5
226, 228	16.5-17.2
274, 276, 278	16.5-17.2
264, 266, 268	>17.2

Run B

128, 130	3.8-13.0
206, 208, 210	13.0-14.0
185, 186, 187, 188	14.0-14.9
212, 214, 216	14.9-17.8
246, 248, 250	>17.8

chromatographic time intervals during which they were monitored.

#### 4.2.2 GC/NCIMS

For the investigation by GC/NCIMS, only Kraft pulps were studied. A Model 5840A (Hewlett-Packard) gas chromatograph was directly coupled to a Hewlett-Packard 5895, High Resolution Mass Spectrometer. Primary ionization of the reagent gas was accomplished using a 230 eV beam of electrons operated from a heated metal filament. High purity methane served as both the GC carrier gas and the CI reagent gas whose flow rate through the column was adjusted to give a pressure of 1 Torr in the CI source. Source temperature was set at 120°C and the pressure in the analyzer was maintained at  $2 \times 10^{-4}$  Torr. The injector was set at 280°C. The transfer line temperature was kept constant at 260°C. The GC was equipped with an open-split interface, purchased from Scientific Instrument Services, Austin, TX. The volume of reconstituted solution manually injected was 1  $\mu$ L. Data were processed using an HP 1000E Series Computer. This GC/NCIMS investigation was carried out at North Carolina State University, Raleigh, NC.

Model chlorinated standards (Table 9) were purchased from AccuStandard, New Haven, CT and Helix Biotech. Corp. Vancouver, B.C., Canada. The standards were dissolved in either distilled, deionized water or HPLC grade methanol purchased from Fisher Scientific.

TABLE 9

## Model Chlorinated Compounds

Compound	Mol. Wt.	R.T. (min)
2,4,6-TCP	196	10.6
2,3,4,6-TeCP	230	14.0
PCP	264	17.4
4-MCG	158	9.5
4,5-DCG	192	13.1
4,5,6-TCG	226	16.9
3,4,5-TCG	226	15.9
3,4,5-TCV	240	15.5
TeCV	274	16.6
6-MCVN	186	14.5

### 4.3 RESULTS AND DISCUSSION

In our previous investigation we were able to identify and quantitate in selected pulp extracts 2,4,6-TCP, PCP, 4-MCG, 4,5-DCG and 6-MCVN at the parts per billion level by GC/EIMS in the SIM mode. Further scrutiny of the data revealed a number of other GC peaks which were of even greater intensity than the identified compounds. Therefore it was of interest to determine if the components giving rise to these additional peaks were chlorinated. The assignment was made by taking note of the monitored mass ion peak ratios to determine if the ratio matched either an anticipated mono-, di-, tri-, tetra- or penta-chloro isotopic pattern.

The time varied SIM of BKP-II water extract is shown in Figure 22. By referring to Table 8 and noting that this presentation corresponds to GC/EIMS Run A, the various ions which were monitored as a function of time can be ascertained. Four major peaks are seen. Two peaks are identified as MCG and DCG while the other two peaks are believed to contain one and two chlorine atoms respectively. (i.e. ~ 7.8 min; 158, 160 -mono and ~ 13.9 min; 192,194 - di). On the other hand, the CTMP-I ethyl acetate extract time varied SIM (Figure 23) exhibits over a dozen peaks of which only four appear to have one of the chlorine isotopic patterns. MCG, TCP, and PCP were identified earlier. Only the small peak around 9.5 minutes had a characteristic ratio (i.e. mono). As to whether these designated peaks are

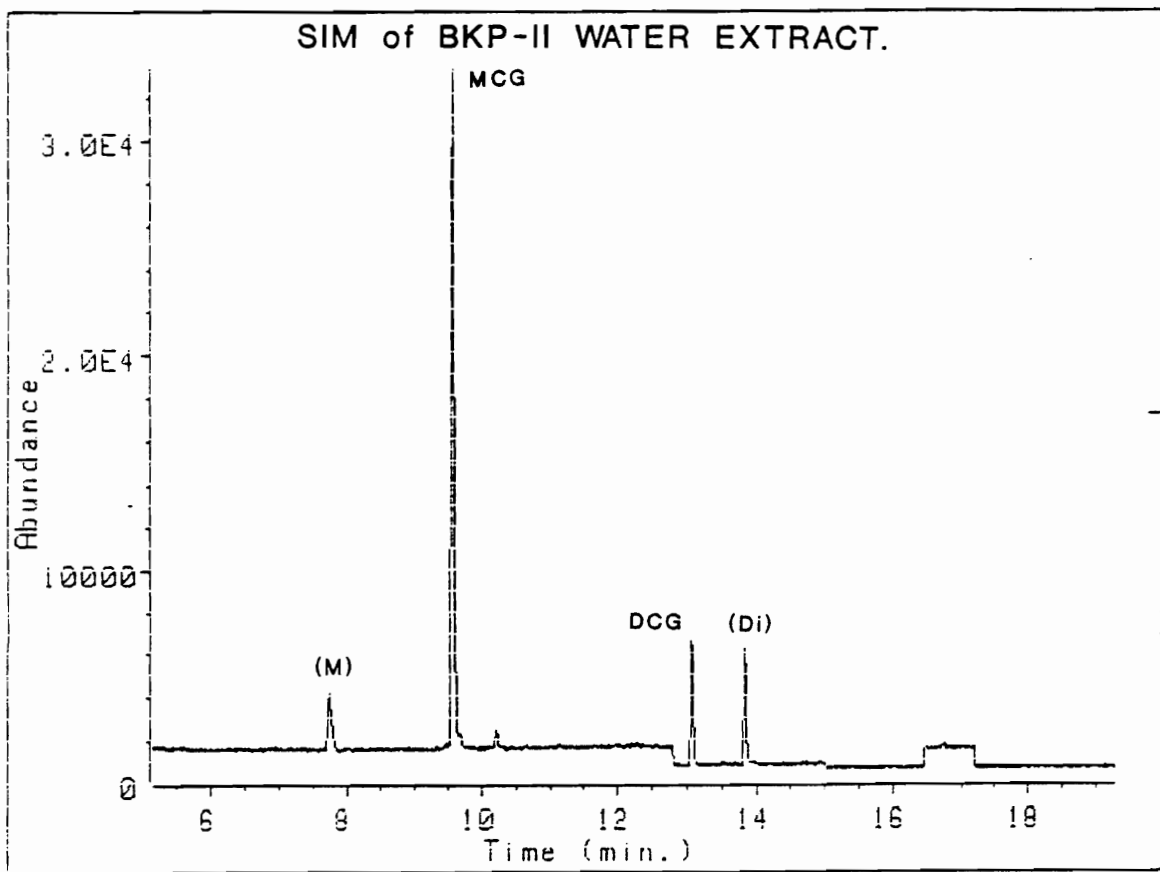

Figure 22. Selected ion monitoring mass spectrum of BKP-II water extract by GC/EIMS: Conditions same as in Figure 17.

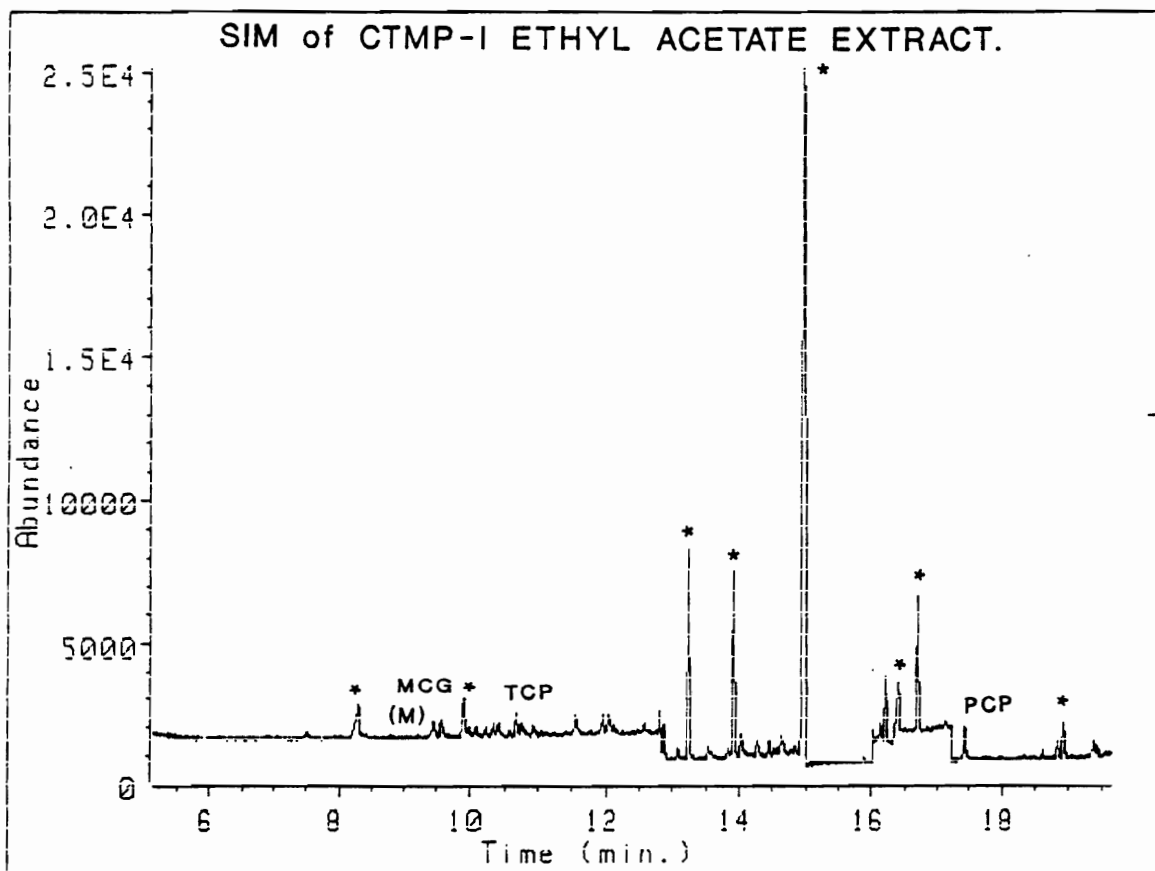

Figure 23. Selected ions monitoring mass spectrum of CTMP-I ethyl acetate extract: GC/EIMS conditions same as in Figure 17.

parent ions is an open question. Fragment ions cannot be excluded since the mode of ionization was EI.

The new chlorinated compound/fragment ions discovered via this technique in the water extract of all wood pulps studied are listed in Table 10. Also listed in the Table are the approximate retention times and the relative abundance of each chlorine-containing chromatographic peak. The dichloro component at 13.9 minutes appears to be common to CTMP-II and all BKP's. A similar situation probably exists at 7.8 minutes where a monochloro component is observed in all BKP's. It is also interesting to note that the UBKP water extract showed no new chlorine-containing material; whereas, in our earlier study with thirteen known standards both 4-MCG and PCP were observed in the UBKP product. The additional monochloro species at 7.9 minutes in BKP-I possibly indicates the presence of an isomer to the component eluting at 7.8 minutes. A further illustration of this situation may exist for the two monochloro components eluting at 11.2 and 11.3 minutes in the BKP-III water extract.

Table 11 summarizes the new chlorinated components found in this study in the ethyl acetate extracts of all pulps studied. Again, several common species seem to be present in more than one pulp as judged by the same retention time and chlorine designation. In contrast to the water extracts, which were predicted to contain mostly monochloro components, the ethyl acetate extracts contain



TABLE 10

Unknown Chlorine-Containing Parent/Fragment Ions found  
in Water Extracts via Time Varied Selected Ion Monitoring

Retention Time (min)	WOOD PULPS					
	CTMP-I	CTMP-II	UBKP-I	BKP-I	-II	-III
5.0	---	M(m) <sup>a</sup>	---	---	---	---
7.8	---	---	---	M(m)	M(s)	M(s)
7.9	---	---	---	M(s)	---	---
10.2	---	M(s)	---	---	---	---
11.2	---	---	---	---	---	M(s)
11.3	---	---	---	---	---	M(s)
11.7	M(s)	---	---	---	---	---
13.9	---	Di(m)	---	Di(l)	Di(m)	Di(s)
16.7	---	---	---	T(s)	---	---

<sup>a</sup>M-Monochloro; Di-Dichloro; T-Trichloro;  
(s)-small; (m)-medium; (l)-large.

TABLE 11

Unknown Chlorine-Containing Parent/Fragment Ions found in  
Ethyl Acetate Extracts via Time Varied Selected Ion  
Monitoring

Retention Time (min)	WOOD PULPS					
	CTMP-I	CTMP-II	UBKP-I	BKP-I	-II	-III
7.2	---	M(s) <sup>a</sup>	---	---	---	---
7.5	M(s)	M(m)	---	---	---	---
7.8	---	---	---	M(s)	M(s)	---
9.0	Di(s)	---	---	---	---	---
9.4	---	M(s)	---	---	---	---
9.5	M(s)	---	M(s)	---	---	M(s)
10.2	---	Di(s)	---	---	---	---
10.7	---	M(s)	---	---	---	---
11.2	---	---	Di(s)	---	---	---
11.7	---	---	Di(s)	---	M(m)	M(s)
11.8	---	T(s)	---	---	---	---
11.9	---	T(s)	---	---	---	M(s)
12.0	---	---	Di(s)	---	M(s)	---
12.4	---	---	---	---	---	M(s)
12.6	---	---	---	---	---	M(s)
12.7	---	---	Te(s)	---	---	---
13.1	P(s)	Di(s)	Di(s)	Di(s)	Di(s)	Di(s)
14.4	---	---	---	M(s)	---	M(s)
16.6	---	---	---	---	---	T(s)
16.7	---	---	---	---	---	M(s)

<sup>a</sup>M-monochloro; Di-Dichloro; T-Trichloro; Te-Tetrachloro;  
P-Pentachloro;  
(s)-small; (m)-medium, (l)-large.

more dichloro as well as a tetrachloro (12.7 min) and pentachloro (13.1 min) species. The number of additional peaks believed to contain chlorine varies with the pulp (i.e. BKP-I, 3 components; BKP-III, 9 components; CTMP-II, 8 components). A number of analogies and comparisons could be drawn but no conclusive evidence about the exact identity of the suspected chlorinated compounds was possible due to the following: 1) no standards were used that matched the retention time of these newly found components, 2) the analysis was done in the SIM mode ( $\leq$  four mass ions) to obtain the best sensitivity possible in order to detect trace components and hence a complete mass spectrum was not possible under these conditions, and 3) the chlorinated patterns recorded could very well be fragments obtained from higher undetected chlorinated compounds due to EI ionization.

Even though the mechanism of sample ionization is the same under both GC/ECD and GC/NCIMS under electron capture conditions, GC/NCIMS has pronounced advantages over GC/ECD. First, NCIMS measures negative ion abundance rather than the variation in the standing current as in ECD. Hence the former technique is expected to be at least 10 - 100 times more sensitive. Secondly, NCIMS gives valuable information concerning sample molecular weight and structure. Moreover, mass resolution in NCI serves the same function as time resolution in GC. However, by using a high resolution mass spectrometer, it is possible to obtain mass resolution of

the order of 1 part in  $10^4$ , which is considerably higher than is available with time resolution in a conventional GC. Next, the reduction in chemical interferences by mass analysis also contributes to the lower detection limit for the NCI system as compared to GC (62). Other vital advantages can be found in the literature (77,78).

When methane is bombarded at 1 Torr (130 Pa) with 230 eV,  $\text{CH}_5^+$  and  $\text{C}_2\text{H}_5^+$  are generated in high abundance (79), as indicated in equations 6-8,

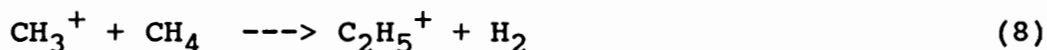
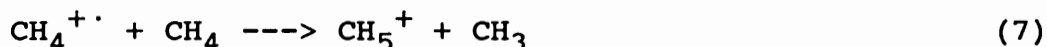
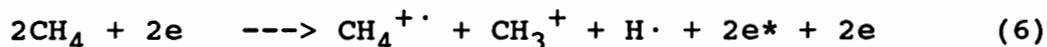

The formation of each positive reagent ion (eg.  $\text{CH}_4^{+\cdot}$  and  $\text{CH}_3^+$ ) is accompanied by the production of a low energy electron ( $e^*$ ) (73). Each ionizing event removes about 30 eV energy from the bombarding electron (81) and the energy of the incident electron beam is further reduced by additional non-ionizing collisions of electrons with neutral methane molecules (50). Hence operation of a mass spectrometer under methane CI conditions affords a mixture of both positive reagent ions and electrons with thermal or near thermal energies. As indicated in several recent reviews (75,76), formation of negative ions by interaction of electrons and sample molecules can occur by 3 different mechanisms.

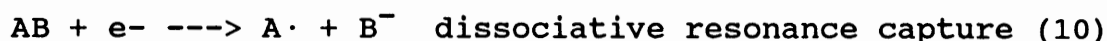



Each of these processes shows a strong dependence on electron energy. Resonance capture affords molecular ions and involves electrons with energies near 0 eV. Dissociative electron capture is observed with electrons in the energy range of 0-15 eV, while ion-pair production usually requires electron energies above 10 eV. The lowest energy process for the formation of a negative ion in methane involves capture of ca. 10 eV electrons and leads to the production of  $H^-$  which ultimately results in the formation of  $OH^-$  (81). Fortunately, the reactions leading to the formation of  $OH^-$  have been found to play a minor role under CI conditions (72). Gas phase negative ion molecule reactions which proceed at the diffusion controlled limit exhibit rate constants near  $1 \times 10^{-9} \text{ cm}^3\text{s}^{-1}$  (82). In contrast, the rate constant for the formation of a negative ion by electron capture can be as high as  $4 \times 10^{-7} \text{ cm}^3\text{s}^{-1}$  (83). Therefore ionization of the sample in the NCI mode will occur predominately by electron capture. Enhanced sensitivity in the electron capture NCI mode will only be realized for sample molecules which possess a positive electron affinity and a large cross section for electron capture.

The free radical  $AB^{\cdot-}$  formed in equation 9 can be relaxed to a stable electronic state via a number of processes which include spontaneous ejection of the extra (odd) electron, emission of light, fragmentation and

collision with a reagent molecule. Generally, symmetrical anions which are forced to remain in the excited state for a longer period of time due to less availability of nondegenerate energy levels, are more prone to relax to their ground states by processes such as auto-ejection or dissociative electron capture. The chlorinated compounds investigated in this study are believed to fall in this former category. The stable anions thus formed are then detected in the mass spectrometer.

The extracted ion chromatograms for  $m/e$  196 and 198 are depicted in Figure 24a; while, Figure 24b demonstrates the total ion current chromatogram (TIC) in the NCI mode for the BKP-III ethyl acetate extract monitored between 130 - 300 amu. As is evident in Figure 24b between 8.0 and 12.8 minutes, a number of peaks are visible which are of much higher intensity, but not of interest in this study since our focus was on 2,4,6-TCP which has a retention time of 10.8 minutes. The extracted ion chromatograms at  $m/e$  196 and 198 indicate the ratio expected for a trichlorinated pattern. The mass spectrum obtained at 10.8 minutes (Figure 25) also shows the isotopic trichlorinated parent ion cluster. Also as seen in Figure 25, CI with methane as the reagent gas affords spectra which contain abundant ions in the molecular weight region of the spectrum and few structurally insignificant low molecular weight fragment ions. Similar observations have been reported (84) when comparing CI to conventional EI.

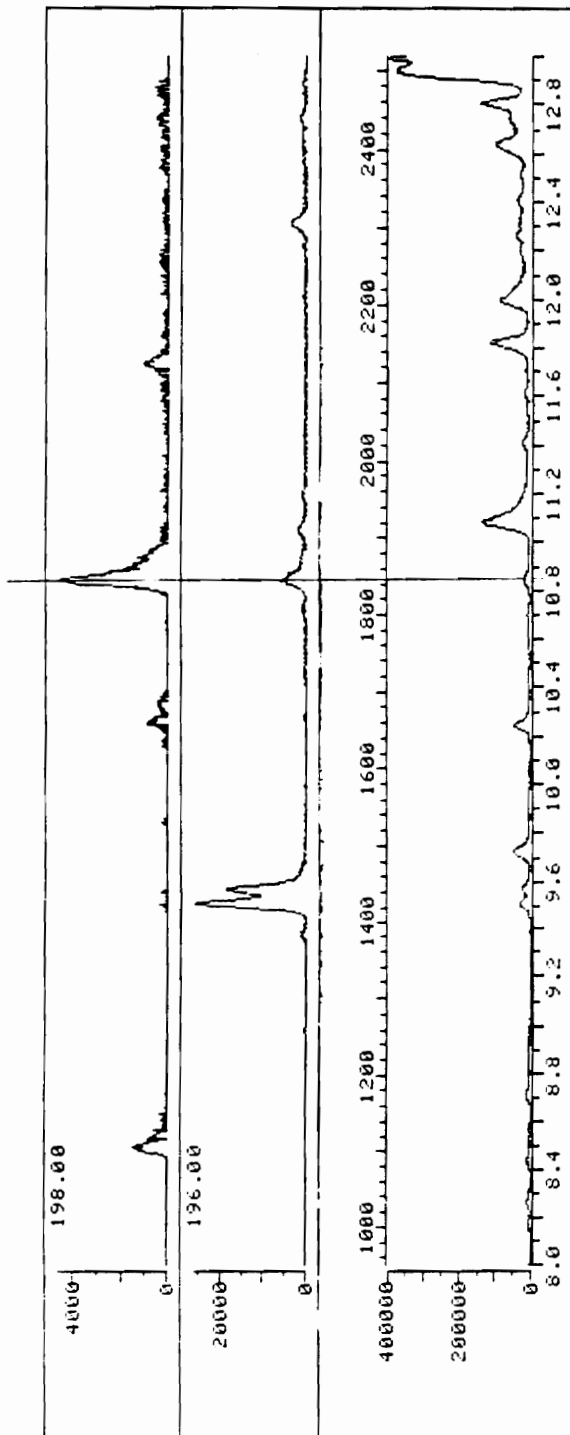

**Figure 24a.** Extracted ions chromatograms of mass ions 196 and 198 between 8.0 and 12.8 minutes from BKP-III ethyl acetate extract by GC/NCIMS: Injector: open-split at 280°C; Carrier: methane; Column, injection volume and temperature program same as in Figure 22. NCI energy: 230 eV; Source pressure: 1 torr; Analyzer pressure:  $2 \times 10^{-4}$  torr; Reagent gas: methane; Ion separation: Quadrupole rods; Source temperature: 120°C.

**24b.** Total ion current chromatogram of BKP-III ethyl acetate extract by GC/NCIMS: Conditions identical to those in Figure 24a.

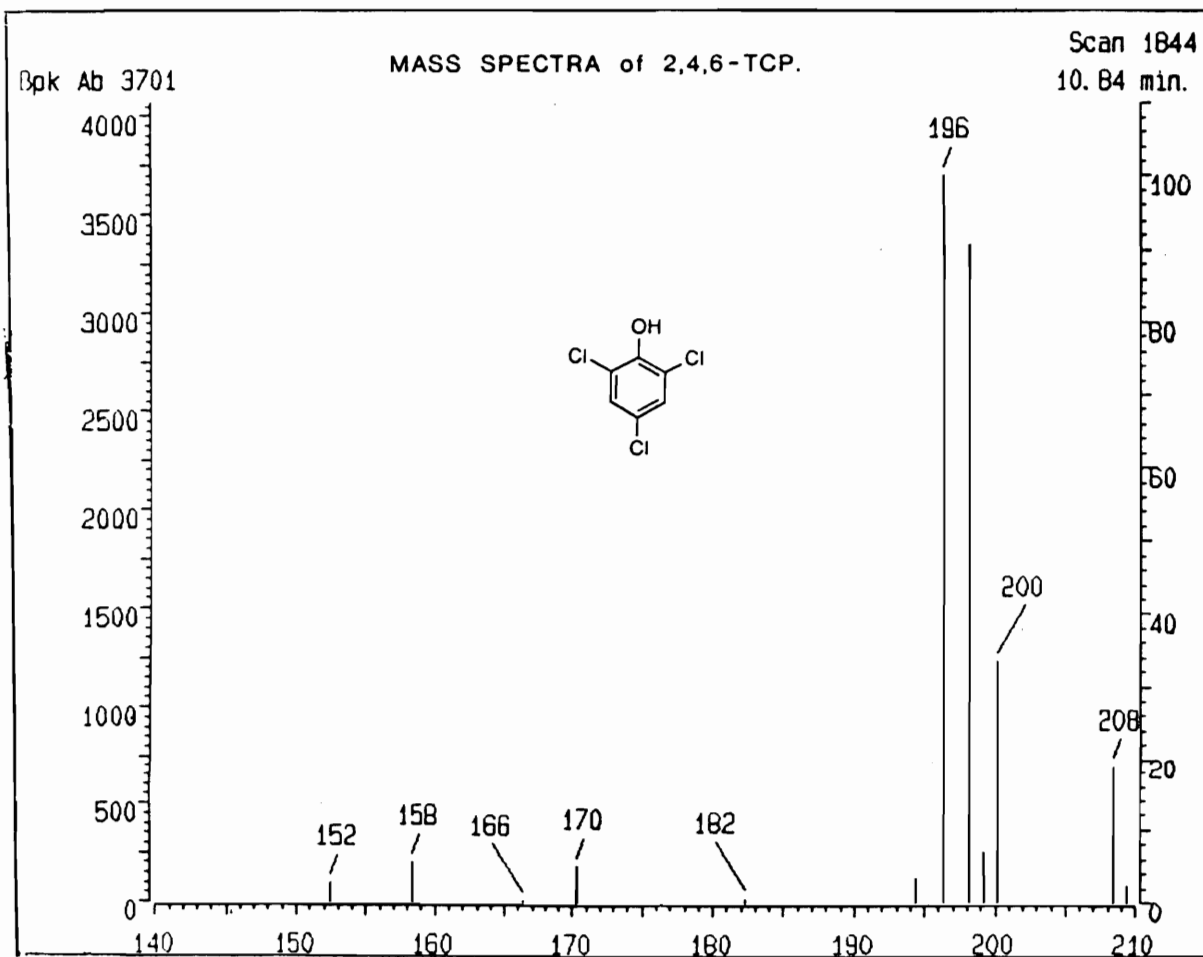

Figure 25. Mass spectrum of 2,4,6-TCP found in BKP-III ethyl acetate at 10.8 minutes: GC/NCIMS conditions same as in Figure 24a.



Although no standard was available for TeCG, it was scrutinized for a range of 5 minutes, from 15-20 minutes based on the trend of retention times observed for 4-MCG, and 4,5-DCG (Ch 3) as well as 4,5,6-TCG and 3,4,5-TCG in this study. As can be seen in Table 12, TeCG was not found in any of the extracts examined by GC/NCIMS and it was not examined by GC/EIMS.

Since two isomers of TCG (4,5,6-TCG and 3,4,5-TCG) were discovered in the extracts examined, an attempt was made to find out if the other isomers were present based on their typical mass spectra, inspite of the fact that the standards were not available. Figure 26 depicts the mass spectrum of the 'other-TCG' found in BKP-I and BKP-II water extracts by NCIMS at a retention time of 13.9 minutes. This is a typical mass spectrum observed for trichloroguaiacols whose molecular weight is 226. Possibly the m/e at 192 is due to  $(M - Cl + H)^+$ . We may recall that ionization by EI in the SIM mode gave a large signal at 13.9 minutes but with a dichlorinated pattern. It is our firm understanding that this 'other-TCG' identified by NCIMS must have undergone fragmentation during EIMS. Ionization by EI affords odd-electron radical cations initially and delocalization of the unpaired electron occurs readily in most of these molecular ions (72). Hence much of the fragmentation observed in EI spectra can be rationalized as having been triggered by the unpaired electron.

TABLE 12

Identification of Chlorinated Compounds by  
GC/EIMS and GC/NCIMS

COMPOUND	CTMP-I		CTMP-II		UBKP-I		BKP-I		BKP-II		BKP-III	
	W*	EA*	W*	EA*	W*	EA	W	EA	W	EA	W*	EA
2,4,6-TCP		X		X				#				X#
2,3,4,6-TeCP								#				
PCP		X		X	X	X		?		X		X
4-MCG	X	X	X	X	X	X	X	X	X	X	X	X
4,5-DCG			X				X	X	X	X	X	X
4,5,6-TCG							?	#		#		#
3,4,5-TCG							#		#	#		#
Other-TCG							#		?			?
TeCG												
3,4,5-TCV												
TeCV												
6-MCVN		?		?				X		X		X
U-MC(M.W. 184)							#	#				#

\*Extracts not studied by GC/NCIMS

X - Identification by GC/EIMS in SIM mode

# - Identification by GC/NCIMS

? - Questionable identification.

U-MC - Unidentified monochloro compound

# MASS SPECTRA of 'TCG'.

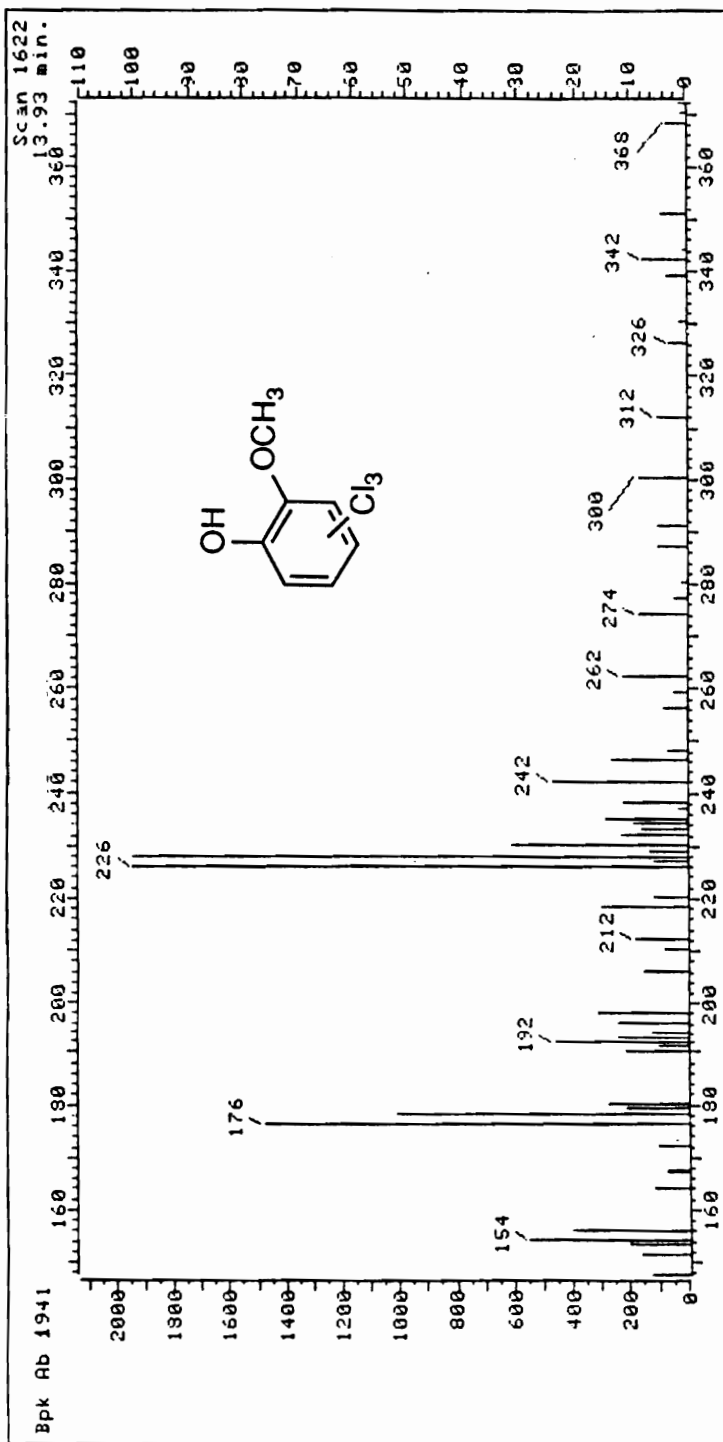
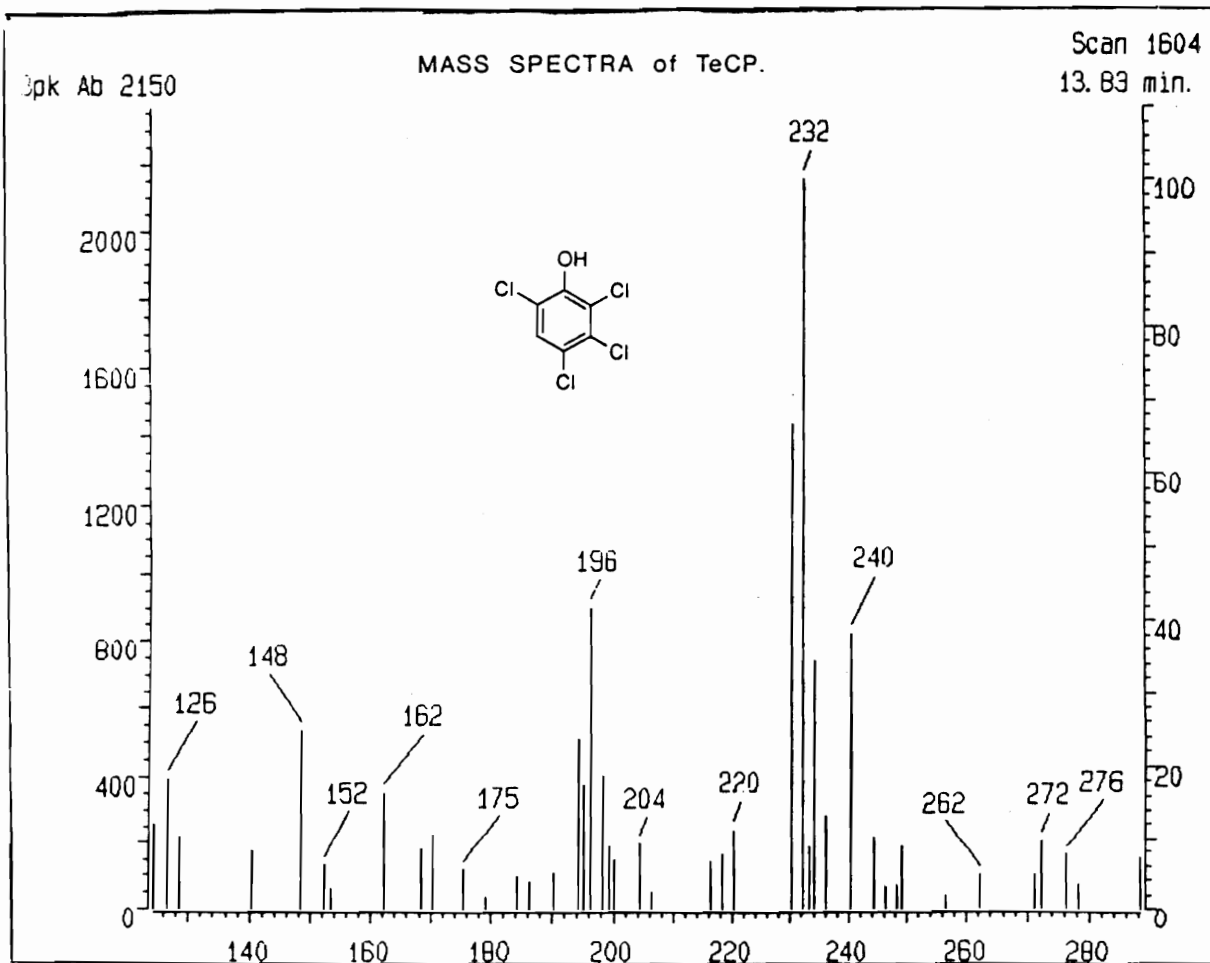

Figure 26. Mass spectrum of Other-TCG in BKP-I water extract at 13.9 minutes: GC/NCIMS conditions same as in Figure 24a.

The mass spectrum of 2,3,4,6-TeCP identified in BKP-I water extract (Figure 27), was observed to exhibit a slight deviation from the expected isotopic ratios of 0.8:1.0:0.5. This departure from the expected ratios could be due to a weak signal obtained. Again the m/e at 196 is probably due to  $(M - Cl + H)^-$ . It is our belief that the large number of mass ions observed could be due to the co-elution of many components in the complex wood pulp extracts. A special consideration for NCIMS is to keep the ion source cool (73) because as the source temperature is increased the probability for dissociative electron capture increases while the probability for resonance electron capture decreases. Consequently, this results in the production of  $Cl^-$  which detracts from the identification of the parent compound. Hence, in our study the source temperature was maintained at 120°C.

A summary of the chlorine-containing compounds detected by GC/EIMS in the SIM mode and GC/NCIMS, is shown in Table 12. A major problem with NCIMS is that it responds poorly to halogenated compounds with 1-2 halogens (74). This has been verified in our study where 4-MCG, 6-MCVN and 4,5-DCG could be repeatedly identified in EIMS using SIM but could not be found by NCIMS. This correlates with the low signal intensity observed when using ECD for these compounds, i.e. electron affinity increases rapidly with increasing chloride content (50). Therefore focussing on the higher chlorinated materials, 2,4,6-TCP was found in BKP-I water and BKP-III



**Figure 27. Mass spectrum of 2,3,4,6-TeCP in BKP-I water extract at 13.8 minutes: GC/NCIMS conditions same as in Figure 24a.**

ethyl acetate by GC/NCIMS but only in the latter extract by GC/EIMS. As observed in Table 12, 2,4,6-TCP was also identified in both CTMP ethyl acetate extracts by GC/EIMS but these extracts were not examined by GC/NCIMS. 2,3,4,6-TeCP was only found in BKP-I water extract. Although the presence of 4,5,6-TCG in the BKP-I water extract is questionable, it was confirmed in all the BKP ethyl acetate extracts. A similar situation was observed with the 'other-TCG', wherein its presence in BKP-II water and BKP-III ethyl acetate was unsure, but it was confirmed in BKP-I water extract. Identification of 3,4,5-TCG in BKP-I and BKP-II water extracts as well as in BKP-II and BKP-III ethyl acetate extracts was made by GC/NCIMS. It is noteworthy that this compound was not examined by GC/EIMS.

There were two surprising findings from the NCIMS work. First, a monochloro compound was detected at 17.1 minutes having a molecular weight of 184 amu (Figure 28). Under typical NCI conditions, an ion must survive for  $10^{-7}$  -  $10^{-8}$  seconds before it experiences a stabilizing collision with a molecule of reagent gas (72). Compounds that fulfil the above criteria also include those that contain an alpha-dicarbonyl unit or its vinylogous homolog, extended conjugation, or strong electron withdrawing substituents attached to a site of unsaturation. So, even though a monochloro compound has a low response with NCIMS, the detection of the unidentified monochloro compound (M.W. 184) in three extracts i.e. BKP-I water, BKP-I ethyl acetate and

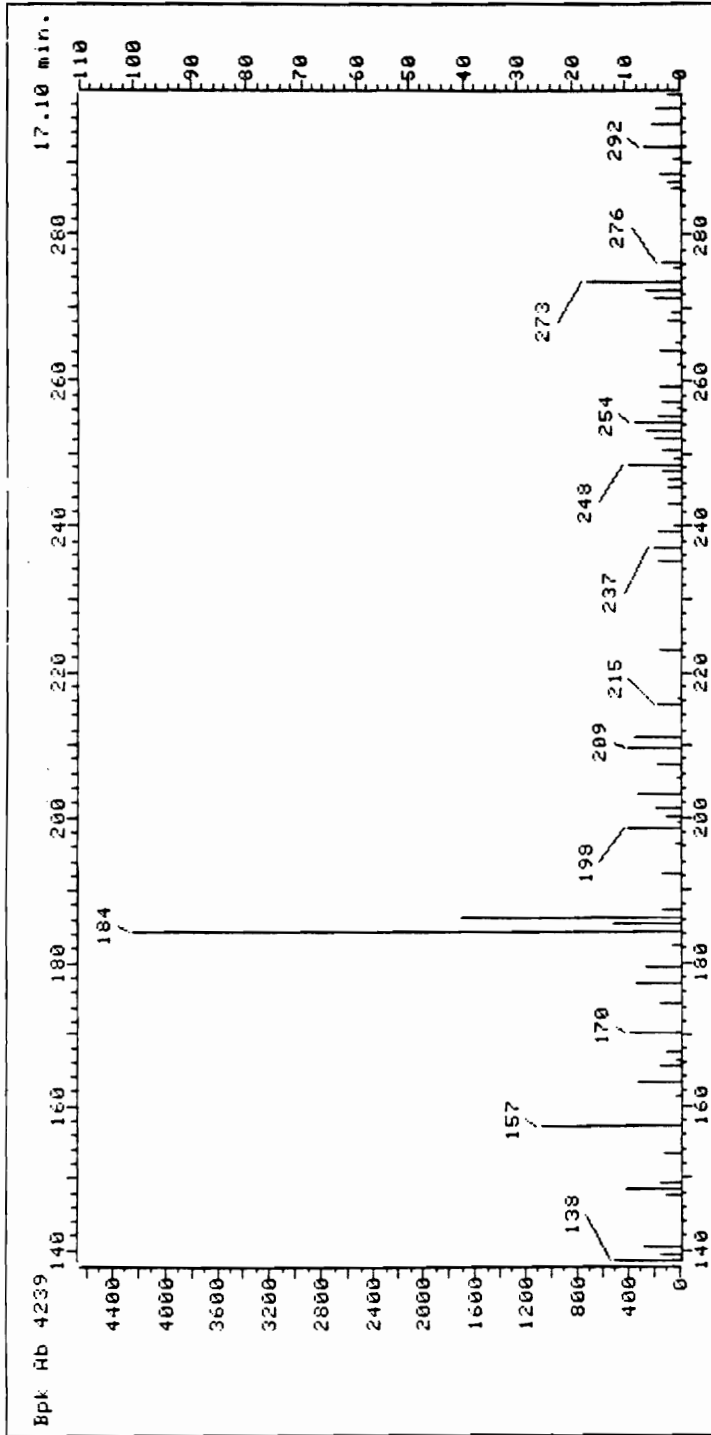

**Figure 28.** Mass spectrum of unidentified monochloro compound (MW 184) in BKP-III ethyl acetate extract at 17.1 minutes: GC/NCIMS conditions same as in Figure 24a.

BKP-III ethyl acetate extract is probably due to this monochlorinated compound possessing one or more of the above mentioned characteristics. It is highly probable that the large number of mass ions observed in Figure 28 were due to co-eluting components. Second, although PCP was identified in a number of extracts by EIMS with SIM, it was not easily identified by NCIMS. Important considerations are that the electron capture process is competitive and that negative ion signals tend to saturate at levels as low as 10 ng (74). Hence, if two components are in the source at the same time, low concentration components might not be observed in the presence of more abundant components. This has been observed to be the case judging from the very small peaks observed by EIMS (Ch 3). Besides, the predominant mode of ionization for PCP is dissociative electron capture (85). As mentioned earlier the source temperature chosen for this study may not have been conducive for the above mode of ionization.

Attention may be drawn to the fact that due to a lack of knowledge of the exact history and background of the wood pulps studied, it is not possible to nail down the reason for the presence of these chlorinated compounds in these wood pulp extracts. As regards NCIMS, there is not a large amount of library data available to aid in the interpretation of unknown spectra. However, for the identification of the chlorinated compounds it served as an ideal complementary technique to the SIM mode of EIMS.



## **5.0 CHAPTER 5: SUPERCRITICAL FLUID EXTRACTION OF WOOD PULPS**

### **5.1 INTRODUCTION**

The extraction of components from a solid matrix with a liquid ranks with distillation as one of the most useful sample concentration/preparation techniques. Most of the modern food, pharmaceutical, cosmetic and oil industries had their origin in liquid-solid extraction processes. Recent studies have demonstrated that the use of supercritical fluids for analytical extraction provides a powerful alternative to the traditional liquid solvent extraction methods (86-95).

Although the extraction of wood constituents with supercritical fluids has been reported recently, no SFE on wood pulps have been published. The attempts at supercritical fluid extraction of wood are due in part to the interest in making use of the chemical compounds found in wood (96-99). Additionally, the problems associated with current wood preparation processes for pulping indicate a need to seek alternative methods for extraction of lignin (100-105). Kinetic models (106,107) have been proposed for the delignification of wood. The liquefaction of wood components at temperatures up to 400°C with various SF

solvents was attempted (108). The effect of SF-CO<sub>2</sub> on the structure of wood and its fibre (109) was also studied.

Extraction by supercritical fluids offers advantages over the traditional liquid solvent extraction methods because of the high diffusivity and low viscosity. SF-CO<sub>2</sub> is by far the material most frequently used in SFE due to the fact that it is chemically inert and has a low critical temperature and pressure (31.1°C and 72.8 atm). It also has low toxicity, is available at low cost and can be used to extract compounds that are thermally unstable, with good recovery. Correlations made using the Hildebrand solubility parameter (110,111) for the solvent strength of SF-CO<sub>2</sub> indicate that it is an excellent extraction medium for non-polar species such as alkanes and terpenes [ $\delta \sim 6-8$ ]. It is reasonably good for moderately polar species including aldehydes, alcohols, esters, polycyclic aromatic hydrocarbons (PAHs), polychlorinated biphenyls (PCBs), organochlorine pesticides and fats (111). Unfortunately, SF-CO<sub>2</sub> does not have sufficient solvent strength at typical working pressures (80-600 atm) to extract analytes that are highly polar. This problem can be overcome by using SF-CO<sub>2</sub> containing an organic modifier such as methanol, methylene chloride, toluene, (112-115) etc.

In our investigation a CTMP and a BKP pulp were extracted with SF-CO<sub>2</sub> and SF-CO<sub>2</sub> modified with 2% MeOH. The results obtained with the two pulps were compared as well as

results for the two extraction fluids with the same pulp.

Comparisons were made based on:

- 1) percent extractives obtained per air dried wood pulp and
- 2) analysis of the volatile extract components by GC/MS.

## 5.2 EXPERIMENTAL

Two wood pulps were compared in this study. The CTMP pulp, obtained from Northern softwoods, was bleached by the peroxide process while BKP, obtained from Southern softwoods, was bleached by the multistage chlorination process. Both these pulps were provided by an industrial sponsor.

All SFE experiments were carried out using the Hewlett Packard (Avondale, PA) 7680A Supercritical Fluid Extractor whose schematic is shown in Figure 29. The pump used in SFE must generate high pressure, deliver reproducible volumes and supply at a constant flow rate. A dual piston reciprocating pump was used for this purpose with the capability of delivering fluid at 0.5-4.0 mL/min flow rate. The major disadvantage of a reciprocating pump is that the pump head must be cooled to pump the liquid CO<sub>2</sub>. Low cost cryogenic-grade CO<sub>2</sub> was used to cool the pump head as well as to cool the extraction chamber and the analyte trap. The extraction vessel or thimble (Hewlett Packard) was a thick walled stainless steel tube of 7 mL volume. The caps at each end contain porous frits to hold the sample in place and to form high pressure seals when the extraction chamber closes. The thimbles must withstand the high pressure

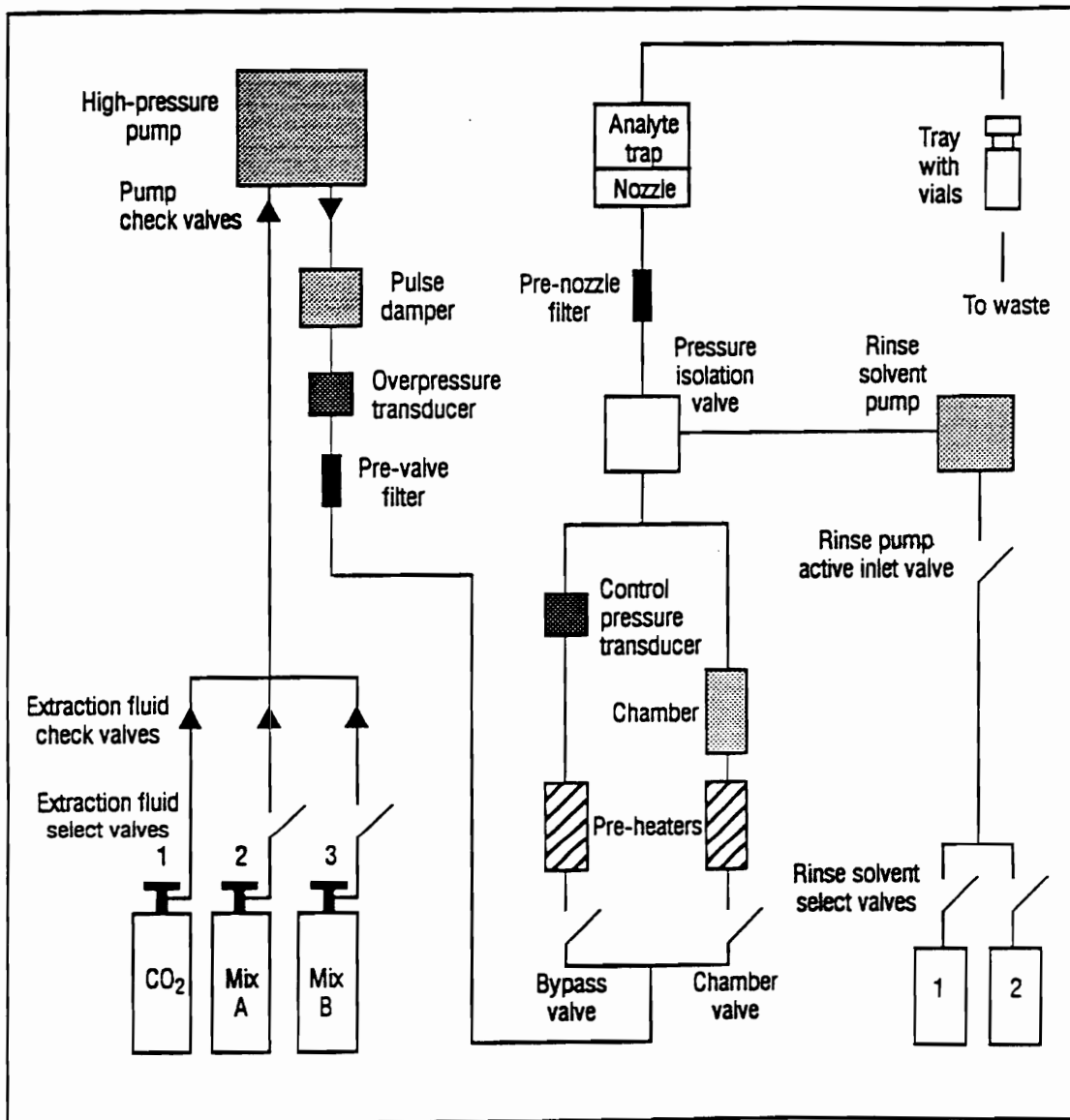

**Figure 29. Schematic of HP 7680A Supercritical Fluid Extractor.**

generated by the pump as well as be inert. The variable restrictor regulates pressure independent of flow rate. The purpose of the restrictor was to maintain the extraction thimble under pressure and provides an interface to the trap which operates at atmospheric pressure. The analyte trap was packed with either a) small stainless steel balls having diameters of 0.36-0.43 mm and a void volume of about 450  $\mu\text{L}$  per trap or b) Hypersil ODS (30-40  $\mu\text{m}$  diameter) and a void volume of about 650  $\mu\text{L}$  per trap. The analyte rinsing device consisted essentially of a high performance liquid chromatography (HPLC) pump which pumps the solvent of choice onto the trap and into glass collection vials of 2 mL capacity. The two rinse solvents used in this research were a)  $\text{CH}_3\text{OH}$  and b) methylene chloride ( $\text{CH}_2\text{Cl}_2$ ). Both were HPLC grade and were purchased from Fisher Scientific.

The extraction fluids, purchased from Scott Speciality Gases (Plumbsteadville, PA), were of SFC Grade, equipped with full-length eductor tubes and were used without purification. These fluids were 100%  $\text{CO}_2$  and a premixed commercial blend of 2% MeOH modified  $\text{CO}_2$ .

### **5.2.1 Supercritical Fluid Extraction Procedure**

About 1.5 gm of wood pulp was weighed as received on an analytical balance, transferred to an extraction vessel and then extracted with about 72 mL of pure SF- $\text{CO}_2$ . The density of the extraction fluid was maintained at 0.85 g/mL at a chamber temperature of 60°C (Figure 30). The liquid flow rate was maintained at 2.0 mL/min. The extraction time was

FLUID DELIVERY

density: 0.85 g/ml  
pressure: 329 bar  
flow rate: 2.0 ml/min  
extraction fluid: CO2

EXTRACTION CHAMBER

chamber temperature: 60 C  
equilibration time: 0.10 min  
extraction time: 33.00 min  
thimble size: 7.0 ml  
thimble volumes swept: 10.3

ANALYTE TRAP

analyte: Intermediate Volatile  
trap material: ODS  
nozzle temperature: 65 C  
trap temperature: 5 C

FRACTION OUTPUT

Rinse substep	Solvent Name	Volume (ml)	Rate (ml/min)	Nozzle Temp	Trap Temp	Vial Number
1	MeOH	1.0	1.0	40	25	1
2	MeOH	1.0	1.0	40	25	2

Figure 30. SFE Conditions.

set at 33 minutes in order for 10.3 thimble volumes to be swept. The analytes in the SF-CO<sub>2</sub> were then carried through a nozzle whose temperature was kept constant at 65°C. The sudden drop in pressure at the nozzle converted the fluid to a gas which vented, while the analytes were deposited onto the (5°C) trap. Next, the trap (ODS or SS at 25°C) was rinsed either with CH<sub>3</sub>OH or CH<sub>2</sub>Cl<sub>2</sub> and the analytes in solution were collected in two 1 mL fractions (Figure 31).

The above procedure was repeated an additional three times for each pulp sample (total mass ~ 5.9 gm) and hence the contents of the 8 vials obtained at this point were transferred to a larger pre-weighed vial, rinsed three times with the respective rinse solvent and purged with a slow stream of nitrogen to dryness (Figure 32). Blank extractions of the thimble were also done by following identical conditions and procedures mentioned above. The dried extracts were then weighed on an analytical balance and the percent extractives calculated after subtracting the background value using relationship 5. For each set of extraction parameters, triplicate extraction sets (12 total 1.5 gm extractions) were performed for each wood pulp. Then using the best combination of trap and rinse solvent, SFE was again performed using 2% MeOH modified SF-CO<sub>2</sub>. The dried extracts of CTMP and BKP were each dissolved in 100 µL of CH<sub>3</sub>OH and the reconstituted solution was used for analysis by GC/MS.

Separations were performed with an HP 5890A gas

## SFE PROCEDURE

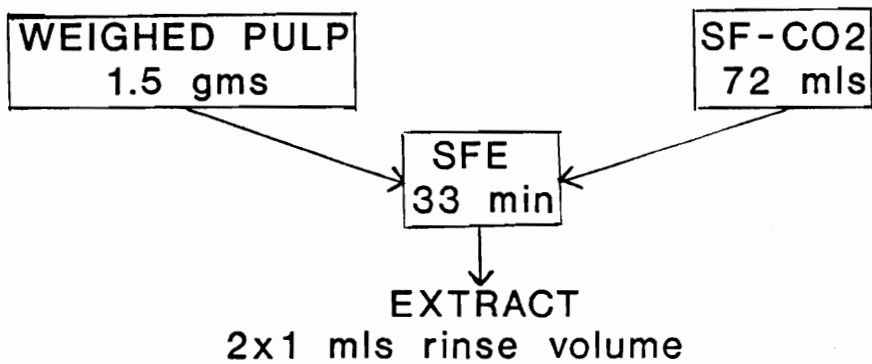
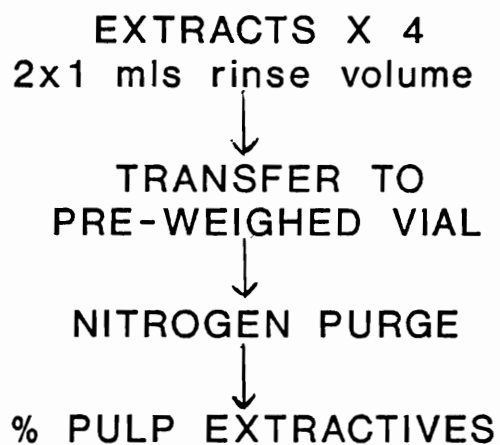

Figure 31. SFE Procedure.



## PROCEDURE FOR DRYING AFTER SFE



**Figure 32. Procedure for Drying.**

chromatograph equipped with a splitless/split capillary column inlet system which was maintained at 260°C. A 30m x 0.25 mm i.d., 0.25 µm film thickness, SPB-20 bonded phase fused silica capillary column coated with 20% diphenyl and 80% dimethyl polysiloxane was used. Mass spectra were obtained by directly interfacing the above gas chromatograph with a Model 5970 (Hewlett-Packard) MSD. Helium was used as the carrier gas and the transfer line was maintained at 260°C. The temperature program employed was as follows: initial oven temperature 55°C for 1 minute, ramp at 8°C/min until 260°C and finally held at 260°C for 10 minutes. For all the extracts, 1 µl of reconstituted solution was injected manually with a Hamilton Microliter Syringe. The mass spectra were obtained by electron impact (EI) ionization at an electron beam energy of 70 eV and the separation of the ions was brought about by quadrupole rods. The ion source temperature was set at 200°C and the masses were scanned from 50-450 amu. All the data were processed using an HP 59970C Chem Station.

### **5.3 RESULTS AND DISCUSSION**

The standard method widely used for the extraction of wood or wood pulps is the method of Soxhlet extraction since its invention by Franz Ritter von Soxhlet over 70 years ago. It is done either as a stepwise technique using different solvents in each step to extract a single sample (23-26), or by performing a single extraction with various solvents differing in polarity (20,21,27). Previously we performed

Soxhlet extractions in duplicate on various CTMP and BKP wood pulps in three solvents (Ch 2). Referring to Table 2, it is observed that for all the pulps studied, as the solvent's solvating power increased, the percent of extractives also increased. In addition, the pulps in question CTMP-I exhibited a greater amount of extractives than BKP-I.

The main difficulties that we encountered here were:

- 1) The pre-extraction step to clean the glassware etc. took about 12 hours.
- 2) The actual extraction time for each wood pulp required 72 hours.
- 3) The volume of solvent required for each extraction was 300 mL.
- 4) The concentration of the extracts was laborious and time consuming.
- 5) Extractions were performed at the boiling point of each extraction solvent; therefore, volatiles are lost and thermally labile compounds are altered.

The unique properties of supercritical fluids have been well documented in several excellent books and review articles (86,111,116-119). These properties prompted us to test SFE as a replacement technique for the isolation of compounds from wood pulps. Practically, SFE involves three variables: extraction fluid, trapping material and rinse solvent. Since analytical SFE is a relatively new

technique, the best combination of these variables was chosen by the method of trial and error.

The determination of optimal extraction conditions for trace components as in the case of wood pulp extractives has been largely empirical for two reasons. First, analytical SFE of wood pulps involves the recovery of a complex mixture of analytes. In such a case the extraction has to be optimized for a group of compounds, which complicates the prediction of optimal extraction conditions. Second, solubility conditions address only part of the extraction problem. Due to the fact that the extraction of an analyte depends on its distribution between the supercritical fluid and the sorptive sites on the sample matrix, the ability of the supercritical fluid to compete with the analyte for the sorptive sites may be more crucial than solubility considerations (111). Unfortunately, the latter fact has received little attention in the development of analytical SFE techniques (120).

The dynamic mode of extraction was employed instead of the static or recirculating mode. All the extractions were carried out at 0.85 gm/mL. For each wood pulp sample, the extraction procedure had to be done four times so that sufficient quantity of material could be weighed and chromatographed by GC/MS since the extraction vessel had a capacity of only 7 mL and the wood pulp had a low density. Therefore ~5.9 gm of pulp and a total volume of ~288 mL of SF-CO<sub>2</sub> were required for each sample. Table 13 compares SFE

TABLE 13

SFE Results using 100% CO<sub>2</sub>

<u>Wood Pulp</u>	<u>Trap</u>	<u>Rinse Solvent</u>	<u>% Extractives*</u>	<u>% RSD</u>
CTMP	SS	CH <sub>2</sub> Cl <sub>2</sub>	0.020	20.0
BKP	SS	CH <sub>2</sub> Cl <sub>2</sub>	0.010	10.0
CTMP	SS	CH <sub>3</sub> OH	0.014	21.4
BKP	SS	CH <sub>3</sub> OH	0.006	22.2
CTMP	ODS	CH <sub>2</sub> Cl <sub>2</sub>	0.018	22.2
BKP	ODS	CH <sub>2</sub> Cl <sub>2</sub>	0.008	12.5
CTMP	ODS	CH <sub>3</sub> OH	0.028	14.3
BKP	ODS	CH <sub>3</sub> OH	0.010	20.0

\* n=3

results on two bleached wood pulps wherein the extracts were collected either on stainless steel or Hypersil ODS traps after CO<sub>2</sub> depressurization. Both CH<sub>3</sub>OH and CH<sub>2</sub>Cl<sub>2</sub> were used to rinse the traps. Using the F-test (121) no significant difference in the standard deviations (S.D.) of any of the the samples studied were observed. Therefore, utilizing the Pooled t-test for a 98% confidence interval (121), no significant difference in the percent extractives was found with BKP extracts no matter what trap or rinse solvent was employed. However, when comparing the percent extractives of the CTMP pulp for the various combinations of trap and rinse solvents, only the CTMP extract with an ODS trap and CH<sub>3</sub>OH rinse proved to be statistically greater in value than the rest. Hence this combination of trap and rinse was used for further investigation. These results also clearly indicate that comparable amounts of percent extractives were found by Soxhlet extraction (Ch 2) with cyclohexane as the extraction solvent. This did not come as a surprise in view of the fact that cyclohexane and carbon dioxide have similar solvent polarizable/polarity parameter (112).

Results reported in the literature indicate that as a rule of thumb, compounds extracted by SFE can be analyzed by gas chromatographic techniques. Also in our earlier study with Soxhlet extraction (Ch 2), GC/MS was used to identify the volatile components extracted. In this investigation too, our purpose in using GC/MS was to compare under identical conditions the CTMP and BKP extracts and not to do

a detailed analyses of as many volatile components as possible. Figures 33 and 34 which are the total ion current chromatograms of CTMP and BKP extracts respectively with 100% SF-CO<sub>2</sub> bring out this comparison. Even though there was no significant difference between their percent extractives, many more different volatile components were extracted from CTMP than from BKP. The peak assignments were made based on a NBS Library search with a probability match greater than 95%. Based upon the general class of compounds indicated as the best matches by the computer search and our interpretation of each spectrum, many of the peaks were assigned a chemical class. However, it was possible to identify definitely very few of the peaks. One such peak of interest was 4-hydroxy-3-methoxy benzaldehyde (peak 23) which is commonly referred to as vanillin and is believed to be a degradation product of the lignin. In fact the solubility of vanillin in SF-CO<sub>2</sub> has been studied and found to be 0.15-0.35% w/w for T = 318.15°K and pressure around 80-200 bar (122). Besides vanillin, 4-hydroxy-3-methoxy benzeneacetic acid (peak 26) and phenanthrene carboxylic acid ester (peak 37) were discovered earlier (Ch 2) in the Soxhlet ethyl acetate extracts of CTMP and here again in this study. Peaks 43-47 were only observed in BKP while peaks 23,24,25,28 and 33 were common to both the CTMP and BKP extracts.

The peaks marked as "#" turned out to be impurities in the blank run. These are believed to be due to plumbing,

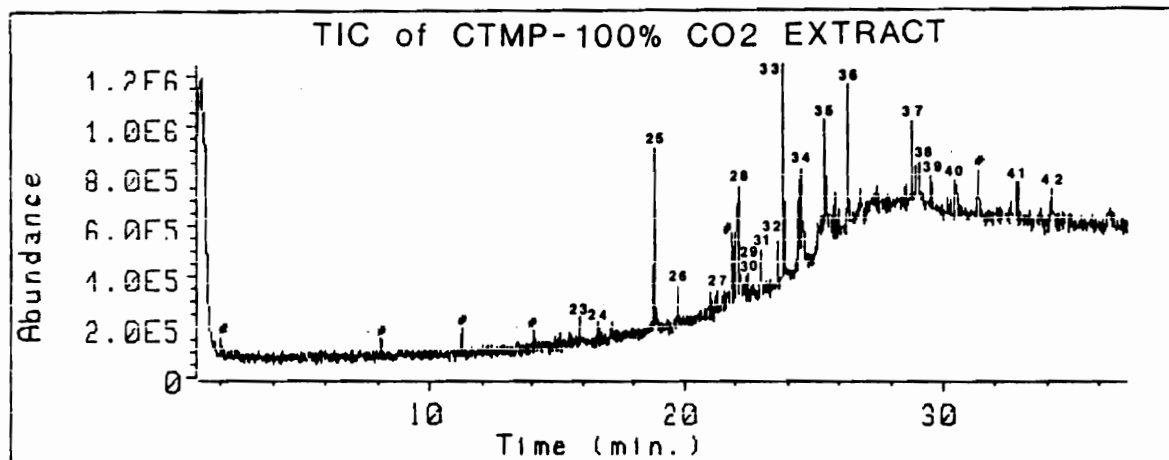

PEAK NO.	IDENTIFICATION
23	4-hydroxy-3-methoxy benzaldehyde
25	1,2 benzenedicarboxylic acid, diisobutyl ester
26	4-hydroxy-3-methoxy benzeneacetic acid
33	Diocetyl benzenedicarboxylic ester
35	' Phenol'
37	' Phenanthrenecarboxylic acid ester'
39	' Sterol'

Figure 33. TIC of CTMP-100% SF-CO<sub>2</sub>: Injector: splitless/split at 260°C; Column: SPB-20 (30 m x 0.25 mm i.d.), 0.25 μm film thickness; Carrier gas: Helium; Temperature program used was 55°C for 1 minute, then a ramp of 8°C/min until 260°C where the temperature was kept constant for 10 minutes; 1 μL injection; Transfer line: 260°C; Ion production: EI; Beam energy: 70 eV; Ion separation: Quadrupole rods; Ion detection: Electron multipliers; Mass range monitored: 50-450 amu.



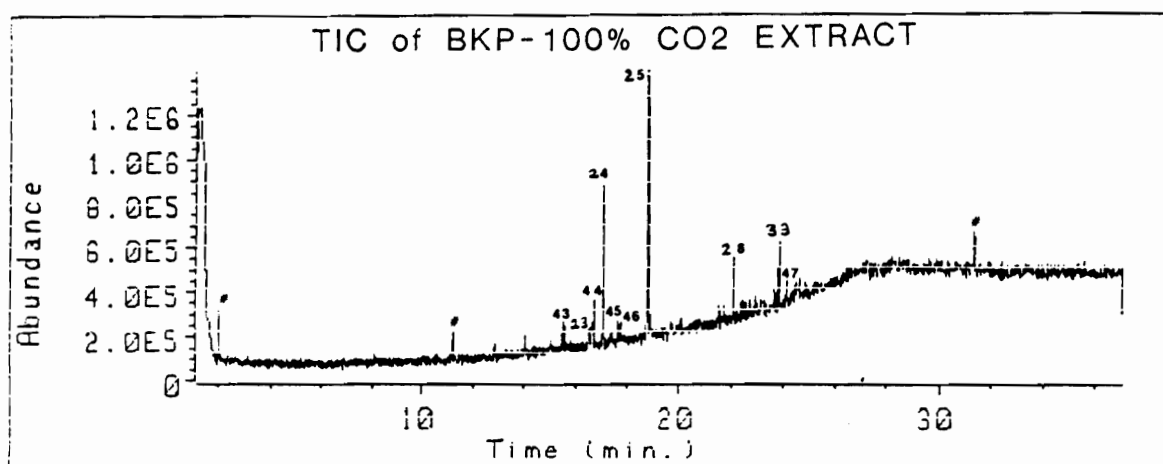

PEAK NO.	IDENTIFICATION
43	' Hexanedioic acid ester'
45	' Propanoic acid ester'
47	' Aliphatic alcohol'

Figure 34. TIC of BKP-100% SF-CO<sub>2</sub>: Conditions same as in Figure 33.

packaging and SF-CO<sub>2</sub> used. These impurities included cyclosiloxanes, chlorofluorohydrocarbons, phthalate esters, esters of long chain fatty acids and hydrocarbons. These were not of great concern in this study because a) their relative abundance was low and b) they did not interfere with our peaks of interest. (Figures 33 and 34).

It is well established that small amounts of an entrainer such as methanol may have a significant effect on the solvating power of SF-CO<sub>2</sub>, particularly if chemical association causes modifier 'clusters' to form (123-126). The modifier effect is not yet well understood though various mechanisms have been proposed (114). Hence we attempted to compare the extractives using an ODS trap and CH<sub>3</sub>OH rinse (Table 14). The percent extractives were found to have statistically similar values (F-test and Pooled t-test) for both the CTMP and the BKP extracts. The purpose of further analysis by GC/MS was not to do a detailed identification, but rather to see whether the 2% MeOH modified SF-CO<sub>2</sub> would extract more polar volatile compounds as compared to 100% SF-CO<sub>2</sub> extracts. Comparing Figures 33 and 35, we observe that although a few common extractives were found, for example peaks 23-26, a large number of different volatile components were extracted with peaks 50 and 52 being of interest to us due to their greater polarity. In fact peak 52 was extracted by ethyl acetate in the Soxhlet extraction done earlier (Ch 2). Similarly, referring to Figure 36, the modified SF-CO<sub>2</sub> was able to

TABLE 14

SFE Results with SF-CO<sub>2</sub> modified with 2% MeOH

<u>Wood Pulp</u>	<u>% Extractives*</u>	<u>% RSD</u>
CTMP	0.037	21.6
BKP	0.010	10.0

\* n=3, ODS trap, CH<sub>3</sub>OH rinse

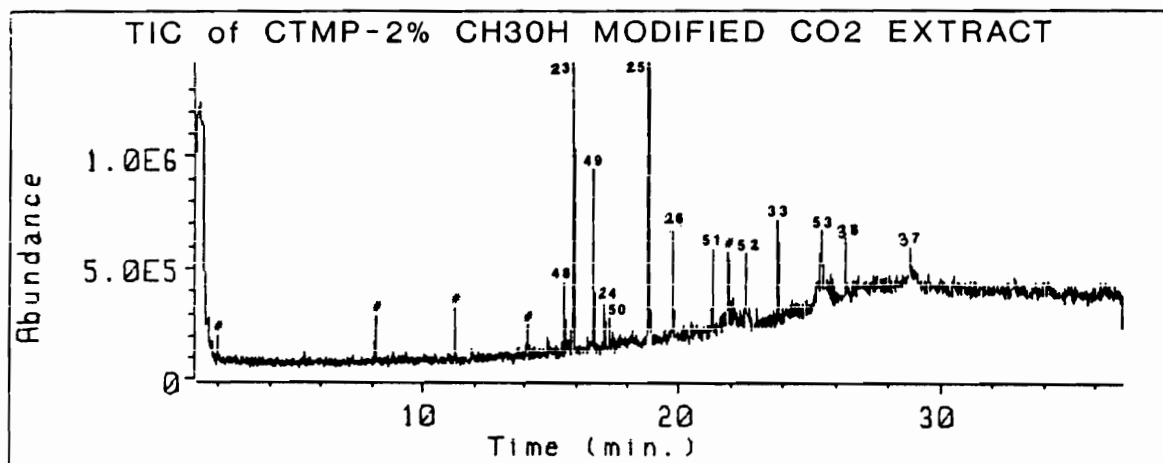

PEAK NO.	IDENTIFICATION
48	'Hexanedioic acid, dioctyl ester'
49	1,2 benzenedicarboxylic acid, dimethyl ester
50	Ethanone, 1-(4-hydroxy-methoxyphenyl)
52	1-Propanone, 3-hydroxy-1-(4-hydroxy-3-methoxy-phenyl)

Figure 35. TIC of CTMP-2% MeOH modified SF-CO<sub>2</sub>: Conditions same as in Figure 33.

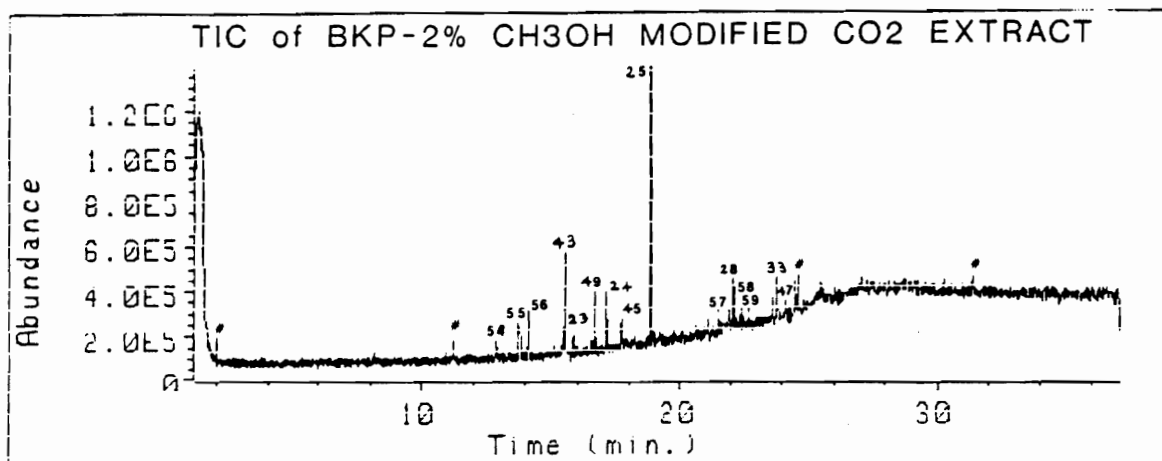

PEAK NO.	IDENTIFICATION
57	'Oxacyclohexadecan-2-one (C <sub>15</sub> H <sub>28</sub> O <sub>2</sub> )

Figure 36. TIC of BKP-2% MeOH modified SF-CO<sub>2</sub>: Conditions same as in Figure 33.

extract oxacyclohexadecan-2-one (peak 57) which is moderately polar in nature. Another interesting observation (comparing Figures 33 and 35) is that more volatile components were extracted by 100% SF-CO<sub>2</sub> as compared with 2% MeOH modified SF-CO<sub>2</sub>. A plausible explanation for this finding is that even though modified SF-CO<sub>2</sub> is capable of extracting more polar compounds than pure SF-CO<sub>2</sub>, the ODS trap may not be as efficient at trapping all the polar compounds as it is for non-polars. It is worth mentioning at this juncture that no chlorinated material was identified in any of the pulp extracts studied and this could strongly be due to the lack of sensitivity of the full scan mode of the mass spectrometer.

The percent extractives obtained by SFE were similar to those obtained by Soxhlet extraction even though only 6 grams of pulp were used for SFE while 16 grams were used for Soxhlet extraction. The extraction time was reduced from 72 hours to about 2 hours, which is a significant saving of time. Besides, the concentration and drying procedure decreased from 6 hours to 3 hours. Another great advantage of using SF-CO<sub>2</sub> is the fact that extraction solvent disposal is not a problem. This is not only environmentally safer, but economical too.

In summary, the best combination for the CTMP pulp was the ODS trap with CH<sub>3</sub>OH as the rinse solvent. Next, comparing the percent extractives of CTMP to BKP extracts for each combination of trap and solvent, they were found to be

statistically similar in all cases. Again, no significant difference was observed in percent extractives by using 100% SF-CO<sub>2</sub> or SF-CO<sub>2</sub> modified with 2% MeOH for both CTMP and BKP extracts. With regard to component to component identification a) the volatile extracted components from CTMP were greater than from BKP extract, b) some impurities were identified in the blanks, c) 2% MeOH modified SF-CO<sub>2</sub> extracted a few more polar compounds compared to 100% SF-CO<sub>2</sub> and d) no chlorinated material was identified in this study by generally scanning from 50-450 amu with the mass spectrometer.

## 6.0 CHAPTER 6: CONCLUSIONS & FUTURE WORK

The principal goal of this investigation has been to compare the CTMP pulp extracts to that of the Kraft pulps based on quantitative and qualitative results obtained after single Soxhlet extractions in solvents differing in polarities. The qualitative analysis by GC/FID and GC/EIMS focussed only on the volatile portion of the extracts. Further research is required for looking at the whole spectrum of compounds (semi-volatile and non-volatile) in these wood pulp extracts utilizing liquid chromatography and/or supercritical fluid chromatography.

The initial survey above served as a precedent for investigating trace chlorinated compounds in the various wood pulp extracts utilizing GC/ECD, GC/EIMS (SIM mode) and GC/NCIMS. Though GC/ECD did not yield any conclusive information, the time varied selected multiple ion approach was found to be reliable and a time-saver for simultaneously monitoring a large number of pre-selected compounds. Surprisingly, chlorinated phenolics were found in practically all pulp extracts whether bleached with chlorine or not. Without the exact history and background of the wood pulps studied, it is impossible to figure out the



reasons for such a discovery. The complementary nature of GC/NCIMS as a second technique to verify or enhance our findings of chlorinated compounds by GC/EIMS is discussed. Since only the BKP wood pulp extracts were studied here, the CTMPs and UBKP need to be examined by this technique. Attention is also drawn to the fact that both by GC/EIMS and GC/NCIMS, our attention was confined to a narrow region of the mass spectra and chromatographic retention times. Further studies of examining the other above mentioned regions are encouraged.

Finally, the problems encountered with Soxhlet extractions, together with the unique advantages of supercritical fluids, in particular SF-CO<sub>2</sub>, prompted the feasibility study of the above mentioned wood pulps. Using the supercritical fluid extracts, and more sensitive techniques like GC/EIMS (using SIM) and GC/NCIMS will throw more light onto the presence of trace chlorinated compounds in wood pulps.

## 7.0 CHAPTER 7: REFERENCES

- (1) 'Dictionary of Paper', 3rd. Ed., Published under auspices of American Paper & Pulp Associates NY, (1965).
- (2) Sjöstrom, E.; 'Wood Chemistry, Fundamentals and Applications ', Academic Press, NY, (1981).
- (3) Kringstad, K. P.; Lindström, K.; **Environ. Sci. Tech.**, 18:236A, (1984).
- (4) Adler, E.; **Wood Sci. Technol.**, 11:169, (1977).
- (5) Lindgren, B. O.; Norin, T., **Svensk. Papperstidn**, 72:143, (1969).
- (6) Casey, J. P.; 'Pulp and Paper Chem. & Chem. Technology', 3rd. Ed., Vol. I, Wiley Interscience Publication, NY, (1980).
- (7) Rydholm, S. A.; 'Pulping Processes', Interscience Publication, NY, (1965).
- (8) Conner, A. H.; Diehl, M. A.; Rowe, J. W.; **Wood Science**, 12:183, (1980).
- (9) Liebergott, N.; Van Lierop, B.; **Pulp & Paper Canada**, 87:T300, (1986).
- (10) Hon, D. N.-S.; **South. Pulp & Pap. Manuf.**, March:23, (1979).
- (11) Gellerstedt, G.; Petterson, I.; Sundin, S.; **Ekman-Days, Intern. Symp. Wood Pulping Chem.**, SPCI, 2:120, (1981).
- (12) Gierer, J.; **Holzforschung**, 36:43, (1982).
- (13) Liebergott, N.; Van Lierop, B.; **Pulp & Paper Canada**, 87:T324, (1986).
- (14) Lindgren, B. O.; **Svensk. Papperstidn.**, 82:126, (1979).

- (15) Das, B. S. et al; **J. Fish. Res. Board. Can.**, 26:3055, (1969).
- (16) Larsson, S. A.; Ostman, B.A.; Bach, E. L.; **Environ. Sci. Technol.**, 9:160, (1975).
- (17) Hillis, W. E.; '**Wood Extractives and their Significance to the Pulp and Paper Industries**', Academic Press, New York and London, (1962).
- (18) Lindgren, B.; Norin, T.; **Svensk. Papperstidn.**, 15:143, (1969).
- (19) Britt, K. W.; '**Handbook of Pulp and Paper Technology**', Van Nostrand Reinhold Company, N.Y. (1970).
- (20) Shimada, K.; **Mokuzai Gakkaishi**, 15:126, (1969).
- (21) Shimada, K.; **Mokuzai Gakkaishi**, 16:388, (1970).
- (22) Sumimoto, M.; Tachibana, S.; Oktani, Y.; **Ekman-Days, Intern. Symp. Wood Pulping Chem.**, SPCI: Stockholm, Sweden, 2:150, (1981).
- (23) Tachibana, S.; Sumimoto, M.; **Mokuzai Gakkaishi**, 28:452, (1982).
- (24) Agatsuma, S.; Tachibana, S.; Sumimoto, M.; **Mokuzai Gakkaishi**, 32:34, (1986).
- (25) Abe, Z.; **Kami Pa Gikyoshi**, H1:H17, (1987).
- (26) Lee, H. K.; Lim, N.; Sumimoto, M.; **Appita.**, 40:351, (1987).
- (27) Douek, M.; Allen, L. H.; **Alkaline Pulping/Secondary Fibres Conf.** [pap.] TAPPI: Atlanta, GA, 17, (1977).
- (28) Akimoto, H.; Sumimoto, M.; **Mokuzai Gakkaishi**, 26:347, (1980).
- (29) Gullichsen, J.; Soderhjelm, L.; **Pap. Puu.**, 1:34, (1984).
- (30) Chapman, R. A.; Nugent, H. M.; Clayton, D. W.; **Trans. Tech. Sect. - Can. Pulp Pap. Assoc.**, 1:122, (1975).
- (31) Donetzhuber, A.; Johansson, K.; Sandstroem, C.; **Appl. Polym. Symp.**, 28:889, (1976).
- (32) Swan, B.; **Svensk. Papperstidn.**, 19:616, (1967).

- (33) Laamanen, L.; **Pap. Puu**, 9:517, (1984).
- (34) Oktani, Y.; Shigemoto, T.; Okagawa, A.; **Mokuzai Gakkaishi**, 34:947, (1988).
- (35) Ekman, R.; Holmbom, B.; **Nord. Pulp. Pap. Res. J.**, 1:16, (1989).
- (36) Ekman, R.; Holmbom, B.; **Nord. Pulp. Pap. Res. J.**, 3:188, (1989).
- (37) Yatagai, M.; Sakurai, K.; Hayashi, Y.; Takahashi, T.; **IUFRO: Conf. on Wood Quality and Utilization of Tropical Species**, pp. 49-58, (1978).
- (38) Yatagai, M.; Takahashi, T.; **Wood Sci.**, 12:176, (1980).
- (39) 'Eight Peak Index of Mass Spectra', The Mass Spectrometry Data Centre, UK, (1983).
- (40) Beynon, K. I.; Crosby, D. G.; Korte, F.; Still, G. G.; Vonk, J. W.; Greve, D. A.; **Div. Comm. on Pest. Chem. Rep.**, pp. 1052, (1981).
- (41) Leah, J. M.; Thakore, A. N.; **J. Fish. Res. Board. Can.**, 32:1249, (1975).
- (42) Servizi, J. A.; Gordon, R. W.; Martens, D. W.; **Int. Pacific Salmon Fish. Comm.**, Prog. Rep. No. 17, (1968).
- (43) Goewice, C. E.; Berkhof, R. J.; Maris, F. A.; Treskes, M.; Brinkman, U. A. Th.; **J. Environ. Anal. Chem.**, 26:305, (1986).
- (44) Lindstrom, K.; Nordin, J.; **J. Chromatogr.**, 128:13, (1976).
- (45) Kringstad, K. P.; Ljungquist, D. O.; de Souza, F.; Stromberg, L. M.; **Environ. Sci. Technol.**, 15:562, (1981).
- (46) Holmbom, B.; Voss, R. H.; Mortimer, R. D.; Wong, A.; **Environ. Sci. Technol.**, 18:333, (1984).
- (47) Leah, J. M.; Mueller, J. C.; Walden, C. C.; **Transactions of the Tech. Sect. Can. Pulp & Pap. Assoc.**, 3:TR126, (1977).
- (48) Blosser, R. O.; **NCASI Stream Improvement Tech. Bulletin**, No. 343, (1981).

- (49) Zlatkis, A.; Poole, C. F.; **'Electron Capture: Theory and Practice in Chromatography'**, Elsevier Scientific Publishing Company, NY. (1981).
- (50) Pellizari, E. D.; **J. Chromatogr.**, 98:323, (1974).
- (51) Knuutnen, J.; Tarhanen, J.; Lahtiperia, M.; **Chromatographia**, 15:9, (1982).
- (52) Voss, R. H.; Wearing, J. T.; Mortimer, R. D.; Kovacs, T.; Wong, A.; **Pap. Puu.**, 12:809, (1980).
- (53) Voss, R. H.; Wearing, J. T.; Wong, A.; **In Industrial Waste Water Analysis**, Pulp & Pap. Research Institute of Canada, Ch 53, (1982).
- (54) McLafferty, F.W.; **'Interpretation of Mass Spectra'**, University Science Books, CA. (1980).
- (55) Sandermann Jr., H.; Scheel, D.; Ud Trenck, T.; **J. Appl. Polym. Sci.**, 37:407, (1983).
- (56) Grainge, M.; Ahmad, S.; **'Handbook of Plants with Pest Control Properties'**, Wiley-Interscience, Honolulu, HI. (1988).
- (57) Tannenbaum, H. P.; Roberts, J. D.; Dougherty, R. C.; **Anal. Chem.**, 47:49, (1975).
- (58) Dougherty, R. C.; Roberts, J. D.; Biros, F. J.; **Anal. Chem.**, 47:54, (1975).
- (59) Dougherty, R. C.; Piotrowska, K.; **J. Assoc. Off. Anal. Chem.**, 59:1023, (1976).
- (60) Dougherty, R. C.; Dalton, J.; **Org. Mass Spectrom.**, 6:1171, (1972).
- (61) Artigas, F.; Martinez, E.; Gelpi, E.; **Biomed. Environ. Mass Spec.**, 16:279, (1988).
- (62) Kuehl, D. W.; Dougherty, R. C.; **Environ. Sci. & Tech.**, 14:447, (1980).
- (63) Dougherty, R. C.; Piotrowska, K.; **Proc. Natl. Acad. Sci., USA**, 73:1777, (1976).
- (64) Karasek, F. W.; Charbonneau, G. M.; Reuel, G. J.; Tong, H. Y.; **Anal. Chem.**, 59:1027, (1987).
- (65) Kuehl, D. W.; Whitaker, M. J.; Dougherty, R. C.; **Anal. Chem.**, 52:935, (1980).

- (66) Porte, C.; Barcelo, D.; Albaiges, J.; J. **Chromatogr.**, 442:386, (1988).
- (67) Oehme, M.; Mano, S.; Thomas, W.; **Frezenius Z. Anal. Chem.**, 321:655, (1985).
- (68) Valls, M.; Bayona, J. M.; Albaiges, J.; **Intern. J. Environ. Anal. Chem.**, 39:329, (1990).
- (69) Zarr N. S.; Lindgren, J. L.; Jenks, J. M.; **Proc. -APCA Annu. Meet.**, 1:84, (1984).
- (70) Hass, J. R.; Friesen, M. D.; Harvan, D. J.; Parker, C. E.; **Anal. Chem.**, 50:1474, (1978).
- (71) Hunt, D. F.; McEwen, C. N.; Harvey, J. M.; **Anal. Chem.**, 47:1730, (1975).
- (72) Hunt, D. F.; Stafford, G. C.; Crow, F. W.; Russell, J. W.; **Anal. Chem.**, 48:2098, (1976).
- (73) Hunt, D. F.; Crow, F. W.; **Anal. Chem.**, 50:1781, (1978).
- (74) Crow, F. W.; Bjorseth, A.; Knapp, K. T.; Bennett, R.; **Anal. Chem.**, 53:619, (1981).
- (75) Dougherty, R. C.; **Anal. Chem.**, 53:625A, (1981).
- (76) Chapman, J. R., 'Practical Organic Mass Spectrometry', John Wiley & Sons Ltd, Chichester, Ch 4, (1985).
- (77) Horning, E. C.; Carroll D. I.; Dzidic, I.; Lin, S. -N.; Stilwell, R. N.; Thenot, J. -P.; **J. Chromatogr.**, 142:481, (1977).
- (78) Farwell, S. O.; Rasmussen, R. A.; **J. Chromatogr. Sci.**, 14:224, (1976).
- (79) Munson, M. S. B.; Field, F. H.; **J. Amer. Chem. Soc.**, 88:2621, (1966).
- (80) Klotz, C. E.; 'Fundamental Processes in Radiation Chemistry', P. Austoos. Ed., John Wiley & Sons, NY, pp 40, (1968).
- (81) Dillard, J. G.; **Chem. Rev.**, 73:589, (1973).
- (82) Lias, S. G.; Austoos, P.; 'Ion Molecule Reactions', ACS, Washington, DC, Ch 4, (1975).
- (83) Christophorou, L. G.; **Chem. Rev.**, 76:409, (1976).

- (84) Field, F. H.; **MTP International Review of Sci. Physical Chemistry Series 1**, Vol. 5, A. Macolli, Ed., Butterworth, London, pp 24, (1972).
- (85) Dougherty, R. C.; **'Pentachlorophenol: Chemistry, Pharmacology and Env. Toxicology**, K. R. Raol. Ed., Plenum, N.Y. pp. 351, (1978).
- (86) King, J. W.; **J. Chromatogr. Sci.**, 27:355, (1989).
- (87) Skelton Jr., R. J.; Johnson, C. C.; Taylor, L. T.; **Chromatographia**, 21:3, (1986).
- (88) Hawthorne, S. B.; Miller, D. J.; **J. Chromatogr.**, 403:63, (1987).
- (89) Schantz, M. M.; Chesler, S. N.; **J. Chromatogr.**, 363:397, (1986).
- (90) Onuska, F. I.; Terry, K. A.; **J. High Res. Chrom.**, 12:357, (1989).
- (91) McNally, M. E. P.; Wheeler, J. R.; **J. Chromatogr.**, 447:53, (1988).
- (92) Sugiyama, K.; Saito, M.; **J. Chromatogr.**, 442:121, (1988).
- (93) Wright, B. W.; Wright, C. W.; Gale, R. W.; Smith, R. W.; **Anal. Chem.**, 59:640, (1987).
- (94) Campbell, R. M.; Lee, M. L.; **Anal. Chem.**, 58:2247, (1986).
- (95) Capriel, P.; Haisch, A.; Khan, S. U.; **J. Agri. Food Chem.**, 30:70, (1986).
- (96) Kiran, E; **Tappi J.**, 70:23, (1987).
- (97) Poirier, M. G.; Ahmad, A.; Grandmaison, J. L.; Kaliaguine, S. C. F.; **Ind. Eng. Chem. Res.**, 26:1738, (1987).
- (98) Hawthorne, S. B.; Miller, D. J.; Kriesger, M. S.; **Frezenius Z. Anal. Chem.**, 330:211, (1988).
- (99) Hawthorne, S. B.; Kriesger, M. S.; Miller, D. J.; **Anal. Chem.**, 60:472, (1988).
- (100) Li, L.; Kiran, E; **Ind. Eng. Chem. Res.**, 27:1301, (1988).
- (101) Li, L.; Kiran, E.; **Tappi J.**, 4:183, (1989).

- (102) Beer, R.; Peter, S.; **In Supercritical Fluid Technology**, Penninger, J. M. L.; Radiosz, M.; McHugh, M. A.; Krukonis, V. J.; Eds. Elsevier-Amsterdam, pp. 385-396, (1985).
- (103) Schneiderman, M. A.; Sharma, A. K.; Locke, D. C.; **J. Chromatogr.**, 409:343, (1987).
- (104) Reyes, T.; Bandyopadhyay, S. S.; McCoy, B. J.; **J. Supercritical Fluids**, 2:80, (1989).
- (105) Chen, S. L.; Sunol, A. K.; Presented at the **AICHE Annual Meeting**, Washington, DC, (1988).
- (106) Li, L.; Kiran, E.; **In Supercritical Science & Technology**, Johnston, K. P.; Penninger, J. M. L.; Eds. ACS Symp. Series No. 406, ACS Washington, DC. Ch 21, (1989).
- (107) Goto, M.; Smith, J. M.; McCoy, B. J.; **Ind. Eng. Chem. Res.**, 29:282, (1990).
- (108) Koll, P.; Brownstrup, B.; Metzger, J. O.; **In Chemical Engineering at Supercritical Fluid Conditions**, Paulaitis, M. E.; Penninger, J. M. L.; Gray, R. D.; Davidson, P.; Eds. Ann Arbor Science, Ann Arbor, MI. pp 499-514, (1983).
- (109) Ritter, D.; Campbell A.; Presented at the **FPRS Annual Meeting**, Chemistry Section, (1986).
- (110) Giddings, J. C.; Myers, M. N.; McCaren, L.; Keller, R. L.; **Science**, 162:67, (1968).
- (111) Hawthorne, S. B.; **Anal. Chem.**, 62:633A, (1990).
- (112) Smith, R. D.; Wright, B. W.; Yonker, C. R.; **Anal. Chem.**, 60:1323A, (1988).
- (113) Drake, B. D.; Smith Jr., R. L.; Presented at the **Symp. on Supercritical Fluids AIChE National Meeting**, Orlando, FL, (1990).
- (114) Deye, J. F.; Berger T. A.; Anderson, A. G.; **Anal. Chem.**, 62:615, (1990)
- (115) Levy, J. M.; Ritchey, W. M.; **J. Chromatogr. Sci.**, 24:242, (1986).
- (116) McHugh, M.; Krukonis, V.; **'Supercritical Fluid Extraction: Principles and Practice'**, Butterworth, Stoneham, MA, (1986).



- (117) Lee, M. L.; Markides, K. E.; **Analytical Supercritical Fluid Chromatography and Extraction**, Chromatography Conferences Inc., Provo, Utah, (1990).
- (118) Charpentier, B. A.; Serenants, M. R.; Eds. **'Supercritical Fluid Extraction and Chromatography: Techniques and Applications**, ACS Symp. Series 366, ACS, Washington, DC, (1988).
- (119) Majors, R. E.; **LC-GC**, 9:78, (1991).
- (120) King, J. W.; In **Supercritical Fluids Chem. & Eng. Principles & Applications**, Squires, T. G.; Paulaitis, M. E.; Eds. ACS Symp. Series 329, ACS, Washington, DC, pp 150-71, (1985).
- (121) Miller, J. C.; Miller, J. N.; **'Statistics for Analytical Chemistry'**, Ellis Horwood Limited, Chichester (1984).
- (122) Wells, P. A.; Chaplin, R. P.; Foster, N. R.; J. **Supercritical Fluids**, 3:8, (1990).
- (123) Yonker, C. R.; Frye, S. L.; Kalkwarf, D. R.; Smith, R. D.; **J. Phys. Chem.**, 90:3022, (1986).
- (124) Kim, S.; Johnston, K. D.; **Ind. Eng. Chem. Res.**, 26:1206, (1987).
- (125) Smith, S. A.; Shenai, V.; Mathews, M. A.; J. **Supercritical Fluids**, 3:175, (1990).
- (126) Gurdial, G. S.; Wells, P. A.; Foster, N. R.; J. **Supercritical Fluids**, 2:85, (1989).

## VITA

Anna J. Sequeira (Queenie) was born on May 3, 1952 in Mombasa, Kenya. She graduated in June 1973 with a Bachelor of Science in Chemistry and Physics, and in June 1975 with a Master of Science in Physical Chemistry from the University of Bombay, India. She also obtained a Diploma in Higher Education from the same university in June 1978. She worked as a Teacher of Chemistry at St. Xavier's College Higher Secondary Section, Goa, India from June 1975 to September 1978. She then went to Qatar, where she served as a Teacher of Scientific English for the Ministry of Education, Doha, Qatar from November 1978 to June 1986. In 1985, she obtained a Diploma in Teaching English as a Foreign Language from the Royal Society of Arts, England. Then, in 1987 she graduated with a Master of Science Education from Radford University and in December 1987 she enrolled in the Ph. D. Program in Chemistry at Virginia Tech. She will be joining Experimental Pathology Laboratories Inc. (contract lab. for R. J. Reynolds) at Winston-Salem, NC in August 1991 after completion of her Doctorate at Virginia Tech.

*A. Sequeira*

## PRESENTATIONS

1. "Enhancement of Packed Column SFC via Deactivated Stationary Phases", M. A. Khorassani, A. J. SEQUEIRA, L. T. Taylor; Pittsburgh Conference and Exposition on Analytical Chemistry and Applied Spectroscopy, Atlanta, GA. March 1989.
2. "A Comparative Study of Wood Pulp Extracts obtained by the CTMP and KRAFT Processes", A. J. SEQUEIRA, L. T. Taylor; National ACS Conference, Washington, DC. Aug. 1990.
3. "Supercritical Fluid Extraction of Wood Pulps", A. J. SEQUEIRA, L. T. Taylor; Pittsburgh Conference and Exposition on Analytical Chemistry and Applied Spectroscopy, Chicago, IL. March 1991.
4. "Identification and Quantification of some Chlorinated Phenolics in Wood Pulp Extracts by Time Varied Selected Multiple Ions Monitoring", A. J. SEQUEIRA, L. T. Taylor; National ACS Conference, Atlanta, GA. April 1991.

## PUBLICATIONS

1. "A Comparative Study of Chemithermomechanical and Kraft Wood Pulp Extracts", A. J. SEQUEIRA & L. T. Taylor; Intern. J. Environ. Anal. Chem. (in print).
2. "Identification and Quantification of Some Chlorinated Phenolics in Wood Pulp Extracts by Monitoring Time Varied Selected Multiple Ions Mass Spectra", A. J. SEQUEIRA & L. T. Taylor; J. Chromatogr. Sci. (in print).
3. "Gas Chromatography-Negative Chemical Ionization Mass Spectrometry of Chlorinated Compounds in Wood Pulp Extracts", A. J. SEQUEIRA & L. T. Taylor; (sent for publication).
4. "SFE of American and European Bleached Wood Pulps", A. J. SEQUEIRA, L. T. Taylor, J. V. Smith & W. Pipkin; Application Note, Hewlett-Packard Company, Avondale, PA. (in print).
5. "Supercritical Fluid Extraction of Wood Pulps", A. J. SEQUEIRA & L. T. Taylor; J. Supercritical Fluids. (sent for publication).