

CHAPTER I

INTRODUCTION AND LITERATURE REVIEW

1.1 INTRODUCTION

Long Span Deck Floor Systems (LSDFS) are a new type of construction system that are being used in the building industry. The principal advantage of this system with respect to steel framed floors is that slabs can span quite long distances without intermediate supports. Deck fabricators have developed the design of the composite action of the concrete and the steel deck in such way that slabs spanning 25 ft without intermediate beams have been constructed in new buildings. The increase of the floor span, however, can cause serviceability problems; in particular those related to human response to floor vibrations.

1.2 SCOPE OF RESEARCH

The purpose of the present research is to assess the performance of LSDFS for floor vibrations and to determine the effectiveness of available design procedures to predict the response of such systems. For this purpose, the research includes a series of experimental and analytical studies with the aim of understanding the dynamics of this type of floor system. The investigation started with the in-situ testing of building floors, where the system properties namely, the natural frequencies and the acceleration response histories, were measured and compared to steel-framed structural systems studied in the past. These measurements determined the vibration characteristics of the floors, which were found to differ from the characteristics of conventionally framed systems.

To investigate the differences, the next step was to construct a laboratory footbridge specimen of a LSDFS. The footbridge was subjected to a number of static and dynamic tests to define the vibration characteristics of the system. Techniques of experimental modal analysis and digital signal processing were used to measure the specimen's dynamic response.

With the experimental work concluded, the next step was to simulate both the in-situ floors and the laboratory specimen using finite element models (FEM). For this purpose, SAP 2000 (CSI, 2007), a finite element analysis program, was used to create the

models and reproduce the experiments. As a result of these analyses, recommendations for the use of FEM are provided for the future use of this method in the design of new buildings.

Finally, the procedures in two floor vibration design guides (Murray et al 1997, and Smith et al, 2007) were studied to determine their accuracy for the prediction of the dynamic performance of LSDFS. Recommendations are made for needed modifications to these procedures.

As a result of the research, a method to evaluate the natural frequency of LSDFS is provided. Recommendations to determine floor accelerations are also discussed; however, further research is required to address and develop a method to predict the acceleration response of this type of floor.

1.3 OVERVIEW OF FLOOR VIBRATION SERVICEABILITY

The floor vibration problem has been addressed by structural engineers for more than a century. It was Tredgold (1828) who stated the first design criterion for this issue. He proposed that long-span beams should be deep enough to avoid the problem of shaking everything in the room while walking. Even though this issue has been known as a construction limitation for almost two hundred years, it is during the last decades that it has been recognized as critical serviceability issue.

In the past, research was entirely devoted to the study of the strength of structures, focusing on the understanding of phenomena related to the strength limit states. Little attention, if any, was given to serviceability issues, particularly to those related to vibrations. This fact is understandable since the design of a structure required the dimensioning of members of large proportions to support the loads applied to the system. As a result, heavy and stiff structures were not subject to excitation levels that would cause discomfort to the building users, in most of the cases.

With the evolution of the building construction engineering, the floor vibration problem has been gaining more and more importance. The building construction industry has a marked tendency to develop construction systems where the structural elements are either reduced in size or simply removed from the structure's design. This tendency is

due to the development of stronger and lighter materials, better construction practices, and improved design methodologies.

On the other hand, building occupancy has also changed. In the past, buildings were designed with a different perspective. Floors were filled with filing cabinets, heavy desks, and other appliances that added mass and damping to the system. Thus, vibrations were minimized and were not considered a matter of design. In the present, this traditional kind of occupancy has changed. Technology has suppressed the use of filing cabinets, and most information is handled electronically. Besides, partition walls have been omitted from floor layouts. Nowadays, building floors are open spaces, where the layout can be rapidly changed to fit the particular requirements of the user.

As a result, the combined effect of light structures and light occupancies has contributed to an increase of floor vibration levels. The complaints due to what Tredgold addressed 180 years ago are common in new buildings. In fact, modern structural engineers are well aware of the problem, and the issue that was formally a design check has become a controlling serviceability limit state. Thus, in design offices, many engineers are designing for serviceability and checking for strength.

The long span deck floor system is an evolution of the steel deck-concrete system that has been used in steel buildings since the 1960's. Using this system reduces the number of beams to a minimum or in many cases, completely, which increases the probability of user complaints due to vibrations.

1.4 REVIEW OF CONCEPTS IN FLOOR VIBRATIONS

The following section is a brief review of the general topics needed for the study of vibrations in long span deck floor systems. A review of the vibration of mechanical systems is presented in section 1.4.1. The discussion addresses the fundamental vibration concepts, with emphasis in the dynamic behavior of structural building floors. Then, a review of the concept of natural frequency and the variables that affect floor frequencies is presented in section 1.4.2. The subjects discussed in this literature review form the basis of the experimental and analytical tools used in later stages of the research.

1.4.1 Vibrations of Mechanical Systems

This section presents a summary of the topics involved in the study of mechanical systems, as applied to floor systems. In the most basic sense, the study of the dynamics of a mechanical system implies the definition of a set of three properties: the natural frequencies, the mode shapes, and the damping ratios. These properties, which define the behavior of a system, are a function of the material, the geometry, and the support conditions. The type of excitation applied to the system does not affect these properties; however, it affects the response of the system. These definitions can be understood by examining Equation (1.1), which is the general equation of motion of a two degree of freedom system in modal coordinates. The mode shapes of this system are obtained by solving the eigenvalue problem and finding the eigenvectors.

$$\begin{Bmatrix} \ddot{x}_1 \\ \ddot{x}_2 \end{Bmatrix} + \begin{bmatrix} 2\xi_1\omega_{n1} & 0 \\ 0 & 2\xi_2\omega_{n2} \end{bmatrix} \begin{Bmatrix} \dot{x}_1 \\ \dot{x}_2 \end{Bmatrix} + \begin{bmatrix} \omega_{n1}^2 & 0 \\ 0 & \omega_{n2}^2 \end{bmatrix} \begin{Bmatrix} x_1 \\ x_2 \end{Bmatrix} = \begin{Bmatrix} 1 \\ 1 \end{Bmatrix} p(t) \quad (1.1)$$

where

ξ = damping ratio

ω_n = system natural frequency

$p(t)$ = force per unit of mass

$x(t)$ = system response in modal coordinates

In floor structures, the natural frequency generally ranges between 19 and 107 rad/sec or 3 and 17 Hz. The damping ratio varies between 1 and 5 % of the critical damping, depending on the furniture, appliances, and number of people that are present on the structure. The forcing frequency varies between 1.5 and 2.5 Hz., which corresponds to the excitation that the floor experiences when people walk on it (Murray et al, 1997; Smith et al, 2007).

Floors are classified in two groups, depending on the value of their natural frequency. In low frequency floors, the natural frequency is less than or equal to 10 Hz. High frequency floors are those that have frequencies greater than 10 Hz (Murray et al, 1997; Smith et al, 2007). In low frequency floors, the walking frequency can match one of the subharmonics of the floor natural frequency. When this occurs, the floor may experience resonance, which causes the maximum response of the structure. The result is a built-up acceleration signal where the response reaches values that may cause

discomfort to the floor occupants. For example, consider a floor with a frequency of 6.16 Hz, and a walking frequency of 1.54 Hz. In this case, the floor frequency is four times the walking frequency. This low frequency floor is being excited at one of its subharmonics. As a result, the floor experiences resonance, as shown in Figure 1.1.

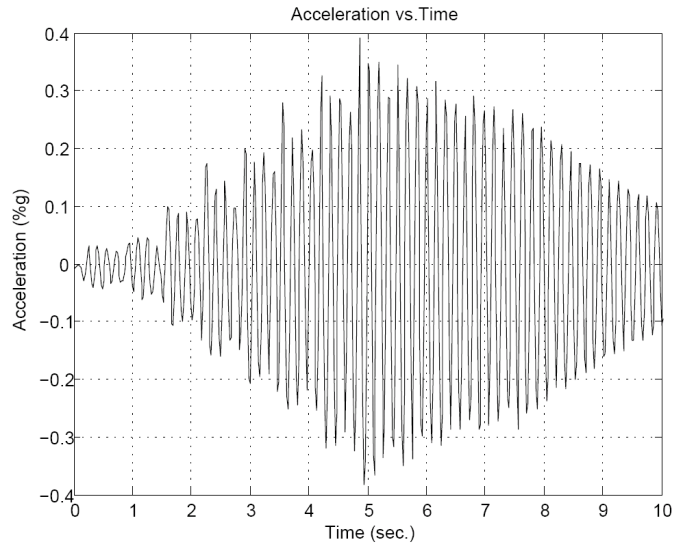

Figure 1.1 Resonant Response of a Low-Frequency Floor, $f_n = 6.16$ Hz, $f_{walk} = 1.54$ Hz

In high frequency floors, resonant responses are not attained. Instead, the floor response is a series of impulses with a fast decay. Figure 1.2 is an example of this phenomenon. The floor frequency is 16.25 Hz, and the walking frequency is 2.33 Hz, which is the seventh subharmonic of the floor frequency. In the figure, it is shown how short impulses occur in the floor response while a person is walking. The peaks in the acceleration trace are the result of the excitation that the structure experiences with each step. This is observed in the figure, where the response reaches a new peak every seven cycles of vibration.

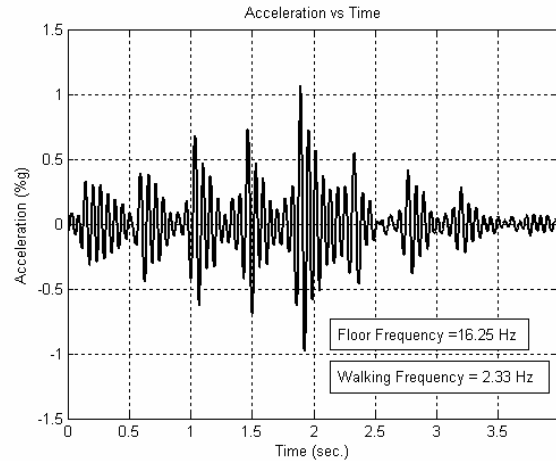

Figure 1.2 Response of a High-Frequency Floor, $f_n = 16.25$ Hz, $f_{walk} = 2.33$ Hz

Notice that in the previous plots, the measured response is the acceleration of the system, $\ddot{x}(t)$. To determine if a floor is adequate for vibrations, the measured accelerations are to be compared to permissible limits such as those shown in Figure 1.3. In the figure the acceptance limits depend on the type of floor occupancy. If the floor accelerations are below those limits, vibrations will not cause discomfort to the users. This is the basis of the acceptance criterion given in the AISC Design Guide 11 (Murray et al, 1997); similar limits are given in the Steel Construction Institute (SCI) Design Guide (Smith et al, 2007).

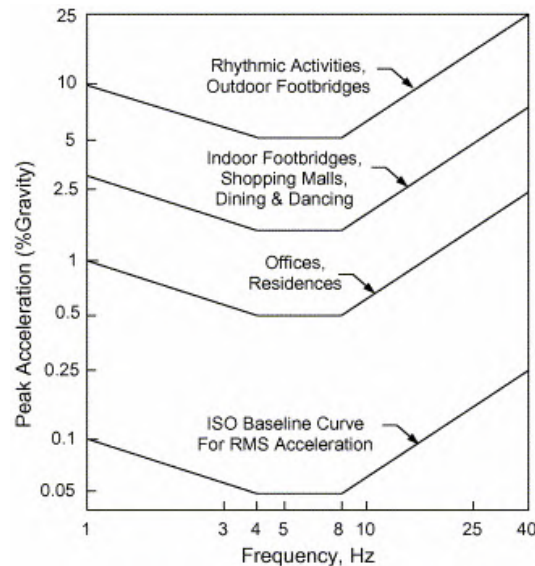

Figure 1.3 Recommended Peak Acceleration for Human Comfort for Vibrations Due to Human Activities (Allen and Murray, 1993)

1.4.2 Floor Natural Frequency

The floor natural frequency is the most important property of the structure when studying its dynamics. The floor natural frequency is a direct function of the support end conditions. The fundamental or first natural frequency of a beam with uniformly distributed mass is given by

$$f_n = \frac{\pi}{2} \sqrt{\frac{E \cdot I}{m \cdot L^4}} \quad (1.2)$$

for pinned supports, and by

$$f_n = \frac{2.25 \cdot \pi}{2} \sqrt{\frac{E \cdot I}{m \cdot L^4}} \quad (1.3)$$

for fixed supports, where

- f_n = fundamental natural frequency (Hz)
- E = modulus of elasticity of the material
- I = transformed moment of inertia
- m = mass per unit length
- L = member length

It is noted that the fundamental frequency is affected by the support conditions. The frequency for a beam with fixed supports is 2.25 times the frequency of the same beam with pinned supports.

For a beam with a uniform distributed mass, Equations (1.2) and (1.3) can be represented in a single equation:

$$f_n = 0.18 \sqrt{\frac{g}{\Delta}} \quad (1.4)$$

where,

- g = acceleration of gravity
- Δ = member midspan deflection due to the weight supported
- = $\frac{5 \cdot m \cdot g \cdot L^4}{384 \cdot E \cdot I}$ for elements with pinned ends
- = $\frac{m \cdot g \cdot L^4}{384 \cdot E \cdot I}$ for elements with fixed ends

It is noted that 2.25 is approximately equal to $\sqrt{5}$; thus, the natural frequency of a fixed-fixed beam is $\sqrt{5}$ times the natural frequency of a simply supported beam.

Common floor structural systems are usually modeled as structures made of simply supported elements. This assumption is based on experimental results that show that the vibration of floor structures corresponds to the behavior of a system with all its members connected with pinned ends. In fact, in the methodology used in the AISC Design Guide 11, the natural frequency of a floor member is calculated using Equation (1.4) with the deflection, Δ , for elements with simple supports.

1.5 LITERATURE REVIEW

Different topics in floor vibrations have been studied during the last decade. Some of the research conducted in this field is directly related to the study presented in this thesis. Sladki (1999) conducted research to determine the accuracy of finite element models to predict the natural frequency and acceleration response of steel framed floors. As a result of the research, Sladki demonstrated that finite element analysis is an accurate tool that can be used to predict natural frequencies, but this method is deficient for predicting floor acceleration responses. Perry (2003) continued the research in computer modeling of floors. He designed loading protocols that were used in finite element models to predict floor responses. As a result of his research, Perry determined that the principal source of discrepancy between the finite element predictions and the measured accelerations is the modal mass. He concluded that the accuracy of analytical procedures to predict floor responses depends on how efficiently is the modal mass calculated. Boice (2003) studied different methods for frequency and response predictions in floor structures. He explored the accuracy of two design guides, comparing the predicted results to data obtained from tests conducted in steel composite floors. As part of his research, Barrett (2006) developed techniques to evaluate modal properties and floor responses using the finite element method. His study was centered in the determination of the acceleration frequency response function. As a result of his research, a method to determine the dynamic response of a steel framed floor is proposed.

1.6 NEED FOR RESEARCH

The need for the research is because some initial tests showed that LSDFS behave as fixed-fixed systems, which is contrary to conventional deck-beam-girder systems. To verify the observed fixity, a number of in-situ tests were evaluated and a laboratory footbridge was constructed and tested.

Chapter II presents the in-situ experiments carried out on actual buildings with a discussion of the results found during the tests. The study of the behavior of the laboratory specimen constructed to address the observations found during the in-situ tests is the topic of Chapter III. In this chapter, the conditions for vibrations of LSDFS are identified, and an understanding of the phenomenon for this type of floors is developed. Chapter IV is dedicated to the study and validation of design procedures and their use in the design of new structures. In Chapter V, the conclusions of the research program are presented with recommendations for future research.

CHAPTER II

IN-SITU TESTS OF LONG SPAN DECK FLOOR SYSTEMS

2.1 INTRODUCTION

This chapter presents the experimental study of thirteen in-situ long span deck floor systems from six different condominium buildings. All the floors were tested when the buildings were in construction. The tests procedures used to perform the experiments are described first. Next, the descriptions of the tested floors in each building are presented, followed by the analysis of the results obtained from the dynamic tests. Table 2.1 provides an overview of the tested floors. As shown in the table, the building floors are labeled from Bay 1 to Bay 13. This bay numbering is used in the analysis presented in the next sections.

2.2 TESTING PROCEDURES

The testing program for each bay consisted of a series of vibration measurements. The floor responses were measured using a seismic accelerometer connected to the ONO SOKKI digital signal analyzer shown in Figure 2.1. The handheld analyzer was used to record the floor acceleration response history due to several types of excitations. The recorded signals are internally processed by the analyzer to determine their frequency content and amplitudes. This Fast Fourier Transform (FFT) analysis performed by the analyzer captures the floor natural frequencies and maximum accelerations at each mode of vibration. Thus, the resulting natural frequencies and accelerations are used to assess the vibration performance of the analyzed floor.

In field tests, four excitations were used to capture the floor vibration properties: ambient excitation, heel-drops, walking, and in some cases bouncing. In a heel-drop test, an individual raises his heel approximately 2 in. from the floor and then releases his weight causing the heel-drop impact. Data from the ambient excitation provides an approximation of the vibration natural frequencies of the floor. For this measurement, the motion of the system is relatively small since there is very little source of energy to cause the vibrations. In the heel-drop tests, the slab is excited, producing the required motion to capture the floor response and the natural frequencies of the system.

Table 2.1 Overview of Tested Bays

Building	Building/Mock-up	Tested Floor	Bay Dimensions (Width x Span)	Slab Thickness (in.)	Concrete Compressive Strength (ksi)	Deck Type	Deck Height (in.)	Floor support
1	Hampton Inn (Norfolk, VA)	End Suite Room (Bay 1)	20'-2 1/4"x22'-8 1/2"	6.0	4.0	CSI Versa-Dek® XLS, 20 gauge, 24.5" CW	2.0	Stud wall - Steel beam
		Suite Room (Bay 2)	20'-2 1/4"x22'-8 1/2"	6.0	4.0	CSI Versa-Dek® XLS, 20 gauge, 24.5" CW	2.0	Stud wall - Stud wall
		Standard Room (Bay 3)	26'-8"x14'-8 1/2"	6.0	4.0	CSI Versa-Dek® XLS, 22 gauge, 24.5" CW	2.0	Stud wall - Stud wall
2	Caribe Cove (Kissimmee, FL)	Bay 4	13'-9"x23'-6"	6.0	4.0	CSI Versa-Dek® XLS, 22 gauge, 24.5" CW	2.0	CMU wall - Concrete beam
3	Concord and Cumberland (Charleston, SC)	Bay 5	30'-5 1/2"x21'-8 3/8"	6.0	3.0	CSI Versa-Dek® S, 22 gauge	2.0	Stud wall - Stud wall
4	Royal Reef (North Caicos, BVI)	Bay 6	32'-0"x23'-0"	6 3/4	4.0	CSI Versa-Dek® XLS, 18 gauge, 24.5" CW	2.0	CMU wall - CMU wall
		Bay 7	29'-4 5/8"x14'-0"	5 1/2	4.0	CSI CDF2, 18 gauge, 36" CW	2.0	CMU wall - CMU wall
5	Seybold Flats (Tampa, FL)	Unit 201 (Bay 8)	17'-8"x22'-0"	6.0	4.0	CSI Versa-Dek® XLS, 20 gauge, 24.5" CW	2.0	Concrete beam - Masonry wall
		Unit 203 (Bay 9)	17'-8"x24'-8"	6.0	4.0	CSI Versa-Dek® XLS, 20 gauge, 24.5" CW	2.0	Concrete beam - Masonry wall
		Unit 401 (Bay 10)	29'-3"x16'-9"	6.0	4.0	CSI Versa-Dek® XLS, 20 gauge, 24.5" CW	2.0	Steel beam - Steel Beam
6	Regency (Sunset Beach, NC)	Bay 11	19'-10"x19'-5"	6.0	3.0	CSI Versa-Dek® XLS, 22 gauge, 24.5" CW	2.0	Stud wall - Stud wall
		Bay 12	19'-10"x19'-5"	6.0	3.0	CSI Versa-Dek® XLS, 22 gauge, 24.5" CW	2.0	Stud wall - Stud wall
		Bay 13	19'-10"x19'-5"	6.0	3.0	CSI Versa-Dek® XLS, 22 gauge, 24.5" CW	2.0	Stud wall - Stud wall

In these tests, the response of the first vibration mode is usually larger than the response of the rest of modes. This is due to the fact that it is easier to excite the fundamental mode compared to higher modes.



Figure 2.1 ONO SOKKI Handheld Analyzer

After the fundamental natural frequency of the floor was determined, walking tests were performed. In these tests, the structure is excited at a subharmonic of the natural frequency. For this purpose the pace that corresponds to the frequency subharmonic is setup in a metronome, and the person walks at the pace given by the metronome. As explained in Section 1.4.1, walking at a subharmonic of the natural frequency may produce a signal built-up in the acceleration trace. Finally, in some cases, the slab was excited by bouncing in an attempt to produce a resonant motion. This excitation does not provide any other new information, but serves to confirm the results found in the walking tests.

2.3 DESCRIPTION AND ANALYSIS OF TESTED FLOORS

2.3.1 Hampton Inn

Three bays of a Hampton Inn, Norfolk, VA, were tested when the building was under construction as shown in Figure 2.2. The total depth of the slab is 6 in., with 4 in. of normal weight concrete, $f'_c = 4.0$ ksi, over 2 in. deep deck.



Figure 2.2 Hampton Inn Building at the Time of Testing

Bay 1 is located on the second floor. The slab span is 22 ft 8-1/2 in. and the bay width is 20 ft 2-1/4 in. The floor slab is supported by steel stud walls at grid line 15 and by a HSS 18x6x1/2 steel beam at grid line 16. The steel deck is 2 in. deep Versa Dek XLS® 20 gauge.

Bay 2 is located in the third floor. The slab is supported by stud walls at both ends. The slab span is 22 ft 8-1/2 in. and bay width is 20 ft 2-1/4 in. The steel deck used in this floor is also 2 in. deep Versa Dek XLS® 20 gauge.

Bay 3 is on the third floor. The slab spans 14 ft 8-1/2 in. and the bay width is 26 ft 8 in. This slab is supported by steel stud walls at both ends, and the steel deck is 2 in. deep Versa Dek XLS® 22 gauge.

In each of the three bays, the floor motion was measured for ambient excitation, heel-drop excitation, walking, and bouncing. Table 2.2 summarizes the experimental results for 16 measurements. In all cases, measurements were taken with the accelerometer placed at the center of the bay. The walking and bouncing paces used in the measurements were selected to match the subharmonics of the floor natural frequency, in an attempt to cause a built-up response. In Bay 1, the walking frequency of 2.22 Hz corresponds to the sixth subharmonic of the floor frequency. Similarly, in Bay 2, the walking frequencies range between 2.40 and 2.80 Hz, which correspond to the seventh and eighth subharmonics of the floor frequency, respectively.

Table 2.2 Summary of Measurements, Hampton Inn

Floor	Grid Lines	Bay	Excitation	Speed (bpm/Hz)	Dominant Frequencies (Hz)			Associated Accelerations (% of Gravity)				
Second	15-16	1	Ambient		13.25	12.25	14.00					
			Heel-Drop		13.25	12.00	15.25					
			Walking	random	13.50	11.75	9.75	0.43	0.21	0.13		
			Walking	133/2.22	13.25	11.00	15.50	0.50	0.14	0.11		
Third	3-4	2	Ambient		16.75	10.00	0.00					
			Heel-Drop		16.75	16.00	15.25					
			Walking	144/2.40	16.75	14.00	15.50	0.42	0.12	0.09		
			Walking	144/2.40	16.75	14.75	15.25	0.27	0.08	0.07		
			Walking	140/2.33	16.25	13.75	9.20	0.25	0.14	0.08		
			Walking	135/2.25	15.25	17.50	16.50	0.15	0.12	0.11		
			Walking	150/2.50	17.00	14.75	9.75	0.35	0.17	0.10		
			Walking	155/2.58	16.75	15.25	16.00	0.32	0.27	0.16		
			Walking	168/2.80	16.00	13.25	17.00	0.44	0.20	0.17		
			Bouncing	168/2.80	2.75	16.75	5.50	0.06	0.04	0.03		
			6-7	3	Ambient		12.75	27.00	25.25			
					Heel-Drop		26.00	23.75	21.25			

Selected plots of the accelerations traces and frequency spectra and the results for Bay 1, Bay 2, and Bay 3 are analyzed and discussed below. The complete set of plots for the three bays is presented in Appendix A. These plots contain the required information to assess the dynamic performance of each floor.

The acceleration response histories and their frequency spectra for Bay 1 are shown in Figure 2.3. The plots correspond to the responses for ambient excitation, heel-drop excitation, and walking at 133 bpm (2.22 Hz). Figure 2.4 presents the acceleration traces and spectra for ambient motion, heel-drop excitation, walking at 144 bpm (2.40 Hz), and bouncing at 168 bpm (2.80 Hz) for Bay 2. Figure 2.5 shows the plots for Bay 3, corresponding to ambient vibrations and heel-drop excitation.

The vibration characteristics of Bay 1 are determined from Figure 2.3. The frequency spectra plots for ambient and heel-drop excitations indicate that the fundamental natural frequency of the floor is 13.3 Hz. From the heel-drop test, it is also determined that the damping ratio is 0.038. The walking pace for the test shown in Figure 2.3(c) was 133 bpm (2.22 Hz). This walking frequency is the sixth subharmonic of the floor natural frequency. The frequency content of the acceleration trace from the walking test shows that the slab is excited at its fundamental natural frequency (13.3 Hz), but there is also some response at the subharmonics. The first peak in the frequency spectrum is the walking frequency (2.22 Hz), which is the sixth subharmonic of the floor frequency. This phenomenon can also be seen in the acceleration trace, where a new peak occurs at every six cycles of free vibration. The acceleration trace for walking indicates that the peak acceleration of the floor is 1.41 %g.

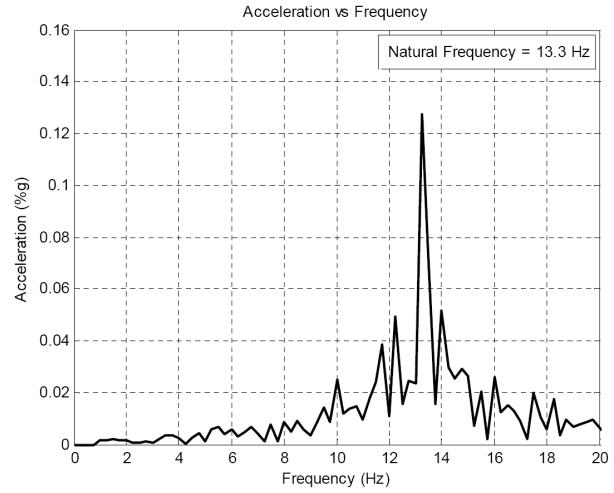
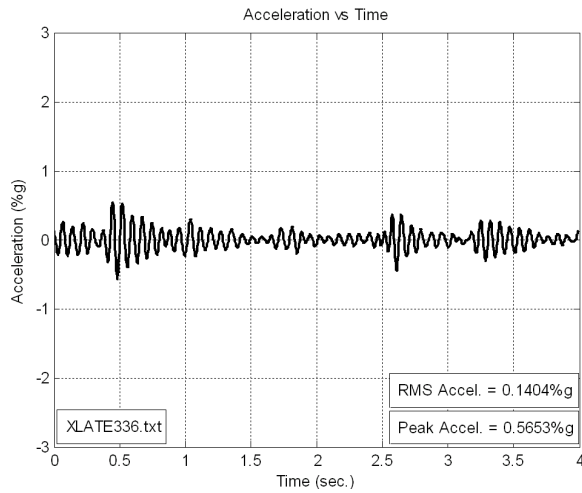

a) Ambient Vibrations

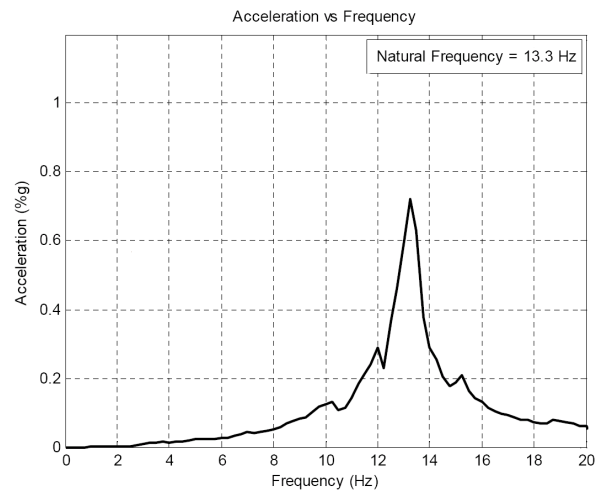
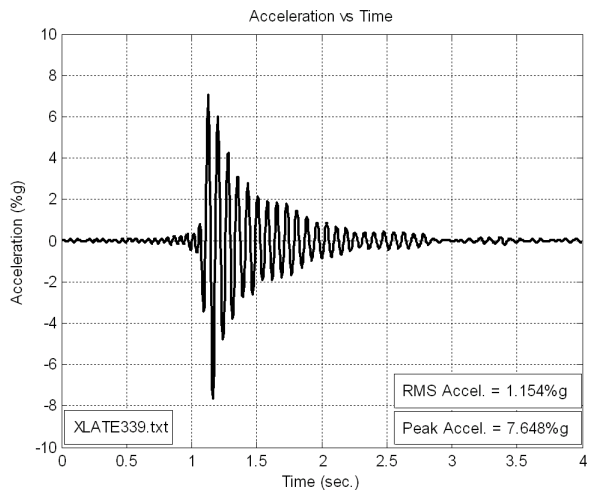

b) Heel-Drop

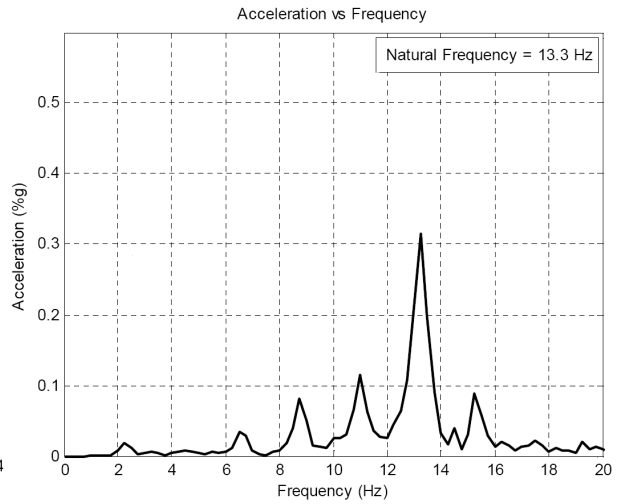
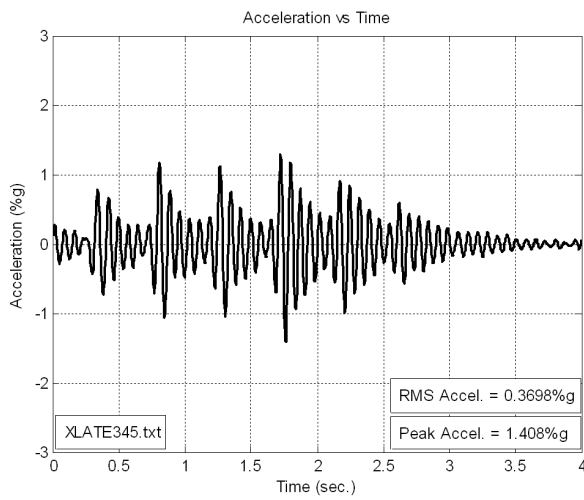

c) Walking at 133 bpm (2.22 Hz)

Figure 2.3 Test Measurements for Bay 1, Hampton Inn

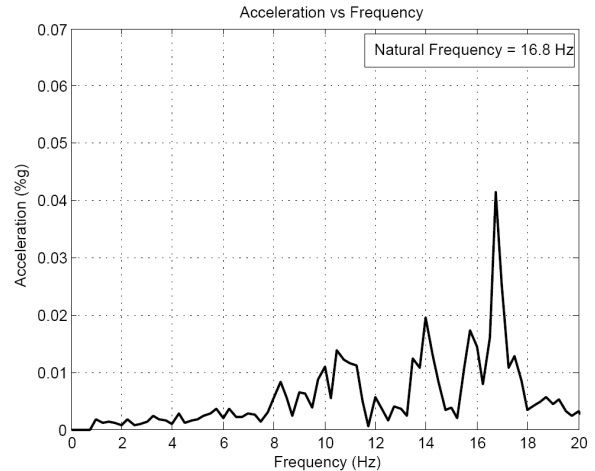
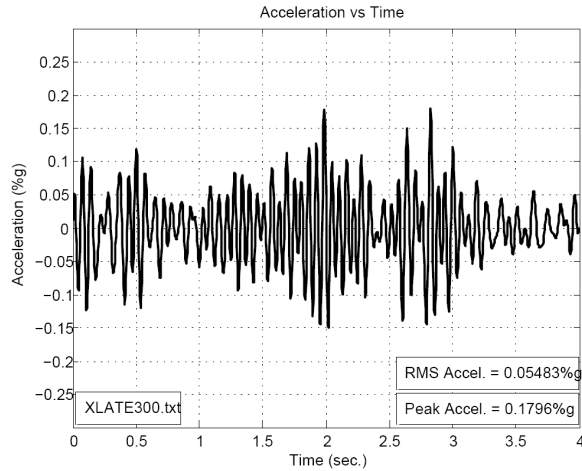

a) Ambient Vibrations

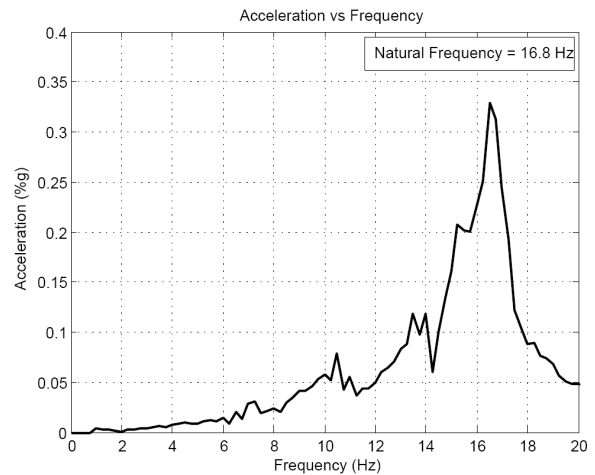
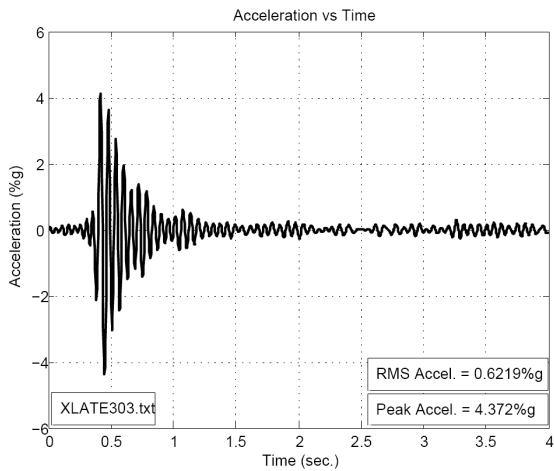

b) Heel-Drop

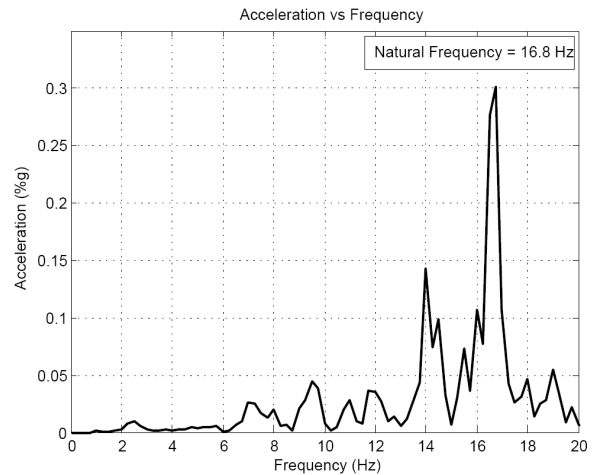
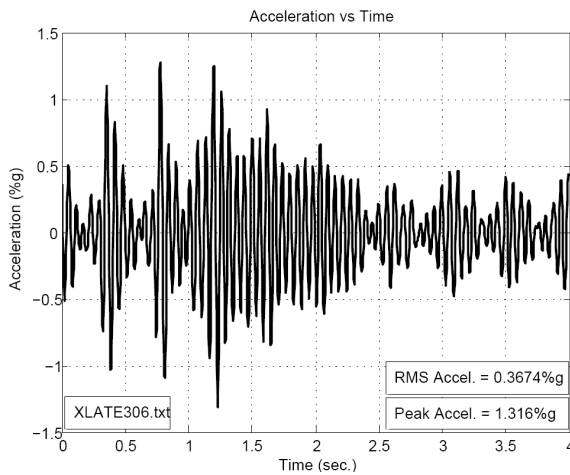

c) Walking at 144 bpm (2.40 Hz)

Figure 2.4 Test Measurements for Bay 2, Hampton Inn

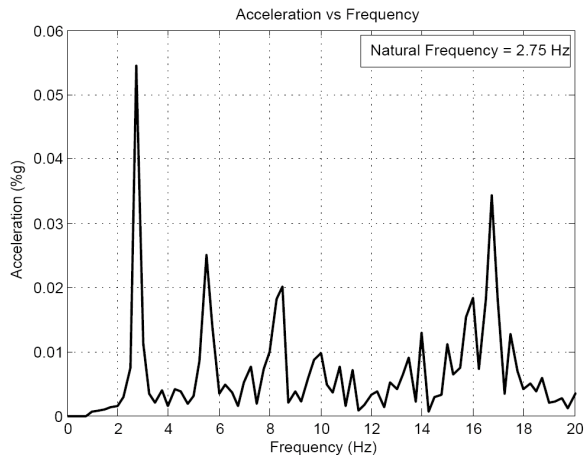
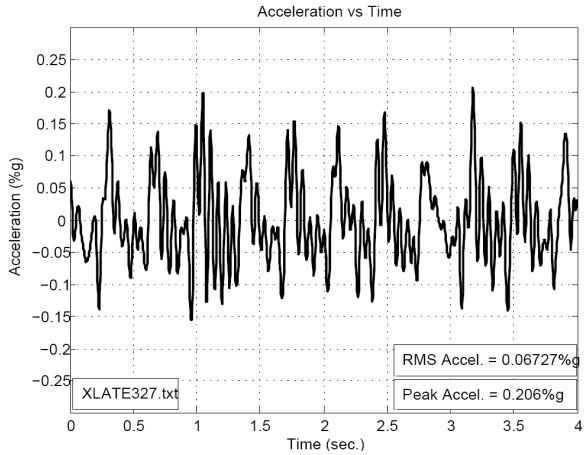

d) Bouncing at 168 bpm (2.40 Hz)

Figure 2.4 Test Measurements for Bay 2, Hampton Inn, Continued

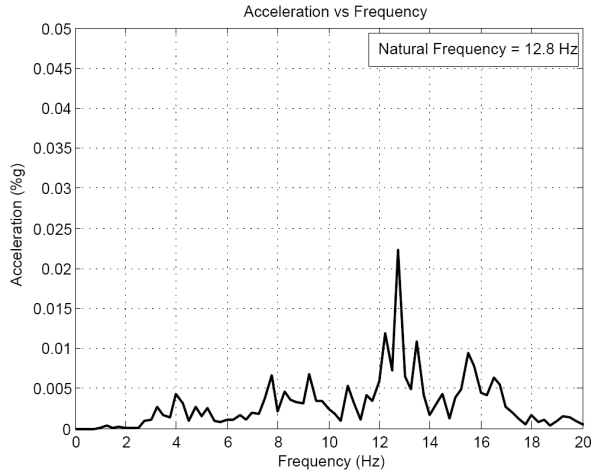
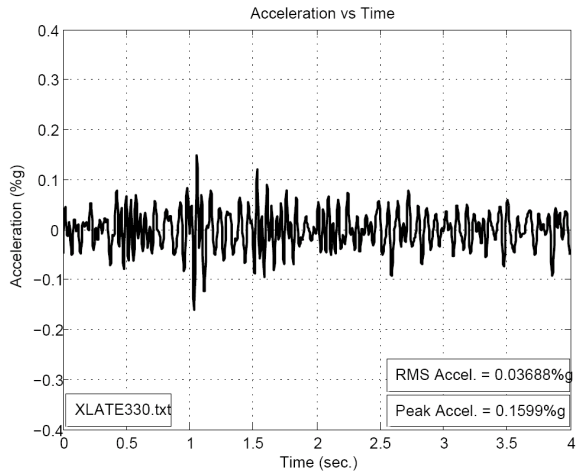

a) Ambient Vibrations

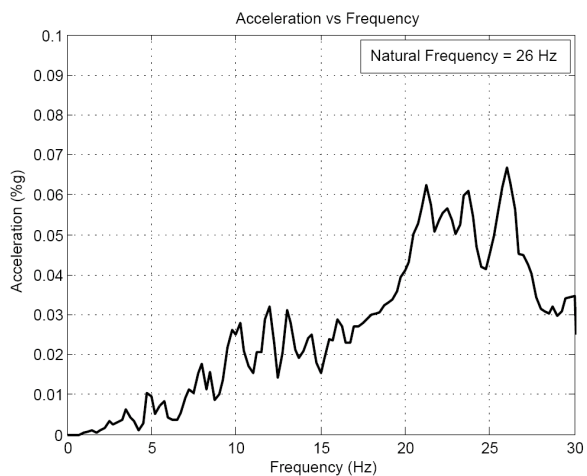
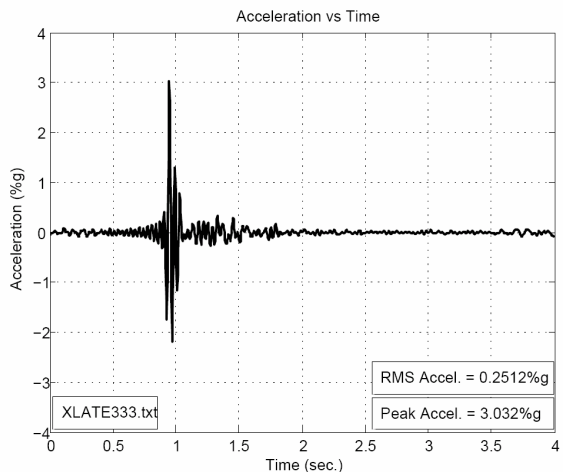

b) Heel-Drop

Figure 2.5 Test Measurements for Bay 3, Hampton Inn

The results for Bay 2 are presented in Figure 2.4. The frequency spectrum for ambient motion and heel-drop excitation shown in Figures 2.4(a) and (b) indicate that the floor natural frequency for this bay is 16.75 Hz. From the heel-drop test, it is determined that the damping ratio is 0.028. For the test of Figure 2.4(c), the walking frequency was 2.40 Hz, which corresponds to the seventh subharmonic of the floor frequency. The peak response of walking at this frequency is 1.32 %g, as shown in the acceleration response history of Figure 2.4(c). For bouncing, the excitation frequency was 2.80 Hz, which is the sixth subharmonic of the floor natural frequency.

Floor acceleration responses and their frequency spectra for Bay 3 are presented in Figure 2.5. The spectrum for ambient vibrations indicates that the natural frequency of this floor is 12.8 Hz. The acceleration at this frequency is 0.023 %g. This value is quite small; therefore, it was determined that the motion due to ambient vibrations did not apply enough energy in the system to capture its natural frequency. The heel-drop excitation spectrum shows that the natural frequency is 26.0 Hz. Based on this high frequency value, it was determined that this floor is not susceptible to vibration levels that could cause discomfort in the occupants. For this reason, no further tests to assess the floor performance due to walking and bouncing were performed.

2.3.2 Caribe Cove

The second tested structure was the Caribe Cove, Kissimmee, FL. Tests were conducted in the fourth floor while the building was in construction. Experiments were conducted in a typical unit, where the slab depth is 6 in., with normal weight concrete ($f'_c = 4000$ psi). The steel deck used for this slab is 2.0 in. deep CSi Versa-Dek® XLS, 22 gauge, 24.5" CW. The floor is supported by an 8 in. CMU wall and a 7-1/2 in. x 45 in. reinforced concrete beam. The floor span is 23 ft 6 in. and the width is 13 ft 9 in.

Dynamic tests were performed to determine the natural frequencies and the acceleration response of the floor. Measurements due to ambient motion, heel-drops, walking parallel and perpendicular to the deck span, decay, and bouncing were taken. Table 2.3 shows the results for the 17 measurements obtained from the tests. As shown in the table, the fundamental natural frequency of the floor is 11.8 Hz.

The floor was excited with walking and bouncing frequencies ranging between 1.83 and 2.35 Hz. The walking paces, measured in steps per minute, were 141, 131, 125, 117, and 110. These paces correspond to frequencies of 2.35 Hz, 2.18 Hz, 2.08 Hz, 1.96 Hz, and 1.83 Hz, respectively. The 2.35 Hz walking frequency is the fifth subharmonic of the floor frequency; the 1.96 Hz frequency is the sixth subharmonic of the floor frequency. As a result of walking at these subharmonic frequencies the floor response can undergo a resonant build up.

Table 2.3 Summary of Measurements, Caribe Cove, Fourth Floor, Bay 4

Excitation	Speed (bpm/Hz)	Dominant Frequencies (Hz)			Associated Accelerations (% of Gravity)		
Ambient		11.75	10.00	0.00			
Heel-Drop		11.75	15.25	10.00			
Walking Parallel	141/2.35	11.75	15.50	14.25	0.52	0.07	0.06
Walking Parallel	141/2.35	11.75	9.25	27.25	0.34	0.09	0.07
Walking Parallel	131/2.18	11.25	9.75	11.00	0.32	0.09	0.07
Walking Parallel	125/2.08	11.50	15.75	9.50	0.16	0.06	0.06
Walking Parallel	117/1.96	11.75	15.50	21.25	0.21	0.15	0.12
Walking Parallel	110/1.83	11.75	21.25	16.25	0.12	0.07	0.07
Bouncing	141/2.35	11.75	9.25	7.00	2.09	0.27	0.19
Decay	141/2.35	11.75	15.25	10.00			
Bouncing	117/1.96	11.75	9.75	15.50	2.46	0.54	0.40
Decay	117/1.96	11.75	15.25	10.00			
Walking Perpendicular	141/2.35	12.00	15.00	15.50	0.50	0.19	0.08
Walking Perpendicular	131/2.18	12.00	11.00	11.50	0.15	0.12	0.09
Walking Perpendicular	125/2.08	11.75	21.50	8.50	0.14	0.11	0.07
Walking Perpendicular	117/1.96	11.75	15.50	9.75	0.32	0.11	0.10
Walking Perpendicular	110/1.83	9.25	22.00	16.50	0.07	0.07	0.06

Five measurements were analyzed to assess the performance of this floor. The acceleration traces and spectra for ambient excitation, heel-drop excitation, walking parallel and perpendicular at 2.35 Hz, and bouncing at 2.35 Hz are plotted in Figure 2.6.

From the frequency spectra for ambient excitation and motion due to a heel-drop shown in Figure 2.6(a) and (b), it is determined that the fundamental natural frequency of the floor is 11.8 Hz. The damping ratio measured from the heel-drop test is 0.008.

The results obtained from the walking tests indicate that the floor experiences resonance. The forcing frequency of 2.35 Hz, which is the fifth subharmonic of the floor natural frequency, excites the floor every five cycles of free vibration, causing a signal build up. This phenomenon is clearly observed in the acceleration time history of Figure 2.6(c) from walking parallel to the steel deck span at 2.35 Hz. This plot shows how the acceleration trace reaches a new peak every five cycles of free vibration to attain a total

peak acceleration of 0.78 %g. The resonant response is also observed in the acceleration trace of Figure 2.6(d) for walking perpendicular at 2.35 Hz. The bouncing test plots of Figure 2.6(e) also show the response experienced when the floor is excited at the fifth subharmonic. In this case, the floor attains a peak acceleration of 3.39 %g.

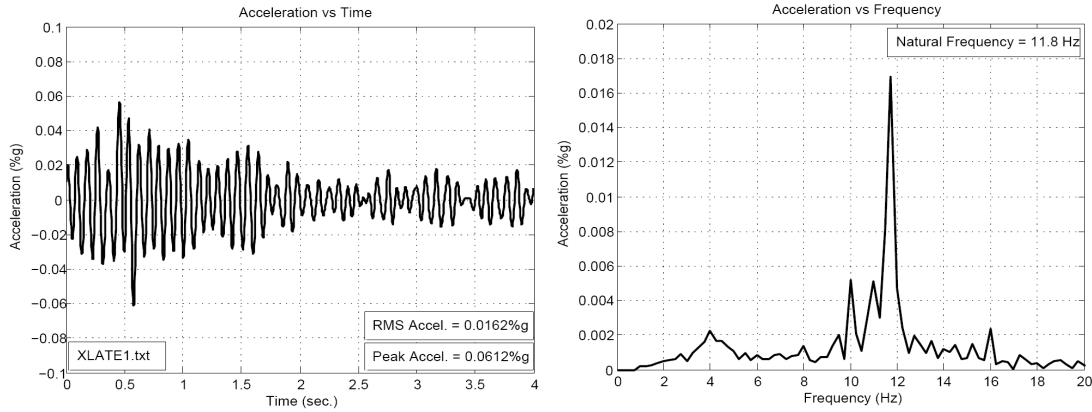

a) Ambient Vibrations

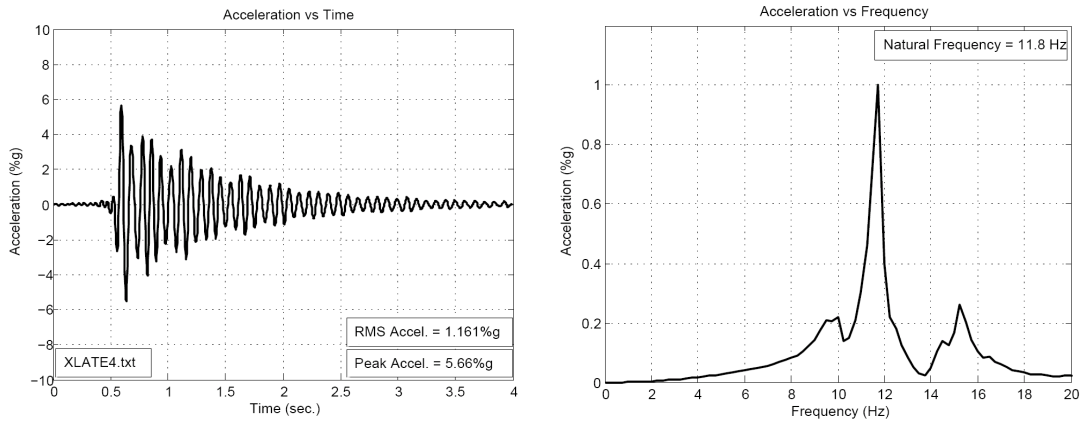

b) Heel-Drop

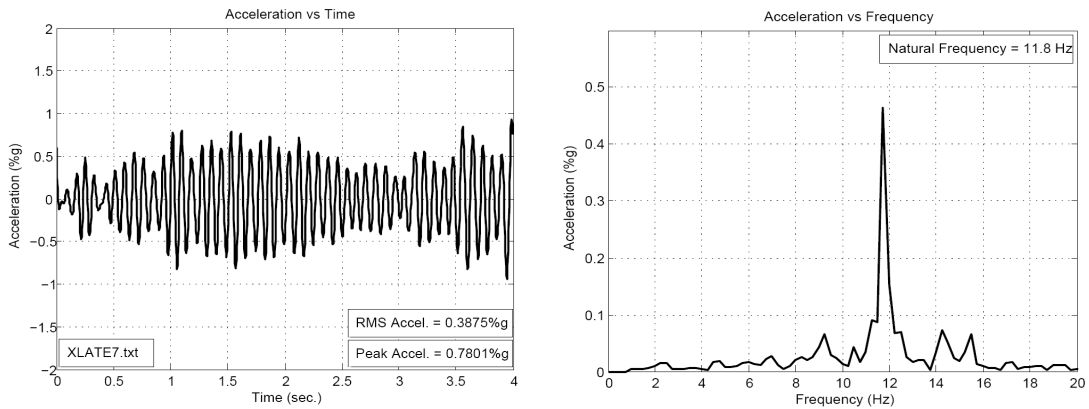

c) Walking Parallel at 141 bpm (2.35 Hz)

Figure 2.6 Test Measurements for Bay 4, Caribe Cove

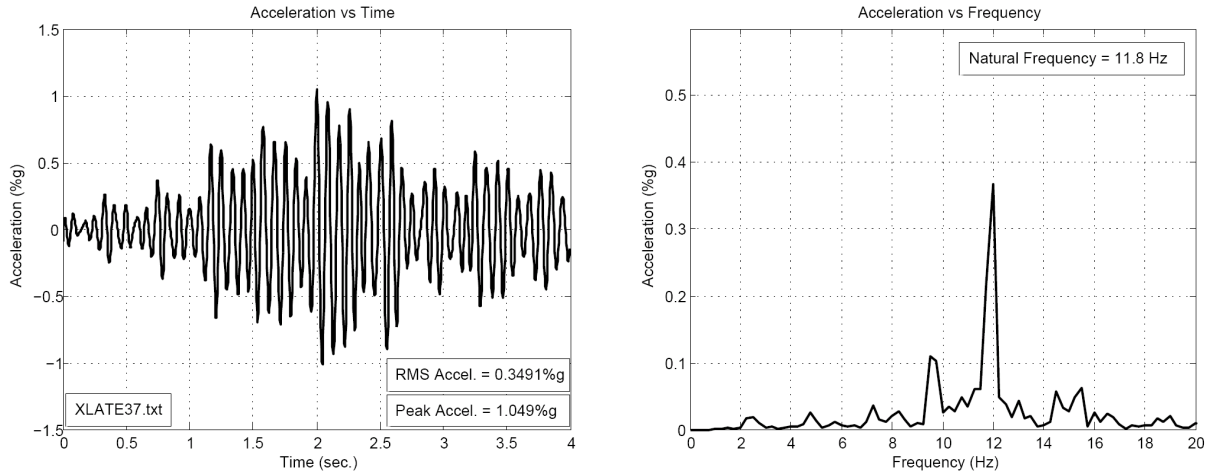

d) Walking Perpendicular at 141 bpm (2.35 Hz)

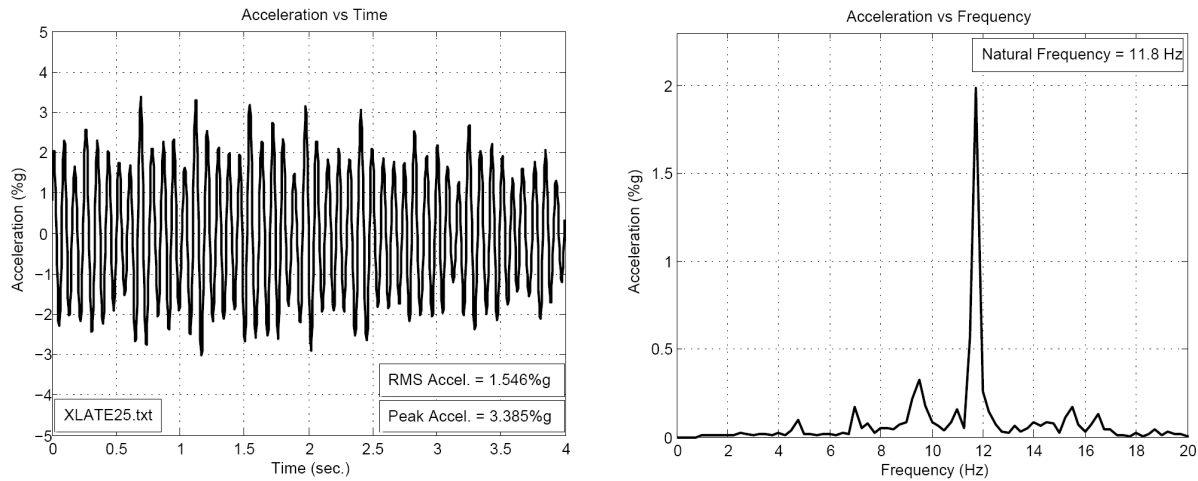

e) Bouncing at 141 bpm (2.35 Hz)

Figure 2.6 Test Measurements for Bay 4, Caribe Cove, Continued

2.3.3 Concord and Cumberland

Tests were conducted in the Concord and Cumberland building, Charleston, SC. The measurements were taken when the building was under construction, as shown in Figure 2.7. The steel deck used in this floor is 2.0 in. deep Versa Dek S®, 22 gauge. The slab has a total depth of 6 in. with 4 in. of normal weight concrete, $f'_c = 3.0$ ksi, placed over the 2 in. deep steel deck. The floor has a length of 21 ft 8-3/8 in. and a width of 30 ft 5-1/2 in. The slab is supported at its ends by stud walls in the direction perpendicular to the deck span. In the other direction, the slab is supported by a 7 ft 9 in. stud wall and a

TS 4x 4x ¼ column. At its ends, the slab is reinforced with #6 reinforcement bars at every 6 in. o.c. to resist the bending moments at the supports. The length of the reinforcement bars is 10 ft. The detailing of the floor at the connection is shown in Figure 2.8.

Dynamic tests were carried out to assess the performance of this floor. Heel-drop and walking tests were performed to determine the floor natural frequency. Tests were also conducted walking parallel and perpendicular to the deck span. The walking paces were set to match the natural frequency subharmonics, attempting to cause a resonant response of the floor. The heel-drop tests were executed at the center of the floor. The seismic accelerometer was placed at the center of the floor to capture the maximum acceleration response. A summary of the results obtained for these measurements is presented in Table 2.4.



Figure 2.7 Concord and Cumberland Floor at Time of Testing

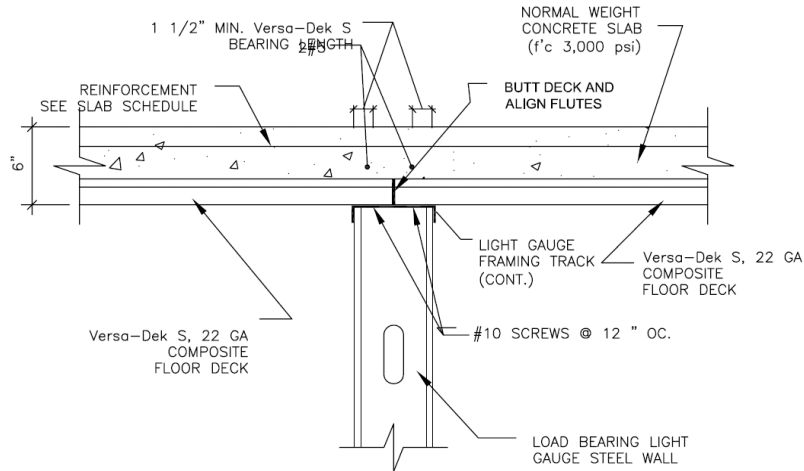

21 TYPICAL INTERIOR BEARING AT SHEET END

Figure 2.8 Connection Detailing at the Slab Support, Concord and Cumberland

Table 2.4 Summary of Measurements, Concord and Cumberland, Bay 5

Excitation	Speed (bpm/Hz)	Dominant Frequencies (Hz)			Associated Accelerations (% of Gravity)		
Heel-Drop		13.50	21.50	10.25			
Heel-Drop		13.50	21.50	10.25			
Walking Parallel	101/1.68	14.50	15.00	14.25	0.29	0.07	0.05
Walking Parallel	101/1.68	13.75	14.50	15.50	0.26	0.06	0.04
Walking Parallel	116/1.93	13.50	15.25	14.25	0.24	0.06	0.04
Walking Parallel	116/1.93	13.50	15.25	7.75	0.27	0.06	0.04
Walking Parallel	135/2.25	13.50	14.50	12.50	0.20	0.05	0.04
Walking Parallel	135/2.25	13.50	14.25	12.25	0.15	0.12	0.06
Walking Parallel	90/1.50	13.50	12.00	15.00	0.28	0.05	0.09
Walking Perpendicular	101/1.68	13.50	15.25	12.00	0.37	0.06	0.04
Walking Perpendicular	101/1.68	13.25	15.00	14.00	0.28	0.08	0.07
Walking Perpendicular	116/1.93	13.25	15.25	19.00	0.20	0.05	0.03
Walking Perpendicular	116/1.93	13.25	15.25	14.25	0.15	0.06	0.05
Walking Perpendicular	135/2.25	13.50	14.25	11.00	0.24	0.08	0.05
Walking Perpendicular	135/2.25	13.25	14.25	15.25	0.16	0.08	0.04
Walking Perpendicular	90/1.5	13.50	12.25	15.25	0.26	0.05	0.04
Walking Perpendicular	101/1.68	13.50	14.25	12.00	0.32	0.07	0.04

Heel-drop and walking tests were conducted to provide the required information to address the dynamic performance of this floor. From the heel-drop tests, it was determined that the fundamental natural frequency of the floor is 13.50 Hz. This is shown in the heel-drop frequency spectrum in Figure 2.9(a). The spectrum shows that most of the energy of the heel-drop excites the first mode of the slab. A minor response of a higher mode at 21.50 Hz is also present, but it is very small compared to the fundamental mode response. The damping ratio measured from the heel-drop spectrum is 0.030.

Walking tests were performed to determine the acceleration response of the floor under a dynamic load. Tests were done walking perpendicular and parallel with respect to the deck span, at 135 bpm, 116 bpm, 101 bpm, and 90 bpm. These paces correspond to frequencies of 2.25 Hz, 1.93 Hz, 1.68 Hz, and 1.5 Hz, respectively. The walking frequencies were set with the aim of causing a built-up response of the floor acceleration. The forcing frequencies shown above are the sixth, seventh, eighth, and ninth subharmonics of the floor natural frequency. The plots of the acceleration traces and the spectra due to walking parallel at 90 bpm, perpendicular at 90 bpm, and perpendicular at 101 bpm are presented in Figure 2.9(b), (c), and (d), respectively .

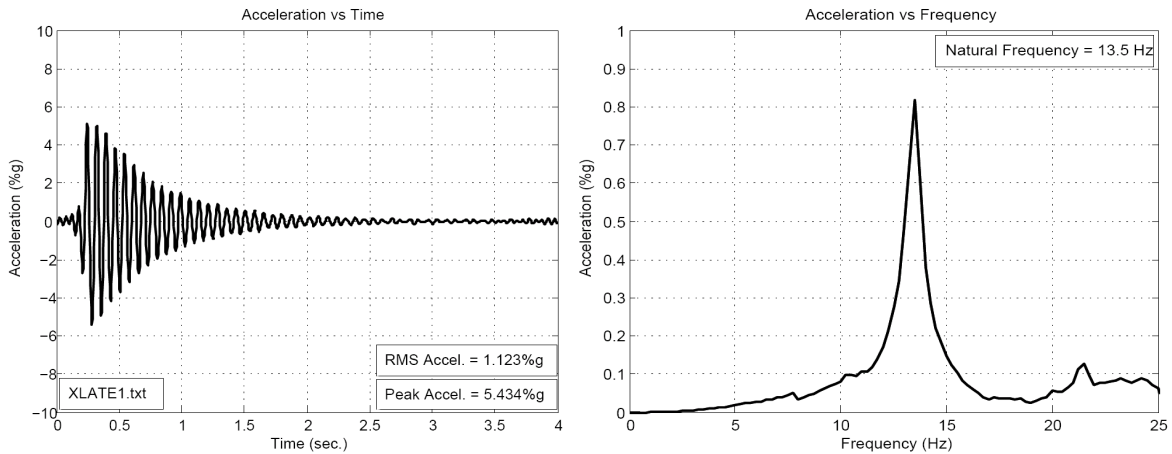

a) Heel-drop Response

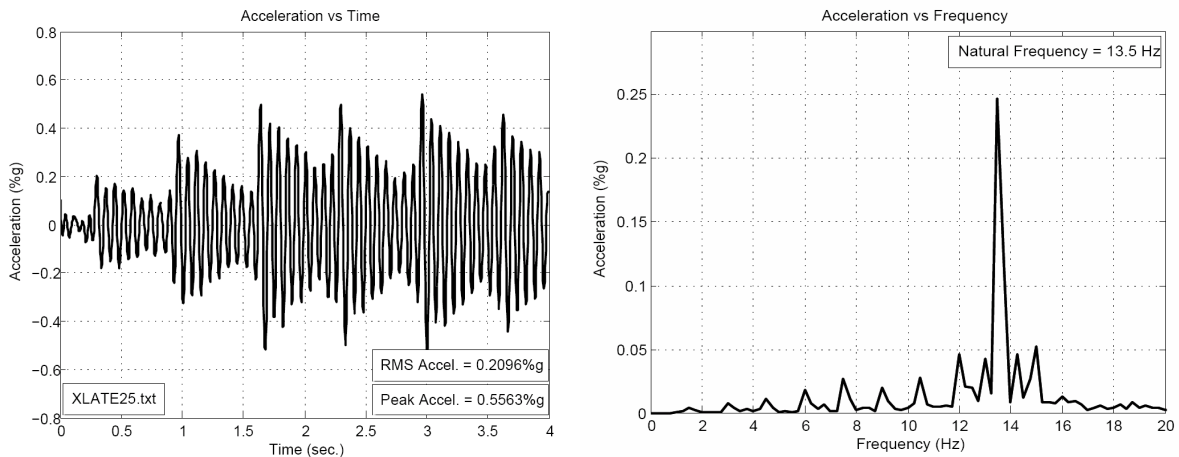

b) Walking Parallel at 90 bpm (1.50 Hz)

Figure 2.9 Test Measurements for Bay 5, Concord and Cumberland

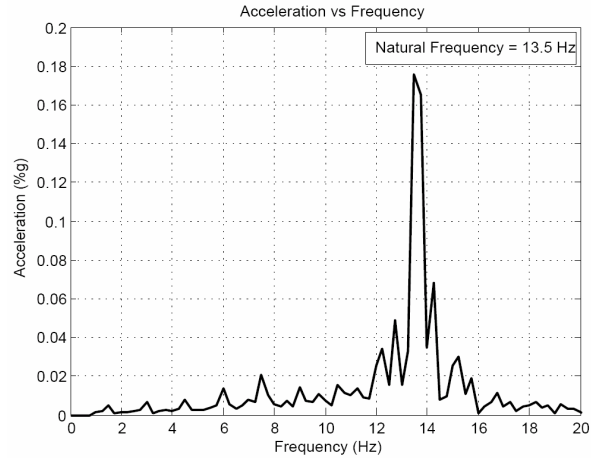
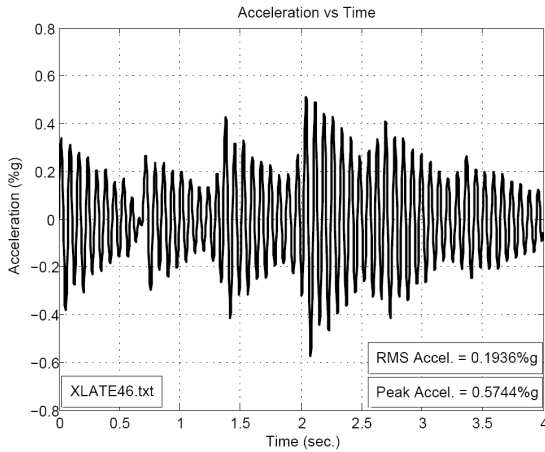

c) Walking Perpendicular at 90 bpm (1.50 Hz)

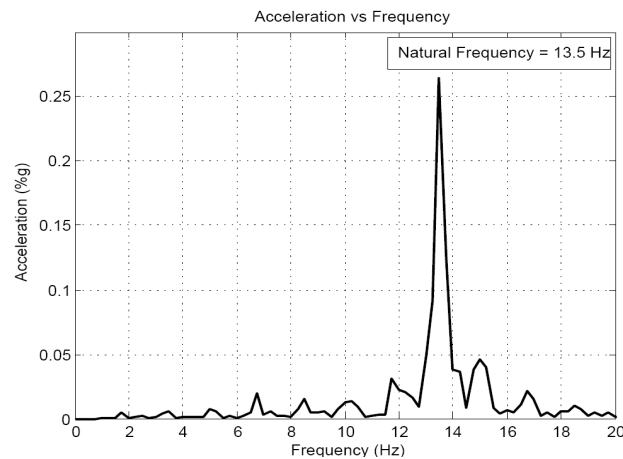
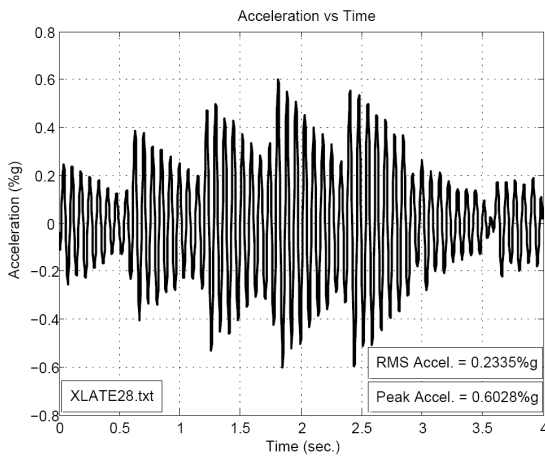

d) Walking Perpendicular at 101 bpm (1.68 Hz)

Figure 2.9 Test Measurements for Bay 5, Concord and Cumberland, Continued

The acceleration response histories and the frequency spectra show that the floor is excited at its fundamental frequency since the walking energy excites only the first vibration mode. This is observed in the frequency spectra of Figures 2.9(b), (c), and (d), where the frequency content above and below the floor frequency is almost null, indicating that all the walking energy is dissipated in the excitation of the fundamental mode of vibration of the floor.

In the tests performed with walking frequencies of 2.25 Hz, 1.93 Hz, 1.68 Hz, and 1.5 Hz, the floor had an impulse response, which corresponds to the characteristic

response of high frequency floors, as described in Section 1.4.1. This behavior is evident in Figures 2.9 (b), (c), and (d), where the plots show the peak formed with each step, followed by a fast decay of the acceleration response. Figure 2.9 (b), for example, shows how a new peak appears in the acceleration trace every nine cycles of free vibration. The response continues to grow, reaching a maximum peak when a person walks near the accelerometer.

The measured accelerations due to walking indicate that the floor behavior is the same, regardless of the direction of the walking path. For walking parallel at 90 bpm, the peak acceleration is 0.56 %g. For walking perpendicular at 90 bpm, the peak acceleration is 0.57 %g. A comparison of the frequency spectra of Figures 2.9(b) and (c) shows that for both directions the spectra are very similar, indicating that the floor vibration characteristics are almost the same in both cases.

2.3.4 Royal Reef Resort

Floor vibration tests were conducted on the second floor of the Staff House, Building C, Royal Reef Resort, North Caicos, BWI. The layout of the tested floor is presented in Figure 2.10. Measurements were taken in the bay between grid lines 4 and 5 (Bay 6) and the bay between grid lines 7 and 8 (Bay 7). The total depth of the slab in Bay 6 is 6 $\frac{3}{4}$ in., and the steel deck used in this bay is the 2.0 in. deep Versa Dek XLS®, 18 gauge, with 4 $\frac{3}{4}$ in. of normal weight concrete ($f'_c = 4.0$ ksi). The span of this bay is 23 ft 0 in., and the width is 32 ft 0 in. In Bay 7, the total depth of the slab is 5 $\frac{1}{2}$ in., and the deck is the 2.0 in. deep CSi CDF 2®, 18 gauge, 36" CW. The concrete is the same as that in Bay 6. The Bay 7 span is 14 ft 0 in., and the width is 29 ft 4-5/8 in. Both bays are supported at their ends by CMU walls.

Dynamic experiments were conducted in Bays 6 and 7. Tests for ambient motion, heel-drop excitation, and walking perpendicular and parallel to the deck span were done to measure the floor response. In Bay 6, the measurements were taken with the accelerometer placed at the center of the slab and at the center quarter point. In Bay 7, the accelerometer was placed at the center of the slab. Table 2.5 presents a summary of the measurements taken during these experiments.

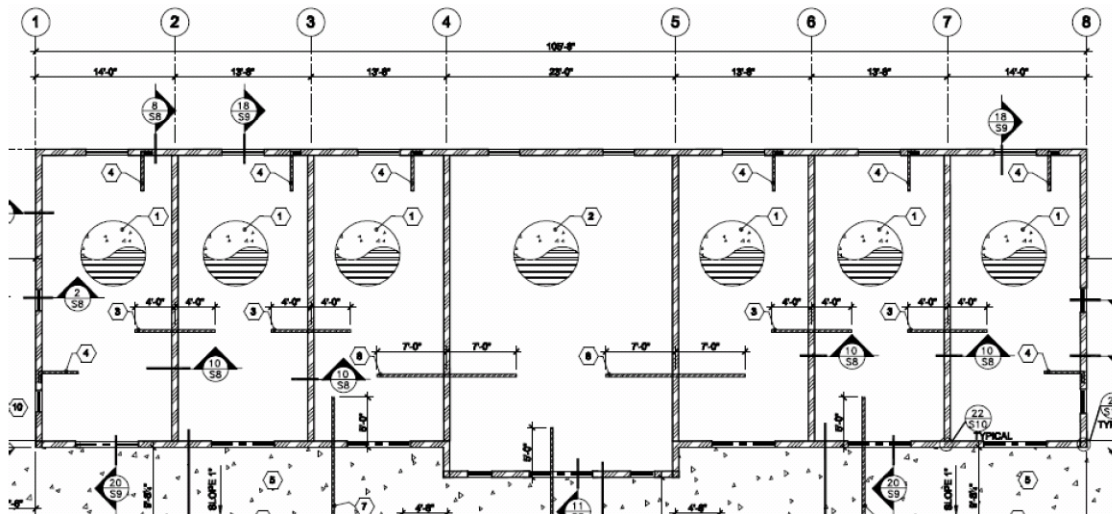
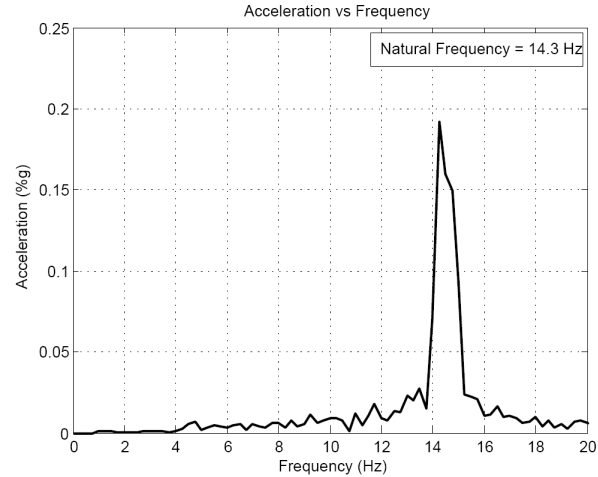
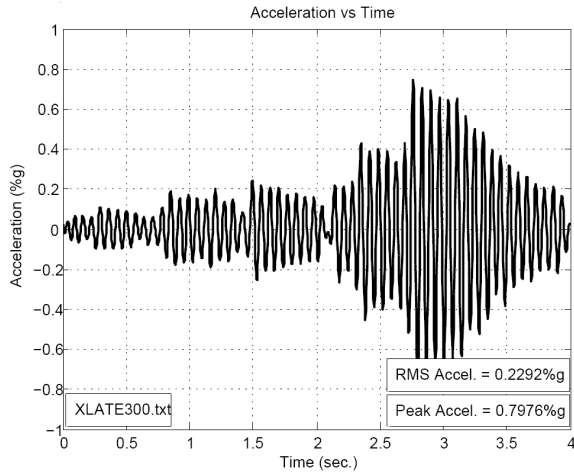

Figure 2.10 Royal Reef, Second Floor Layout

Table 2.5 Summary of Measurements, Royal Reef, Second Floor

Bay	Accel. Location	Excitation	Speed (bpm/Hz)	Dominant Frequencies (Hz)			Associated Accelerations (% of Gravity)		
6	Center	Ambient		14.25	14.75	94.50			
		Heel-Drop		14.50	96.50	31.00			
		Walking Perpendicular	100/1.67	15.25	13.50	14.25	0.14	0.11	0.07
		Walking Perpendicular	109/1.82	14.50	13.25	16.00	0.48	0.04	0.04
		Walking Perpendicular	118/1.97	14.75	14.00	15.75	0.17	0.16	0.07
		Walking Parallel	100/1.67	14.50	14.00	16.75	0.21	0.12	0.03
		Walking Parallel	109/1.82	14.50	15.50	16.50	0.42	0.06	0.05
	Center Front 1/4 th Point	Walking Parallel	118/1.97	13.75	14.50	15.50	0.15	0.12	0.08
		Heel-Drop		14.50	20.50	21.25			
		Walking Perpendicular	100/1.67	14.50	14.00	20.75	0.11	0.05	0.05
		Walking Perpendicular	109/1.82	14.50	20.75	21.75	0.10	0.08	0.08
		Walking Perpendicular	118/1.97	21.50	20.50	14.25	0.14	0.13	0.12
		Walking Perpendicular	109/1.82	20.25	14.25	22.25	0.13	0.07	0.07
		Walking Parallel	100/1.67	20.75	14.50	19.00	0.15	0.08	0.05
7	Center	Walking Parallel	109/1.82	20.25	25.25	21.75	0.10	0.08	0.07
		Walking Parallel	118/1.97	21.50	19.50	13.75	0.17	0.12	0.05
		Heel-Drop		28.00	84.75	85.25			
		Fast Walk Perp.		28.25	86.50	86.50	0.25	0.14	0.13
		Fast Walk Parallel		27.50	85.50	85.50	0.11	0.08	0.06

Selected plots of the acceleration traces and spectra are presented in Figures 2.11 and 2.12 for Bays 6 and 7, respectively. The plots presented in these figures contain the information required to assess the vibration properties of these two floors. The complete set of plots for the 17 measurements taken for Bay 6 and the three measurements taken for Bay 7 are presented in Appendix A.



a) Ambient Vibrations. Accelerometer at Floor Center

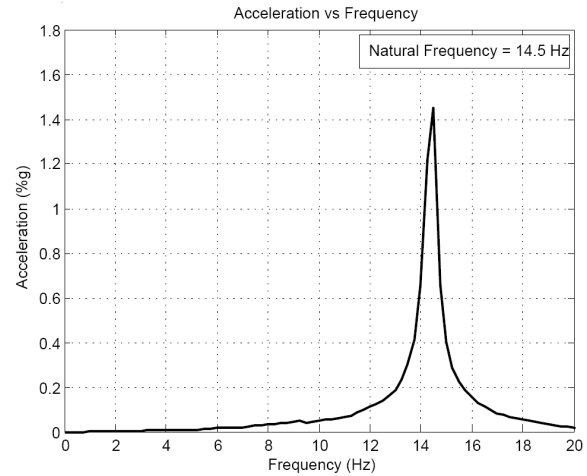
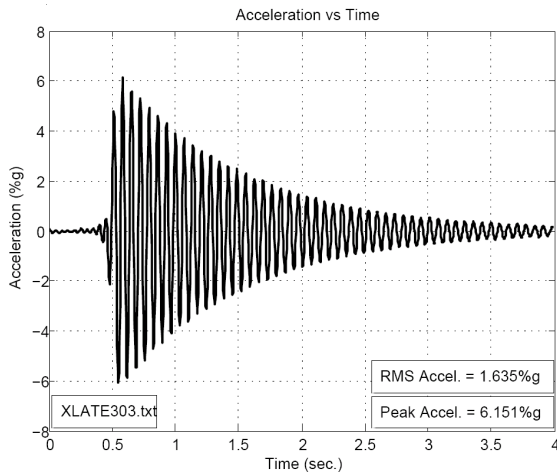

b) Heel-Drop. Accelerometer at Floor Center

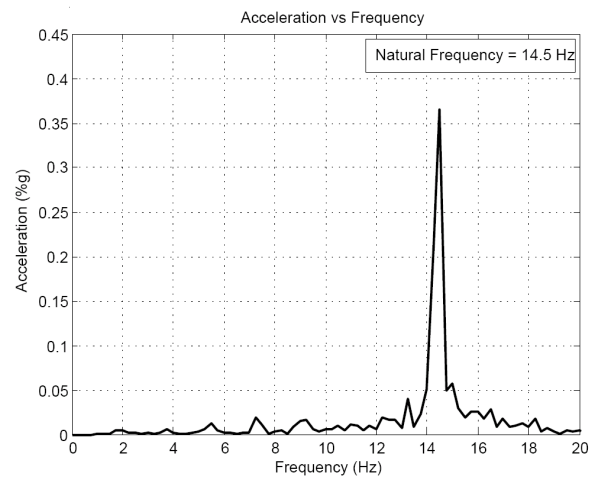
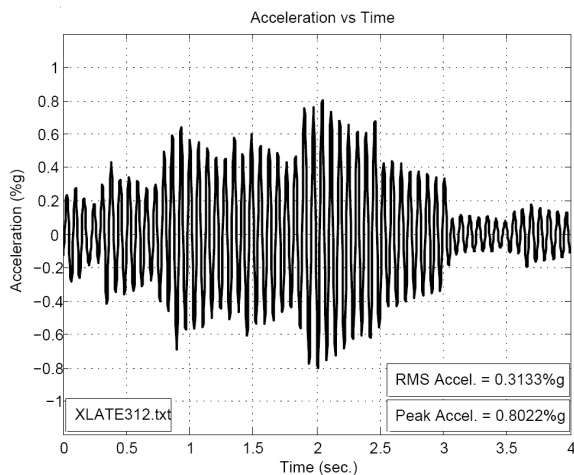

c) Walking Perpendicular at 109 bpm (1.82 Hz). Accelerometer at Floor Center

Figure 2.11 Test Measurements for Bay 6, Royal Reef

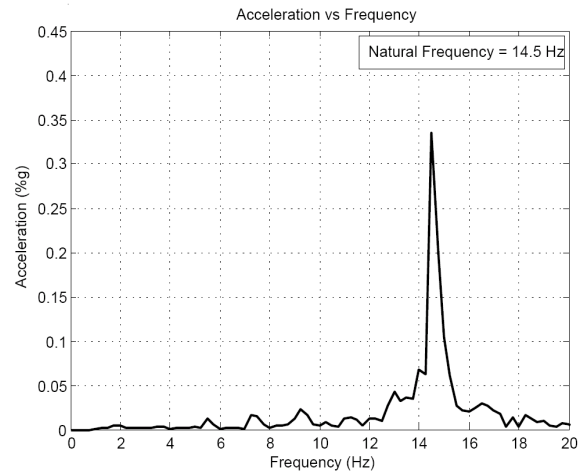
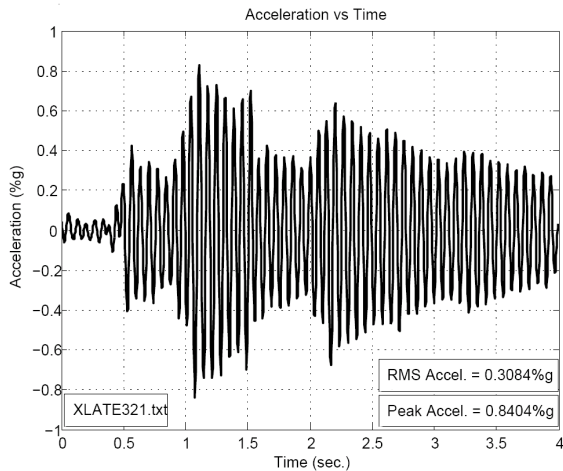

d) Walking Parallel at 109 bpm (1.82 Hz). Accelerometer at Floor Center

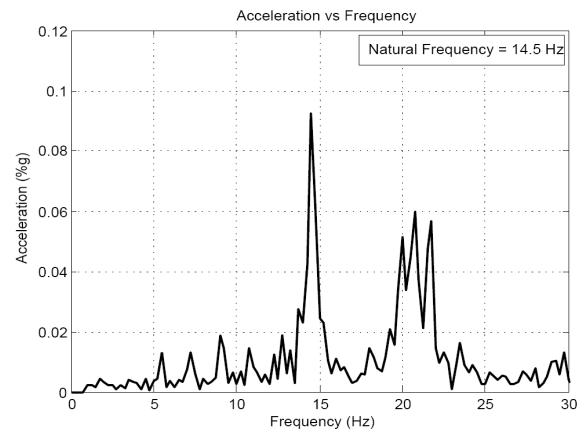
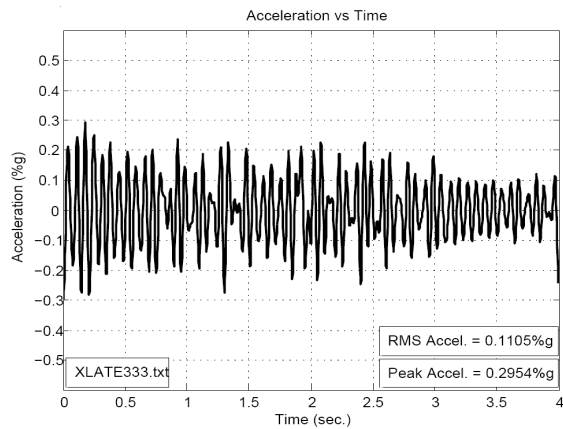

e) Walking Perpendicular at 109 bpm (1.82 Hz). Accelerometer at Center Front Quarter

Figure 2.11 Test Measurements for Bay 6, Royal Reef, Continued

The vibration characteristics of Bay 6 are determined from Figure 2.11. The ambient motion spectrum of Figure 2.11(a) shows that the floor natural frequency in Bay 6 is between 14.3 Hz and 14.5 Hz. From Figure 2.11(b), the floor frequency measured with the heel-drop excitation is 14.5 Hz, with only the first vibration mode being excited. This is clearly observed in the heel-drop spectrum, where the only one peak occurs at 14.5 Hz. From the heel-drop test, it is also determined that the damping ratio is 0.017.

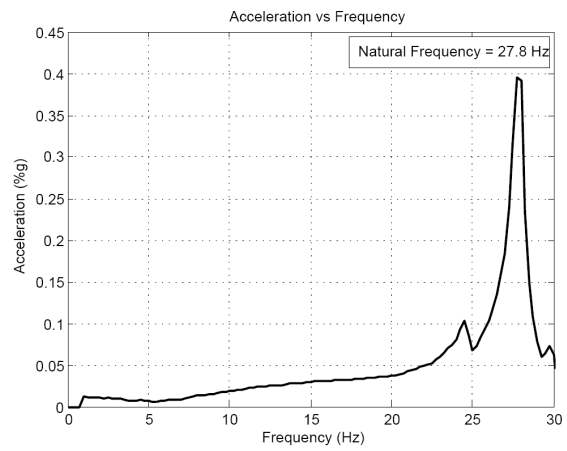
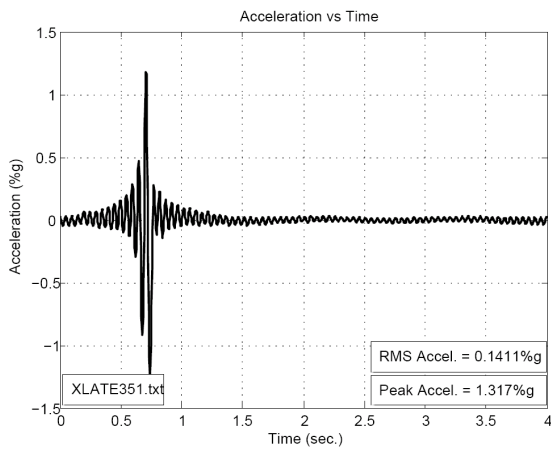

a) Heel-Drop

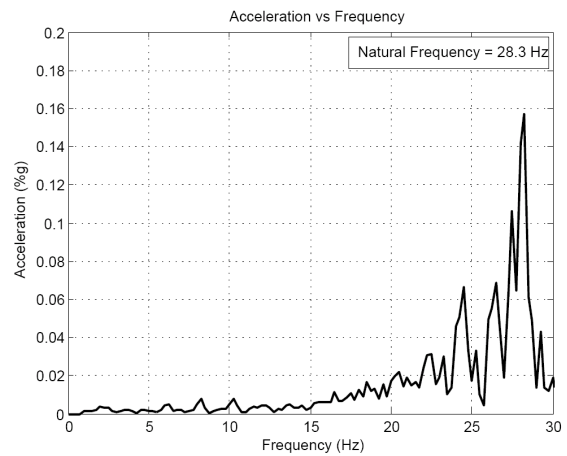
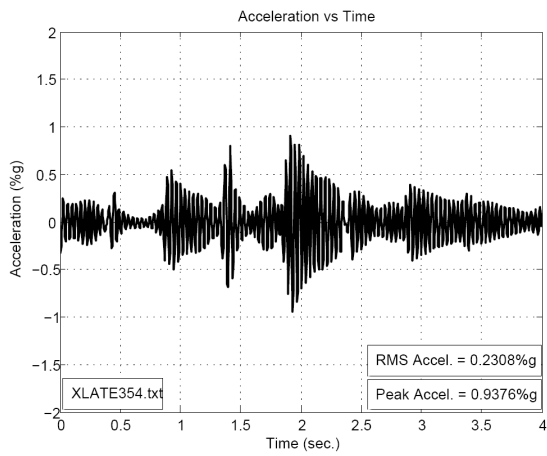

b) Walking Fast, Perpendicular

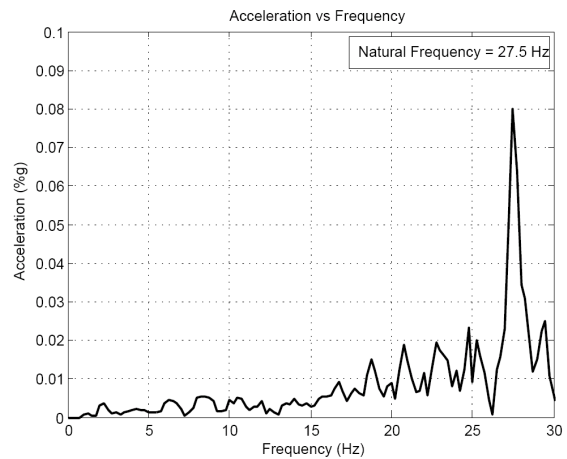
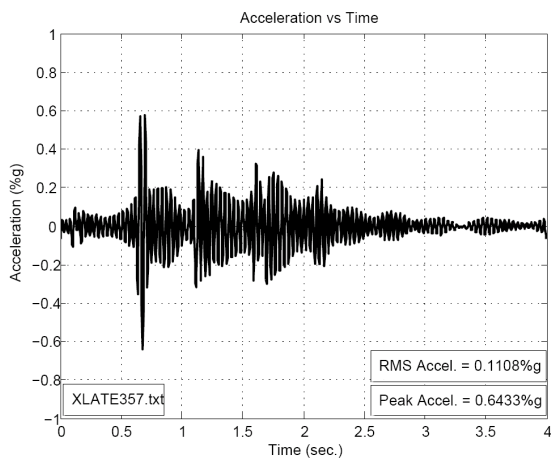

c) Walking Fast, Parallel

Figure 2.12 Test Measurements for Bay 7, Royal Reef

In Bay 6, walking tests were performed walking perpendicular and parallel to the deck span. Tests were conducted at speeds of 100 bpm, 109 bpm, and 118 bpm. The corresponding frequencies for the walking speeds are 1.67 Hz, 1.82 Hz, and 1.97 Hz, respectively. The frequency of 1.82 Hz is the eighth subharmonic of the floor natural frequency. Walking at this frequency was performed as an attempt to cause a build up in the floor response.

The acceleration trace of walking perpendicular at 1.82 Hz with the accelerometer placed at the floor center indicates that the peak acceleration is 0.80 %g. This is shown in Figure 2.11(c). The spectrum of this figure also shows that only the fundamental vibration mode is excited when walking at this frequency. For walking at 1.82 Hz in the parallel direction with the accelerometer in the same position, the peak acceleration is 0.84 %g, as shown in the acceleration response history of Figure 2.11 (d). The measured peak accelerations for both walking directions are almost the same. This indicates that the walking direction does not influence the floor response. This is also observed in the similarities between spectra for walking in each direction.

The plots in Figure 2.11(d) show the acceleration trace and the frequency spectrum for walking at 1.82 Hz with the measurements taken at the center front quarter point of the bay. The frequency content in the spectrum shows that the floor is excited at the fundamental vibration mode and at a second mode at 20.8 Hz. The response, however, is very low for both modes. The peak acceleration for this measurement is 0.30 %g, which is quite smaller than the accelerations measured at the center of the bay.

The acceleration response histories and frequency spectra for the experiments in Bay 7 are presented in Figure 2.12. The heel-drop excitation spectrum of Figure 2.12(a) shows that the floor natural frequency is 27.8 Hz. Floor vibrations are not perceived by humans at this high frequency and are not a serviceability issue. Therefore, only two walking tests were conducted on this floor. The acceleration traces show that the peak accelerations for walking perpendicular and walking parallel are 0.94 %g and 0.64 %g, respectively. These accelerations, however, have little meaning in floor vibration analysis since the floor natural frequency is very high. The damping ratio determined from the heel-drop spectrum is 0.016.

2.3.5 Seybold Flats

Three areas were tested in the Seybold Flats building, Tampa, FL: two on the second level, Bays 8 and 9, (Units 201 and 203) and one floor on the fourth level, Bay 10 (Unit 401). The layouts of the three areas are shown in Figure 2.13. The building construction was near completion when vibration tests were conducted with ceiling and ductwork in place below the tested areas. The conditions at the time of testing are shown in the photographs of Figure 2.14. The arrows in Figures 2.13 and 2.14 show the deck direction and the walking paths, respectively.

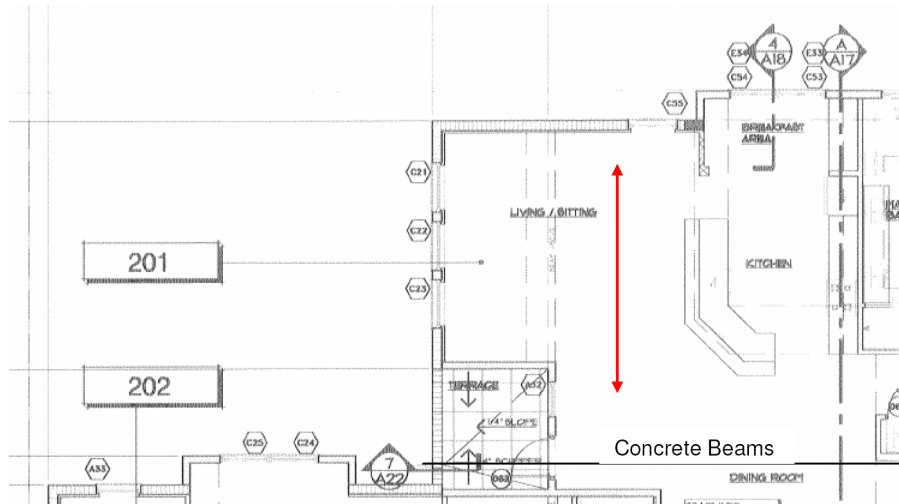

a) Bay 8 (Unit 201)

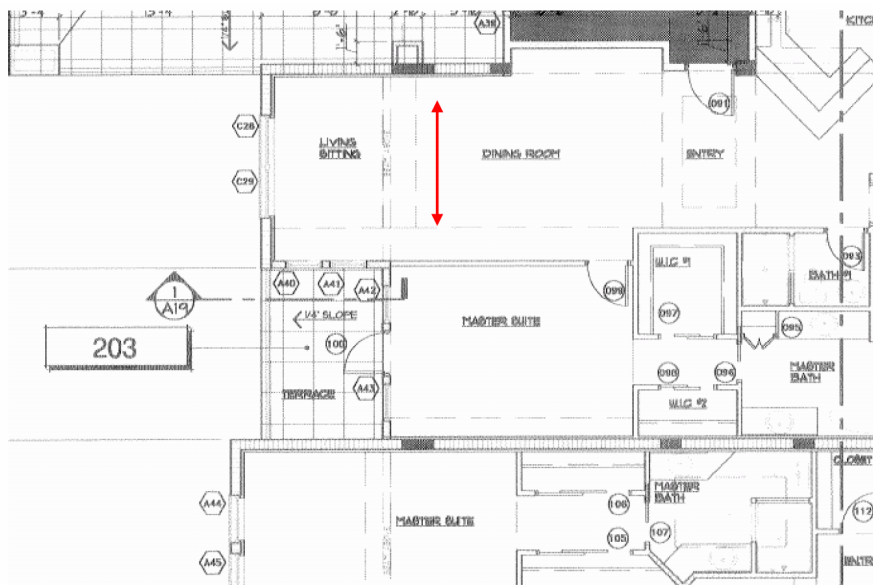

b) Bay 9 (Unit 203)

Figure 2.13 Room Layouts for Bays 8, 9, and 10, Seybold Flats

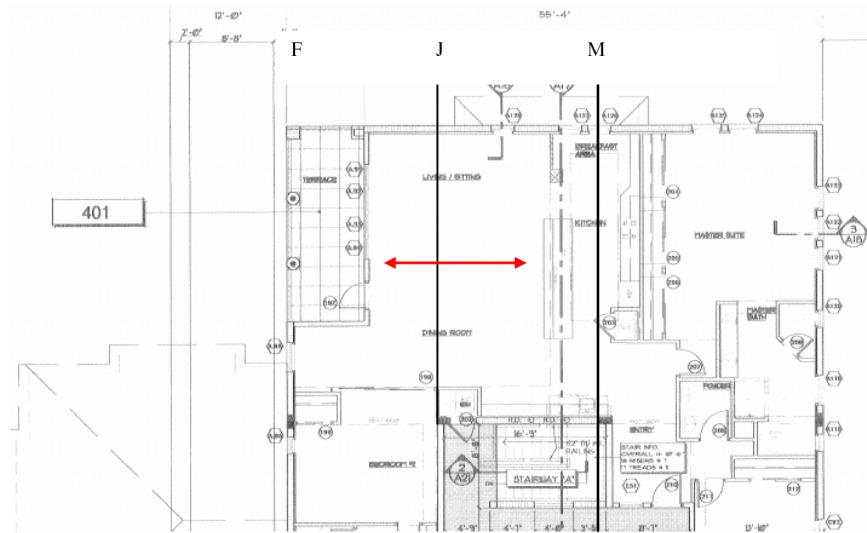

c) Bay 10 (Unit 401)

Figure 2.13 Floor Layouts for Bays 8, 9, and 10, Seybold Flats, Continued



a) Bay 8



b) Bay 9



c) Bay 10

Figure 2.14 Units at Time of Testing, Seybold Flats

In the three tested bays, the total slab thickness is 6.0 in. with 4.0 in. of normal weight concrete cast over 2.0 in. deep Versa-Dek XLS®, 20 gauge, 24.5” CW. The floor in Bay 8 is supported by a masonry wall at one end and 16 in. x 48 in. concrete beams at the other end. The bay length is 22 ft 0 in. and the width is 17 ft 8 in. The supports in Bay 9 are a masonry wall on one side and an 8 in. x 16 in. concrete beam on the other side. The slab in the fourth floor, where Unit 401 is located, has an intermediate support that divides the floor into two spans. The exterior support is an 8 in. x 36 in. concrete beam. The intermediate support is a W21x73 steel beam, and the other support is a W21x83 beam. The span between the concrete beam and the W21x73 member is 15 ft 6 in. The span between the W21x73 member and the W21x83 is 16 ft 9 in. Bay 10 is located between the two steel beams. Thus, the floor length in Bay 10 is 16 ft 9 in. and the width is 29 ft 3 in. A partition wall is supported by the Bay 10 slab between grid lines J and M, as shown in Figure 2.13(c).

Four types of excitations were used to cause motion in each bay. Nine floor motion measurements due to ambient vibrations, heel-drop excitations, and walking were taken in Bay 8. Two measurements were taken for Bay 9, and twelve measurements were recorded for Bay 10. Tests in Bay 10 were performed with the excitations mentioned above and bouncing excitations. Table 2.6 is the summary of the frequencies and accelerations measured during the tests.

Table 2.6 Summary of Measurements, Seybold Flats

Floor	Bay	Excitation	Speed (bpm/Hz)	Dominant Frequencies (Hz)			Associated Accelerations (% of Gravity)		
Second	Bay 8	Ambient		11.50	60.75	59.00			
		Heel-Drop		11.50	16.25	13.75			
		Walking	115/1.92	11.75	9.75	7.75	0.21	0.07	0.07
		Walking	100/1.67	16.75	11.75	21.75	0.07	0.06	0.03
		Walking	130/2.17	10.75	8.75	12.00	0.09	0.06	0.05
		Walking	138/2.30	11.25	9.00	13.50	0.23	0.09	0.07
		Walking	130/2.17	10.75	12.75	8.50	0.11	0.09	0.07
		Walking	172/2.87	11.50	17.00	8.50	0.54	0.20	0.09
	Walking	160/2.67	11.50	9.25	14.00	0.26	0.08	0.06	
		Bay 9	Ambient		29.50	45.25	59.00		
		Heel-Drop		20.50	57.00	58.00			
Fourth	Bay 10	Ambient		10.75	59.00	97.00			
		Heel-Drop		12.25	13.50	21.25			
		Walking	154/2.56	12.50	13.50	10.00	0.12	0.08	0.07
		Walking	122/2.03	12.00	14.50	9.75	0.13	0.05	0.05
		Walking	147/2.45	13.50	12.25	21.25	0.05	0.02	0.01
		Walking	132/2.20	13.25	13.75	11.00	0.05	0.04	0.03
		Walking	138/2.30	13.50	11.50	9.25	0.13	0.07	0.04
		Walking	135/2.25	13.50	11.25	9.00	0.13	0.06	0.04
		Walking	140/2.33	13.75	11.50	9.25	0.13	0.08	0.05
		Bouncing	140/2.33	13.75	4.50	11.50	0.08	0.05	0.05
		Bouncing	135/2.25	4.50	13.75	11.75	0.05	0.03	0.03
		Bouncing	145/2.41	4.75	12.25	9.75	0.06	0.05	0.04

As shown in the table, the first natural frequency of the floor in Bay 8 is 11.50 Hz. Walking tests were performed in this bay at frequencies of 1.67 Hz, 1.92 Hz, 2.17 Hz, 2.30 Hz, 2.67 Hz, and 2.87 Hz. Some of these frequencies are the floor natural frequency subharmonics. In particular, 1.67 Hz, 1.92 Hz, 2.30 Hz, and 2.87 Hz are the seventh, sixth, fifth, and fourth subharmonics of 11.50 Hz.

Bay 8 acceleration traces and the frequency spectra for ambient motion, heel-drop excitation, and walking at 172 bpm (2.87 Hz) are presented in Figure 2.15. The frequency spectra for ambient vibrations and the heel-drop excitation show that the floor fundamental natural frequency is 11.50 Hz.

The acceleration response due to walking at the fourth subharmonic of the floor frequency, 2.87 Hz, is presented in Figure 2.15(c). It is determined from this plot that the floor in Bay 8 has the dynamic characteristics of a high frequency floor. With every step, the acceleration trace reaches a peak, followed by four cycles of free vibration with a fast decay. The maximum peak acceleration in this case is 1.73 %g.

Plots for the floor response in Bay 9 are presented in Figure 2.16. The frequency spectrum for ambient vibrations, which is presented in Figure 2.16(a), barely captures the floor frequency. This spectrum indicates that the natural frequency of this floor is 29.5 Hz. The response for the heel-drop excitation and the frequency spectrum in Figure 2.16(b), however, shows that the floor frequency is 20.50 Hz. This frequency is out of the human vibration perception range; therefore, vibrations are not a controlling serviceability limit state, and no further tests were conducted in this floor. The measured damping ratio is 0.054.

Bay 10 was excited at walking frequencies ranging between 2.03 Hz and 2.56 Hz. These frequencies were set as an attempt to match the subharmonics of the floor frequency and cause a resonant response. Selected plots of the acceleration response history and its frequency spectrum are presented in Figure 2.17 for three types of excitations. The heel-drop spectrum shows that the floor frequency is between 12.30 and 13.80 Hz. As shown in the spectrum, the frequency content for this floor is complex, and a clear determination of the floor frequency is not possible. Figure 2.17(c) shows the plots that correspond to walking at 2.33 Hz. This frequency is approximately the sixth

subharmonic of 13.80 Hz. The response due to walking shows that the floor resembles the behavior of a high frequency floor, with a maximum peak acceleration of 0.38%g.

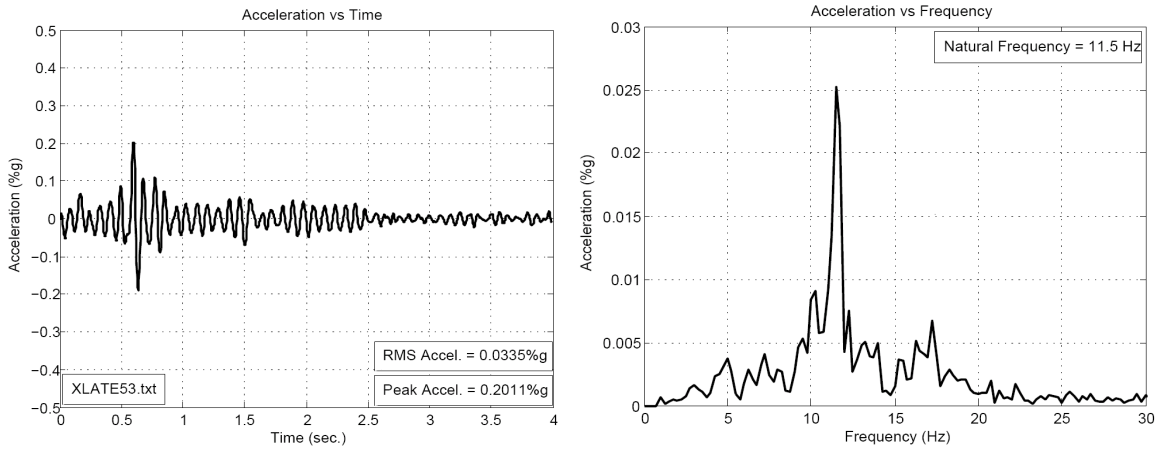

a) Ambient Vibrations

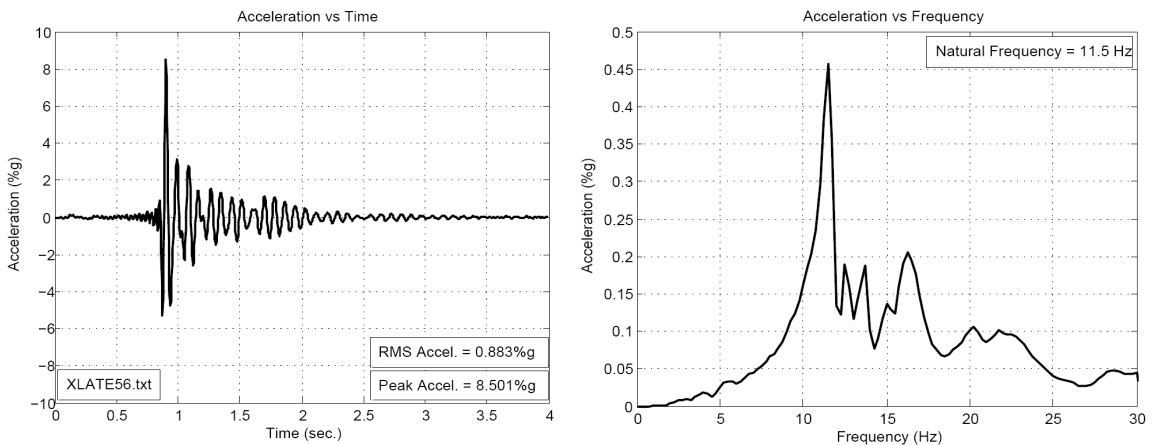

b) Heel-Drop

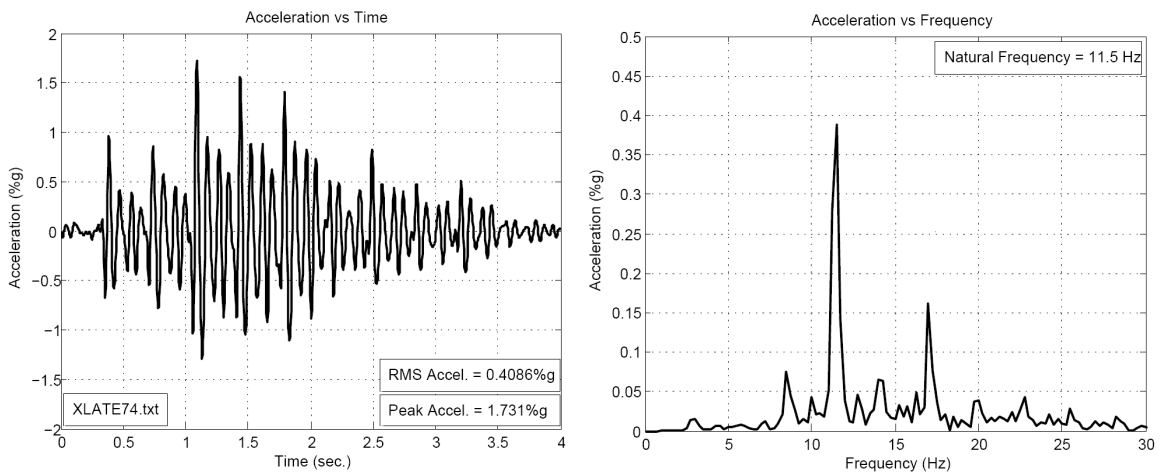

c) Walking at 172 bpm (2.87 Hz)

Figure 2.15 Tests Measurements for Bay 8, Seybold Flats

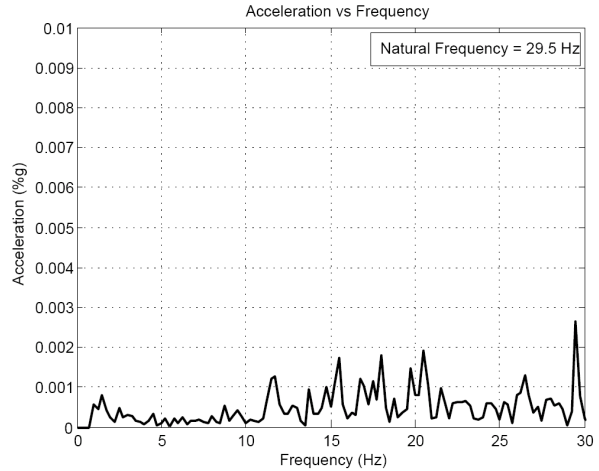
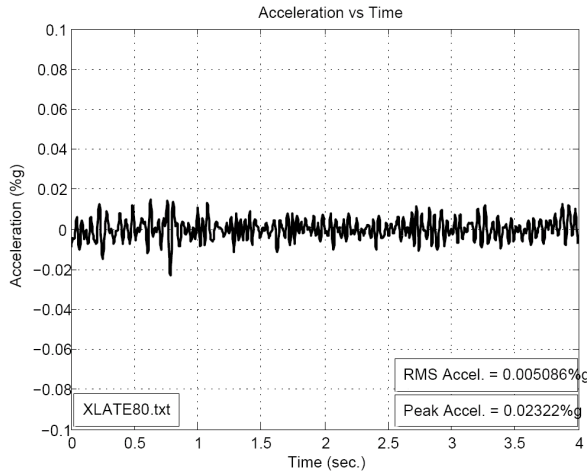

a) Ambient Vibrations

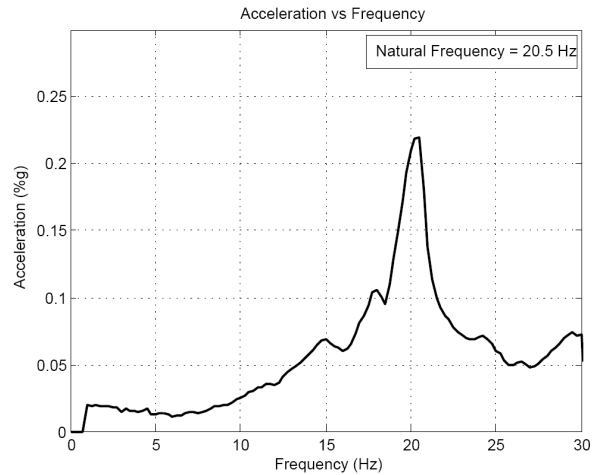
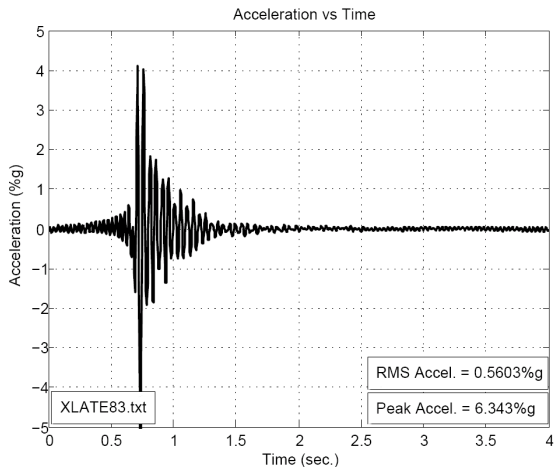

b) Heel-Drop

Figure 2.16 Test Measurements for Bay 9, Seybold Flats

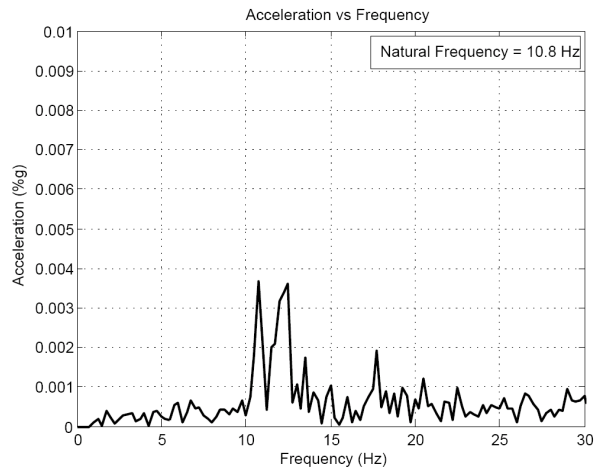
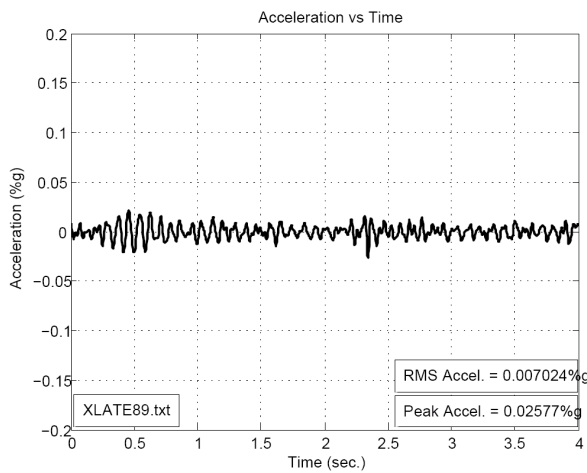

a) Ambient Motion

Figure 2.17 Test Measurements for Bay 10, Seybold Flats

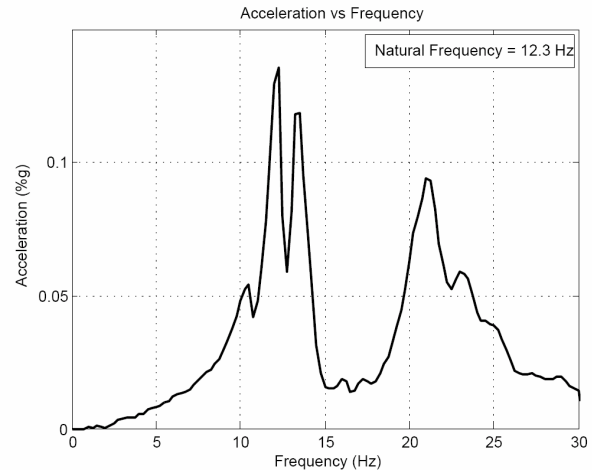
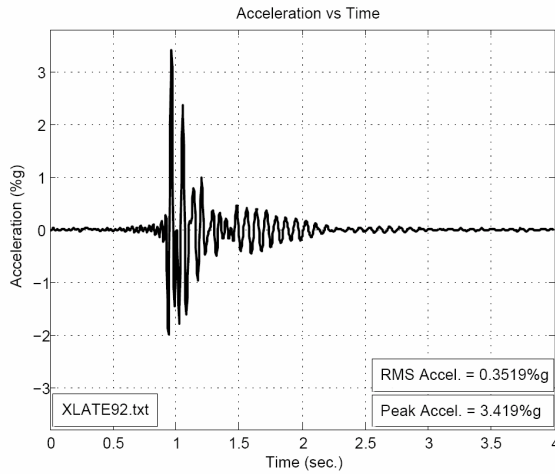

b) Heel-Drop

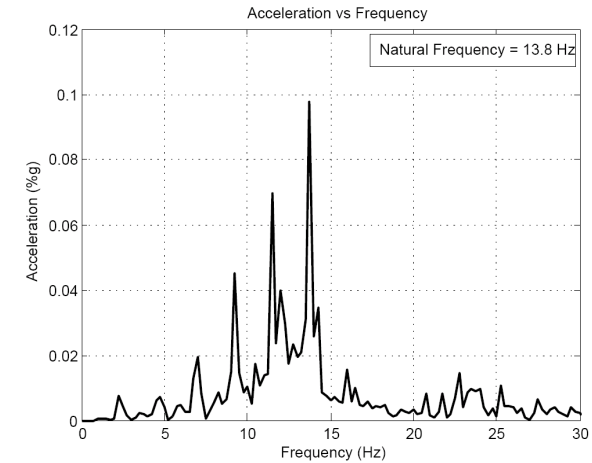
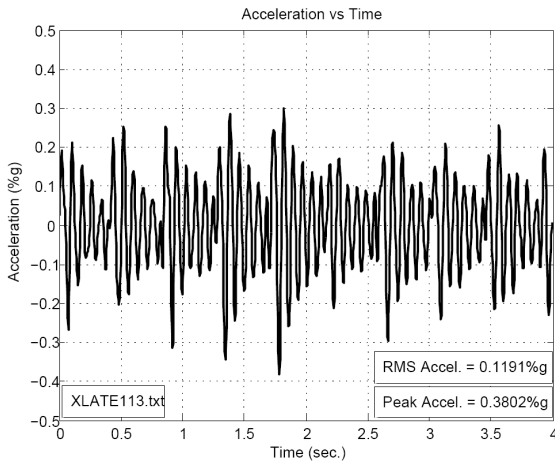

c) Walking at 140 bpm (2.33 Hz)

Figure 2.17 Test Measurements for Bay 10, Seybold Flats, Continued

2.3.6 Regency

Floor vibration tests were conducted in the Regency building, Sunset Beach, NC. One bay on the second level and two on the fifth level were selected for making measurements. Tests were done in the fifth level to see the effect of “clamping” of heavily loaded stud walls above. Bay 11 is located on the second floor. Bays 12 and 13 are located in the fifth floor. The floor dimensions, slab characteristics, and deck supports are the same for the three bays. The deck span is 19 ft 5 in. and the bay width is 19 ft 10 in. The slab thickness is 6.0 in., with 4.0 in. of normal weight concrete, $f'_c = 3.0$ ksi, over

2.0 in. deep deck. The steel deck used is Versa Dek XLS®, 22 gauge, 24.5 CW. The slabs are supported on steel stud walls.

Ambient vibrations were measured in the three bays. Measurements were also taken to capture the response of the floors due to heel drop, walking, and bouncing excitations. The walking and bouncing frequencies were selected to match the subharmonics of the floor natural frequencies, as an attempt to cause a resonant response. Tests were performed walking parallel and perpendicular to the deck span. In all cases, tests were done with the accelerometer placed in the center of the bays. Table 2.7 presents the results from 30 measurements taken in this building.

Table 2.7 Summary of Measurements. Regency

Floor	Bay	Excitation	Speed (bpm/Hz)	Dominant Frequencies (Hz)			Associated Accelerations (% of Gravity)		
Second	8-9/E-F (Bay 11)	Ambient		9.25	17.25	12.50			
		Ambient		12.75	58.25	64.25			
		Ambient		13.00	14.25	25.50			
		Heel-Drop		13.00	14.50	19.75			
		Heel-Drop		13.00	14.50	9.50			
		Walking Perpendicular	130/2.17	13.00	14.00	11.00	0.30	0.20	0.11
		Walking Perpendicular	130/2.17	13.00	25.00	11.00	0.21	0.20	0.10
		Walking Parallel	130/2.17	13.00	10.75	14.25	0.42	0.13	0.09
		Walking Parallel	130/2.17	12.50	13.00	13.75	0.21	0.21	0.15
		Walking Parallel	130/2.17	13.00	14.25	10.75	0.31	0.12	0.10
		Walking Parallel	130/2.17	12.75	14.00	92.00	0.30	0.16	0.15
		Walking Perpendicular	156/2.6	13.00	10.50	15.75	0.92	0.31	0.21
		Walking Perpendicular	156/2.6	13.25	10.50	14.25	0.74	0.31	0.24
		Walking Parallel	156/2.6	13.25	10.50	16.00	0.59	0.22	0.19
		Bouncing	130/2.17	4.25	12.25	2.25	0.11	0.10	0.08
Fifth	1-2/E-F (Bay 12)	Heel-Drop		10.50	13.75	9.75			
		Heel-Drop		10.50	9.75	14.00			
		Ambient		10.00	39.25	8.00			
		Walking Perpendicular	120/2.00	8.00	10.25	12.25	0.21	0.14	0.08
		Walking Perpendicular	120/2.00	8.00	10.50	18.25	0.21	0.11	0.10
		Walking Parallel	120/2.00	8.00	9.75	11.75	0.19	0.08	0.07
		Walking Parallel	120/2.00	8.00	9.75	11.75	0.16	0.11	0.10
		Bouncing	120/2.00	10.00	4.00	8.00	0.13	0.12	0.12
		Ambient		10.75	13.50	8.50			
	4-5/E-F (Bay 13)	Heel-Drop		10.75	12.75	14.50			
		Heel-Drop		10.75	12.75	14.50			
		Walking Perpendicular	129/2.15	10.75	8.50	12.75	0.24	0.10	0.10
		Walking Perpendicular	129/2.15	10.75	12.75	8.50	0.19	0.12	0.10
		Walking Parallel	129/2.15	11.00	8.75	13.00	0.24	0.15	0.11
		Walking Parallel	129/2.15	10.75	8.75	12.75	0.26	0.13	0.08

As shown in Table 2.7, the floor frequency for Bay 11 is 13.00 Hz. Tests in this bay were carried out with walking paces of 130 bpm and 156 bpm. These paces correspond to frequencies of 2.17 and 2.60 Hz, which are the sixth and the fifth subharmonics of the floor natural frequency, respectively. In Bay 12, the floor natural frequency is between 10.0 Hz and 10.5 Hz. Walking tests were conducted at 120 bpm, which corresponds to a frequency of 2.00 Hz. This frequency is approximately, the fifth

subharmonic of the floor natural frequency. The floor frequency in Bay 13 is 10.75 Hz. Walking tests were performed at 2.15 Hz, which is the fifth subharmonic of the floor frequency. Figures 2.18, 2.19, and 2.20 show the plots of the acceleration traces and frequency spectra for selected measurements. The complete set of plots for the 30 measurements taken in the building is presented in Appendix A.

Figure 2.18 presents the floor response due to ambient vibrations, heel-drop excitation, and walking perpendicular at the fifth subharmonic, 156 bpm (2.60 Hz), for Bay 11. As shown in the frequency spectrum for ambient vibrations, the floor frequency is about 12.8 Hz. The heel-drop excitation spectrum, however, shows that the floor frequency is 13.0 Hz. This spectrum also shows that only the fundamental mode of vibration is excited with the heel-drop. The damping ratio for this mode is 0.05. From the walking acceleration trace, it is determined that the peak acceleration response is 2.57 %g. It is also observed in this trace that the floor has the typical response of a high frequency floor. The acceleration reaches a peak due to the step impulse. Then, the floor vibrates five cycles before it reaches a new peak.

Figure 2.19 presents the acceleration response histories and spectra for Bay 12. The figure presents the plots for ambient vibrations, heel-drop excitations, and walking perpendicular at the fifth subharmonic, 120 bpm (2.00 Hz). From the ambient vibration and heel-drop excitation spectra, it is determined that the floor frequency is between 10.0 and 10.5 Hz. The acceleration trace for walking at 2.00 Hz shows that the floor peak acceleration is 0.78 %g. The acceleration trace for this excitation is very irregular, and there is not a defined pattern in the floor response, as was observed in the floors studied previously.

Figure 2.20 presents the plots of the acceleration traces for ambient vibrations, heel-drop excitation, and walking perpendicular at 129 bpm (2.15 Hz) for Bay 13. From the ambient vibration and heel-drop excitation spectra it is determined that the floor frequency is 10.8 Hz. The walking acceleration trace shows that the behavior of the floor resembles the case of a high frequency floor. The maximum acceleration experienced in the floor is 0.84 %g. In this trace, a new peak is attained in the floor response every five cycles of vibration, as a result of the impulse given to the floor with each step.

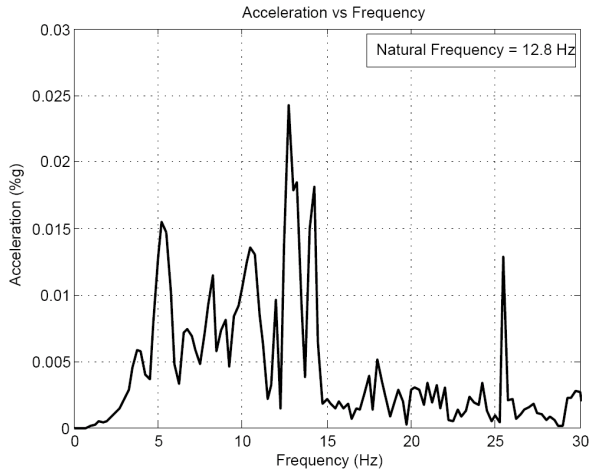
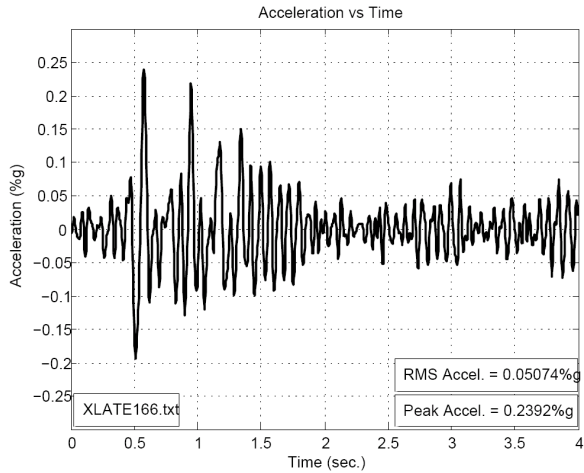

a) Ambient Vibrations

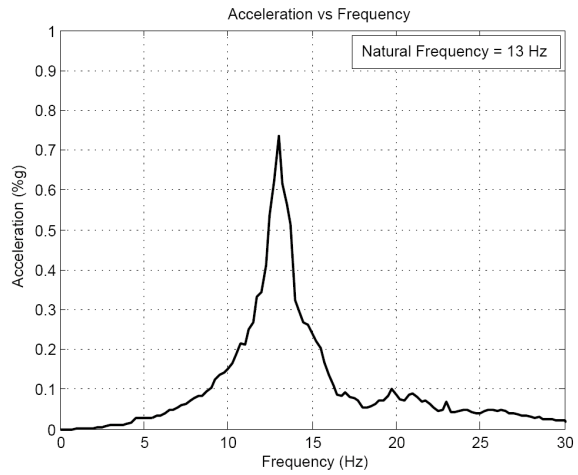
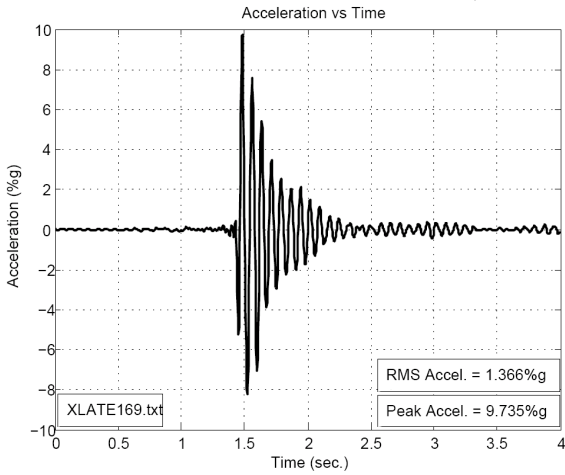

b) Heel-Drop

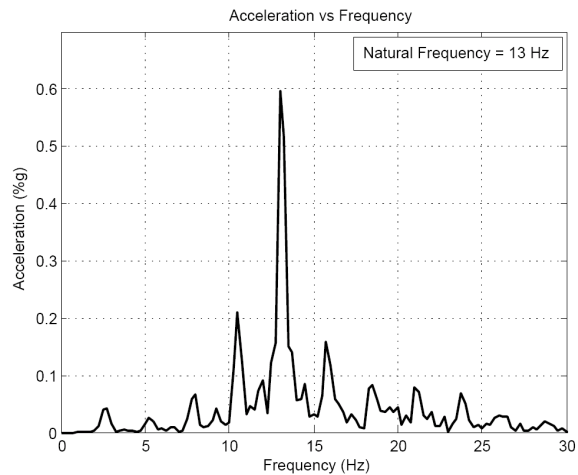
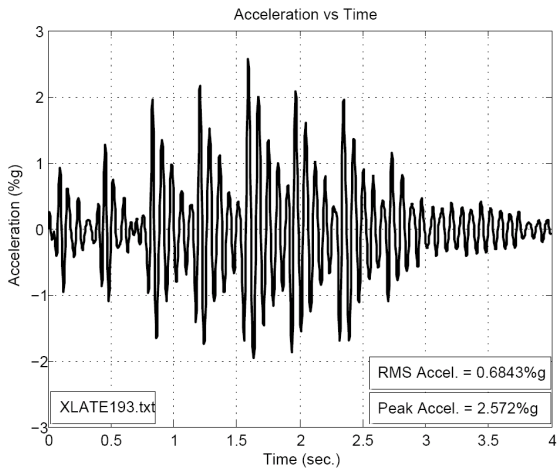

c) Walking Perpendicular at 156 bpm (2.60 Hz)

Figure 2.18 Test Measurements for Bay 11, Regency

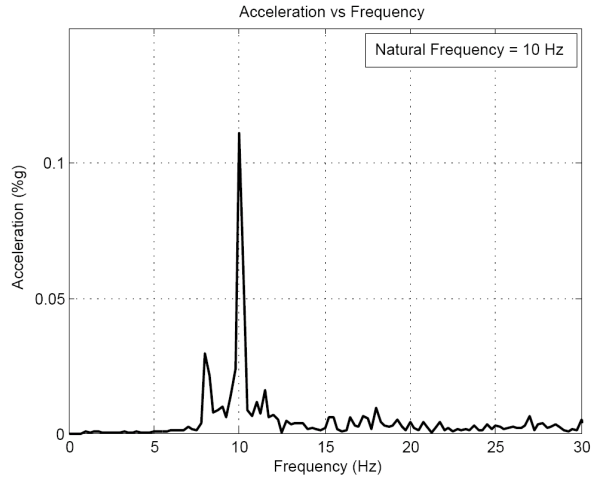
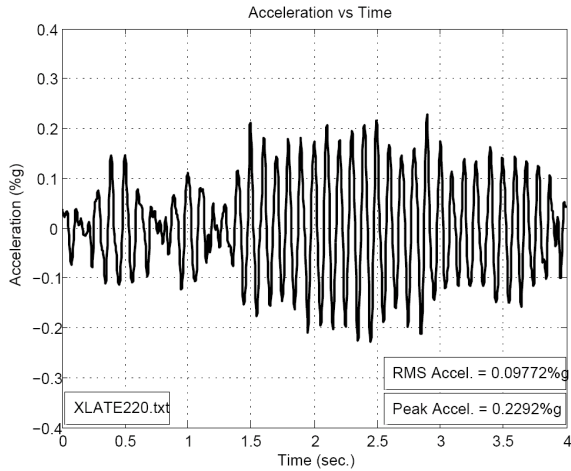

a) Ambient Vibrations

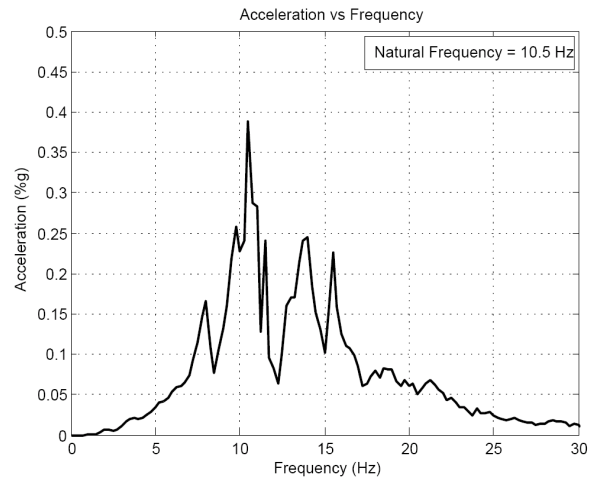
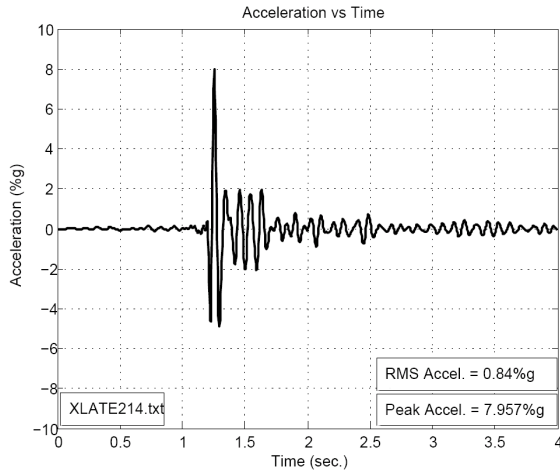

b) Heel-Drop Vibrations

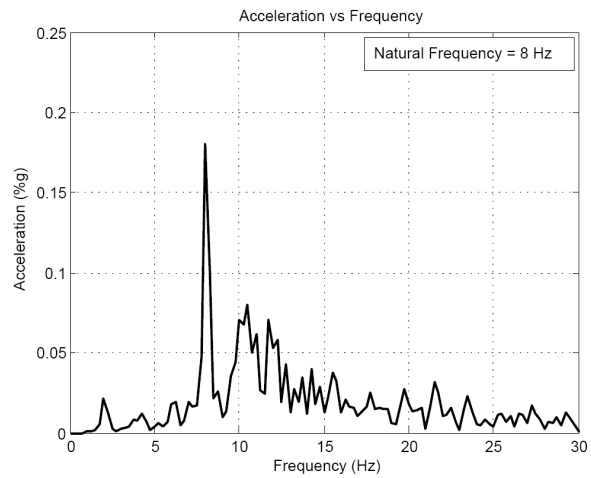
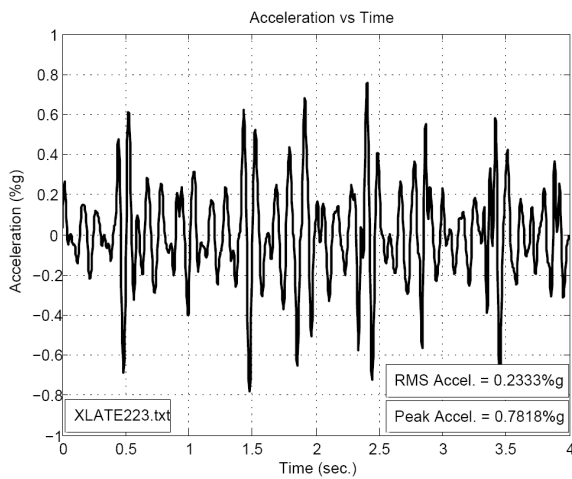

c) Walking Perpendicular at 120 bpm (2.00 Hz)

Figure 2.19 Test Measurements for Bay 12, Regency

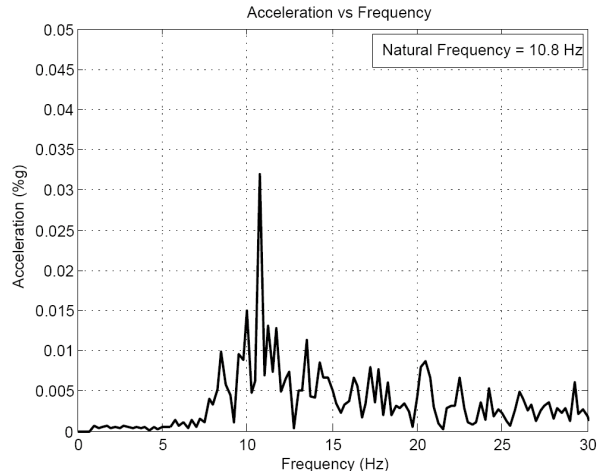
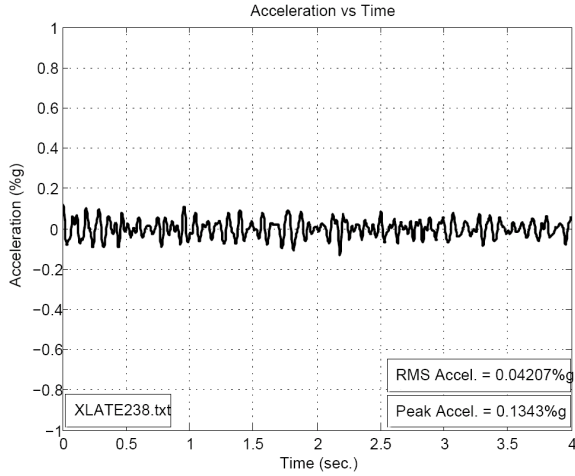

a) Ambient Vibrations

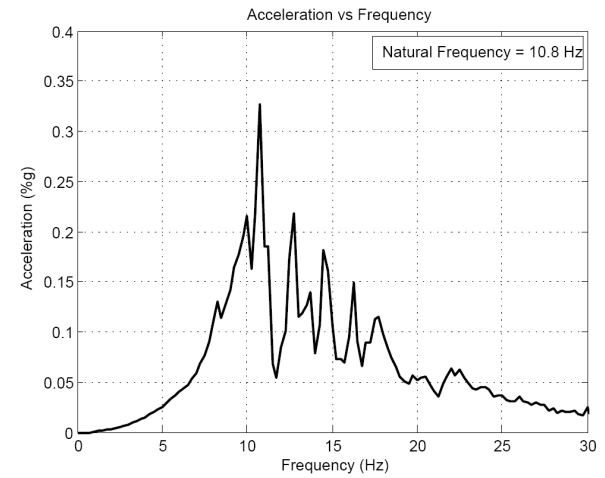
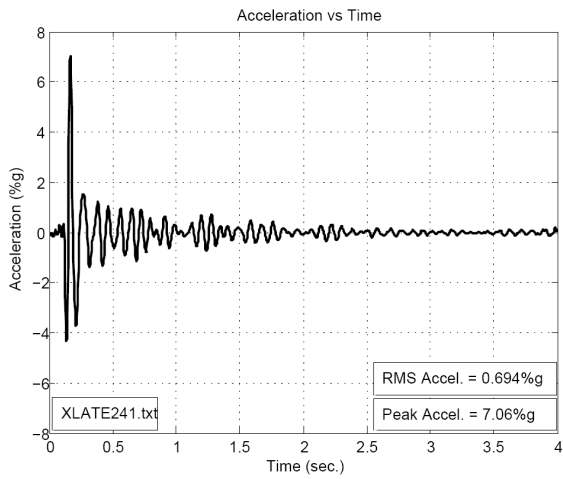

b) Heel-Drop

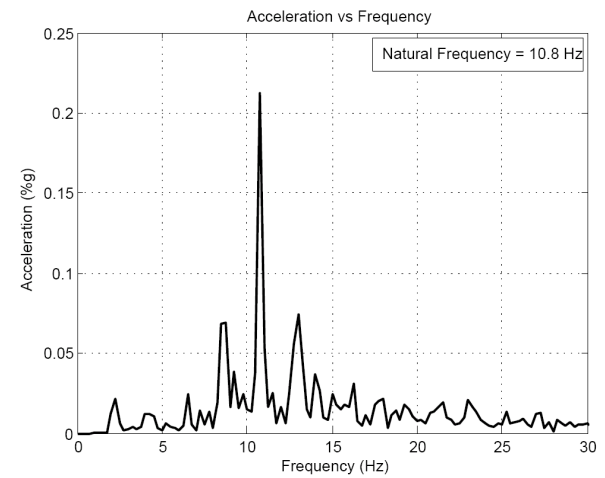
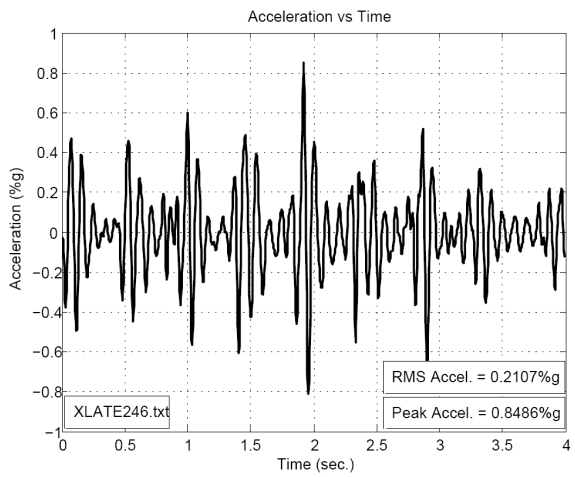

c) Walking Perpendicular at 129 bpm (2.15 Hz)

Figure 2.20 Test Measurements for Bay 13, Regency

2.4 SUMMARY OF RESULTS

Thirteen bays in seven buildings were tested to determine the vibration properties of long span deck floor systems. Floor frequencies and acceleration responses were obtained from the measurements taken in each bay. Table 2.8 summarizes the experimental results of the tests. For each bay, the table presents the floor dimensions, the dominant floor frequencies, the measured damping ratios, the response peak accelerations, the rms acceleration and the type of floor, based on its frequency level.

Table 2.8 Summary of Results for In-Situ Tests

Building/Mock-up	Bay Number	Dimensions	Floor Frequency (Hz)	Damping Ratio	Peak Acceleration (%g)	rms Acceleration (%g)	Floor type
Hampton Inn (Norfolk, VA)	1	20'-2 1/4"x22'-8 1/2"	13.30	0.038	1.41	0.37	High Frequency
	2	20'-2 1/4"x22'-8 1/2"	16.80	0.028	1.32	0.37	High Frequency
	3	26'-8"x14'-8 1/2"	26.00	***	***	***	High Frequency
Caribe Cove (Kissimmee, FL)	4	13'-9"x23'-6"	11.80	0.008	1.05	0.35	High Frequency
Concord and Cumberland (Charleston, SC)	5	30'-5 1/2"x21'-8 3/8"	13.50	0.030	0.60	0.23	High Frequency
Royal Reef (North Caicos, BWI)	6	32'-0"x23'-0"	14.50	0.017	0.84	0.31	High Frequency
	7	29'-4 5/8"x14'-0"	27.80	0.016	0.94	0.23	High Frequency
Seybold Flats (Tampa, FL)	8	17'-8"x22'-0"	11.50	***	1.73	0.41	High Frequency
	9	17'-8"x24'-8"	20.50	0.054	***	***	High Frequency
	10	29'-3"x16'-9"	13.50	***	0.38	0.12	High Frequency
Regency (Sunset Beach, NC)	11	19'-10"x19'-5"	13.00	0.050	2.57	0.68	High Frequency
	12	19'-10"x19'-5"	10.50	***	0.78	0.23	High Frequency
	13	19'-10"x19'-5"	10.75	***	0.84	0.21	High Frequency

The measurements show that the dominant frequency of the tested long span deck floors supported by CMU walls, steel stud walls, concrete beams, and masonry walls is more than 10 Hz. It is apparent that LSDFS are high frequency floors when supported by rigid walls.