

The role of abdominal pumping in tracheal tube compressions in the darkling beetle,  
*Zophobas morio*

Elan Dalton

Thesis submitted to the faculty of the Virginia Polytechnic Institute and State University  
in partial fulfillment of the requirements for the degree of

Master of Science  
In  
Biological Sciences

John J. Socha, Co-Chair  
Ignacio T. Moore, Co-Chair  
Daniel M. Dudek  
Douglas G. Pfeiffer

March 4<sup>th</sup>, 2013  
Blacksburg, VA

Keywords: beetle, abdominal pumping, tracheal tube collapse, integrative physiology

The role of abdominal pumping in tracheal tube compressions in the darkling beetle,  
*Zophobas morio*

Elan Dalton

ABSTRACT

Abdominal pumping is a widespread behavior in insects. However, there remains ambiguity surrounding the abdominal pumping behavior, both in terms of describing what exactly abdominal pumping is (i.e., if various modes of operation exist) and also what function(s) abdominal pumping serves (and if function is conserved across groups of insects). In some insects respiratory patterns have been correlated with abdominal movements, although the specific mechanical effects of these movements on the animal's respiratory system are generally unknown. Conversely, some insects (such as beetles, ants, and crickets) create convection in the respiratory system by compressing their tracheal tubes, yet the underlying physiological mechanisms of tracheal collapse are also unknown. This study aimed to investigate the relationship between abdominal pumping and the compression of tracheal tubes in the darkling beetle, *Zophobas morio*. I observed the movements of the abdomen and tracheal tubes using synchrotron x-ray imaging and video cameras, while concurrently monitoring CO<sub>2</sub> expiration. I identified and characterized two distinct abdominal movements differentiated by the synchrony (the pinch movement) or lack of synchrony (the wave movement) of abdominal tergite movement. Tracheal tube compressions (and corresponding CO<sub>2</sub> pulses) occurred concurrently with every pinch movement. This study provides evidence of a mechanistic linkage between abdominal movements and tracheal tube compressions in the ground beetle, *Zophobas morio*.

## Acknowledgements

I would like to thank my lab-mate Hodjat. This project would not have been completed without his encouragement, advice, and direct support. He is as brilliant and as kind as they come, and I am indeed fortunate to call him rafigh.

Table of Contents	Page
Chapter 1: Introduction	1
Chapter 2: Literature Review	4
Chapter 3: Manuscript: The role of abdominal pumping in tracheal tube compressions in the darkling beetle, <i>Zophobas morio</i>	13
Chapter 4: Conclusions	50
References	53
Appendix A: The initial experimental design, with additional detail on methodology	55

## List of Figures

### Chapter 2:

	Page
Figure 1: Each triangle represents the coordination between circulation, abdominal movements, and respiration in the pupae of an individual species	6

### Chapter 3:

Figure 1: Experimental setup used to simultaneously record abdominal movements, tracheal tube compressions, and CO <sub>2</sub> emission of the tenebrionid beetle, <i>Zophobas morio</i>	21
---	----

Figure 2: The custom Matlab interface used to simultaneously playback all data sources.	27
---	----

Figure 3: Tracing of the abdominal surface from a representative beetle during a pinch movement (top) and wave movement (bottom).	30
---	----

Figure 4: Schematic diagram of the pinch and wave movements, depicting the relative timing of tergite compression.	30
--	----

Figure 5: Temporal relationship between three successive tracheal compressions, abdominal pinches, and CO <sub>2</sub> pulses in a representative darkling beetle.	33
--	----

Figure 6: Timing characteristics of abdominal pinch movements and the corresponding tracheal tube collapse.	35
---	----

Appendix A: Supplementary Figure 1: Raw data from picospritzer trials using the Kapton chamber used to calculate the timing offset required to synchronize the CO <sub>2</sub> data with the video data.	46
--	----

### Appendix B: Supplementary Videos 1 & 2:

Supplementary Video 1: Abdominal pinching movement in an unconstrained beetle.	47
--	----

Supplementary Video 2: Abdominal pinching movement in a constrained beetle (prior to x-ray irradiation).	
--	--

Appendix C: Supplementary Figure 2: Attributing the occurrence of an event as a discrete action specific to a single video frame represents a degree of uncertainty in the analysis of video data.	48
--	----

Appendix D: Supplementary Video 3: Concurrent imaging of abdominal wave movement (top panel) with tracheal tubes in the abdomen (lower panel).	49
--	----

## List of Tables

Chapter 3:	Page
Table 1: Description of markers used to define events for each behavior analyzed.	27
Table 2: Parameters of the two characteristic abdominal movements, sub-sampled from two specimens during x-ray imaging.	31
Table 3: Summary of tracheal collapse and abdominal movement event characteristics.	36

## Chapter 1: Introduction

Abdominal pumping is a well-documented behavior exhibited in a range of insect taxa that consists of motion of the abdominal segments that typically decreases the internal volume of the abdomen. Generally, abdominal pumping is considered to be a ventilatory behavior, owing to the studies on a variety of flying insects that note the correlated increase in frequency of abdominal pumping during periods of increased metabolic rate (e.g. during and post flight) (Harrison, 1997; Weis-Fogh, 1967). However, there have been only a few studies that focus on the abdominal pumping of epigeic species. These few studies have focused mainly on larval or pupal forms, and suggest a potential circulatory function of abdominal pumping (Ichikawa, 2008; Sláma, 1999; Wasserthal, 2012). However, these studies demonstrate the difficulty in determining the effective role of abdominal pumping on the insect's respiratory and circulatory systems, respectively (Tartes et al., 2002). Furthermore, although the insect abdomen is understood to behave and move in a variety of manners across a variety of species, it is poorly characterized anatomically in even a single species, and the classification of an "abdominal pump" is difficult to make. Nonetheless this has not prevented the widespread use of the term "abdominal pump" as a general description of abdominal movements across multiple insect taxa. These factors leave the body of research focusing on the role of abdominal movements in controlling/actuating aspects of insect physiology in need of more detailed work.

Arguably one of the most peculiar aspects of the insect respiratory system, is the phenomenon of tracheal tube compression. Although identified as early as 75 years ago (Herford, 1938), tracheal compressions have only recently begun to be documented and studied in detail across a variety of insects and with respect to insect metabolism/physiology (Westneat et al., 2003). As a means of generating convection within the tracheal system and thus augmenting the

role of gas exchange in insect metabolism, tracheal compressions have begun to garner recent attention within a range of contexts: phylogenetics (Westneat et al., 2007), convective respiration (Socha et al., 2008; Westneat et al., 2003), ecology, and evolution (Westneat et al., 2007). Although the underlying mechanisms that are responsible for causing tracheal compression is unknown, two main hypotheses have been presented. One is a pressure mechanism by which the insect creates a pressure gradient across the tracheal tube wall (taenidia) either by increasing the relative pressure of the internal body compartments (i.e. hemolymph), by decreasing the pressure within the lumen of the trachea, or both. The other hypothesis is a mechanical deformation mechanism that requires a direct impingement of the tracheal wall by surrounding tissues, muscles, and/or organs. The trachea are not muscularized, as known from histological study (Schmitz and Perry, 1999). Although neither mechanism(s) nor the function of tracheal compression are well understood, the fact that compression behavior is conserved across a wide range of insect taxa (e.g. Odonata, Hymenoptera, Coleoptera, Blattaria), responds within individual organisms to differing metabolic/physiologic states, and appears to have direct and immediate respiratory function all suggest it to be an important, if not critical, aspect of insect behavior/physiology.

This project explored the relationship between abdominal movements and tracheal tube compressions in the darkling beetle, *Zophobas morio*. In turn, this helped to more accurately characterize the “abdominal pump”. The goal was to answer the question: *what is the relationship between abdominal movements and tracheal tube collapse?* It was hypothesized that, in *Zophobas morio*, abdominal pumping facilitates external gas exchange by inducing compression in the tracheal system, thereby creating bulk flow of air. Methods of external (high-definition light video recordings of abdominal movements) and internal (synchrotron x-ray phase contrast



imaging) imaging, as well as measuring respiratory behavior (CO<sub>2</sub> output) of living darkling beetles was documented.

## Chapter 2: Literature Review

### Pupal studies:

A study examining correlations between abdominal movements, heartbeat direction, and CO<sub>2</sub> release, (Tartes et al., 2002) reported no evidence of correlation between abdominal movements and measured respiration despite a clear pattern of cyclic CO<sub>2</sub> output. In diapausing *Pieris brassicae* pupae the abdominal movements (measured using an IR sensor aimed at the tip of the abdomen) were side-to-side “swinging” motions that occur as isolated events with irregular activity. Furthermore, the release of CO<sub>2</sub> occurred in the absence of abdominal movements and the authors were explicit about their contention that abdominal bending was not ventilatory and that the cyclic gas-exchange was independent of periods of abdominal pulsations (Tartes et al., 2002). In a detailed analysis of body movements and respiratory patterns, Tartes and Kussik found in *Tenebrio molitor* pupae no immediate effect of “muscular activity” on CO<sub>2</sub> output, but that the length of periods between bouts of muscular activity (between 19 – 40 min) was strongly correlated to metabolic rate (Tartes and Kuusik, 1994). Muscular activity was described as a combination of abdominal dorsal-ventral flexion and extension and compression/extension of the body that increases in duration from early to late pupal development. This finding suggests that while the abdominal movements of *T. molitor* may not directly or immediately affect the respiratory behavior of the pupae, they are likely implicated in maintaining homeostasis on longer time-scales (hours), such as regulating pH balance of the hemolymph as CO<sub>2</sub> is cumulatively built up in the process of bicarbonate buffering. It should be noted that the high degree of modification to the abdominal movements in *T. molitor* pupae as they develop suggests the variable nature of abdominal movements. Also it should not be disregarded that the abdominal movements may play a different role on aspects of adult physiology (a life-stage

whereby the animal has drastically different behavior and requirements), perhaps even more directly on respiratory behavior.

It would appear there exist multiple modes of coordination between respiration, abdominal movements, and heartbeat across a variety of pupal species. Tartes and colleagues have reported different degrees of coordination between these three systems in pupae of four different species, with no two species sharing the same relationship between these three systems (Tartes et al., 2002). Specifically, in *Pieris brassicae* pupae the cessation of anterior-directed heartbeat activity coincided with the onset of a CO<sub>2</sub> burst (lasting 2-5 minutes) which was sometimes additionally accompanied by a period of posterior-directed heartbeat activity that would continue until the CO<sub>2</sub> burst (Tartes et al., 2002). In *Tenebrio molitor*, the authors described periods of “muscular movements” (abdominal movements) to be coincident with heartbeat activity, but as previously stated, not with respiratory behavior, therefore suggesting that heartbeat and abdominal movements are functionally coupled and independent of respiration (Tartes and Kuusik, 1994). In *Galleria mellonella* pupae there appears to be coordination between both rotational and bending abdominal movements and heartbeat, as well as rotational (but not bending) abdominal movements and CO<sub>2</sub> release, but not between heart activity and respiratory behavior (Tartes et al., 1999). Pupae of the fourth species, *Leptinotarsa decemlineata*, exhibited coordination between circulation, abdominal movements, and respiration; large bursts in CO<sub>2</sub> occurred in 20-65 minute intervals and were accompanied by a period of abdominal pumping, lasting 5-6 times longer than the CO<sub>2</sub> burst, as well as heartbeat. The heartbeat also occurred independently from the other two phenomenon (Tartes et al., 2000). In *L. decemlineata* pupae, the synchrony among respiratory, abdominal movement, and heartbeat behavior (17 out of 20 specimens studied) suggest there is a functional connection between these processes. The variety

of behaviors demonstrated by these species reveals the possibility that there are multiple means of meeting respiratory and circulatory demands and that the behavioral mechanisms of maintaining proper development may change and fluctuate between the multiple systems of control (heart, abdominal movements, spiracular opening). These collective findings serve as a cautionary tale to one who may look to find answers for physiological control mechanisms broadly applied to insects or groups of insects, but in turn may also serve to elucidate the importance of discovering commonalities among methods of control for multiple species.

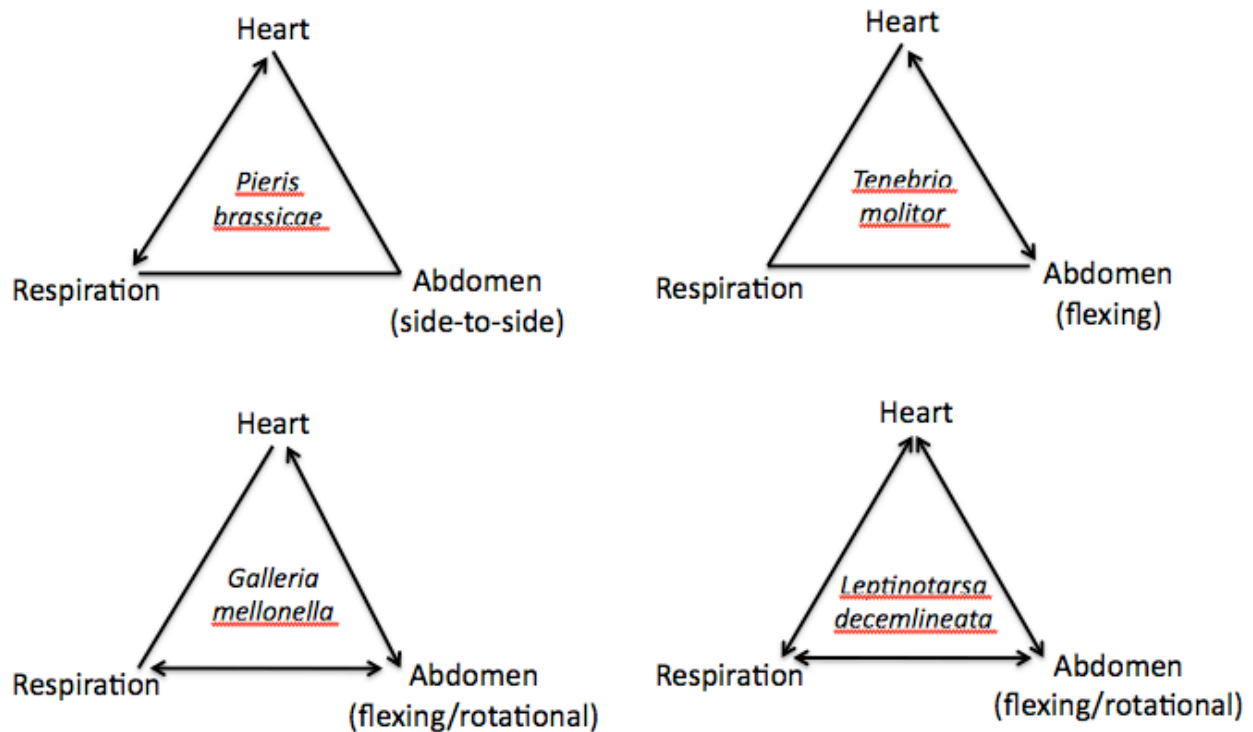

Figure 1: Each triangle represents the coordination between circulation, abdominal movements, and respiration in the pupae of an individual species. The arrows indicate coordination between the respective systems. Abdomen clarifiers represent the type(s) of abdominal movements observed by each type of pupae. Modified from Tartes et al. (2002), Fig. 6.

### Adult Insects:

A much smaller body of literature focuses on the abdominal and respiratory physiology of adult insects compared to pupae, owing in most part to the relative simplicity, ease of access (both to spiracles and to internal processes that are visible through the more transparent cuticle), and immobility of pupae. Despite the relative paucity of adult work, however, developing a more complete understanding of adult physiology is relevant for evolutionary, ecological, and behavioral contexts of the behaviors of interest.

### *Characteristics of abdominal pumping in adults*

In multiple species of adult grasshoppers, it is known that abdominal pumping behavior increases during and after states of heightened metabolic activity (hopping or flying) and coordinated with thoracic ventilatory patterns (Harrison, 1997; Weis-Fogh, 1967). This increase in abdominal pumping appears to fall within the middle of the modulatory capabilities spectrum for insects; dragonflies do not use abdominal movements to fulfill increased demand during flight (instead relying on thoracic ventilatory mechanisms that result from expansion/contraction of flight muscles) whereas wasps and bees rely exclusively on abdominal pumping to fulfill the increased respiratory demands. Furthermore, exposing resting grasshoppers to hypercapnia (5% CO<sub>2</sub>) increases the frequency and magnitude of abdominal pumping movements beyond physiologically normal levels (Weis-Fogh, 1967).

In the ground (desert) dwelling tenebrionid beetle, *Eleodes obscura* (presently, the most closely related beetle to be studied relative to the species used in the current study), two distinct types of abdominal movements were described, disregarding the movement of abdominal tergites caused by heartbeats (Schilman et al., 2008). One movement was characterized by a lifting and

subsequent squeezing of the abdominal tergites relative to a resting position, with each bout lasting 15-20 seconds and occurring about every minute. These so-called “bowel movements” (named for their hypothesized origin as movements of the digestive tract within the abdomen) occurred regularly and were not correlated with CO<sub>2</sub> bursts. The second movement, termed “abdominal paroxysms”, were characterized by an initial depression of the abdominal tergites followed by consecutive rapid movements. Unlike the bowel movements, the abdominal paroxysms resulted in pronounced external pressure changes (the initial depression caused a large decrease in subelytral cavity pressure) and resulted in correlated CO<sub>2</sub> release. Despite these findings, the authors suggest that the irregularly occurring abdominal paroxysms were triggered by some respiratory homeostatic requirement and were not identifiable as a ventilatory movement *per se*. This study serves to demonstrate the complexity of movements a darkling beetle abdomen is capable of making, and perhaps more importantly, reveals that these movements have a variable degree of physiological relevance depending on the system in question. It should also be noted that the flow rate, and thus the temporal resolution, of the respirometry system used in these experiments was rather low (100 mL/min), which likely caused any immediate effects of abdominal movements on high frequency respiratory patterns (CO<sub>2</sub> output) to be lost within an “averaged” signal.

The “averaged” signal phenomenon is directly addressed in a paper that thoroughly explained the behavior of CO<sub>2</sub> in a flow-through respirometry system as CO<sub>2</sub> leaves an animal and travels to an analyzer (Gray and Bradley, 2006). The issue with low flow rates (or large animal chambers) is that there is a time constant inherent in any flow-through chamber setup resulting from the finite duration it takes a given CO<sub>2</sub> burst to exit the chamber, travel through the tubing, and be detected by the analyzer. This value is simply calculated as the volume of the

chamber divided by the flow rate through the chamber; however, the implications of this time constant on data analysis can be profound. If the time constant is relatively long relative to the phenomenon under examination, then it is impossible to determine the reality of the respiratory pattern despite the best of efforts since any actual event will be blended with subsequent events as the CO<sub>2</sub> from the latter mixes before the former is completely cleared from the chamber. This is potentially a critical oversight for respirometry researchers, but can easily be compensated for by increasing flow rates and/or reducing chamber volumes. There is a similar aspect to most CO<sub>2</sub>-detecting flow-through respirometry systems, due to the nature of CO<sub>2</sub> analyzers, which can be equally misleading and is again caused by low flow rates. In essence, infrared CO<sub>2</sub> analyzers measure the differential absorption of IR light by CO<sub>2</sub> molecules along the entire length of an internal sampling tube. The instantaneous output at any given time is actually the averaged signal along the length of this detection chamber, and similar to the time constant effects of the animal chamber, if the flow rate is too low, a blending of CO<sub>2</sub> signals from independent respiratory events will manifest as a single signal (Gray and Bradley, 2006). Taking from these findings of the previous two studies, high frequency sampling methods will be utilized in the current study to ensure capture of any rapidly occurring changes in the CO<sub>2</sub> profiles of the insects.

In an examination of the abdominal movements of resting blow flies (*Calliphora vicina*), (Wasserthal, 2012) identified patterns of abdominal movements that coincided with changes in heartbeat activity. By using an innovative method to measure intratracheal pressure concurrently with hemolymph pressures, he was able to provide one of the most comprehensive descriptions of the insect as an integrated physiological system to date. He demonstrated the high degree of coordination between the abdominal pumping movements and heartbeat by showing the linkage

of pressure pulses between abdomen and thorax. He determined that heartbeat reversal is coincident with abdominal contractions/relaxations (backward heartbeat coincides with abdominal expansion and forward beating with contraction) and, furthermore, he was able to show that intratracheal pressure followed the pattern created by hemolymph pressurization, which correlated with abdominal pumping strokes (Wasserthal, 2012).

Bailey studied the pathway of airflow around honeybees with attention to the abdominal pumping behavior and found synchrony between spiracular opening/closing and abdominal movements (Bailey, 1954). Using a rubber diaphragm to divide the head and thorax from the abdomen, and using water beads within capillaries exiting the anterior and posterior chamber sections, it was observed that when the abdomen contracted the volume in the posterior chamber section decreased and that this volume was displaced into the anterior chamber section. This same volume displacement occurred in the opposite direction while the abdomen expanded (i.e. “completed” a single abdominal pumping movement). Collectively, these findings led Bailey to conclude that tidal airflow normally occurs through thoracic spiracles, and is caused by abdominal pumping. Not only do Bailey’s results elucidate the respiratory function of the bee’s abdominal pumping behavior, but they also suggest the complex regulatory abilities that can be achieved by the insect utilizing coordinated abdominal movements with spiracular activity. In fact, when adding a CO<sub>2</sub> airstream to the experiment, the honeybee altered its normal breathing (the tidal airflow through thoracic spiracles caused by abdominal pumping) to adopt a unidirectional flow entering the thoracic spiracles and exiting the abdominal spiracles, suggesting modulatory capability to respond to physiological production of CO<sub>2</sub> (i.e. increase ventilation through active flight muscles producing high levels of CO<sub>2</sub>). Additionally, a study by another group has shown the thoracic spiracles to be the primary location of gas exchange with the external environment,



and while not examined in detail, also noted the likelihood of abdominal pumping movements to facilitate tidal airflow through the tracheal system (Duncan and Byrne, 2002).

Pressure changes and oxygen consumption were measured with respect to abdominal movements in constrained adult locusts (*Locuta migratoria*) using a closed chamber system, revealing two distinct modes of breathing patterns associated with respective abdominal movements (Arieli and Lehrer, 1988). Abdominal movements were observed by eye and exhibited two characteristic patterns that correlated to two types of pressure changes; longitudinal telescoping abdominal movements corresponding to high-amplitude changes in pressure, and dorsal-ventral abdominal pumping that corresponded to low-amplitude pressure changes. Furthermore, as oxygen was consumed over time causing the partial pressure within the chamber to decrease, the frequency of both movements changed from sporadic to regular and more frequent movements (after about 90 minutes with  $P_{O_2}=6.4$  kPa), then to only low-amplitude dorsal-ventral movements occurring but with greater amplitude and frequency (after about 120 minutes with  $P_{O_2}=4.4-2.9$  kPa), and finally to cessation of all ventilatory (abdominal) movements (after about 170 minutes with  $P_{O_2}=2.8$  kPa). Additionally, peaks in oxygen consumption occurred during bursts in frequency of dorsal-ventral abdominal movements.

Another study that monitored the movement of the abdomen with respect to oxygen partial pressures again found coordination between lowered  $P_{O_2}$  and movement of the abdomen, during discontinuous gas exchange cycles of *Attacus atlas* pupae (Hetz and Bradley, 2005). As  $P_{O_2}$  decreased due to consumption (from 20.4 kPa to 4-5 kPa), the animal's abdomen contracted to shorten its length, which also coincided with the similar linear decrease in intratracheal pressure. The authors attributed the change in abdominal length to the decreased intratracheal pressure, but did not elaborate further nor describe differences in abdominal behavior during different periods

in the respiratory cycle. It is possible that the pupae were also modifying their abdominal movements in a manner similar to Arieli and Lehrer's grasshoppers, but such details were not provided.

### Chapter 3: Manuscript

Title:

The role of abdominal pumping in tracheal tube compressions in the darkling beetle, *Zophobas morio*

Abstract:

Abdominal pumping is a widespread behavior in insects, with multiple proposed physiological roles that include respiration and circulation. However, there remains ambiguity surrounding abdominal pumping behavior in terms of describing what exactly abdominal pumping is, if various modes of operation exist, what the functional outcomes of abdominal pumping behavior are, and if the function is conserved across groups of insects. In some insects, respiratory patterns have been correlated with abdominal movements, although the specific mechanical effects of these movements on the animal's respiratory system are generally unknown. Conversely, some insects (such as beetles, ants, and crickets) create convection in the respiratory system by compressing the tracheal tubes, yet the underlying physiological mechanisms of tracheal collapse are also unknown. This study aimed to investigate the relationship between abdominal pumping and the compression of tracheal tubes in the tenebrionid beetle, *Zophobas morio*. We observed the movements of the abdomen and tracheal tubes using synchrotron x-ray imaging and video cameras, while concurrently monitoring CO<sub>2</sub> expiration. We identified and characterized two distinct abdominal movements differentiated by the synchrony (the pinch movement) or lack of synchrony (the wave movement) of abdominal tergite movement. Tracheal tube compressions (and corresponding CO<sub>2</sub> pulses) concurrently occurred with every pinch movement. This study provides the first evidence of a mechanistic linkage between abdominal movements and tracheal tube compressions in the ground beetle,

*Zophobas morio*, serving to help define the role of abdominal movements in insect physiology.

### Introduction:

A remarkable aspect of insect physiology is the ability to effectively transport both liquids and gases throughout the body simultaneously with remarkable distinction in structural design. The open-system approach of the circulatory system maintains liquid (hemolymph) transport, while the tracheal system represents discrete and precise delivery of respiratory gases through a vast network of micron and nanometer-sized tracheal tubes directly to individual cells. These systems are responsive to changes in environmental conditions (Chappell and Rogowitz, 2000; Lighton and Lovegrove, 1990), physiological state (Harrison, 1997; Kaiser et al., 2007; Weis-Fogh, 1967), and development stage (Ichikawa, 2008), representing an incredible degree of sophistication when considered as autonomous microfluidic systems. Of particular interest is the control of these physiological systems, as insights into coordination and actuation may offer inspiration to the design of engineered microfluidic devices.

While the circulatory and respiratory systems of insects both employ independent methods of actuation (heart/dorsal vessel and spiracles, respectively), it is abdominal pumping behavior that is interesting as a multifunctional control mechanism since it can potentially influence both systems (Sibul et al., 2004; Wasserthal, 1996; Wasserthal, 2012). In most cases, abdominal pumping is considered a respiratory behavior because it is responsive to changes in metabolic activity, such as during flight (Harrison, 1997; Weis-Fogh, 1967); fluctuating levels of oxygen and carbon dioxide concentration (Arieli and Lehrer, 1988; Gulinson and Harrison, 1996; Miller, 1960); and is coordinated with spiracular activity (Bailey, 1954; Duncan and Byrne, 2002; Sláma, 1988). However, abdominal pumping has also been identified to have a primarily

circulatory function (Ichikawa, 2008; Sláma, 1999; Wasserthal, 2012). A few studies have demonstrated varying degrees of coordination between abdominal pumping and respiration (CO<sub>2</sub> release and/or spiracular control; (Arieli and Lehrer, 1988; Bailey, 1954; Schilman et al., 2008), while others (Bailey, 1954) show patterns of abdominal pumping and circulation (heart beating), although no unequivocal relationships stand out from the findings (Tartes et al., 2000; Tartes et al., 1999; Wasserthal, 1996; Wasserthal, 2012). Arieli and Lehrer (Arieli and Lehrer, 1988) documented the changes in amplitude and frequency of grasshopper (*Locusta migratoria*) abdominal movements in response to changing oxygen concentrations, Bailey (Bailey, 1954) described brief and rapid abdominal pumping (telescoping movements) in synchrony with spiracular opening and closing that created tidal airflow within honey bees, and Schilman and colleagues (Schilman et al., 2008) documented both the presence or absence of coordinated CO<sub>2</sub> release from a darkling beetle (*Elodeos obscura*), depending on the type of abdominal movement (described in detail below). There appears to be no consistent, stereotypical function of abdominal pumping behavior across species. Thus it remains to be understood if the variety of abdominal behaviors exhibited across species are indeed functionally distinct, or rather a product of the difficulty inherent in describing a highly complex and modifiable behavior.

Some of the difficulty in assessing any common patterns of coordinated circulatory and respiratory behavior across insects must be attributed to the poor documentation of what exactly abdominal pumping is. The abdomen is capable of moving and behaving in a range of manners within even a single organism (Arieli and Lehrer, 1988; Schilman et al., 2008; Tartes and Kuusik, 1994; Tartes et al., 1999; Tartes et al., 2002). Abdominal movements can range from irregularly occurring side-to-side swinging of the entire abdomen in pupae (Tartes et al., 2002), to dorsal-ventral flexion and extension gradually transitioning to compression/extension of the entire

abdomen during pupal development (Tartes and Kuusik, 1994). Rotational and bending movements of the abdomen have also been identified in pupae (Tartes et al., 1999). In adult grasshoppers, abdominal pumping can refer to the dorsal compression of the abdominal sternites (Harrison, 1997), as well as the telescoping movement of abdominal segments upon one another (Arieli and Lehrer, 1988). Schilman and colleagues (2008) have provided one of the few detailed examinations of abdominal movements, differentiating “bowel movements” as the lifting and subsequent squeezing of the abdomen from “abdominal paroxysms,” which occurred as initial depression followed by rapid movement of the abdominal tergites. With rare exception, throughout the literature the term “abdominal pump” is applied broadly to any movement of the abdomen, despite the variation in movement types and resulting functions. Because abdominal behaviors appear to be highly variable within and across species, there is need to characterize abdominal movements in detail for mechanistic and/or comparative studies.

An interesting aspect of respiratory physiology in insects that occurs with similar frequency to some abdominal pumping behaviors is tracheal tube collapse. The prevalence of tracheal tube collapse across a range of insect taxa suggests an important physiological role. The behavior appears to function as convective augmentation to passive diffusion of respiratory gases between the animal and its environment and/or within the animal itself (Greenlee et al., 2013; Socha et al., 2008; Waters et al., 2013). The mechanisms of tracheal tube collapse, however, are not well understood. One proposed mechanism, relevant to this thesis, suggests a pressure-mediated collapse whereby the hemocoel of the insect is somehow pressurized and the resulting pressure gradient across tracheal tube walls causes the tubes to compress. Since internal pressure fluctuations have been attributed to abdominal movements (Arieli and Lehrer, 1988; Schilman et

al., 2008; Sláma, 1988; Wasserthal, 2012), it would follow that abdominal pumping behavior is potentially an actuating mechanism for tracheal tube collapse.

The purpose of the current study was to examine the behavior of the insect abdomen as a potential mechanism of tracheal compression, while also characterizing the abdominal movements in detail. We sought to answer two questions: 1) What is the relationship between abdominal movements and tracheal tube compression? and 2) Are there multiple modes of abdominal movements that can be characterized as individual behaviors? We concurrently observed the abdominal cuticle, synchrotron x-ray images of tracheal tubes, and CO<sub>2</sub> expiration from the tenebrionid beetle, *Zophobas morio*. We hypothesized that the so-called “abdominal pump” actually encompasses multiple behaviors characterized by different kinematics, and that only some abdominal behaviors are related to tracheal tube compression. If a casual link exists between tube collapse and a specific behavior, then that behavior should co-occur with tracheal compression.

## Materials and methods:

### **Animals**

This study was conducted using the ground beetle *Zophobas morio* Fabricius (Coleoptera: Tenebrionidae). This beetle was chosen for its relatively large body size, providing easy visualization of abdominal movements and tracheal tubes, and because beetles belonging to the Tenebrionidae family have been the subject of previous studies concerning abdominal movements (Schilman et al., 2008; Tartes and Kuusik, 1994). Furthermore our preliminary x-ray imaging identified that *Z. morio* exhibit tracheal compression. Adult beetles were purchased from Carolina Biological (Burlington, NC, USA) and were kept in a terrarium with *ad libitum* food and

water prior to testing. Nineteen beetles were used, with mass  $445.5 \pm 78.9$  mg (mean  $\pm$  s.d., hereafter).

## **Experimental Design**

Two separate sets of trials were conducted to address each of the project's two main questions (see above). Both sets of trials shared the same experimental set-up, including video recording both abdominal movement and tracheal tube behaviors as well as CO<sub>2</sub> release using flow-through respirometry; however, the chambers used to contain the beetle varied. One set of trials was conducted using a transparent chamber to obtain high-resolution images of abdominal movements. The second set of trials was conducted using a semi-transparent and much smaller chamber to obtain high-resolution respirometry data. Additionally, a third set of trials was conducted without the use of synchrotron x-rays to serve as a control for comparison between constrained, irradiated beetles and unconstrained, “naturally” behaving beetles. The details of the trials follow below.

### **Abdominal movements and x-ray imaging**

To determine the relationship between abdominal movements and tracheal tube compression, the external behavior of the abdomen was imaged concurrently with synchrotron x-ray imaging of the tracheal tubes. A Sony NEX-VG10 (New York, NY, USA) high-definition video camera with was used to visualize movements of the beetle's exposed abdominal tergites. A Nikon 105 mm AF Micro-Nikkor lens (Melville, NY, USA) was used, which produced a field of view of approximately 2.0 cm x 1.5 cm. The video camera was positioned to obtain a side view of the beetle's abdomen. X-ray images of tracheal compressions were recorded using a Cohu 2700



video camera (San Diego, CA, USA) and a 2x microscope objective, producing a field of view of 3.2 mm x 2.4 mm. Both sets of videos were recorded at standard rates (30 Hz). Movie clips were downloaded to a Macintosh computer using Final Cut Pro (Apple Inc., Cupertino, CA, USA).

Synchrotron x-ray image data were obtained using the XOR-32ID undulator beamline at the Advanced Photon Source (Argonne National Laboratory, Argonne, IL, USA). Phase-enhanced images were made with monochromatic x-rays (30 keV), a sample-to-scintillator distance of ~0.4m, and a scintillator screen (cerium-doped yttrium aluminum garnet). Further specifics of this imaging technique can be found in (Socha et al., 2008; Socha et al., 2007).

## **Respirometry**

To determine the relationship between abdominal movements, compression of tracheal tubes, and external gas exchange, the imaging techniques described above were conducted while concurrent CO<sub>2</sub> expiration was recorded. A positive pressure flow-through system was used to record CO<sub>2</sub> production from the animal. A mixture of 79% N<sub>2</sub> and 21% O<sub>2</sub> gas was made using dry, compressed nitrogen and oxygen set to flow at 1L/min using mass flow controllers (O<sub>2</sub>: Hastings HFC – 302, Teledyne Hastings Instruments, Hampton, VA, USA; N<sub>2</sub>: Side-Trak Model 840L-2, Sierra Instruments, Monterey, CA, USA). This gas mixture was flowed over the beetle in a respiratory chamber (described below) and then measured in-line using a CO<sub>2</sub> analyzer (LI-7000, LI-COR, Lincoln, NE, USA). The length of tubing that connected the respirometry chamber to the CO<sub>2</sub> analyzer was 1.11 m. The voltage output from the CO<sub>2</sub> analyzer was transferred to a computer using a DAQ (NI 9125, National Instruments Corporation, Austin, TX, USA), and was recorded at a sampling rate of 100 Hz using Labview software (National

Instruments Corporation). The CO<sub>2</sub> analyzer was calibrated and spanned using a 99.2 ppm CO<sub>2</sub> reference gas and a CO<sub>2</sub>-free gas (compressed nitrogen) prior to conducting the trials.

Beetles were held in a tube of x-ray translucent polyimide film (Kapton, Dupont, DE, USA), which allowed for some movement of the legs but constrained the animal from translating forward or backward. The tube's dimensions were 0.7 cm in internal diameter and 3.7 cm long, with a volume of 1.42 mL. The Kapton tube was capped at both ends using a male Luer x 1/8" hose barb tubing connector (Cole-Parmer, Vernon Hills, IL, USA) and clay-like adhesive (UHU tac, UHU GmbH & Co. KG, Baden, Germany). The air stream entered the Kapton tube at the animal's head and flowed posteriorly to exit the tube behind the abdomen (Figure 1). To test the sealing of the Kapton tube, the flow rate was measured (Intelligent Subsamplere TR-SS3, Sable Systems International, Las Vegas, NV, USA) with and without the tube in-line. A high flow rate is necessary in this system to have sufficient temporal resolution to detect potential effects of tracheal tube compressions, which occur on the second time-scale. The resolution of the respirometry system, accounting for both washout in the respiratory chamber and tubing volume as well as transit through the CO<sub>2</sub> analyzer's detection chamber, must allow for identification of events with sub-second precision. For our system the average measured flow rate was 927±13 mL/min, corresponding to a time constant (Gray and Bradley, 2006) for the Kapton chamber of 0.09 sec and a 95% washout time of 0.27 s. The transit time through the CO<sub>2</sub> analyzer's cylindrical detection chamber (volume=10.86 mL) was 0.71 s. These parameters were sufficient to identify CO<sub>2</sub> events with sub-second precision.

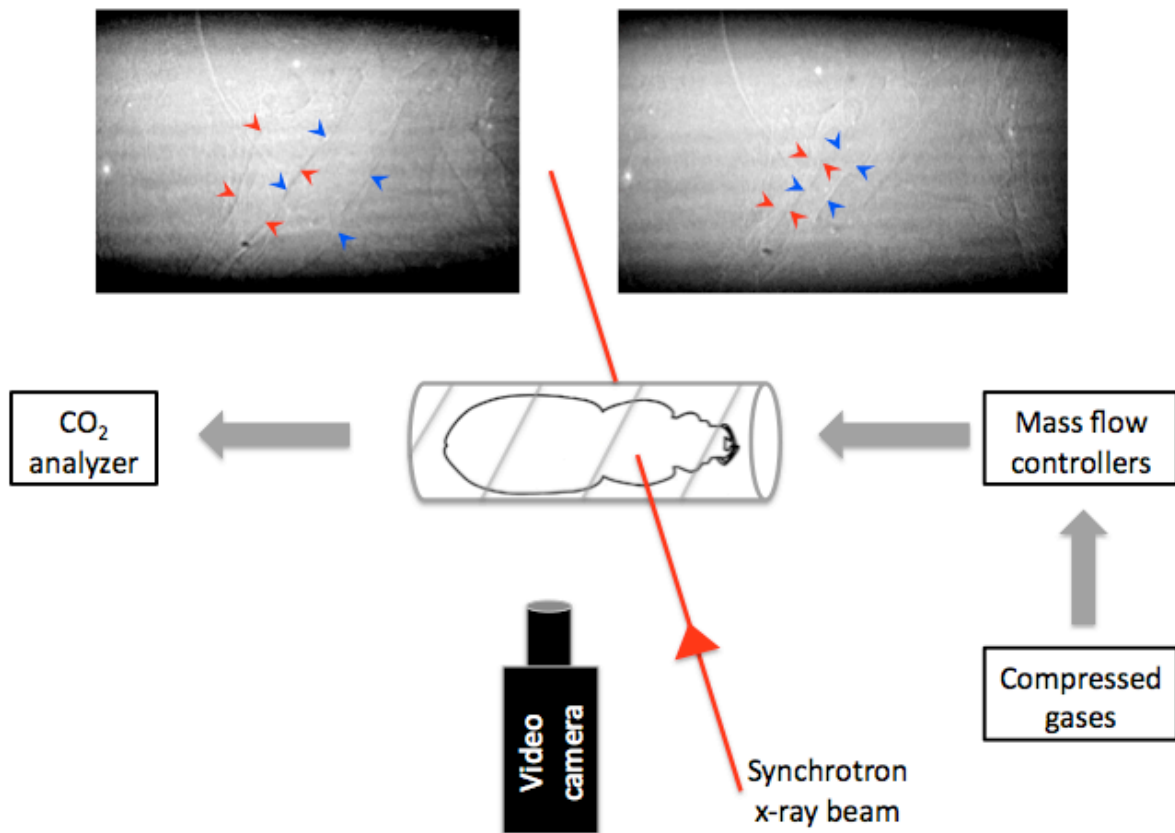

Figure 1: Experimental setup used to simultaneously record abdominal movements, tracheal tube compressions, and CO<sub>2</sub> emission of the tenebrionid beetle, *Zophobas morio*. X-ray movie stills depict two tracheal trunks (colored arrow heads) inflated (left) and compressed (right). The field of view is 3.2mm x 2.4mm. In the schematic diagram, legs are not depicted for clarity.

While the Kapton-tube chamber is well-suited for collecting x-ray images, the material is only semi-opaque in visible light. The movements of the abdominal surface are detectable through the Kapton chamber, but discerning the details of the movements proved to be difficult. Therefore, a second set of trials was conducted using a custom-built acrylic Plexiglas chamber, which allowed for clearer visible-light imaging of the beetle's external behavior. The acrylic chamber measured 1.6 cm x 1.7 cm x 7.6 cm internally, with a volume of 20.67 mL, and utilized the same male Luer fitting connections with the respirometry system. Because this larger chamber has a much longer 95% washout time (2.04 s), trials utilizing the acrylic chamber were not included in the analysis of event timing, but for analyzing abdominal movements in detail.

## **Trial protocol**

Beetles were weighed to the nearest 0.1 mg using a balance (Mettler-Toledo, Columbus, OH, USA). To expose the abdominal tergites for the recording of abdominal movements, the animal's elytra and hind wings were excised using surgical scissors and a dissecting probe. For the trials utilizing the Kapton tube, the beetles were placed into the tube and positioned on a translatable stage in line with the x-ray beam, with the head pointed up and the dorsal surface facing the x-ray source. The video camera was also mounted on the stage to provide a lateral view of the beetle's abdomen. After recording a 2-4 minute baseline of CO<sub>2</sub>-free air, the respiratory chamber was then connected in-line with the flow-through respirometry system. At least 5 minutes of CO<sub>2</sub> and abdominal movement data were recorded in this state (hereafter, "pre-beam"), serving as a reference for comparison with the x-ray data. During this pre-beam period a synchronization event was performed to link the abdominal movements, tracheal compressions, and CO<sub>2</sub> expiration data together (described in detail below). The x-ray beam was then turned on and the beetle was translated so that the main thoracic tracheal trunks were in view. If a trachea was observed to collapse within 2 minutes, a sequence of compressions were recorded for at least 1 minute. If no collapse was observed, the beetle was further translated to view other areas of the body. To visualize all areas of the abdomen and thorax, the beetle was translated from the starting point (middle of the prothorax) posteriorly along one lateral edge of the animal to the tip of the abdomen, and then anteriorly along the opposite lateral edge back to the prothorax. To attempt to capture as many tracheal compression events as possible, specimens were irradiated until the animal no longer produced any detectable movement (typically ~20 minutes). After the x-ray beam was turned off, a second baseline of CO<sub>2</sub>-free air was recorded.

Additional trials were conducted on separate beetles using the acrylic chamber to more clearly image the external movements of the abdomen. For these trials, the protocol was modified in that the beetles were mounted to prevent movement and to allow a clear view of the dorsal abdominal surface. After the elytra were excised, the animal was placed upon a block of clay-like adhesive roughly the size of the animal, and strips of the adhesive were placed over its legs and head to immobilize the animal. Once mounted, the beetles were placed in the acrylic chamber connected to the respirometry system, and oriented so that the x-ray images revealed a lateral view.

### **Data Synchronization**

To allow for *post hoc* synchronization of the x-ray video, light video, and CO<sub>2</sub> data, a concurrent flash of light and synchronous voltage signal were produced. The light was produced by a voltage source connected to the DAQ, producing a voltage spike recorded in Labview at the same time the light pulse was recorded on each video recording, enabling synchronization precise within one video frame (1/30<sup>th</sup> of a second). The coordination of the CO<sub>2</sub> data required an additional consideration. In a flow-through respirometry system, there exists a time lag from when CO<sub>2</sub> is output from the animal and when the gas analyzer records it. To determine this time was used a pressure-controlled picoliter volume ejector (Picospritzer III, Parker Hannifin Corporation, Fairfield, NJ, USA) connected to a tank of CO<sub>2</sub> gas. When triggered, a valve is opened for a set time period, producing a discrete pulse of CO<sub>2</sub> in synchrony with a voltage spike. Here, a volume of CO<sub>2</sub> was released into the chamber containing a dead, desiccated beetle to replicate the flow conditions, as described by (Socha et al., 2008). The experimental time lag was determined to be  $0.87 \pm 0.02$  s (n=6 CO<sub>2</sub> injections) for the system using the Kapton chamber

(See Appendix A). Prior to analysis, the respiratory recordings were time-shifted to correct for this lag.

### **Control Trials**

Additional trials were conducted without synchrotron x-rays to evaluate potential respiratory effects of excising the beetle's flight wings and elytra, which cover most of the spiracles. Respiratory trials were conducted using the same setup as described above, with two modifications: 1) the gas source was compressed air set to flow at 1 L/min, and 2) the respiratory chamber was a glass tube (1.7 cm in diameter with a volume of 8.4 mL) placed in an infrared activity detector (AD-1, Sable Systems International, Las Vegas, NV, USA), which provided a dark environment. Data from the activity detector was used to exclude periods of movement from the analysis. Five beetles were monitored while their CO<sub>2</sub> respiratory patterns were measured for 1.5 hours. Their elytra and wings were then excised (procedure taking ~3 minutes) and they were immediately placed back into the respiratory chamber for another 1.5 hours of CO<sub>2</sub> emission recording. The pre-excision and post-excision were then compared to evaluate if the excision procedure altered the average metabolic rate of the animals. The mass-specific average CO<sub>2</sub> expiration over a 15-minute period without movement from the animal was measured from the pre-excision and post-excision periods. The averages from each animal were then grouped to compare between the two conditions and tested for difference using a Student's t-test (alpha = 0.05).

To assess the effects of constraint on the beetle's abdominal movements, the abdomen of a set of five beetles was imaged under unconstrained conditions. After excision of the elytra and wings, the beetle was placed in the same acrylic chamber used previously (1.6 cm x 1.7 cm x 7.6

cm), allowing free movement of the beetle. The dorsal-ventral movements of the abdominal tergites were imaged in a lateral view using the high-definition video camera. From these videos the duration of abdominal movements were measured to compare abdominal behavior in constrained and unconstrained conditions (Appendix B). Durations were measured to compare the effects of constraint since more discrete analysis of abdominal tergite behavior was not possible due to the animal's movement in unconstrained videos.

## **Analyses**

Seven Kapton chamber trials were recorded (one per specimen), and six were used for analysis; the omitted trial was not analyzable due to the beetle moving throughout. For each trial, clear, discernable, and rhythmic tracheal compression events were identified. For each event, x-ray video, light video, and CO<sub>2</sub> data were analyzed frame by frame using a custom Matlab program (written by H. Pendar) designed for simultaneous playback of all data sources (Figure 2). To determine the timing of tracheal tube compression, abdominal movement, and CO<sub>2</sub> pulse characteristics, each data source was examined frame-by-frame for the events detailed in Table 1. The x-ray video was first examined and all tracheal tube compressions were identified and characterized for the four timing events: start of tube compression, end of tube compression, start of tube expansion, and end of tube expansion. Subsequently the light video of the abdomen was examined and movements with repeatable characteristics were identified and characterized using similar timing events (Table 1). Finally, CO<sub>2</sub> data was examined with reference to the identified tracheal compressions and the local peak (within  $\pm 3$  seconds of the start of a tracheal compression) was identified. All events were recorded as timestamps that were used to calculate the temporal relationships (i.e. durations and delays between events) among abdominal

movements, tracheal compressions, and CO<sub>2</sub> pulses. To determine uncertainty, we used a conservative  $\pm 1$  frame confidence interval for the detection of each video event to calculate a 95% confidence interval (C.I.) of 0.19 s when comparing any two events (Appendix C).

Four trials were recorded (one per specimen) for analysis of the abdominal movements using the acrylic respirometry chamber. For these trials, repetitive abdominal movements that occurred in both beetles were identified. To characterize each movement, the displacement of the abdominal tergites during the movement was digitized using ImageJ (Rasband, 1997-2012). In particular, the tergite height was calculated as the distance between the mid-segment apex of the dorsal surface and the dorsal edge of the abdominal lateral carina. The tergite displacements are reported for the tergites 3, 4, 5, and 6, since these middle tergites most clearly displayed the abdominal movements. This resting tergite height was compared to the height of the tergite at maximum depression during the movement (Figure 3), and the timing of this maximum depression (as a percentage of the movement's total duration, see Table 1) was measured.



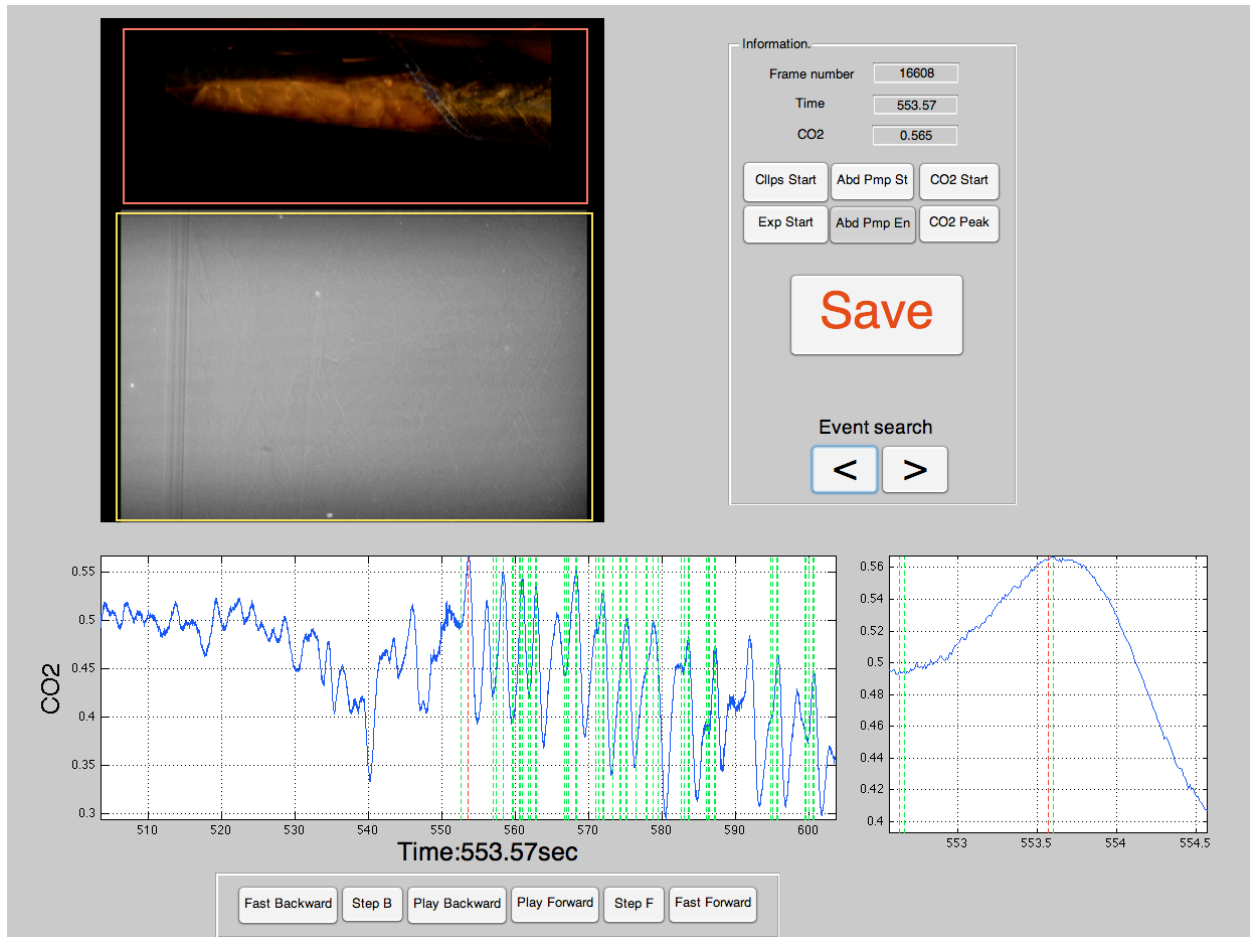

Figure 2: The custom Matlab interface used to simultaneously playback all data sources. The light video of the abdominal movements is outlined in red, the x-ray recording of tracheal tubes is outlined in yellow, and the CO<sub>2</sub> recording is displayed along the bottom as a 100 second trace (left) and 2 second trace (right). Controls and data are displayed on the top-right panel. This custom program was developed by H. Pendar.

Behavior	Event	Operational definition
Tracheal tube compression	Start of tube compression	The first frame at which the maximum tube diameter (resting) begins to decrease at any point along the tube
	End of tube compression	The frame at which the minimum tube diameter is reached at all points along the tube
	Start of tube expansion	The frame at which the minimum tube diameter begins to increase at any point along the tube
	End of tube expansion	The frame at which the maximum tube diameter is reached at all points along the tube
Abdominal	Start of	The first frame at which the abdominal cuticle begins to

movements	abdominal compression	compress (move ventrally) at any point along the length of the abdomen
	End of abdominal compression	The frame at which the abdominal cuticle reaches maximum compression at all points along the abdomen
	Start of abdominal expansion	The frame at which the abdominal cuticle begins to expand (move dorsally) at any point along the length of the abdomen
	End of abdominal expansion	The frame at which the abdominal cuticle reaches maximum expansion (resting height) at all points along the abdomen
CO <sub>2</sub> release	Peak	The maximum CO <sub>2</sub> concentration within a local pulse

Table 1: Description of markers used to define events for each behavior analyzed. Total durations of tube compression and abdominal movements were calculated as the time between start of compression events and end of expansion events. Compression durations were calculated as the time between start and end of compression events. Expansion durations were calculated as the time between start and end of expansion events. Static compression durations were calculated as the time between end of compression events and start of expansion events.

## Statistics

To account for the unequal samples sizes collected from each animal, a nonparametric Kruskal-Wallis test was used to test for variation between specimens for tracheal and abdominal timing event variables using JMP software (SAS Institute, Cary, NC, USA). If no variation between the means across the animals was detected ( $p > 0.05$ ), then a 10,000 iteration bootstrap analysis was conducted on the pooled data ( $n = 114$ ) to determine the 95% confidence interval for the given variable. Pre-beam vs. irradiation and constrained vs. unconstrained pinch durations, as well as excised vs. intact elytra CO<sub>2</sub> emission, were evaluated among specimens using two-tailed, paired Student's t-tests.

## Results:

### **Abdominal behaviors**

Two distinct behaviors were identified from video analysis of the abdominal tergites: a 'pinch' movement and 'wave' movement (Figures 3 and 4). A pinch event was characterized by a compression of the dorsal surface, involving the synchronous ventral displacement of each abdominal tergite (Table 2). The magnitude of compression ranged between ~6-12% (0.3 mm – 0.6 mm) of the resting tergite height. During the movement, the compression of the lateral area of each tergite's dorsal surface created a series of dimples along the length of the abdomen. The compressed state was held in all tergites for a ~0.5 sec period of sustained compression (between ~47-72% the total movement duration) before the tergites relaxed, synchronously, back to the resting position.

A wave event, in contrast, originated as a slight depression of tergite three that then successively propagated caudally with an escalating magnitude of depression. The magnitude of maximum compression at tergite three was 5.9% ( $\pm 4.7\%$ ) of resting height, increasing up to 15.9% ( $\pm 3.5\%$ ) at tergite six. Unlike the pinching movement, the tergite depression did not occur synchronously; instead, there was a delay in maximum depression from one tergite to the next posterior tergite of between 2-14% of the total movement duration. Depression was most pronounced at the caudal tergites (tergites 6 and 7) and there was no period of sustained depression (except at tergite 7 to end the movement). The tergites then relaxed back to resting position successively, in the same order that they were depressed.

In all testing conditions (constrained, irradiated, and freely moving) both behaviors were observed. Movements typically occurred as bouts of one movement separated by periods of inactivity and/or bouts of the other movement, though at times a single instance of one movement would directly follow the other.

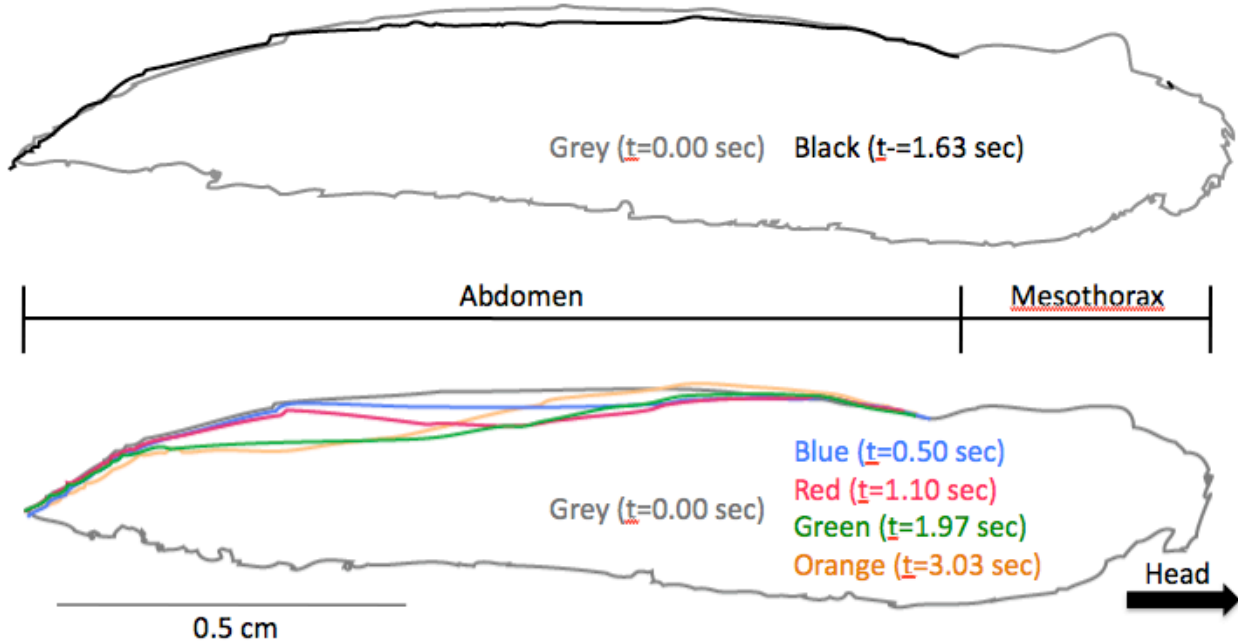

Figure 3: Tracing of the abdominal surface from a representative beetle during a pinch movement (top) and wave movement (bottom). The lower border of the outline is the lateral abdominal carina, while the top edge of the outline is the dorsal surface of the abdominal tergites. The dorsal surface of the tergites is outlined in black (pinch movement) or color (wave movement), representing the difference in tergite behavior during the pinch and wave movements. The head and appendages are not depicted.

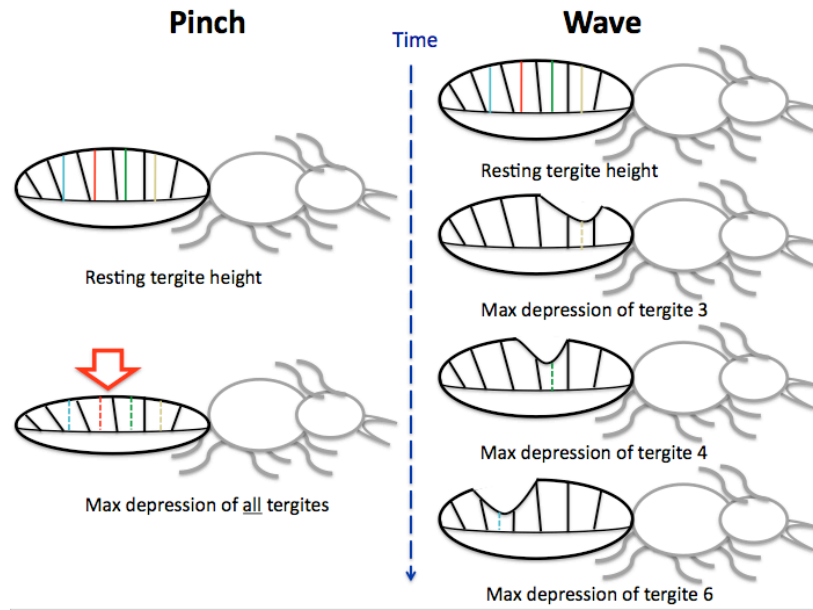

Figure 4: Schematic diagram of the pinch and wave movements, summarizing the relative timing of tergite compression. The dashed, colored lines represent how tergite height was calculated for each tergite. Not to scale.

	Tergite 3	Tergite 4	Tergite 5	Tergite 6	Total Duration of Movement
<b>Pinch</b>					1.84 ( $\pm 0.20$ ) sec
Maximum depression (% of resting height)	11.1% ( $\pm 8.83\%$ )	10.4% ( $\pm 8.84\%$ )	7.88% ( $\pm 3.61\%$ )	9.84% ( $\pm 3.69\%$ )	
Maximum depression (mm)	0.56 ( $\pm 0.44$ )	0.52 ( $\pm 0.44$ )	0.39 ( $\pm 0.18$ )	0.49 ( $\pm 0.18$ )	
Duration of depression (% of total duration)	39.6% ( $\pm 8.11\%$ ) - 65.6% ( $\pm 10.1\%$ )	40.5% ( $\pm 8.17\%$ ) - 65.9% ( $\pm 10.1\%$ )	40.2% ( $\pm 7.20\%$ ) - 67.4% ( $\pm 10.7\%$ )	41.7% ( $\pm 7.42\%$ ) - 68.1% ( $\pm 8.84\%$ )	
<b>Wave</b>					3.95 ( $\pm 0.79$ ) sec
Maximum depression (% of resting height)	9.38% ( $\pm 4.30\%$ )	9.51% ( $\pm 1.96\%$ )	11.2% ( $\pm 5.09\%$ )	15.7% ( $\pm 2.09\%$ )	
Maximum depression (mm)	0.47 ( $\pm 0.22$ )	0.48 ( $\pm 0.10$ )	0.56 ( $\pm 0.25$ )	0.78 ( $\pm 0.10$ )	
Duration of depression (% of total duration)	21.2% ( $\pm 4.32\%$ ) - 25.3% ( $\pm 6.01\%$ )	32.6% ( $\pm 6.91\%$ ) - 36.1% ( $\pm 8.18\%$ )	48.3% ( $\pm 7.34\%$ ) - 57.5% ( $\pm 9.73\%$ )	63.2% ( $\pm 6.93\%$ ) - 71.5% ( $\pm 8.43\%$ )	

**Table 2: Parameters of the two characteristic abdominal movements, sub-sampled from four specimens during x-ray imaging (acrylic chamber trials). Averages ( $\pm$  S.D.) across the four beetles are reported for the average from each individual's set of movements. n=4 animals producing 33 pinch and 22 wave movements**

## Tracheal compression dynamics

Tracheal compressions were observed throughout the beetles' bodies, including head, thorax, and abdomen, with the most obvious compressions occurring in the main tracheal trunks in the prothorax. Similarly to previously observed beetles (Socha et al., 2008; Waters et al., 2013), not all tracheal tubes were observed to compress. Additionally, tracheal tubes did not necessarily compress uniformly or completely along their lengths. Tracheal compressions were detected in 8 of 11 total x-ray trials, although the tracheal compression dynamics of the two acrylic chamber trials were not analyzed.

Tracheal compressions typically occurred in rhythmic fashion, although at times (typically after prolonged x-ray exposure at a single location) the rhythmic nature was observed to transition into a state of prolonged compression (i.e. a clenched tube), compressions would stop altogether, or isolated compression events were observed. The phases of a compression consisted

of collapse (decreasing tube diameter), static compression (maintained minimum tube diameter), and reinflation (increasing tube diameter). Total duration of a tracheal compression (from start of collapse to end of reinflation) was on average  $1.41 \pm 0.37$  s, with a collapse time of  $0.34 \pm 0.22$  s, static compression time of  $0.78 \pm 0.35$  s, and expansion time of  $0.29 \pm 0.11$  s (n=114 events, six specimens).

### **Relationship between abdominal movements, tracheal compressions, and CO<sub>2</sub> emission**

For each and every tracheal tube compression, a corresponding abdominal pinch and a corresponding pulse of CO<sub>2</sub> were observed (Figure 5). Additionally, abdominal pinching movements were only observed with a corresponding tracheal compression. Tracheal compressions varied in magnitude, from dimpling along the tracheal wall to more complete collapse, whereby the diameter of the tracheal tube appeared to be zero. The ‘incomplete’ compressions corresponded to lesser magnitude abdominal pinching, either as shorter tergite displacement and/or quicker movement duration.

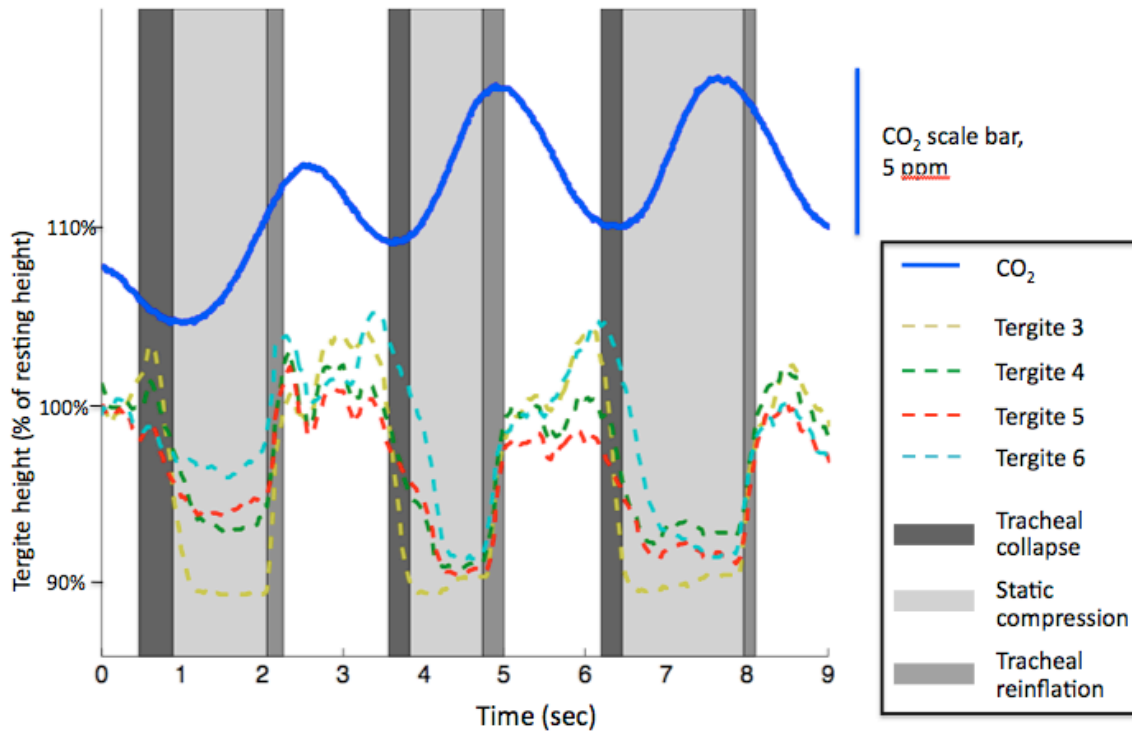

Figure 5: Temporal relationship between three successive tracheal compressions, abdominal pinches, and CO<sub>2</sub> pulses in a representative darkling beetle. Relative tergite height was measured frame-by-frame for each tergite (see text for details). Grey bands depict the state of the collapsing tracheal tube, with the interval white space indicating a fully inflated tracheal tube.

The delay between the start of an abdominal pinch movement and the start of tracheal collapse was constant across the six animals as determined by the Kruskal-Wallis test for variance ( $p=0.32$ ). The subsequent bootstrap analysis produced a 95% confidence interval for the pinch movement beginning 0.04 – 0.02 seconds prior to the tracheal tube collapse starting. While the other timing variables showed significant variation between animals, each delay measure (i.e. start of compression, end of compression, start of expansion, etc.) between pinch movement and tube compression fell within the measurement uncertainty (0.19 s), indicating that the events did co-occur within this level of precision (Figure 6). The average time lag between the start of a pinch expansion and the start of the corresponding tracheal tube expansion was  $0.03 \pm 0.05$  s ( $n=114$ , six specimens). The lag between the end of tracheal compression and the end of abdominal

compression was  $0.08 \pm 0.13$  s (n=114, six specimens), and the lag at the end of expansion events was  $0.05 \pm 0.10$  s (n=114, six specimens).

Each tracheal tube collapse corresponded with a local burst in CO<sub>2</sub>. On average, the CO<sub>2</sub> peak occurred  $0.93 \pm 0.25$  s (n=114, six specimens) after the start of a tube compression. There were no instances of tracheal tube compression without a corresponding pulse of CO<sub>2</sub>.

Although the wave behavior was detected in all trials, no tube collapse event coincided with this type of movement. During wave movements, some tracheal tubes were observed to translate, typically in an undulating fashion within the abdominal cavity; however, no decrease in tube diameter occurred (Appendix D). Wave movements did not correlate with any detectable CO<sub>2</sub> pattern. In the trials without observed tracheal tube collapse, pinching abdominal movements were not detected.



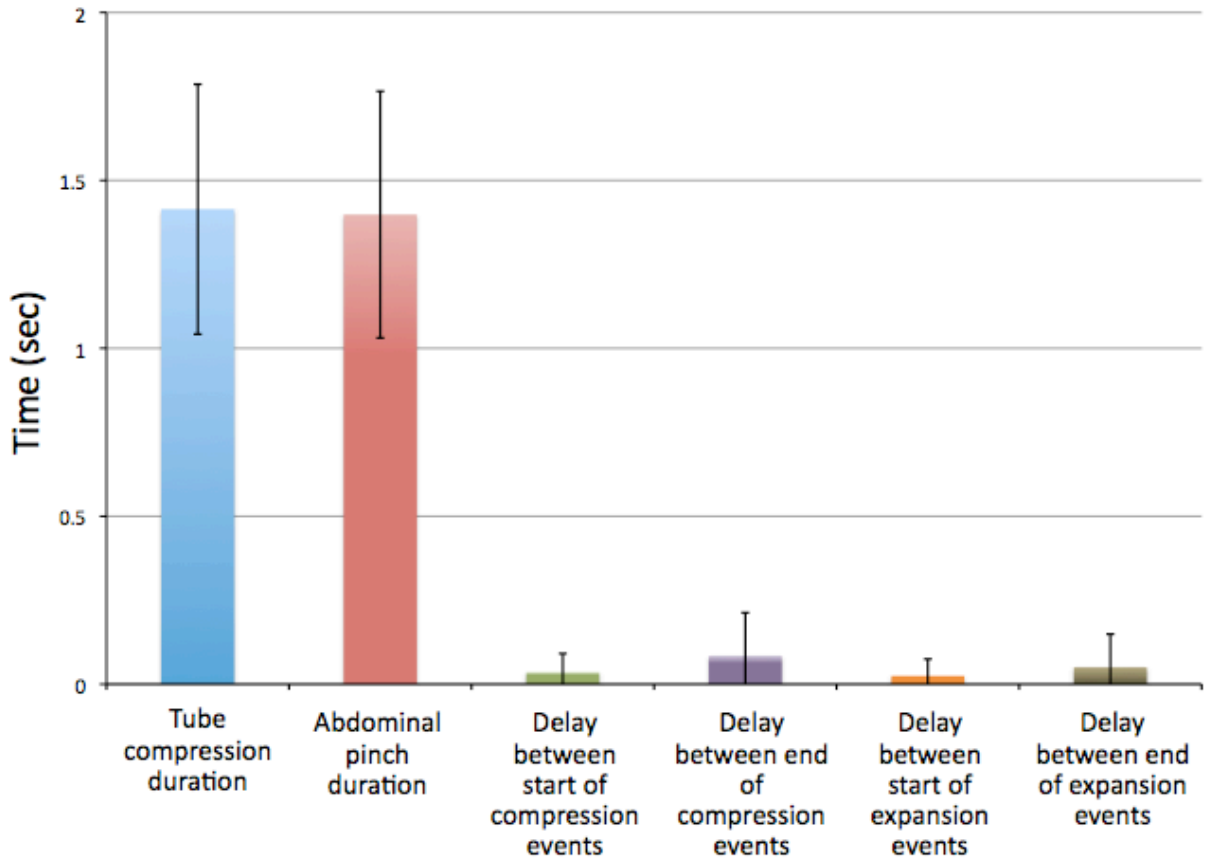

Figure 6: Timing characteristics of abdominal pinch movements and the corresponding tracheal tube collapse.. The pinch movement starts slightly before the tracheal tube begins to collapse (95% CI: 0.04 – 0.02 sec). Data points are averages from 114 events from six specimens. Error bars are  $\pm 1$  standard deviation.

Event	Mean	Range	n events (6 animals)
Tracheal Compression			
Total duration	1.41± 0.37	3.40 - 0.70	114
Collapse duration	0.34± 0.22	1.60 - 0.56	114
Static compression duration	0.78± 0.35	1.90 - 0.07	114
Expansion duration	0.29± 0.11	0.76 - 0.10	114
Pinch Movement			
Total duration	1.40± 0.37	3.54 - 0.80	114
Compression duration	0.30± 0.21	1.43 - 0.83	114
Static pinched duration	0.83± 0.34	1.94 - 0.04	114
Expansion duration	0.27± 0.12	0.80 - 0.07	114
Wave movement			
Duration	2.52± 0.56	4.03 - 1.50	84

Table 3: Summary of tracheal collapse and abdominal movement event characteristics. All units are in seconds.

### Effects of x-ray exposure and surgical manipulation

To determine the effects of constraint due to mounting and x-ray irradiation on the beetle's abdominal behavior, the durations of the abdominal pinch movement were compared across trials. The average pinch duration with the beetle mounted but prior to x-ray exposure was  $1.39 \pm 0.31$  s (n= 58, six specimens). During x-ray irradiation of the same animals, the average pinch duration was  $1.40 \pm 0.37$  s (n=114, six specimens). There was no significant difference in the pinch durations between pre x-ray exposure and during x-ray irradiation (Student's *t*-test, d.f.=170,  $t=0.90$ ). The pinch duration of animals in the unconstrained condition (with no x-ray irradiation) was  $1.47 \pm 0.24$  s (n=84, five specimens). Comparing the pooled pre-exposure and x-ray irradiation durations with the durations of unconstrained animals, there is no significant difference in abdominal pinch durations (Student's *t*-test, d.f.=254,  $t=0.09$ ).

Pre-excision, the beetles' mass-specific average CO<sub>2</sub> expiration was 1.07 ( $\pm 0.31$ ) ppm x min<sup>-1</sup> x g<sup>-1</sup>. After the procedure the average rate of CO<sub>2</sub> expiration was 0.91 ( $\pm 0.12$ ) ppm x min<sup>-1</sup> x g<sup>-1</sup>. These rates were not significantly different (Student's *t*-test, d.f.=8, *t*=0.30), suggesting that the animal's average metabolic rate did not change.

### Discussion:

Abdominal pinching movements occurred simultaneously with tracheal tube compressions in the tenebrionid beetle, *Zophobas morio*. The coupling of abdominal pinch movements and tracheal tube compressions suggest a mechanistic linkage between the two behaviors. On the other hand, abdominal wave movements were not correlated with tracheal tube compression, despite similar location and magnitude of movement relative to pinching movements. Tracheal compressions and pinching movements were also correlated with local bursts of expired CO<sub>2</sub>.

### **Abdominal movements and the mechanism of tracheal collapse**

Two abdominal movements that could be grossly considered as “abdominal pumping” behaviors were characterized in detail to help determine their role in active respiration, specifically with respect to tracheal tube collapse. A timing analysis was conducted to identify the movements as either pinching, in which abdominal tergites move in synchrony, or wave, in which abdominal tergites move in succession. Whereas the pinching movements were tightly correlated with respiratory behaviors, the wave movements occurred independent of tracheal compression or any obvious pattern of CO<sub>2</sub> expiration. It is possible that the abdominal pinching movements may be similar to the “abdominal paroxysms” of *Eleodes obscura* (a closely related

species to *Z. morio*) described by Schilman and colleagues (Schilman, Kaiser et al. 2008). In that study, abdominal movements were measured using an infrared activity detector that outputs a single signal in attempt to characterize the entire abdomen's behavior. Although they demonstrate a correlation between abdominal paroxysms (described only as "rapid short term oscillations") and CO<sub>2</sub> pulsations, possibly similar to the correlation found in our study between abdominal pinching movements and bursts of CO<sub>2</sub>, comparing the movements is difficult since the characteristics of the abdominal paroxysms are concealed within the single output of the infrared detector. Furthermore, they briefly described the occurrence of another abdominal movement, called "bowel movements", that is potentially a behavior similar to the wave movements documented here. Although some parallels may exist between the abdominal movements Schilman and colleagues briefly described and those we described here, we have demonstrated that a more detailed examination of the abdomen's behavior is needed to understand the intricacies of the various movements and their potential physiological effects.

Comparing the abdominal movements characterized in our study with the results of previous studies that examined abdominal movements is difficult due to the perspective of the studies. In the previous studies, abdominal movements were typically examined with respect to some other, focal aspect of physiology, and few studies focused on beetles. As a result, the body of literature that examined beetles' abdominal movements is sparse, with the typical method of measurement being an infrared sensor that subsumes the total movement of the abdomen into a single signal (Duncan and Byrne, 2002; Duncan and Förster, 2010; Schilman et al., 2008; Sibul et al., 2004; Tartes et al., 2002). The result is a series of correlations between various respiratory and/or circulatory phenomena and the gross movement of the abdomen. The single infrared sensor used in the previous studies cannot differentiate tergite-to-tergite differences in abdominal

movements. We conducted exploratory trials using the AD-2 infrared sensor aimed at various locations along the exposed dorsal surface of multiple *Z. morio* abdomens, and could not differentiate individual tergite movements nor wave movements from pinch movements from this single light sensor. Consequently, comparing the two movements we have characterized to the abdominal behaviors recorded in these previous studies would be speculative.

In our study, the degree of abdominal tergite depression was similar for both pinching and wave movements (between 6 – 16% of their resting dorsal-ventral height). The behavior of each dorsal tergite during pinching and wave movements is also similar – a decrease in dorsal-ventral height with a bilateral dimpling of the lateral edge about the middle of the segment. However, clearly the movements of individual tergites were not in and of themselves responsible for tracheal compression. The important aspect appears to be the synchronization of tergite depression, as only the pinch movement is correlated with tracheal compression. During a pinch movement, compression of the tracheal tube wall began momentarily after the start of dorsal abdominal cuticle compression (95% CI = 0.02 – 0.04 sec). The short time lag suggests a common source, such as shared neural input and/or a mechanistic linkage, which singularly determines the onset and cessation of both abdominal pinching and tracheal compression events. Recent evidence has linked hemocoelic pressure pulses to tracheal tube compressions (Cox, 2011), therefore it suggests that the onset of abdominal pinching causes an increase in hemocoelic pressure that is coupled with tracheal compression. In this model, as soon as the tergites begin to relax from the pinched state, the hemocoelic pressure would decrease, and immediate expansion of the compressed trachea coincides. Additionally, careful review of instances of incomplete tracheal tube compression (dimpling or partial collapse) revealed corresponding abdominal pinching movements that appeared to be similarly scaled-down in magnitude. Although this

study does not demonstrate a direct causal relationship between abdominal pinching and tracheal compression, we have documented a correlation that strongly suggests a mechanistic linkage.

Pressurization of the hemocoel has been proposed as the more likely of two mechanisms hypothesized to cause tracheal tube collapse (Cox, 2011). The hemolymph pressure mechanism supposes a pressure gradient across the tracheal tube wall sufficient to overcome the structural reinforcement of the taenidia and induce collapse. The pinching of the abdominal cuticle likely results in a decrease of internal volume of the abdomen and possibly increases the hemolymph pressure within the hemocoel. This behavior raises interesting questions about how pressure is controlled by the animal. How acutely, or specifically, does the beetle modulate the pressures it creates? Further experimentation integrating pressure sensors with observing abdominal movements and tracheal tube behavior would help elucidate how pressure is transferred within the animal and how trachea respond to varying pressures.

The findings of the current study lend support to the hypothesis of tracheal collapse by hemolymph pressure. Considering that tracheal collapse only occurs with abdominal pinching movements, and not during abdominal wave movements, two justifications arise. The first, as previously mentioned, is that systemic pressurization is likely created throughout the hemocoel during pinching movements. We observed tracheal tube compressions occurring throughout the beetle's body during pinching movements, most notably in areas of the body (*i.e.* the thorax) that were not near the place of actuation (abdominal tergites). Comparing to the wave movement, in which movement is generally restricted to a single tergite at any given time, pressurization of the hemocoel is not likely to result. Secondly, the "direct" mechanism of tracheal collapse suggests instead that trachea are compressing due to direct impingement upon the tracheal tube wall, such as during isovolumetric contraction of surrounding musculature. This

direct mechanism of collapse is discounted by the current findings, owing to the fact that similar abdominal tergite movements occur, presumably due to the action of the same muscles, without a similar response in the surrounding tracheal tubes. The movements are consistent with the anatomy of the expiratory muscles, which connect the ventral sterna to the dorsal terga (Harrison et al., 2012). The contraction of these expiratory muscles is likely responsible for the movement of the abdominal tergites during both pinching and wave movements, with the key difference being complete or absent coordination, respectively. Since the same muscles are likely responsible (at least in part) for both types of movement, one would expect to observe tracheal tube compression in both instances if direct impingement was the mechanism of tracheal collapse. Instead, the tracheal tubes respond to a wave movement by translating (in a fully inflated state) in an anterior-posterior undulating fashion. Furthermore, since tracheal compressions were often observed to occur in the thorax, despite the body movements occurring in the abdomen, hemolymph pressure provides a link between actuation and response. It does remain a possibility that muscular contractions were occurring in the thorax simultaneously with abdominal pinching movements, but our methods were not designed to detect such muscle activation.

### **Physiological effect**

We observed a corresponding burst in  $\text{CO}_2$  with each and every tracheal tube collapse (n=114).  $\text{CO}_2$  bursts occurred superimposed on an elevated background of  $\text{CO}_2$ , indicating at least one spiracle was open before, during, and after tracheal collapse. Maintaining an open spiracle ensures sustained interface with the external air and may suggest that tracheal collapse is used to augment the passive diffusion of gases into and/or out of the animal. This finding is consistent with previous research on caterpillars and carabid beetles, which demonstrated that tracheal tube

collapse convectively pushes air out of the animal (Greenlee et al., 2013; Socha et al., 2008).

Combining this collection of findings, it is apparent that tracheal tube collapse causes convective flow of CO<sub>2</sub> out of the animal.

Although the data in this study strongly suggest that the compression of tracheal tubes facilitates external gas exchange, the functional purpose of tracheal compression is potentially more convoluted. The system is complex, with an interconnected network of tracheae, varying magnitude and location of collapsing tracheae, and modulated control of spiracle behavior, combined with cellular respiration constantly fluctuating the composition of air occupying the tracheae. This combination of factors creates a highly variable system with a large degree of potential actuation and response behaviors that are possible. Since tracheal compression would have opposite effect if all spiracles were closed vs. open (driving internal gas exchange vs. external gas exchange, respectively), and possibly some modulation between the extremes with varying coordination of spiracles opening/closing, it is difficult to determine function. It is known that spiracular coordination modifies the directional airflow into and out of the animal (Duncan and Byrne, 2002). Perhaps the animal modifies the functional effect of tracheal collapse by modulating the location and magnitude of open spiracles. If oxygen delivery to local tissues or carbonic acid hemolymph buffering (to remove circulating CO<sub>2</sub>) is necessary, the animal could close all or local spiracles to increase pressure within the tracheal system. On the other hand, if CO<sub>2</sub> is required to be rapidly removed from the animal, an open spiracular system would result in convective airflow out of the animal with each tracheal collapse, assuming lower pressure in the external environment.

### **Effects of irradiation**



Prolonged x-ray exposure from synchrotron imaging will eventually alter the respiratory pattern and kill the insect (Socha et al., 2007). However, x-rays can be successfully utilized to observe internal phenomenon without significantly altering the resting metabolic state of insects within a finite window of time (Socha et al., 2008). Following similar protocol (using low power and finite time periods to minimize radiation effects), we have observed tracheal tube collapse in *Z. morio*, and have demonstrated that the underlying behavior, abdominal pinching, is not significantly affected. Pinching movement durations were measured in beetles mounted and ready for x-ray exposure, then in the same animals during x-ray exposure, and finally (in a separate set of beetles) in beetles left unconstrained (but with elytra and wings excised). I've reported the durations of the pinching movements to be consistent across all conditions. We have demonstrated how abdominal pinching is coupled to tracheal tube collapse, and further shown how the behavior is observed across a range of experimental conditions in *Z. morio*. These findings lend further support to previous findings, which relied on CO<sub>2</sub> patterns alone (Socha et al., 2008), that tracheal tube collapse is a respiratory behavior that facilitates external and internal gas transport.

## **Conclusion**

In *Z. morio*, tracheal tube collapse and pinching abdominal movements occur simultaneously. It follows that the candidate mechanism for tracheal tube collapse is the synchronous movement of abdominal tergites (pinch movement) that induces volume changes and pressurizes the animal's hemolymph and collapses compliant tracheal tube walls. Furthermore, we have identified a lab-based proxy for measuring tracheal tube collapse by means of abdominal movements. Since the state of tracheal tubes can be inferred by observation of abdominal movements, the option of conducting lab-based studies that hinge on knowledge of

tracheal tube collapse is possible without subjecting specimens to x-rays. If pinching abdominal movements (or some variant thereof) is observed across beetle species, it could prove useful for teasing out the intricacies of tracheal tube collapse, and also to establish trends within and between species related to respiratory behavior.

#### References:

**Arieli, R. and Lehrer, C.** (1988). Recording of locust breathing frequency by barometric method exemplified by hypoxic exposure. *Journal of Insect Physiology* **34**, 325-328.

**Bailey, L.** (1954). The respiratory currents of the tracheal system of the adult honey-bee. *Journal of Experimental Biology* **31**, 589-593.

**Chappell, M. A. and Rogowitz, G.** (2000). Mass, temperature and metabolic effects on discontinuous gas exchange cycles in eucalyptus-boring beetles (Coleoptera: Cerambycidae). *The Journal of experimental biology* **203**, 3809-3820.

**Duncan, F. and Byrne, M.** (2002). Respiratory airflow in a wingless dung beetle. *Journal of Experimental Biology* **205**, 2489-2497.

**Duncan, F. and Förster, T.** (2010). Pump out the volume--The effect of tracheal and subelytral pressure pulses on convective gas exchange in a dung beetle, *Circellium bacchus* (Fabricus). *Journal of Insect Physiology*.

**Gray, E. M. and Bradley, T. J.** (2006). Evidence from mosquitoes suggests that cyclic gas exchange and discontinuous gas exchange are two manifestations of a single respiratory pattern. *Journal of Experimental Biology* **209**, 1603-1611.

**Greenlee, K. J., Socha, J. J., Eubanks, H. B., Thapa, G., Pederson, P., Lee, W.-K. and Kirkton, S. D.** (2013). The scaling of hypoxia-induced compression in the tracheal system in the caterpillar, *Manduca sexta*. *The Journal of Experimental Biology (in press)*.

**Gulinson, S. and Harrison, J. F.** (1996). Control of resting ventilation rate in grasshoppers. *Journal of Experimental Biology* **199**, 379-389.

**Harrison, J., Woods, H. and Roberts, S.** (2012). Ecological and Environmental Physiology of Insects. New York: Oxford University Press, Inc. pg. 36.

**Harrison, J. F.** (1997). Ventilatory mechanism and control in grasshoppers. *Integrative and Comparative Biology* **37**, 73-81.

**Ichikawa, T.** (2008). Periodic abdominal pumping supports leg development during metamorphosis in tenebrionid beetle *Zophobas atratus*. *Comparative Biochemistry and Physiology-Part A: Molecular & Integrative Physiology* **150**, 8-13.

**Kaiser, A., Klok, C., Socha, J. J., Lee, W.-K., Quinlan, M. C. and Harrison, J. F.** (2007). Increase in tracheal investment with beetle size supports hypothesis of oxygen limitation on insect gigantism. *PNAS* **104**, 13198-13203.

**Lighton, J. and Lovegrove, B.** (1990). A temperature-induced switch from diffusive to convective ventilation in the honeybee. *Journal of Experimental Biology* **154**, 509-516.

**Miller, P.** (1960). Respiration in the desert locust I. The control of ventilation. *Journal of Experimental Biology* **37**, 224-236.

- Schilman, P., Kaiser, A. and Lighton, J.** (2008). Breathe softly, beetle: Continuous gas exchange, water loss and the role of the subelytral space in the tenebrionid beetle, *Eloedes obscura*. *Journal of Insect Physiology* **54**, 192-203.
- Sibul, I., Kuusik, A. and Voolma, K.** (2004). Patterns in abdominal pumping, miniature inspirations and heartbeats simultaneously recorded during cyclical gas exchange in adult *Hylobius abietis* (Coleoptera: Curculionidae) using a respirometer and IR actographs. *European Journal of Entomology* **101**, 219-226.
- Slama, K.** (1999). Active regulation of insect respiration. *Annals of the Entomological Society of America* **92**, 916-929.
- Sláma, K.** (1988). A new look at insect respiration. *Biological Bulletin* **175**, 289-300.
- Socha, J. J. and De Carlo, F.** (2008). Use of synchrotron tomography to image naturalistic anatomy in insects. *Proc. of SPIE* **7078**, 70780A-70780A-7.
- Socha, J. J., Lee, W.-K., Harrison, J. F., Waters, J. S., Fezzaa, K. and Westneat, M. W.** (2008). Correlated patterns of tracheal compression and convective gas exchange in a carabid beetle. *Journal of Experimental Biology* **211**, 3409-3420.
- Socha, J. J., Westneat, M. W., Harrison, J. F., Waters, J. S. and Lee, W.-K.** (2007). Real-time phase-contrast x-ray imaging: a new technique for the study of animal form and function. *BMC Biol* **5**, 6.
- Tartes, U. and Kuusik, A.** (1994). Periodic muscular activity and its possible functions in pupae of *Tenebrio molitor*. *Physiological Entomology* **19**, 216-222.
- Tartes, U., Kuusik, A., Hiiesaar, K., Metspalu, L. and Vanatoa, A.** (2000). Abdominal movements, heartbeats and gas exchange in pupae of the Colorado potato beetle, *Leptinotarsa decemlineata*. *Physiological Entomology* **25**, 151-158.
- Tartes, U., Kuusik, A. and Vanatoa, A.** (1999). Diversity in gas exchange and muscular activity patterns in insects studied by a respirometer-actograph. *Physiological Entomology* **24**, 150-157.
- Tartes, U., Vanatoa, A. and Kuusik, A.** (2002). The insect abdomen - a heartbeat manager in insects? *Comparative Biochemistry and Physiology a-Molecular & Integrative Physiology* **133**, 611-623.
- Wasserthal, L. T.** (1996). Interaction of Circulation and Tracheal Ventilation in Holometabolous Insects *Advances in insect physiology* **26**, 297-351.
- Wasserthal, L. T.** (2012). Influence of periodic heartbeat reversal and abdominal movements on hemocoelic and tracheal pressure in resting blowflies *Calliphora vicina*. *Journal of Experimental Biology* **215**, 362-373.
- Waters, J., Lee, W.-K., Westneat, M. W. and Socha, J. J.** Dynamics of tracheal compression in the horned passalus beetle. *American Journal of Physiology - Regulatory, Integrative and Comparative Physiology* **304**,R621-R627.
- Weis-Fogh, T.** (1967). Respiration and tracheal ventilation in locusts and other flying insects. *Journal of Experimental Biology* **47**, 561-587.
- Westneat, M., Betz, O., Blob, R., Fezzaa, K., Cooper, W. and Lee, W.** (2003). Tracheal respiration in insects visualized with synchrotron X-ray imaging. *Science* **299**, 558-560.

## Appendices

### Appendix A: Calculation of CO<sub>2</sub> correction factor using a gas microinjector

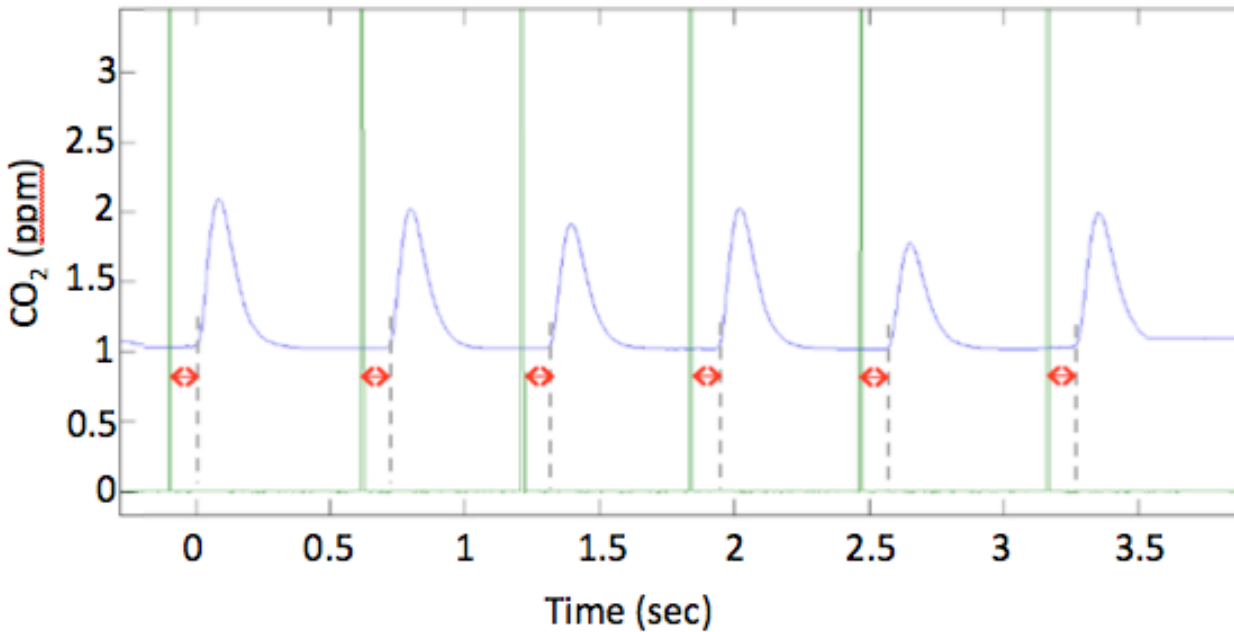

Supplementary Figure 1: Raw data from microinjection trials using the Kapton chamber used to calculate the timing offset required to synchronize the CO<sub>2</sub> data with the video data. The green lines are voltage pulses produced by the microinjector (Picospritzer II, Parker Hannifin, Cleveland, OH) simultaneously with a bolus of CO<sub>2</sub> (blue trace). The red arrows indicate the measured interval between release of CO<sub>2</sub> (the green lines, but see below) and detection by the analyzer (the grey dotted lines), which was used to calculate the experimental delay within the flow-through respirometry system. This measured interval between release and detection of CO<sub>2</sub> was  $1.13 \pm 0.2$  sec. However, the transit time of CO<sub>2</sub> within the picospritzer itself also had to be accounted for (0.26 sec; measured previously in Socha, et al. 2008 though using a tubing of same diameter but 0.4m shorter than that used here), and was subtracted from the measured interval. The resulting value, 0.87 sec was used to offset the CO<sub>2</sub> data in order to synchronize it with the video recordings.

Appendix B: Supplementary Video 1 & 2



**Supplementary Video 1: Abdominal pinching movement in an unconstrained beetle. The elytra and wings have been removed and the animal is on a vertical wall of the acrylic chamber. Refer to Dalton\_E\_T\_2013\_video1.**



**Supplementary Video 2: Abdominal pinching movement in a constrained beetle (prior to x-ray irradiation). The elytra and wings have been removed, the animal's head and legs are secured with putty, and the animal is housed in the acrylic chamber. Refer to Dalton\_E\_T\_2013\_video2.**

Appendix C: Measurement uncertainty analysis used to calculate the video event detection confidence interval

Attributing the occurrence of an event as a discrete action specific to a single video frame represents a degree of uncertainty in the analysis of video data. Using uncertainty analysis we can consider the detection of events as variables with inherent uncertainty and calculate a confidence interval for our analyses. The observer bias can subjectively quantified (i.e. how confident the observer is that a particular event occurs when they deem it to) and attributed as a source of random error. We will assume our systematic error is zero since our measurement bias is also our observer bias. Therefore, where  $u$  is uncertainty,  $r$  is random error (in our case determined to be  $\pm 1$  frame; 1 frame = 1/30 sec = 0.033 sec),  $s$  is systematic error, and  $t$  is time:

$$\begin{aligned}
 u_{\Delta t}^2 &= \left( \frac{\partial \Delta t}{\partial t_1} \right)^2 (r_{t1}^2 + s_{t1}^2) + \left( \frac{\partial \Delta t}{\partial t_2} \right)^2 (r_{t2}^2 + s_{t2}^2) \\
 u_{\Delta t}^2 &= 1^2 \left( (0.06\bar{6} \text{ sec})^2 + 0^2 \right) + (-1)^2 \left( (0.06\bar{6} \text{ sec})^2 + 0^2 \right) \\
 u_{\Delta t}^2 &= (0.06\bar{6} \text{ sec})^2 + (0.06\bar{6} \text{ sec})^2 \\
 u_{\Delta t}^2 &= 2 (0.06\bar{6} \text{ sec})^2 \\
 u_{\Delta t} &= \sqrt{2} (0.06\bar{6} \text{ sec})
 \end{aligned}$$

and calculating a 95% confidence interval in which the actual event occurs:

$$\begin{aligned}
 u_{95\%} &= 1.96 \left( \sqrt{2} (0.06\bar{6} \text{ sec}) \right) \\
 u_{95\%} &= 0.185 \text{ sec}
 \end{aligned}$$

Appendix D: Supplementary Video 3

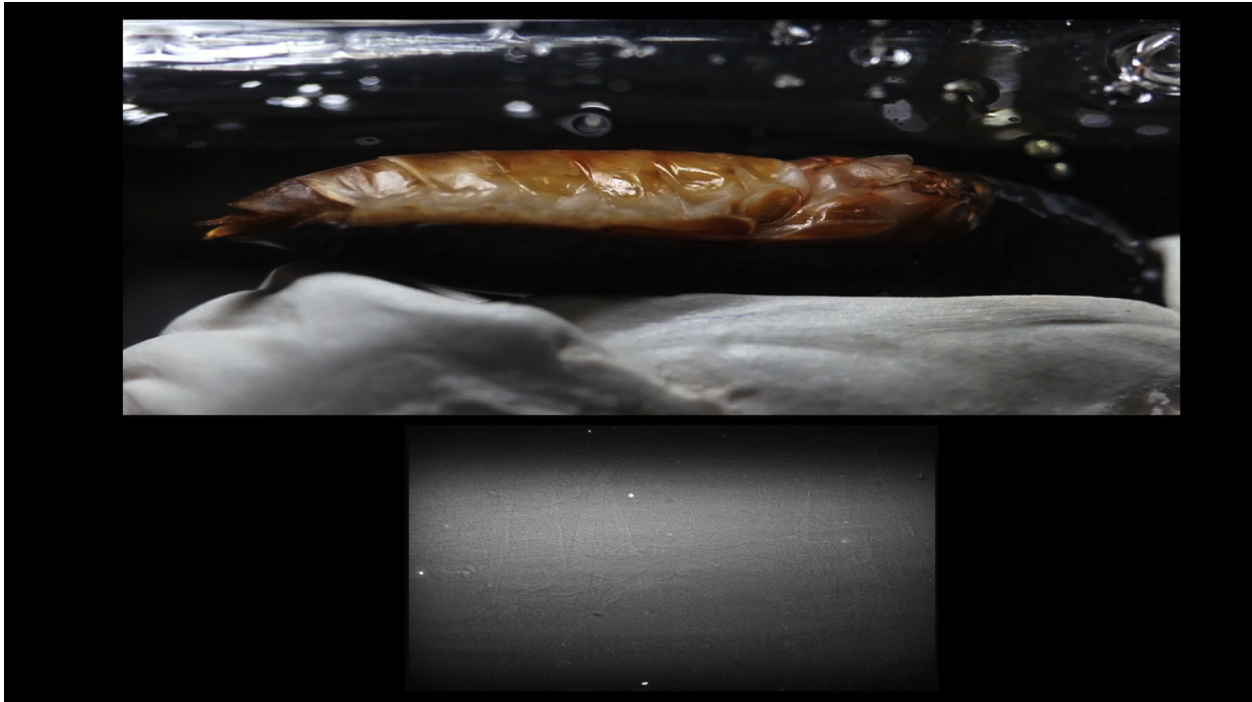

**Supplementary Video 3: Concurrent imaging of abdominal wave movement (top panel) with tracheal tubes in the abdomen (lower panel). The animal's elytra and hind wings have been excised, exposing the abdominal tergites, and its head and legs are secured with clay-like adhesive. The field of view in the synchrotron x-ray video is 3.2mm x 2.4mm. Note the displacement of the tracheal tubes, without compression, with each wave movement. Refer to Dalton\_E\_T\_2013\_video3.**

## Chapter 4: Conclusions

The relationship between abdominal movements and tracheal tube compressions were evaluated in the darkling beetle, *Zophobas morio*. Two distinct abdominal movements were described using digital video analysis, and were defined by a difference in the relative synchrony of tergite movement. In the pinch movement, the abdominal tergites all compress (ventrally) from a resting position in synchrony, and likewise relax back to their resting position as a unit. The wave movement is characterized by an initial compression of the more anterior tergites (typically tergite 3 or 4), with successive compression of the next posterior tergite occurring in series. The compression of each tergite is similar in both movement types (between ~6 – 14% of resting tergite height), but the wave movement involves propagation of tergite compression whereas the pinch movement involves compression in unison. It would appear this aspect of synchrony is key to the function of such pinch movements, as the pinch movement, and not the wave movement, is correlated with tracheal tube compression.

Since the wave movement is marked by compression isolated to a single tergite at any given time, it is not likely that a significant (with respect to the pinch movement) decrease in body volume, and therefore pressurization of the hemocoel, results. This is supported by the fact that no tracheal tube compression was observed during wave movements. On the other hand, the pinch movement is marked by a noticeable decrease in body volume as all abdominal tergites compress together, presumably resulting in a pressurized abdominal cavity. This pressure is distributed throughout the insect's hemocoel, though it is possible that complete or incomplete compartmentalization may differentiate the experienced pressures in one area of the body compared to another. This hypothetical model fits with the observations of the current study, seeing as some tracheal tubes were observed to compress while other tracheal tubes within the field



of view (but perhaps in a different body compartment) remained inflated. Also, it is likely that the material properties of the taenidia that constitute the tracheal walls, which may vary in microstructure throughout different parts of the tracheal system, behave differently depending on the pressures experienced across the membrane. Since the larger tracheal tubes were disproportionately observed to collapse (compared to the smaller trachea) in our study, it would seem that the larger tracheal tubes are more likely to compress than the smaller tracheoles, suggesting that the required pressure differential across the taenidial wall is lower with increasing trachea size. Yet another aspect that should be considered is the dynamics leading to tracheal tube compression, more than just the effects of the abdominal pinch movement. While the pressure on the outside of the tracheal wall may be fluctuating, the pressure within the trachea is likely also in flux due to cellular respiration, mixing of gases within the tracheal system, and/or exchange of gases with the outside environment. While a pressure-driven mechanism causing tracheal tube compression is supported by the findings of the current study, the function of tracheal compressions can only be speculated on.

Tracheal tube compressions were identified and characteristics of the compression dynamics were quantified. Each and every tracheal tube compression correlated to a local pulse in CO<sub>2</sub> emitted from the animal, which along with recent studies (Socha et al., 2008; Waters et al., 2013), supports the notion that tracheal tube compressions function to convectively move respiratory gases. It remains largely in the realm of speculation as to whether tracheal tube compressions function to drive internal gas exchange (at the tracheal-tissue interface), external gas exchange (at the spiracle-environment interface), or some combination of both. Addressing the functional outcome of tracheal tube compressions likely requires a much better understanding of how the insect's spiracles are behaving before, during, and after compressions.

With a completely closed spiracular system, any tracheal compression would increase the intratracheal pressure thus driving internal gas exchange, such as at the site of tissue interface (say if oxygen demand is temporarily increased) and/or to aid the buffering of CO<sub>2</sub> into the hemolymph surrounding the trachea. Conversely, if the spiracular system is completely open, the convective airflow caused by tracheal compression likely results in the flow of air out of the animal since the external air pressure is presumably much lower than the pressure within the terminal branches of the tracheal network. The interesting aspect of this system is the potential to modulate the flow of gases within the trachea with various configurations of spiracle opening/closing. It is feasible that selectively opening certain spiracles during tracheal tube compressions (and/or other means of creating convection) would result in directed airflow within certain regions of the tracheal system. Directed airflow that results from synchronized spiracle activity has been previously reported (Duncan and Byrne, 2002), so speculating that small-scale, site-specific airflows could be being generated within localized regions of the tracheal system is perhaps not unreasonable. In this case, it would be remarkable if the animals are able to control and direct airflow within their tracheal system as respiratory demands of certain tissues fluctuate on short time scales (*i.e.* seconds). This degree of control and modulation, if realized, would represent remarkable sophistication within such a small organism. The application of such behavior would offer great advances to the field of self-contained microfluidic devices, which presently rely on external methods of actuation to transport and mix fluids on the micro scale.

## References

- Arieli, R. and Lehrer, C.** (1988). Recording of locust breathing frequency by barometric method exemplified by hypoxic exposure. *Journal of Insect Physiology* **34**, 325-328.
- Bailey, L.** (1954). The respiratory currents of the tracheal system of the adult honey-bee. *Journal of Experimental Biology* **31**, 589-593.
- Chappell, M. A. and Rogowitz, G.** (2000). Mass, temperature and metabolic effects on discontinuous gas exchange cycles in eucalyptus-boring beetles (Coleoptera: Cerambycidae). *The Journal of experimental biology* **203**, 3809-3820.
- Cox, L.** (2011). Patterns of Hemolymph Pressure Related to Tracheal Tube Collapse in the Beetle *Pterostichus commutabilis*. In *Engineering Science and Mechanics*, vol. Master of Science. Blacksburg, VA: Virginia Tech.
- Duncan, F. and Byrne, M.** (2002). Respiratory airflow in a wingless dung beetle. *Journal of Experimental Biology* **205**, 2489-2497.
- Duncan, F. and Förster, T.** (2010). Pump out the volume--The effect of tracheal and subelytral pressure pulses on convective gas exchange in a dung beetle, *Circellium bacchus* (Fabricus). *Journal of Insect Physiology* **56**, 551-558.
- Gray, E. M. and Bradley, T. J.** (2006). Evidence from mosquitoes suggests that cyclic gas exchange and discontinuous gas exchange are two manifestations of a single respiratory pattern. *Journal of Experimental Biology* **209**, 1603-1611.
- Greenlee, K. J., Socha, J. J., Eubanks, H. B., Thapa, G., Pederson, P., Lee, W.-K. and Kirkton, S. D.** (2013). Hypoxia-induced compression in the tracheal system in the tobacco hornworm caterpillar, *Manduca sexta*. *The Journal of Experimental Biology*.
- Gulinson, S. and Harrison, J. F.** (1996). Control of resting ventilation rate in grasshoppers. *Journal of Experimental Biology* **199**, 379-389.
- Harrison, J., Woods, H. and Roberts, S.** (2012). Ecological and Environmental Physiology of Insects. New York: Oxford University Press, Inc.
- Harrison, J. F.** (1997). Ventilatory mechanism and control in grasshoppers. *Integrative and Comparative Biology* **37**, 73-81.
- Herford, G. M.** (1938). Tracheal pulsation in the flea. *Journal of Experimental Biology* **15**, 327-338.
- Hetz, S. and Bradley, T. J.** (2005). Insects breathe discontinuously to avoid oxygen toxicity. *Nature* **433**, 516-519.
- Ichikawa, T.** (2008). Periodic abdominal pumping supports leg development during metamorphosis in tenebrionid beetle *Zophobas atratus*. *Comparative Biochemistry and Physiology-Part A: Molecular & Integrative Physiology* **150**, 8-13.
- Kaiser, A., Klok, C., Socha, J. J., Lee, W.-K., Quinlan, M. C. and Harrison, J. F.** (2007). Increase in tracheal investment with beetle size supports hypothesis of oxygen limitation on insect gigantism. *PNAS* **104**, 13198-13203.
- Lighton, J. and Lovegrove, B.** (1990). A temperature-induced switch from diffusive to convective ventilation in the honeybee. *Journal of Experimental Biology* **154**, 509-516.
- Miller, P.** (1960). Respiration in the desert locust I. The control of ventilation. *Journal of Experimental Biology* **37**, 224-236.
- Rasband, W. S.** (1997-2012). ImageJ. U.S. National Institutes of Health, Bethesda, Maryland, USA, <http://imagej.nih.gov/ij>.

- Schilman, P., Kaiser, A. and Lighton, J.** (2008). Breathe softly, beetle: Continuous gas exchange, water loss and the role of the subelytral space in the tenebrionid beetle, *Eloedes obscura*. *Journal of Insect Physiology* **54**, 192-203.
- Schmitz, A. and Perry, S. F.** (1999). Stereological determination of tracheal volume and diffusing capacity of the tracheal walls in the stick insect *Carausius morosus* (Phasmatodea, Lonchodidae). *Physiological & Biochemical Zoology* **72**, 205.
- Sibul, I., Kuusik, A. and Voolma, K.** (2004). Patterns in abdominal pumping, miniature inspirations and heartbeats simultaneously recorded during cyclical gas exchange in adult *Hylobius abietis* (Coleoptera: Curculionidae) using a respirometer and IR actographs. *European Journal of Entomology* **101**, 219-226.
- Sláma, K.** (1988). A new look at insect respiration. *Biological Bulletin* **175**, 289-300.
- Sláma, K.** (1999). Active regulation of insect respiration. *Annals of the Entomological Society of America* **92**, 916-929.
- Socha, J. J. and De Carlo, F.** (2008). Use of synchrotron tomography to image naturalistic anatomy in insects. *Proc. of SPIE* **7078**, 70780A-70780A-7.
- Socha, J. J., Lee, W.-K., Harrison, J. F., Waters, J. S., Fezzaa, K. and Westneat, M. W.** (2008). Correlated patterns of tracheal compression and convective gas exchange in a carabid beetle. *Journal of Experimental Biology* **211**, 3409-3420.
- Socha, J. J., Westneat, M. W., Harrison, J. F., Waters, J. S. and Lee, W.-K.** (2007). Real-time phase-contrast x-ray imaging: A new technique for the study of animal form and function. *BMC Biol* **5**, 6.
- Tartes, U. and Kuusik, A.** (1994). Periodic muscular activity and its possible functions in pupae of *Tenebrio molitor*. *Physiological Entomology* **19**, 216-222.
- Tartes, U., Kuusik, A., Hiiesaar, K., Metspalu, L. and Vanatoa, A.** (2000). Abdominal movements, heartbeats and gas exchange in pupae of the Colorado potato beetle, *Leptinotarsa decemlineata*. *Physiological Entomology* **25**, 151-158.
- Tartes, U., Kuusik, A. and Vanatoa, A.** (1999). Diversity in gas exchange and muscular activity patterns in insects studied by a respirometer-actograph. *Physiological Entomology* **24**, 150-157.
- Tartes, U., Vanatoa, A. and Kuusik, A.** (2002). The insect abdomen - a heartbeat manager in insects? *Comparative Biochemistry and Physiology a-Molecular & Integrative Physiology* **133**, 611-623.
- Wasserthal, L. T.** (1996). Interaction of circulation and tracheal ventilation in holometabolous insects *Advances in insect physiology* **26**, 297-351.
- Wasserthal, L. T.** (2012). Influence of periodic heartbeat reversal and abdominal movements on hemocoelic and tracheal pressure in resting blowflies *Calliphora vicina*. *Journal of Experimental Biology* **215**, 362-373.
- Waters, J., Lee, W.-K., Westneat, M. W. and Socha, J. J.** (2013). Dynamics of tracheal compression in the horned passalus beetle. *American Journal of Physiology - Regulatory, Integrative and Comparative Physiology* **Epub ahead of print (Feb 20)**.
- Weis-Fogh, T.** (1967). Respiration and tracheal ventilation in locusts and other flying insects. *Journal of Experimental Biology* **47**, 561-587.
- Westneat, M., Betz, O., Blob, R., Fezzaa, K., Cooper, W. and Lee, W.** (2003). Tracheal respiration in insects visualized with synchrotron X-ray imaging. *Science* **299**, 558-560.
- Westneat, M. W., Socha, J., Waters, J., Hale, M. and Lee, W.-K.** (2007). Phylogenetic diversity of tracheal compression patterns in insects. *SICB Annual Meeting - Poster*, 1-1.

## Appendix A: The initial experimental design, with additional detail on methodology

### **Motivation & Questions**

*What is the relationship between abdominal movements and tracheal tube collapse?*

Abdominal movements have been demonstrated to co-occur with pulses in CO<sub>2</sub> production across multiple insect species (see Chapter 2), suggesting a respiratory function of the abdominal movements. Additionally, tracheal tube collapse in a ground beetle is correlated with a pulse of CO<sub>2</sub> to expire from the animal (Socha et al., 2008). Preliminary data suggests that certain abdominal movements and pulses of CO<sub>2</sub> (characteristic of those that occur with tracheal tube collapse) both occur with the same frequency. Thus, it is hypothesized that one or more types of abdominal movements cause tracheal tube collapse. In order to address this primary question a set of constituent experiments will be conducted to answer precursory questions.

*Can the abdominal movements of the animal be characterized as individual movements that can be evaluated for functional effects?*

As noted in the literature review section, the abdominal movements of insects are poorly documented though the conspicuous “abdominal pump” is generally described as an important physiological behavior. At least in the model animal for this study, preliminary evidence indicates that the abdomen can move in a variety ways and identifying any stereotypical pattern may be difficult to discern from the suite of movements. If the goal is to evaluate what effects the movements of the abdomen have on the insect’s respiratory physiology, then a more complete understanding and thorough description of the abdominal movements is required. Thus, observations will be made to document the behavior of the abdomen in attempt to characterize individual movement patterns. It is suspected that a given abdominal movement is responsible

for tracheal tube collapse, but the difficulty remains in teasing out this singular movement from the variety of movements that occur.

Using a HD video camera to record the exposed abdomen of the model animal, abdominal movement “events” will be collected for analysis. The anatomical structure of the abdomen allows for movement primarily within the transverse plane occurring due to shortening of dorsal-sternal muscles within each abdominal segment (contraction) and shortening of the longitudinal muscles that run along the body-axis from segment to segment (expansion). Therefore, the video recordings for this experiment will aim on a “side view” of the abdomen (a view orthogonal to the long axis of the abdomen), focusing on the dorsal-ventral compression/expansion of the abdominal tergites. For these experiments, the animal will be constrained (required for video recording) and the abdomen will be exposed (by removing or securing the elytra away from the body). The animal will be provided an acclimation period before video recordings begin (preliminary experiments suggest 30 minutes is adequate). Continued recording of the abdominal movements will proceed until sufficient abdominal movement events have been recorded or the animal exhibits any obvious signs of unnatural behavior. Analysis of the images collected during these recordings will consist of quantifying local displacements of the each abdominal segment by tracking cuticular landmarks. Image software (ImageJ) will be utilized to aid in the tracking of locations and calculation of displacements. This quantification analysis will hopefully allow for more discrete characterization of the different abdominal movements than would be possible with qualitative observation.

The data collected from the abdominal imaging experiments will provide a set of quantifiable parameters (digitized movement patterns) that detail the characteristics of a given

movement. Once the movements have been characterized in this fashion then the subsequent experiments that aim to evaluate the effects of the movements can be conducted.

*Do abdominal movements induce volume changes in the tracheal system?*

In a variety of species, the insect abdomen is implicated in respiratory behavior/control, yet the internal mechanisms that give rise to specific patterns of gas exchange are unknown. It would be beneficial to have some insight into the internal dynamics of the insect's respiratory system, but this is difficult in most insect species due to their small size and opaque exoskeleton. Fortunately the use of synchrotron phase-contrast x-ray imaging can be used to view the air-filled respiratory system amongst the animal's denser tissues in the living, breathing animal. Utilizing the abdominal imaging techniques detailed in the previous section along with the phase-contrast x-ray techniques, it is possible to view the external abdominal movements and the internal tracheal behavior in synchrony.

Using the Advanced Photon Source at Argonne National Laboratory, x-ray images of the model animal's tracheal system will be produced. Integrating the HD video camera to image the abdominal movements, and syncing the two recordings together, will provide a set of data images that can be quantified for analyzing the temporal relationship between the two behaviors. Tracheal tube collapse events will be identified on the x-ray images. Documented collapse events can then be correlated with any abdominal movements that co-occur. Time-synced displacements of the abdomen/abdominal segments and tracheal tubes will be detailed with sub-second temporal resolution and statistical analysis will help elucidate the relationship between abdominal movements and tracheal tube collapse. This work will test the temporal linkage

between external and internal dynamics will provide useful insight into the functional relationship between these two processes.

*How are abdominal movements and CO<sub>2</sub> patterns related?*

X-ray techniques will provide useful information on the physical state of the respiratory system; however, the functional effect of collapsing tubes cannot be visualized. Furthermore, while x-ray techniques provide direct evidence of tracheal tubes collapse, the availability of a synchrotron x-ray source is restrictive. It will therefore be insightful to also monitor the respiratory gas exchange of the animals in relation to abdominal movements, creating a linkage between abdominal movements, tracheal tube collapse, and respiratory function. Additionally, if this linkage can be confirmed, a lab-based proxy for identifying tracheal tube collapse events will be established, using characteristic abdominal movements and/or characteristic expired CO<sub>2</sub> events.

A previous study suggests each tracheal collapse results in a burst of expired CO<sub>2</sub> in one carabid beetle species (Socha et al., 2008), and preliminary evidence suggests abdominal movements shortly precede similar bursts in CO<sub>2</sub>. Monitoring the expired CO<sub>2</sub> from the animal during abdominal imaging trials will potentially provide the functional connection between abdominal movements and tracheal tube collapse. Flow-through respirometry will be used to measure the CO<sub>2</sub> expired from the beetle with relatively high temporal resolution (see below), allowing the previously mentioned characteristic CO<sub>2</sub> bursts to be identified. In monitoring the CO<sub>2</sub> patterns during abdominal imaging trials, the temporal relationship between characteristic abdominal movements and CO<sub>2</sub> respiration will be identified. Briefly, CO<sub>2</sub> bursts will be identified as local peaks in the CO<sub>2</sub> recording and correlated to the abdominal movement events



characterized from the video recordings. The correlation between CO<sub>2</sub> peaks and abdominal movement events will be quantified by identifying and comparing timing events of each signal, while accounting for the washout time inherent in the flow-through respirometry system (see below). Once the relationship between characterized abdominal movements and corresponding CO<sub>2</sub> patterns is established, the same abdominal movements can be analyzed from x-ray recordings to determine a relationship with tracheal tube collapse.

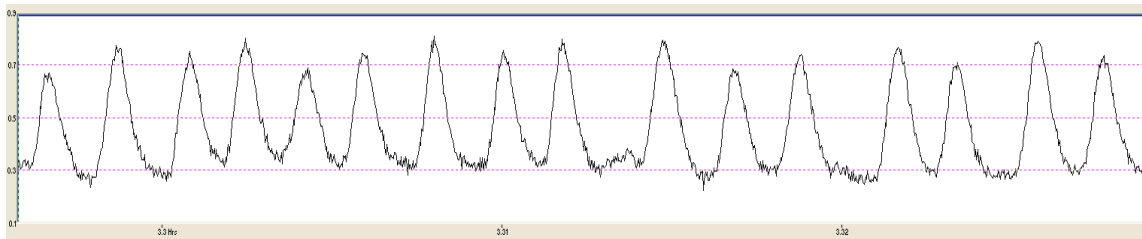

**Figure 1: Rhythmic CO<sub>2</sub> pulses, i.e. "beetle breaths". Time (x-axis is in hours) and CO<sub>2</sub> concentration (y-axis) is in ppm.**

Some initial experiments will be necessary to determine if the manipulations required to obtain the previously described data significantly alter the “normal” behavior of the animal. Since it is required to both expose the abdominal cuticle (by removing or displacing the elytra) and also to constrain the animal from moving around (in order to record the detail of abdominal movements), it is possible that such manipulations affect the animal’s resting behavior. To evaluate these effects, preliminary experiments will be conducted that progressively answer the question of whether the animal is unable to sufficiently adapt to the experimental manipulations. A baseline will be established using the flow-through respirometry system to characterize the CO<sub>2</sub> pattern of an unaltered, freely moving set of animals. The average rate of CO<sub>2</sub> emission will be the variable used to indicate and determine the resting respiratory behavior. Once the baseline is established, the next control experiment will examine how the animal adapts to having its elytra excised, placing the operated animal into the same respirometry system to determine if the

amount of CO<sub>2</sub> released by the animal changes. The final control manipulation will be to constrain the same excised beetles using sticky putty (Uhu Tac) in a fashion that prevents the animal from moving its appendages or head, leaving the abdomen free, and again monitoring the rate of CO<sub>2</sub> emission using the respirometry system. These experiments will be used as a control for the manipulation effects that can be accounted for in the analysis of the main experiments.

#### *Assimilation of questions:*

While conserving abdominal movement recordings across all trials, x-ray images will establish the relationship between abdominal movement events and tracheal tube collapse while the CO<sub>2</sub> recordings will establish the relationship between abdominal movement events and respiratory function, collectively serving to identify a functional mechanism linking abdominal movements to respiratory behavior.

#### **Methods & Techniques**

In aiming to answer the questions detailed above about the relationship between abdominal movements, tracheal compressions, and CO<sub>2</sub> gas exchange in the model organism, *Zophobas morio*, three primary sources of data will be obtained. Imaging the abdominal movements will be accomplished using an HD video camera (1); visualizing the internal behavior of the tracheal compressions will be captured using synchrotron x-rays to create phase-enhanced images (2); and respiratory behavior will be measured using a flow-through respirometry system to capture CO<sub>2</sub> release from the animal (3). An infrared activity detector will also be used as supplemental data source to indicate periods of activity for exclusion of analysis and/or to act as a

supplemental source of abdominal movement data (preliminary data suggests rhythmic, stereotypical abdominal pumping events can be clearly distinguished on the IR signal). These three data collection techniques will be described in detail below.

### *Imaging abdominal pumping behavior*

The primary source of questions arises from the unknown consequences of abdominal movements. In attempt to uncover some understanding of the functional effects behind specific movements, and to define the characteristics of the movements themselves, the abdomen will be visualized using a high-definition video camera (Sony NEX-VG10). While the previous research and initial observations from this study's experiments suggest a variety of complex movements undergone by the abdomen, the most conspicuous movement occurs in the animal's transverse plane. Therefore, the camera will be placed to capture a "side-view" of the abdomen. The camera's recordings at the standard 30Hz frame rate will capture the movements of the abdomen that correspond to respiratory events that are identified on the 100 Hz respirometry recording.

As described above, it has been fairly well documented that at least in some species of beetle the abdominal movements are coordinated with gas exchange and/or heart beating events, though a detailed assessment of these movements is wanting. Analysis of the video recordings from this experiment will aim to identify and label movements of the abdomen as highly characterizable, discrete movements. Assuming each discernable movement has a functional effect, each movement will be examined for its effect on the respiratory physiology of the beetle (see below). To this end, preliminary data suggest that a rhythmic and repeated (though otherwise uncharacterized) movement of the abdomen is coincident with a pulse in CO<sub>2</sub> output in *Z. morio*.

### *Flow through respirometry*

Serving as the primary source of information for the internal dynamics of the organism, flow through respirometry will provide a high-resolution account of how the animal is expiring carbon dioxide. Since the state of tracheal tubes is in question and it has been demonstrated that CO<sub>2</sub> pulses tightly coincide with tracheal tube collapse in another species of beetle, CO<sub>2</sub> is being monitored because it is likely responsive to the physiological behaviors in question. While long time scale data will be collected to ensure large data sets, the analytical focus will be on short-term events that occur on the same timescale as abdominal movements (milliseconds to seconds). Expired CO<sub>2</sub> is known to be highly responsive to movement effects (though whether this is an effect of metabolic activity, spiracular coordination, and/or other factors is unclear) and is already documented to be coordinated to abdominal movements in some species. This experiment will aim to document such patterns on a much shorter timescale than these previous studies, examining the physiological processes causing the CO<sub>2</sub> patterns on an individual event basis. This implies sampling the respiratory pattern at relatively high temporal resolution (comparing to most previous studies) so that events that occur with sub-second resolution can be identified and measured.

The flow-through respirometry setup consists of a compressed atmospheric air gas source (21% O<sub>2</sub>, 79% N<sub>2</sub>) that is passed over the beetle, picking up the respired CO<sub>2</sub>, and flowed through a CO<sub>2</sub> analyzer. Since temporal definition is of utmost importance in this study, the flow rate of the compressed air will be maintained at the relatively high 1 L/min using a mass flow controller (5850E, Coastal Instruments; MFC-4, Sable Systems International), allowing individual respiratory events (i.e. “breaths”) to be measured (Figure 1). Since trials will have the potential to run for hour-length periods of time and desiccation is a concern for the animal, the airflow will be

passed through a water bubbler to maintain a high level of humidity. The use of an automatic baseliner (BL-2, Sable Systems International) will be utilized to allow for long, automated trials. Baselining is critical in flow-through respirometry systems because it provides both a zero “baseline” for which absolute measures of CO<sub>2</sub> can be obtained (i.e. for determining metabolic rate of the organism) and also (and more importantly for the current study) it corrects for drift in the system that occurs over prolonged trials in which the instrumentation can demonstrate gradual fluctuations in performance (such as temperature/concentration drifts within the CO<sub>2</sub> detector’s sampling cells). During trials, the organism will be contained within one of two chambers: a small round glass chamber (1.7 cm diameter, 8.4 cm<sup>3</sup> internal volume) that is part of an infrared activity detector (AD-2, Sable Systems International), used during unconstrained trials where the animal is free to move within the chamber; or a custom-built rectangular acrylic glass chamber (7.2 cm x 3.3 cm x 2.0 cm, 47.5 cm<sup>3</sup>) that will be used during x-ray imaging trials in which the animal is constrained in position using removable adhesive putty (Uhu Tac). Each chamber has the same fittings to allow either one to be plumbed into the flow through system without modification to any other aspect of the system or streamline. Once past the animal’s chamber the gas flow passes into the CO<sub>2</sub> analyzer (LI-7000, LiCor Inc.) where the respiratory CO<sub>2</sub> emitted from the animal is measured in comparison to a CO<sub>2</sub>-free reference gas (compressed nitrogen). The LI-7000 is an infrared differential gas analyzer that uses the IR

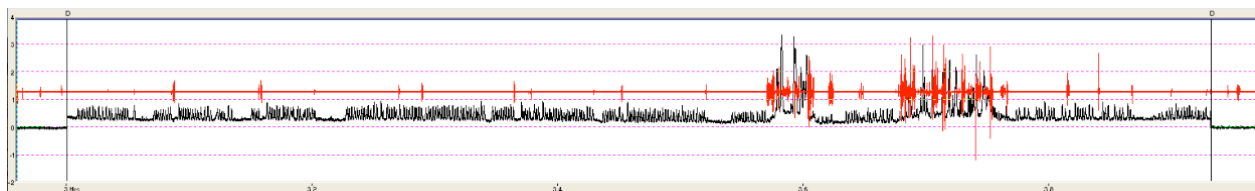

**Figure 2: One hour-long trace of CO<sub>2</sub> release (black line) from a *Z. morio* specimen. The saw-toothed pattern is the result of individual pulses of CO<sub>2</sub>, as seen in Figure 1. Activity is indicated as fluctuations in the red line; note the increased CO<sub>2</sub> output during periods of heightened activity. Five-minute baselines are shown at the beginning and end of the recording and are delineated from the animal’s CO<sub>2</sub> emission by the vertical lines.**

absorptive properties of gases within two sampling cells to determine gas concentration. The analog output from the CO<sub>2</sub> analyzer is converted into a digital signal by a data acquisition system (UI-2; Sable Systems International), and sent to a computer for logging and analysis at a collection rate of 100 Hz. The respirometry setup is summarized in Figure 3. The washout time (the time it takes for the CO<sub>2</sub> released from the animal to flow through the system's tubing, into the detection chamber, and reproduced as an analog signal) will be calculated theoretically using tubing length and flow speed constants, and verified experimentally using time-lag measurements of manually administered CO<sub>2</sub> bursts into the system. The combination of high flow rate (1L/min) and high collection frequency (100 Hz; relative to most flow through respirometry experiments) will provide the temporal resolution required to analyze independent respiratory events that occur in concert with the recorded abdominal movements.

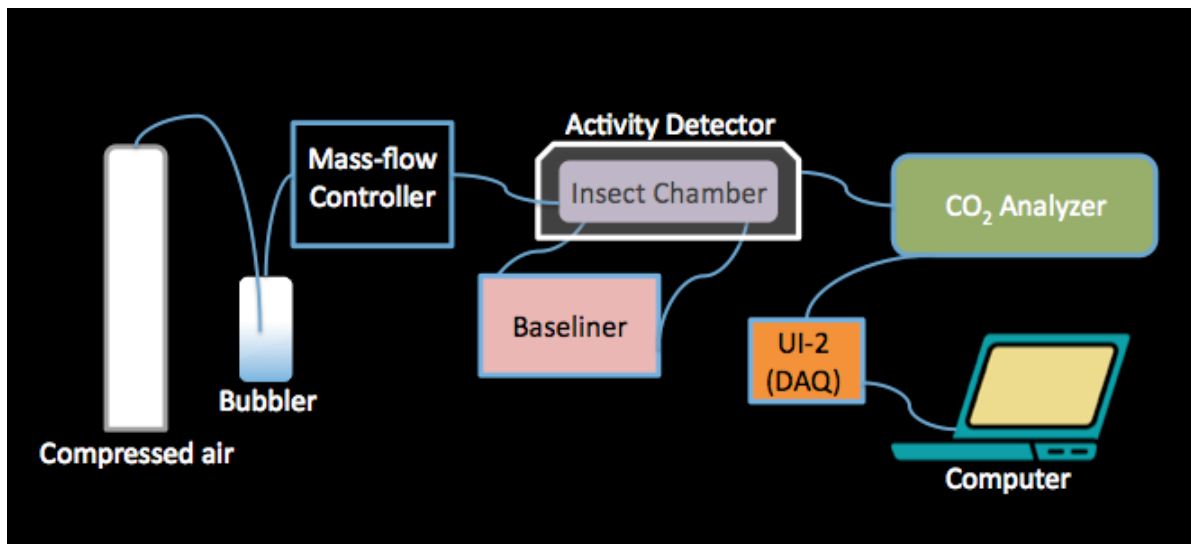

Figure 3: Schematic of the flow through respirometry system

*Synchrotron X-ray Imaging*

Synchrotron x-ray phase-contrast imaging will be used to visualize the internal behavior of the respiratory system (tracheae) of the beetles while the external behavior of the abdominal movements are being recorded simultaneously. Synchrotron x-ray image data will be collected at the XOR-32ID beamline at the Advanced Photon Source (Argonne National Laboratory, Argonne, IL, USA). Phase-enhanced images will be created using monochromatic x-rays (30 keV), a scintillator screen (cerium-doped yttrium aluminum garnet), and a sample-to-scintillator distance of  $\sim 0.4\text{m}$  (for details see Socha, et al. 2007). The lowest possible incident beam flux to form a viewable image will be used so that potential harm to the animal will be minimized. Using a 2x microscope objective and a video camera (Cohu 2700, Cohu, San Diego, CA, USA), images will be recorded at standard video rates (30Hz), providing a full field of view of 3.2 mm x 2.4 mm. The phase-contrast images allow visualization of the tracheal system of the beetles due to the significantly lower density of the air within the tubes relative to the animal's tissues. While the same technique has been used for highly detailed imaging (such as microtomography of the tracheal network down to micron-sized tracheal tubes), the focus of this study will be on the more conspicuous, generally larger tracheal tubes that are known to collapse (such as the tracheal trunks in the thorax). The aim will be to visualize the behavior of these tracheal tubes with respect to the behavior of the abdominal movements. The analysis of the images created using the HD recording of the abdominal movements and those created using the x-ray phase-contrast recording will be completed by combining the two videos together. Using image analysis software (ImageJ), the point tracking method mentioned previously will be used to determine the synchrony between the external movements and internal movements.

### *Model Animals*

The darkling beetle, *Zophobas morio*, will serve as the model organism for these experiments. This animal is chosen due to its large size, docile behavior (ease of handling), and being readily available (purchased from Carolina Biological). Furthermore, the animals are part of the Tenebrionidae family of beetle that have received a deal of attention in the previous research completed on abdominal and respiratory behavior of insects (see Chapter 2), and this project should serve to compliment this body of research. The animal has proven to be both easily handled and tolerant during preliminary experiments in which various handling and/or surgical stressors have not obviously altered its normal behavior for extended periods of time (they adjust to constraint, flow through respirometry, and/or excision of elytra within 1 hour post handling).