

LD
5655
A762
1982B
c.2

Publication 426-490
April 1982



Demonstration Garden Handbook

A Guide to Growing Your Own

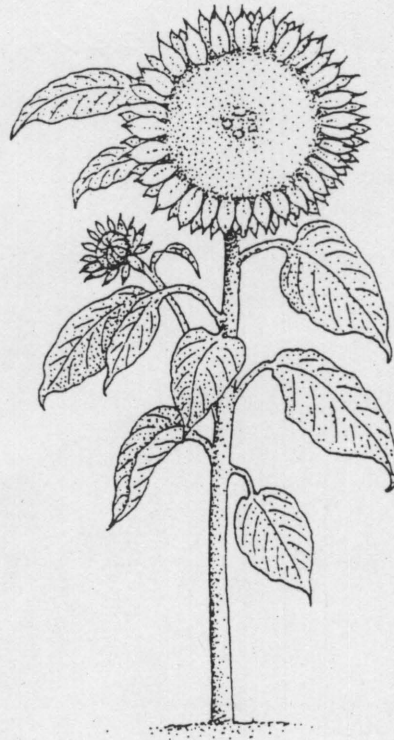

**Virginia Cooperative Extension Service
Extension Division
Virginia Polytechnic Institute and State University
Blacksburg, Virginia 24061**

Virginia Cooperative Extension Service programs, activities, and employment opportunities are available to all people regardless of race, color, religion, sex, age, national origin, handicap, or political affiliation. An equal opportunity/affirmative action employer.

Issued in furtherance of Cooperative Extension work, Acts of May 8 and June 30, 1914, and September 30, 1977, in cooperation with the U. S. Department of Agriculture. Mitchell R. Geasler, Interim Dean, Extension Division, Cooperative Extension Service, Virginia Polytechnic Institute and State University, Blacksburg, Virginia 24061; M. C. Harding, Sr., Administrator, 1890 Extension Program, Virginia State University, Petersburg, Virginia 23803.

DEMONSTRATION GARDEN
HANDBOOK

A Guide to Growing Your Own

Written by: Vicki Karagianis
Project Administrator: Dr. Diane Relf

Illustrations: Rocky Price
Plot Plans: Phil Dzugan

LD
5655
A762
1982b
c.2

CREDITS AND ACKNOWLEDGEMENTS

A number of people have contributed to this booklet in one way or another, and their help has been greatly appreciated. Dr. Diane Relf offered her patience, ideas, criticisms and gentle guidance (and the funds!). Technician Julie Haigler spent long hours planning and caring for the intensive garden, and taking precise records of its abundance, in addition to all her other work. Thanks also to Kris Deimel, a technician, for her many suggestions, and to technician Jody Blum for her assistance.

With the exception of the drawing of the milk jug and hotkap on page 45 (from Becky Butchert's 4-H illustrations), all of the drawings are by Rocky Price, a talented local artist who has been very generous with his time. The plot plans were all done by Phil Dzugan, a work-study student in landscape horticulture. Phil spent his Christmas vacation working on these plans!

Not to be forgotten are the dedicated souls on the farm crew who offered their time, materials, assistance, and rainy-day French fries all summer.

The following companies donated seed: Stokes, Harris, Comstock, Ferre, & Co., Twilley, Kitazawa, Petoseed Co., and Northrup King. Seed were also donated by Oregon State University and the Organic Gardening and Farming Research Center in Kutztown, Pennsylvania. Mr. Charles O'Dell and Mr. Courtney Schwertz donated plants. Dean Foster Nurseries and Bountiful Ridge Nurseries donated strawberry plants. Plants, bench space and lots of patience were offered by the Tech Greenhouse crew. "Instant Greenhouses" were sent to us by Gilbert & Bennett Co.

Reference materials and ideas were found in Ortho and Sunset series books, several Rodale Press books, Extension publications and other books noted within this publication.

Finally, the moral (and other) support I received from Jim Hasslacher helped me to maintain my insanity long enough to finish this.

Nicki Karajian

C O N T E N T S

Introduction	1
Possibilities	1
SECTION I - ESTABLISHING A DEMONSTRATION GARDEN	
Planning	3
Planting	7
Expenditures	9
Benefits	9
Time Needed	11
Recruiting Assistance	14
Gardens in Urban Areas	14
SECTION II - THE GARDENS	
The Intensive Garden	16
Variety Demonstrations	19
Unusual Vegetables	21
Miniature Crops	34
The Herb Garden	37
The Perennial Bed	39
The Vertical Garden	41
The Container Garden	42
Special Displays	43
SECTION III - APPENDICES	
A. Suggestions for Gardens	47
B. Ideas for Workshops and Demonstrations	53
C. Gardening in Raised Beds	54
D. Tools	57
E. Building Materials, Containers, Etc.	58
F. Organic Matter/Mulches (and where to get them)	59
G. Seed, Plant & Supply Sources	60

INTRODUCTION

If you're looking for new ways to relay gardening information to the public, consider a demonstration garden. This is not only an excellent way to teach gardening practices; it can also be a learning experience for you and your staff. And, of course, a demonstration garden provides a place to go and pull weeds when you're tired of sitting in the office.

This booklet is intended to give you ideas for and information about setting up a demonstration garden. It is based upon the experiences from the Home Food Production Demonstration Gardens at the Horticulture Farm near Blacksburg. You will find descriptions of the various trial gardens, suggestions for planning, planting, and maintaining a demonstration garden, ways to use the garden, estimates on costs and time requirements, lists of resources, and ideas for other demonstrations. Specific information is given on unusual vegetables, perennial vegetables, and miniature crops.

Many extension people have discovered over the years that demonstration is one of the most effective ways of teaching. For example, people learn pruning more easily by watching someone prune a tree or shrub, along with verbal or audio-visual instruction, than they do through lectures or slides alone. In the Home Food Production Demonstration Garden, one of the most frequent comments heard on Field Day was: "I'll have to try that!" And that's what it's all about.

POSSIBILITIES

When planning a demonstration garden in your city or county, go for the unusual. Even a simple container garden, imaginatively presented, can attract attention and offer opportunity for instruction. Try new things! New techniques, new varieties, even whole new crops, can be introduced in your garden. Current popular gardening magazines are rich sources of ideas. Make note of questions that come to your office about unusual vegetables, special gardening techniques, and pest control methods. These, too, can be the inspiration for trials to be made in a demonstration garden.

Grow things "everyone" says can't be grown in your area, by using special varieties and techniques. Remember, home horticulture is not like farming - there is not as much at stake if something doesn't work. Some trials will succeed, others will fail, but each will add to your experience and give you information to provide to an increasingly sophisticated and demanding gardening public.

Some ideas for types of gardens which might be established are given in Appendix A. You may have other ideas.

A demonstration garden is great fodder for a regular garden column, newsletter or radio tape. In it you will see what is happening to area gardens and be able to offer timely advice. When you come up with a blank spot, you can fill in with information about new varieties or techniques. If written up and submitted to the state specialists' offices, your experiences can also reach other agents, and consequently, many other gardeners!

Invite the media to visit your garden. One demonstration garden in Chesterfield was followed the whole summer by an area newspaper for a series of articles to be written the following year. Even if the local media do not cover your garden that thoroughly, any amount of exposure lets people know what the Extension service is doing.

The garden is an ideal place to hold demonstrations and walk-throughs. It's also a dynamic laboratory where you can photograph plants, pests, diseases, gardening practices, or whatever you need for gardening programs. (See Appendix B for ideas for workshops and demonstrations.)

If you are in an urban area, don't ignore the possibilities of a demonstration garden. Weedy vacant lots in many cities are being renovated into lush green food gardens. A city garden may require extra planning and care - see "Gardens in Urban Areas," page 14. A community garden containing your extension demonstration plot can offer excellent opportunities for teaching and learning.

This booklet concentrates on vegetable demonstration gardens; fruit production will also be touched upon. However, don't forget flowers and other ornamental plants which add grace and interest to what might otherwise be a very plain-looking garden. You may even wish to display only ornamental plants.

What is offered here is only a starting place. You will certainly have other ideas and uses for a demonstration garden, depending on your area and clientele. Please read the following pages with this in mind.

SECTION I

ESTABLISHING A DEMONSTRATION GARDEN

PLANNING

If at all possible, start planning at least the fall before the demonstration garden is to be planted. If for no other reason, organic materials should be added to the soil in the fall to give them time to break down somewhat before spring. However, you may find that there are other areas in which preparing well ahead of time will prevent frustration.

Choosing a Site

As for any vegetable garden, site choice is important for a demonstration plot. Ideal is a place with rich, well-drained soil, plenty of sun but not flatly exposed, a little shade nearby for hardening-off plants (and resting weary bodies), and a good dependable water supply. It is also preferable to have a site within a few miles of the population center which will benefit from your trials.

Since you are unlikely to find a place with all the above qualities, be especially concerned with these factors:

- at least 6-8 hours of direct sunshine a day
- a water supply
- soil without a hardpan or other serious problems
- a place to store tools and other supplies
- close enough that the caretaker(s) can check the garden at least every other day with a minimum of effort and expense

Other considerations which may have weight: (1) Is it close to a community garden, or can you rent one plot in a community garden? This situation puts Extension side by side with other gardeners; one could announce a demonstration, plant clinic, or question-answer session by posting an announcement at the garden entrance. (2) Does the area have a high theft or vandalism rate, and will people be around to keep an eye on things? (3) Is the garden easily accessible to a pickup truck so that supplies and organic materials can be brought in? (4) Is there some method of controlling surrounding vegetation? Herbicides may result in an unattractive appearance, and drift can damage vegetable gardens, so someone should be responsible for mowing or otherwise keeping the immediate surroundings cleared.

If there is an area near the Extension office which is suitable, this might be ideal. If not, though, someone might be willing to open his or her backyard garden for demonstration purposes. Or, contact the local housing authority for possible sites. Churches, schools, and parks are other possibilities.

See Pub. 426-312 for more information on site planning and location.

Plot Plan

Decide on the style of garden you want. Section 2, "The Gardens," contains descriptions of the demonstration gardens established at the Horticulture Farm near Blacksburg, and Appendix A has suggestions for other possible gardens. The Horticulture Farm garden contained eleven different displays, each of which could be used as a separate demonstration. Start small for best results. One well-maintained bed can hold a lot of interesting items and yield a lot of produce. To help you decide what might work best for you, we've estimated the amount of time and money needed to implement these gardens (see pages 9-13).

Once decided, draw a plot plan. Our plans for the entire group of gardens and for individual ones are on the following pages (Figures 1 to 12). Draw a general plan for your site, then outline the growing area(s) on paper. Leave space in the plan for compost, organic matter and mulch storage, a tool shed if needed, and displays of other items as desired. Consider space, such as border areas, for fruits and nuts and perennial vegetables, even though you may not be able to include these the first year.

Beds need not necessarily be square or rectangular. Good landscaping principles may be applied to make the garden pleasant and attractive, including "soft" shapes and use of trees and shrubs within and around the garden. You might consider an "edible landscape," incorporating attractive fruit trees and bushes, or making use of a building wall for espaliered vines or trees. Or, use special landscaping plants which will attract birds, bees, butterflies or other beneficial fauna.

When using trees and shrubs near vegetable beds, plan so that they will not shade vegetable plants too much or otherwise interfere with plants (root systems should not grow into beds; plants with allelopathic qualities, such as black walnut, should be avoided; etc.)

To prevent soil compaction from traffic, and to demonstrate an attractive planting method which may also result in higher per-square-foot yields, consider raised beds for any demonstration garden. A raised bed may range from a mounded bed without any type of border to a three-foot-high wooden box filled with soil for demonstrating a garden for the physically handicapped. Appendix C contains detailed information on several types of raised beds.

Outlining beds in some manner makes them more attractive and permits easier weed control. At the Horticulture Farm Demonstration Garden, slab wood (the rounded part of a log remaining after lumber is taken from it) was used around beds by securing each slab with short stakes and also supporting it with soil on the bed side and sawdust and soil on the path side.

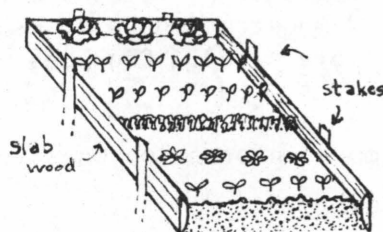

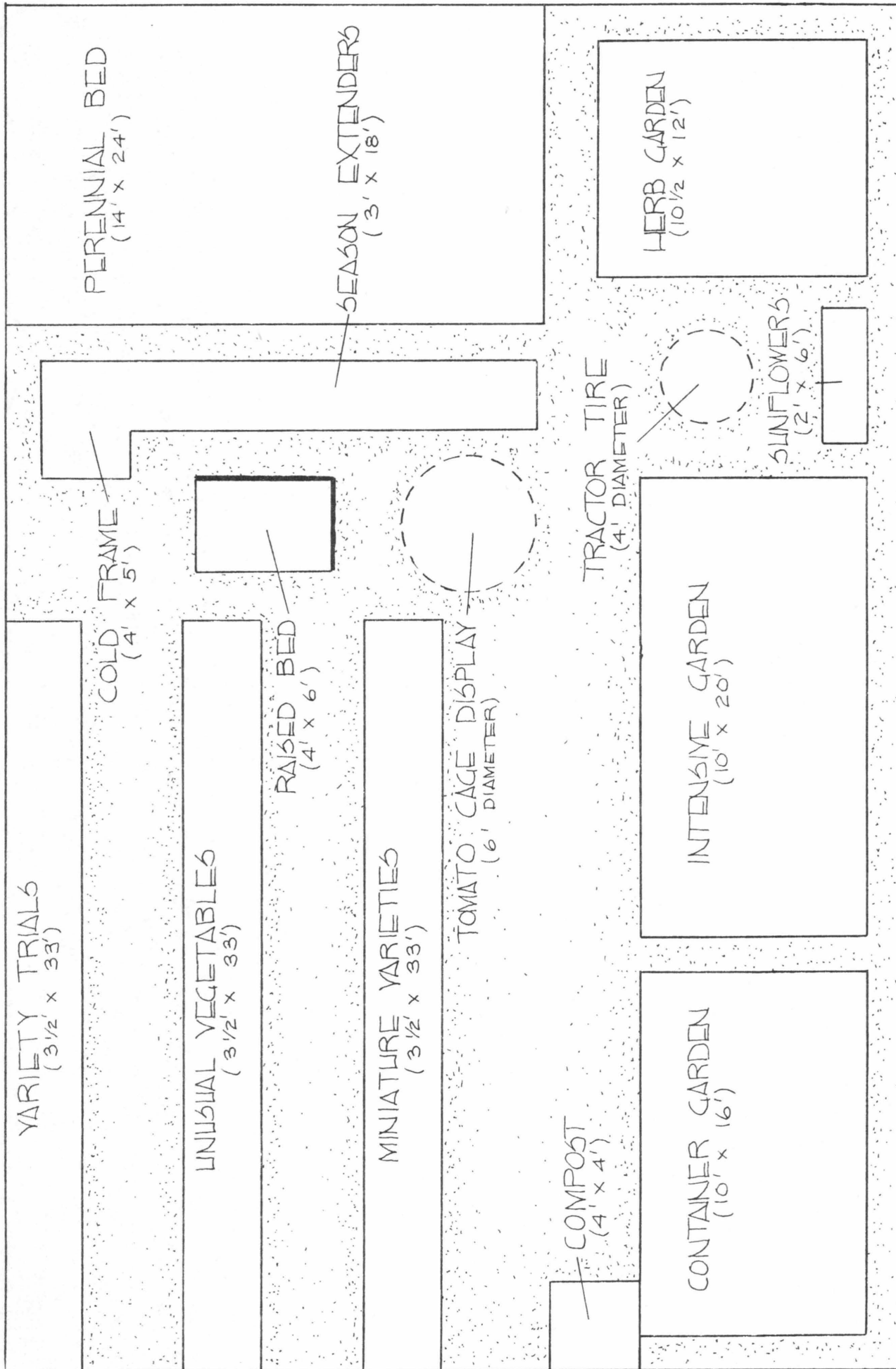

1981 URBAN GARDENING DEMONSTRATIONS

SCALE: 1" = 6'-0"

Other Early Planning

Find Donors

Try to locate donors of seeds, plants and other materials to reduce your costs. Many seed companies and nurseries are willing to contribute. Some firms will ask for your evaluation at the end of the season - send it promptly.

Universities and agricultural research stations testing new varieties are other possible sources of plant material. Local gardeners may also donate flower bulbs, divisions of perennial flowers and vegetables, strawberry runners, excess seeds and other items. Be sure that all donors receive appropriate recognition for their contributions.

Install Water System

If your site doesn't have water freely available, see that a usable system is installed as soon as possible. Carrying 2-gallon cans of water from a building a couple hundred feet away is very tiresome, as is hauling eight lengths of hose from one place to another or bringing water to the site in jugs. Ideally, a permanent spigot near the garden should be installed so that two to three lengths of hose will reach the entire garden. An oscillating sprinkler is a worthwhile purchase (the fan-spray type can be bought for \$5-\$10) unless you are able to invest in a trickle irrigation system or other sophisticated watering devices. If installation of a spigot is impractical, at the very least consider a rain barrel to fill when water is available (cover it to keep mosquitoes from breeding).

Recruit Help

Volunteers or paid staff persons who are to care for the garden should be involved early. Someone should be on the job by March 1st, at the latest, and even then seeds should be in his or her hands. Extra staff may be needed from April through June, depending on garden size and amount of work that must be done. See "Recruiting Assistance," page 14.

Locate a Source of Tools

You will need to have certain tools available when spring rolls around, and if possible the use of a pickup truck or dump truck should be enlisted. Basic tools should be purchased when possible so that they may be kept on-site and ready for use when needed. Try flea markets, yard sales, and auctions for good used tools. Other items, such as rototillers and special-purpose tools, may be borrowed, but workers should be reminded to return them promptly and in good condition. See Appendix D for a list of tools that may be needed.

The use of a pickup truck to bring in organic matter and supplies is almost a necessity; if no one on the project owns one, perhaps a local teenager with access to a truck would volunteer or provide this service for a small fee.

Order Supplies

Supplies for starting plants in the spring should be ordered during the fall or winter so you can get an early start. If fairly substantial quantities (a case or more of Jiffy-7's, for example) are needed, check wholesale nurseries or suppliers, or try to work something out with a local retailer. Don't forget planting media (peat pots and soil, or Jiffy-7's), flats, pot markers, and a seedling nozzle for watering. If there is no greenhouse or cold frame available, grow-lights may be needed.

It is possible to buy plants, but if you are trying unusual crops or varieties not commonly grown in your area, you will most likely have to start your own from seed. A local nursery might consider starting plants for you or giving you bench space if you provide seed, help, or other exchange.

Decide on varieties, and order seeds and plants (asparagus roots, rhubarb crowns, etc.) as soon as catalogs arrive. Have your homework done on unusual crops and know when and how to start them. (Note that seeds for unusual vegetables are frequently sold out early and may have to be re-ordered. We've also experienced germination problems with some seed.) Order spring-flowering bulbs and other fall-planted perennials if there is time to plant before winter arrives.

Construct Permanent Structures

Permanent structures - compost bins, cold frames, fences, etc. - should be built during the fall and winter when possible. Unless a large crew is available, there is little time for such projects during spring planting season. Obtain containers for container gardens during fall and winter, and try to locate a source of scrap wood for odd jobs.

Plowing and Tilling

Have the garden spot plowed or tilled in the fall, especially if the area has not been used as a garden before. Spread manure or other organic matter (see Appendix F for a list of suitable organic materials and sources) before plowing, and plant a cover crop if desired or if the area is subject to erosion. If a cover crop is planted, it should be tilled under several weeks before time for planting other crops.

PLANTING

Late Winter and Early Spring

Begin early - plant seeds indoors the appropriate number of weeks before the last spring frost date. Some, such as celery, might have to be started as early as January. Plan to have transplants ready at the best planting time, then start more if needed for successions (it's a good idea to have 6" seedlings ready to go into an empty space in an intensive garden). This takes careful planning and some luck.

Young seedlings must be cared for daily. They dry out fast under greenhouse conditions, and if grown in a cold frame will be subject to extremes of heat and cold unless care is taken to regulate heat by opening and closing the cover. If one person cannot be responsible for the plants seven days a week, have a watering schedule for volunteers.

If an intensive garden display is used, it should be given high priority, since the whole idea is to obtain as much produce out of the space as possible. Plant early, using cloches and other season-extenders (see "Special Displays," page 45), and have plants growing in every available space. A small intensive garden (the one at the Virginia Tech Horticulture Farm is approximately 10' x 22') is easier to manage than a large one. See Publication 426-335, "Intensive Cropping Methods," and "The Intensive Garden," page 16.

Once garden beds have been tilled and prepared for planting, begin sowing seed and setting out hardened transplants. Have protection available for small transplants. Drying winds and intense sunshine can be just as devastating as nightly cold. Plastic milk jugs, flower pots, baskets, or more sophisticated structures will help. Plants should not be allowed to dry out, and a watering schedule for seven days a week will be needed except when rain is plentiful. Mulch will help on transplants, but avoid a too-thick mulch in early spring, since it will keep the soil from warming up.

Mid Spring and Early Summer

Once established, the garden should be inspected every 2-3 days for insects, disease, water needs, and harvestable produce.

Heavy mulches around plants after the soil has warmed dramatically reduce the need for watering and keep soil temperatures stable (see Appendix F for suggested mulch materials). Mulches also keep weeds down and improve the appearance of the garden. Black plastic mulches are valuable in early spring to help plants get off to a good start, but tend to allow soil to become too hot and become ragged-looking by mid-summer.

Four inches or more of sawdust or other material will keep path weeds to a minimum. Use mulches which are easy to walk on and which won't be blown away or be too easily degraded. Several truckloads may be needed for paths.

Train climbing plants before they grow too large. Prune fruit trees and bushes as necessary.

Continue planting as the season progresses, with new plants filling beds as the old ones come out.

When sprays or dusts are needed, apply as soon as possible, and reapply after rains. If feasible, share pesticides with individuals or other groups. Some are quite expensive (the smallest locally available size of Benlate in 1981 was a two-pound bag, costing \$21.00, for example), and the shelf life might not be long enough to justify such an expense to save a few cucumbers.

Extra help may be needed during planting times and heavy harvesting periods.

Keep careful records of activities, expenses, and harvests, and make suggestions for improvements the following year.

Late Summer through Fall

Continue to harvest and keep an eye on plants for insects and disease. Water when necessary to keep plants growing through dry periods.

Compost or otherwise dispose of plant wastes promptly, and destroy diseased plant materials so that they will not infect other plants. If you plan to burn them, check local burning regulations.

Plant fall crops at appropriate times.

Till finished beds and sow a cover crop if desired.

Clean tools and machines well once the garden is finished. Remove temporary trellises and other structures which may be damaged by winter weather.

Plant and harvest from cold frames and other season extenders when they are used.

Mulch perennial beds and do any necessary pruning or other preparations which will help perennials through the winter.

EXPENDITURES

The Demonstration Garden at the VPI & SU Horticulture Farm included eleven different and separate displays in 1981. The total cost was around \$700 (excluding the greenhouse materials), of which about \$500 was for permanent items. An outline of expenditures is given on page 10. This outline also includes estimates for the cost of each garden as a separate unit. To analyze this information in terms of your own potential demonstration garden, consider:

- Water fixture installation is a major, but one-time expense.
- Fencing is optional, except where there are problems with animals or vandals. A good chain-link fence would cost considerably more than the purely decorative one installed at the Farm.
- Purchase of tools, tiller rental, site rental, and cost for gasoline and some other supplies are not included. These were supplied by the Horticulture Farm.
- Labor is not included for anything.
- Many items were donated.
- Planting costs can be apportioned between the ten different gardens, by about 10% per garden. So, if seed/plant costs were \$45, the average cost per garden was \$4.50. There are exceptions, though. For example, seed costs for the tomato cage display were minimal, since only five plants were used, but several special fertilizers (fish emulsion, bone meal, tomato fertilizer) were called for. For Unusual Vegetables, on the other hand, the seed were quite costly, since many were \$1.00-\$2.00 per packet, but fertilizer costs were average for that garden area. Also, for smaller gardens, expect certain items to be more expensive per item, since it is likely that they won't be purchased in bulk.

It is felt that a small demonstration garden can operate easily for under \$100/year after initial costs for water installation and construction are met. This figure does not include personnel, of course. Volunteers, such as Master Gardeners, garden club members, retired persons, or students eager for experience (in exchange for produce, perhaps?) are all sources of assistance that may keep personnel expenditures down. See "Recruiting Assistance," page 14.

BENEFITS

The harvest from a demonstration garden can be substantial. The produce from our 10' x 22' intensive garden alone was worth about \$300 in 1981, according to supermarket prices the day of harvest (see "The Intensive Garden," page 16). The ability to demonstrate this high a yield from such a small space will have significant impact on your educational program.

EXPENDITURES FOR DEMONSTRATION GARDENS

	<u>1981</u> <u>All Gardens</u>	<u>Estimate</u> <u>Per Garden</u>
Planting Supplies - annual replacement (peat pots, seed-starting soil, etc.)	\$ 47.30	\$ 5.00 - 10.00
Planting Supplies - needed every 2-5 years (flats, cell packs, markers, etc.)	19.77	5.00
Seeds and Plants	44.85	5.00 - 15.00
Fertilizers and Pesticides (1981 figure includes \$21 for Benlate, fertilizers for special tomato display, and some ground rock fertilizers, in addition to "usual" fertilizers and pesticides)	60.19	10.00
Hardware, paint, lumber, chicken wire, hoses, etc. - mostly permanent Raised bed total - approx. \$70 Fence total - approx. \$65	350.39	depends on the garden
Water installation (pipe and fixtures)	150.00 (approx.)	
Miscellaneous (\$48 for 6 dump truck loads sawdust, plastic bags for harvest, office supplies, etc.)	54.48	5.00 - 10.00

TIME NEEDED

Gardens nearly always take more time than is counted on. A demonstration garden is no exception, and in this case it's even more important to control weeds, keep plants well watered, and do all chores "on time." Naturally, time spent in setting up and maintaining a demonstration garden will vary depending on the size of the garden, the number of "extras," and the condition the garden is maintained in, as well as the expertise of the staff.

Some effort was made at the VPI & SU Horticulture Farm demonstration garden in 1981 to keep track of the amount of time spend on individual activities. No attempt was made to be exact; it is just too time-consuming to record every activity and the period spent on it, but the chart on page 13 gives a rough idea of what to expect for each type of garden.

Several changes were made during the season which helped to reduce the amount of time needed for maintenance of the garden: a water spigot was installed near the garden - prior to that watering was done by dragging five or six hoses from bed to bed and holding the hose over the plants, a chore which took several hours; an oscillating fan-type sprinkler reduced the number of times the hose had to be moved and relieved gardeners from hand-watering; borders were put on the growing beds and the pathways were covered with 4" of sawdust, reducing the amount of weeding in the path areas to nearly zero.

The following is a breakdown of the different types of activities involved in implementation of a demonstration garden:

Planning and Paperwork

Includes meetings, discussions, individual research, drawing of garden plans, deciding on cultivars, ordering, preparing paperwork for orders, locating and arranging for delivery of various materials and supplies, preparing written materials, and other indoor work.

Greenhouse Work

Mixing soils, filling pots and cubes, planting, watering, thinning, transplanting, treating for insects, and observing plants are all included here. Plants are in the greenhouse for a period of three months or more and during that time must be watered once, sometimes twice a day, every day. Jiffy-7's reduce time spent on transplanting from flats to peat pots, but they dry out quickly and usually must be watered twice daily when plants become larger.

Gathering Materials

Includes picking up and hauling sawdust, wood chips, leaf mold, leaves, straw, manure, wood, fencing, cages, fertilizers and pesticides, and other supplies.

Preparing Soil

The time spent here depends on the size of the garden, available equipment, and amount of soil preparation needed. If a tractor can be used to plow and disk the garden, this initial preparation may take only a short time. However, if done at the wrong time, resulting soil compaction could cost a lot of effort later in rototilling and spading to make sure roots can grow deeply. Also, raised bed preparation can take a lot of time in the early stages (see Appendix C, "Gardening in Raised Beds"), but if properly done can reduce subsequent soil preparation time significantly.

Soil for containers should be mixed with organic matter and other soil amendments. If desired, it may be sterilized or fumigated.

Perennial vegetables, fruits trees and shrubs, and other long-lived plants need extra care when soil is prepared for them. Organic matter should be added to deeply dug planting areas; ground rock fertilizers will break down slowly and have a time-release fertilizing effect on these plants.

Other soil preparation includes spreading and working in of organic matter over the entire garden area, tilling and raking beds for sowing and transplanting, adding fertilizers, etc.

Planting

Includes sowing seed outdoors, transplanting, measuring for plant placement, watering-in, etc.

Maintenance

Outdoor watering, side-dressings, pinching, pruning, tying, staking, caging, removing dead flowers and leaves, thinning, mulching, weeding, mowing, observing, researching problems, spraying, and other garden maintenance are included.

Harvest

This includes time spent actually gathering harvests, sorting out dead or damaged plant material, and packaging for taking home. It also includes preparation of harvested herbs for drying, a significant amount of time. If an Intensive Garden or Variety Demonstration is planted, you may want to weigh and record harvests. When economic value is to be determined, grocery store prices should be checked within a day or two.

Construction

The following items were constructed for the Horticulture Farm Demonstration Gardens: water spigot and pipeline were installed (not included in chart); a fence for the Intensive Garden, two compost bins, a hose holder made of a wooden spool, several trellises, a number of wooden signs, borders for growing beds, and a cold frame; also included were stripping and re-painting of barrels and a bathtub for the container garden, and painting of a greenhouse bench, a mailbox and other items.

Clean-Up

Cleaning out of spent plants, rototilling and sowing for cover crop, removal and storage of signs and other "hardware," cleaning of cages and trellises, daily cleaning of tools, storage of container store, cleaning and storage of planting items to be used the next year, etc.

* * * * *

The following chart shows the approximate number of hours needed for the various activities within each garden. These are very rough estimates, and may differ for your own garden. However, this can be a guide in determining how much personnel time is needed for maintaining different types of gardens.

Activity	Type of Demonstration	Intensive Garden	Variety Demonstration	Unusual Vegetables	Miniature Crops	Vertical Garden	Perennial Bed	Herbs	Raised Bed/Tractor Tire	Tomato Cage Display	Container Garden
Planning/Paperwork		40	15	20	20	12	20	20*	10	12	10
Greenhouse		15	10	10	10	5	5	10	5	3	5
Gathering Materials		7	5	5	5	8	5	5	7	7	10*
Preparing Soil		8	8	8	8	5	10*	5	6	12	5
Planting		15	10	10	10	10	15*	12	8	3	5
Maintenance		30	20	20	20	20	16	10	5	7	3
Harvest		20	15	10	10	10	1**	13	7	12	2
Construction		20*	2	4	2	15	2	2	15*	2	20*
Clean-Up		10	5	5	5	7	3	4	2	2	2
TOTALS		165	90	92	90	92	77	81	65	60	62

*Significant one-time activities are included

**Expected to increase in future years

RECRUITING ASSISTANCE

If your office is a busy one, you may not have time or personnel to care for a demonstration garden. Consider the following sources of volunteers and low-wage employees:

- (1) Master Gardeners who have pledged work time in return for training received
- (2) Students needing experience who are willing to work without pay
- (3) Garden club members
- (4) Government-sponsored programs which subsidize employees (if there are any left)
- (5) 4-H or Scout groups
- (6) Retired persons
- (7) Coordinate with other programs in existence; e.g., local community garden projects

It is important to have at least one experienced gardener on the crew. Otherwise you may spend more time teaching than you desire. And, since veteran gardeners will likely be visiting your demonstration garden, they will have questions that a novice can't answer.

GARDENS IN URBAN AREAS

Gardening in an urban area can present special considerations which you should be aware of:

- a community garden may be already available in which you can establish a demonstration garden. This is also a possibility in more rural areas.
- ethnic neighborhood gardens offer the chance to share plant varieties and gardening practices across cultures.
- soil should be thoroughly tested; high levels of lead and cadmium have been found in areas where there is heavy vehicular traffic or where buildings have been demolished. This is the exception rather than the rule, but the possibility is there. See Publication 426-314, "Good Gardening Practices Where Lead is a Concern."
- 6-8 hours of direct sunlight is needed; avoid areas shaded too heavily by buildings

- air pollution is a problem in some urban areas; unusual spots, off-coloring, or lack of growth not due to insects or diseases may be an indication of air pollution damage.
- theft and vandalism is a major concern in some areas. Adequate fencing and a location near people who will be watchful will help considerably. There are also means of hiding or camouflaging ripening fruits, and planting unusual vegetables or odd-colored or strangely-shaped varieties may deter impulsive theft. An article in Horticulture magazine, August 1980, "Foiling the Two-Legged Varmint," discusses these ideas at length.
- consider a container garden where no in-the-ground site is available. Many city dwellers are unable to garden except on balconies and rooftops. See "The Container Garden," page 42.
- when leasing a city lot for gardening, investigate possible development plans for the area. A long-term lease will help guarantee that efforts to improve soil, install watering facilities, erect fences, and plant perennials, will not be in vain.
- check with the local housing authority when searching for a demonstration garden site; churches, schools, and government agencies may all be helpful. Apartment/condominium grounds are another possibility.
- use intensive techniques in city gardens to coax the greatest amounts of produce from small plots.

More information on these topics and ideas for other activities can be found in these publications:

Guide to Community Garden Organization 50¢

Gardens for All
Bay & Harbor Roads
Shelburne, VT 05482

City Green: The Urban Gardening Program in Philadelphia free

Pennsylvania State University
Cooperative Extension Service
Urban Gardening Program
SE Corner Broad & Grange Streets
Philadelphia, PA 19141

Growing With Community Gardening \$6.95

by Mary Lee Coe (order from bookstore)
Countryman Press

SECTION II

THE GARDENS

THE INTENSIVE GARDEN

For the past two years an intensive garden has been in operation at the Horticulture Farm to demonstrate the potential gardening value of a very small growing area. Our garden space is approximately 10' x 22' and is fenced for easy trellising and aesthetic enhancement.

In this garden, various special techniques are practiced to increase yield per square foot: vertical growing, intercropping, succession planting, wide beds, and intensive matrix or equidistant planting, all discussed below. Harvests from the garden are weighed and recorded, and prices of comparable fresh produce are checked at a local grocery store within a few days of harvest in order to assign an economic value to this produce. No attempt is made to do the same for canned, frozen, or dried vegetables, even though there are cases in which there is too much produce from the intensive garden to be used fresh.

To give an idea of the results that can be attained in a small garden: in 1980, the 10' x 20' garden's yields were worth about \$160, or 80¢/square foot. In 1981, the size increased to 11' x 22' by including a foot of space on the outside of the fence; harvests rose to a value of about \$300, or \$1.24/square foot.

In making the most of a small area, the practices outlined below are very helpful.

Vertical growing

Most vining crops can be trellised on a fence or other support. Even melons, except for very large-fruited ones, can be grown this way, provided individual fruits are supported with a sling of scrap cloth or mesh. Many crops are much more productive per square foot of garden space when planted in this manner. They are easier to harvest, and fruits stay drier and are less susceptible to soil-borne insects and diseases. Cucumbers grow straighter and suffer less vine damage from being stepped on. Tomatoes produce abundantly when grown up a fence. They do not need pruning like staked tomatoes and thus have a better foliage cover, and the need for storage space required by wire cages is eliminated. Pole beans produce greater amounts and for a longer period than do bush beans.

Vertical planting involves training plants up a fence, trellis, poles, or inside wire cages. Some must be tied, while others have tendrils which do their own climbing. Extra fertilizer and water may be needed for trellised plants to keep the vines in heavy production.

Intercropping

Intercropping, or companion planting, is planting two or more compatible crops in the same place at the same time. This is accomplished in several ways. For example, seed for a fast-growing and a slow-growing crop are sown at the same time. The traditional example is carrots and radishes: the radishes mark the slow-to-germinate carrot seed until the carrot plants reach a substantial

size. By then the radishes are ready to harvest and room is made for the carrots. Another combination is low-growing (especially shade-loving) plants with taller ones. Lettuce planted under okra is an example.

Succession Planting

To spread harvests throughout the growing season, sowings may be made of a crop every 2-3 weeks. This will prevent all vegetables of a variety from maturing at once, especially useful for lettuce, radishes and other crops that are not generally preserved.

Another method of succession cropping is to sow seed all at once, but use varieties which mature at different rates. This is used for vegetables (and fruits) which have a peak period of harvest before slacking off. Beans, peas and strawberry plants are just a few examples which are productively treated this way.

Finally, succession cropping also refers to filling in spaces left by crops which have come and gone with different crops. A spring harvest (peas, for example) may be followed by a summer crop (squash), which is in turn followed by a fall-winter planting (kale, Chinese cabbage, or a cover crop sown between the rows of squash in late summer). This type of succession requires careful management and timing. Short-season varieties and transplants ready to go into the ground when another crop comes out are crucial.

Wide Beds and Intensive Matrix

Wide beds allow more plants per square foot of garden space because less room is taken up in pathways. A bed is generally 3'-4' wide, so that it is easy to work on from one side or the other without stepping in the growing area. Plants are spaced so that their leaves will barely touch when mature, equidistant from each other within the bed.

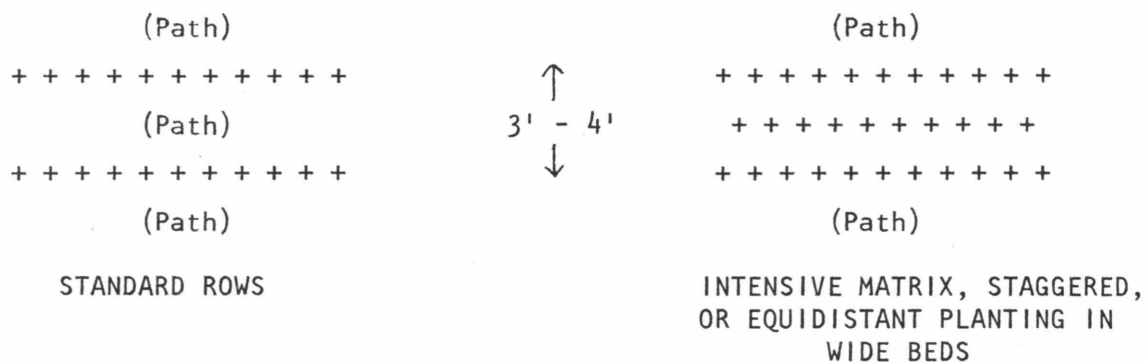

Seed may also be broadcast in wide beds and thinned to approximately equal distances. Soil must be relatively fertile and high in organic matter for this method to work, since there are more plants in the growing area to compete for nutrients. Also see "Gardening in Raised Beds," Appendix C.

Some or all of the techniques described above may be used within an intensive garden. Another good idea is to have 4"-6" plants from a greenhouse or cold frame ready to go into the garden when the preceding crop comes out. Or, seed may be sown beneath plants that are nearly finished bearing, providing care is taken not to uproot young seedlings when pulling up old plants. Dwarf varieties may also be used to save space (see *Miniature Crops*, page 34). Season extenders, such as cold frames, cloches, and others, will also increase yields of a small garden area. Information on these may be found in the section entitled "Special Displays," page 43.

Of all, this type of demonstration garden is the most time-consuming and demanding of staff. Careful planning is necessary to make best use of space, and even then, maturity dates may differ from what is on the seed packet due to the vagaries of weather and cultural practices. If an economic study is being done on the garden, harvesting takes a lot of time, since produce must be weighed and prices checked at the supermarket.

However, an intensive garden offers the best opportunity of all to display gardening methods for small spaces, and even for larger areas which could be more productive.

Other sources of information on intensive gardening include:

"Gardening in a Small Space" slide set

can be borrowed from Horticulture Department Slide
Loan Library

The Postage Stamp Garden Book

by Duane Newcomb
Bantam Books

Getting the Most from Your Garden

Rodale Press

"Intensive Cropping Methods"

Publication 426-335

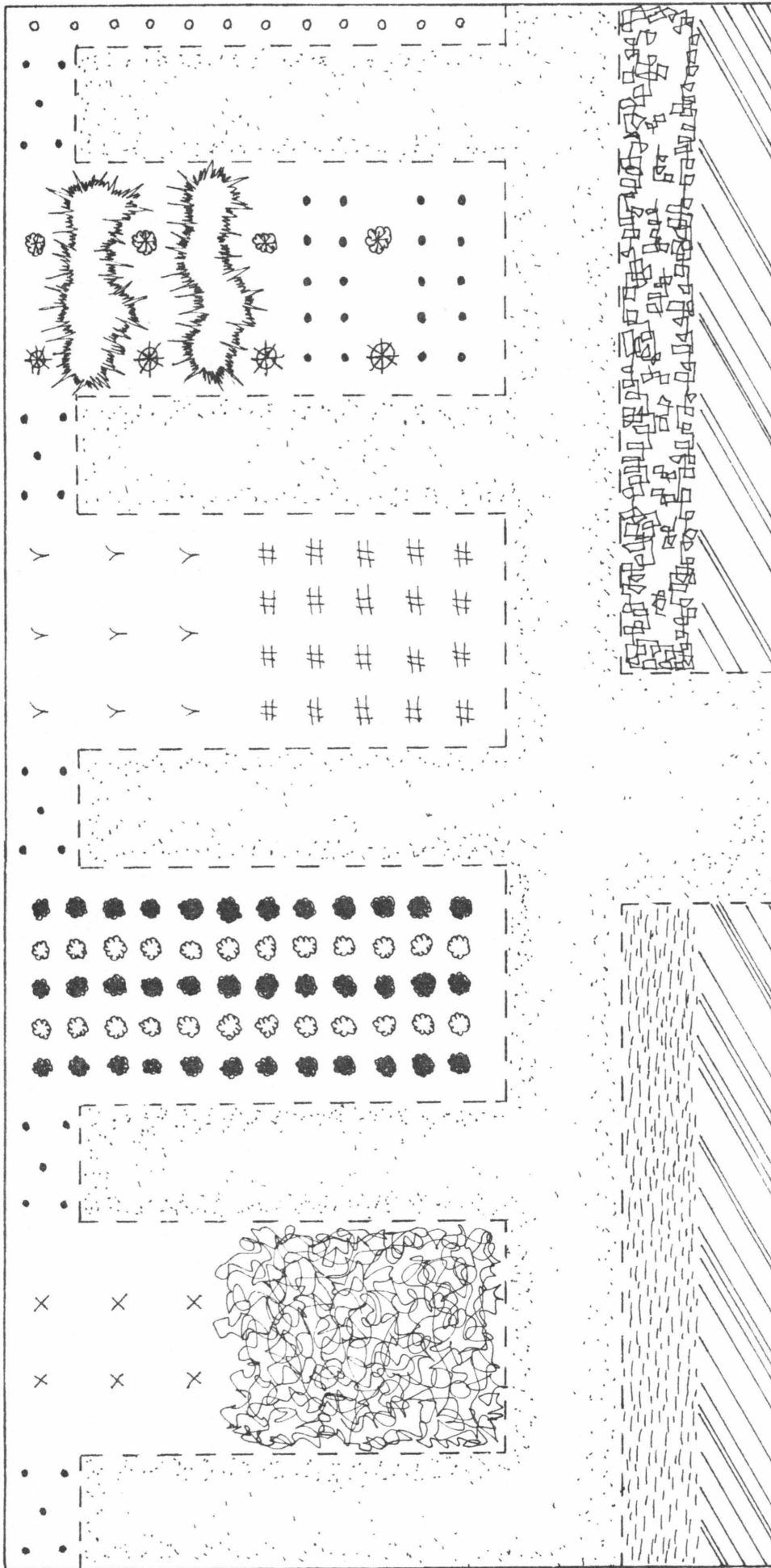

INTENSIVE GARDEN (LATE APRIL / EARLY MAY)

SCALE: 1" = 2'-0"

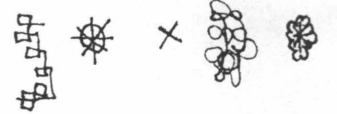

BEETS

BROCCOLI

CABBAGE

CARROTS AND RADISHES

CALLIFLOWER

y KALE

o KCHLRABI

• BIBB LETTUCE

• LETTUCE



ONION

PEAS

SPINACH

SWISS CHARD

TURNIPS

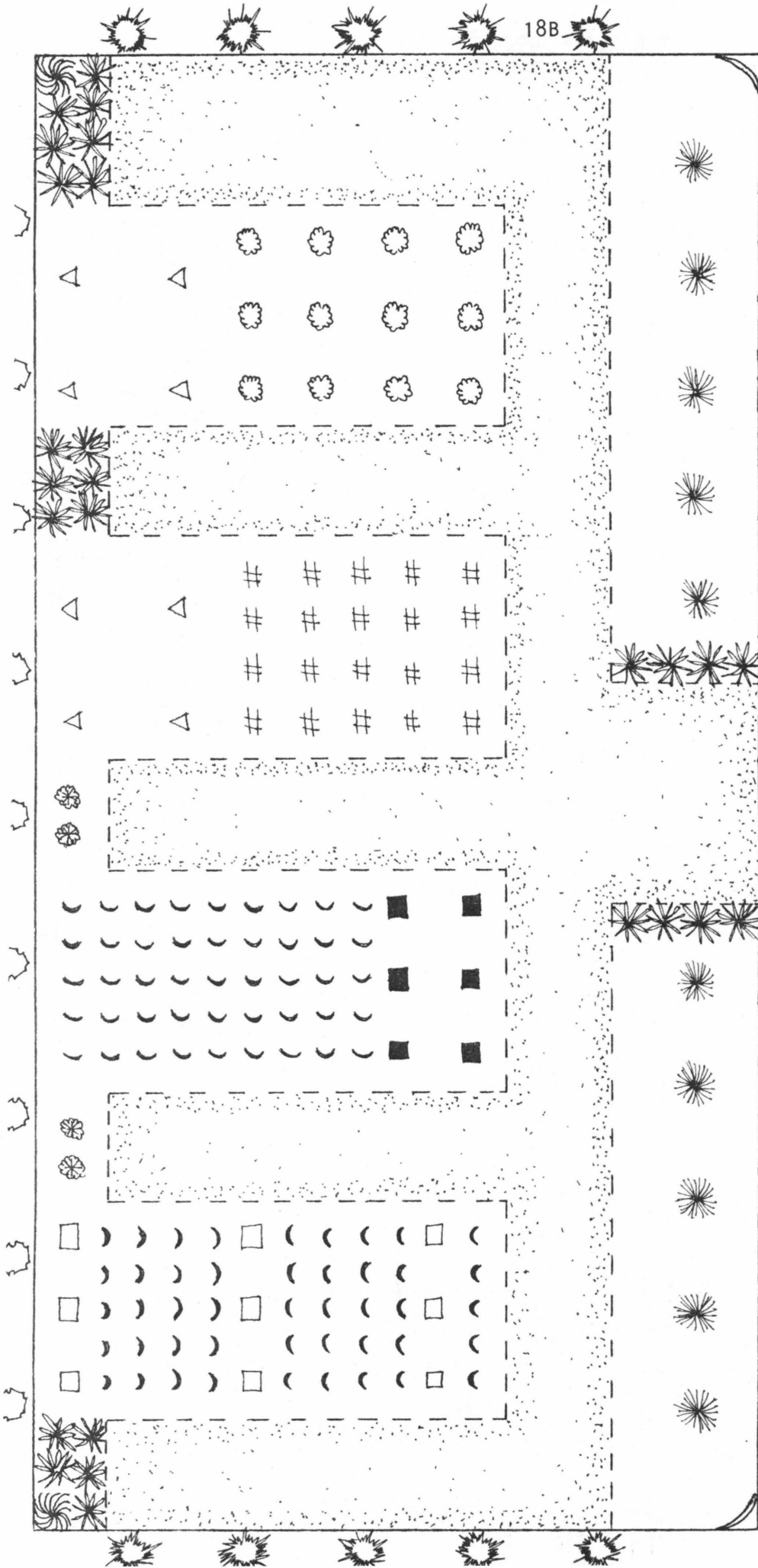

SCALE: 1" = 2'-0"

INTENSIVE GARDEN (MID-JUNE / EARLY-JULY)

- ☐ #1 BLUSH BEANS
- ☐ #2 BLUSH BEANS
- ☐ #3 BLUSH BEANS
- ☐ POLE BEANS
- ☐ CHARD
- △ EGGPLANT
- ☐ FLOWERS
- ☐ OKRA
- ☐ PEPPERS
- ☐ ORNAMENTAL PEPPERS
- ☐ SQUASH
- ☐ SUNFLOWER
- ☐ TOMATOES
- ☐ CANTALOUPE
- ☐ CUCUMBERS

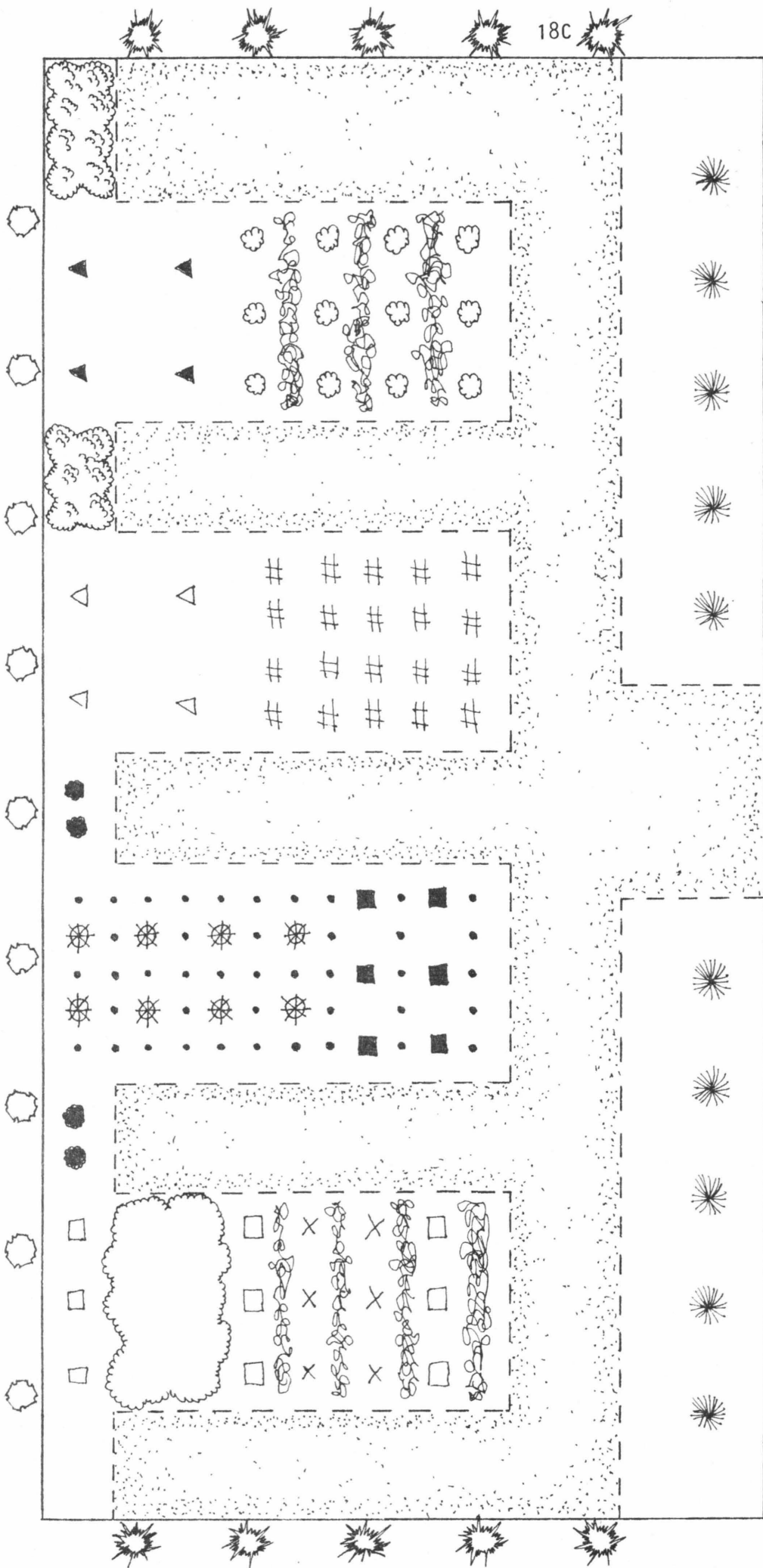

SCALE: 1" = 2'-0"

INTENSIVE GARDEN (MID AUGUST / EARLY SEPTEMBER)

- * BRUSSELS SPROUTS
- X CHINESE CABBAGE
- # CHARD
- ☁ CRESS
- EGGPLANT
- LETTUCE
- OKRA
- ☁ PEPPERS
- ☁ RADISH
- ☁ SPINACH
- YELLOW CROOKNECK SQUASH
- ▲ WINTER SQUASH
- * CANTALOUPE
- ☁ CUCUMBERS
- ☁ TOMATOES
- ☁ TURNIPS

VARIETY DEMONSTRATIONS

Variety demonstrations are not too difficult to do, produce interesting results, and may introduce people to those very new or even very old varieties that they "never had room to try." Trials can be done to observe one quality (fruit size, yield, color) or the general performance of the plants. There may be some surprises! This is the time for reading the small print in the seed catalogs and picking out the obscure varieties that aren't featured with color pictures, as well as the fancy new hybrids.

When doing variety demonstrations, try to have conditions for crops being compared as similar as possible. Soil preparation, watering, mulching, and other practices should be the same for all varieties for the most accurate records. If you're doing the demonstrations in order to gather information on which varieties do well in your area, keep careful records of pests, diseases, and other problems, in addition to harvest records.

In the Variety Demonstration gardens at the VPI & SU Horticulture Farm, tests have been done on tomatoes, lettuce, white radishes, beans and squash. The trials and some highlights of them are described here.

Tomatoes

Six cultivars were grown in a bed, each utilizing the same amount of ground space. Bush (determinate) varieties were allowed to grow as they would. Others were caged.

The basic results of the tests were that the standard varieties produced longer, and their eating and fresh storage qualities were better, than were those of the bush varieties. Therefore, it was concluded that in the same garden space, the standard (indeterminate) varieties were a better choice for home production.

Lettuce

In our variety demonstration bed we tested three crisphead-type lettuces, two butterhead varieties, and two leaf lettuces for heat resistance and eating qualities. The butterheads and leaf types performed pretty much as expected - good eating until June, at which time they turned bitter and some bolted. A notable leaf lettuce is *Crispy Sweet*, which has leaves which are less wavy than most and which is very good-tasting.

The crisphead lettuces were very successful. *Ithaca*, *Great Lakes*, and *Green Lake* were all tried, and despite late planting, hot weather and no rain, all plants formed 1-3 pound market-quality heads with good flavor. One three-pound head of *Great Lakes* harvested on July 5 was still good to eat, according to Charlie O'Dell, Commercial Vegetable Specialist (who took it home). *Iceberg* is the cultivar of crisphead lettuce most commonly sold in catalogs and as bedding plants, but most gardeners who have tried it are convinced that crisphead lettuce won't grow in Virginia, since *Iceberg* has a tendency to bolt early in the summer.

Varieties used: (a) Crisphead - *Green Lake, Great Lakes, Ithaca*;
 (b) Butterhead - *Patience, Butter King*; (c) Leaf - *Crispy Sweet, Slo-Bolt*

Seed availability: *Patience* is the only variety not available from major seed companies; it came from Epicure Seeds

Radishes

As space-fillers between lettuce, the white radishes, *White Icicle* and *Tokinashi Daikon* were tested. Both are sold as "all-season" radishes, and are long, white types. Soil must be prepared deeply, as these radishes can grow to one foot long. They both grew well until June, at which time they started turning bitter and became infested with root maggots. Both were quite "hot" when the weather was warm, and might not be acceptable to many people for salads. However, despite the "all-season" designation by some seedhouses, *Daikon* radishes should be grown as winter radishes, according to other sources, and are generally eaten raw, pickled, or cooked in stir-fry dishes. Cool-weather use only is also suggested for *White Icicle*.

Seed availability: *White Icicle* may be obtained from most seed companies. *Daikon* radishes are also widely available, but may be listed as winter radishes, Chinese or White Chinese, or White Celestial radishes

Beans

Small beds of five different bush snap beans were tested for productivity and flavor. Two were new varieties sent by Oregon State University for testing as processing beans. Despite resistance in Oregon, these were susceptible to local strains of rust and mosaic. The other three varieties did not develop severe disease problems even though they were planted next to the Oregon beans. Harvests were weighed and all beans were tasted fresh and canned. *Gator Green* was found to be outstanding in all qualities.

Varieties used: *Oregon 43, Oregon 55, Gator Green, Speculator, and Honey Gold*

Seed availability: All except the Oregon beans were donated by Stokes Seed Company

Squash

Since 1981 was the Year of the Squash, we tested the varieties which were also being tried by the home garden cooperators throughout the state - *Gold Rush* zucchini type and *Jersey Golden Acorn*. Squash were picked small when possible and samples were weighed for an estimate of productivity. Taste tests by a number of people resulted in varied opinions on the acorn squash and a generally favorable reaction to *Gold Rush*, which is also highly productive.

Seed availability: Both squash are generally available now.

PLOT PLANS FOR MINIATURE VARIETIES, UNUSUAL VEGETABLES, AND VARIETY DEMONSTRATIONS WERE EACH DIVIDED INTO THREE SECTIONS BECAUSE OF THEIR UNUSUAL WIDTH:LENGTH ($3\frac{1}{2}' : 33'$)

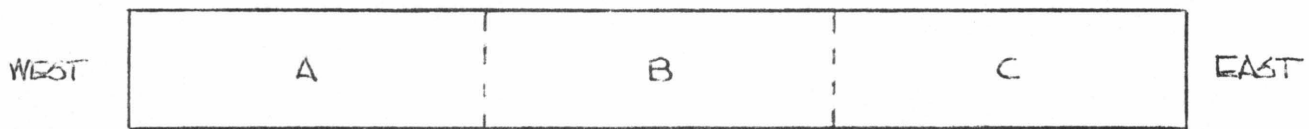

IS ILLUSTRATED AS:

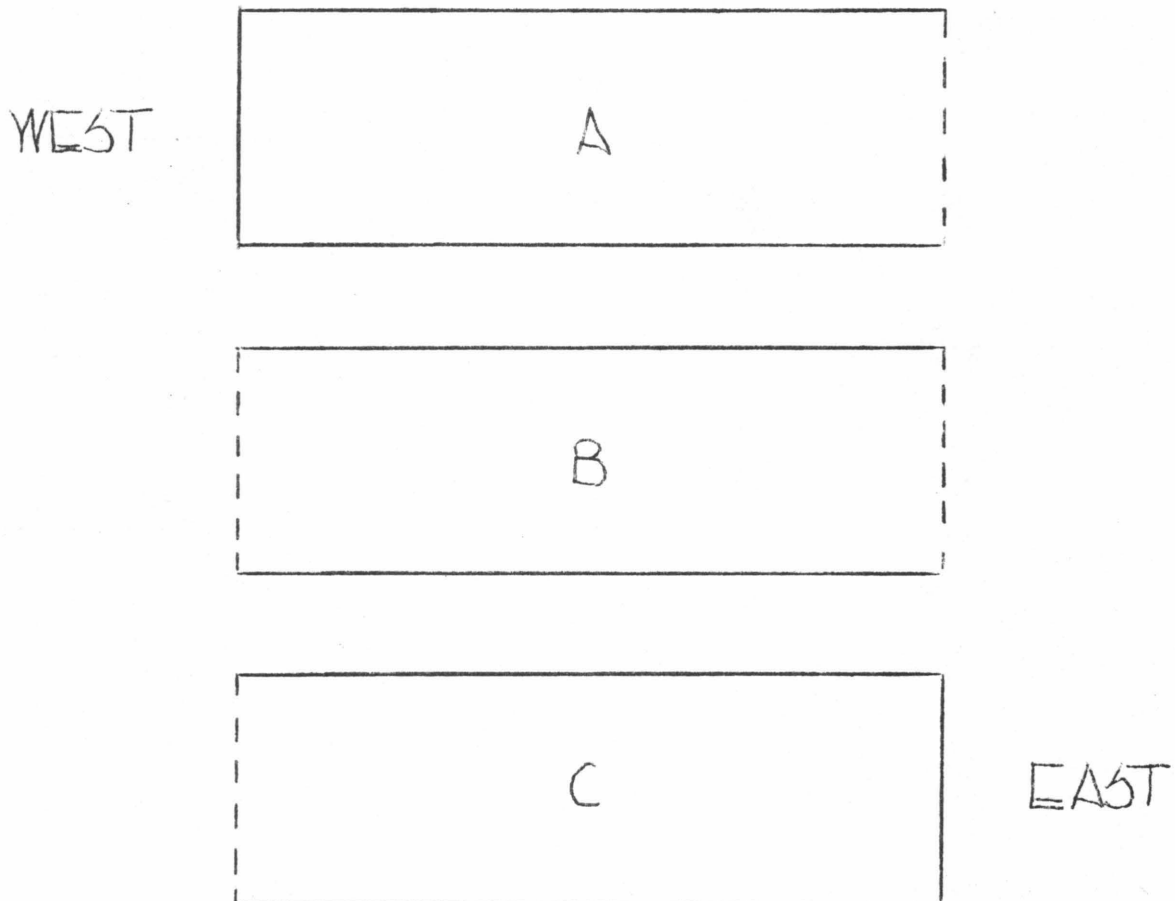

VARIETY DEMONSTRATIONS

20B

(MAY - LATE JUNE) Fig.

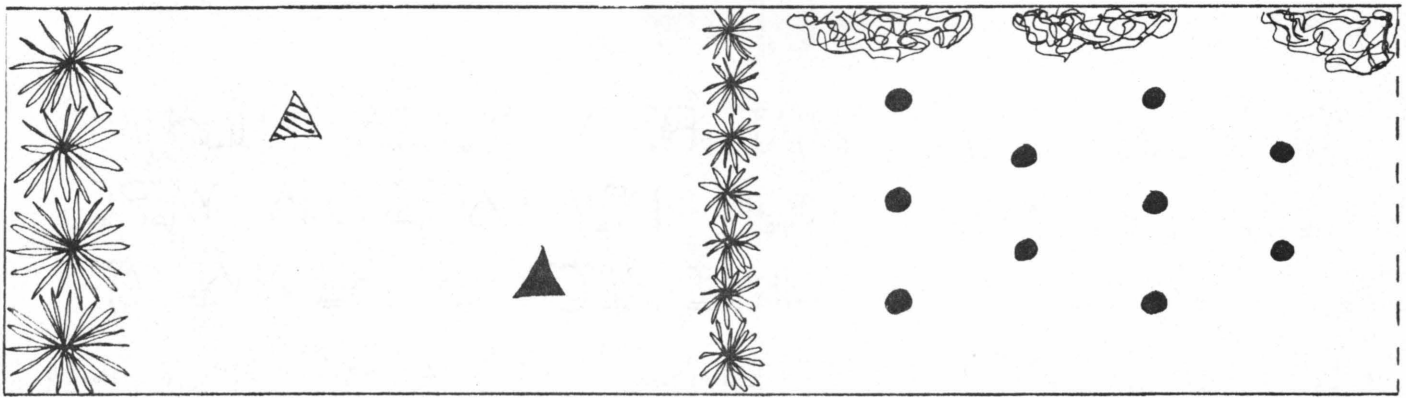

SCALE: 1" = 1' - 6"

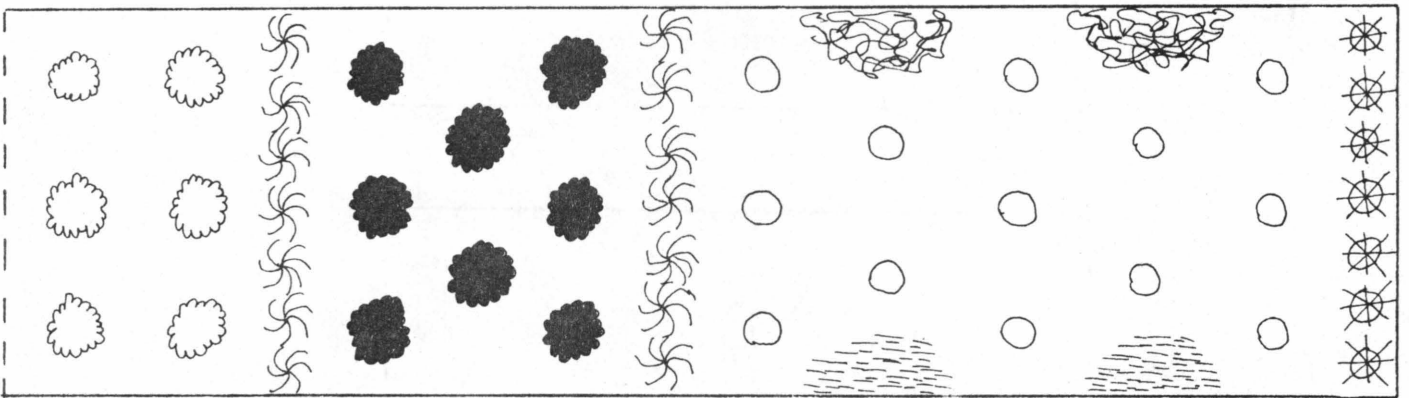
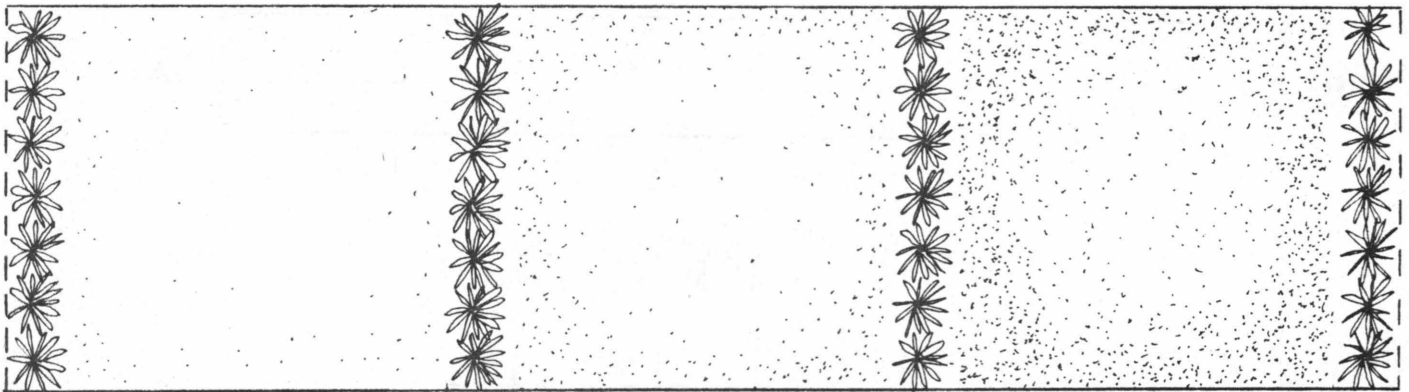

- EARLY HEAD LETTUCE ('ITHACA', 'GREEN LAKE', 'GREAT LAKES')
- LATE HEAD LETTUCE ('GREAT LAKES', 'ITHACA')
- ☼ 'BUTTER KING' BUTTERHEADS
- 'PATIENCE' BUTTERHEADS
- ☼ COCKSCOMB
- ⋯ 'MONTELLO' LETTUCE
- ⋯ 'SLO BOLT' LETTUCE
- ⊠ 'CRISPY SWEET' LETTUCE
- ✱ MARIGOLDS
- ✱ 'MERRYUM' MARIGOLDS
- ⊙ 'DAIKON' RADISHES
- ⊙ 'WHITE ICICLE' RADISHES
- ▲ 'GOLD RUSH' EARLY SQUASH
- △ 'JERSEY GOLDEN ACORN' EARLY SQUASH
- ✱ 'TOM THUMB' ZINNIAS

VARIETY DEMONSTRATIONS

20C

(LATE JUNE - LATE SUMMER)

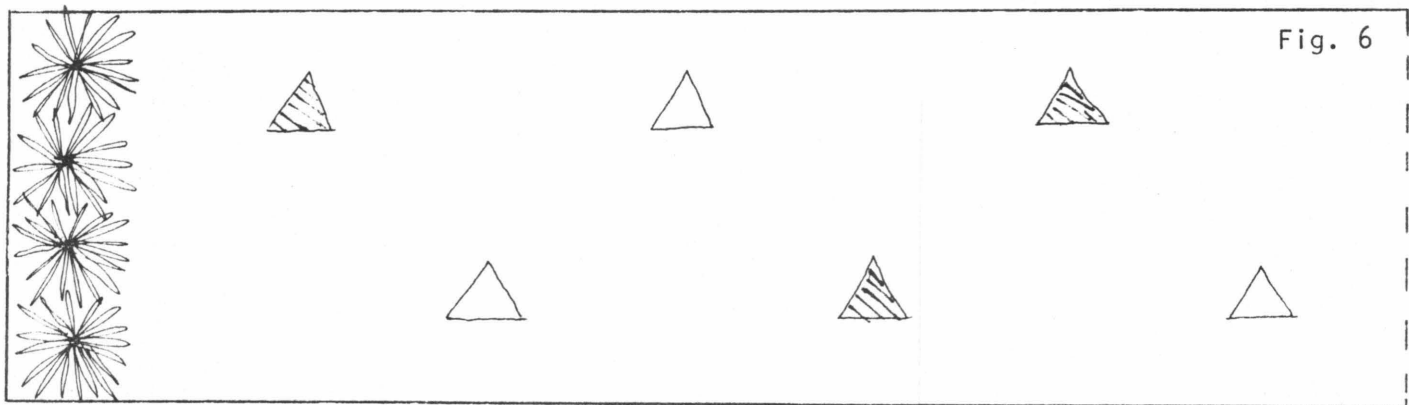
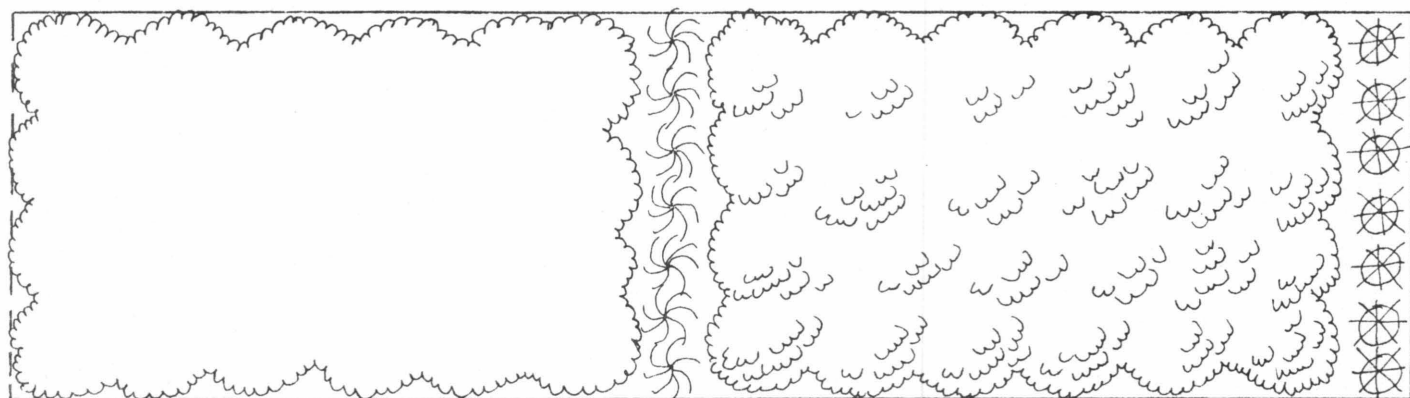
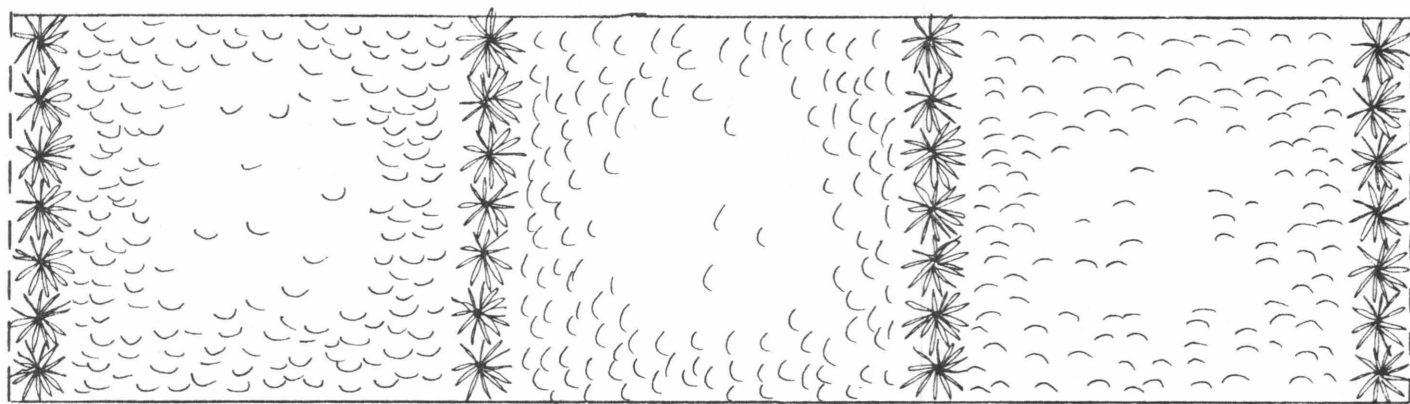

Fig. 6

SCALE: 1" = 1' - 6"



- | | | | |
|--|---------------------|--|------------------------------|
| | 'SPECULATOR' BEANS | | MARIGOLDS |
| | 'HONEY GOLD' BEANS | | 'MERRYMUM' MARIGOLDS |
| | 'GATOR GREEN' BEANS | | 'GOLD RUSH HYBRID' SQUASH |
| | 'OREGON 55' BEANS | | 'JERSEY GOLDEN ACORN' SQUASH |
| | 'OREGON 43' BEANS | | 'TOM THUMB' ZINNIAS |
| | COCKSCOMB | | |

UNUSUAL VEGETABLES

This is a garden you can have a lot of fun with. It's also one that you have to be prepared for, since many of the vegetables have different requirements than commonly grown types. Seed are often hard to come by - some of ours had to be ordered two or three times because companies had run out of their supply.

Visitors find the Unusual Vegetables bed among the most interesting and have a lot of questions about the crops being grown. Choosing vegetables for it is part of the enjoyment. Have a wide variety of seed catalogs available - addresses are given in Appendix G for companies you may not usually deal with, as well as major companies. Some of the catalogs are quite informative; others are only lists of seeds.

Since information on unusual vegetables is scattered and hard to find, this section includes a description of vegetables tried in the 1980 and 1981 Unusual Vegetables beds at the Horticulture Farm. Even if you do not have a demonstration of unusual crops, this material may be helpful for answering questions from adventurous home gardeners.

Amaranth, Vegetable - New gardeners may find themselves unpleasantly surprised by the hidden spines of a common, obnoxious garden weed. Spiny amaranth can be quite a pest, so it's no wonder that its close relative, vegetable amaranth, has been slow to gain favor. However, new varieties of this plant that are both attractive and delicious, as well as heat- and drought-resistant, have been developed, and the high-protein, spinach-like leaves are worth a try. Amaranth is best started indoors because of its very tiny seed and the tendency toward slow growth in cool weather. It can also be sown outdoors for succession crops, but seed must be kept moist. Amaranth may be harvested all at once, like spinach, or a few leaves at a time; plants will, in any case, eventually decline, and a new crop will be needed for a steady supply through the summer.

Varieties used: White stem, Red leaf and stem, and Tiger leaf
 Seed availability: Test seed may be obtained from the
 Organic Gardening and Farming Research Center, R. D. 1,
 Kutztown, PA 19530. Burgess and Burpee list amaranth
 as "Tampala," and it may also be called "Chinese spinach."

Armenian cucumber - see *Cucumber, Armenian*

Artichoke, Globe - This plant has very exacting requirements and is not for the less-than-dedicated amateur, but for someone willing to take care of its needs, the globe artichoke is very rewarding and ornamental. This tender perennial grows best in an area with cool, moist summers and winters without extremely cold temperatures. If an artichoke bud forms during very hot weather, it will be tough and woody; hard freezes, though, will reduce the crowns to mush. Since it is difficult, but not impossible, to get buds the first year, it is usually necessary to overwinter the crowns (see publication 426-444 for instructions). The globe artichoke plant looks like a thistle, to which it is related, and takes a 3' square area in the garden. Refer to the publication mentioned above for cultural details.

Varieties: Green Globe, Grande Buerre, Early Green Provence
Seed/Crown Availability: Green Globe is available from many seed companies, but is not as likely to produce first-year buds as Grande Buerre (Thompson & Morgan) or Early Green Provence (J. L. Hudson). Crowns are available from Gurney.

Artichoke, Jerusalem - Not really an artichoke at all, this is a native sunflower which produces tubers which are said to be a starchless substitute for potatoes, but "Sunchokes" are better regarded for their own virtues. Because they grow 6'-7' tall, plant Jerusalem artichokes where they will not compete with less vigorous vegetables. Plant tubers or parts of tubers with eyes, 2"-3" deep, water in, and then wait until harvest time - after frost, that is. In the meantime, the plants will grow, flower and die back. Cut off and dispose of the woody stalks and dig tubers as needed as long as the ground stays soft enough. They do not store well indoors, even in the crisper compartment of a refrigerator. But BEWARE! If you do not get all the tubers, they can become a nuisance, because each "eye" will sprout with the coming of Spring. If you have an area where they can be grown year after year, undisturbed, you can just dig as many as you want to eat and leave the rest for next year's crop. The major pests of Jerusalem artichoke seem to be aphids on the stems, but they do not appear to significantly reduce yields.

Seed tuber availability: Seed companies were all out of their supply, so "Sunchokes" were purchased at a local grocery store, cut up like seed potatoes, and planted. This worked very well.

Beans, Black Turtle - These beans have been used in soups usually only found in "heath food" restaurants in this part of the country, but they are gaining in popularity. Grown like any other dry bush bean, black turtle beans surprised us with pleasant, light purple flowers which were very ornamental. Since our plants were very susceptible to bean rust, it is recommended that they be given a very open area in which to grow, where the sun will dry the leaves early in the morning. Plants should never be worked on when wet. There were also the usual bean pests, but a reasonable harvest was obtained.

Seed availability: J. L. Hudson, Johnny's Selected Seeds, Vermont Bean Seed Co., and Gurney.

Belgian Endive - see *Chicory, Witloof*

Black Turtle Beans - see *Beans, Black Turtle*

Bok Choy - This is a cool-weather crop which may be grown both in spring and fall. It is one of the Asian brassicas, and is often called Chinese cabbage, but it is grown more for the stems than for the leaves (see also Chinese cabbage and Michihli). Bok Choy's flavor is milder and sweeter than that of cabbage. It is excellent raw or cooked, especially stir-fried. Culture is pretty much the same as for other cabbage family plants, but Bok Choy has the advantage of a very short (45-day) growing season. Insect and disease problems are the same as for other brassicas. Bok Choy does not transplant well, though, tending to go to seed after being disturbed, so seed should be sown directly or entire peat pots transplanted.

Seed availability: Now available from most seed companies.

May also be called Pak Choi, celery cabbage, Chinese celery, Pe-Tsai, or Pei Tsai.

Cardoon - This plant takes a lot of room - about four feet square - but it is highly attractive and unusual. A member of the thistle family, like the globe artichoke, cardoon is grown for its stems rather than its buds. There seems to be some argument as to the proper harvest time; one authority says to harvest when they are 12"-24" tall, another says in the fall, after blanching the stalks for a month with straw, burlap or heavy brown paper. Or, the whole plant may be dug, roots and all, and stored in sand or earth in a cellar or shed where temperatures are over 40°. No matter when it's done, the stalks are broken off at the base and all leaves removed (they are bitter), then the stalks are cooked according to recipe. Even if not eaten, however, this is a very ornamental plant and worth a spot in the garden.

Seed availability: Comstock, Ferre, & Morse, Gurney, J. L. Hudson, Le Jardin du Gourmet, and Shumway.

Celery Cabbage - see *Bok Choy*

Chick Peas - see *Garbanzos*

Chicory, Witloof - Visitors to the 1981 Demonstration Gardens at the Horticulture Farm probably thought our weeding efforts had failed when they saw this plant. Witloof chicory bears a strong resemblance to a healthy dandelion, but this lowly-looking plant is highly prized by gourmets when its roots are dug and brought indoors to be "forced" to produce delicate, blanched heads known as "*chicons*".

Seed is sown outdoors in June, thinned to 6" apart, and the plants are allowed to grow until after frost, but before the ground freezes; at this time the roots are dug and the tops trimmed back to 2". The roots should be stored horizontally in barely moist sand for about a month, then prepared for forcing by cutting off the tips of the roots so that all are of even length. Then set the roots close together in a box at least 12"

deep, with a 6" layer of damp sand, loam, or a mixture of sand and peat. Thoroughly water, then cover the crowns with coarse, dry sand, about 6". This layer will blanch the leaves as they sprout, but if water is needed, add it through holes poked in the sand, since the heads or crowns may rot if this layer is wet. (Another suggestion is to forget about the layer of sand and just use a box on top to exclude light.) Place the box in a dark, warm place (at least 50°) and check 2-3 weeks later to see if sprouts are poking through. Harvest when heads, or *chicons*, are 5"-8" long. If they are too small, or not needed at the time, add more sand to keep the tips bleached. Harvest by breaking or twisting off the heads about ½" above the crown. Tamp down the sand and wait for another crop. Use the *chicons* in salads or in special recipes found in cookbooks for European-style foods.

Seed availability: from most seed catalogs, under chicory, Belgian endive, French endive, or witloof chicory; Thompson & Morgan has a variety, "Snowflake," which does not have to be forced

Chinese Bitter Melon - see *Melon, Chinese Bitter*

Chinese Cabbage - The true Chinese cabbage looks somewhat like an elongated savoy cabbage. It, too, has a mild flavor, but its growing season is longer than that of Bok Choy - 75 days. Culture is the same as for other brassicas. See also *Michihli* and *Bok Choy*.

Seed availability: from many seed companies. May be called Siew Choy, Wong Bok, or Nagaoka. Some catalogs call Michihli Chinese cabbage, but the two are a little different.

Chives, Garlic - In a small extra space we planted garlic chives, since they are relatively unknown. As the name implies, these chives taste more like mild garlic than onion. Their flattened leaves are the only difference in appearance from regular chives, and the culture and uses of garlic chives are the same.

Seed availability: most seed catalogs have them; they may be called Chinese chives.

Coriander - Another herb grown in a tiny space in the Unusual Vegetables bed. Coriander is grown mostly for its seed in this country, but the Chinese and Mexicans commonly use the leaves like parsley, chopped and sprinkled over carrots, for example, or in tacos. Coriander is easy to grow, and after enough fresh leaves are used, may be allowed to go to seed for grinding and using in baked goods.

Seed availability: Most catalogs with a good herb selection have coriander, which may also be called Chinese or Mexican parsley, or cilantro.

Corn, Pickling - Those baby ears in Chinese dishes, at salad bars, and in little jars on the grocery store shelf for \$1.89 have been a source of fascination and curiosity, so we decided to try growing some. It wasn't that easy. Numerous telephone calls, letters, and visits resulted in a lot of opinions, but no definite answers, about what kind of corn to grow. Most agreed that it was immature corn, but whether certain varieties were better than others was still in doubt. Park Seed had "Candystick," which boasted a mere $\frac{1}{4}$ " diameter cob at maturity, so this was the chosen cultivar. A very small patch (4'x4') was planted in the Unusual Vegetables garden, and samples were taken at various stages of development. Just when the tassels started turning red (not brown) seemed to be the best size; even immature "Candystick" had a good amount of sweetness, so it would probably be acceptable for pickling. Other varieties (in other gardens) had cobs too large even when quite immature.

Unfortunately, our patch was too small to get a number of ears at once, so there were never enough to can. No recipe for pickling baby corn was found, either, other than a jar label which said, "corn, water, vinegar, and salt," so some experimentation will need to be done in that area.

Seed availability: Park Seed is the only source of "Candystick" we could find. Other miniature varieties might be just as suitable.

Cucumber, Armenian - A novelty item that is also useful, the Armenian cucumber is very unusual in appearance. A sample was sent to our office last year, and no one could identify it, but when we later found out what the strange-looking cucumber was, we decided to try it. Unfortunately, the seed arrived late, germination was poor, and cucumber beetles destroyed the tiny seedlings that did come up. (Maybe next year.)

This cucumber must be trellised for straight fruit, since they can be up to three feet long. The skin is light green with thick ribs, and the flavor is comparable to that of other cucumbers. Culture is the same as for other cucumbers, and the fruit may be used in the same way.

Seed availability: Gurney's has Armenian cucumbers, but calls them Yard-long cucumbers. Other Yard-long cucumbers are available, but may not be the same.

Edible Soybeans - see *Soybeans, Edible*

Eggplant, Italian and Japanese - There are a number of odd eggplants which can be grown in an Unusual Vegetables garden. We tried two of them; the Italian was a variety which looked very similar to an ordinary eggplant except that the skin remained white where not exposed to sunlight. The Japanese one was a long, thin type. Both were excellent and culture was like that of any other eggplant.

Varieties used: "Melanzana" (from Epicure Seeds) and "Millionaire Hybrid" (from Kitazawa Seed Co.). Suggested - "Oriental Eggplant," a small white, then yellow variety (from Thompson & Morgan - order early!)

Seed availability: unusual eggplants may be obtained from the above-named companies and many others

Elephant Garlic - see *Garlic, Elephant*

Fennel, Florence - Fennel is usually thought of as an herb, but those bred for large, bulbous stems or bases can be used like a vegetable. There are three types; look for *finocchio* when purchasing seed for the vegetable type.

Seeding was tried at different times in the Demonstration Garden. In April, seeds were started in the greenhouse and the plants were set out in May. These produced tender bulbs by July, and those not harvested went to seed in late July. Other seed was sown in early May, directly in the bed. Plants did not develop the desired 2"-3" bases until about September; some were stringier and tougher than the July-harvested bulbs, probably due to heat and drought. Cooler weather is undoubtedly needed for tender bulbs, so seed should be sown later, perhaps in June or July, for a fall crop. Also, some sources suggest blanching the bases like celery for tenderness and a more delicate flavor. The flavor of fennel is that of mild licorice, with a texture similar to an artichoke heart. Fennel growing is relatively trouble-free, with parsleyworm being the only insect pest noticed.

Variety used: Mammoth

Seed availability: most seed companies have finocchio

Finocchio - see *Fennel, Florence*

Florence Fennel - see *Fennel, Florence*

Garbanzos - Another popular salad bar item, garbanzos are also a delicious addition to soups. They grow in a similar manner to bush beans, but their leaves are "fernny," and they are not, in fact, true beans or peas. Plant thickly and in large numbers, because plants produce only one or two seeds per pod. Do not overwater or mulch too heavily. Garbanzos are originally from arid and semiarid regions and their seeds and roots have a tendency to rot in heavy, moist soil. Seeds may be harvested and used green or allowed to dry on the vine.

Seed availability: Most seed catalogs have them, some under

Chick Peas

Garlic Chives - see *Chives, Garlic*

Garlic, Elephant - This mild form of garlic produces five huge cloves from each clove you plant; the leaves may grow so tall as to be mistaken for a small corn plant. Culture is like that for garlic. Plant individual cloves about an inch deep in a rich, loose soil. Do not mulch too heavily or bulbs will rot; deep cultivation may damage bulbs. Cut back flowers if they develop. When the tops fall over, lift the bulbs and allow to cure in a warm, dry place for several days, then store like onions. Use as you would use garlic, but if a heavy garlic flavor is desired, you'll need more, since elephant garlic is not strong. Presumably, elephant garlic should keep the larger vampires away from your home.

Seed bulb availability: most companies now carry elephant garlic, but order early - they run out fast, and those sent late in the season may be moldy or otherwise of low quality. Burpee ships only in the fall.

Globe Artichoke - see *Artichoke, Globe*

Ground Cherry - This plant is very similar in growth habit to the *Tomatillo*, both having a husk surrounding the fruit. Culture for the two plants is nearly the same as for tomatoes, with seed started indoors and plants set out after danger of frost has passed. Ground cherries are harvested after the husk turns brown and the fruits turn yellow and begin to drop off. They are used in pies and preserves. Related to the Chinese lantern, these plants are ornamental; however, they may "escape" and become almost a weed, so plant ground cherries in a patch where you don't mind their regrowth.

The Latin name for Ground Cherry is *Physalis pruinosa*. There may be some confusion with cape gooseberry, and in some cases ground cherry may be called dwarf cape gooseberry, but they are different plants. Also see *Tomatillo*.

Seed availability: Not too difficult to find. Gurney's, Burgess, Henry Field, J. L. Hudson, Earl May, Shumway, Exotica, and Thompson & Morgan offer seed; however, the array of names given to it is confusing - ground cherry, golden berry, husk tomato, strawberry tomato, or dwarf cape gooseberry are a few.

Husk Tomato - see *Ground Cherry*

Italian Eggplant - see *Eggplant, Italian and Japanese*

Japanese Eggplant - see *Eggplant, Italian and Japanese*

Jerusalem Artichoke - see *Artichoke, Jerusalem*

Jicama (pronounced *hee-kah'-ma*) - This is a strange one. Our test of jicama was spurred by a request for information on this plant, which looked very interesting. This legume is grown for its roots, which may be used like water-chestnuts. If allowed to develop, the bean pods may be eaten when very small, but mature beans are toxic, and it's better to pinch off the flowers to encourage root development. Start plants early in the greenhouse, since a five-month growing season is the minimum requirement for good-sized roots. The plants are set out after the last frost, and it's preferable to trellis the vines, keeping them pinched back to about three feet. Dig the roots before heavy frost. They have a crisp, sweet taste. Because we had to re-order seed and so planted them out late, only one root was large enough to eat. It was delicious, though, and highly recommended!

Seed availability: Jicama is available from Thompson & Morgan (they call it Waterchestnut), J. L. Hudson, Exotica Seed Co., Hastings, Gurney, and Park.

Leeks - Leeks are members of the Allium group which are not that unusual, but which are rarely grown here. Their culture is not as difficult as some believe. Seed are sown in spring, and the plants grow without much assistance until winter, when they are harvested. The only cultural difference from growing other members of the onion family from seed is that the stalks are blanched as the leeks grow. Commonly, they are sown in a 4" deep trench which is filled in as the plants grow. We are attempting to grow leeks broadcast, with sawdust and leaves added to blanch the lower part of the leaf bases. Leeks may be used from the time they reach maturity (150-190 days) through the winter until they begin to bolt, and if protected may be left in the ground until time to use them.

Seed availability: from most seed catalogs

Luffa - Luffa gourd, or vegetable sponge, may be grown both as an edible squash (eaten when small, up to 6" long) and as a useful household product. The mature gourd has a strong, fibrous "pulp" covered by a thin, tough skin which is removed after harvest. Luffas are grown like other vining squash, best started indoors and then trellised on a high (6') cage or fence. Small luffas are harvested like summer squash, and those which are left to mature for sponges should stay on the vine until the skin starts turning yellow-brown (the greener they are when harvested, the softer the sponges; but if harvested too soon, the skin won't come off). Dry the gourds two weeks, cut off the ends and shake out the seeds. Soak the sponges for three or four days, changing water daily to prevent molding, then peel off the skin. If it is difficult to peel, soak longer. Allow peeled luffas to dry in the sun. They may be immersed in a bleach solution and re-dried if a whiter sponge is desired.

Luffa sponges are used to smooth rough skin and stimulate circulation. They are also the world's best back-scratchers! Luffas are great for scrubbing pots and pans and other surfaces. One gardener with too many luffas suggested tying one to the end

of a garden hose for use as a water breaker.

Seed availability: Most seed companies now carry luffa seeds; may be listed under "vegetable sponge" or with exotic plants.

Melon, Chinese Bitter - This is a very unusual plant, attracting a great deal of attention. It is grown like a vining squash, preferably caged or trellised, and has interesting foliage, flowers and fruit (what more could you ask?). There is some debate as to whether the fruit is edible, but it is highly ornamental. The outer rind is warty, the pulp is white, turning yellow, and the seeds are bright red when mature.

Seed availability: Park Seed and probably some of the more exotic catalogs

Michihli - Even more elongated than Chinese cabbage, but similar in appearance, Michihli has a somewhat stronger flavor. Its culture and growing season are about the same as Chinese cabbage as well. See *Chinese Cabbage* and *Bok Choy*.

Seed availability: From many seed catalogs; may be called Chihli, Green Chinese Cabbage, or Ching Siew Choy.

Onion, Storage - Onions are not unusual, of course, but this one is a little special. The cultivar *Spartan Sleeper* remains dormant (under proper storage conditions) for up to 16 months. Tests at Michigan State University showed that *Spartan Sleeper* had much lower percentage of sprouting and shrinkage than two standard storage varieties. Stored at temperatures between 35° and 70°, none of the *Sleepers* had sprouted by March 1, and only 41% had sprouted by July 1, although 73% and 75% of the two other tested varieties had sprouted by then.

Grown like any other onion, *Spartan Sleeper* will produce full-sized bulbs in a season from seed sown outdoors in Spring. Sets are available, but are expensive. This onion is comparable in appearance and taste to other onions.

Seed availability: Thompson & Morgan has seed and sets; Park and some other major companies have seed.

Pak Choi - see *Bok Choy*

Parsnips - Depending on your area, this may or may not be an unusual vegetable. However, many people have tasted only parsnips that have grown too large because most seed companies indicate that they should be sown in early spring. Since growing to maturity takes about 3½ months, if planted in March or April, parsnips are ready to eat in June, July, or August at the latest. That leaves two or more months until frost, after which parsnips are best harvested. During those two months, the sugar changes to

starch, apparently, and by October, parsnips are tasteless if edible at all. To prevent this from happening, sow seed in May or June. Keeping seeds moist may be a problem, since they are small and slow to germinate, so cover with sawdust or other light material, or use the old-timer's trick of laying a board over the bed (remove as soon as the seeds germinate, of course.)

Parsnips are quite hardy and will continue to grow slowly for some time after frost, until a really hard freeze kills the tops back. They can be dug any time until they start to sprout again in early Spring.

Seed availability: most seed companies have parsnip seed.

Epicure Seed has some varieties other than Hollow Crown.

Peas, Sugar Snap - Though these are rapidly moving out of the "unusual" category, many gardeners still have not tried *Sugar Snaps*. Tall trellises must be provided - they may grow to seven feet - and the peas should be planted early to get a good crop. Culture is the same as for other peas. *Sugar Snaps* are delicious raw (children will eat them like candy!) or cooked.

Seed availability: most seed companies now have *Sugar Snaps*.

Pickling Corn - see *Corn, Pickling*

Popcorn - Grown just like sweet corn, popcorn is one vegetable many gardeners haven't tried. Popcorn should be planted a good distance from sweet corn to prevent cross-pollination, and preferably should pollinate at a different time. Allow ears to dry on the stalk, then cure in a dry place for three weeks. When twisted "aggressively" (as Burpee puts it) the kernels should come off the ears easily. Store in containers several weeks before using to equalize moisture content of kernels.

Seed availability: from most seed companies. White, yellow, and red varieties are available. The "Strawberry" type is especially ornamental.

Rocket - see *Roquette*

Roquette - A leafy green, to be used in salads or cooked like (and with) other greens, roquette is best grown in cool weather. Our seed arrived late and, though shaded, had a very strong flavor and went to seed quickly. The flavor during the summer is reminiscent of the way a skunk smells, but the few plants left over in the fall had a much more subdued taste, and might be considered merely "pungent." People of southern Europe have eaten roquette since ancient times, perhaps because of its reputed aphrodisiac qualities. Culture is like that of spinach.

Seed availability: from many seed companies; may be called rucola, arugula, garden rocket or rocket salad.

Salsify - Salsify has a culture similar to that of parsnips (page 29). The same rules may apply, except the growing season of salsify is longer - about four months - so plant in May. Resist the temptation to "weed out" its grass-like leaves when plants are young! Salsify is known as "vegetable oyster" or "oyster plant" because of its mildly oyster-like flavor. The black-skinned *Scorzonera* is similar, but reputedly of better flavor, with culture the same as that of salsify. It is available in gourmet seed catalogs.

Dig roots as needed after frost and until Spring as long as ground is soft. Indoor storage qualities are poor.

Variety Used: Sandwich Island

Seed Availability: Sandwich Island is available from most seed companies. *Scorzonera* can be purchased from Gurney's, Thompson & Morgan, and Epicure Seed.

Scorzonera - see *Salsify*

Shallots - These small, mild members of the onion family grow well from cloves planted in spring. Care must be taken not to plant too deeply or mulch too heavily, as shallots rot easily. They prefer to develop somewhat above-ground, so cloves are only buried to about half their depth. A light, dry mulch of straw or undecomposed leaves will keep some moisture in and weeds down. Culture is otherwise similar to that of onions. Shallots are used like onions, but have a subtler flavor; they are excellent in eggs, for example.

Seed clove availability: from most mail-order catalogs; a giant variety is available from some sources, and Thompson & Morgan have red shallots

Soybeans, Edible - All soybeans are edible, but some are better for human consumption than others. Many people do not know that soybeans may be eaten green, like limas, as well as dried. They are grown like any other bean, but some varieties require a long growing season to mature. Soybeans are high in protein, and are an excellent choice for vegetarians. They may be eaten raw or cooked, roasted, ground and used like coffee, canned, or dried. There is even a snack called "soy nuts." Tofu, popular in health food and other circles, is a curd made from soy "milk," just like a cheese. It can be added to salads, soups or stir-fry dishes.

Seed availability: Most seed companies carry soybeans. If not under "beans" or "soybeans," try looking under "unusual" or "foreign" vegetables

Spaghetti Squash - see *Squash, Spaghetti*

Squash, Spaghetti - This is another vegetable that is rapidly moving off the "unusual" list because it is becoming so popular. An excellent substitute for noodles, this winter squash is simply boiled or baked for 20 minutes and the pulp, when "fluffed out" with a fork, looks like noodles and tastes delicious served with a sauce or butter. The vine takes a large area to grow, but we trellised it successfully on a heavy tomato cage; each squash was supported by a net sling to prevent its pulling the vine down or falling off.

Spaghetti squash is grown like other vining winter squash and is susceptible to the same problems, but is of fairly easy culture. Squash are ready when they turn light yellow; they have a long growing season and should be started early.

Seed availability: most seed companies have it (also called "Vegetable Spaghetti," but order early!)

Sugar Snap Peas - see *Peas, Sugar Snap*

Tampala - see *Amaranth, Vegetable*

Tomatillos - Another vegetable which may be mistaken for a weed, the tomatillo plant is very similar to that of the ground cherry commonly found in fields. Tomatillo plants are cultivated just like tomato plants; start them in the greenhouse and set plants out after the last frost. Staking or trellising may be helpful, since vines are spindly and eventually fall over. The little fruits are enclosed in a papery husk, with a sticky, soapy substance between the fruit and the husk (this washes off). Tomatillos are best harvested green, when the husk turns a tannish color, at which time they may be eaten raw, tasting somewhere between a tomato and a pepper. In Mexico, the little tomatoes are used for a taco sauce, *salsa verde*, meaning "green sauce." The fruit may also be eaten ripe, but is bland. Tomatillos keep well in a cool, dry basement if placed in a single layer.

The plants have the same pests as tomatoes, but do not seem to have as many disease problems, possibly due to their open growth form. Also see *Ground Cherry*.

Seed availability: These are rather hard to find, but J. L. Hudson, Exotica, and some other seed companies carry it - *Physalis ixocarpa*. Park Seed sells *P. edulis* as "Cape Gooseberry" or "Tomatillo," but this is an old Latin name for a species that was split into *P. ixocarpa* and *P. peruviana*. It is difficult to tell which plant Park is selling. *Tamarillos*, or tree tomatoes, are something completely different, incidentally, and should not be confused with *Tomatillos*.

Vegetable Amaranth - see *Amaranth, Vegetable*

Vegetable Spaghetti - see *Squash, Spaghetti*

Vegetable Sponge - see *Luffa*

Witloof Chicory - see *Chicory, Witloof*

Wong Bok - see *Bok Choy*

Other Unusual Vegetables you may want to try:

Edible bamboo	Lentils
Asparagus beans	Chinese crispy melon
Fava beans	Mushrooms (indoors, esp. in winter)
Yellow beets	Red okra
Rhubarb chard	Egyptian onion
Broccoli raab	Asparagus peas
Purple cauliflower or broccoli	Novella peas
Celeriac	Rutabaga
Celtuce	New Zealand spinach
Chayote	Stuffing tomatoes
Cresses	Yellow watermelon
Dandelion	

... and catalogs contain many more!!!

A source of further information on many of the vegetables listed here and others is Unusual Vegetables, a Rodale Press book.

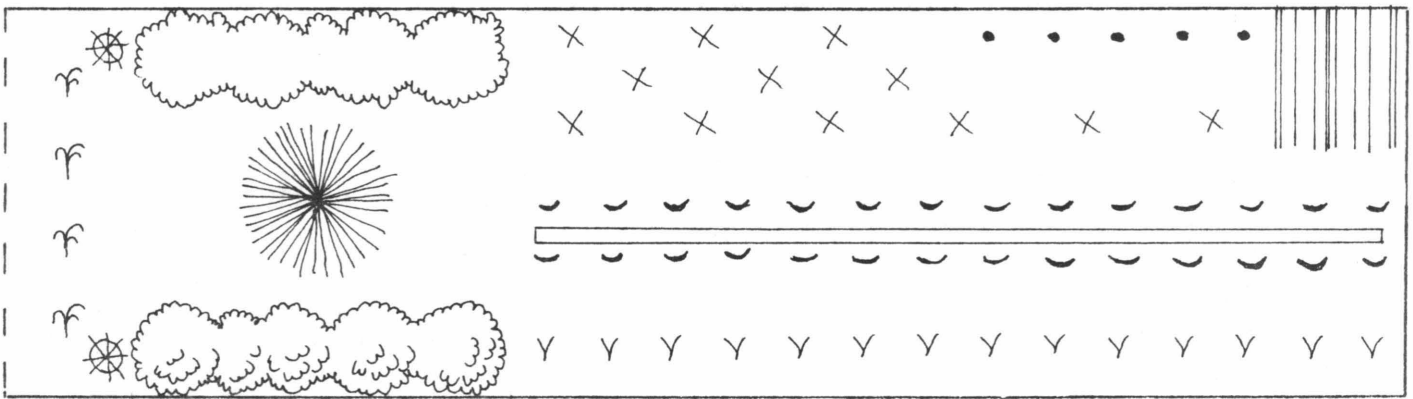
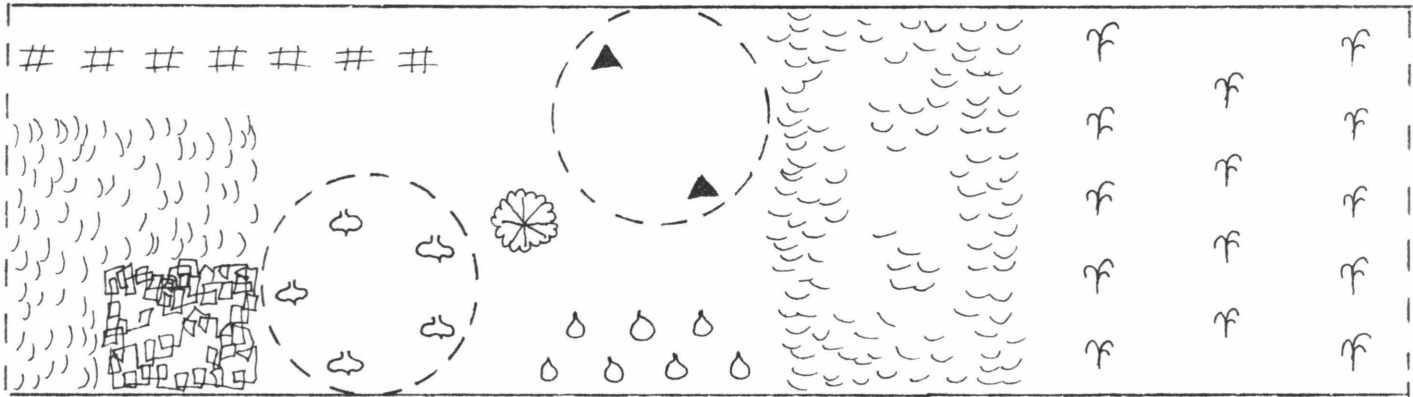
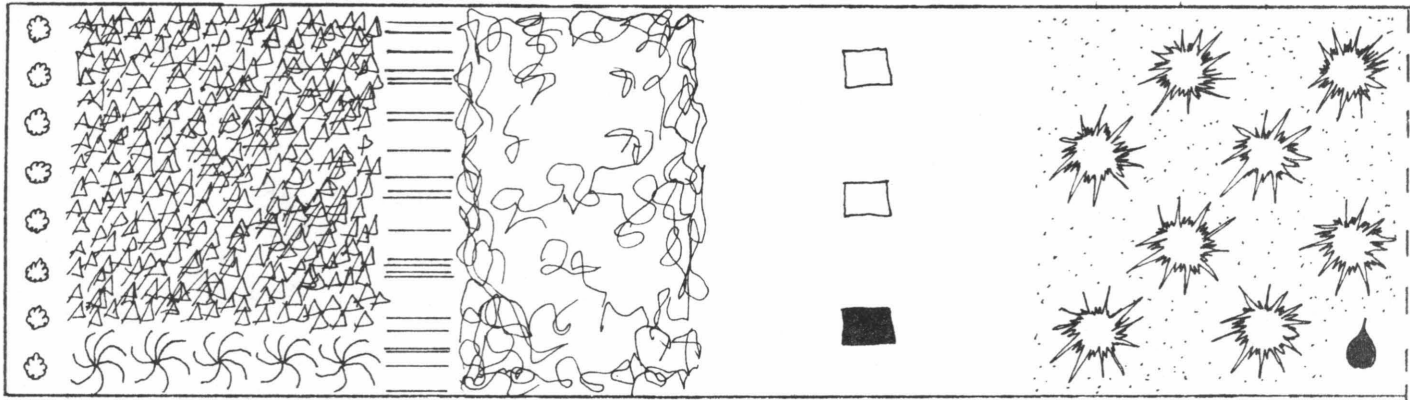

- | | | | |
|--|---------------------------------------|--|-------------------------------|
| | 'RED-LEAF' AMARANTH (THEN PARSNIPS) | | ITALIAN EGGPLANT |
| | 'TIGER-LEAF' AMARANTH | | JAPANESE EGGPLANT |
| | 'WHITE-LEAF' AMARANTH (THEN PARSNIPS) | | CARBANZOS |
| | GLOBE ARTICHOKE | | ELEPHANT GARLIC |
| | BLACK TURTLE BEANS | | JICAMA (CAGED) |
| | BOK CHOY (FOR FALL) | | LEEKS |
| | WITLOOF CHICORY | | MULCH |
| | COCKSCOMB | | 'SPARTAN SLEEPER' ONION |
| | CORIANDER | | 'SUGAR SNAP' PEAS (TRELLISED) |
| | 'CANDYSTICK' CORN | | PIMIENTO PEPPER |
| | ROULETTE | | 'TEQUILA SUNRISE' PEPPER |
| | SALSIFY | | |
| | SHALLOTS | | |
| | TOMATILLOS | | |
| | VEGETABLE SPAGHETTI (CAGED) | | |
| | ENDIVE | | |
| | FENNEL (FINOCCHIO) | | |

MINIATURE CROPS

Many seed catalogs, and some seed racks in urban areas, feature vegetables bred for small gardens and containers. Some especially welcome plants are bush melons, cucumbers, and squash, which normally take up a lot of space. Dwarf varieties of corn, head lettuce, and cabbage mature fast to allow succession crops to be planted (see "The Intensive Garden," page 16). And small pepper, eggplant and tomato plants are prolific but suited to small areas and containers.

There is still a long way to go with miniature vegetables. In two years of trials, we've found that some are not disease- or insect-resistant like some of their standard counterparts, posing a problem to gardeners in many parts of the country. Yet, on the other hand, there are some outstanding qualities in some of these vegetables that are not available in other varieties; for example, a dwarf eggplant grown in this garden produced earlier and more abundantly than standard plants.

A miniature variety demonstration garden is ideal where space is limited for many gardeners, as in urban areas. If combined with a container garden and/or an intensive garden, you can have an exhibit which will give gardeners in such areas new ideas for growing vegetables which they may have thought impossible.

Here are descriptions of dwarf plants which we've grown. Since culture is generally the same for these varieties as for standard plants, only the notable qualities, problems and special instructions will be discussed.

Cabbage - Two commonly available varieties are *Darkri* and *Morden Dwarf*, both of which produced well in our gardens. They grow fast (47-55 days), resist heat well, and have an excellent flavor. An added bonus is that the small heads of *Morden Dwarf* (4"-6") are about the right size for a big dish of slaw. (People with small families know the value of little packages.) *Darkri's* 6"-8" heads have few outer leaves, so that plants can be closely spaced. Succession planting will keep cabbages coming as needed.

Seed availability: Most major seed catalogs have early-maturing and small-sized varieties.

Carrots - There are many small varieties of carrots. Though standard plants don't take much more garden space, they do need a deep soil, while the miniatures produce well even in stony or shallow soils or window boxes. They are quite sweet and tasty, and ideal for using whole, but they do not generally store well in a root cellar.

Varieties used: *Little Finger*, *Short 'n Sweet*

Seed availability: Most seed catalogs carry several small varieties.

Corn - There are many early-maturing and miniature corn varieties available - "coon corn," as old-timers call it, since the ears develop low enough that raccoons have no trouble picking off a midnight snack. Raccoons aside, dwarf and early-maturing corn is ideal for a small garden, since it allows for succession planting and each stalk takes less space, permitting closer planting. Ears range from very tiny (4") to nearly full-sized, and even extra-sweet miniature varieties are available.

Varieties used: *Miniature Hybrid*, *Candystick*, and *Candystick II*

Seed availability: Some varieties of miniature, or at least very early-maturing smaller-eared corn are available from most seed companies.

Cucumber - Many small-space gardeners were happy to see bush cucumbers make their appearance a few years ago. These plants produce full-sized fruits on vines that take about 1/3 the space of ordinary cucumber plants. Fruit are of excellent quality. However, if your area is subject to diseases, take care in choice of variety. Some bush types do not have tolerance to mosaic, anthracnose, and other common cucumber diseases. In this case, trellising standard varieties might be a better option. There are a few bush cucumbers which are resistant to mosaic, though, and they're worth a try for a miniature crops display. One cultural note: picking off flowers until leaves are plentiful may help in prolonging and increasing harvest.

Varieties used: *Bush Champion*, *Bush Whopper*

Seed availability: Most major seed companies now carry bush cucumber seed.

Eggplant - Dwarf eggplant is not too much smaller than regular eggplant, but the bushes are sturdy, compact, and produce earlier. This is especially valuable in short-season gardens, where eggplant may not begin yielding until near the season's end. Even gardeners with plenty of room may want to try the dwarf types to extend their season, since the fruit is comparable to that of standard plants, and the dwarf varieties do produce well.

Variety used: *Morden Dwarf*

Seed availability: Park has *Morden Dwarf*, Thompson & Morgan sell *Short Tom*, Burpee has *Early Beauty*, and other companies offer their own.

Lettuce - While leaf lettuce can be grown in any garden, from a window box up, many people may be unaware that there is a dwarf heading variety which will also grow in small areas. *Tom Thumb* is a delightful little butterhead, maturing in 65 days. Like other butterheads this one will bolt in hot weather, but it can be grown in both spring and fall, either from plants or seed. *Tom Thumb* has a compact, attractive growing habit; harvest when heads are full- they are still rather loose. It does well in containers, too. Each head is enough lettuce for 1-2 people, making a very appealing luncheon plate, for example, and is delicious.

Seed availability: *Tom Thumb* is now available from many catalogs.

Melons - The same problems exist with the dwarf melons as with bush cucumbers. The fruit is good, but the vines are generally not disease resistant. They are worth a try, though. *Oliver's Pearl Cluster* honeydew can be grown where other honeydews wouldn't have time to mature, and it's a very ornamental plant. The *Kengarden* watermelon is also very unusual-looking, with good fruit. There are other excellent dwarf melons as well. As with dwarf cucumbers, pinch off flowers until a substantial number of leaves has developed; otherwise the plants will support only a few fruits.

Varieties used: *Oliver's Pearl Cluster* honeydew, *Kengarden* watermelon, *Sweet 'n Early*, *Sugar Bush*, and *Armstrong* cantaloupes.

Seed availability: Most companies have early-season varieties with small fruit; for a miniature crops garden, look for dwarf vines as well as short season.

Peppers - Dwarf, short-season peppers with fruits of nearly standard size are available. *Park's Pot* was the variety we used. They were good, but standard pepper bushes can easily be grown in small spaces and containers, and it is felt that the restricted choice in fruit quality of dwarf varieties might not be worth the small gain in planting space. However, for stretching the season and in areas where a short growing season is a problem, the 10-15 days gained by planting dwarf types might significantly improve yields.

Seed availability: Many companies have dwarf peppers.

Squash - A number of bush squash varieties are on the market now. Many are excellent producers in a reasonable amount of space - one or two hills with succession planting several weeks later will meet most people's fresh squash needs. Some special dwarf plants take even less space.

Varieties used: *Early Acorn Hybrid*, *Creamy Hybrid*

Seed availability: Most catalogs have bush or dwarf squash.

Tomatoes - Dwarf tomato plants do not necessarily take less room than staked, caged, or trellised standard tomato plant; in fact, we've found that standards are better producers per square foot (see Variety Demonstrations, page 19). However, in cases where large, heavy vines cannot be supported (in hanging baskets, for example), the determinate (bush) types are better suited. One distinct disadvantage of determinate varieties is their short production season; most gardeners prefer to have fresh tomatoes as long as possible. Incidentally, small tomatoes do not necessarily mean small plants; the Sweet 100 variety of cherry tomatoes grows to seven feet or more. Nor do small plants necessarily produce small fruit; many bush varieties bear average sized tomatoes.

Varieties used: *Patio*, *Bitsy*, *Roma VF*

Seed availability: Bush or determinate tomatoes are available from most catalogs and seed stores.

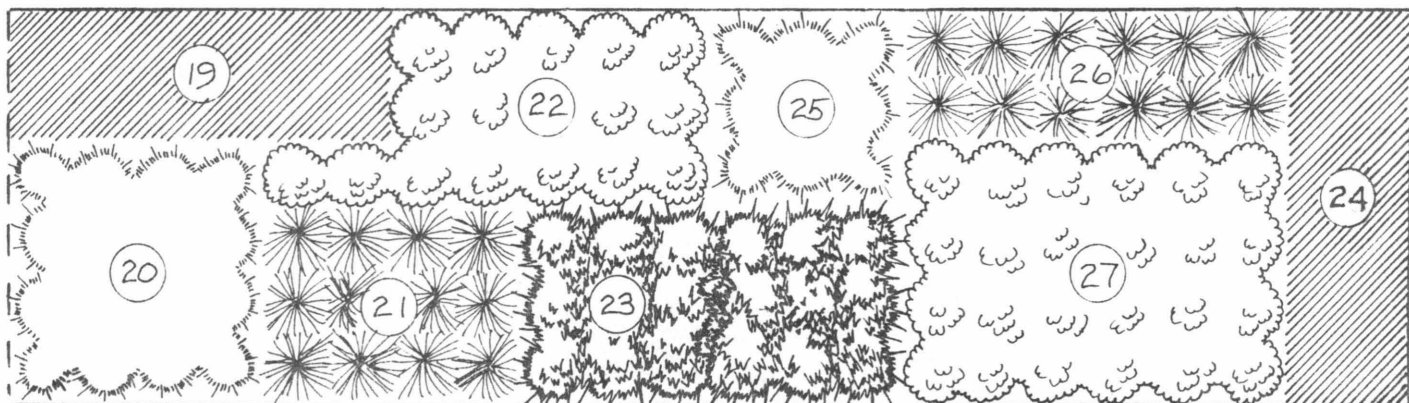
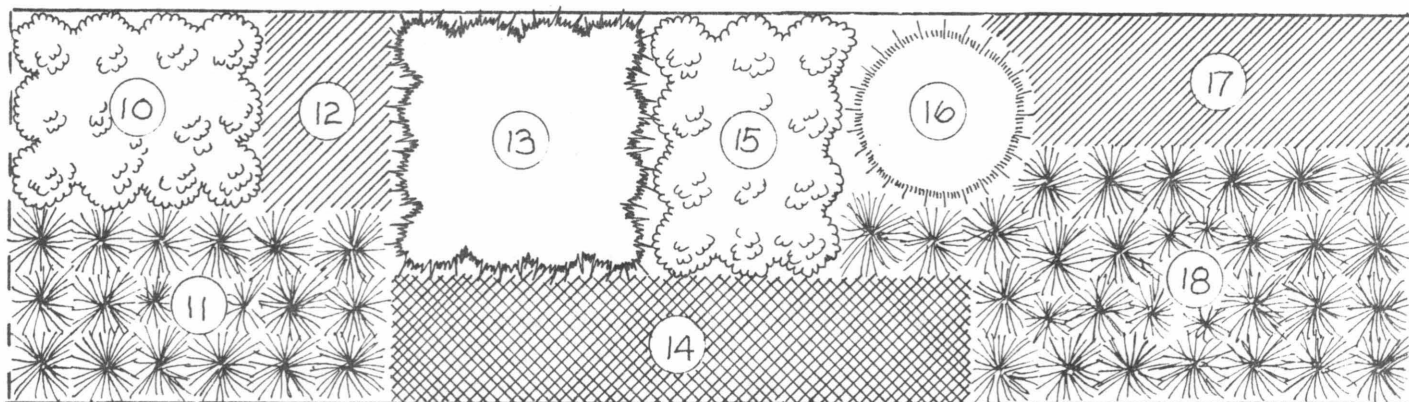
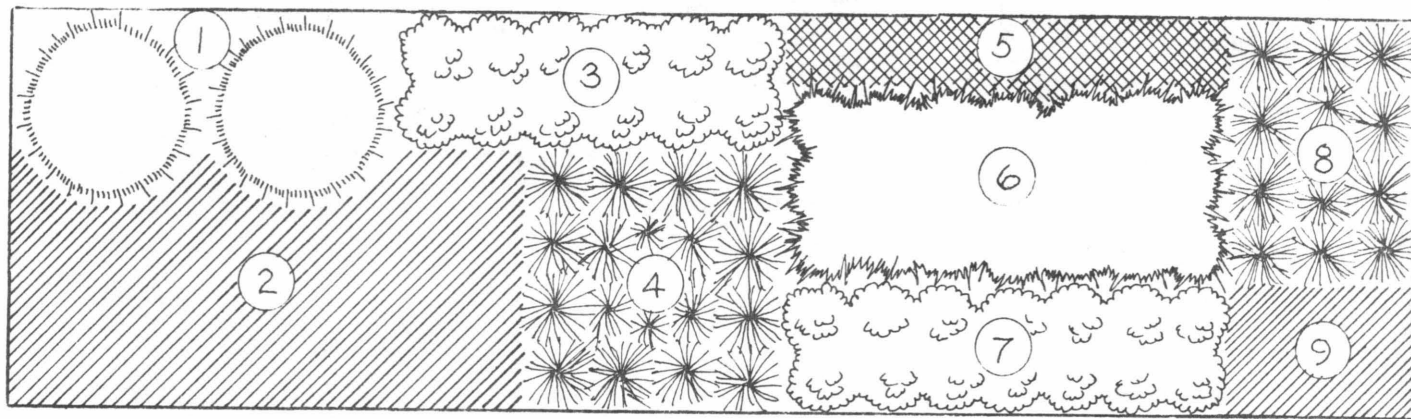

- | | |
|------------------------------------|-------------------------------------------------------|
| 1 'VEE PICK' PEAR-TOMATOES | 14 'MORDEN MIDGET' CABBAGE / 'LITTLE FINGER' ZUCCHINI |
| 2 'MORDEN MIDGET' EGGPLANT | 15 'SELECT' ZUCCHINI CARROTS |
| 3 BUSH BEANS | 16 PEAR TOMATOES |
| 4 'ARMSTRONG' CANTALOUPE | 17 JUNE BEANS |
| 5 JUNE BUSH BEANS | 18 'ARMSTRONG' CANTALOUPE |
| 6 'PARK'S POT' PEPPERS | 19 'PATIO' TOMATOES |
| 7 'PATIO' TOMATO | 20 'KENGARDEN' WATERMELON |
| 8 'MINIATURE HYBRID' CORN (EARLY) | 21 'LITTLE FINGER' CARROTS / 'CHERRY BELLE' RADISHE |
| 9 'MINIATURE HYBRID' CORN (LATE) | 22 'BUSH CHAMPION' CUCUMBERS |
| 10 'MINIATURE HYBRID' CORN (EARLY) | 23 'DWARF GREEN LONG POD' OKRA |
| 11 'BUTTERBUSH' SQUASH | 24 MARIGOLDS |
| 12 JULY BEANS | 25 'SELECT' ZUCCHINI |
| 13 WINTER SQUASH (ACORN) | 26 'BUSH WHOPPER' CUCUMBERS |
| | 27 'OLIVER'S PEARL CLUSTER' HONEYDEW |

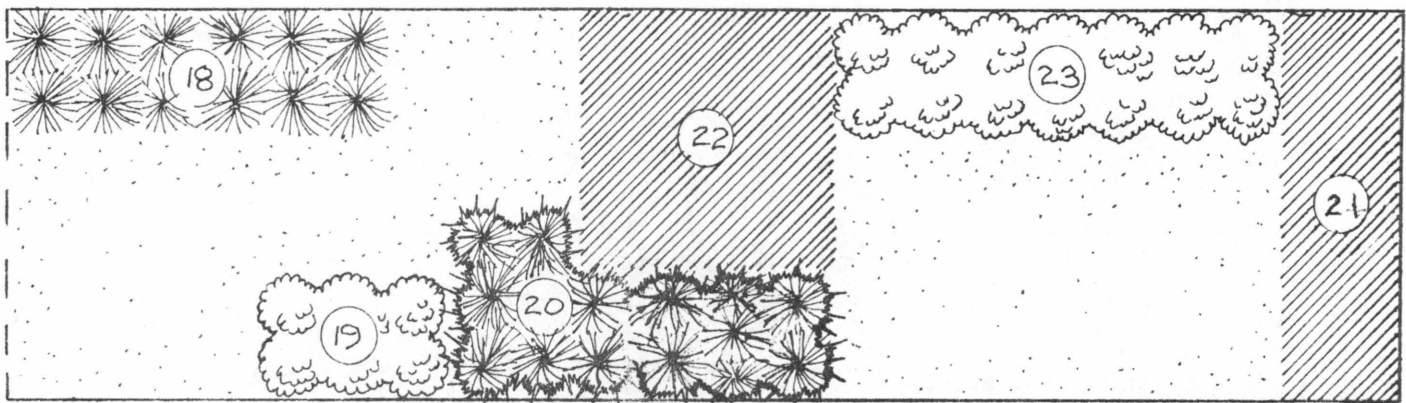
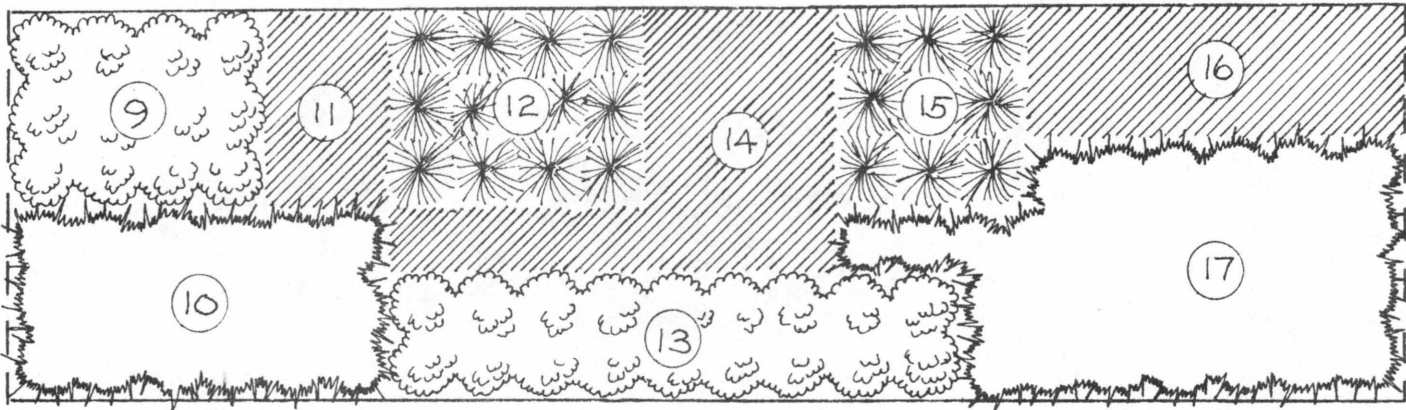
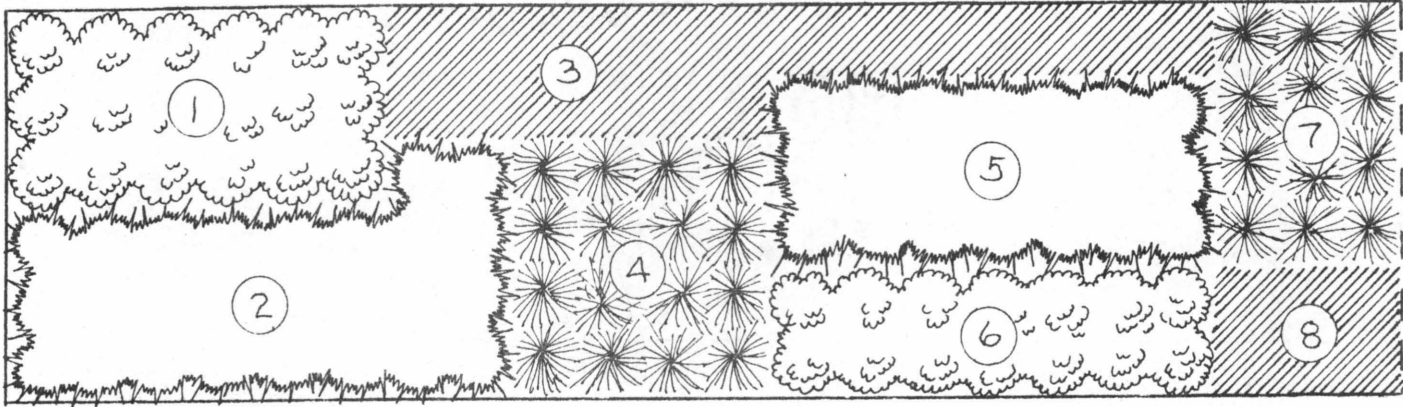

- | | |
|--------------------------------------|------------------------------------------------------|
| 1 'VEE PICK' PEAR TOMATOES | 13 'MORDEN MIDGET' CABBAGE / 'LITTLE FINGER' CARROTS |
| 2 'MORDEN MIDGET' EGGPLANT | 14 'SELECT' ZUCCHINI |
| 3 'GATOR GREEN' BUSH BEANS | 15 PEAR TOMATO |
| 4 'TOM THUMB' LETTUCE | 16 BEANS |
| 5 'PARK'S POT' PEPPERS | 17 'LITTLE FINGER' CARROTS / 'TOM THUMB' LETTUCE |
| 6 'PATIO' TOMATOES | 18 'PATIO' TOMATOES |
| 7 'MINIATURE HYBRID' CORN | 19 'LITTLE FINGER' CARROTS |
| 8 JULY CORN | 20 'DWARF GREEN LONG POD' OKRA |
| 9 'TOM THUMB' LETTUCE | 21 MARIGOLDS |
| 10 'CREAMY HYBRID' CROOK-NECK SQUASH | 22 'SELECT' ZUCCHINI |
| 11 JULY BEANS | 23 'PATIO' TOMATOES |
| 12 'EARLY MORN' HYBRID' SQUASH | |

THE HERB GARDEN

An herb garden makes an attractive and attention-getting display, is easy to care for, and does not require a great deal of input. There's also a lot of interest in the plants themselves and in their history, culture, preservation, and uses.

Even many experienced gardeners learn something new from an herb display. The colorful lore that surrounds the aromatic plants can be amusing or amazing, but always interesting. For example, when the early Greek and Roman physicians sowed basil seed, they cursed and shouted while doing so, in the belief that this would make the plants grow well. There is a French idiom for "raving" which literally translates as "sowing the basil."

The culinary uses of herbs are well-known; with the revival of gourmet cooking and vegetarianism, people are growing and using herbs they had formerly ignored or never heard of.

Herbs for fragrance, cosmetics, and medicinal uses are also receiving attention. A lot of herbs have landscape value, too. Common sage, for example, has silvery green leaves with purple flowers that bumblebees love. A perennial shrub, sage would work well in a border where annuals or perennial flowers would hide its summer tendency to scragginess, since sage is at its best in spring and fall. Wormwood is another herb with silvery foliage, forming a 3'-4' shrub. Thyme is a useful border plant or ground cover. There are many other examples.

It is not our purpose here to describe all the herbs and their growing habits and uses; it is suggested that you consult Publication 426-420, "Herb Culture for Home Gardens," for descriptions, culture, and uses of common herbs. For the more exotic ones you may have to purchase one of the many available guides or check out a library book on the subject. The culture of most herbs is not difficult. In most cases they require a soil of low to medium fertility with reasonably good drainage. As with any group of plants, there are exceptions.

When planning an herb garden, you may wish to separate annuals from perennials in some manner, so there will not be the temptation to pull up perennials and so that space for annuals can be worked each spring. Study plant heights and spreading distances, and use these to plant an attractive bed, by the same general principles used for planting flower borders. If you lean toward the formal, and have some extra time, consider an old-fashioned knot garden.

Plant care requirements are usually minimal in an herb garden. Few insects and diseases bother the plants; there may be parsleyworms, the big green/yellow/black larvæ of the black swallowtail butterfly, on parsley, dill, and fennel, but they are easily hand-picked.

The major work involved is in harvesting, trimming, and preserving. Herbs such as basil and dill will go to seed quickly and their life-span will be shortened if they are not trimmed. Mints will not be happy with a small space, and runners must be confined with a container or other restraining device extending 2" above and 8" below the soil surface. The peak harvest time for most herbs is just before the flowers open, preferably on a warm, clear day, since the aromatic oils are encouraged to circulate in the plant at such times. So, someone must keep an eye on the plants to catch the best harvest.

After harvest, herbs should be cared for promptly. For those with small, thin leaves, simply tying in bundles and hanging in a warm, dark, dry place, or spreading stems on a screen is sufficient. When crispy-dry, the leaves are stripped from the stems and stored in (preferably glass) containers.

More succulent leaves (such as basil) will turn dark brown when air-dried slowly and will lose much of their aromatic quality. These are best dried in a dehydrator, a convection oven, or a conventional oven at no more than 150° F. Oven doors should be left slightly open for moisture removal. Screens or racks with some type of mesh material are used to allow air movement around the entire stem, and a single layer of herbs is spread on each rack. As above, when the leaves are crispy-dry, they are stripped from the stems and stored.

Many herbs will freeze well. All herbs should be labelled before freezing or drying; shrivelled green leaves look very similar after processing.

Harvesting and drying herbs, then, offers another educational opportunity that you can take advantage of. The Home Economics agent may be willing to participate or even to extend the project by doing demonstrations of culinary uses.

The slide set, "Herb Culture for the Home Garden" is available from the Horticulture Extension Specialist, providing helpful information and photographs of herbs.

HERB GARDEN
SCALE: 1" = 1'-6"

- 1 WORMWOOD (ARTEMESIA)
- 2 CONFREY
- 3 SAGE
- 4 OREGANO
- 5 EGYPTIAN ONION
- 6 THYME
- 7 CHIVES
- 8 CHAMOMILE
- 9 WINTER SAVORY
- 10 LAVENDER
- 11 RUE
- 12 ROSEMARY
- 13 CATNIP
- 14 TARRAGON
- 15 GARLIC CHIVES
- 16 FLOWERS/ITALIAN PARSLEY
- 17 CHERVIL
- 18 PURPLE-LEAVED BASIL
- 19 FENNEL
- 20 SESAME
- 21 CORIANDER (FOR LEAVES)
- 22 LEMON BASIL
- 23 DILL
- 24 ANISE
- 25 SUMMER SAVORY
- 26 CRESS/LOW-GROWING FLOWERS
- 27 SWEET BASIL
- 28 FLOWERS/PARSLEY (INTERPLANT)
- 29 WOOD ROUNDS IN PATH

Fig. 10

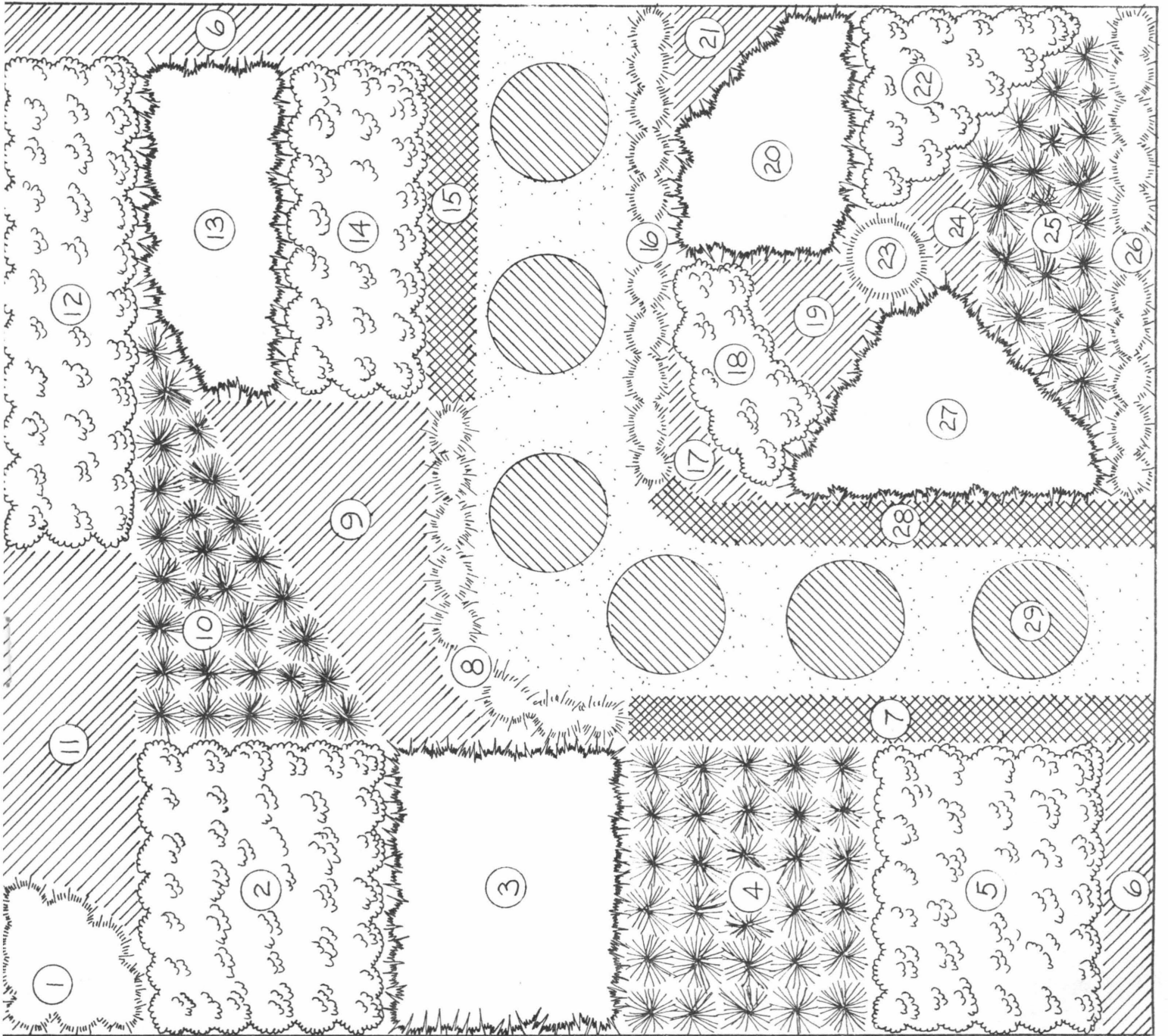

THE PERENNIAL BED

1981 was the first year a perennial bed was planted at the Horticulture Farm near Blacksburg, so there were virtually no harvests. Most of the work on this bed was in keeping strawberry flowers and runners under control and digging trenches for asparagus. Otherwise, it was fairly trouble-free.

The plants used were as follows:

rhubarb	asparagus
horseradish	sorrel
comfrey	Jerusalem artichokes
strawberries	borage (not perennial, but self-sows)

Since information is widely available on some of the above, only those plants not commonly grown by home gardeners in Virginia will be discussed here.

Borage - Borage is a large-leaved, fast-growing annual herb. (It was placed in this garden because it self-sows readily and because it takes space which was not available elsewhere.) Borage has attractive purple flowers which bring bees by the hive-ful. A former technician attributed the complete pollination of her huge sunflowers to nearby borage plants. The leaves of borage have a cucumber-like flavor and may be used in salads when very young. The plants die back in summer, but usually seed will sprout for another crop in fall.

Seed availability: Most seed catalogs list borage in their herb sections.

Comfrey - A member of the same family as borage, comfrey is a useful perennial plant. Once established, comfrey plants grow up to 3' wide and must be cut back several times during the season. The leaves may be dried and used for tea or as feed for some livestock, or spread on the garden as a high-nitrogen mulch. Comfrey is also considered a medicinal herb with many uses. It makes a beautiful border plant, and grows very fast. Comfrey may be started from seed, but has a reputation for being difficult to germinate. Root cuttings or divisions are easier ways to get started.

Seed/plant availability: Seed is available from some major companies and from most catalogs specializing in herbs; Gurney's carries plants. Nichols Garden Nursery has root cuttings.

Horseradish - The puny, dry sticks which are horseradish root cuttings take a month or more to generate shoots which will poke their way through the soil surface, and then they are in danger of being mistaken for a weed (like broadleaf dock). But refrain, and soon you'll have a 3' tall and 2½' wide plant busily forming thick roots capable of bringing tears to the eyes. When the plants are about a foot high, the soil is carefully scraped back from the main root, and lateral roots to a depth of 6"-8" are cut off so that the main root will be smoother and larger. The soil is replaced and watered in, and the plants keep on growing in their carefree manner until after frost, when the roots may be dug and used for the famous tangy sauce, or stored like carrots and grated fresh. Some gardeners leave them in the ground until they are needed. Enough lateral roots inevitably remain to form the basis for the following year's bed.

Cutting availability: Several large seed companies sell horseradish root cuttings in the spring, and they are available from most herb specialists.

Jerusalem Artichoke - Details on culture of this plant are given in the "Unusual Vegetables" section, page 22.

Sorrel - Grown as a leafy green plant, sorrel forms clumps that keep producing for years. The outer leaves are picked and used in salads, soup, and with other greens, such as spinach or chard. Sorrel has a somewhat tart or sour taste that many people find pleasant; it contains a high amount of oxalic acid, like spinach, and should be eaten in moderation by those who are sensitive to it. Plants should be provided with sufficient nitrogen and water to grow rapidly, and clumps should be divided when they become crowded. Sorrel may need to be kept within bounds to prevent interference with other crops if allowed to go to seed.

Seed availability: Most herb catalogs and the herb sections of major seed catalogs list sorrel. It may also be called *oseille* or patience dock. *Rumex acetosa* is common garden sorrel; *Rumex scutatus* is French sorrel, with smaller leaves and a tangier taste.

Other perennials you may want to try:

sea kale

edible bamboo









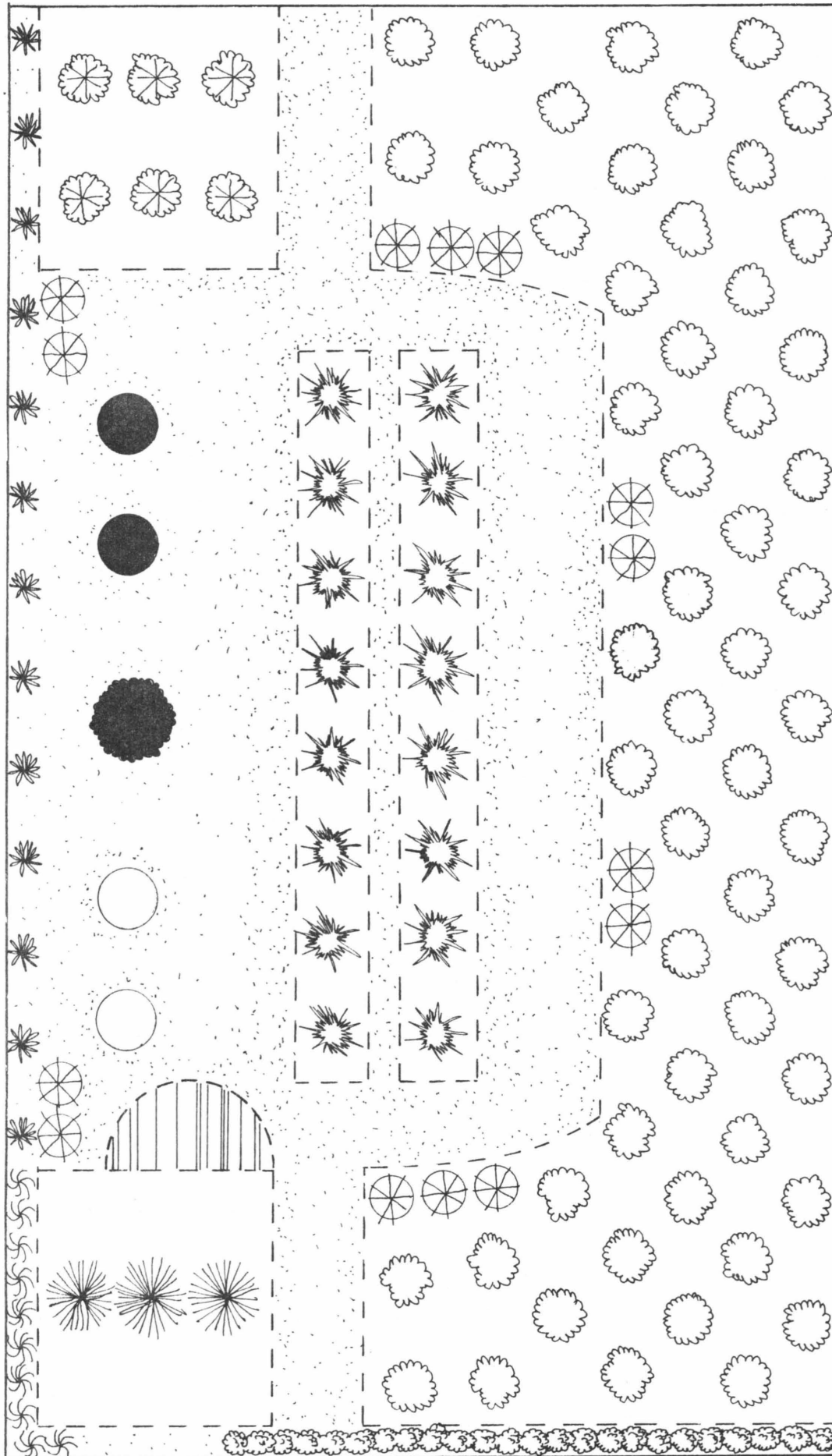



Egyptian onion

other fruits

SCALE: 1" = 2'-6"

PERENNIAL BED



- | | | | |
|---------------------------------------------------------------------------------------|-------------------------|--------------------------------------------------------------------------------------|--------------|
|  | ALYSSUM |  | COSMOS |
|  | JERUSALEM ARTICHOKE |  | HORSERADISH |
|  | ASPARAGUS |  | RHUBARB |
|  | BORAGE |  | SORREL |
|  | CARDOON (NOT PERENNIAL) |  | STRAWBERRIES |
|  | COMFREY |  | ZINNIAS |

THE VERTICAL GARDEN

A completely vertical garden demonstrating this space-saving technique was planted at the Horticulture Farm in 1980. A double trellis was made using chicken wire and 2" x 2"x, with the trellises 6" apart. Climbing vegetables - peas, pole beans, cucumbers, melons, squash and luffa gourd - were grown on both sides of the trellis. Chicken wire was not recommended for use again, since fruits matured inside the two trellises and were unreachable. But the trellis was sturdy and might be constructed with 6" mesh fencing instead. There was a great deal of interest in this structure at Field Day; gardeners were heard to say they would try it.

Pole beans were grown on teepees made of 1½" - 2" diameter branches. These worked very well. Tomatoes were staked or caged.

Some other ideas that might be incorporated into a demonstration of vertical gardening:

- using an existing fence
- espalier of fruit trees or vines on fences or walls
- a portable, vertical growing box (Figure 1)
- a wire mesh cylinder filled with soil mix and sphagnum moss (Figure 2)
- an A-frame trellis with hinges for flat storage (Figure 3)
- a trellis built on a planter box (Figure 4)

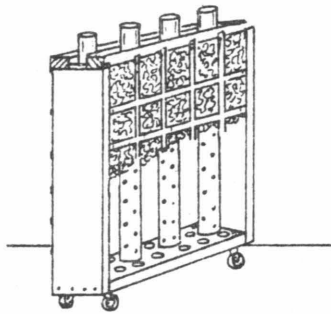

Figure 1

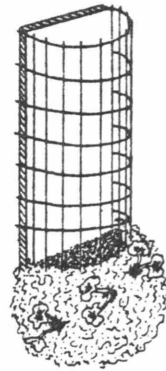

Figure 2

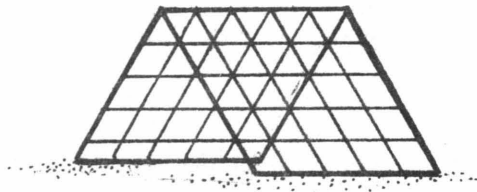

Figure 3

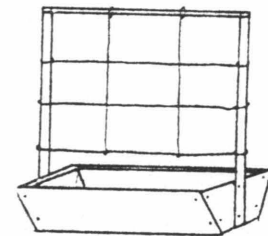

Figure 4

THE CONTAINER GARDEN

A container garden is useful for people who have no gardening space outdoors or who simply don't want to plant in the ground for some reason. An intern working in Danville several years ago had such a successful container garden display that she was asked to leave the containers so that the garden could be set up again the following year at the housing development where her display was.

Many kinds of containers can be used and most types of vegetables and some fruits grow in them. Basically, anything that will hold soil and not be toxic to plants will do. Publication 426-336, "Container Gardening," contains ideas for containers and instructions for mixing soil. Try to find unusual containers which attract attention - an old bathtub, a used commode, baskets, buckets, a wheelbarrow, old shoes - in addition to more conventional ones.

Do not feel limited to planting dwarf or miniature varieties in containers, though they can be used. A *Big Moon* plant grown in half of a 55-gallon drum in our demonstration garden produced a pumpkin to rival any grown in the field! Special varieties are useful in certain cases; for example, cascading varieties of tomatoes are attractive in hanging baskets and other containers; miniature carrots can be grown in very small containers, such as berry baskets.

Container plants need greater amounts of supplemental watering than do ground-grown ones, since roots are confined within the container. In summer heat, they may need water once a day or more. A spigot or rain barrel close by is practically a necessity, and a weekend watering schedule is a must. Water until some comes out of the drainage holes to be sure the soil is thoroughly moistened.

Fertilizing may be somewhat different for container-grown plants, too. A soil test for container soil is needed as for any other gardening soil. Timed-release fertilizers may be mixed into the soil as it is being prepared, or soluble fertilizers may be added later. Look on the fertilizer package for instructions for container plants.

Container-grown vegetables need good sunlight for best growth. Publication 426-336 shows the amount of direct sunlight needed by many vegetables. However, it's best not to grow container plants directly on concrete or other hard surface where there is strong sunlight, since heat buildup and light reflection may burn plants. If the only available gardening spot presents this problem, place boards, a pallet, or some other contrivance beneath containers to allow for air flow and to reduce reflection. In cases where extra sunlight is needed, use reflective materials beneath and around plants.

Two slide sets, available from the Home Horticulture Slide Loan Library, outline container gardening in detail. They are: "Container Gardening: Construction and Planting," and "Container Gardening: Principles and Practices."

SPECIAL DISPLAYS

Raised Bed

A 4' x 6' x 3' wooden raised bed was built in 1980 to demonstrate a gardening area for a handicapped person, particularly a wheelchair-bound person. Both vegetables and flowers were grown in the bed, and abundant harvests of tomatoes, peppers, beans and other vegetables have been reaped from it.

To build a wooden raised bed, use long-lasting wood which will weather attractively. Cedar or treated pine is a good choice, but treatments should not be toxic to plants. 4" x 4" corner posts are sunk vertically into the ground about a foot, and 1" - 2" thick boards of the desired width and length are nailed to the posts to form the sides of the box.

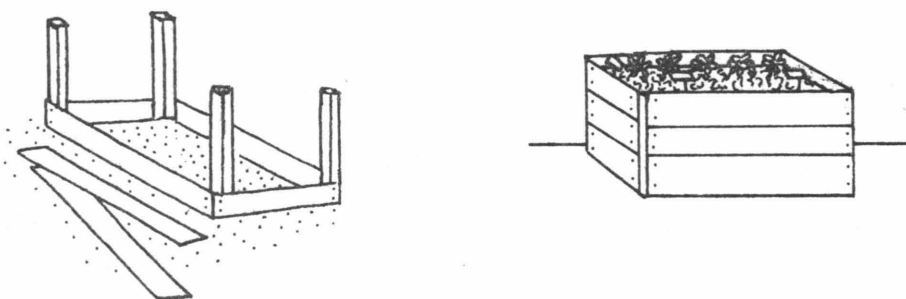

The bed may be as long as desired, but the bed's width should not exceed four feet so that it is easily worked. If the bed is accessible from one side only, the maximum width must be reduced correspondingly in order to be worked easily from a wheelchair or by a standing person.

A light, porous soil rich in humus and nutrients gives best results in a raised bed. Roots must grow downward, and the deeper they can reach, the better. A mixture of topsoil, compost, and/or manure and sand (for very clay-ey soil) is excellent. Peat may also be added. The soil in a raised bed such as this will dry out quickly, so water regularly during dry periods.

Planting a raised bed like this is best considered thoughtfully. Putting large plants in the middle or at the back of the bed, with lower-growing or cascading plants around the edges, prevents difficulties in reaching plants and shading problems. Container varieties and dwarf varieties are useful here (see "The Container Garden" and "Miniature Crops"). A sample planting plan is on page 43A.





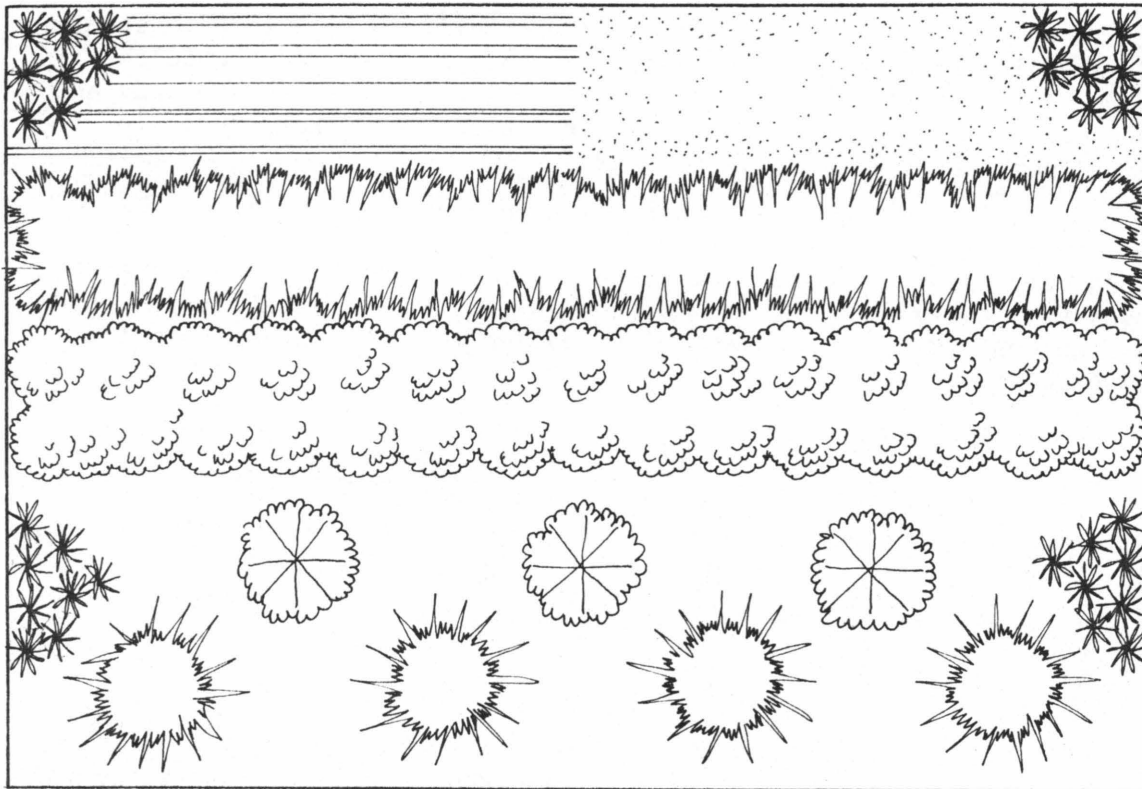

Tractor Tire

A used tractor tire donated by a local farm equipment company makes a curious "children's garden" display. Filled with a soil mixture similar to that used in the raised bed and planted with flowers and novelty vegetables, this simple garden has a place to sit while planting and harvesting.



RAISED BED

SCALE: 1" = 1'-0"

-  'GREENCROP' BUSH BEANS
-  'DANVERS HALF LONG' CARROTS AND
'WHITE ICICLE' RADISHES (INTERPLANTED)
-  FLOWERS
-  'CRISPY SWEET' LETTUCE
-  ONIONS
-  'BETTER BELLE' PEPPERS
-  'PIXIE HYBRID' TOMATOES

SECTION III

APPENDICES

Circle of Cages

A magazine article gave us the idea for this unique display. Five tomato plants in cages were planted in a circle, in holes dug two feet deep and filled with a mixture of manure, soil and fertilizers. Inside the circle of cages was a compost bin. Big (some huge), perfect tomatoes grew on plants that were essentially disease- and insect-free until late blight appeared after some very cold nights. Yields were not as good as the author's claim of 200 tomatoes per plant - we only harvested 34 Stakebreakers (though some were 7" across); but there were 75 Super-steaks, and the 7' Sweet 100 plant yielded cherry tomatoes too numerous to count.

Compost Bins

Two simple compost bins were displayed in the demonstration gardens at the Horticulture Farm. One (inside the Circle of Cages) was a cylinder made of wire fencing, supported by wooden stakes; the other was an arrangement of three used loading pallets to form an open-sided bin (a fourth side is suggested, since compost tends to fall out).

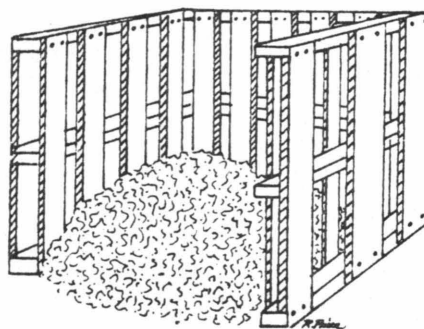
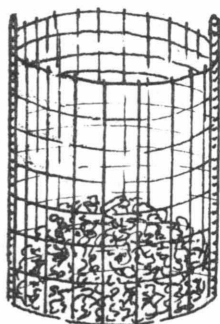

Other types of compost bins and compost makers would make an interesting display. The tumbler type and the vinyl bin with movable panels are just two which you might purchase, build, or attempt to have donated.

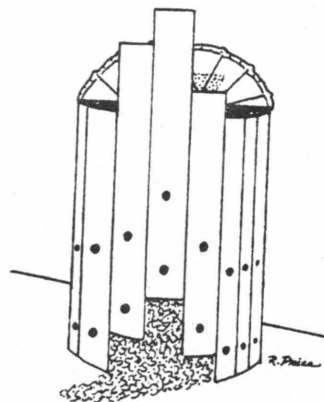
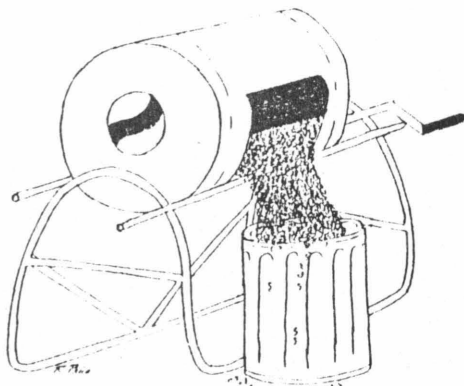

Season-Extenders

To get the most out of a garden, one can extend the season by sheltering plants from cold weather both in early spring and during the fall. Very ambitious gardeners can harvest greens and other cool-weather crops all winter by providing the right conditions. The Horticulture Farm Demonstration Garden included a display of season-extenders in 1981.

Cloches

The cloche (pronounced *klōsh* or *klôsh*) was originally a bell-shaped glass jar set over delicate plants to protect them from the elements. The definition has expanded, however, to include many types of portable structures which shelter plants from drying winds and cold air.

The idea is to provide a greenhouse-like atmosphere for seeds and small plants in order to get an early start on the season or to extend the fall garden as long as possible. Cloches are set out over individual plants or are made into "tunnels" for whole rows. They trap solar radiation and moisture evaporating from the soil and plants. The "hotkap" and the ubiquitous cut-off plastic jug are simple forms. More elaborate ones are fiberglas tunnels, special plastic cloches or row covers with slits for aeration, and panes of glass connected by special hinges to form a tent. There are a variety of forms on the market now; some work, some don't. Many are easily constructed from materials found around the home.

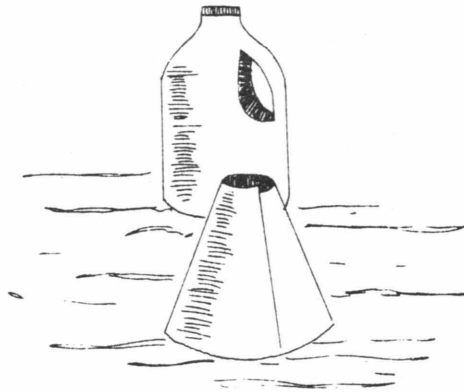
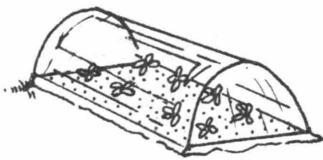

Cloches are generally lightweight, portable and re-usable. It is preferable to have a design which can be closed completely at night to prevent frost damage, and opened or completely removed during the day for good air circulation. Cloches should be anchored or heavy enough that they don't blow away.

Cold Frames and Hot Beds

The cold frame is the traditional form of season-extender for many American gardeners. A cold frame is a fairly permanent structure in which small plants are started and cool-season crops may be grown to harvest.

The hot bed is a form of cold frame, with a layer of fresh manure or heating cables below the growing medium. This provides extra heat to seedlings for an early start. For more information see Publication 426-381, "Cold Frames and Hot Beds."

Cold frames are moving into the solar age with some more recent developments. 55-gallon barrels painted black and filled with water have been used to store solar radiation for the night inside some elaborate cold frames. Also, some experimentation is being done with reflecting devices to maximize winter sunlight and with movable insulation to protect plants from extremes of cold. Earth berming and combinations of heating with manure and solar storage are under testing as well.

Greenhouses

Many avid gardeners choose to take the final "step up" to a greenhouse. Complete instructions for building an estate-size gothic greenhouse, such as the one displayed at the Horticulture Farm, are found in VPI & SU Extension Division Publication #461, "Plastic Greenhouses."

Conservation-minded persons may be interested in solar greenhouses. The initial cost is generally higher for a solar greenhouse than for the simpler free-standing, uninsulated types, but for maximum use with lower heating bills, one can insulate north and side walls, provide liberal glass area for winter sun-catching, and make use of some type of solar radiation storage. When attached to a house, these greenhouses can be used for supplementary household heating, but there is a trade-off between heating the home and growing plants (especially heat-loving ones) in the greenhouse, so cool-weather crops are recommended. VPI & SU now has a publication (#919) entitled "Attached Solar Greenhouses."

Shading

It is not always easy to start seeds or young plants for fall gardens in the hot and dry conditions of August in Virginia. One simple way to provide shade in otherwise exposed conditions is to use a couple of tires, set upright, with an old bamboo shade securely attached on top of them to form a tent-like structure. You should be able to roll the shade up and down as conditions demand. Or, a portable shade frame of lath or mesh could be built to place over rows after seeds are sown or transplants set out.

APPENDIX A - SUGGESTIONS FOR GARDENS

In addition to the types of gardens for demonstration already discussed in this manual, a little imagination can lead to any number of possibilities. Here are a few which come to mind, and suggested plants to put in them.

All-America Selections

Each year a demonstration garden could show off all or some of the All-America Selections for that year, both vegetables and flowers. Or, a display of selections from three or four years' AAS choices might be planned.

Children's Garden

white "Easter egg" or Oriental eggplant	chives
giant sunflowers	potatoes
peanuts	baby carrots
Egyptian onions	radishes
yard-long cucumber	snap peas
luffa	spaghetti squash
ground cherry/tomatillo	lemon cucumbers
penguin gourds	Sweet 100 tomatoes
mini- or super-sweet corn	cotton
yard-long beans	beefsteak tomato
elephant garlic	strawberries
<i>Tom Thumb</i> lettuce	popcorn
Turk's turban gourd	rhubarb chard

Drought-Resistant Garden

amaranth	kale
herbs	orach
mung beans	garbanzos
okra	New Zealand spinach

Edible "Wild" Plants

dandelion	purslane	asparagus
ground cherry	ginseng	lamb's quarters
sorrel	watercress	Jerusalem artichoke
burdock	salad burnet	daylilies

Shrubs and trees

blueberries	elderberries	common persimmon
huckleberries	blackberries	black walnut
common pawpaw	Allegheny chinquapin	

Family Garden

This could be an educational display of plants within botanical families, both vegetables and flowers. Some examples:

Solanaceae

tomato
eggplant
pepper
tomatillo
potato
ground cherry
cape gooseberry
tobacco
nicotiana
petunia
browallia
nightshade

Cruciferae

cabbage
radish
turnip
kohlrabi
broccoli
cauliflower
Brussels sprouts
collards
Chinese cabbage
mustards
broccoli raab
nasturtium
rutabaga
roquette
Bok Choi
sea kale
garden cress
candytuft
alyssum
sweet alyssum
horseradish
kale
wallflower

(also see Virginia Home Food Production Guide)

Fragrance Garden

Emphasis here can be placed on plants which are highly aromatic, perhaps those which can be easily recognized by their scents.

fennel	herbs	various peppers
garlic	onions	shallots
horseradish	marigold	geranium
heliotrope	dianthus	carnation
lemon verbena	wallflower	ornamental flowering tobacco
iris	Siberian wallflower	

Shrubs and trees

roses	fragrant viburnum	sassafras
spicebush	sweet bay magnolia	lilac
Carolina sweetshrub		

Geographic Theme Garden

Display plants grown and used in other countries.

Oriental

Bok Choi	Chinese cabbage
Michihli	waterchestnut (in tub)
bamboo shoots	crispy melon
soybean	asparagus bean
amaranth	chopsuey green shungiku
baby corn	<i>Daikon</i> radish
snow peas	Oriental eggplant
jujube	yard-long cucumbers
daylily	garlic

Mexican

jicama
tomatillo
Mexican rainbow bean
luffa
Castilian winter squash
cilantro (coriander leaves)

In containers in cold areas

Indoors
sprouts

shii-take mushroom log

Opuntia cacti (prickly pear)
pomegranate
passion fruit

Gourmet Garden

witloof chicory	petits pois	shallots
stuffing tomato	sugar pod peas	garlic
globe artichoke	baby beets	herbs
baby carrots	Brussels sprouts	asparagus
finocchio (fennel)	bunching onions	celtuce
butterhead lettuce	cress	leeks
cos (Romaine) lettuce	sea kale	sorrel
Japanese eggplant	endive	

Also see Unusual Vegetables and Geographic Theme vegetables

Handicapped Person's Garden

Use raised bed at the appropriate width, height, etc. for easy reaching from a wheelchair, or which can be leaned against by a person who cannot stand for long periods. See "Special Displays," page 43. Feature tools which reduce strength required to do work, pathways suitable for a wheelchair or walking on with a cane or walker, a specially-designed potting bench, plants easy to work with, etc.

Monstrosity Garden

Most catalogs feature at least a few vegetables and flowers which grow to enormous sizes. *Big Max* or *Big Moon* pumpkins, giant radishes, huge tomatoes, gargantuan green peppers, yard-long beans, peas and cucumbers, giant dahlias, and others are available.

Off-Color Garden

Vegetables, fruits, or flowers which are unusual in color are featured in this garden.

yellow watermelon	purple cauliflower
red okra	purple broccoli
rhubarb chard	red cabbage
blue potato	white or yellow eggplant
white cucumber	bi-color corn
purple pod beans	black corn
ruby lettuce	yellow or white beets
yellow peppers	yellow zucchini, acorn squash
striped tomatoes	red onions
yellow tomatoes	golden raspberries

Old-Fashioned Vegetables

The ones you use will depend upon what is available in your area. If you have a newsletter which goes out to homeowners, ask for a few of their saved seed, especially of varieties that have been handed down to them. Be sure to request: name of vegetables, donor's name (to be mentioned in the display if the donor permits), and special cultural instructions, if any.

Ornamental Edibles

Arrange plants in a landscape or flower border-type setting, if possible, or in some way suggest ornamental uses. Label plants and describe what is eaten.

Vegetables, herbs and small fruits

artichoke	cardoon	flowering kale
sunflowers	asparagus	ornamental peppers
chives	sage	<i>Tom Thumb</i> lettuce
red okra	sesame	scarlet runner beans
ruby lettuce	comfrey	ornamental eggplants
luffa gourd	fennel	alpine strawberries

Shrubs, trees and flowers

martynia	nasturtium	Allegheny chinquapin
kiwi	blueberry	common pawpaw
pomegranate	jujube	Chinese chestnut
quince	daylilies	

Personal Styles

Perhaps you've heard or read about someone who has a unique style of gardening and could demonstrate how it is done. Here are two examples:

Ruth Stout

Many gardeners have heard about the "queen of mulch," who died a few years ago after gardening her way through her eighties. An advocate of spoiled hay mulch, Ruth Stout wrote books with intriguing titles like, Gardening Without Work, and How to Have a Green Thumb Without an Aching Back. She had a constant source of spoiled hay, which she used in an 8" or thicker mulch throughout her garden, sometimes not even bothering to untie the bales. She had few weeds, did not till or have her garden plowed, did not use fertilizers, and had few pest problems. In the spring she pulled the hay back long enough to allow the soil to warm and plant her vegetables, then re-mulched and sat back waiting for the harvest. Her books are available in most public libraries.

James Underwood Crockett

A gardener with a television program, Mr. Crockett transformed a parking lot outside the Boston station into a lush garden. His book, Crockett's Victory Garden, tells how.

Plant Type Gardens

This would probably be most effective if all five types could be displayed separately, showing the parts of each that are eaten for food. This might make an excellent 4-H display:

Underground Garden (might be divided into root, tuber, tuberous foot, rhizomes, etc.)

Potatoes, carrots, parsnips, sweet potatoes, jicama, horseradish, chicory (for coffee substitute) salsify, rutabaga, turnips, Jerusalem artichoke, radish, onions, shallots, garlic, celeriac, beets, yam, daylily

Shoots/Stems (rhizomes, or underground stems, could be included here)

Rhubarb, celery, celery cabbage, leek, asparagus, cardoon, sweet sorghum, Swiss chard, sea kale, fennel, celtuce, bamboo

Leaves

Mustards, collards, spinach, beets, chard, roquette, sorrel, cabbage, Chinese cabbage, Michihli, kale, endive, lettuces, herbs, amaranth, New Zealand spinach, witloof chicory, nasturtium, orach

Flower Parts

Brussels sprouts, broccoli, cauliflower, globe artichoke, nasturtium, daylily

Fruits/Seeds

Tomatoes, eggplant, peppers, cucumbers, squash, tomatillos, melons, pumpkins, beans, corn, peas, okra, peanuts, nasturtiums, Egyptian onions

Protein or Vegetarian Garden

various beans, peas
amaranth
peanuts
asparagus
garbanzos
edible soybeans
nut trees

lentils
sunflower seeds
black-eyed peas
cowpeas
Brussels sprouts
grains

Salad Garden

various lettuces
radishes
carrots
sprouts (indoors)
celery
endive
herbs
broccoli

witloof chicory
shallots
celtuce
cucumbers
Chinese cabbages
sugar snap peas
kohlrabi
garbanzos

tomatoes (esp. cherry)
spinach
peppers
peas/snow peas (raw)
nasturtium flowers
summer squash (raw)
cauliflower
garden cress

Shady Place Garden

lettuces	carrots	chives
beets	kale	cabbage
mustards	green onions	parsley
radish	Swiss chard	turnips

Also, methods of increasing the amount of light may be demonstrated: reflective white wall, aluminum mulches, trellising at an angle (more leaf surface exposed), planting tall plants to the North, etc.

Short-Season Garden

Most cool-weather crops would be included here, as well as early varieties of other vegetables. Displays of season-extenders (see "Special Displays, page 45), planting on the south side of soil ridges (see illustration below), windbreaks, and other ideas used to create a warmer microclimate are appropriate.

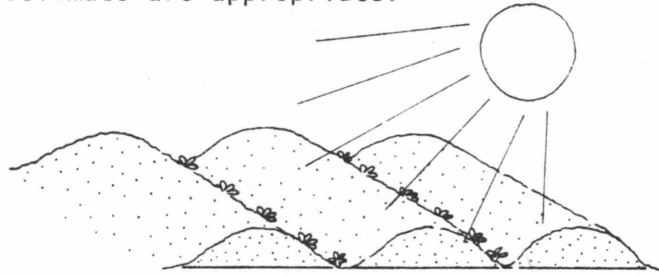
Special Vegetables

One interesting type of garden is a display of many varieties of a single vegetable. This is best done with vegetables which grow in obviously different ways or which look very different from each other, depending on the variety. There are many different kinds of beans, squash, cabbages, tomatoes, melons, or lettuces, which would be interesting enough individually to attract attention while growing. Other vegetables might be better utilized in a harvest display, since the growing plants look basically the same: corn, dry beans, carrots, peppers, and radishes. Each year is designated by the seed trade industry as "Year of the Bean" or "Year of the Squash," etc., which, of course, would be an ideal time to feature these vegetables.

Wet Place Garden

Very few plants are happy in a very wet soil, but there are some which can be planted to take advantage of these conditions. Few vegetables do well without air to their roots, especially in clay-ey soils, so ornamentals are also listed. Some of these plants can be grown in tubs or pools.

watercress	rice	water lilies
waterchestnut	lotus	horsetail
violet-stemmed taro	cattails	water poppy

APPENDIX B - IDEAS FOR WORKSHOPS AND DEMONSTRATIONS

Compost pile building and maintenance
Flowers/trees/shrubs - displays
Harvesting/Preserving
Insect and disease management
Intensive methods
Open house
Perennial planting and displays
Planting/Transplanting How-to
Pruning of shrubs, trees, and vines
Raised beds - building, preparing
Trickle irrigation, other watering devices
Walk-throughs during the season
Weed control

APPENDIX C - GARDENING IN RAISED BEDS

Raised beds seem to deserve an appendix all their own because they offer an attractive way to display plants, reduce work, and increase production per square foot. The concept of raised beds has different meanings to different people, sometimes resulting in confusion when the term is used. Hopefully, this section will help clear that up.

A raised bed can be as simple as mounding of soil when it is prepared for planting, or as complex and permanent as a multi-tiered stone or wooden structure for planting included in a landscape design for a handicapped individual. Somewhere in between is the raised bed of the French Intensive style of gardening, in which the soil is "double-dug" in wide beds, with large amounts of organic matter incorporated into the top layer, resulting in a bed raised by the added materials and air spaces. All of these types of raised beds have their virtues, as will be discussed here.

Mounding

In areas with soil which remains wet due to heavy rains, fine texture, or a high water table, mounding the soil before planting may give just enough drainage advantage to prevent rots or other root diseases which might prevent successful culture of a crop or an entire garden. Mounding is also helpful in getting soil warmed up more quickly in spring. For convenience, and to prevent the beds from drying out too quickly, these mounds are usually made wide enough to plant 2-3 rows of vegetables, generally about three feet wide. The planting area is never walked upon, thus reducing soil compaction.

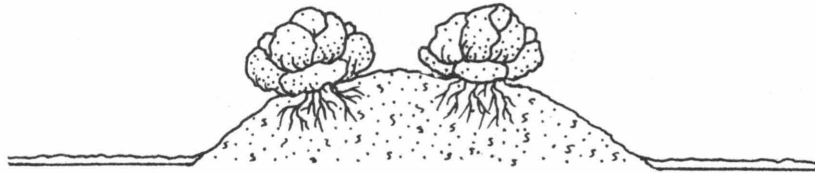

This type of raised bed is most often used by farmers who have tractor attachments which will do the mounding, but it can be done by hand, by raking or shovelling soil from pathways into the planting area. (Mounded soil such as this is used in the "biodynamic method" practiced by some organic gardeners. In this case, plants are spaced very closely and special emphasis is placed upon plant heights, root areas, and other plant interactions.) Mounded rows are especially conducive to the use of black plastic mulch, if row width is planned carefully.

French Intensive Method

More complex is the French Intensive method. Raised beds are a natural result of this practice, since organic matter and air spaces result in a "fluffy" soil which is raised above the general ground

level. The French Intensive bed is also a wide bed, usually 3'-4' wide, which is also never walked upon. The procedure is as follows:*

- (1) Outline the wide bed to be prepared with stakes or other markers.
- (2) Spread on the bed enough organic matter (compost, manure, sand if needed, etc.) to make a loose soil.
- (3) At one end dig a trench the width of the bed, one space (10"-12") wide and deep (9"-10"). Set the soil aside.

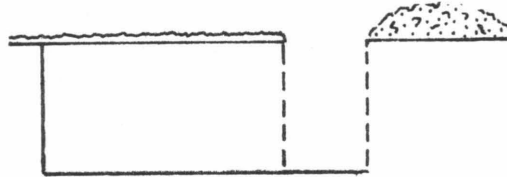

- (4) Loosen the subsoil (double-dig) in the trench with the spade to another spade depth (a total of 18"-20" down) by rocking the spade back and forth in the subsoil. Do not remove the subsoil.

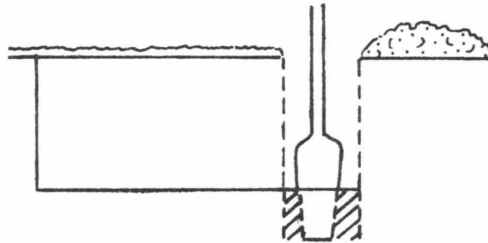

- (5) Dig an adjacent trench the same way, using the topsoil plus added compost and other materials that you dig out to fill the first trench. These materials should be well mixed.

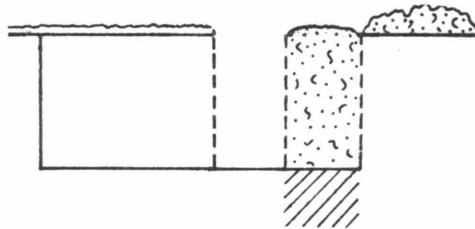

- (6) Spade the subsoil in the second trench in the same manner as you did the first.

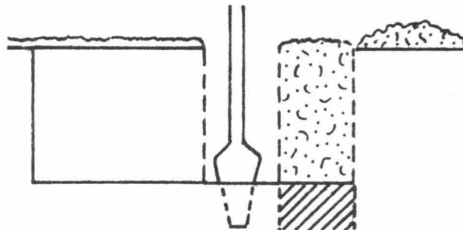

* Adapted from material in The Postage Stamp Garden Book, by Duane Newcomb (Bantam Books).

- (7) Continue down the bed until you have a trench at the end which has been double-dug. Use the topsoil laid aside from the first trench to fill the last one.

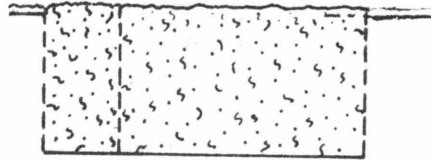

- (8) Allow the bed to settle for a few days, at least, before planting. Then dig other fertilizers and additions into the bed as needed.

This type of raised bed, as you can see, is a lot of work. However, its proponents say it is worthwhile for small gardens because the soil is easy to work thereafter and should not require further plowing or tilling if the soil is not compacted by walking or using heavy machinery in the bed. The high quality soil structure and close planting can result in high yields per square foot in a well-planned bed. Organic matter should be added every year to maintain the looseness and fertility of the soil.

There are several hand tools made especially for digging and turning soil in an established raised bed, including the U-Bar Digger, Grelinette, and the French Fourche Beche en T. A mini-cultivator (a very small, lightweight rototiller, actually) or "soil blender" may also be used. Raised beds are also quite easy to prepare for planting with just a spade, a hoe, or a shovel.

Within a raised bed, plants are set at equal distances apart, and seeds may be broadcast or spaced evenly within their growing area. Leaves of adjacent plants should just touch each other at maturity. This density of planting helps conserve moisture and control weeds.

Beds may be bordered with wood or other material if desired to hold their raised quality and delineate paths.

Constructed Beds

Finally, raised beds can be built with common building materials to any height, or any existing structure which will retain soil might be turned into a raised bed (for example, our garden boasted a tractor tire filled with soil to make a small raised bed). Such a bed can be an integral part of the landscape where attractive materials such as wood, stone, or brick are used.

Persons who are otherwise unable to garden because of difficulty bending, stooping, or using heavy tools find that raised beds allow them to garden easily. Beds may be designed to the appropriate height for use by a person confined to a wheelchair, or higher in the case of a person who can stand and lean against the bed for support. If built 3'-4' wide, the entire bed can be worked easily with hand tools, such as a trowel, a weed digger, a hand rake, a bulb planter, etc. as long as

both sides are accessible. A good soil mixture and watering during very dry periods will help bring high yields from a very small area.

For more details, see the "Special Displays" section of this manual, page 43. The slide set, "Gardening in Raised Beds," available from the Home Horticulture Extension Specialist, contains further information on construction, planting, and use of this type of raised bed.

APPENDIX D - TOOLS

<u>Necessary</u>	<u>Useful</u>
rototiller*	spade
shovel	coal shovel
hoe	pitchfork
trowels	weed-digger
rake	hand rake
measuring tape	tarps
hoses/sprinklers	buckets
sprayer/duster	lawn mower (for surrounding area)
hammer	saw/chain saw

*After several years of soil-building, raised beds should not need rototilling if soil does not become compacted.

APPENDIX E - BUILDING MATERIALS, CONTAINERS, ETC.
Suggestions and Sources

Wood - Sawmills often have "slab" wood, the rounded parts on the outside of the log which are cut off when lumber is made. This is sometimes sold for firewood during the fall and winter and so may be more available in late spring and summer. Pallets can be dismantled or used whole (three pallets make an excellent, easy compost bin when set up in a square with one side open (or add a fourth to close it). See "Special Displays," page 44. Wood scraps might be obtained from construction sites if the foreman is agreeable. Farmers often have large scrap piles, as well. The telephone company can be contacted for used poles, and the railroad lines for used ties.

Plastic, fiberglass panels, etc. - Try yard sales and flea markets for many kinds of construction materials. Building supply outlets might sell imperfects at low cost.

Containers - Types of containers which can be used are mentioned in "The Container Garden," page 42, and Publication 426-336. Some sources: grocery stores, bakeries, fast food chains, flea markets, yard sales, friends and neighbors, school cafeterias, delicatessans, etc. Be creative!

Planting materials - Department stores will sometimes give away, or sell at low cost, flats from bedding plant sales; plants can be started in used styrofoam or paper cups; popsicle sticks can be used for markers; milk cartons and jugs make good hotcaps and containers; some people start seeds in egg cartons (they have to be transplanted to larger containers later).

APPENDIX F - ORGANIC MATTER/MULCHES
(and where to get them)

- Leaves* - town dump, neighbors
- Manure* - local stables, rabbitries, poultry houses, etc. There is usually a heavy demand in early spring and fall; at other times some people have too much and are happy to get rid of excess manure.
- Sawdust* - sawmills; small mills usually do not have as high a price; add nitrogen to compensate for requirements of breakdown if used as a mulch; may form a crusty layer
- Wood chips* - same as sawdust. Wood chips break down slowly and will last longer. It's also possible to have tree trimmers dump wood chips if they are in your area.
- Straw* - expensive at garden stores, up to \$3.75/bale. Try local farmers, trading journals. Watch for stickers/weeds.
- Hay* - check with local farmers for spoiled hay. It must be laid down thickly (8" or more) if used for mulch to prevent weed growth. Makes excellent compost.
- Grass clippings* - neighbors, grounds maintenance for public buildings. An excellent mulch which breaks down fast and adds nitrogen to the soil; if laid down too thickly, water may not be able to penetrate. Avoid clippings from lawns treated with herbicide.
- Corn cobs* - local mill that shells corn; should be shredded. These are light and will blow away; decompose fast. Good addition to compost pile
- Pine needles* - town dump, neighbors
- Newspaper* - excellent for weed control if put down in layers of four sheets or more with some other material on top to hold it down. Easily obtained from friends, neighbors.
- Gravel, stones* - from quarry or someone's rocky garden; warms soil fast; permanent. Use only on areas which will not be tilled.
- Plant wastes* - compost all plant wastes from your garden and kitchen; use tea leaves and coffee grounds; grow your own mulch or compost plants - comfrey is an excellent mulch; a small patch of alfalfa will provide composting material
- Miscellaneous* - depending on your area and the type of industry there, you might be able to obtain spent hops, wastes from market produce, oyster shells (ground), etc. Black plastic and aluminum may be purchased for mulching.

Also see Publication 426-326, "Mulches for the Home Garden"

APPENDIX G - SEED, PLANT, & SUPPLY SOURCES
(Also see list in Virginia Home Food Production Guide)

Burgess, 905 Four Seasons Road, Bloomington, IL 61701
Burpee Seed Co., 300 Park Avenue, Warminster, PA 18991
Bountiful Ridge Nurseries, Princess Anne, MD 21853
Comstock, Ferre, & Co., 236 Main Street, Wethersfield, CT 06109
Epicure Seeds, Box 69, Avon, NY 14414
Exotica Seed Co., 8033 Sunset Blvd., Suite 125, West Hollywood, CA 90046
Henry Field Seed & Nursery Co., Shenandoah, IA 51602
Dean Foster Nurseries, Route 2, Hartford, MI 49057
Gurney's, Yankton, SD 57079
Harris Seeds, Moreton Farm, Rochester, NY 14624
Hastings, 434 Marietta Street, NW, P. O. Box 4274, Atlanta, GA 30302
Hemlock Hill Herb Farm, Hemlock Hill Road, Litchfield, CT 06759
J. L. Hudson, Seedsman, P. O. Box 1058, Redwood City, CA 94064
Jackson & Perkins Co., Medford, OR 97501
Le Jardin du Gourmet, West Danville, VT 05873
Johnny's Selected Seeds, Organic Seed & Crop Research, Albion, ME 04910
Kitazawa Seed Co., 356 W. Taylor Street, San Jose, CA 95110
Earl May Seed & Nursery Co., Shenandoah, IA 51603
Mellinger's, Inc., North Lima, OH 44452
Nichols Garden Nursery, 1190 North Pacific Highway, Albany, OR 97321
Northrup King Co., P. O. Box 959, Minneapolis, MN 55440
Park Seed Co., S. C. Hwy. 254 N., Greenwood, SC 29647
R. H. Shumway, Seedsman, Rockford, IL 61101
Stillcopper Herb Farm, Route 1, Box 186, Brookneal, VA 24528
Stokes Seeds, Box 548, Buffalo, NY 14240
Thompson & Morgan, Inc., P. O. Box 100, Farmingdale, NJ 07727
Twilley Seeds, P. O. Box 65, Trevoise, PA 19047
Unwins, Box 9, Farmingdale, NJ 07727
Vermont Bean Seed Co., Garden Lane, Bomoseen, VT 05732
Waynesboro Nurseries, P. O. Box 987, Waynesboro, VA 22980

* * * * *

The information given herein is for educational purposes only. Reference to commercial companies, products, or trade names is made with the understanding that no discrimination is intended and no endorsement by Cooperative Extension Service is implied.

