

Wrist Worn Device to Aid the Elderly to Age in Place

Latonya Rochelle Scott

Thesis submitted to the faculty of the
Virginia Polytechnic Institute and State University
in partial fulfillment of the requirements for the degree of

MASTER OF SCIENCE

In

Mechanical Engineering

Alfred L. Wicks, Chair

John P. Bird

Andre Muelenaer

May 7th, 2014

Blacksburg, Virginia

Keywords: Wrist worn device, heart disease, stroke, falling/fainting, blood glucose

Copyright © 2014, Latonya Rochelle Scott

Draft 09/01/2009

(Questions? Concerns? Contact Gail McMillan, Director of the Digital Library and Archives at Virginia Tech's University Libraries: gailmac@vt.edu)

(Please ensure that Javascript is enabled on your browser before using this tool.)

Virginia Tech ETD Fair Use Analysis Results

This is not a replacement for professional legal advice but an effort to assist you in making a sound decision.

Name: Latonya Scott

Description of item under review for fair use: "The Stroke Center at University Hospital," 2013. [Online]. Available: <http://www.uhnj.org/stroke/stats.htm>. [Accessed 6 june 2013]

Report generated on: 09-19-2014 at : 22:57:12

Based on the information you provided:

Factor 1

Your consideration of the purpose and character of your use of the copyright work weighs: *in favor of fair use*

Factor 2

Your consideration of the nature of the copyrighted work you used weighs: *against fair use*

Factor 3

Your consideration of the amount and substantiality of your use of the copyrighted work weighs: *in favor of fair use*

Factor 4

Your consideration of the effect or potential effect on the market after your use of the copyrighted work weighs:

in favor of fair use

Based on the information you provided, your use of the copyrighted work weighs: *in favor of fair use*



Draft 09/01/2009

(Questions? Concerns? Contact Gail McMillan, Director of the Digital Library and Archives at Virginia Tech's University Libraries: gailmac@vt.edu)

(Please ensure that Javascript is enabled on your browser before using this tool.)

Virginia Tech ETD Fair Use Analysis Results

This is not a replacement for professional legal advice but an effort to assist you in making a sound decision.

Name: Latonya Scott

Description of item under review for fair use: AHA, "Heart and Stroke Statistics," [Online]. Available: http://www.heart.org/HEARTORG/General/Heart-and-Stroke-Association-Statistics_UCM_319064_SubHomePage.jsp. [Accessed 8 July 2013]

Report generated on: 09-19-2014 at : 22:57:52

Based on the information you provided:

Factor 1

Your consideration of the purpose and character of your use of the copyright work weighs: *in favor of fair use*

Factor 2

Your consideration of the nature of the copyrighted work you used weighs: *against fair use*

Factor 3

Your consideration of the amount and substantiality of your use of the copyrighted work weighs: *in favor of fair use*

Factor 4

Your consideration of the effect or potential effect on the market after your use of the copyrighted work weighs:

in favor of fair use

Based on the information you provided, your use of the copyrighted work weighs: *in favor of fair use*



Draft 09/01/2009

(Questions? Concerns? Contact Gail McMillan, Director of the Digital Library and Archives at Virginia Tech's University Libraries: gailmac@vt.edu)

(Please ensure that Javascript is enabled on your browser before using this tool.)

Virginia Tech ETD Fair Use Analysis Results

This is not a replacement for professional legal advice but an effort to assist you in making a sound decision.

Name: Latonya Scott

Description of item under review for fair use: C. Midey, "Response times play big part in Stroke patients' recovery," 24 February 2012. [Online]. Available: <http://www.azcentral.com/news/azliving/articles/2012/02/24/20120224response-times-play-big-part-stroke-patients-recovery.html>. [Accessed 8 July 2013]

Report generated on: 09-19-2014 at : 22:58:30

Based on the information you provided:

Factor 1

Your consideration of the purpose and character of your use of the copyright work weighs: *in favor of fair use*

Factor 2

Your consideration of the nature of the copyrighted work you used weighs: *against fair use*

Factor 3

Your consideration of the amount and substantiality of your use of the copyrighted work weighs: *in favor of fair use*

Factor 4

Your consideration of the effect or potential effect on the market after your use of the copyrighted work weighs:

in favor of fair use

Based on the information you provided, your use of the copyrighted work weighs: *in favor of fair use*



Draft 09/01/2009

(Questions? Concerns? Contact Gail McMillan, Director of the Digital Library and Archives at Virginia Tech's University Libraries: gailmac@vt.edu)

(Please ensure that Javascript is enabled on your browser before using this tool.)

Virginia Tech ETD Fair Use Analysis Results

This is not a replacement for professional legal advice but an effort to assist you in making a sound decision.

Name: Latonya Scott

Description of item under review for fair use: CDC, "Stroke Facts," [Online]. Available: <http://www.cdc.gov/stroke/facts.htm>. [Accessed 8 July 2013]

Report generated on: 09-19-2014 at : 22:59:17

Based on the information you provided:

Factor 1

Your consideration of the purpose and character of your use of the copyright work weighs: *in favor of fair use*

Factor 2

Your consideration of the nature of the copyrighted work you used weighs: *against fair use*

Factor 3

Your consideration of the amount and substantiality of your use of the copyrighted work weighs: *in favor of fair use*

Factor 4

Your consideration of the effect or potential effect on the market after your use of the copyrighted work weighs:

in favor of fair use

Based on the information you provided, your use of the copyrighted work weighs: *in favor of fair use*



Draft 09/01/2009

(Questions? Concerns? Contact Gail McMillan, Director of the Digital Library and Archives at Virginia Tech's University Libraries: gailmac@vt.edu)

(Please ensure that Javascript is enabled on your browser before using this tool.)

Virginia Tech ETD Fair Use Analysis Results

This is not a replacement for professional legal advice but an effort to assist you in making a sound decision.

Name: Latonya Scott

Description of item under review for fair use: "54 Random Facts About . . . Share on facebookShare on twitterShare on google_plusone_shareShare on pinterest_shareShare on stumbleuponShare on redditShare on tumblrMore Sharing Services," 25 March 2010. [Online]. Available: <http://facts.randomhistory.com/heart-disease-facts.html>. [Accessed 8 July 2013]

Report generated on: 09-19-2014 at : 23:00:27

Based on the information you provided:

Factor 1

Your consideration of the purpose and character of your use of the copyright work weighs: *in favor of fair use*

Factor 2

Your consideration of the nature of the copyrighted work you used weighs: *against fair use*

Factor 3

Your consideration of the amount and substantiality of your use of the copyrighted work weighs: *in favor of fair use*

Factor 4

Your consideration of the effect or potential effect on the market after your use of the copyrighted work weighs:
in favor of fair use

Based on the information you provided, your use of the copyrighted work weighs: *in favor of fair use*



Draft 09/01/2009

(Questions? Concerns? Contact Gail McMillan, Director of the Digital Library and Archives at Virginia Tech's University Libraries: gailmac@vt.edu)

(Please ensure that Javascript is enabled on your browser before using this tool.)

Virginia Tech ETD Fair Use Analysis Results

This is not a replacement for professional legal advice but an effort to assist you in making a sound decision.

Name: Latonya Scott

Description of item under review for fair use: S. Tao, M. Kudo and H. and Nonaka, "Privacy-preserved fall detection by an infrared ceiling sensor network," NCBI, vol. 12, no. 12, pp. 16920-16936, 2012

Report generated on: 09-19-2014 at : 23:01:27

Based on the information you provided:

Factor 1

Your consideration of the purpose and character of your use of the copyright work weighs: *in favor of fair use*

Factor 2

Your consideration of the nature of the copyrighted work you used weighs: *in favor of fair use*

Factor 3

Your consideration of the amount and substantiality of your use of the copyrighted work weighs: *in favor of fair use*

Factor 4

Your consideration of the effect or potential effect on the market after your use of the copyrighted work weighs:

in favor of fair use

Based on the information you provided, your use of the copyrighted work weighs: *in favor of fair use*



Draft 09/01/2009

(Questions? Concerns? Contact Gail McMillan, Director of the Digital Library and Archives at Virginia Tech's University Libraries: gailmac@vt.edu)

(Please ensure that Javascript is enabled on your browser before using this tool.)

Virginia Tech ETD Fair Use Analysis Results

This is not a replacement for professional legal advice but an effort to assist you in making a sound decision.

Name: Latonya Scott

Description of item under review for fair use: [Online]. Available: <http://www.pololu.com/product/2469>. [Accessed 9 September 2013]

Report generated on: 09-19-2014 at : 22:48:06

Based on the information you provided:

Factor 1

Your consideration of the purpose and character of your use of the copyright work weighs: *in favor of fair use*

Factor 2

Your consideration of the nature of the copyrighted work you used weighs: *against fair use*

Factor 3

Your consideration of the amount and substantiality of your use of the copyrighted work weighs: *in favor of fair use*

Factor 4

Your consideration of the effect or potential effect on the market after your use of the copyrighted work weighs:

in favor of fair use

Based on the information you provided, your use of the copyrighted work weighs: *in favor of fair use*



Draft 09/01/2009

(Questions? Concerns? Contact Gail McMillan, Director of the Digital Library and Archives at Virginia Tech's University Libraries: gailmac@vt.edu)

(Please ensure that Javascript is enabled on your browser before using this tool.)

Virginia Tech ETD Fair Use Analysis Results

This is not a replacement for professional legal advice but an effort to assist you in making a sound decision.

Name: Latonya Scott

Description of item under review for fair use: [Online]. Available: http://cdn.shopify.com/s/files/1/0100/6632/products/PulseSensorAmpedFinger-web_2_1024x1024.jpg?v=1348514131. [Accessed 9 September 2013]

Report generated on: 09-19-2014 at : 22:49:29

Based on the information you provided:

Factor 1

Your consideration of the purpose and character of your use of the copyright work weighs: *in favor of fair use*

Factor 2

Your consideration of the nature of the copyrighted work you used weighs: *against fair use*

Factor 3

Your consideration of the amount and substantiality of your use of the copyrighted work weighs: *in favor of fair use*

Factor 4

Your consideration of the effect or potential effect on the market after your use of the copyrighted work weighs:

in favor of fair use

Based on the information you provided, your use of the copyrighted work weighs: *in favor of fair use*



Draft 09/01/2009

(Questions? Concerns? Contact Gail McMillan, Director of the Digital Library and Archives at Virginia Tech's University Libraries: gailmac@vt.edu)

(Please ensure that Javascript is enabled on your browser before using this tool.)

Virginia Tech ETD Fair Use Analysis Results

This is not a replacement for professional legal advice but an effort to assist you in making a sound decision.

Name: Latonya Scott

Description of item under review for fair use: [Online]. Available: <https://www.adafruit.com/products/1296>. [Accessed 9 September 2013]

Report generated on: 09-19-2014 at : 22:51:34

Based on the information you provided:

Factor 1

Your consideration of the purpose and character of your use of the copyright work weighs: *in favor of fair use*

Factor 2

Your consideration of the nature of the copyrighted work you used weighs: *against fair use*

Factor 3

Your consideration of the amount and substantiality of your use of the copyrighted work weighs: *in favor of fair use*

Factor 4

Your consideration of the effect or potential effect on the market after your use of the copyrighted work weighs:

in favor of fair use

Based on the information you provided, your use of the copyrighted work weighs: *in favor of fair use*



Draft 09/01/2009

(Questions? Concerns? Contact Gail McMillan, Director of the Digital Library and Archives at Virginia Tech's University Libraries: gailmac@vt.edu)

(Please ensure that Javascript is enabled on your browser before using this tool.)

Virginia Tech ETD Fair Use Analysis Results

This is not a replacement for professional legal advice but an effort to assist you in making a sound decision.

Name: Latonya Scott

Description of item under review for fair use: [Online]. Available: <http://www.robotshop.com/en/vc0706-uart-vga-camera.html>. [Accessed 9 September 2013]

Report generated on: 09-19-2014 at : 22:52:55

Based on the information you provided:

Factor 1

Your consideration of the purpose and character of your use of the copyright work weighs: *in favor of fair use*

Factor 2

Your consideration of the nature of the copyrighted work you used weighs: *against fair use*

Factor 3

Your consideration of the amount and substantiality of your use of the copyrighted work weighs: *in favor of fair use*

Factor 4

Your consideration of the effect or potential effect on the market after your use of the copyrighted work weighs:

in favor of fair use

Based on the information you provided, your use of the copyrighted work weighs: *in favor of fair use*



Draft 09/01/2009

(Questions? Concerns? Contact Gail McMillan, Director of the Digital Library and Archives at Virginia Tech's University Libraries: gailmac@vt.edu)

(Please ensure that Javascript is enabled on your browser before using this tool.)

Virginia Tech ETD Fair Use Analysis Results

This is not a replacement for professional legal advice but an effort to assist you in making a sound decision.

Name: Latonya Scott

Description of item under review for fair use: "The Stroke Center at University Hospital," 2013. [Online]. Available: <http://www.uhnj.org/stroke/stats.htm>. [Accessed 6 june 2013]

Report generated on: 09-19-2014 at : 22:57:12

Based on the information you provided:

Factor 1

Your consideration of the purpose and character of your use of the copyright work weighs: *in favor of fair use*

Factor 2

Your consideration of the nature of the copyrighted work you used weighs: *against fair use*

Factor 3

Your consideration of the amount and substantiality of your use of the copyrighted work weighs: *in favor of fair use*

Factor 4

Your consideration of the effect or potential effect on the market after your use of the copyrighted work weighs:

in favor of fair use

Based on the information you provided, your use of the copyrighted work weighs: *in favor of fair use*



Draft 09/01/2009

(Questions? Concerns? Contact Gail McMillan, Director of the Digital Library and Archives at Virginia Tech's University Libraries: gailmac@vt.edu)

(Please ensure that Javascript is enabled on your browser before using this tool.)

Virginia Tech ETD Fair Use Analysis Results

This is not a replacement for professional legal advice but an effort to assist you in making a sound decision.

Name: Latonya Scott

Description of item under review for fair use: AHA, "Heart and Stroke Statistics," [Online]. Available: http://www.heart.org/HEARTORG/General/Heart-and-Stroke-Association-Statistics_UCM_319064_SubHomePage.jsp. [Accessed 8 July 2013]

Report generated on: 09-19-2014 at : 22:57:52

Based on the information you provided:

Factor 1

Your consideration of the purpose and character of your use of the copyright work weighs: *in favor of fair use*

Factor 2

Your consideration of the nature of the copyrighted work you used weighs: *against fair use*

Factor 3

Your consideration of the amount and substantiality of your use of the copyrighted work weighs: *in favor of fair use*

Factor 4

Your consideration of the effect or potential effect on the market after your use of the copyrighted work weighs:

in favor of fair use

Based on the information you provided, your use of the copyrighted work weighs: *in favor of fair use*



Draft 09/01/2009

(Questions? Concerns? Contact Gail McMillan, Director of the Digital Library and Archives at Virginia Tech's University Libraries: gailmac@vt.edu)

(Please ensure that Javascript is enabled on your browser before using this tool.)

Virginia Tech ETD Fair Use Analysis Results

This is not a replacement for professional legal advice but an effort to assist you in making a sound decision.

Name: Latonya Scott

Description of item under review for fair use: C. Midey, "Response times play big part in Stroke patients' recovery," 24 February 2012. [Online]. Available: <http://www.azcentral.com/news/azliving/articles/2012/02/24/20120224response-times-play-big-part-stroke-patients-recovery.html>. [Accessed 8 July 2013]

Report generated on: 09-19-2014 at : 22:58:30

Based on the information you provided:

Factor 1

Your consideration of the purpose and character of your use of the copyright work weighs: *in favor of fair use*

Factor 2

Your consideration of the nature of the copyrighted work you used weighs: *against fair use*

Factor 3

Your consideration of the amount and substantiality of your use of the copyrighted work weighs: *in favor of fair use*

Factor 4

Your consideration of the effect or potential effect on the market after your use of the copyrighted work weighs:

in favor of fair use

Based on the information you provided, your use of the copyrighted work weighs: *in favor of fair use*



Draft 09/01/2009

(Questions? Concerns? Contact Gail McMillan, Director of the Digital Library and Archives at Virginia Tech's University Libraries: gailmac@vt.edu)

(Please ensure that Javascript is enabled on your browser before using this tool.)

Virginia Tech ETD Fair Use Analysis Results

This is not a replacement for professional legal advice but an effort to assist you in making a sound decision.

Name: Latonya Scott

Description of item under review for fair use: CDC, "Stroke Facts," [Online]. Available: <http://www.cdc.gov/stroke/facts.htm>. [Accessed 8 July 2013]

Report generated on: 09-19-2014 at : 22:59:17

Based on the information you provided:

Factor 1

Your consideration of the purpose and character of your use of the copyright work weighs: *in favor of fair use*

Factor 2

Your consideration of the nature of the copyrighted work you used weighs: *against fair use*

Factor 3

Your consideration of the amount and substantiality of your use of the copyrighted work weighs: *in favor of fair use*

Factor 4

Your consideration of the effect or potential effect on the market after your use of the copyrighted work weighs:

in favor of fair use

Based on the information you provided, your use of the copyrighted work weighs: *in favor of fair use*



Draft 09/01/2009

(Questions? Concerns? Contact Gail McMillan, Director of the Digital Library and Archives at Virginia Tech's University Libraries: gailmac@vt.edu)

(Please ensure that Javascript is enabled on your browser before using this tool.)

Virginia Tech ETD Fair Use Analysis Results

This is not a replacement for professional legal advice but an effort to assist you in making a sound decision.

Name: Latonya Scott

Description of item under review for fair use: "54 Random Facts About . . . Share on facebookShare on twitterShare on google_plusone_shareShare on pinterest_shareShare on stumbleuponShare on redditShare on tumblrMore Sharing Services," 25 March 2010. [Online]. Available: <http://facts.randomhistory.com/heart-disease-facts.html>. [Accessed 8 July 2013]

Report generated on: 09-19-2014 at : 23:00:27

Based on the information you provided:

Factor 1

Your consideration of the purpose and character of your use of the copyright work weighs: *in favor of fair use*

Factor 2

Your consideration of the nature of the copyrighted work you used weighs: *against fair use*

Factor 3

Your consideration of the amount and substantiality of your use of the copyrighted work weighs: *in favor of fair use*

Factor 4

Your consideration of the effect or potential effect on the market after your use of the copyrighted work weighs:
in favor of fair use

Based on the information you provided, your use of the copyrighted work weighs: *in favor of fair use*



Draft 09/01/2009

(Questions? Concerns? Contact Gail McMillan, Director of the Digital Library and Archives at Virginia Tech's University Libraries: gailmac@vt.edu)

(Please ensure that Javascript is enabled on your browser before using this tool.)

Virginia Tech ETD Fair Use Analysis Results

This is not a replacement for professional legal advice but an effort to assist you in making a sound decision.

Name: Latonya Scott

Description of item under review for fair use: S. Tao, M. Kudo and H. and Nonaka, "Privacy-preserved fall detection by an infrared ceiling sensor network," NCBI, vol. 12, no. 12, pp. 16920-16936, 2012

Report generated on: 09-19-2014 at : 23:01:27

Based on the information you provided:

Factor 1

Your consideration of the purpose and character of your use of the copyright work weighs: *in favor of fair use*

Factor 2

Your consideration of the nature of the copyrighted work you used weighs: *in favor of fair use*

Factor 3

Your consideration of the amount and substantiality of your use of the copyrighted work weighs: *in favor of fair use*

Factor 4

Your consideration of the effect or potential effect on the market after your use of the copyrighted work weighs:

in favor of fair use

Based on the information you provided, your use of the copyrighted work weighs: *in favor of fair use*



SPRINGER LICENSE TERMS AND CONDITIONS

Sep 20, 2014

This is a License Agreement between Latonya Scott ("You") and Springer ("Springer") provided by Copyright Clearance Center ("CCC"). The license consists of your order details, the terms and conditions provided by Springer, and the payment terms and conditions.

All payments must be made in full to CCC. For payment instructions, please see information listed at the bottom of this form.

License Number	3473351441947
License date	Sep 20, 2014
Licensed content publisher	Springer
Licensed content publication	Springer eBook
Licensed content title	A wearable wireless ECG sensor: a design with a minimal number of parts
Licensed content author	E. S. Valchinov
Licensed content date	Jan 1, 2010
Type of Use	Thesis/Dissertation
Portion	Figures
Author of this Springer article	No
Order reference number	None
Original figure numbers	figures 1 and 4
Title of your thesis / dissertation	Wrist Worn Device to Aid the Elderly to Age in Place
Expected completion date	Sep 2014
Estimated size(pages)	126
Total	0.00 USD

[Terms and Conditions](#)

Introduction

The publisher for this copyrighted material is Springer Science + Business Media. By clicking "accept" in connection with completing this licensing transaction, you agree that the following terms and conditions apply to this transaction (along with the Billing and Payment terms and conditions established by Copyright Clearance Center, Inc. ("CCC"), at the time that you opened your Rightslink account and that are available at any time at <http://myaccount.copyright.com>).

Limited License

With reference to your request to reprint in your thesis material on which Springer Science and Business Media control the copyright, permission is granted, free of charge, for the use indicated in your enquiry.

Licenses are for one-time use only with a maximum distribution equal to the number that you identified in the licensing process.

This License includes use in an electronic form, provided its password protected or on the university's intranet or repository, including UMI (according to the definition at the Sherpa website: <http://www.sherpa.ac.uk/romeo/>). For any other electronic use, please contact Springer at (permissions.dordrecht@springer.com or permissions.heidelberg@springer.com).

The material can only be used for the purpose of defending your thesis limited to university-use only. If the thesis is going to be published, permission needs to be re-obtained (selecting "book/textbook" as the type of use).

Although Springer holds copyright to the material and is entitled to negotiate on rights, this license is only valid, subject to a courtesy information to the author (address is given with the article/chapter) and provided it concerns original material which does not carry references to other sources (if material in question appears with credit to another source, authorization from that source is required as well).

Permission free of charge on this occasion does not prejudice any rights we might have to charge for reproduction of our copyrighted material in the future.

Altering/Modifying Material: Not Permitted

You may not alter or modify the material in any manner. Abbreviations, additions, deletions and/or any other alterations shall be made only with prior written authorization of the

author(s) and/or Springer Science + Business Media. (Please contact Springer at (permissions.dordrecht@springer.com or permissions.heidelberg@springer.com)

Reservation of Rights

Springer Science + Business Media reserves all rights not specifically granted in the combination of (i) the license details provided by you and accepted in the course of this licensing transaction, (ii) these terms and conditions and (iii) CCC's Billing and Payment terms and conditions.

Copyright Notice:Disclaimer

You must include the following copyright and permission notice in connection with any reproduction of the licensed material: "Springer and the original publisher /journal title, volume, year of publication, page, chapter/article title, name(s) of author(s), figure number(s), original copyright notice) is given to the publication in which the material was originally published, by adding; with kind permission from Springer Science and Business Media"

Warranties: None

Example 1: Springer Science + Business Media makes no representations or warranties with respect to the licensed material.

Example 2: Springer Science + Business Media makes no representations or warranties with respect to the licensed material and adopts on its own behalf the limitations and disclaimers established by CCC on its behalf in its Billing and Payment terms and conditions for this licensing transaction.

Indemnity

You hereby indemnify and agree to hold harmless Springer Science + Business Media and CCC, and their respective officers, directors, employees and agents, from and against any and all claims arising out of your use of the licensed material other than as specifically authorized pursuant to this license.

No Transfer of License

This license is personal to you and may not be sublicensed, assigned, or transferred by you to any other person without Springer Science + Business Media's written permission.

No Amendment Except in Writing

This license may not be amended except in a writing signed by both parties (or, in the case

of Springer Science + Business Media, by CCC on Springer Science + Business Media's behalf).

Objection to Contrary Terms

Springer Science + Business Media hereby objects to any terms contained in any purchase order, acknowledgment, check endorsement or other writing prepared by you, which terms are inconsistent with these terms and conditions or CCC's Billing and Payment terms and conditions. These terms and conditions, together with CCC's Billing and Payment terms and conditions (which are incorporated herein), comprise the entire agreement between you and Springer Science + Business Media (and CCC) concerning this licensing transaction. In the event of any conflict between your obligations established by these terms and conditions and those established by CCC's Billing and Payment terms and conditions, these terms and conditions shall control.

Jurisdiction

All disputes that may arise in connection with this present License, or the breach thereof, shall be settled exclusively by arbitration, to be held in The Netherlands, in accordance with Dutch law, and to be conducted under the Rules of the 'Netherlands Arbitrage Instituut' (Netherlands Institute of Arbitration). **OR:**

All disputes that may arise in connection with this present License, or the breach thereof, shall be settled exclusively by arbitration, to be held in the Federal Republic of Germany, in accordance with German law.

Other terms and conditions:

v1.3

Questions? customercare@copyright.com or +1-855-239-3415 (toll free in the US) or +1-978-646-2777.

Gratis licenses (referencing \$0 in the Total field) are free. Please retain this printable license for your reference. No payment is required.



RightsLink®

Home Account Info Help



Title: A wireless wearable ECG sensor for long-term applications

Logged in as:
Latonya Scott

Author: Nemati, E.; Deen, M.J.; Mondal, T.

LOGOUT

Publication: IEEE Communications Magazine

Publisher: IEEE

Date: January 2012

Copyright © 2012, IEEE

Thesis / Dissertation Reuse

The IEEE does not require individuals working on a thesis to obtain a formal reuse license, however, you may print out this statement to be used as a permission grant:

Requirements to be followed when using any portion (e.g., figure, graph, table, or textual material) of an IEEE copyrighted paper in a thesis:

- 1) In the case of textual material (e.g., using short quotes or referring to the work within these papers) users must give full credit to the original source (author, paper, publication) followed by the IEEE copyright line © 2011 IEEE.
- 2) In the case of illustrations or tabular material, we require that the copyright line © [Year of original publication] IEEE appear prominently with each reprinted figure and/or table.
- 3) If a substantial portion of the original paper is to be used, and if you are not the senior author, also obtain the senior author's approval.

Requirements to be followed when using an entire IEEE copyrighted paper in a thesis:

- 1) The following IEEE copyright/ credit notice should be placed prominently in the references: © [year of original publication] IEEE. Reprinted, with permission, from [author names, paper title, IEEE publication title, and month/year of publication]
- 2) Only the accepted version of an IEEE copyrighted paper can be used when posting the paper or your thesis on-line.
- 3) In placing the thesis on the author's university website, please display the following message in a prominent place on the website: In reference to IEEE copyrighted material which is used with permission in this thesis, the IEEE does not endorse any of [university/educational entity's name goes here]'s products or services. Internal or personal use of this material is permitted. If interested in reprinting/republishing IEEE copyrighted material for advertising or promotional purposes or for creating new collective works for resale or redistribution, please go to http://www.ieee.org/publications_standards/publications/rights/rights_link.html to learn how to obtain

a License from RightsLink.

If applicable, University Microfilms and/or ProQuest Library, or the Archives of Canada may supply single copies of the dissertation.

BACK

CLOSE WINDOW

Copyright © 2014 [Copyright Clearance Center, Inc.](#) All Rights Reserved. [Privacy statement](#).
Comments? We would like to hear from you. E-mail us at customercare@copyright.com

Draft 09/01/2009

(Questions? Concerns? Contact Gail McMillan, Director of the Digital Library and Archives at Virginia Tech's University Libraries: gailmac@vt.edu)

(Please ensure that Javascript is enabled on your browser before using this tool.)

Virginia Tech ETD Fair Use Analysis Results

This is not a replacement for professional legal advice but an effort to assist you in making a sound decision.

Name: Latonya Scott

Description of item under review for fair use: Lakshmi, "Optical Sensor Based Instrument for Correlative Analysis of Human ECG and Breathing Signal," International Journal of Electronic Engineering Research, vol. 1, no. 4, pp. 287-298, 2009

Report generated on: 09-19-2014 at : 21:44:49

Based on the information you provided:

Factor 1

Your consideration of the purpose and character of your use of the copyright work weighs: *in favor of fair use*

Factor 2

Your consideration of the nature of the copyrighted work you used weighs: *in favor of fair use*

Factor 3

Your consideration of the amount and substantiality of your use of the copyrighted work weighs: *in favor of fair use*

Factor 4

Your consideration of the effect or potential effect on the market after your use of the copyrighted work weighs:

in favor of fair use

Based on the information you provided, your use of the copyrighted work weighs: *in favor of fair use*



Draft 09/01/2009

(Questions? Concerns? Contact Gail McMillan, Director of the Digital Library and Archives at Virginia Tech's University Libraries: gailmac@vt.edu)

(Please ensure that Javascript is enabled on your browser before using this tool.)

Virginia Tech ETD Fair Use Analysis Results

This is not a replacement for professional legal advice but an effort to assist you in making a sound decision.

Name: Latonya Scott

Description of item under review for fair use: S. A. Kingsley, S. Sriram, A. Pollick and J. and Marsh, "Revolutionary optical sensor for physiological monitoring in the battlefield," Sensors, and Command, Control, Communications, and Intelligence (C3I) Technologies for Homeland Security and Homeland Defense III, vol. 5403, no. Carapezza, Edward M, pp. 66-77, 2004

Report generated on: 09-19-2014 at : 21:50:00

Based on the information you provided:

Factor 1

Your consideration of the purpose and character of your use of the copyright work weighs: *in favor of fair use*

Factor 2

Your consideration of the nature of the copyrighted work you used weighs: *in favor of fair use*

Factor 3

Your consideration of the amount and substantiality of your use of the copyrighted work weighs: *in favor of fair use*

Factor 4

Your consideration of the effect or potential effect on the market after your use of the copyrighted work weighs:
in favor of fair use

Based on the information you provided, your use of the copyrighted work weighs: *in favor of fair use*





RightsLink®

[Home](#)
[Account Info](#)
[Help](#)

Title: Wireless Non-contact EEG/ECG Electrodes for Body Sensor Networks

Conference Proceedings: Body Sensor Networks (BSN), 2010 International Conference on

Author: Chi, Y.M.; Cauwenberghs, G.

Publisher: IEEE

Date: 7-9 June 2010

Copyright © 2010, IEEE

Logged in as:

Latonya Scott

Account #:

3000835974

[LOGOUT](#)

Thesis / Dissertation Reuse

The IEEE does not require individuals working on a thesis to obtain a formal reuse license, however, you may print out this statement to be used as a permission grant:

Requirements to be followed when using any portion (e.g., figure, graph, table, or textual material) of an IEEE copyrighted paper in a thesis:

- 1) In the case of textual material (e.g., using short quotes or referring to the work within these papers) users must give full credit to the original source (author, paper, publication) followed by the IEEE copyright line © 2011 IEEE.
- 2) In the case of illustrations or tabular material, we require that the copyright line © [Year of original publication] IEEE appear prominently with each reprinted figure and/or table.
- 3) If a substantial portion of the original paper is to be used, and if you are not the senior author, also obtain the senior author's approval.

Requirements to be followed when using an entire IEEE copyrighted paper in a thesis:

- 1) The following IEEE copyright/ credit notice should be placed prominently in the references: © [year of original publication] IEEE. Reprinted, with permission, from [author names, paper title, IEEE publication title, and month/year of publication]
- 2) Only the accepted version of an IEEE copyrighted paper can be used when posting the paper or your thesis on-line.
- 3) In placing the thesis on the author's university website, please display the following message in a prominent place on the website: In reference to IEEE copyrighted material which is used with permission in this thesis, the IEEE does not endorse any of [university/educational entity's name goes here]'s products or services. Internal or personal use of this material is permitted. If interested in reprinting/republishing IEEE copyrighted material for advertising or promotional purposes or for

creating new collective works for resale or redistribution, please go to http://www.ieee.org/publications_standards/publications/rights/rights_link.html to learn how to obtain a License from RightsLink.

If applicable, University Microfilms and/or ProQuest Library, or the Archives of Canada may supply single copies of the dissertation.

[BACK](#)[CLOSE WINDOW](#)

Copyright © 2014 [Copyright Clearance Center, Inc.](#) All Rights Reserved. [Privacy statement.](#)
Comments? We would like to hear from you. E-mail us at customercare@copyright.com



[Creative Commons](#)

Creative Commons License Deed

Attribution 3.0 Unported (CC BY 3.0)

This is a human-readable summary of (and not a substitute for) the [license](#).
[Disclaimer](#)

You are free to:

Share — copy and redistribute the material in any medium or format

Adapt — remix, transform, and build upon the material

for any purpose, even commercially.

The licensor cannot revoke these freedoms as long as you follow the license terms.

Under the following terms:



Attribution — You must give [appropriate credit](#), provide a link to the license, and [indicate if changes were made](#). You may do so in any reasonable manner, but not in any way that suggests the licensor endorses you or your use.

No additional restrictions — You may not apply legal terms or [technological measures](#) that legally restrict others from doing anything the license permits.

Notices:



You do not have to comply with the license for elements of the material in the public domain or where your use is permitted by an applicable [exception or limitation](#).

No warranties are given. The license may not give you all of the permissions necessary for your intended use. For example, other rights such as [publicity, privacy, or moral rights](#) may limit how you use the material.

The applicable mediation rules will be designated in the copyright notice published with the work, or if none then in the request for mediation. Unless otherwise designated in a copyright notice attached to the work, the UNCITRAL Arbitration Rules apply to any arbitration.

[More info](#).

You may also use a license listed as compatible at <https://creativecommons.org/compatiblelicenses>

[More info](#).

A commercial use is one primarily intended for commercial advantage or monetary compensation.

[More info](#).

Merely changing the format never creates a derivative.

[More info](#).



Latonya Scott <latonya.scott@gmail.com>

Permission to use image

4 messages

Latonya Scott <latonya.scott@gmail.com>

Sat, Sep 20, 2014 at 10:03 PM

To: contact-edps@edpsciences.org

Dear ,

I am in the process of finalizing and submitting my masters thesis. While in the process of doing research for my thesis I ran across you image(s) and would like to request permission to use it in my thesis.

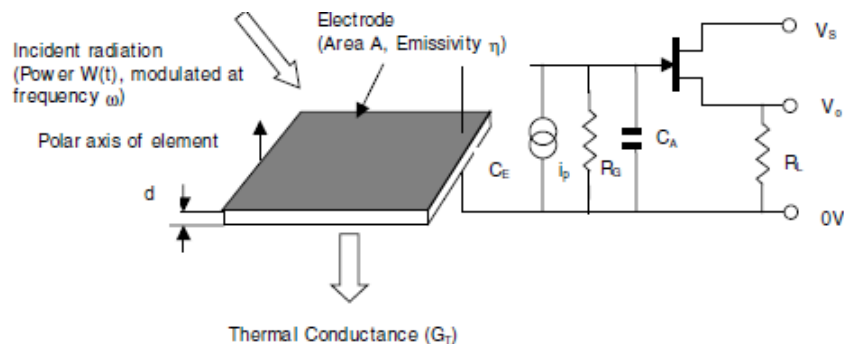

Thank You,
Latonya Scott

Mail_EDP <corinne@edpsciences.org>

Tue, Sep 23, 2014 at 10:42 AM

To: Latonya Scott <latonya.scott@gmail.com>

Dear Sir,

Please provide the following information with your request:

Title of the article

Full bibliographical reference

What material will be used

Where the material will be reused.

Yours sincerely,

Permissions Dept

EDP Sciences

De : Latonya Scott [mailto:latonya.scott@gmail.com]

Envoyé : dimanche 21 septembre 2014 04:04

À : contact-edps@edpsciences.org

Objet : Permission to use image

[Quoted text hidden]

Latonya Scott <latonya.scott@gmail.com>

Tue, Sep 23, 2014 at 11:07 AM

To: Mail_EDP <corinne@edpsciences.org>

Hey,

The title of my thesis is Wrist Worn Device to Aid the Elderly to Age in Place. The image I would like to use comes from A. Sixsmith, N. Johnson and R. and Whatmore, "Pyroelectric IR sensor arrays for fall detection in the older population," EDP Sciences, vol. 128, pp. 153-160, 2005. The intended use of the image is for the purpose of a Literature Review to show what others are working on. The image will be use in my thesis.

Thank You

Latonya Scott

[Quoted text hidden]

Mail_EDP <corinne@edpsciences.org>

Wed, Oct 1, 2014 at 4:40 AM

To: Latonya Scott <latonya.scott@gmail.com>

Dear Sir,

In answer to your request, we are pleased to inform you that you are authorized to reproduce in your thesis:

Figure published in Journal de Physique vol 128 , p 153-160 (2005)

We kindly ask you to provide the references of the source: title, year, issue and the URL address of the journal.

Yours sincerely,

Permissions Dept

EDP Sciences

De : Latonya Scott [mailto:latonya.scott@gmail.com]

Envoyé : mardi 23 septembre 2014 17:08

À : Mail_EDP

Objet : Re: Permission to use image

[Quoted text hidden]



RightsLink®

Home Account Info Help



Title: Towards automatic detection of falls using wireless sensors

Conference Proceedings: Engineering in Medicine and Biology Society, 2007. EMBS 2007. 29th Annual International Conference of the IEEE

Author: Srinivasan, S.; Jun Han; Lal, D.; Gacic, A.

Publisher: IEEE

Date: 22-26 Aug. 2007

Copyright © 2007, IEEE

Logged in as:
Latonya Scott

Account #:
3000835974

LOGOUT

Thesis / Dissertation Reuse

The IEEE does not require individuals working on a thesis to obtain a formal reuse license, however, you may print out this statement to be used as a permission grant:

Requirements to be followed when using any portion (e.g., figure, graph, table, or textual material) of an IEEE copyrighted paper in a thesis:

- 1) In the case of textual material (e.g., using short quotes or referring to the work within these papers) users must give full credit to the original source (author, paper, publication) followed by the IEEE copyright line © 2011 IEEE.
- 2) In the case of illustrations or tabular material, we require that the copyright line © [Year of original publication] IEEE appear prominently with each reprinted figure and/or table.
- 3) If a substantial portion of the original paper is to be used, and if you are not the senior author, also obtain the senior author's approval.

Requirements to be followed when using an entire IEEE copyrighted paper in a thesis:

- 1) The following IEEE copyright/ credit notice should be placed prominently in the references: © [year of original publication] IEEE. Reprinted, with permission, from [author names, paper title, IEEE publication title, and month/year of publication]
- 2) Only the accepted version of an IEEE copyrighted paper can be used when posting the paper or your thesis on-line.
- 3) In placing the thesis on the author's university website, please display the following message in a prominent place on the website: In reference to IEEE copyrighted material which is used with permission in this thesis, the IEEE does not endorse any of [university/educational entity's name goes

here]'s products or services. Internal or personal use of this material is permitted. If interested in reprinting/republishing IEEE copyrighted material for advertising or promotional purposes or for creating new collective works for resale or redistribution, please go to http://www.ieee.org/publications_standards/publications/rights/rights_link.html to learn how to obtain a License from RightsLink.

If applicable, University Microfilms and/or ProQuest Library, or the Archives of Canada may supply single copies of the dissertation.

[BACK](#)[CLOSE WINDOW](#)

Copyright © 2014 [Copyright Clearance Center, Inc.](#) All Rights Reserved. [Privacy statement.](#)
Comments? We would like to hear from you. E-mail us at customercare@copyright.com

Draft 09/01/2009

(Questions? Concerns? Contact Gail McMillan, Director of the Digital Library and Archives at Virginia Tech's University Libraries: gailmac@vt.edu)

(Please ensure that Javascript is enabled on your browser before using this tool.)

Virginia Tech ETD Fair Use Analysis Results

This is not a replacement for professional legal advice but an effort to assist you in making a sound decision.

Name: Latonya Scott

Description of item under review for fair use: M. Popescu, B. Hotrabhavananda, M. Moore and M. and Skubic, "AMPIR- An Automatic Fall Detection System Using a Vertical PIR Sensor Array," in International Conference on Pervasive Computing Technologies for Healthcare (PervasiveHealth) and Workshops pg163-166, San Diego, 2012.

Report generated on: 09-19-2014 at : 22:04:01

Based on the information you provided:

Factor 1

Your consideration of the purpose and character of your use of the copyright work weighs: *in favor of fair use*

Factor 2

Your consideration of the nature of the copyrighted work you used weighs: *in favor of fair use*

Factor 3

Your consideration of the amount and substantiality of your use of the copyrighted work weighs: *in favor of fair use*

Factor 4

Your consideration of the effect or potential effect on the market after your use of the copyrighted work weighs:
in favor of fair use

Based on the information you provided, your use of the copyrighted work weighs: *in favor of fair use*





Latonya Scott <latonya.scott@gmail.com>

Permission to use image

3 messages

Latonya Scott <latonya.scott@gmail.com>
To: pikov@hotmail.com

Sat, Sep 20, 2014 at 10:23 PM

Dear Dr. Victor Pikov,

I am in the process of finalizing and submitting my masters thesis. While in the process of doing research for my thesis I ran across you image(s) and would like to request permission to use it in my thesis.

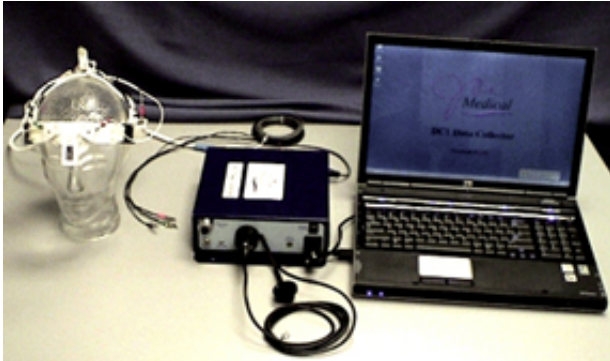

Thank You,
Latonya Scott

Victor Pikov <pikov@hotmail.com>
To: Latonya Scott <latonya.scott@gmail.com>

Sun, Sep 21, 2014 at 12:42 AM

Sure, no problem.
Good luck with the defense.

V Pikov

9/22/2014

Gmail - Permission to use image

Date: Sat, 20 Sep 2014 22:23:51 -0400

Subject: Permission to use image

From: latonya.scott@gmail.com

To: pikov@hotmail.com

[Quoted text hidden]

Latonya Scott <latonya.scott@gmail.com>

To: Victor Pikov <pikov@hotmail.com>

Mon, Sep 22, 2014 at 8:15 PM

Thank you. All credit will be properly given and noted accordingly.

[Quoted text hidden]

Draft 09/01/2009

(Questions? Concerns? Contact Gail McMillan, Director of the Digital Library and Archives at Virginia Tech's University Libraries: gailmac@vt.edu)

(Please ensure that Javascript is enabled on your browser before using this tool.)

Virginia Tech ETD Fair Use Analysis Results

This is not a replacement for professional legal advice but an effort to assist you in making a sound decision.

Name: Latonya Scott

Description of item under review for fair use: D. Ferguson, "Scientists: Portable device acts as early detector of strokes," 27 December 2012. [Online]. Available: <http://www.rawstory.com/rs/2012/12/27/scientists-portable-device-acts-as-early-detector-of-strokes/>. [Accessed 9 september 2013]

Report generated on: 09-19-2014 at : 22:07:55

Based on the information you provided:

Factor 1

Your consideration of the purpose and character of your use of the copyright work weighs: *in favor of fair use*

Factor 2

Your consideration of the nature of the copyrighted work you used weighs: *against fair use*

Factor 3

Your consideration of the amount and substantiality of your use of the copyrighted work weighs: *in favor of fair use*

Factor 4

Your consideration of the effect or potential effect on the market after your use of the copyrighted work weighs:

in favor of fair use

Based on the information you provided, your use of the copyrighted work weighs: *in favor of fair use*



Draft 09/01/2009

(Questions? Concerns? Contact Gail McMillan, Director of the Digital Library and Archives at Virginia Tech's University Libraries: gailmac@vt.edu)

(Please ensure that Javascript is enabled on your browser before using this tool.)

Virginia Tech ETD Fair Use Analysis Results

This is not a replacement for professional legal advice but an effort to assist you in making a sound decision.

Name: Latonya Scott

Description of item under review for fair use: C. Paddock, "Eye Movement Analyzer May Diagnose Stroke," MNT, 7 March 2013. [Online]. Available: <http://www.medicalnewstoday.com/articles/257312.php>. [Accessed 9 September 2013]

Report generated on: 09-19-2014 at : 22:09:32

Based on the information you provided:

Factor 1

Your consideration of the purpose and character of your use of the copyright work weighs: *in favor of fair use*

Factor 2

Your consideration of the nature of the copyrighted work you used weighs: *against fair use*

Factor 3

Your consideration of the amount and substantiality of your use of the copyrighted work weighs: *in favor of fair use*

Factor 4

Your consideration of the effect or potential effect on the market after your use of the copyrighted work weighs:

in favor of fair use

Based on the information you provided, your use of the copyrighted work weighs: *in favor of fair use*



Draft 09/01/2009

(Questions? Concerns? Contact Gail McMillan, Director of the Digital Library and Archives at Virginia Tech's University Libraries: gailmac@vt.edu)

(Please ensure that Javascript is enabled on your browser before using this tool.)

Virginia Tech ETD Fair Use Analysis Results

This is not a replacement for professional legal advice but an effort to assist you in making a sound decision.

Name: Latonya Scott

Description of item under review for fair use: ScienceDaily, "New device uses submarine technology to diagnose stroke quickly," Society of Interventional Radiology, 29 March 2011. [Online]. Available: <http://www.sciencedaily.com/releases/2011/03/110329095434.htm>. [Accessed 9 September 2013].

Report generated on: 09-19-2014 at : 22:10:59

Based on the information you provided:

Factor 1

Your consideration of the purpose and character of your use of the copyright work weighs: *in favor of fair use*

Factor 2

Your consideration of the nature of the copyrighted work you used weighs: *against fair use*

Factor 3

Your consideration of the amount and substantiality of your use of the copyrighted work weighs: *in favor of fair use*

Factor 4

Your consideration of the effect or potential effect on the market after your use of the copyrighted work weighs:

in favor of fair use

Based on the information you provided, your use of the copyrighted work weighs: *in favor of fair use*



[PubMed](#)[Entrez](#)[BLAST](#)[OMIM](#)[Taxonomy](#)[Structure](#)[NCBI](#)[SITE MAP](#)

Copyright and Disclaimers

Copyright Status

Information that is created by or for the US government on this site is within the public domain. Public domain information on the National Library of Medicine (NLM) Web pages may be freely distributed and copied. However, it is requested that in any subsequent use of this work, NLM be given appropriate acknowledgment.

NOTE: This site contains resources such as, but not limited to, PubMed Central (see [PMC Copyright Notice](#)), Bookshelf (see [Bookshelf Copyright Notice](#)), OMIM, and PubChem which incorporate material contributed or licensed by individuals, companies, or organizations that may be protected by U.S. and foreign copyright laws. All persons reproducing, redistributing, or making commercial use of this information are expected to adhere to the terms and conditions asserted by the copyright holder. Transmission or reproduction of protected items beyond that allowed by [fair use](#) (PDF) as defined in the copyright laws requires the written permission of the copyright owners.

Molecular Database Availability

Databases of molecular data on the NCBI Web site include such examples as nucleotide sequences (GenBank), protein sequences, macromolecular structures, molecular variation, gene expression, and mapping data. They are designed to provide and encourage access within the scientific community to sources of current and comprehensive information. Therefore, NCBI itself places no restrictions on the use or

distribution of the data contained therein. Nor do we accept data when the submitter has requested restrictions on reuse or redistribution. However, some submitters of the original data (or the country of origin of such data) may claim patent, copyright, or other intellectual property rights in all or a portion of the data (that has been submitted). NCBI is not in a position to assess the validity of such claims and since there is no transfer of rights from submitters to NCBI, NCBI has no rights to transfer to a third party. Therefore, NCBI cannot provide comment or unrestricted permission concerning the use, copying, or distribution of the information contained in the molecular databases.

Disclaimer

Liability: For documents and software available from this server, the U.S. Government does not warrant or assume any legal liability or responsibility for the accuracy, completeness, or usefulness of any information, apparatus, product, or process disclosed.

Endorsement: NCBI does not endorse or recommend any commercial products, processes, or services. The views and opinions of authors expressed on NCBI's Web sites do not necessarily state or reflect those of the U.S. Government, and they may not be used for advertising or product endorsement purposes.

External Links: Some NCBI Web pages may provide links to other Internet sites for the convenience of users. NCBI is not responsible for the availability or content of these external sites, nor does NCBI endorse, warrant, or guarantee the products, services, or information described or offered at these other Internet sites. Users cannot assume that the external sites will abide by the same [Privacy Policy](#) to which NCBI adheres. It is the responsibility of the user to examine the copyright and licensing restrictions of linked pages and to secure all necessary permissions.

Pop-Up Advertisements: When visiting our Web site, your Web browser may produce pop-up advertisements. These advertisements were most likely produced by other Web sites you visited or by third party software installed on your computer. The NLM does not endorse or recommend products or services for which you may view a pop-up advertisement on your computer screen while visiting our site.

Medical Information

It is not the intention of NLM to provide specific medical advice but rather to provide users with information to better understand their health and their diagnosed disorders. Specific medical advice will not be provided, and NLM urges you to consult with a qualified physician for diagnosis and for answers to your personal questions.

Conditions of Use

This site is maintained by the U.S. Government and is protected by various provisions of Title 18 of the U.S. Code. Violations of Title 18 are subject to criminal prosecution in a federal court. For site security purposes, as well as to ensure that this service remains available to all users, we use software programs to monitor traffic and to identify unauthorized attempts to upload or change information or otherwise cause damage. In the event of authorized law enforcement investigations and pursuant to any required legal process, information from these sources may be used to help identify an individual.

Revised: October 28, 2009.

Draft 09/01/2009

(Questions? Concerns? Contact Gail McMillan, Director of the Digital Library and Archives at Virginia Tech's University Libraries: gailmac@vt.edu)

(Please ensure that Javascript is enabled on your browser before using this tool.)

Virginia Tech ETD Fair Use Analysis Results

This is not a replacement for professional legal advice but an effort to assist you in making a sound decision.

Name: Latonya Scott

Description of item under review for fair use: W. Stomp, "Glucotrack DF-F Noninvasive Glucose Meter Receives CE Mark," medGadget, 4 June 2013. [Online]. Available: <http://www.medgadget.com/2013/06/glucotrack-df-f-noninvasive-earlobe-clip-glucose-meter-receives-ce-mark.html>. [Accessed 9 September 2013]

Report generated on: 09-19-2014 at : 22:14:55

Based on the information you provided:

Factor 1

Your consideration of the purpose and character of your use of the copyright work weighs: *in favor of fair use*

Factor 2

Your consideration of the nature of the copyrighted work you used weighs: *against fair use*

Factor 3

Your consideration of the amount and substantiality of your use of the copyrighted work weighs: *in favor of fair use*

Factor 4

Your consideration of the effect or potential effect on the market after your use of the copyrighted work weighs:
in favor of fair use

Based on the information you provided, your use of the copyrighted work weighs: *in favor of fair use*



Draft 09/01/2009

(Questions? Concerns? Contact Gail McMillan, Director of the Digital Library and Archives at Virginia Tech's University Libraries: gailmac@vt.edu)

(Please ensure that Javascript is enabled on your browser before using this tool.)

Virginia Tech ETD Fair Use Analysis Results

This is not a replacement for professional legal advice but an effort to assist you in making a sound decision.

Name: Latonya Scott

Description of item under review for fair use: New Non-Invasive Blood Glucose Measurement and Continuous Monitoring Device: the Glucoband(R)," MINT, 10 June 2005. [Online]. Available: <http://www.medicalnewstoday.com/releases/25926.php>. [Accessed 9 September 2013]

Report generated on: 09-19-2014 at : 22:17:54

Based on the information you provided:

Factor 1

Your consideration of the purpose and character of your use of the copyright work weighs: *in favor of fair use*

Factor 2

Your consideration of the nature of the copyrighted work you used weighs: *against fair use*

Factor 3

Your consideration of the amount and substantiality of your use of the copyrighted work weighs: *in favor of fair use*

Factor 4

Your consideration of the effect or potential effect on the market after your use of the copyrighted work weighs:

in favor of fair use

Based on the information you provided, your use of the copyrighted work weighs: *in favor of fair use*



Draft 09/01/2009

(Questions? Concerns? Contact Gail McMillan, Director of the Digital Library and Archives at Virginia Tech's University Libraries: gailmac@vt.edu)

(Please ensure that Javascript is enabled on your browser before using this tool.)

Virginia Tech ETD Fair Use Analysis Results

This is not a replacement for professional legal advice but an effort to assist you in making a sound decision.

Name: Latonya Scott

Description of item under review for fair use: A. N, "New Non-Invasive Continuous Glucose Monitor Will Talk to Your SmartPhone," 3 October 2011. [Online]. Available: <http://www.diabetesmine.com/2011/10/new-non-invasive-continuous-glucose-monitor-will-talk-to-your-smartphone.html>. [Accessed 9 September 2013]

Report generated on: 09-19-2014 at : 22:19:07

Based on the information you provided:

Factor 1

Your consideration of the purpose and character of your use of the copyright work weighs: *in favor of fair use*

Factor 2

Your consideration of the nature of the copyrighted work you used weighs: *against fair use*

Factor 3

Your consideration of the amount and substantiality of your use of the copyrighted work weighs: *in favor of fair use*

Factor 4

Your consideration of the effect or potential effect on the market after your use of the copyrighted work weighs:
in favor of fair use

Based on the information you provided, your use of the copyrighted work weighs: *in favor of fair use*





Latonya Scott <latonya.scott@gmail.com>

permission to use images

5 messages

Latonya Scott <latonya.scott@gmail.com>

Sat, Sep 20, 2014 at 11:58 PM

To: m.bdi@tmd.ac.jp

Dear M.K. Chu, K. Mitsubayashi K. Miyajima, T. Arakawa, H. Kudo, and K. Mitsubayashi,

I am in the process of finalizing and submitting my masters thesis. While in the process of doing research for my thesis I ran across you image(s) and would like to request permission to use it in my thesis. The images I am referring to are figures 1, 2, and 3.

Thank You,
Latonya Scott

Kohji Mitsubayashi <m-bdi@tmd.ac.jp>

Sun, Sep 21, 2014 at 12:11 AM

To: Latonya Scott <latonya.scott@gmail.com>, m.bdi@tmd.ac.jp

Hi Latonya,

Thank you for your mail.
Please inform me your detail, belongs,etc.(which graduate school, university, your thesis title).
And also, which our paper's images do you need? Because we have published many papers and articles.
(Of course, we can support more if necessary)
Thank you in advance.

Best regards,
Kohji

Prof. Kohji Mitsubayashi, Ph.D.
(Deputy Director of University Innovation and Globalization)
Department of Biomedical Devices and Instrumentation
Institute of Biomaterials and Bioengineering
Tokyo Medical and Dental University
2-3-10 Kanda-Surugadai, Chiyoda-ku,
Tokyo 101-0062, JAPAN
Phone [+81-3-5280-8091](tel:+81-3-5280-8091)
FAX [+81-3-5280-8094](tel:+81-3-5280-8094)

E-mail m.bdi@tmd.ac.jp
(Editorial member of "Biosensors and Bioelectronics" [Elsevier])

[Quoted text hidden]

Latonya Scott <latonya.scott@gmail.com>
To: Kohji Mitsubayashi <m-bdi@tmd.ac.jp>

Sun, Sep 21, 2014 at 8:59 AM

Hi,

I go to Virginia polytechnic institute and state university in Blacksburg, Va. The Title of my Thesis is Wrist Worn Device to Aid the Elderly to Age in Place. The images I am referring to are in Soft Contact-lens Sensor for Monitoring Tear Sugar as Novel Wearable Device of Body Sensor Network

Thank You,
Latonya Scott
[Quoted text hidden]

Mitsubayashi <m.bdi@tmd.ac.jp>
To: Latonya Scott <latonya.scott@gmail.com>, Kohji Mitsubayashi <m-bdi@tmd.ac.jp>

Sun, Sep 21, 2014 at 8:38 PM

Good morning Latonya,

Thank you for your reply.
OK. Please use the images.
And ask the publisher about the coyright.

Best regards,
Kohji

Prof. Kohji Mitsubayashi, Ph.D.
(Deputy Director of University Innovation and Globalization)
Department of Biomedical Devices and Instrumentation
Institute of Biomaterials and Bioengineering
Tokyo Medical and Dental University
2-3-10 Kanda-Surugadai, Chiyoda-ku,
Tokyo 101-0062, JAPAN
Phone [+81-3-5280-8091](tel:+81-3-5280-8091)
FAX [+81-3-5280-8094](tel:+81-3-5280-8094)

E-mail m.bdi@tmd.ac.jp

(Editorial member of "Biosensors and Bioelectronics" [Elsevier])

From: [Latonya Scott](#)

Sent: Sunday, September 21, 2014 9:59 PM

To: [Kohji Mitsubayashi](#)

Subject: Re: permission to use images

[Quoted text hidden]

Latonya Scott <latonya.scott@gmail.com>

To: Mitsubayashi <m.bdi@tmd.ac.jp>

Cc: Kohji Mitsubayashi <m-bdi@tmd.ac.jp>

Mon, Sep 22, 2014 at 8:14 PM

Thank you. I will also talk to the publisher as well.

[Quoted text hidden]

Draft 09/01/2009

(Questions? Concerns? Contact Gail McMillan, Director of the Digital Library and Archives at Virginia Tech's University Libraries: gailmac@vt.edu)

(Please ensure that Javascript is enabled on your browser before using this tool.)

Virginia Tech ETD Fair Use Analysis Results

This is not a replacement for professional legal advice but an effort to assist you in making a sound decision.

Name: Latonya Scott

Description of item under review for fair use: <http://directorsblog.nih.gov/2014/01/16/move-over-holter-heart-monitoring-in-the-mhealth-era/>

Report generated on: 10-13-2014 at : 23:35:55

Based on the information you provided:

Factor 1

Your consideration of the purpose and character of your use of the copyright work weighs: *in favor of fair use*

Factor 2

Your consideration of the nature of the copyrighted work you used weighs: *against fair use*

Factor 3

Your consideration of the amount and substantiality of your use of the copyrighted work weighs: *in favor of fair use*

Factor 4

Your consideration of the effect or potential effect on the market after your use of the copyrighted work weighs:

in favor of fair use

Based on the information you provided, your use of the copyrighted work weighs: *in favor of fair use*





Latonya Scott <latonya.scott@gmail.com>

Permission to use image

3 messages

Latonya Scott <latonya.scott@gmail.com>
To: merckmanualpermissions@merck.com

Mon, Sep 22, 2014 at 11:38 PM

Dear Merck Manuals,

I am in the process of finalizing and submitting my masters thesis. While in the process of doing research for my thesis I ran across you image(s) and would like to request permission to use it in my thesis. The image I am referring to is from

www.merckmanuals.com/home/heart_and_blood_vessel_disorders/diagnosis_of_heart_and_blood_vessel_disorders/other_tests_for_heart_and_blood_vessel_disorders.html

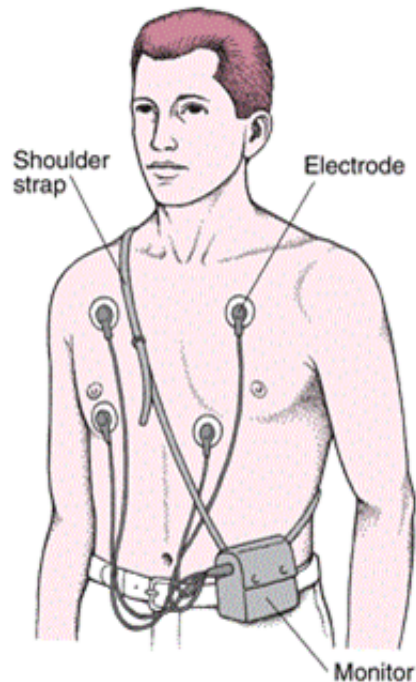

My contact information is
Latonya Scott
lscott9@vt.edu
latonya.scott@gmail.com
843-742-3373

Thank You,
Latonya Scott

Short, Susan C. (Merck Manuals) <susan_short@merck.com>
To: Latonya Scott <latonya.scott@gmail.com>

Thu, Sep 25, 2014 at 9:24 AM

Dear Ms Scott:

We are happy to grant permission for you to use our figure " **Holter Monitor: Continuous ECG Readings**" from The Merck Manual Home Health Handbook. We understand the figure is to be used in your master's thesis. Please note that no changes are permitted. Should the thesis be re-published (eg, in a book or journal article), you would need to seek permission from us for the additional publication. Should the thesis be made available in digital form, we ask that you include a link to our website.

Please include the following information in the credit line:

From the Merck Manual Home Health Handbook, edited by Robert Porter. Copyright (year at bottom of web page; eg, 2013) by Merck Sharp & Dohme Corp., a subsidiary of Merck & Co, Inc, Whitehouse Station, NJ. Available at <http://www.merckmanuals.com/home/>. Accessed (date).

Thank you for your interest in The Merck Manual.

Susan

Susan C. Short, ELS
Senior Editor

The Merck Manuals
351 N. Sumneytown Pike

PO Box 1000, UG-2D62

North Wales, PA 19454

(267) 305-6941

susan_short@merck.com

From: Latonya Scott [mailto:latonya.scott@gmail.com]

Sent: Monday, September 22, 2014 11:39 PM

To: MerckManualsPermissions

Subject: Permission to use image

[Quoted text hidden]

Notice: This e-mail message, together with any attachments, contains information of Merck & Co., Inc. (One Merck Drive, Whitehouse Station, New Jersey, USA 08889), and/or its affiliates Direct contact information for affiliates is available at

<http://www.merck.com/contact/contacts.html>) that may be confidential, proprietary copyrighted and/or legally privileged. It is intended solely for the use of the individual or entity named on this message. If you are not the intended recipient, and have received this message in error, please notify us immediately by reply e-mail and then delete it from your system.

Latonya Scott <latonya.scott@gmail.com>

To: "Short, Susan C. (Merck Manuals)" <susan_short@merck.com>

Sat, Sep 27, 2014 at 10:30 PM

Thank you. All credit will be properly given and noted accordingly.

[Quoted text hidden]

Draft 09/01/2009

(Questions? Concerns? Contact Gail McMillan, Director of the Digital Library and Archives at Virginia Tech's University Libraries: gailmac@vt.edu)

(Please ensure that Javascript is enabled on your browser before using this tool.)

Virginia Tech ETD Fair Use Analysis Results

This is not a replacement for professional legal advice but an effort to assist you in making a sound decision.

Name: Latonya Scott

Description of item under review for fair use: [Online]. Available: <http://www.endothelix.com/>. [Accessed 9 September 2013].

Report generated on: 09-19-2014 at : 22:27:49

Based on the information you provided:

Factor 1

Your consideration of the purpose and character of your use of the copyright work weighs: *in favor of fair use*

Factor 2

Your consideration of the nature of the copyrighted work you used weighs: *against fair use*

Factor 3

Your consideration of the amount and substantiality of your use of the copyrighted work weighs: *in favor of fair use*

Factor 4

Your consideration of the effect or potential effect on the market after your use of the copyrighted work weighs:

in favor of fair use

Based on the information you provided, your use of the copyrighted work weighs: *in favor of fair use*



Draft 09/01/2009

(Questions? Concerns? Contact Gail McMillan, Director of the Digital Library and Archives at Virginia Tech's University Libraries: gailmac@vt.edu)

(Please ensure that Javascript is enabled on your browser before using this tool.)

Virginia Tech ETD Fair Use Analysis Results

This is not a replacement for professional legal advice but an effort to assist you in making a sound decision.

Name: Latonya Scott

Description of item under review for fair use: [Online]. Available:

http://www.lasplash.com/publish/LifesJourney/cat_index_golden_years/myHalo_Monitoring_Device_Review_Automatic_Fall_Detection.php. [Accessed 9 September 2013].

Report generated on: 09-19-2014 at : 22:32:55

Based on the information you provided:

Factor 1

Your consideration of the purpose and character of your use of the copyright work weighs: *in favor of fair use*

Factor 2

Your consideration of the nature of the copyrighted work you used weighs: *against fair use*

Factor 3

Your consideration of the amount and substantiality of your use of the copyrighted work weighs: *in favor of fair use*

Factor 4

Your consideration of the effect or potential effect on the market after your use of the copyrighted work weighs:
in favor of fair use

Based on the information you provided, your use of the copyrighted work weighs: *in favor of fair use*





Latonya Scott <latonya.scott@gmail.com>

FW: Request to use fall detector image.

1 message

Shirley Wilson <Shirley.Wilson@protectron.com>

Mon, Oct 6, 2014 at 3:04 PM

To: "lscott9@vt.edu" <lscott9@vt.edu>

Our LifeCall Manager, Richard Heyd has approved your using the fall detector image as you requested.

Take care.

Shirley Wilson
Payment Specialist | Operations
LifeCall Canada

Reliance Protectron Inc.
Phone : [1.800.266.4166](tel:1.800.266.4166), #51239 | [1.800.661.5433](tel:1.800.661.5433)
Fax : [1.800.661.7051](tel:1.800.661.7051)
shirley.wilson@protectron.com
4209 - 99 Street, Unit 102, Edmonton (Alberta) T6E 5V7
www.lifecall.ca

-----Original Message-----

From: Richard Heyd
Sent: Monday, October 06, 2014 12:57 PM
To: Shirley Wilson
Subject: FW: Request to use fall detector image.

WE have a green light on using the image for the fall pendant ,.

-----Original Message-----

From: Shirley Wilson
Sent: September-29-14 11:52 AM
To: Richard Heyd
Subject: Request to use fall detector image.

Shirley Wilson

Payment Specialist | Operations
LifeCall Canada

Reliance Protectron Inc.
Phone : [1.800.266.4166](tel:1.800.266.4166), [#51239 | 1.800.661.5433](tel:1.800.661.5433) Fax : [1.800.661.7051](tel:1.800.661.7051) shirley.wilson@protectron.com
4209 - 99 Street, Unit 102, Edmonton (Alberta) T6E 5V7 www.lifecall.ca

-----Original Message-----

From: WorkCentre 5335 [mailto:no-reply@protectron.com]
Sent: Monday, September 29, 2014 11:53 AM
To: Shirley Wilson
Subject: Scan from a Xerox WorkCentre

Please open the attached document. It was scanned and sent to you using a Xerox WorkCentre.

Number of Images: 1
Attachment File Type: PDF

Device Name: WorkCentre 5335
Device Location:

For more information on Xerox products and solutions, please visit <http://www.xerox.com/>

 **img-929115253-0001.pdf**
18K

Draft 09/01/2009

(Questions? Concerns? Contact Gail McMillan, Director of the Digital Library and Archives at Virginia Tech's University Libraries: gailmac@vt.edu)

(Please ensure that Javascript is enabled on your browser before using this tool.)

Virginia Tech ETD Fair Use Analysis Results

This is not a replacement for professional legal advice but an effort to assist you in making a sound decision.

Name: Latonya Scott

Description of item under review for fair use: [Online]. Available: <http://www.healthstats.com/index3.php?page=homepage>. [Accessed 9 September 2013]

Report generated on: 09-19-2014 at : 22:35:23

Based on the information you provided:

Factor 1

Your consideration of the purpose and character of your use of the copyright work weighs: *in favor of fair use*

Factor 2

Your consideration of the nature of the copyrighted work you used weighs: *against fair use*

Factor 3

Your consideration of the amount and substantiality of your use of the copyrighted work weighs: *in favor of fair use*

Factor 4

Your consideration of the effect or potential effect on the market after your use of the copyrighted work weighs:

in favor of fair use

Based on the information you provided, your use of the copyrighted work weighs: *in favor of fair use*



Draft 09/01/2009

(Questions? Concerns? Contact Gail McMillan, Director of the Digital Library and Archives at Virginia Tech's University Libraries: gailmac@vt.edu)

(Please ensure that Javascript is enabled on your browser before using this tool.)

Virginia Tech ETD Fair Use Analysis Results

This is not a replacement for professional legal advice but an effort to assist you in making a sound decision.

Name: Latonya Scott

Description of item under review for fair use: D. Pogrelc, "Bloodless glucometer uses light to check blood sugar in 20 seconds or less," MEDCITY, 28 June 2012. [Online]. Available: <http://medcitynews.com/2012/06/bloodless-glucometer-uses-light-to-check-blood-sugar-in-20-seconds-or-less/>. [Accessed 9 September 2013].

Report generated on: 09-19-2014 at : 22:36:37

Based on the information you provided:

Factor 1

Your consideration of the purpose and character of your use of the copyright work weighs: *in favor of fair use*

Factor 2

Your consideration of the nature of the copyrighted work you used weighs: *against fair use*

Factor 3

Your consideration of the amount and substantiality of your use of the copyrighted work weighs: *in favor of fair use*

Factor 4

Your consideration of the effect or potential effect on the market after your use of the copyrighted work weighs:
in favor of fair use

Based on the information you provided, your use of the copyrighted work weighs: *in favor of fair use*



Draft 09/01/2009

(Questions? Concerns? Contact Gail McMillan, Director of the Digital Library and Archives at Virginia Tech's University Libraries: gailmac@vt.edu)

(Please ensure that Javascript is enabled on your browser before using this tool.)

Virginia Tech ETD Fair Use Analysis Results

This is not a replacement for professional legal advice but an effort to assist you in making a sound decision.

Name: Latonya Scott

Description of item under review for fair use: [Online]. Available: <http://www.diabetesmine.com/2011/04/sleep-well-a-diabetes-design-concept-gone-viral.html>. [Accessed 9 September 2013].

Report generated on: 09-19-2014 at : 22:37:38

Based on the information you provided:

Factor 1

Your consideration of the purpose and character of your use of the copyright work weighs: *in favor of fair use*

Factor 2

Your consideration of the nature of the copyrighted work you used weighs: *against fair use*

Factor 3

Your consideration of the amount and substantiality of your use of the copyrighted work weighs: *in favor of fair use*

Factor 4

Your consideration of the effect or potential effect on the market after your use of the copyrighted work weighs:

in favor of fair use

Based on the information you provided, your use of the copyrighted work weighs: *in favor of fair use*





Latonya Scott <latonya.scott@gmail.com>

Permission to use image

3 messages

Latonya Scott <latonya.scott@gmail.com>
To: gdepaula@pancreum.com

Sun, Sep 21, 2014 at 9:24 PM

Dear Gil DePaula,

I am in the process of finalizing and submitting my masters thesis. While in the process of doing research for my thesis I ran across you image(s) and would like to request permission to use it in my thesis.



Thank You,
Latonya Scott

Guilherme de Paula <gdepaula@pancreum.com>
To: Latonya Scott <latonya.scott@gmail.com>

Tue, Sep 23, 2014 at 12:15 AM

Hi Latonya,

Yes, you have the permission to use that image or any other that we have on our site, our Facebook page or Twitter account.

9/27/2014

Gmail - Permission to use image

Best regards,
Gil

Guilherme 'Gil' de Paula
CEO/CTO & Founder
Pancreum, LLC.
Tel: +1-978-500-3991
gdepaula@pancreum.com
<http://www.pancreum.com/>

[Quoted text hidden]

Latonya Scott <latonya.scott@gmail.com>
To: Guilherme de Paula <gdepaula@pancreum.com>

Sat, Sep 27, 2014 at 10:28 PM

Thank you. All credit will be properly given and noted accordingly.

[Quoted text hidden]



Latonya Scott <latonya.scott@gmail.com>

Permission to use images

4 messages

Latonya Scott <latonya.scott@gmail.com>

Sun, Sep 21, 2014 at 9:30 PM

To: sales.us@invensense.com

Cc: pr@invensense.com

Dear InvenSense,

I am in the process of finalizing and submitting my masters thesis. While in the process of doing research for my thesis I ran across you image(s) and would like to request permission to use it in my thesis.

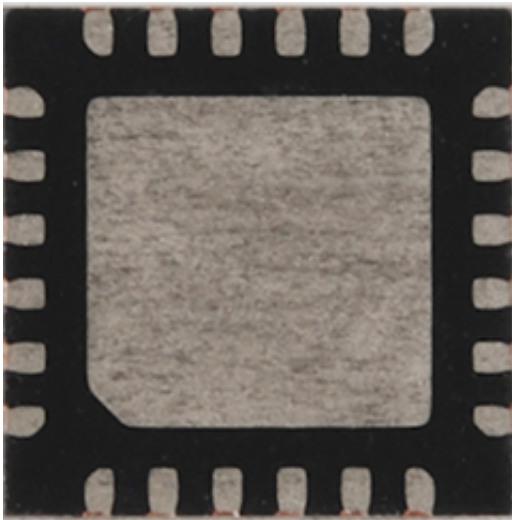

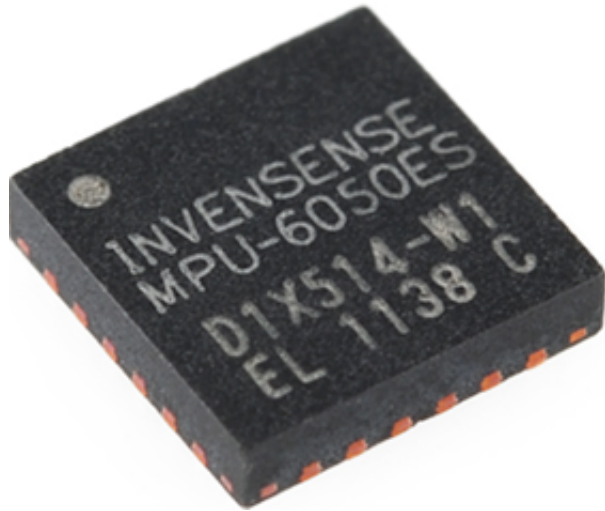

Thank You,
Latonya Scott

postmaster@invcorp.invensense.com <postmaster@invcorp.invensense.com>
To: latonya.scott@gmail.com

Sun, Sep 21, 2014 at 9:30 PM

Delivery has failed to these recipients or groups:

sales.us@invensense.com

Your message can't be delivered because delivery to this address is restricted.

Diagnostic information for administrators:

Generating server: invcorp.invensense.com

sales.us@invensense.com

#550 5.7.1 RESOLVER.RST.AuthRequired; authentication required ##

Original message headers:

Received: from IUSASPAM1.invensense.com (10.26.112.117) by IUSEXCH01.invcorp.invensense.com (10.26.112.161) with Microsoft SMTP Server id 14.3.169.1; Sun, 21 Sep 2014 18:30:39 -0700
X-ASG-Debug-ID: 1411349419-079da71029e5610001-pjKfCh
Received: from mail-ob0-f179.google.com (mail-ob0-f179.google.com [209.85.214.179]) by IUSASPAM1.invensense.com with ESMTP id h0x6IWVXsHwzOkqJ; Sun, 21 Sep 2014 18:30:19 -0700 (PDT)
X-Barracuda-Envelope-From: latonya.scott@gmail.com
X-Barracuda-Apparent-Source-IP: 209.85.214.179
Received: by mail-ob0-f179.google.com with SMTP id wm4so349662obc.10 for <multiple recipients>; Sun, 21 Sep 2014 18:30:18 -0700 (PDT)
DKIM-Signature: v=1; a=rsa-sha256; c=relaxed/relaxed; d=gmail.com; s=20120113; h=mime-version:date:message-id:subject:from:to:cc:content-type; bh=d0ebUk7ewLTjFH37VmkrbG/WUDRWCRwHp9y9sqzJXfY=; b=IoPOxi+Uub5jorvZxM+n7Q+d6ib13uu1PMJSRoxEGX15/zow5iwzatgn4rg9lkije5TYNuUE5T/GNYV3h39jd0QeIFKaimwuwoYEH5npkxHPUnCLvACacpJ+iwf+nJc7fQXa31WHa6ZLdix8UVKIoIPv/Oa5j8x3xTkzGqGaV/cK2JkzZFbY4XY28QrDc/JbAGzE3bP4q35J/UQNhs6hht7I1kEdbB69B83ux2IwngvWgtQ5XQOnGeKD1L8rvsc6nACGos3lNKRLDg2Y+NYItYn0MA1QkxpMIS9klsVpIU13/uCmr+yxVdShFC8iypLozyJsRj7rSqPwh5nIIH4L1A==
MIME-Version: 1.0
X-Received: by 10.182.126.162 with SMTP id mz2mr24141998obb.19.1411349418775; Sun, 21 Sep 2014 18:30:18 -0700 (PDT)
Received: by 10.202.3.66 with HTTP; Sun, 21 Sep 2014 18:30:18 -0700 (PDT)
Date: Sun, 21 Sep 2014 21:30:18 -0400
Message-ID: <CAHP=9-exn3vv4bJi_ANjnv=2i+=E=PXNP7-fvHM_zzHocuKSLw@mail.gmail.com>
Subject: Permission to use images
From: Latonya Scott <latonya.scott@gmail.com>
X-ASG-Orig-Subj: Permission to use images
To: <sales.us@invensense.com>
CC: <pr@invensense.com>
Content-Type: multipart/related; boundary="089e01634bf8c3198805039d64b9"
X-Barracuda-Connect: mail-ob0-f179.google.com[209.85.214.179]
X-Barracuda-Start-Time: 1411349419
X-Barracuda-URL: <http://10.26.112.117:8000/cgi-mod/mark.cgi>
Received-SPF: pass (invensense.com: domain of latonya.scott@gmail.com designates 209.85.214.179 as permitted sender)
X-Virus-Scanned: by bsmtpd at invensense.com
X-Barracuda-BRTS-Status: 1
X-Barracuda-Spam-Score: -1001.00
X-Barracuda-Spam-Status: No, SCORE=-1001.00 using global scores of TAG_LEVEL=3.5 QUARANTINE_LEVEL=1000.0 KILL_LEVEL=6.0
Return-Path: latonya.scott@gmail.com

Final-Recipient: rfc822:sales.us@invensense.com

Action: failed

Status: 5.7.1

Diagnostic-Code: smtp;550 5.7.1 RESOLVER.RST.AuthRequired; authentication required

----- Forwarded message -----

From: Latonya Scott <latonya.scott@gmail.com>

To: <sales.us@invensense.com>

Cc: <pr@invensense.com>

Date: Sun, 21 Sep 2014 21:30:18 -0400

Subject: Permission to use images

Dear InvenSense,

I am in the process of finalizing and submitting my masters thesis. While in the process of doing research for my thesis I ran across you image(s) and would like to request permission to use it in my thesis.

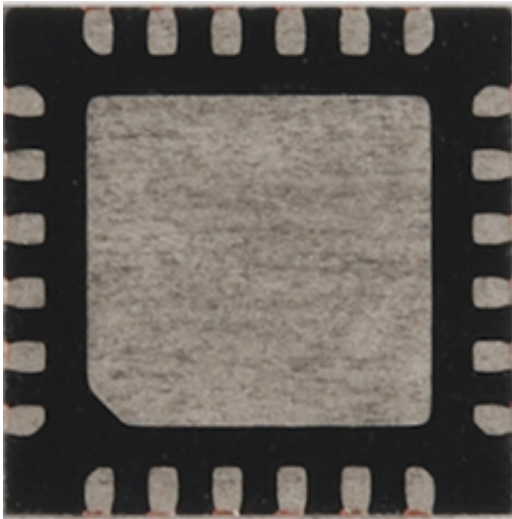

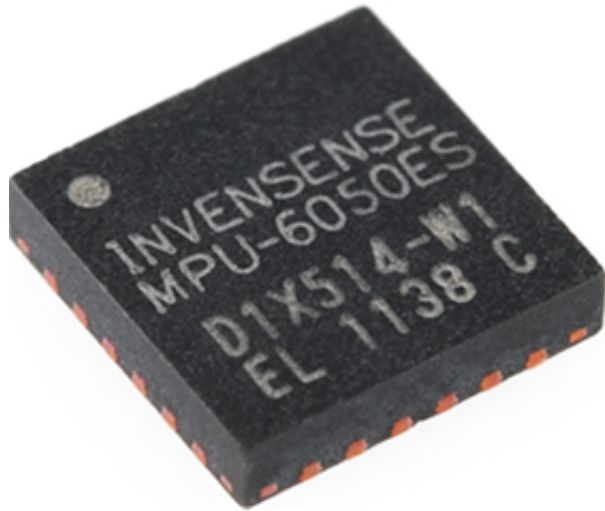

Thank You,
Latonya Scott

David Almoslino <DAlmoslino@invensense.com>
To: Latonya Scott <latonya.scott@gmail.com>, "sales.us" <sales.us@invensense.com>

Mon, Sep 22, 2014 at 12:45 PM

Latonya,

Yes, with this email I grant you permission as long as you adequately mark the source (which I'm sure you would have).

Best,

Dave

David A. Almoslino | Sr. Director of Marketing and Communications | InvenSense, Inc. | M +1 408.478.5799 | T +1 408.501.2278 | E dalmoslino@invensense.com Our Vision: To Become the Leader in Sensor System on Chip <http://www.invensense.com>

This email may contain confidential information that is intended only for the listed recipient(s) of this email. Any unauthorized review, use, disclosure or distribution is prohibited. If you believe you have received this email in error, please immediately delete this email and any attachments, and inform me via reply e-mail.

From: Latonya Scott [mailto:latonya.scott@gmail.com]
Sent: Sunday, September 21, 2014 6:30 PM
To: sales.us
Cc: Public Relations
Subject: Permission to use images

Dear InvenSense,

[Quoted text hidden]

Latonya Scott <latonya.scott@gmail.com>
To: David Almoslino <DAmoslino@invensense.com>

Mon, Sep 22, 2014 at 8:00 PM

Thank you. All credit will be properly given and noted accordingly.
[Quoted text hidden]



Latonya Scott <latonya.scott@gmail.com>

Permission to use images

2 messages

Sheets, Cindy <c-sheets@ti.com>

Mon, Sep 22, 2014 at 4:55 PM

To: "latonya.scott@gmail.com" <latonya.scott@gmail.com>

Cc: "Kelly, Nancy" <nkelly@ti.com>, "Sherrell, Rhonda" <r-sherrell@ti.com>

Hi Latonya,

Your request to use photos/graphics from Texas Instruments has been forwarded to me and the request has been granted – however, we ask that you please include “Photo courtesy of Texas Instruments” near the photo usage.

Regards,



Cindy Sheets

Texas Instruments
Corporate Brand Communications

c-sheets@ti.com

ph: 214/567-5089

cell: 817/247-1990

Latonya Scott <latonya.scott@gmail.com>

Mon, Sep 22, 2014 at 7:58 PM

To: "Sheets, Cindy" <c-sheets@ti.com>

9/22/2014

Gmail - Permission to use images

Cc: "Kelly, Nancy" <nkelly@ti.com>, "Sherrell, Rhonda" <r-sherrell@ti.com>

Thank you. All credit will be properly given and noted accordingly.

[Quoted text hidden]

Draft 09/01/2009

(Questions? Concerns? Contact Gail McMillan, Director of the Digital Library and Archives at Virginia Tech's University Libraries: gailmac@vt.edu)

(Please ensure that Javascript is enabled on your browser before using this tool.)

Virginia Tech ETD Fair Use Analysis Results

This is not a replacement for professional legal advice but an effort to assist you in making a sound decision.

Name: Latonya Scott

Description of item under review for fair use: [Online]. Available: [http://www.ovt.com/uploads/parts/OV3640_PB\(1.02\)_web.pdf](http://www.ovt.com/uploads/parts/OV3640_PB(1.02)_web.pdf). [Accessed 9 September 2013]

Report generated on: 09-19-2014 at : 22:46:04

Based on the information you provided:

Factor 1

Your consideration of the purpose and character of your use of the copyright work weighs: *in favor of fair use*

Factor 2

Your consideration of the nature of the copyrighted work you used weighs: *against fair use*

Factor 3

Your consideration of the amount and substantiality of your use of the copyrighted work weighs: *in favor of fair use*

Factor 4

Your consideration of the effect or potential effect on the market after your use of the copyrighted work weighs:

in favor of fair use

Based on the information you provided, your use of the copyrighted work weighs: *in favor of fair use*



Draft 09/01/2009

(Questions? Concerns? Contact Gail McMillan, Director of the Digital Library and Archives at Virginia Tech's University Libraries: gailmac@vt.edu)

(Please ensure that Javascript is enabled on your browser before using this tool.)

Virginia Tech ETD Fair Use Analysis Results

This is not a replacement for professional legal advice but an effort to assist you in making a sound decision.

Name: Latonya Scott

Description of item under review for fair use: [Online]. Available: <http://www.jai.com/en/products/nearinfrared>. [Accessed 9 September 2013]

Report generated on: 09-19-2014 at : 22:47:10

Based on the information you provided:

Factor 1

Your consideration of the purpose and character of your use of the copyright work weighs: *in favor of fair use*

Factor 2

Your consideration of the nature of the copyrighted work you used weighs: *against fair use*

Factor 3

Your consideration of the amount and substantiality of your use of the copyrighted work weighs: *in favor of fair use*

Factor 4

Your consideration of the effect or potential effect on the market after your use of the copyrighted work weighs:

in favor of fair use

Based on the information you provided, your use of the copyrighted work weighs: *in favor of fair use*





Latonya Scott <latonya.scott@gmail.com>

Permission to use images

3 messages

Latonya Scott <latonya.scott@gmail.com>

Sun, Sep 21, 2014 at 9:51 PM

To: inbox@pololu.com

Dear Pololu,

I am in the process of finalizing and submitting my masters thesis. While in the process of doing research for my thesis I ran across you image(s) and would like to request permission to use it in my thesis.

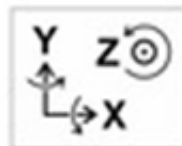
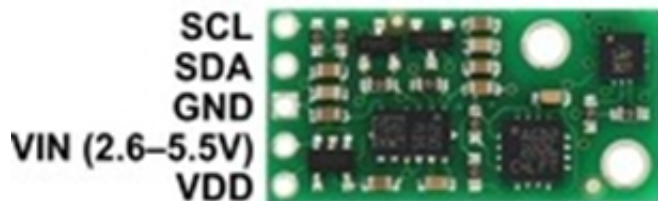

Thank You

Latonya Scott

Derrill Hartley <derrill@pololu.com>
To: Latonya Scott <latonya.scott@gmail.com>

Mon, Sep 22, 2014 at 4:56 PM

Hello, Latonya.

Thank you for your inquiry. You are welcome to use those pictures for your thesis as long as proper attribution is given.

Please let me know if you have any additional questions.

Sincerely,
Derrill Hartley
(702) 262-6648
www.pololu.com

.....
Pololu Corporation
920 Pilot Rd.
Las Vegas, NV 89119
USA

[Quoted text hidden]

Latonya Scott <latonya.scott@gmail.com>
To: Derrill Hartley <derrill@pololu.com>

Mon, Sep 22, 2014 at 7:57 PM

Thank you. All credit will be properly given.

[Quoted text hidden]



Latonya Scott <latonya.scott@gmail.com>

Permission to use images

3 messages

Latonya Scott <latonya.scott@gmail.com>

Sun, Sep 21, 2014 at 9:56 PM

To: Yury@pulsesensor.com

Cc: Joel@pulsesensor.com

Dear ,

I am in the process of finalizing and submitting my masters thesis. While in the process of doing research for my thesis I ran across you image(s) and would like to request permission to use it in my thesis.

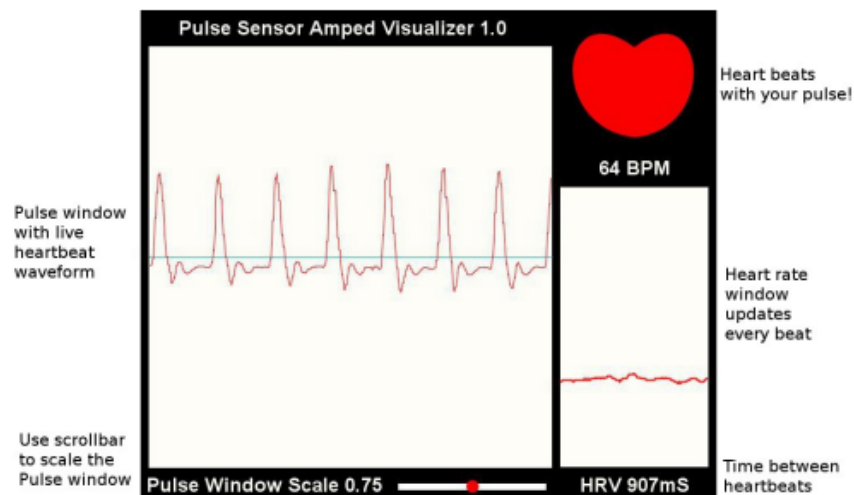



Thank You
Latonya Scott

Yury Gitman <yury@pulsesensor.com>
To: Latonya Scott <latonya.scott@gmail.com>
Cc: "Joel@pulsesensor.com" <Joel@pulsesensor.com>

Mon, Sep 22, 2014 at 7:20 AM

No problem use the images, just give attributions to where they came from.

[Quoted text hidden]

--

Yury Gitman
www.PulseSensor.com

=====
Brooklyn, NY. USA Direct: (646) 263-5554
=====

Latonya Scott <latonya.scott@gmail.com>
To: Yury Gitman <yury@pulsesensor.com>
Cc: "Joel@pulsesensor.com" <Joel@pulsesensor.com>

Mon, Sep 22, 2014 at 8:01 PM

Thank you. All credit will be properly given and noted accordingly.

9/22/2014

Gmail - Permission to use images

[Quoted text hidden]



Latonya Scott <latonya.scott@gmail.com>

Permission to use images

3 messages

Latonya Scott <latonya.scott@gmail.com>

Sun, Sep 21, 2014 at 9:59 PM

To: support@adafruit.com

Dear ,

I am in the process of finalizing and submitting my masters thesis. While in the process of doing research for my thesis I ran across you image(s) and would like to request permission to use it in my thesis.

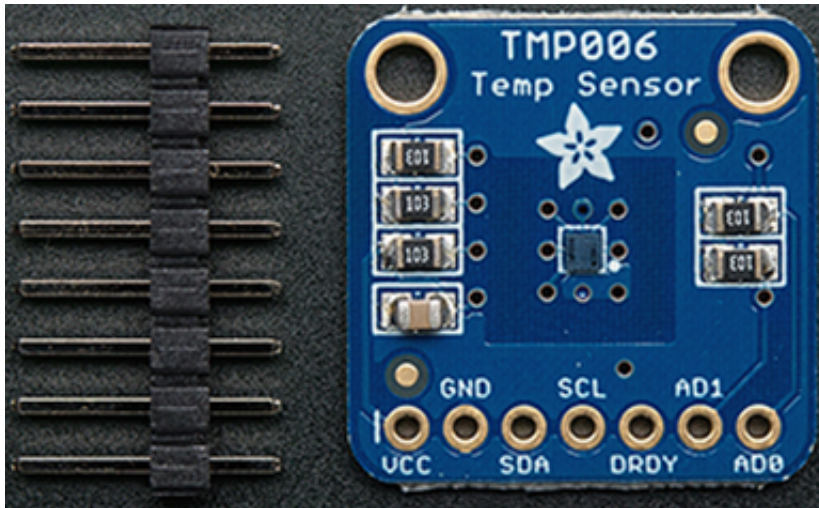

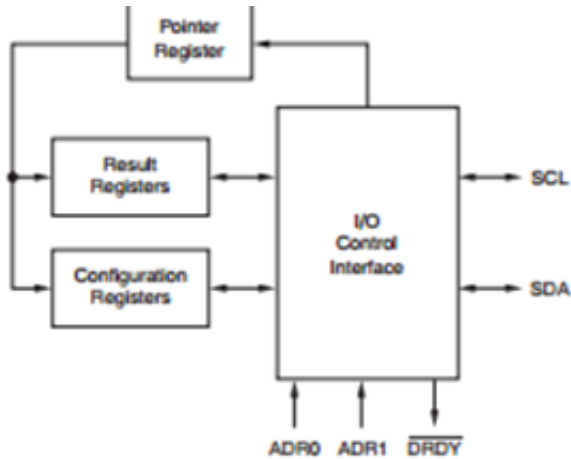
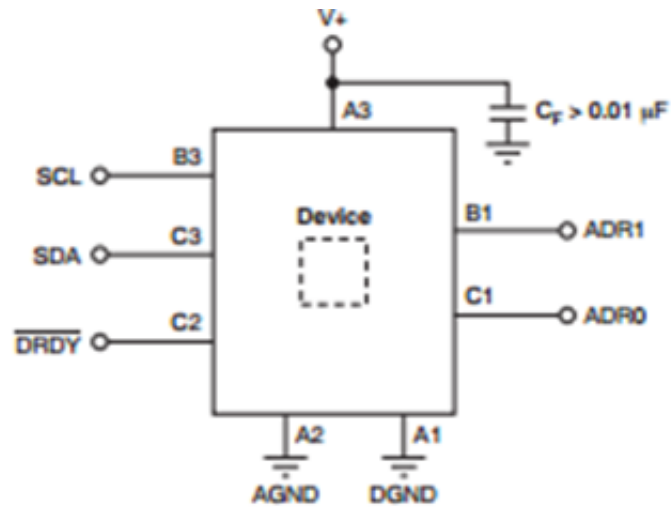

Thank You
Latonya Scott

Adafruit Industries <support@adafruit.com>
To: Latonya Scott <latonya.scott@gmail.com>

Mon, Sep 22, 2014 at 7:44 AM

thanks for the note, permission granted!

thank you,
adafruit support

[Quoted text hidden]

--

Adafruit - Unique and fun DIY electronics & kits

=Get technical support, help and more=

<http://www.adafruit.com/support/>

=Visit the Adafruit blog for how-tos, electronic projects & more=

<http://www.adafruit.com/blog/>

=Follow Adafruit on Twitter!=

<http://www.twitter.com/adafruit/>

=See us each week on our LIVE video show "Ask an Engineer" - 8pm ET every Wednesday night=

<http://www.adafruit.com/ask/>

*** Adafruit Industries is always striving to improve our products and services. If there is anything more we can do, or if we could improve your experience, please let us know! ***

Latonya Scott <latonya.scott@gmail.com>
To: Adafruit Industries <support@adafruit.com>

Mon, Sep 22, 2014 at 8:00 PM

Thank you. All credit will be properly given and noted accordingly.

[Quoted text hidden]



Latonya Scott <latonya.scott@gmail.com>

[#ADA-799-92562]: Permission to use images

2 messages

(EN) RobotShop inc. <supportcenter@robotshop.com>

Mon, Sep 22, 2014 at 12:04 PM

Reply-To: supportcenter@robotshop.com

To: latonya.scott@gmail.com

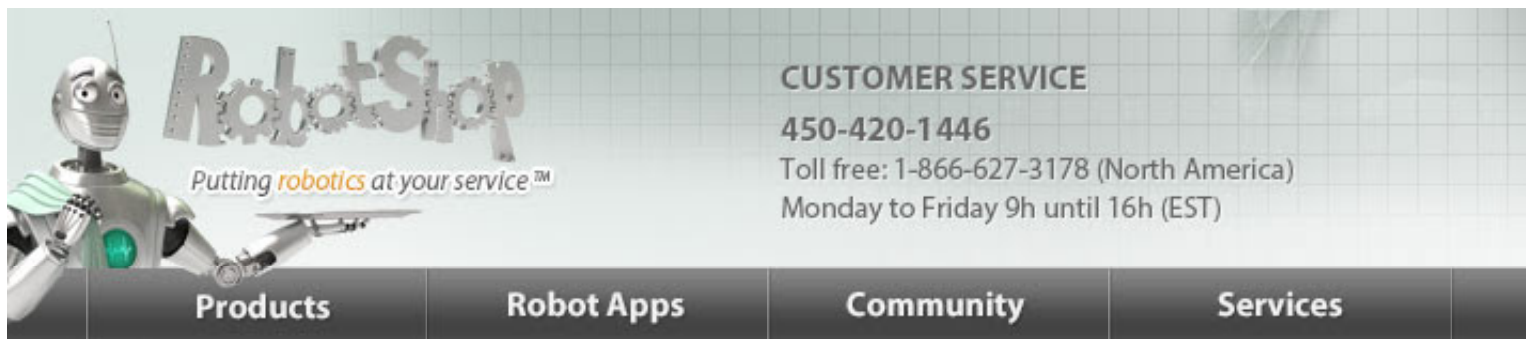

Hi Scott,

Thanks for contacting the RobotShop support center.

Congratulation about your Master Thesis, and there is no problem about using those pictures in your work.

All the best,

Eric Nantel - DiaLFonZo
Technical Team - Équipe Technique
RobotShop inc.
Putting Robotics at Your Service!®
La Robotique à votre Service!®
Web: www.robotshop.com

[Ticket Details](#)

Ticket ID: ADA-799-92562
Department: Technical Support
Status: Answered

Sign in at the [RobotShop Support Center](#) to see your full support history.

Visitez le [centre de support RobotShop](#) pour voir votre historique de support complet.

Thanks for your trust in RobotShop!
Further your experience



Connect Your Robots
Reap the benefits



©2014 RobotShop Distribution Inc. [RobotShop.com](#)

Latonya Scott <latonya.scott@gmail.com>
To: supportcenter@robotshop.com

Mon, Sep 22, 2014 at 8:16 PM

Thank you. All credit will be properly given and noted accordingly.

[Quoted text hidden]