

A PERFORMING ARTS CENTER
ON THE POTOMAC

by

Robert E. Pribish, Jr.

Thesis submitted to the Faculty of the
Virginia Polytechnic Institute and State University
in partial fulfillment of the requirements for the degree of

MASTER OF ARCHITECTURE

Approved:

Jaan Holt, Committee Chairman
Director of the Washington - Alexandria Center
for Architecture and Urban Studies

Gregory Hunt, Associate Professor

James W. Ritter, AIA

January, 1990
Blacksburg, Virginia

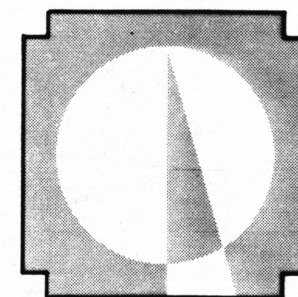

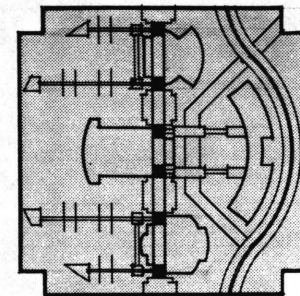

Abstract

The nature of Architecture, as it could exist at the edge of a river, was investigated through the design of a Center for Performing Arts located on the Potomac River. Site analysis, functional requirements and structural feasibility were among the considerations utilized in arriving at the proposed design.

The Center is comprised of three theatres, restaurants, a marina, administration offices, guest suites, and their ancillary spaces. Six stair towers support a thick wall which is situated at the river's edge. Stage areas for the theatres are located within the wall between pairs of towers, with seating on one side of the wall and backstage areas on the other. A serpentine "riverwalk" connects the towers and four plazas, encouraging public use of the river's edge. Parking is provided by a crescent-shaped garage which also serves as a buffer to the adjacent expressway traffic.

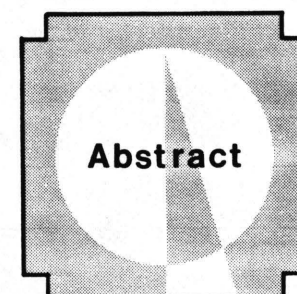
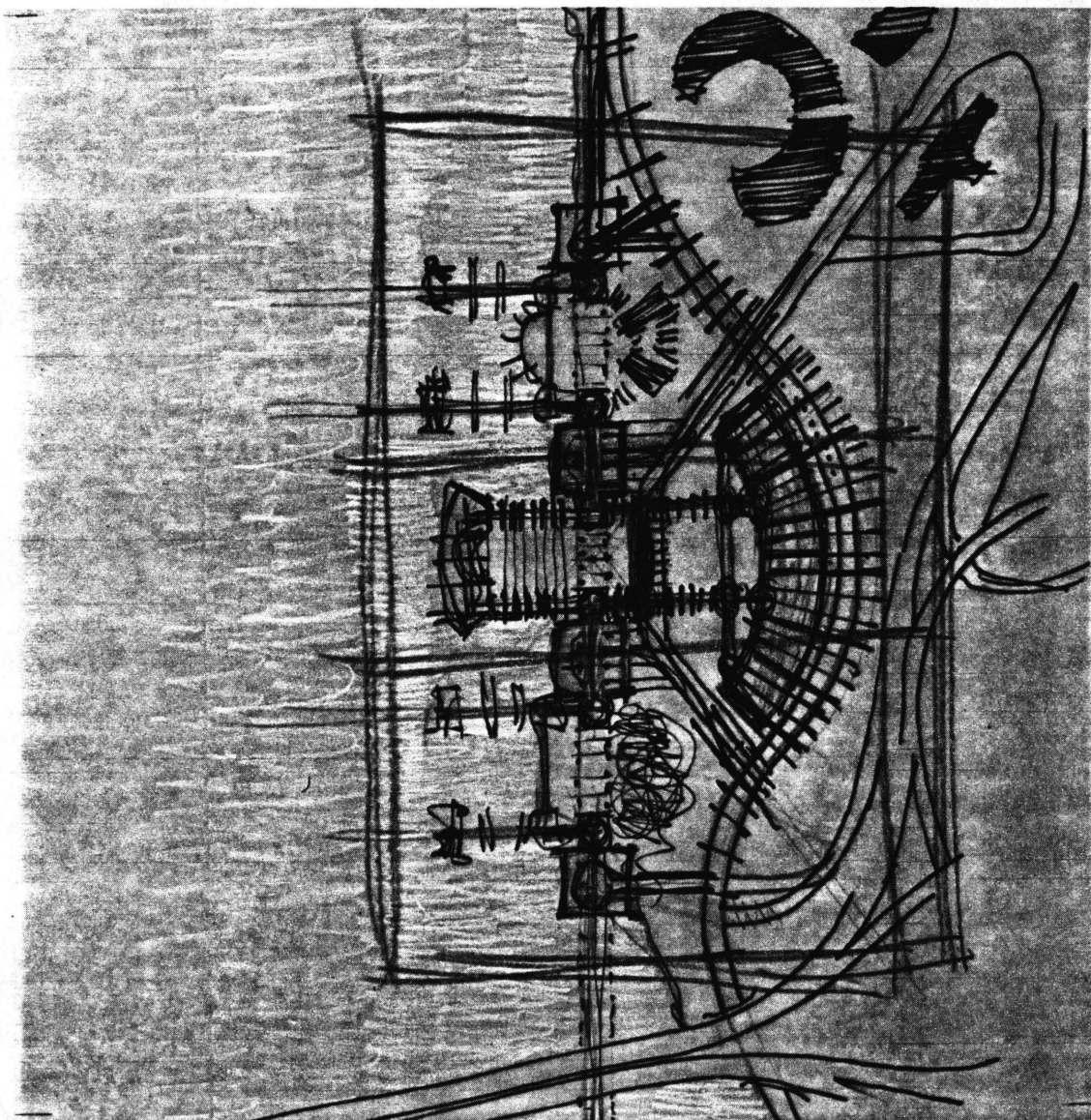

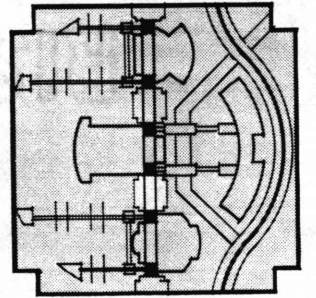

Acknowledgements

To those of the past who established the College of Architecture and Urban Studies at Virginia Tech and those of the present who continue to sustain the original spirit of this institution, I am grateful.

To my committee members, Jaan Holt, Greg Hunt, and Jim Ritter, for their assistance in distilling the mash, I am truly grateful.

To Patti, my best friend, for her omnipresent support, encouragement and patience, I am sincerely grateful.

For Patti, Samantha, and Robbie

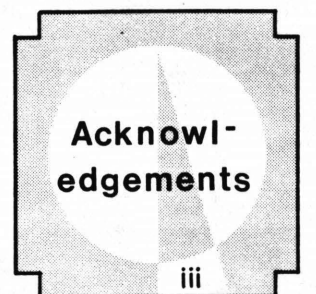

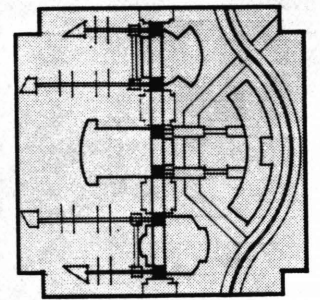
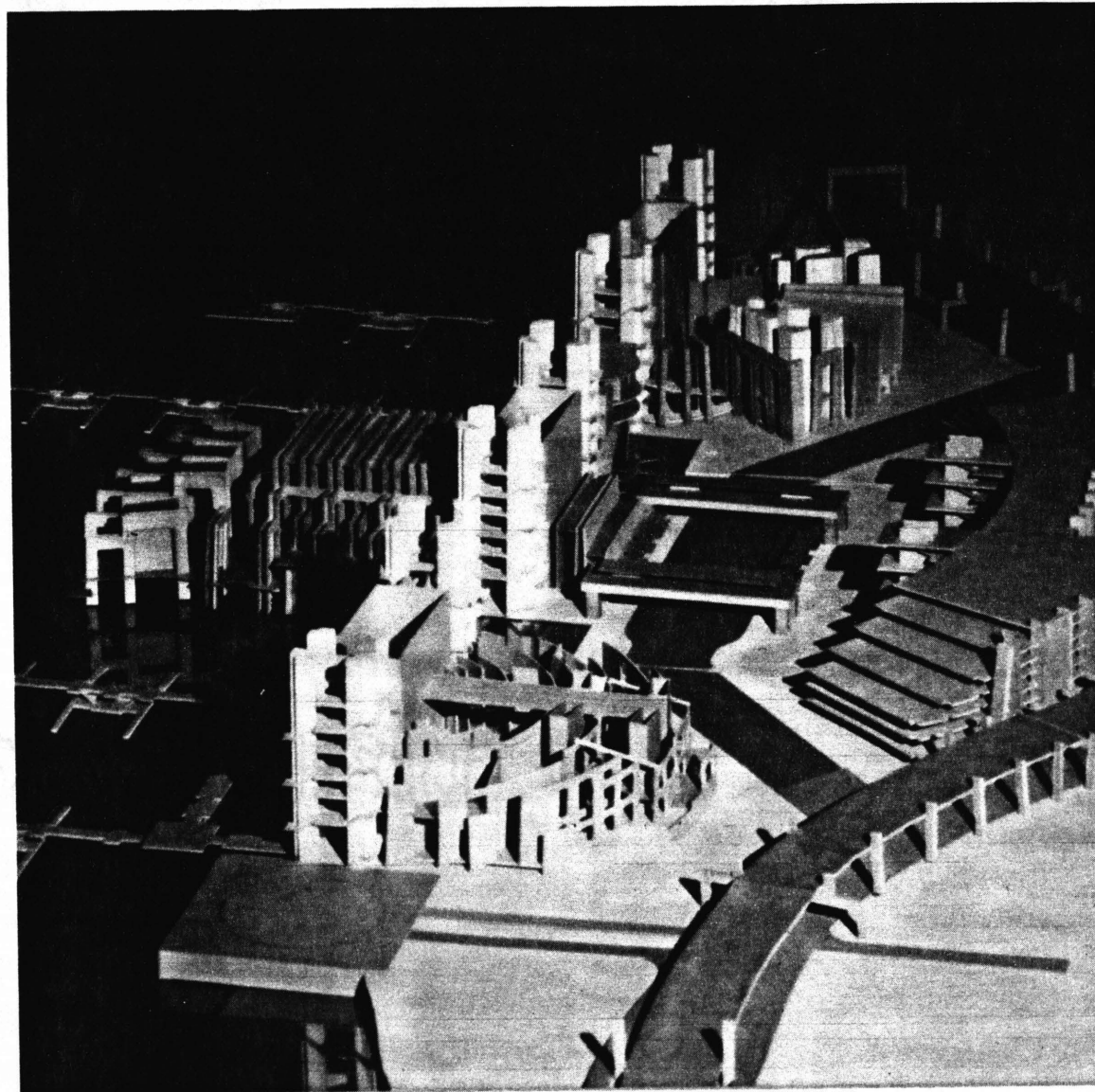
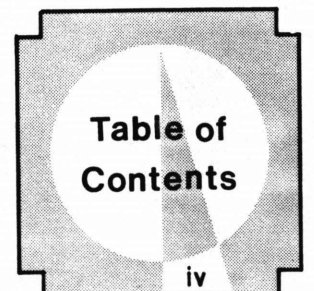
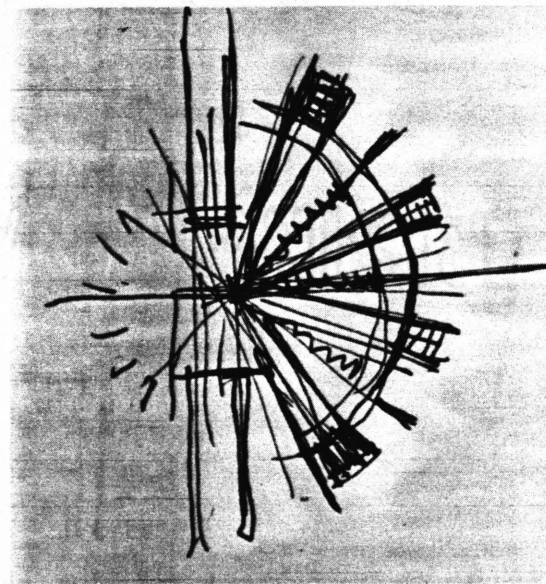
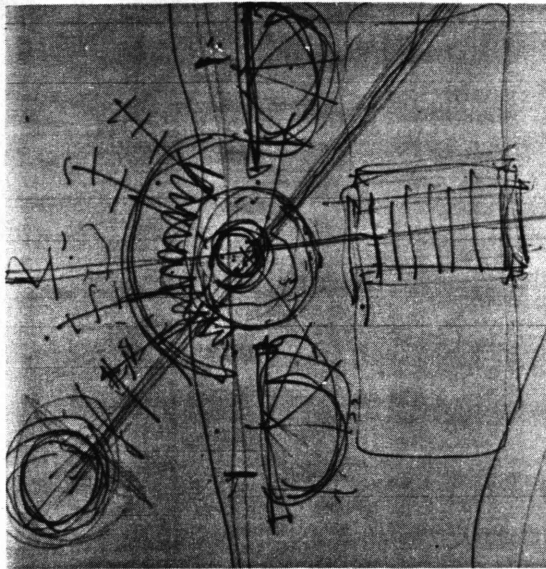

Table of Contents

Acknowledgements	iii
Introduction	1
Design Comments	2
Site Considerations	3
Site Plan	4
Parking & Plazas	5
Master Plan	6
Playhouse	7
Main Level	8
Level 2	9
Level 3	10
Upper Levels	11
Sections	12
North Plaza	
Upper Levels	13
Symphony Hall	14
Main Level	15
Levels 2 & 3	16
Upper Levels	17
Section & Elevation	18
South Plaza	
Upper Levels	19
Opera House	20
Main Level	21
Level 2	22
Level 3	23
Upper Levels	24
Sections	25
Longitudinal & Traverse Sections	26
Elevations	27
Bibliography	28
Vita	29





Introduction

The Potomac River, flowing south towards the Chesapeake Bay, passes the District of Columbia on its left and the State of Virginia on its right. The River gives way to an outcrop of land, and divides itself briefly while passing Roosevelt island.

On the eastern bank, across the river from the island stands a row of six towers, their uppermost portions visible above the glass and metal skin which links them together to form a wall. Below, concrete and glass structures project out from pairs of towers over the water, one dominating the other two. Openings in the wall allow a view of additional structures on the other side of the wall, similarly jutting from the row of towers over the land. Inside, between pairs of towers and directly above the bank of the river, lie the three stages. It is here, at the point where water meets land, that the artist meets the audience.

The selection of this riverside location for the proposed 'National Cultural Center' by the District of Columbia Auditorium Commission in the late 1950's, seemed to be a superb decision, allowing the beauty of man-made art to mix with the natural beauty of a river and its associated vistas. The idea of performances occurring on the bank of the Potomac River was not new. In the early 1900's, bands and orchestras had performed concerts from moored barges to audiences on shore. In 1971, the idea became a reality in the form of the present-

day John F. Kennedy Center for the Performing Arts.

This water front site, along with a program which approximates that of the existing center were the springboard for this investigation into how Architecture could exist at the river's edge.

The proposed complex comprises three theatres. Patrons may choose among performances at the Playhouse, Symphony Hall, and the Opera House. Three restaurants and a cafeteria provide a variety of dining options for patrons, performers and support staff while having a panoramic view of the river. Banquet facilities and reception areas are included to accommodate art events and exhibitions. Additionally, plazas and a riverwalk encourage day use of the river's edge by those who may not necessarily attend a performance. Performers have the option of lodging within the complex in one of the penthouse guest suites overlooking the Potomac. The complex has been designed to be easily accessible by pedestrians, vehicles, and watercraft.

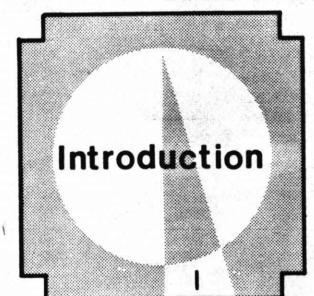
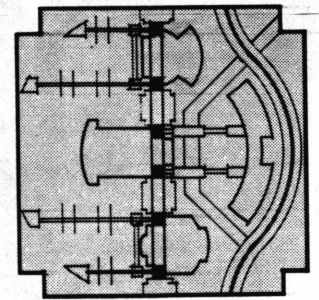

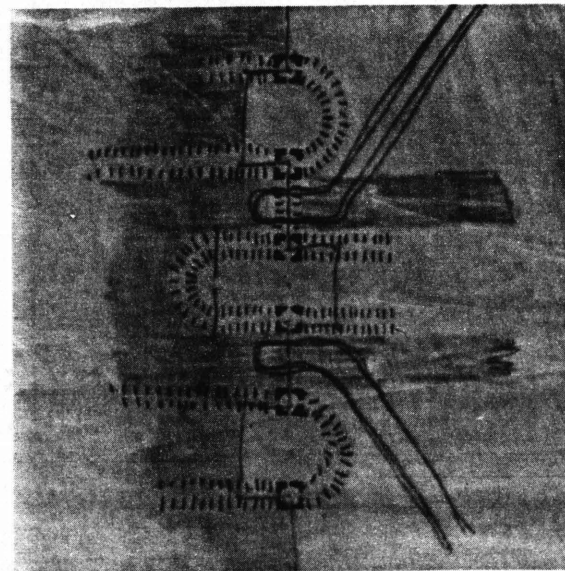
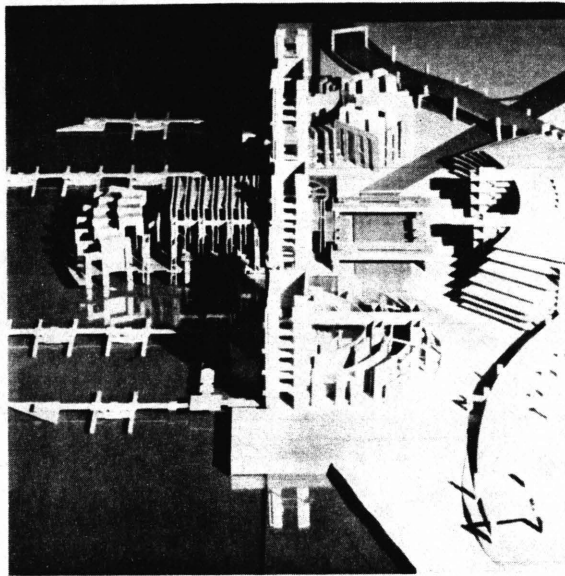

Design Comments

The artist and the audience intersect on the stage. Until a performance begins, the events on either side of the stage are separate and distinct. Patrons gather in the lobby or in the seating area - conversing, looking and waiting. Performers backstage rehearse, practice, study, and wait. The importance of this separation has been symbolized by the thick wall situated between the two. They come together within the wall, on the stage.

Points of intersection have an intrinsic importance attached to them. Cities are built around them, atoms are split at them. The river's edge is the intersection of two materials: one, liquid, the other solid. How life progresses in or on each is quite different. When they meet, the event can be as calming as a bubbling brook or as turbulent as a tidal wave. The importance of this line of intersection dictated the symbolic placement of the stages within the wall directly on the shore line.

Towers on each side of a stage contain elevators, stairways and mechanical shafts, and provide structural support for the wall. During the design process, they evolved into three dimensional circulation nodes, becoming intersections between horizontal and vertical circulation. For example, the upper floors, the docks, a plaza, and the lobby of a theatre are all accessible from one of these nodes. The Performing Arts Center is clearly organized

along the wall, which contains the three stages, each situated between a pair of towers/nodes.

One of the design objectives is to encourage public use of the water front. A pedestrian path which originally existed along the river evolved into a serpentine riverwalk which weaves its way between the buildings. Portions of the thick wall were cut away between the theatres to allow access to and views of the river. Located at these two points and at both ends of the wall, are plazas through which the riverwalk passes. Outdoor cafes located at the plazas would encourage public involvement and use.

The columns and stairways of the towers are concrete. The upper portion of the thick wall utilizes a relatively lightweight skin of metal panel and glass set in aluminum framing attached to the towers. Much of the structure of the theatres is cast in place concrete with glass or metal panel infill.

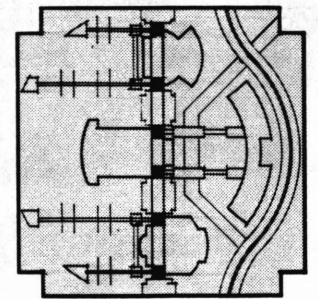

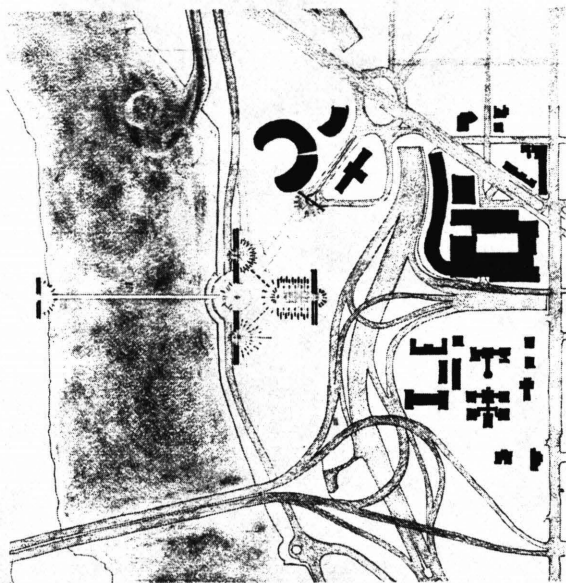
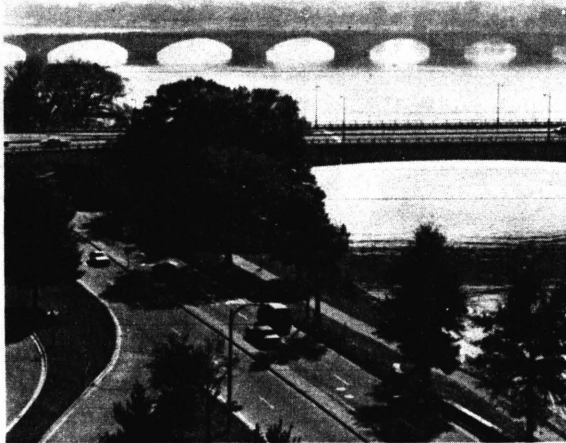

Site Considerations

The view of the river from the site is quite picturesque. Roosevelt Island, a wooded bird sanctuary, is located directly across from the site. The shallow depth of the water prohibits any kind of commercial river traffic. The nearby universities have rowing teams and are frequently seen practicing or racing along the river. The weekends bring out fishermen and boaters.

The construction of an extensive expressway interchange in the 1950's virtually cut this parcel of land off from the rest of the city. Before this spaghetti of highways was constructed, a node had existed at the point where the now severed 'E' Street and New Hampshire Avenue intersected Rock Creek Parkway. Like many of this city's intersections through which more than two streets pass, the importance of this node was recognized by the placement of a monument, in this case, the Titanic Memorial.

This project attempts to revive the significance of this node as a gathering place and as a termination of New Hampshire Avenue by placing the physical center of the complex at this historical node. In order to allow this to happen, the parkway was relocated away from the river adjacent to the expressway. This additionally returned the site to the river, which greatly increased its ability to accommodate water front activities.

Each theatre has its own separate, identifiable structure and is situated apart from the others. They are interconnected by the wall which is situated on the shore

line. The centrally located Symphony Hall has an audience area which is designed as a pier and juts out into the river. The other two theaters have their audience areas situated on land and backstage support areas over the water. This allows for the performers' rehearsal and dressing rooms to have a view of the river.

A high water table dictated the choice of an above-ground parking structure. This additionally allowed for the structure to become an acoustical and visual buffer to the expressway and the parkway. A garden located between the parking garage and the theaters would provide a landscaped transition area.

Pedestrian access to the Center is via New Hampshire avenue, which would be improved to become a tree-shaded boulevard. This road and its sidewalks lead directly to the drop-off area. Automobiles would have access to the parking garage or the drop-off area from an access road located directly below the relocated and elevated parkway. Docking facilities for boats are available at the proposed marina facility.

The floor of the first level of the Center would be placed at approximately fifteen feet above the mean river level to reduce the possibility of interior damage due to river flooding.

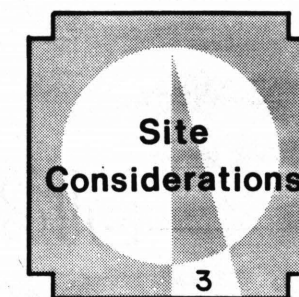
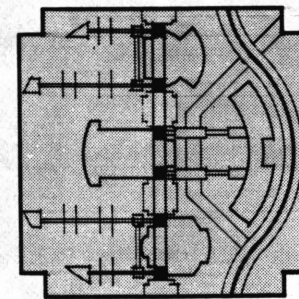

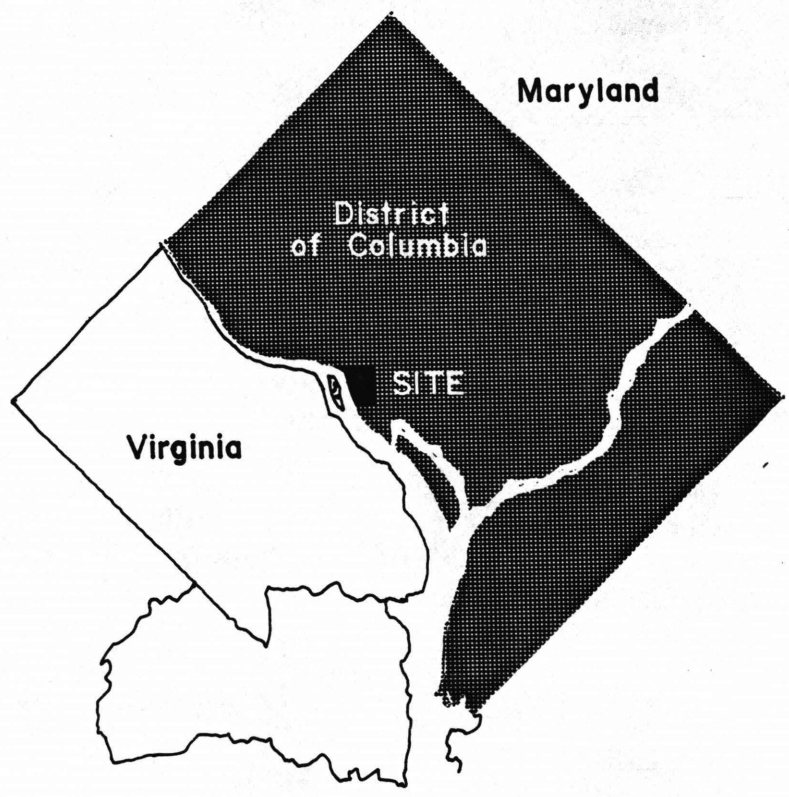
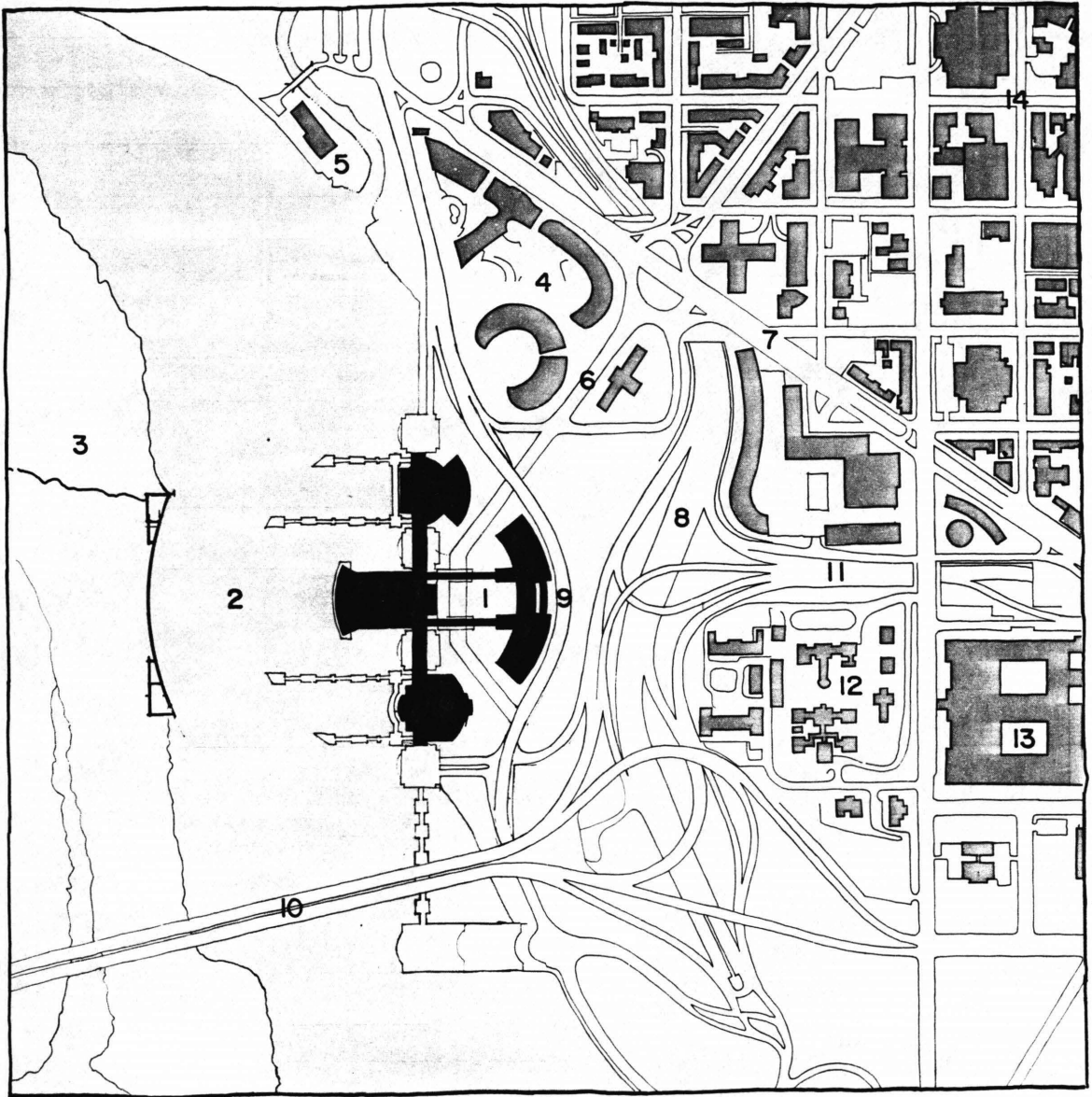
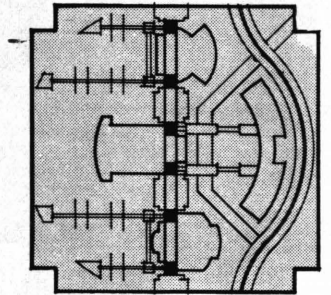

- 1 Performing Arts Center
- 2 Potomac River
- 3 Roosevelt Island
- 4 Watergate Complex
- 5 Thompson Boat Center
- 6 New Hampshire Avenue
- 7 Virginia Avenue
- 8 I-66 Expressway
- 9 Rockcreek Parkway
- 10 Roosevelt Bridge
- 11 'E' Street
- 12 U.S. Navy Complex
- 13 State Department
- 14 George Washington University

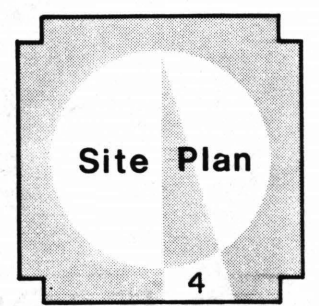

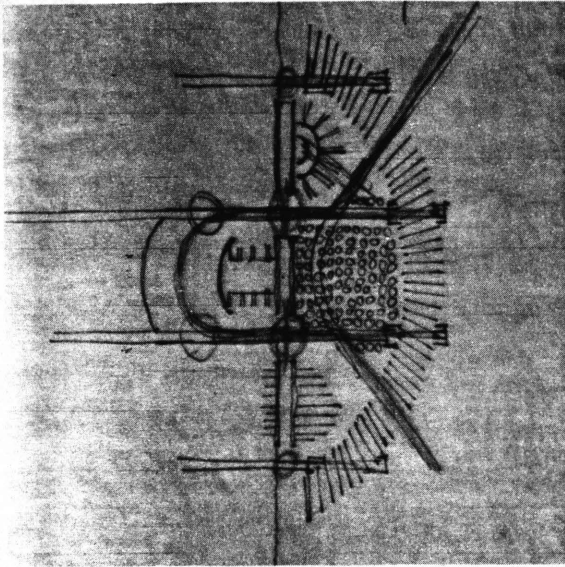

Parking Structure

The crescent shape of the parking garage comes from the desire to have its structural scheme focus on the center of the complex, thereby reinforcing the center's importance. Its structure is a combination of a wall in the shape of an arc in plan and radiating planes of beams and columns. The wall helps contain the garden and separates the pedestrian walkways from the vehicular traffic.

The parkway has been relocated to the outside of the parking garage, elevated twenty five feet above an access road. After parking the car, one walks directly across the garage and through an opening in the curved wall to a walkway. One of two banks of escalators can be reached via the walkway. Upon descending to the garden level, one can proceed directly to the theatres or stroll in the garden. Two walkways lead directly to the towers, from which the theatres, restaurants or the water front may be accessed.

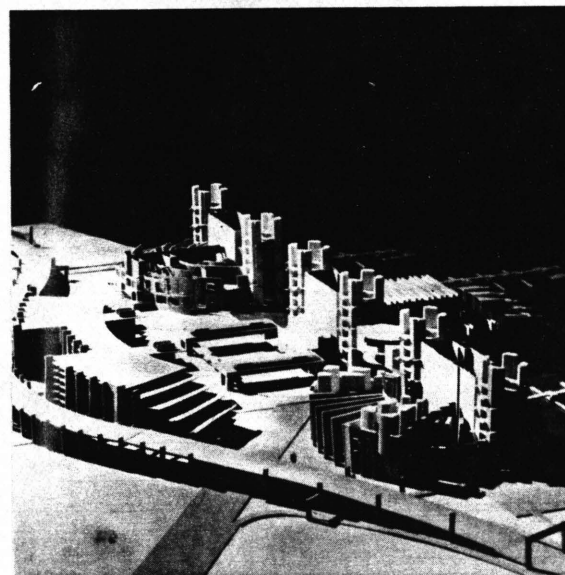

Plazas

The wall of the complex containing the stages has large three-story openings which frame the North and South Plazas. Included in the plan of the plazas are still-water pools laced with strolling paths which lead to the waters edge.

Three restaurants, two night clubs and a cafeteria are located above the North and South Plazas on Levels Four, Five, and Six. Their placement on upper levels adds to their panoramic view of the river and the garden.

Additional plazas, one at each end of the wall will accommodate moving vans for traveling sets.

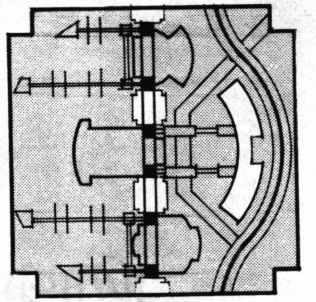

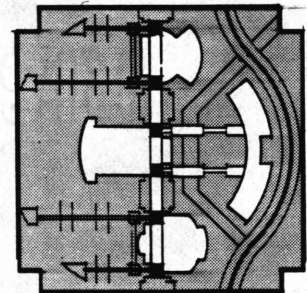
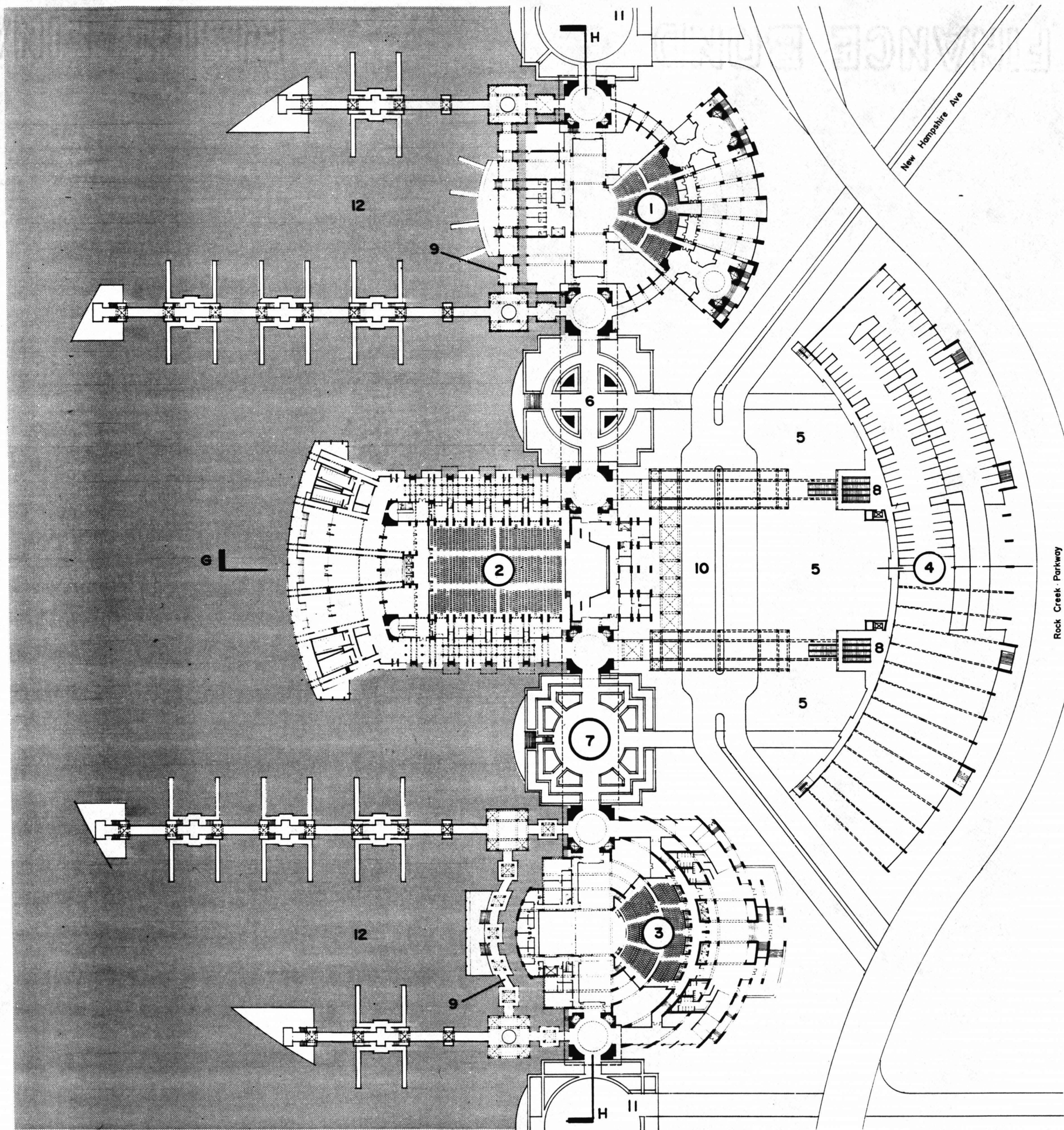

- 1 Playhouse
- 2 Symphony Hall
- 3 Opera House
- 4 Parking Structure
- 5 Garden
- 6 North Plaza
- 7 South Plaza
- 8 Escalators/Elevators
- 9 Riverwalk
- 10 Drop-off
- 11 Delivery Plaza
- 12 Marina

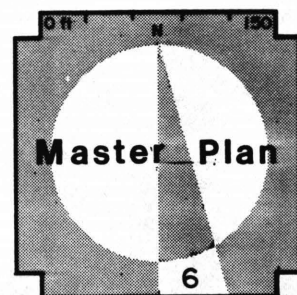
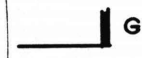

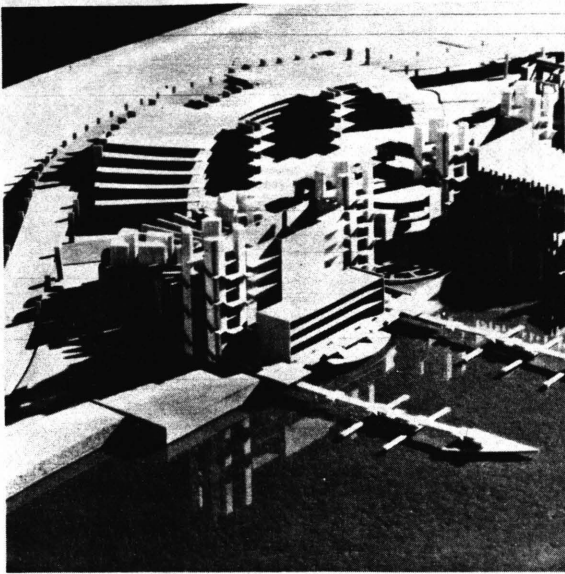

Playhouse

The stage area of the playhouse is flanked by the two northernmost towers. Extending over the river from the towers are two arms of the marina. The riverwalk connects the arms as it passes by the backstage areas and proceeds to the towers. From either of the towers, at the main level, one can access the backstage area, the upper levels, or the hall that leads to the lobby.

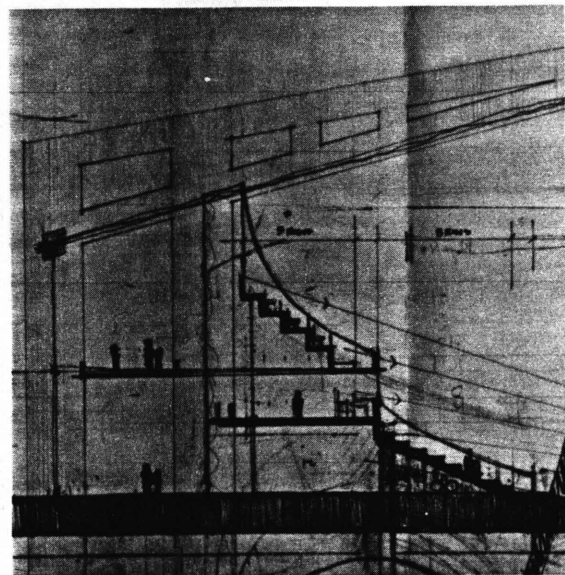

Before reaching the audience area, one arrives at a circular space, which signifies a change of direction. One immediately enters a second circular space and has the option of ascending to the balcony level, or turning and proceeding into the main lobby area. This transition space receives daylight through a twenty-foot diameter skylight supported by eighty-foot high columns. Light reaches the first level through a circular opening at the upper level. A turn in direction leads to the lobby which is enclosed on the land side by a seventy-foot high wall of glass. The wedge-shaped seating area is accessible from the lobby through light/sound locks and has the following seating distribution:

734 main level
24 box seats
<u>537 balcony</u>
1295 total

Performers and crew members would enter the backstage area through a tower at the first or second levels. Individual dress-

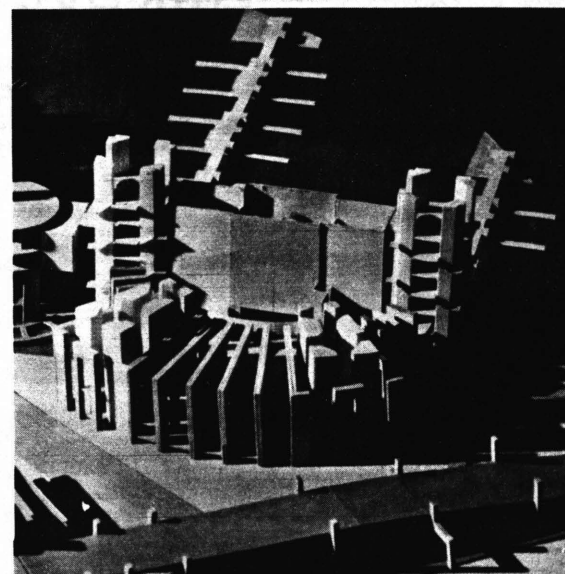

ing rooms are found on Level One, group dressing rooms on Level Two. All of these spaces, as well as the rehearsal and dance studios on Level Three, have views of the river.

Levels Four, Five, and Six lie within the wall above the stage and are accessible by elevators and stairways in the towers. Banquet rooms, which could easily serve additional temporary uses, are located on Level Four. The cafeteria is also located on this level on the other side of the tower and would provide food service for receptions. Levels Five and Six are comprised of four guest rooms and nine suites, intended to be used by performers and dignitaries. Mechanical equipment is located at the roof top.

The service entrance for this theatre is through the northernmost tower, whose second level has been left out to give a clearance of twenty-eight feet.

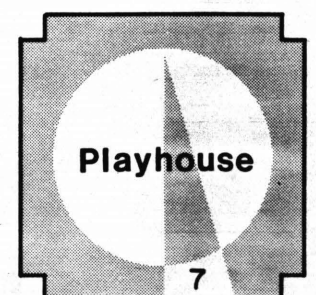
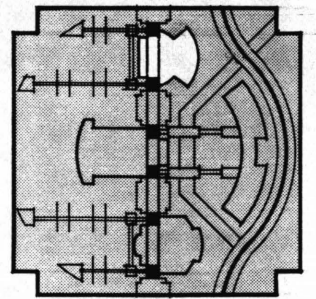

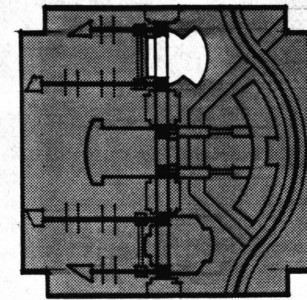
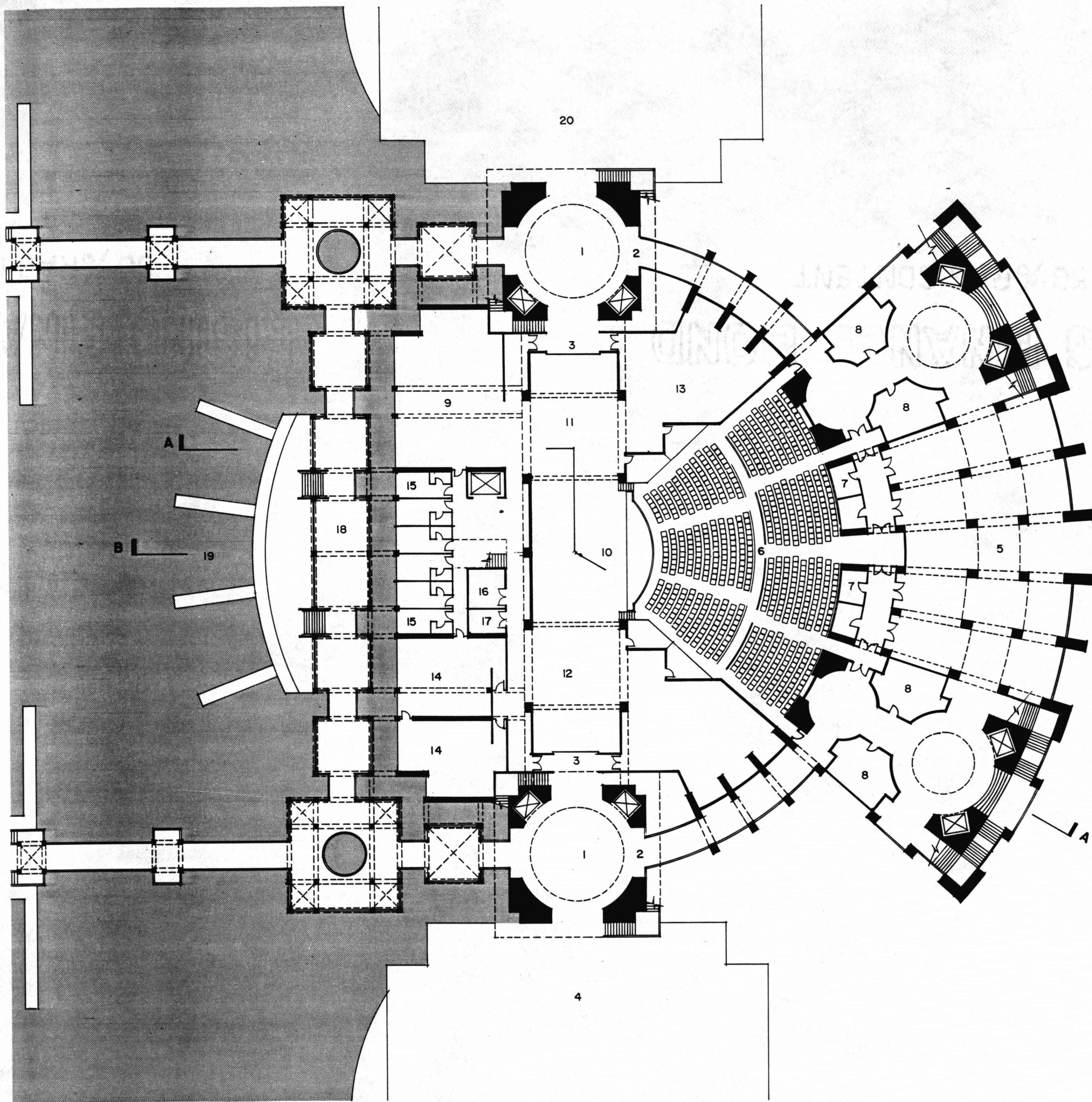

- 1 Stair/Elevator Tower
- 2 Patron Entrance
- 3 Service Entrance
- 4 North Plaza
- 5 Lobby
- 6 Audience Area
- 7 Box Seats
- 8 Rest Room
- 9 Scenery Shop
- 10 Center Stage
- 11 Stage Left
- 12 Stage Right
- 13 Costumes
- 14 Group Dressing Room
- 15 Star Dressing Room
- 16 Mechanical
- 17 Elevator Equipment
- 18 Riverwalk
- 19 Marina
- 20 Service Plaza

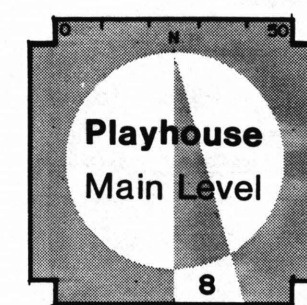

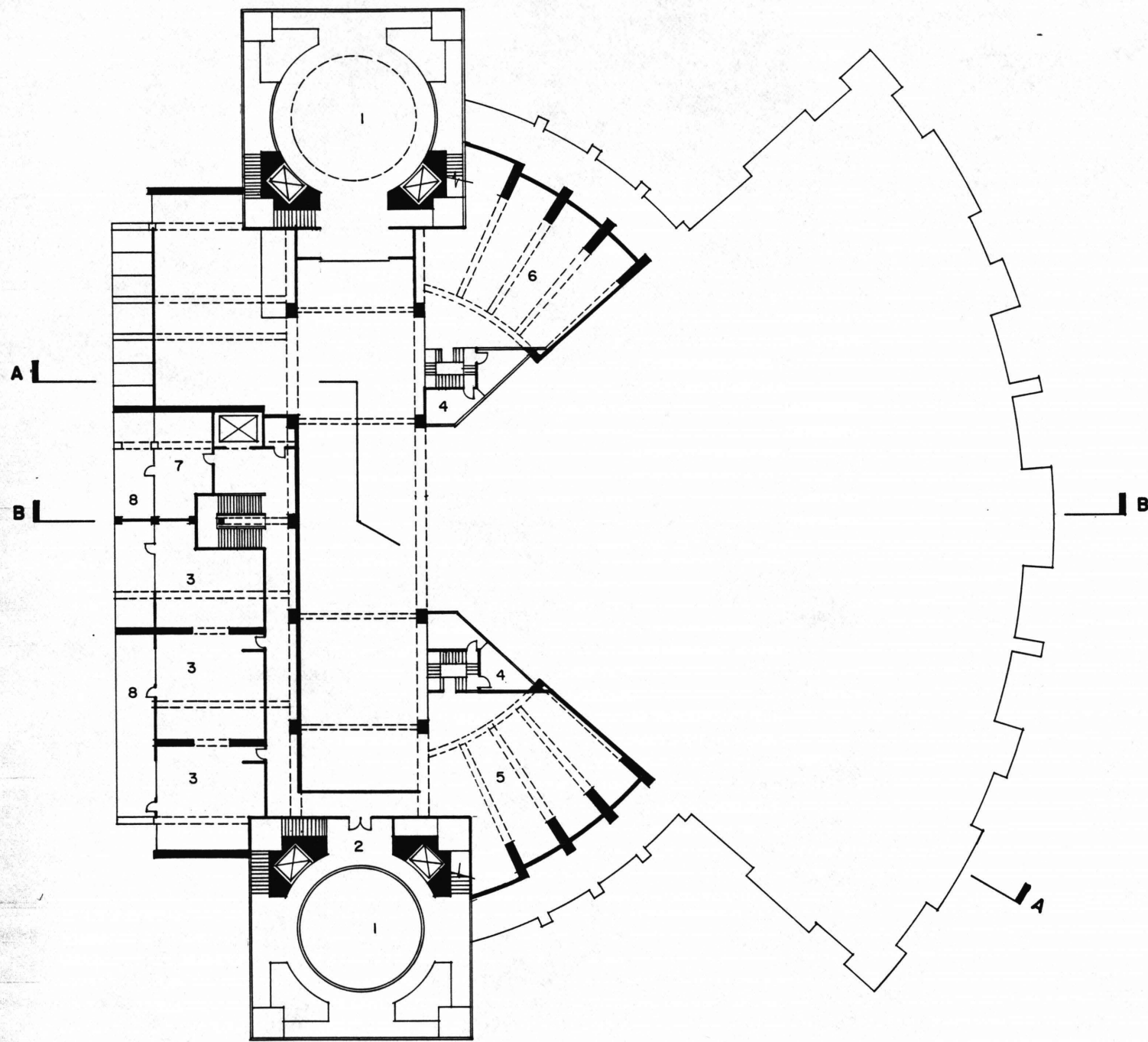
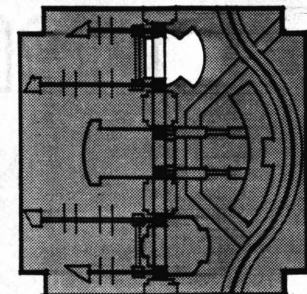

- 1 Stair/Elevator Tower
- 2 Performer Entrance
- 3 Group Dressing Rooms
- 4 Performance Balcony
- 5 Prop Storage
- 6 Storage Area
- 7 Green Room
- 8 Balcony

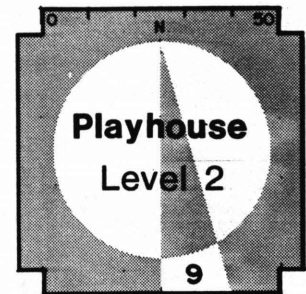

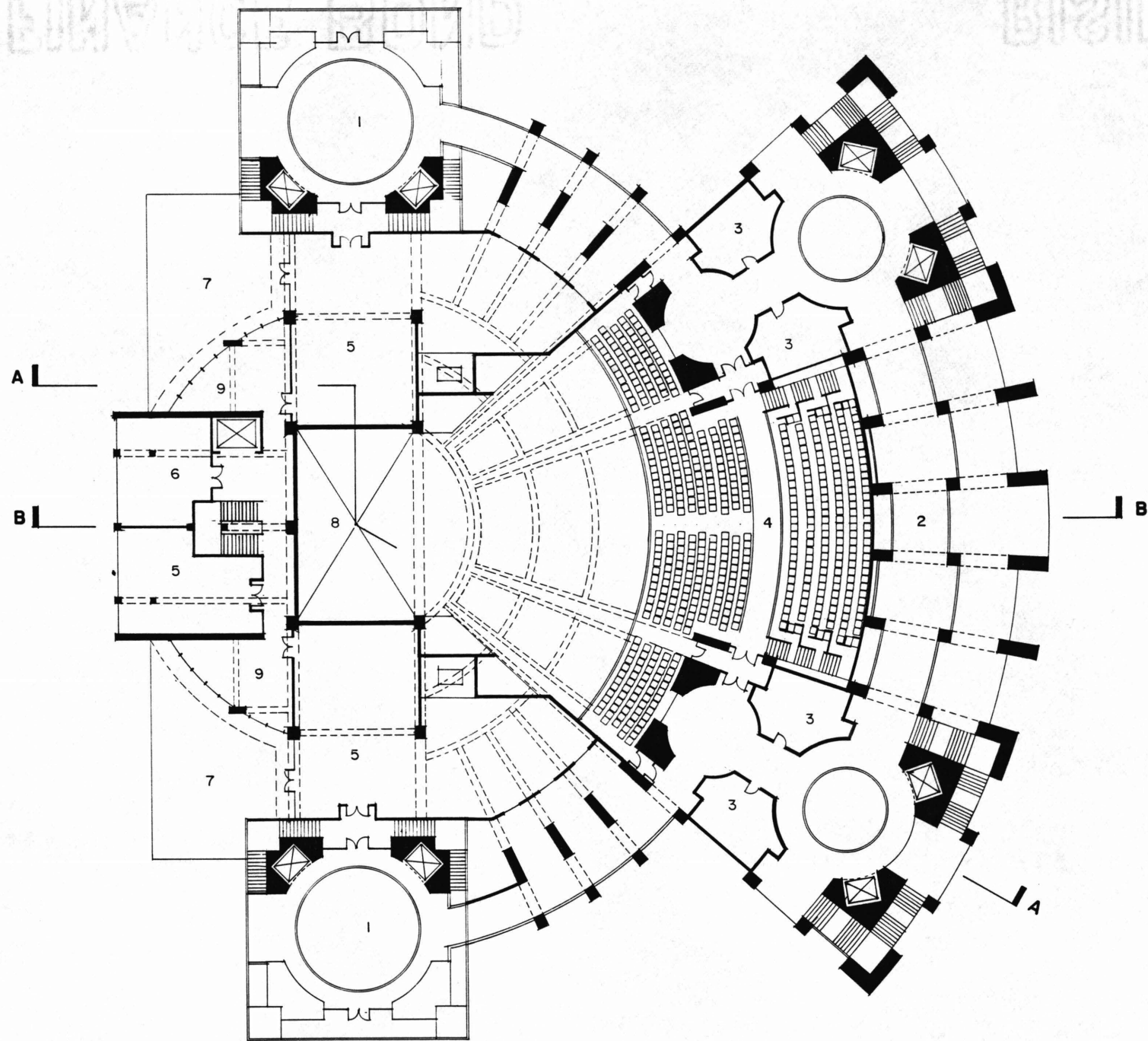
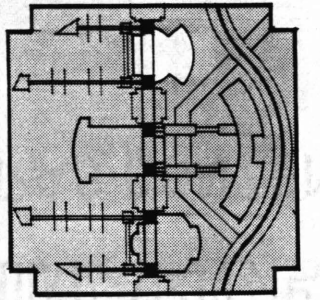

- 1 Stair/Elevator Tower
- 2 Balcony Lobby
- 3 Rest Room
- 4 Balcony Seating
- 5 Rehearsal Room
- 6 Offices
- 7 Roof Top Terrace
- 8 Fly Space
- 9 Lounge

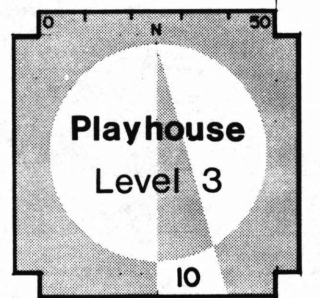

RECEPTION ROOMS

GUEST ROOMS

GUEST SUITES

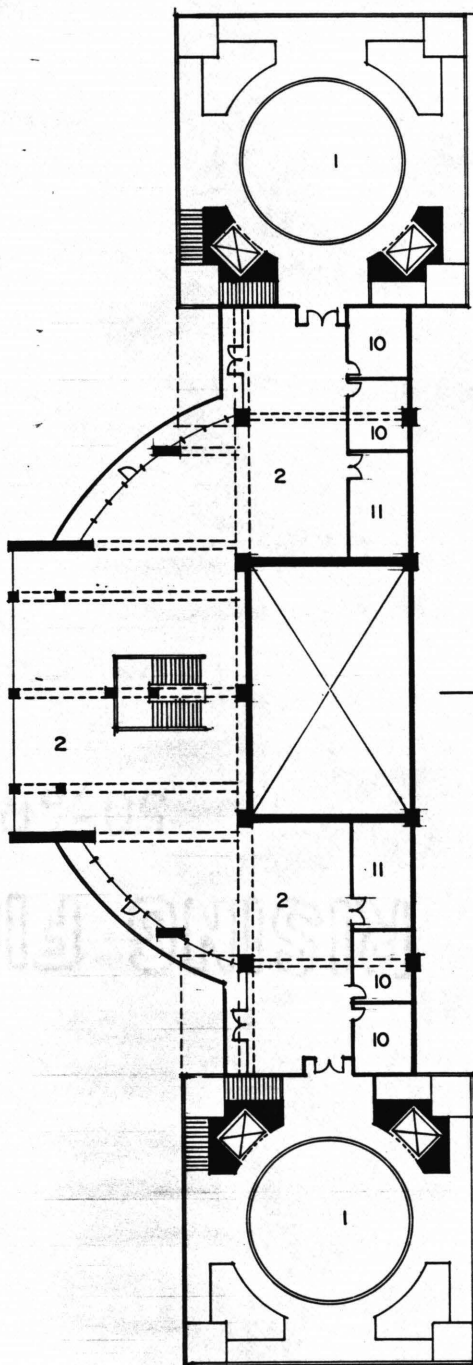
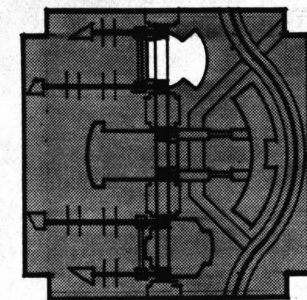

LEVEL 4

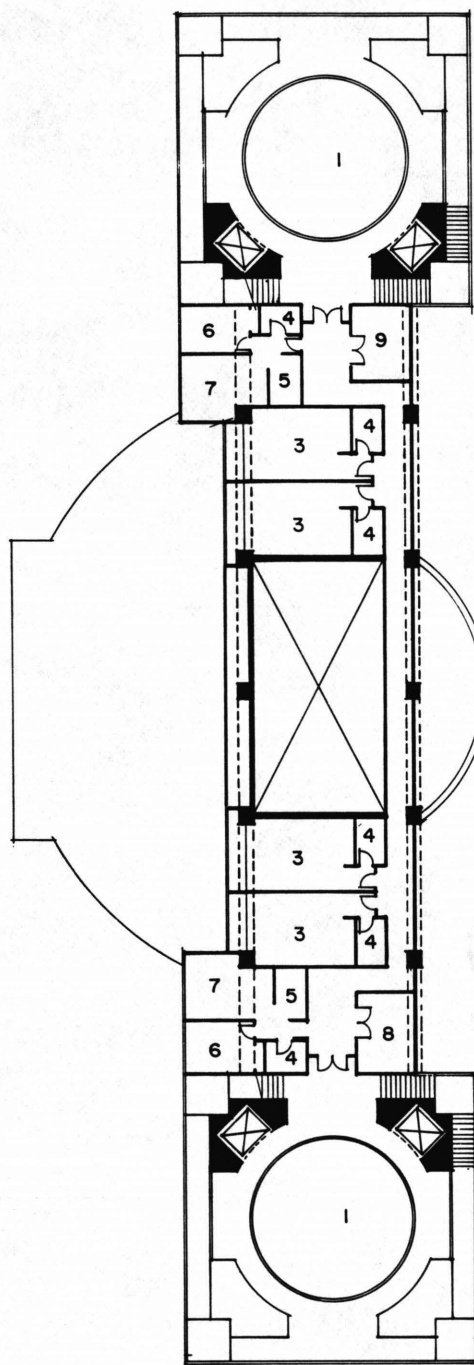

LEVEL 5

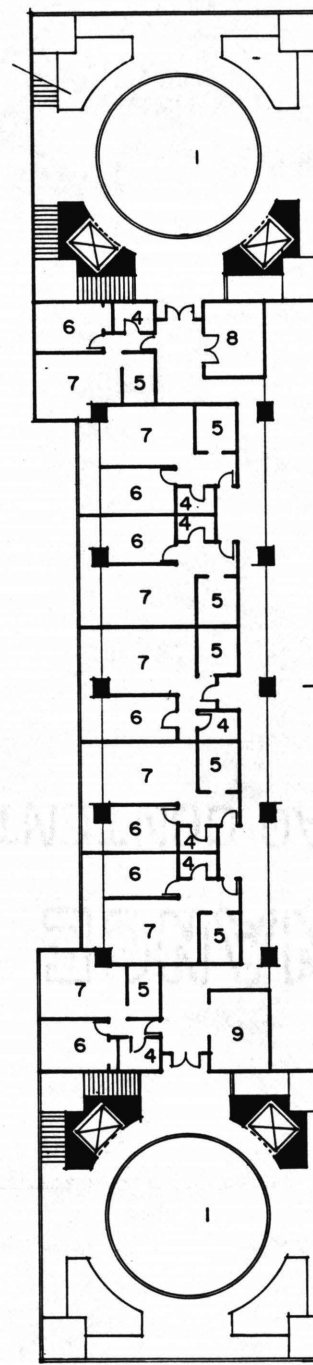

LEVEL 6

- 1 Stair/Elevator Tower
- 2 Reception/Banquet
- 3 Guest Room
- 4 Bathroom
- 5 Kitchen
- 6 Bedroom
- 7 Living Room
- 8 Laundry
- 9 Vending
- 10 Rest Room
- 11 Mechanical

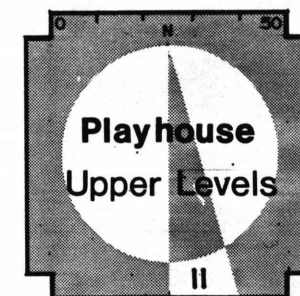

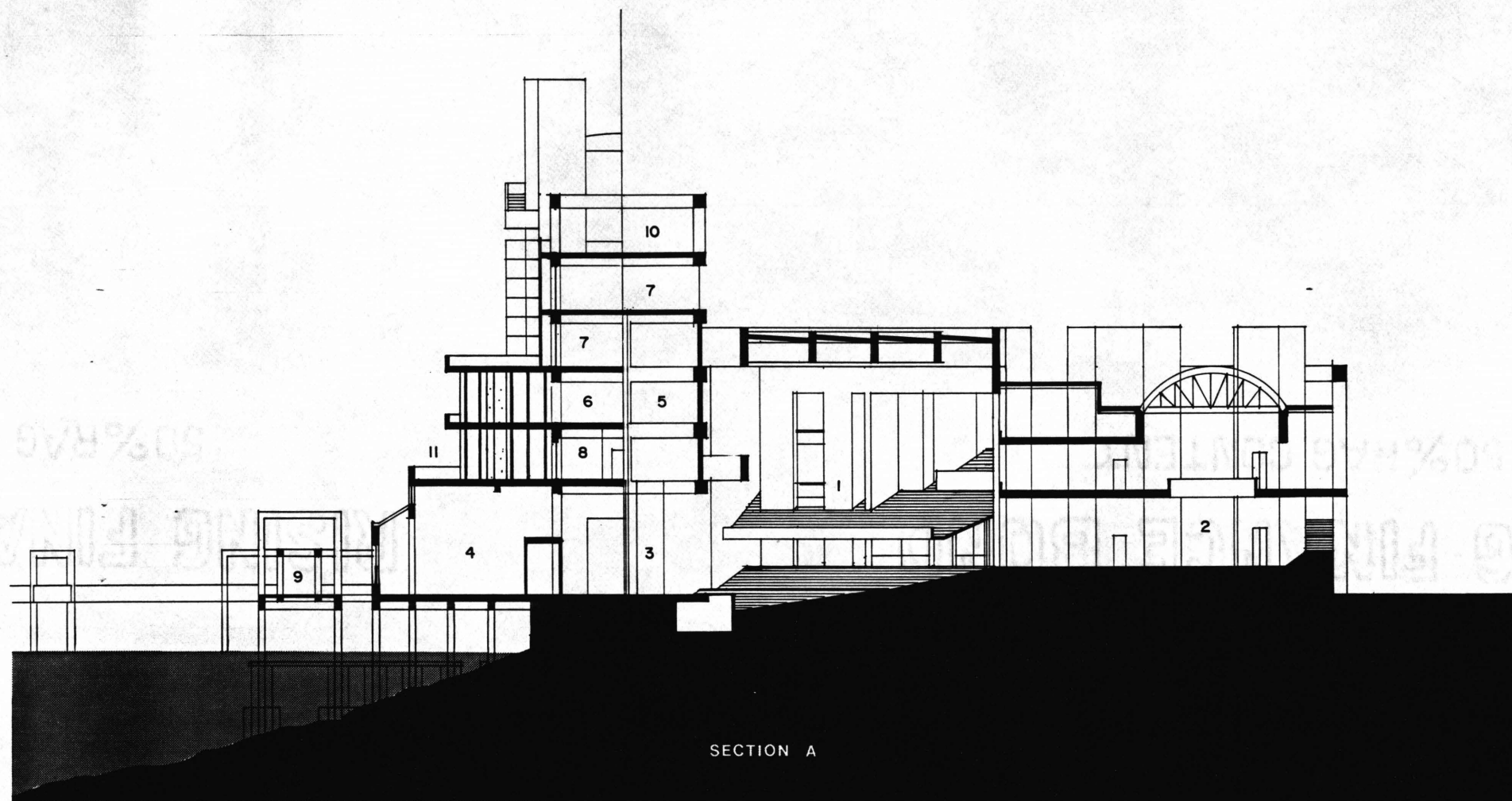
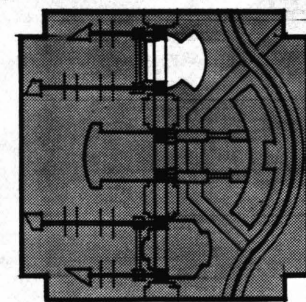

SECTION A

- 1 Audience Area
- 2 Lobby
- 3 Stage
- 4 Scenery Shop
- 5 Fly Space
- 6 Reception/Banquet
- 7 Guest Room
- 8 Rehearsal Room
- 9 Riverwalk
- 10 Mechanical
- 11 Terrace
- 12 Green Room
- 13 Star Dressing Room

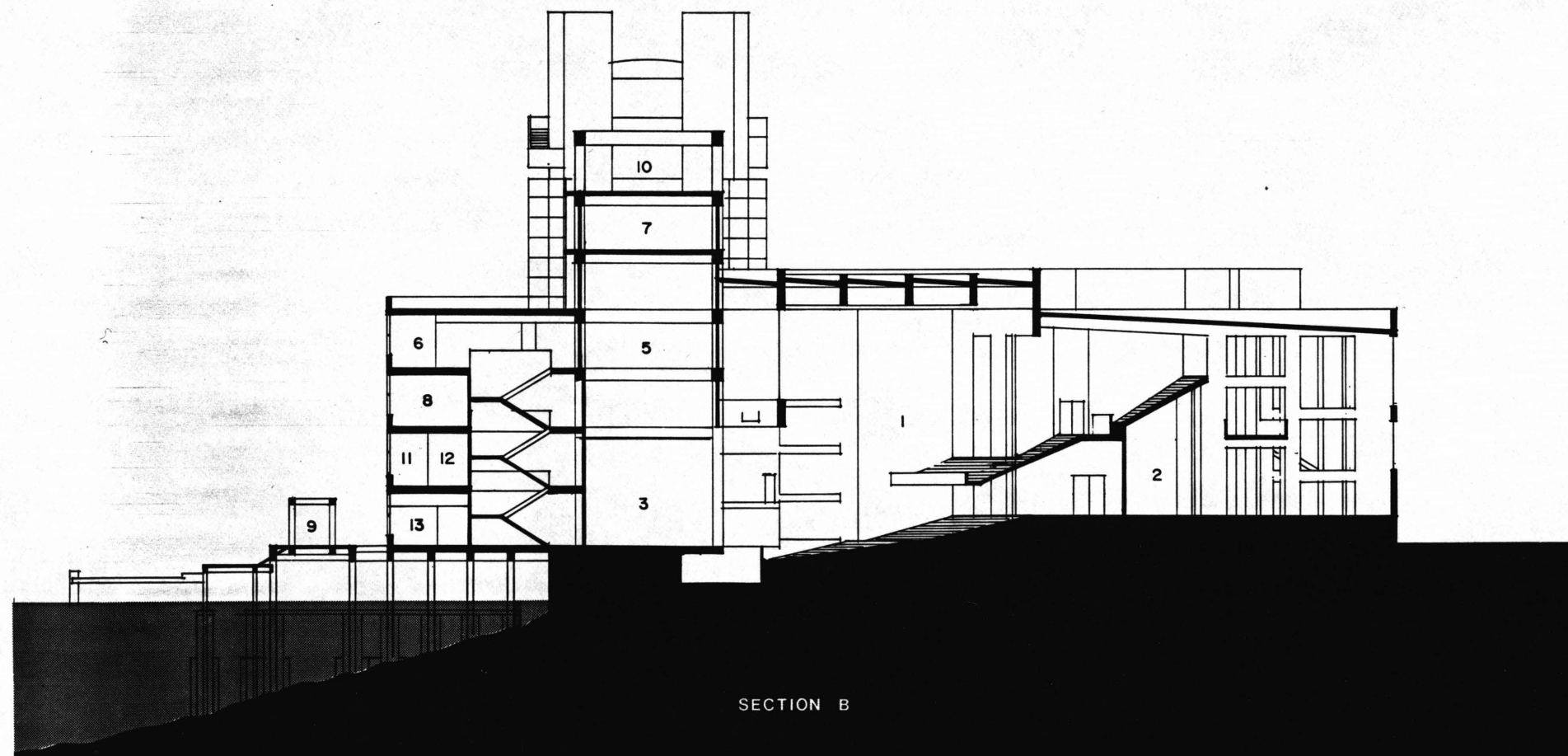

SECTION B

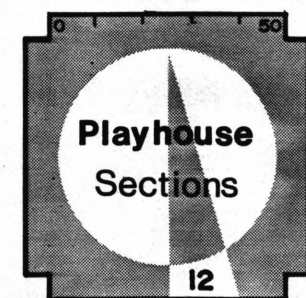

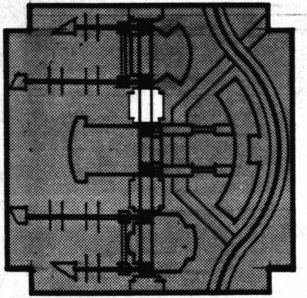

CAFETERIA

NIGHT CLUB

RESTAURANT

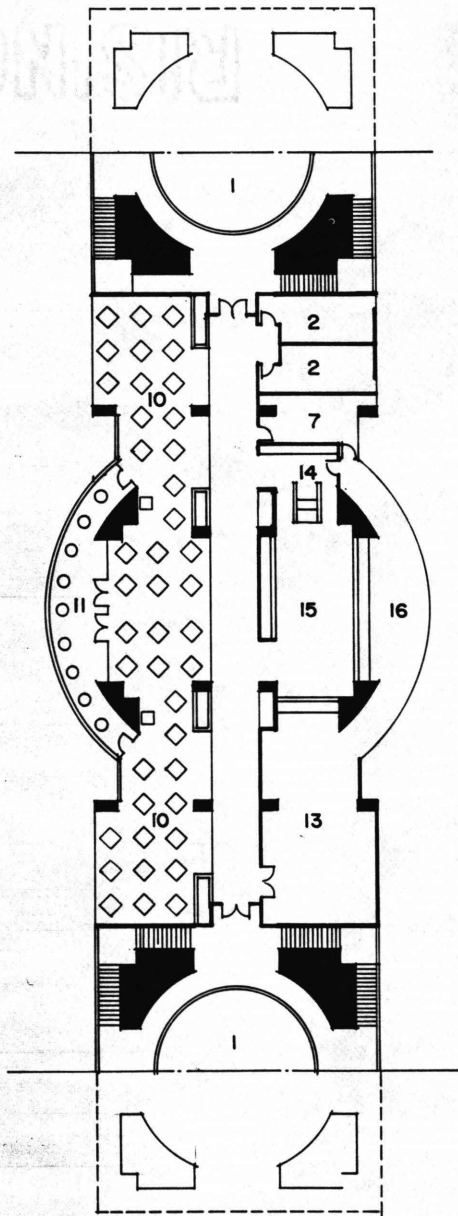

LEVEL 4

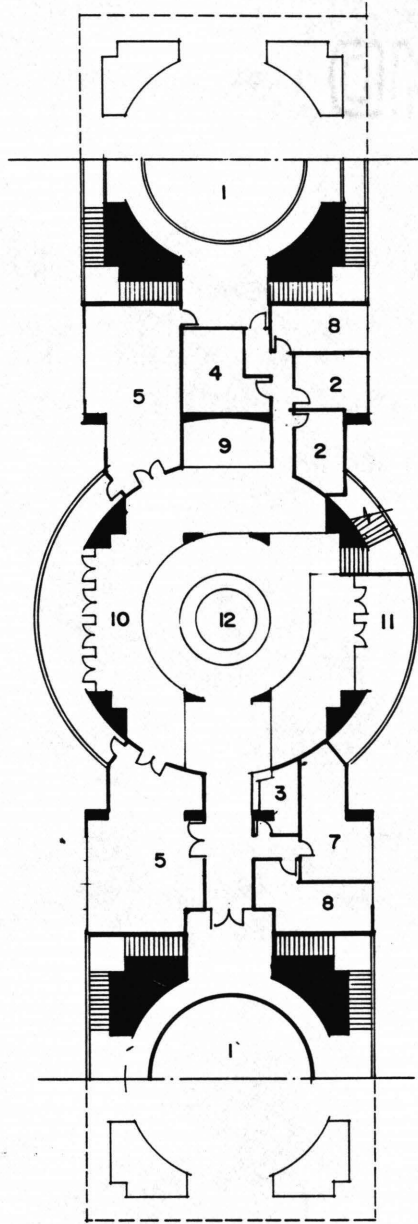

LEVEL 5

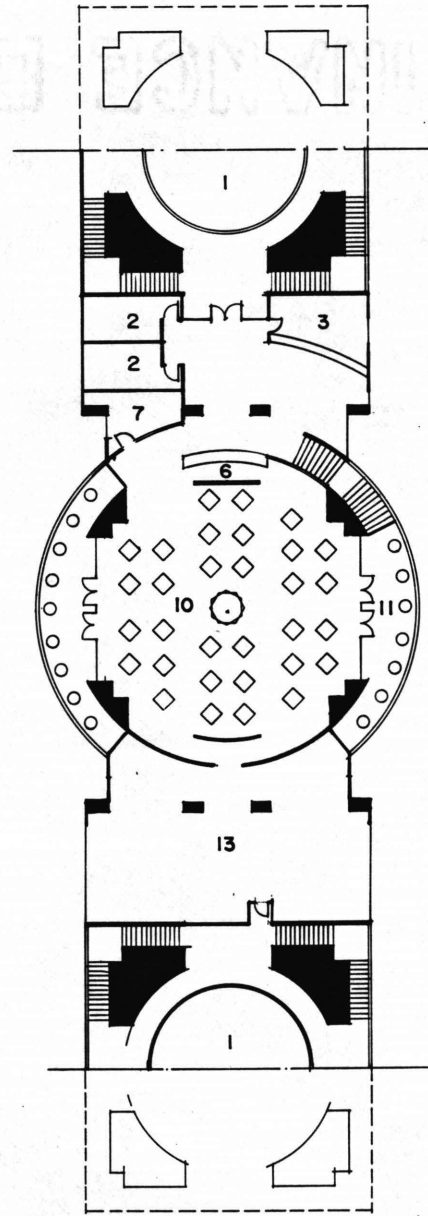

LEVEL 6

- 1 Stair/Elevator Tower
- 2 Restrooms
- 3 Cloak Room
- 4 Mechanical
- 5 Private Room
- 6 Maitre d'
- 7 Manager Office
- 8 Storage
- 9 Stage
- 10 Seating
- 11 Balcony Seating
- 12 Bar
- 13 Kitchen
- 14 Cashier
- 15 Serving Area
- 16 Food Preparation

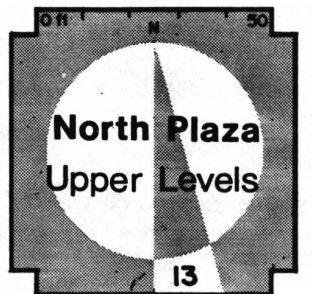

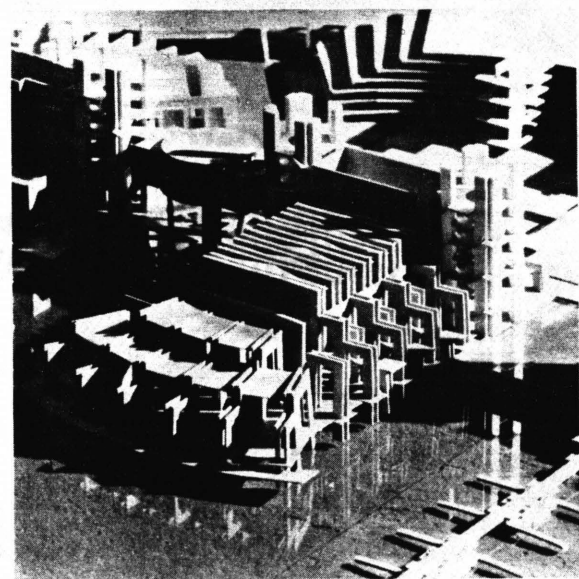
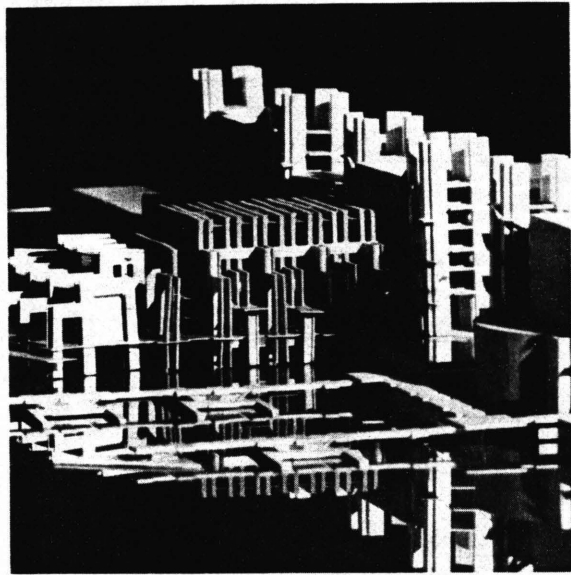

Symphony Hall

The audience area of this theatre is actually a pier jutting out into the river. Patrons enter through one of the two towers into a grand hallway which leads to the lobby. Passing through layers of structural concrete 'bents', the river is in view on one side through a thirty-foot high expanse of glass.

The planes of structure change direction to form the lobby, turning and pointing toward the center of the stage, which is also the center of the complex. Rest rooms, cloak rooms, and mechanical rooms are located on either side of the lobby between planes of structure, of which a few have remained solid. A panoramic view of the river is available from the lobby.

After passing through the light/sound lock, one enters the seating area which has been carved out of the parallel walls. Two levels of box seats are supported between the columns on each side of the hall. These have access to terraces which overlook the river. Additionally, two general seating balconies line the rear wall. The hall has a seating capacity of 1865 seats and is distributed as follows:

1477	main level
184	first balcony
132	second balcony
<u>72</u>	<u>box seats</u>
1865	total

Practice rooms are located on Levels Two and Three and have a view of the garden and the City beyond. Administrative offices for the complex and the library are symbolically, as well as practically, located at the physical center of the complex on Levels Four, Five, and Six, above the stage.

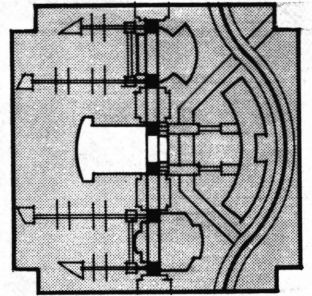

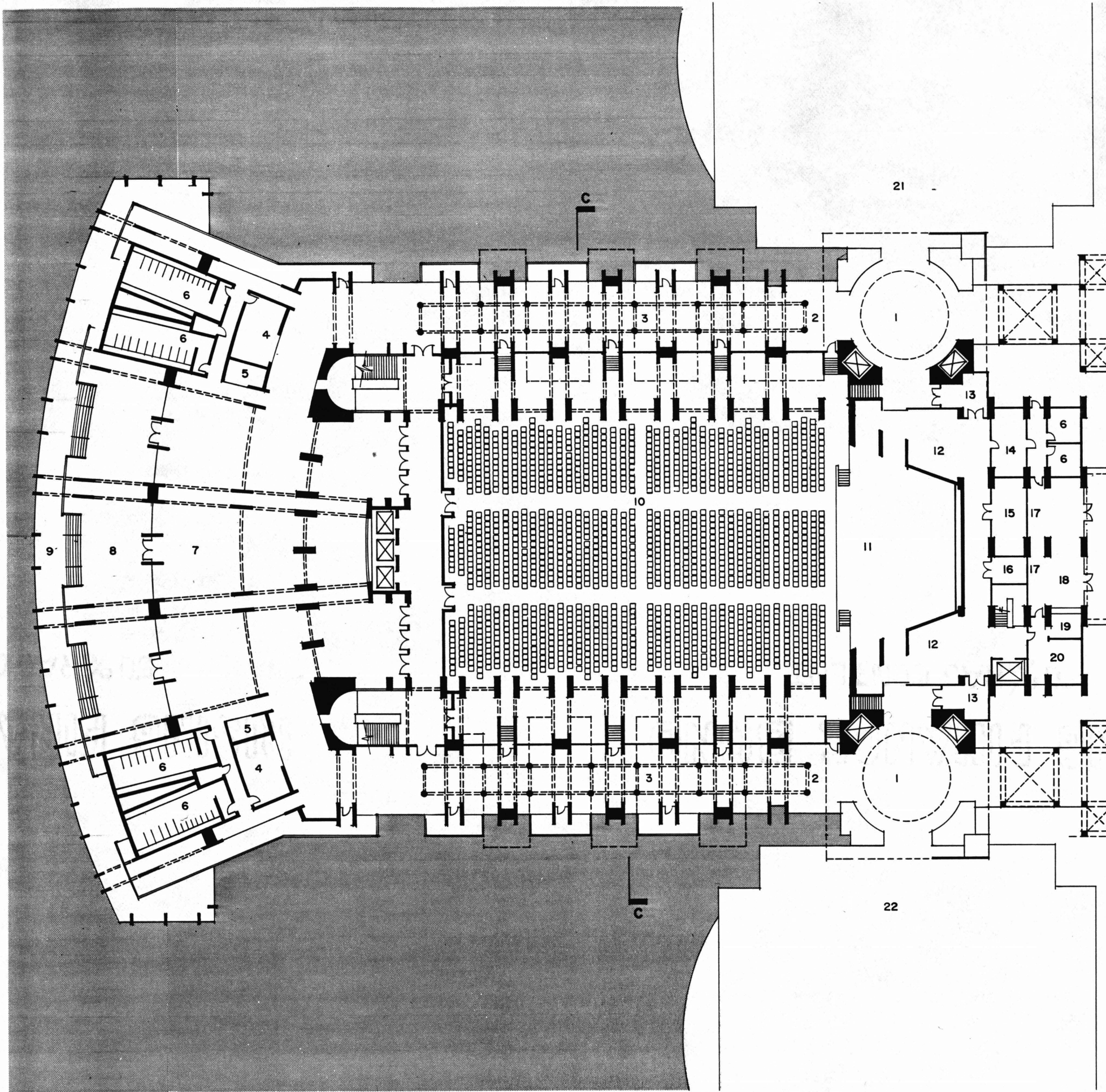
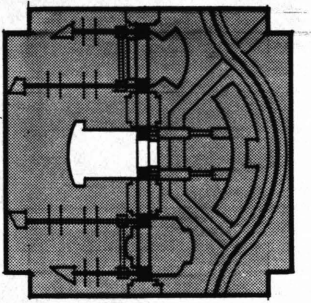

- 1 Stair/Elevator Tower
- 2 Patron Entrance
- 3 Entrance Corridor
- 4 Cloak Room
- 5 Refreshments
- 6 Restrooms
- 7 Lobby
- 8 Terrace
- 9 Boat Dock
- 10 Audience Area
- 11 Stage
- 12 Assembly Area
- 13 Performer Entrance
- 14 Green Room
- 15 Storage
- 16 Mechanical
- 17 Display
- 18 Box Office Lobby
- 19 Tickets
- 20 Manager Office

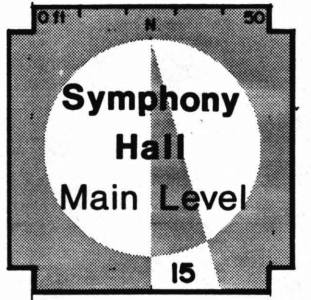

LEVEL 2

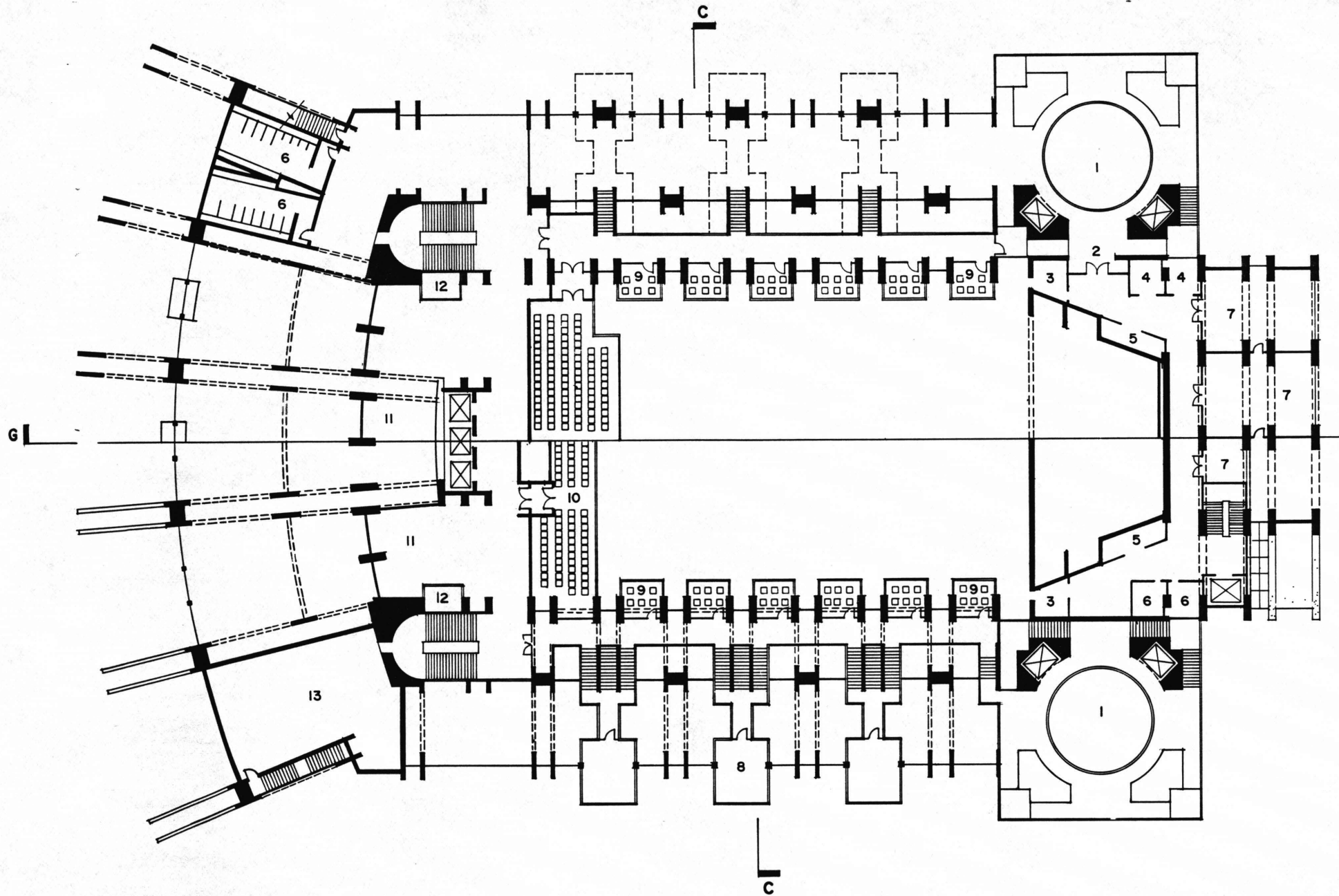
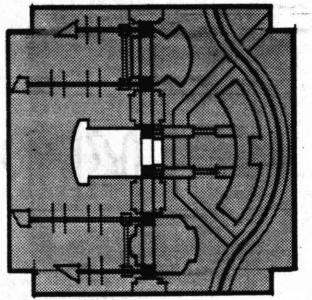

- 1 Stair/Elevator Tower
- 2 Employee Entrance
- 3 Lounge
- 4 Office
- 5 Storage/Mechanical
- 6 Restrooms
- 7 Rehearsal Room
- 8 Terrace
- 9 Balcony Box Seats
- 10 Balcony Seating
- 11 Balcony Lobby
- 12 Refreshments
- 13 Mechanical

LEVEL 3



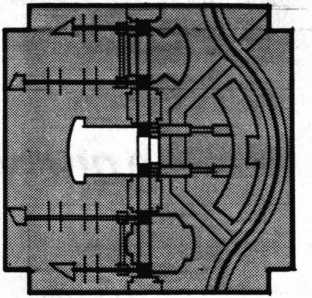

ADMINISTRATION

LIBRARY

ADMINISTRATION

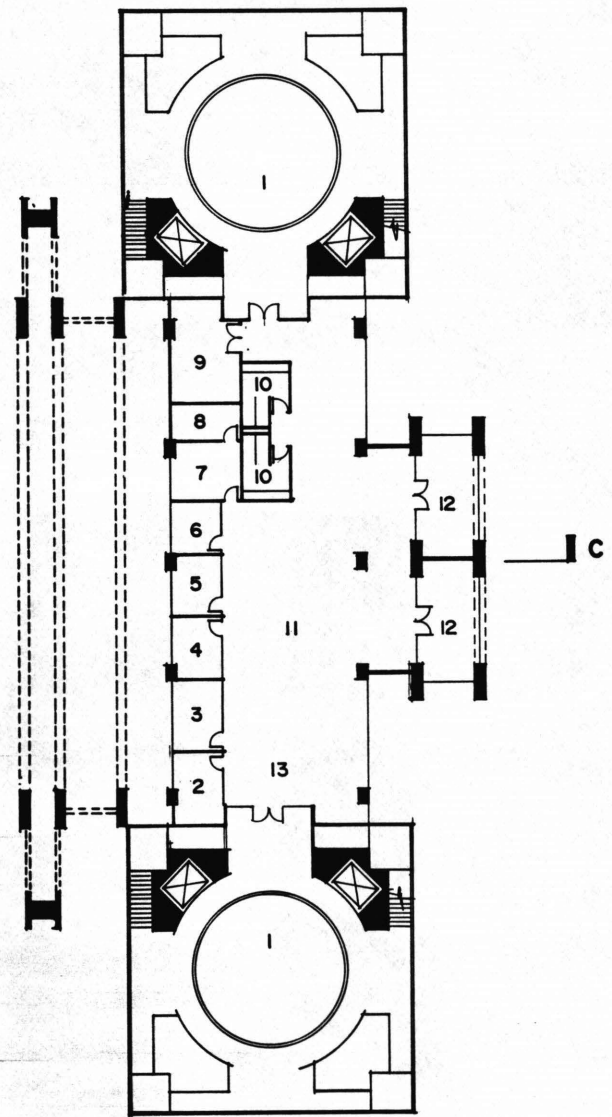

LEVEL 4

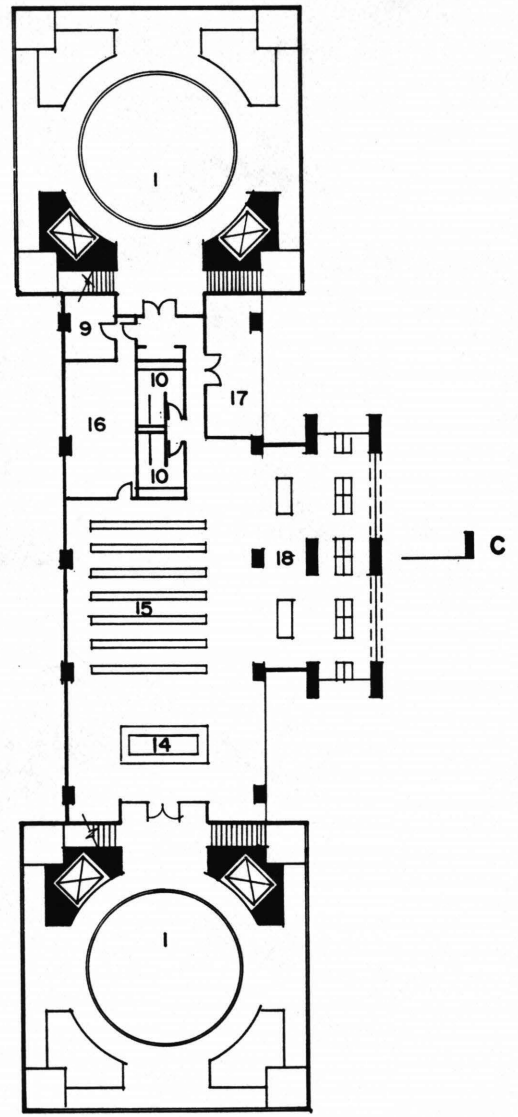

LEVEL 5

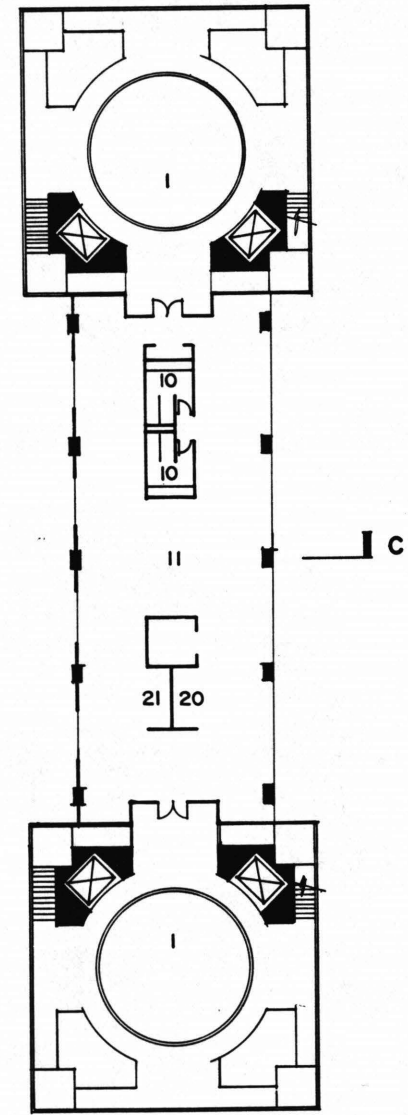

LEVEL 6

- 1 Stair/Elevator Tower
- 2 Production Manager
- 3 Office
- 4 Conductor
- 5 Office
- 6 Office
- 7 Press & Publicity
- 8 Darkroom
- 9 Mechanical
- 10 Restrooms
- 11 Open Office Plan
- 12 Conference Room
- 13 Reception
- 14 Circulation Desk
- 15 Stacks
- 16 Storage/Processing
- 17 Library Office
- 18 Study Area
- 19 Office Space
- 20 Copier/Supplies
- 21 Coffee Bar



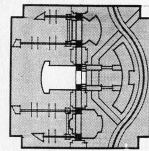
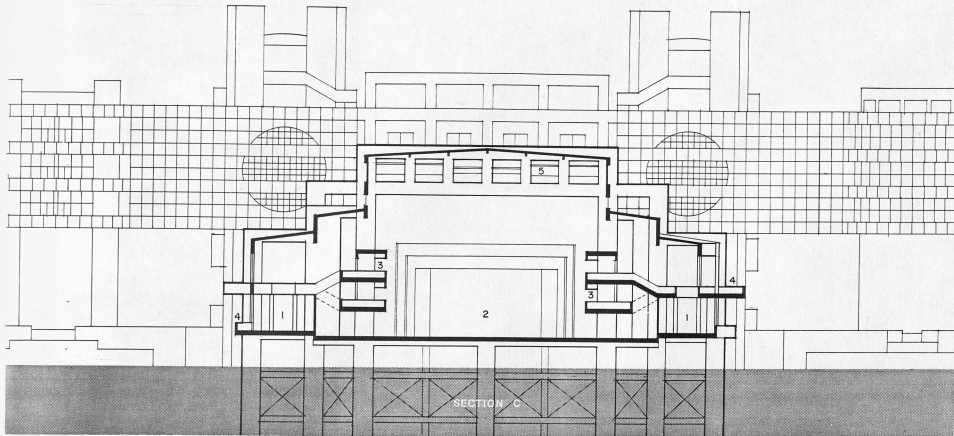

- 1 Entrance Corridor
- 2 Audience Area
- 3 Box Seats
- 4 Terrace
- 5 Adjustable Sound Deflectors
- 6 Restaurant
- 7 Night Club
- 8 South Plaza
- 9 Kitchen Prep Area
- 10 Balcony

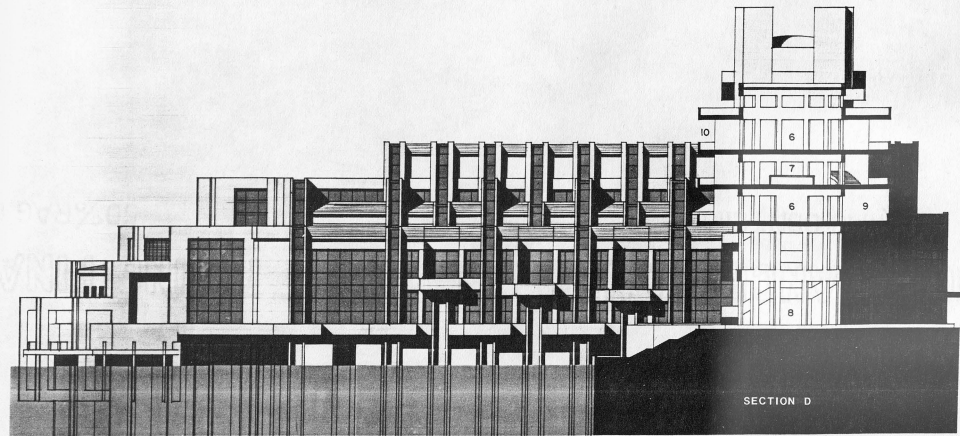

0' 1" 50'

**Symphony
Hall
Section &
Elevation**

18

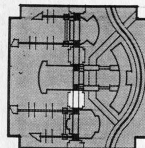

RESTAURANT

NIGHT CLUB

RESTAURANT

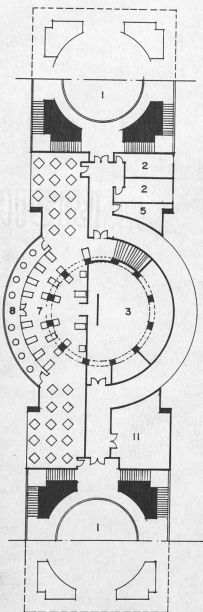

LEVEL 4

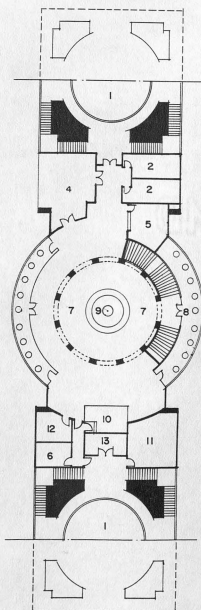

LEVEL 5

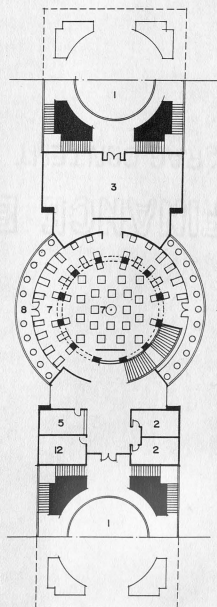

LEVEL 6

- 1 Stair/Elevator Tower
- 2 Restrooms
- 3 Kitchen
- 4 Private Room
- 5 Cloak Room
- 6 Employee Lounge
- 7 Seating Area
- 8 Balcony Seating
- 9 Seating Area
- 10 Stage
- 11 Mechanical
- 12 Manager Office
- 13 Storage

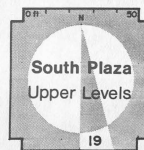

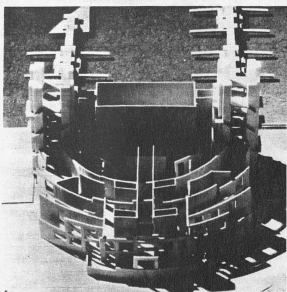
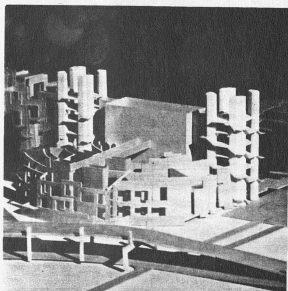

Opera House

The Opera House shares many of the characteristics of the Playhouse, due partly to the overall symmetry of the master plan. Its structural order is, however, quite different. A series of walls laid out in concentric arcs centered on the stage define the patron area and its spaces.

Similar to the other theatres, one enters through a tower/node into an entrance corridor which leads to the lobby. Openings within the concentric walls allow one to pass through the layers to be guided by a more solid wall into the lobby. The nature of the walls changes depending upon their distance from the center. The innermost wall, that which encloses the seating area is the most dense, having a minimum number of openings. As the distance from the center increases, the walls become lighter and less dense, allowing more light to penetrate the space that it encloses. The seating has the following distribution:

718 main level
24 box seats
<u>260 balcony</u>
1002 total

The stage area is designed to accommodate three full sets. They would be moved to and from the left, right, and rear stage areas. Star and small group dressing rooms are located on the main level. Large group dressing rooms are situated on Level Two. All have a view towards the river.

Level Three of the backstage area contains the rehearsal and dance studios as well as roof top terraces. Banquet/reception rooms are found on Level Four. Level Five and Six contain six guest rooms and eight guest suites.

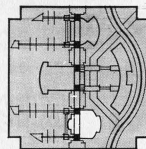

25

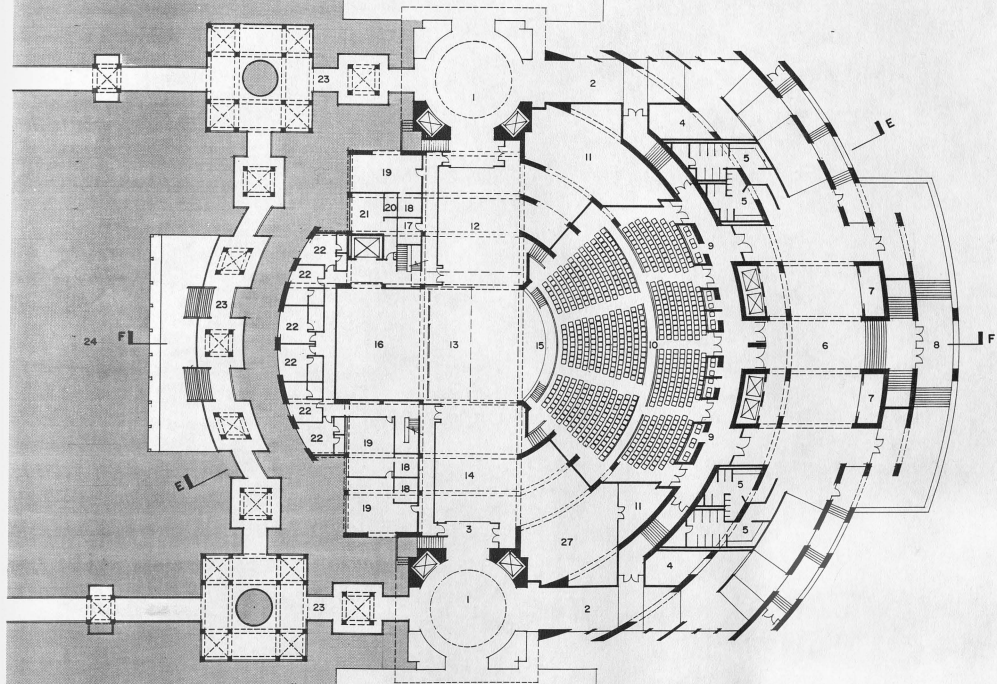
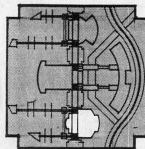

- 1 Stair/Elevator Tower
- 2 Entrance Corridor
- 3 Service Entrance
- 4 Cloak Room
- 5 Restroom
- 6 Lobby
- 7 Refreshments
- 8 Terrace
- 9 Box Seats
- 10 Audience Area
- 11 Prop Storage
- 12 Stage Left
- 13 Center Stage
- 14 Stage Right
- 15 Orchestra Pit
- 16 Rear Stage
- 17 Elevator/Equipment
- 18 Toilets/Showers
- 19 Group Dressing Room
- 20 Kitchen
- 21 Green Room
- 22 Star Dressing Room
- 23 Riverwalk
- 24 Marina
- 25 South Plaza
- 26 Service Plaza
- 27 Scenery Shop

26



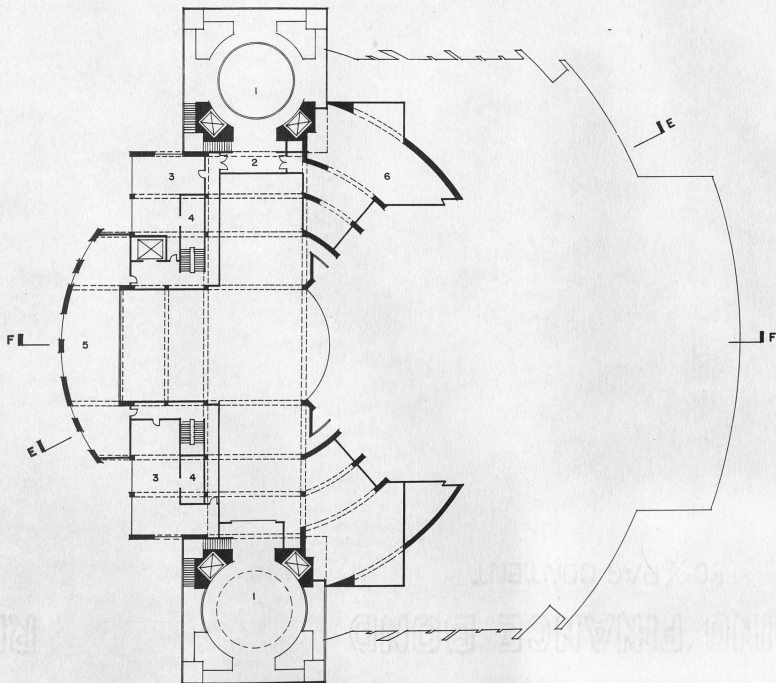
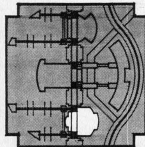

- 1 Stair/Elevator Tower
- 2 Performer Entrance
- 3 Large Group Dressing Room
- 4 Toilets/Showers
- 5 Rehearsal Room
- 6 Costume



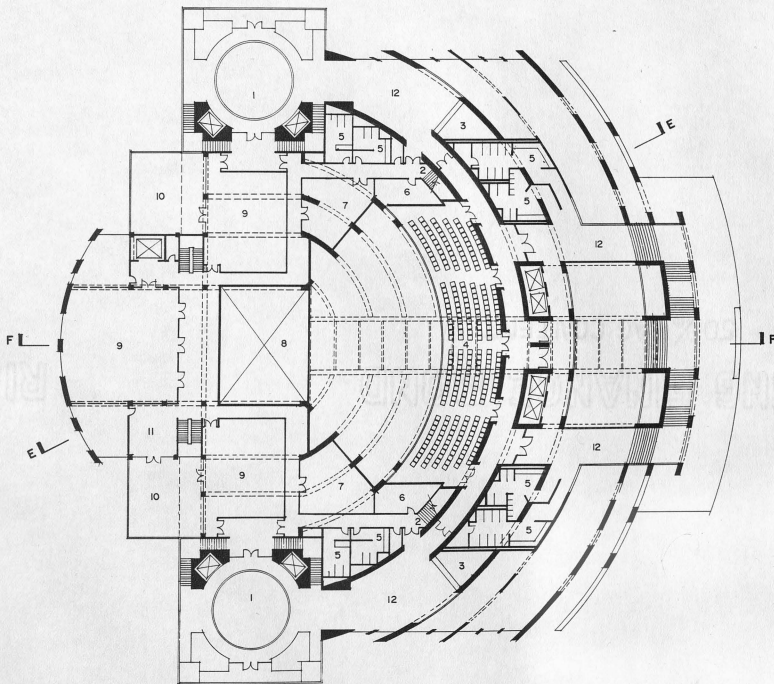
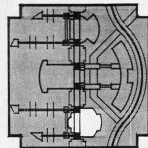

- 1 Stair/Elevator Tower
- 2 Stair to Light/Sound Booth
- 3 Refreshments
- 4 Balcony Seating
- 5 Restrooms
- 6 Storage
- 7 Mechanical
- 8 Fly Space
- 9 Rehearsal Room
- 10 Rooftop Terrace
- 11 Lounge
- 12 Balcony Lobby



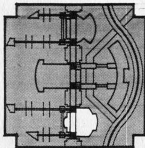

RECEPTION ROOMS

GUEST ROOMS

GUEST SUITES

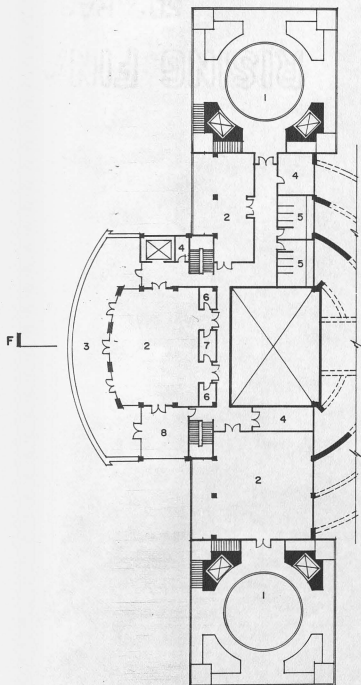

LEVEL 4

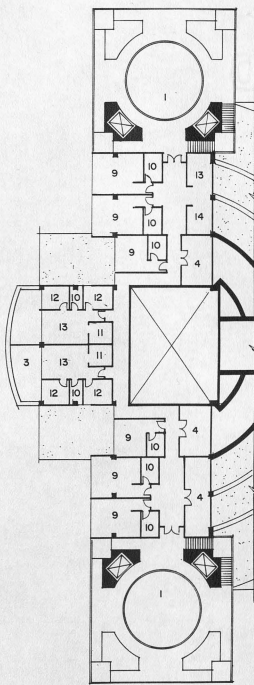

LEVEL 5

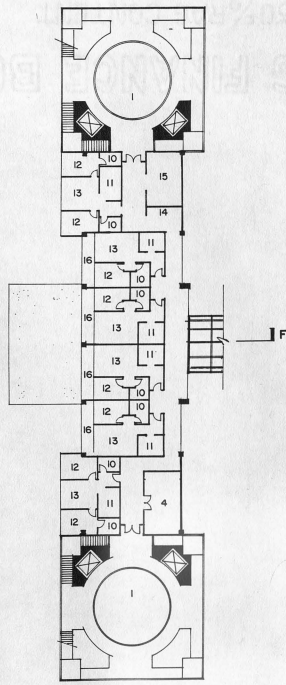

LEVEL 6

- 1 Stair/Elevator Tower
- 2 Reception/Banquet
- 3 Rooftop Terrace
- 4 Mechanical
- 5 Restrooms
- 6 Storage
- 7 Cloak Room
- 8 Lounge
- 9 Guest Room
- 10 Bathroom
- 11 Kitchen
- 12 Bedroom
- 13 Living Room
- 14 Vending
- 15 Laundry
- 16 Balcony

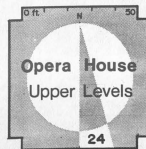

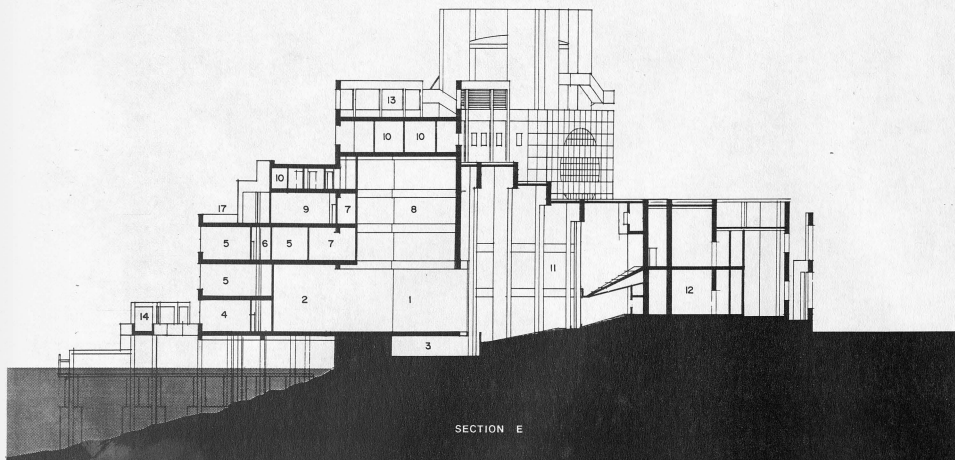
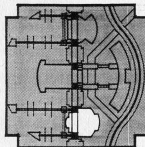

SECTION E

- 1 Stage
- 2 Rear Stage
- 3 Orchestra Pit
- 4 Star Dressing Room
- 5 Rehearsal Room
- 6 Lounge
- 7 Corridor
- 8 Fly Space
- 9 Reception/Banquet
- 10 Guest Room
- 11 Audience Area
- 12 Lobby
- 13 Rooftop Mechanical
- 14 Riverwalk
- 15 Bathroom
- 16 Cloak Room

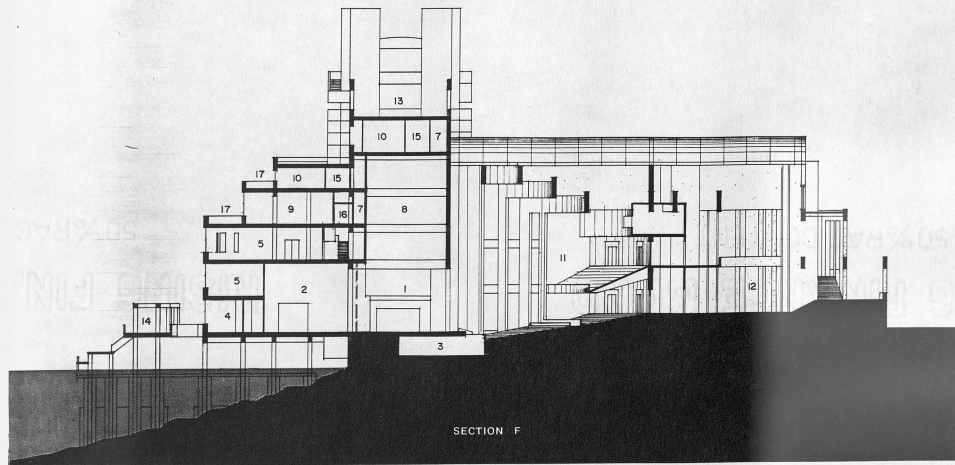

SECTION F

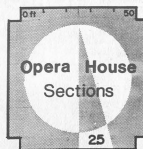

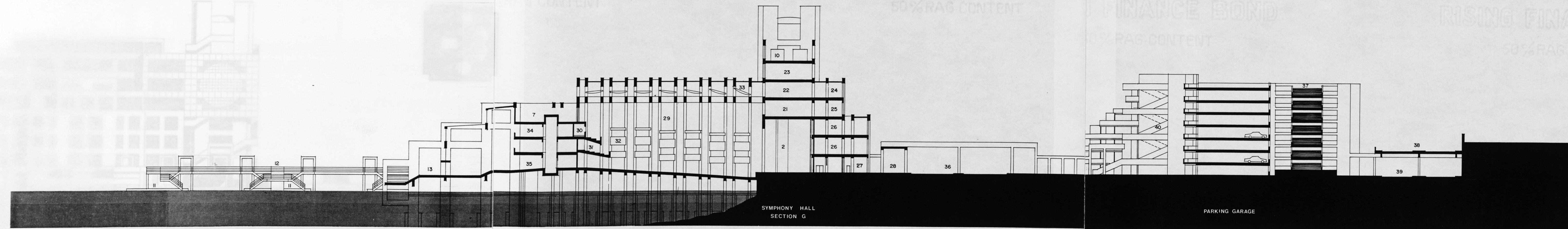

SYMPHONY HALL
SECTION G

PARKING GARAGE

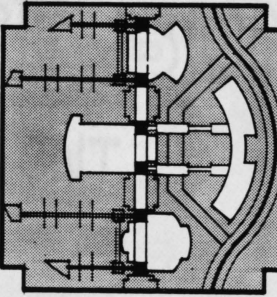

- 1 Stair/Elevator Tower
- 2 Stage
- 3 Stage Right
- 4 Stage Left
- 5 Rehearsal Room
- 6 Performer Entrance
- 7 Mechanical
- 8 Corridor
- 9 Living Room
- 10 Roof-top Mechanical
- 11 Boat Dock
- 12 Walkway
- 13 Terrace
- 14 Fly Space
- 15 Kitchen
- 16 Dining Area
- 17 Bar
- 18 Waiting Area
- 19 Maitre d'
- 20 Storage
- 21 Open Office Area
- 22 Library
- 23 Office Space
- 24 Study Area
- 25 Conference Room
- 26 Practice Room
- 27 Box Office
- 28 Riverwalk
- 29 Audience Area
- 30 Light/Sound Booth
- 31 Balcony
- 32 Box Seats
- 33 Adjustable Sound Deflectors
- 34 Balcony Lobby
- 35 Lobby
- 36 Drop Off Area
- 37 Ramps
- 38 Parkway
- 39 Access Road
- 40 Escalators
- 41 Reception/Banquet
- 42 Guest Rooms

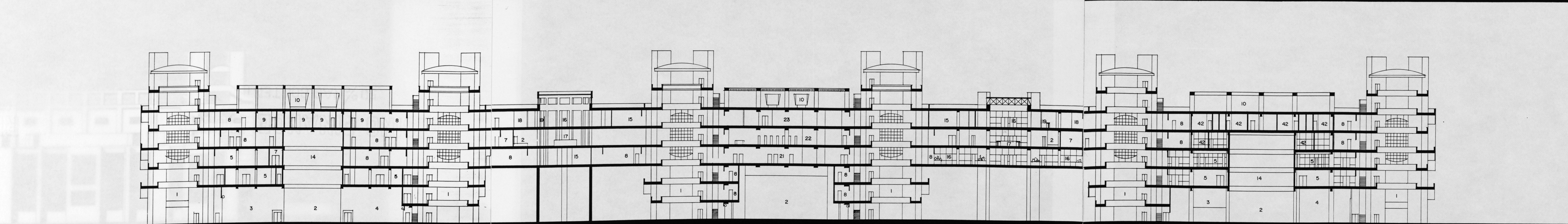

OPERA HOUSE

SOUTH PLAZA

SYMPHONY HALL
SECTION H

NORTH PLAZA

PLAYHOUSE

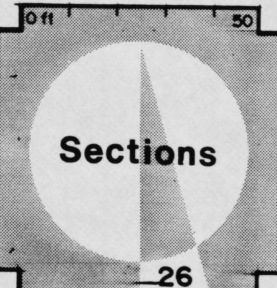

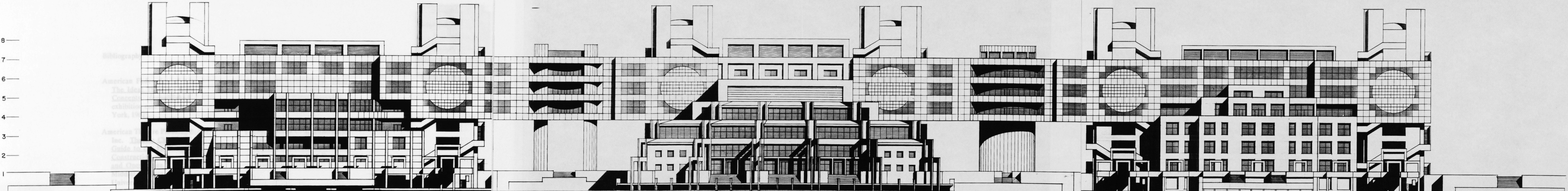

PLAYHOUSE

NORTH PLAZA

SYMPHONY HALL
RIVER ELEVATION

SOUTH PLAZA

OPERA HOUSE

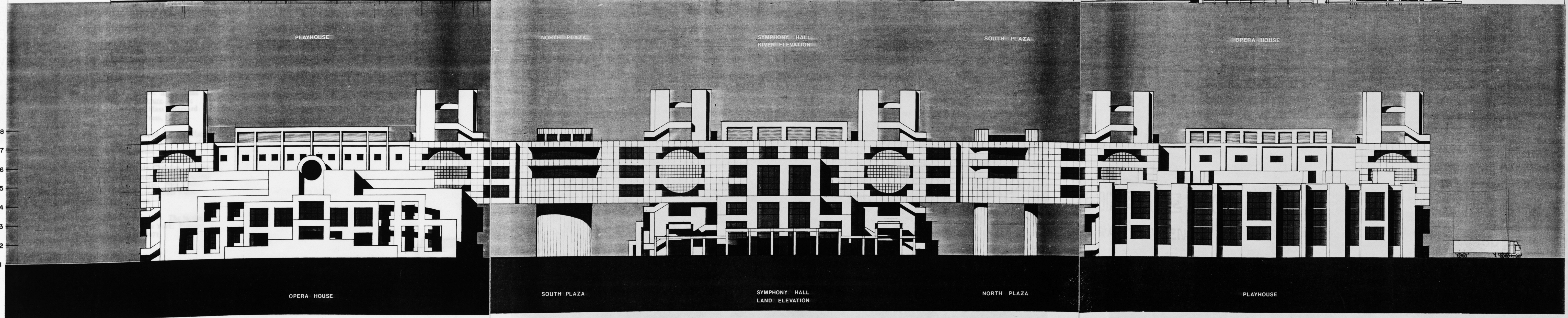

OPERA HOUSE

SOUTH PLAZA

SYMPHONY HALL
LAND ELEVATION

NORTH PLAZA

PLAYHOUSE

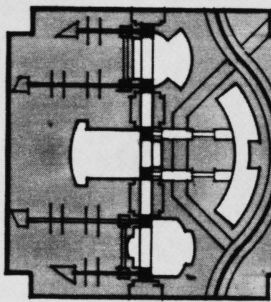

Elevations

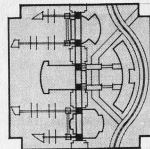

Bibliography

- American Federation of Arts. The Ideal Theatre: Eight Concepts. (unpublished exhibition catalogue, New York, 1962).
- American Theatre Planning Board, Inc. Theatre Checklist: A Guide to the Planning and Construction of Proscenium and Open Stage Theatres. Middleton, Conn.: Wesleyan University Press, 1969.
- Bronowski, Jacob. The Ascent of Man. Boston: Little, Brown and Company, 1976.
- Dal Co, Francesco; Mazzariol, Giuseppe. Carlo Scarpa: The Complete Works. New York: Rizzoli International Publications, 1984.
- Giedion, Sigfried. Space, Time and Architecture. 5th ed.; Cambridge, Mass.: Harvard University Press, 1982.
- Ham, Roderick, ed. Theatre Planning. Toronto: University of Toronto Press.
- Norberg-Schulz, Christian. Genius Loci: Towards a Phenomenology of Architecture. New York: Rizzoli International Publications, 1980.
- Schubert, Hannevor. The Modern Theatre. New York: Praeger Publishers, 1971.
- Wurman, Richard Saul, ed. What Will Be Has Always Been. New York: Rizzoli International Publications, 1986.
- Young, William C. Documents of American Theatre History: Famous American Playhouses. Chicago: American Library Association, 1973.

**The vita has been removed from
the scanned document**