



# WET NORTHFACE TEAL

by

Leonard Harrison Simpson IV

Thesis submitted to the Faculty of the  
Virginia Polytechnic Institute and State University  
in partial fulfillment of the requirements for the Degree of:  
MASTER OF ARCHITECTURE

Approved:

x \_\_\_\_\_  
Dayton Eugene Egger, Chairman

x \_\_\_\_\_  
William W. Brown

x \_\_\_\_\_  
Olivio C. Ferrari

August, 1990  
Blacksburg, Virginia



to my family<sup>1</sup>.

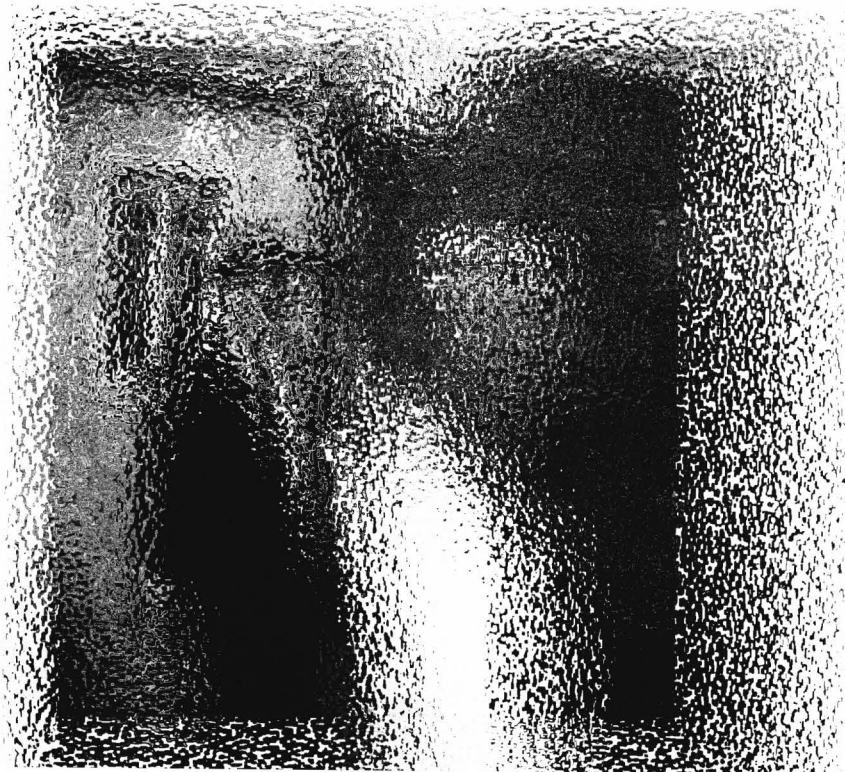

If this is now an adventure it  
is nothing, said my father

Inspiration: And suddenly I rejoiced in the great security of the sea  
as compared with the unrest of the land....  
Wrote Conrad.



Winslow Homer

Abstract: Intuition is so often right, but so seldom observed. Reno, Nevada.

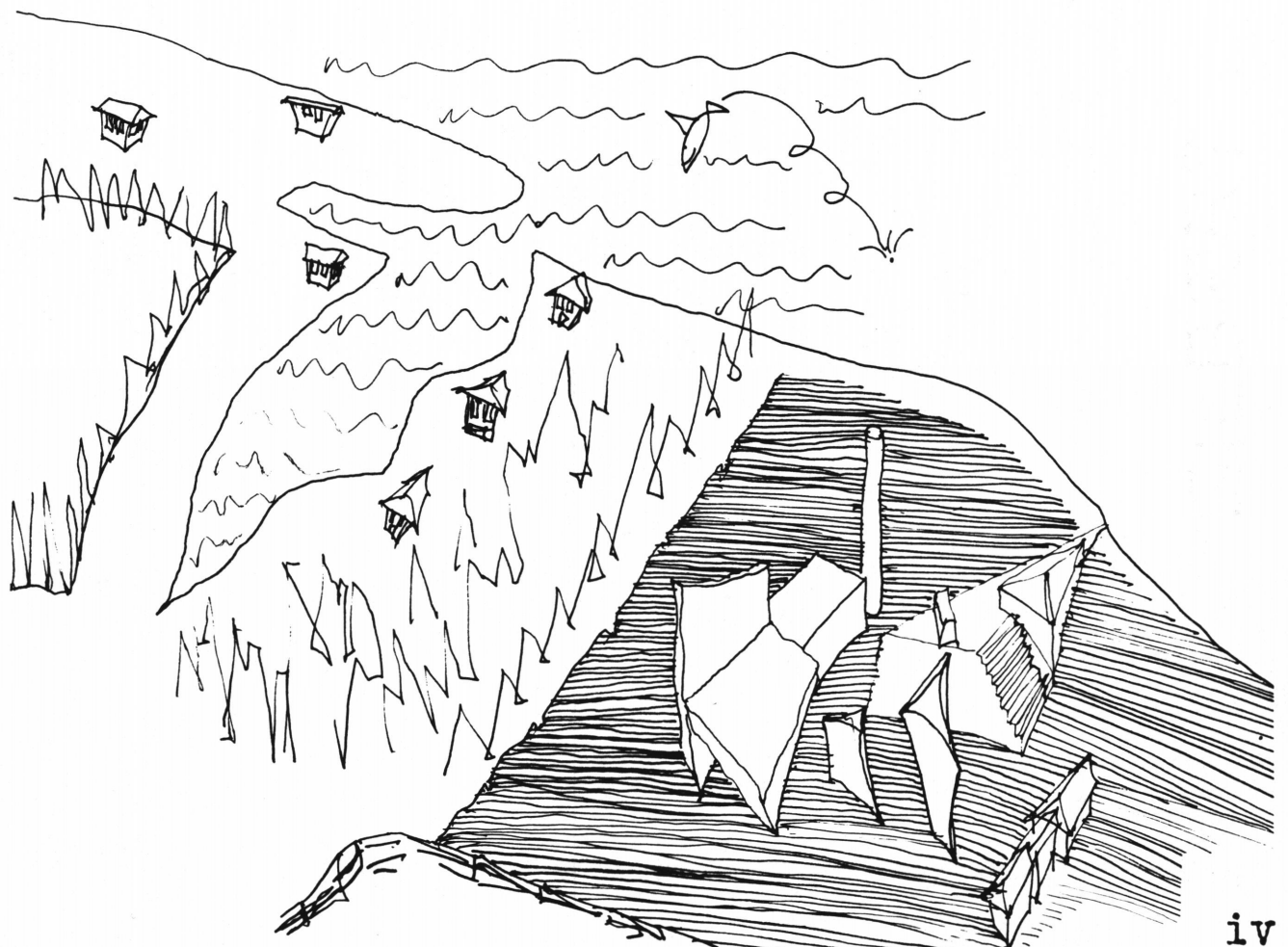
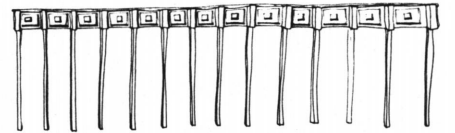
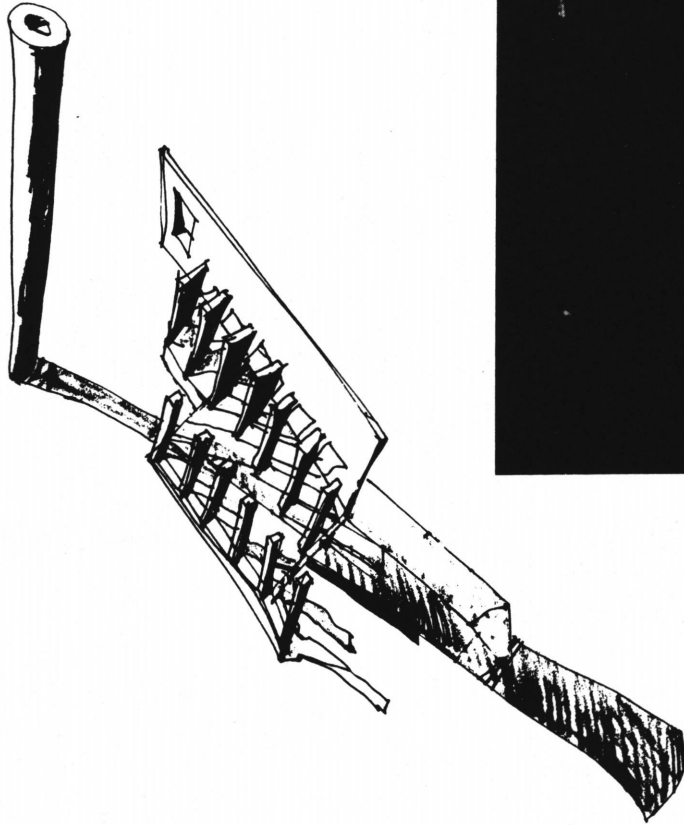
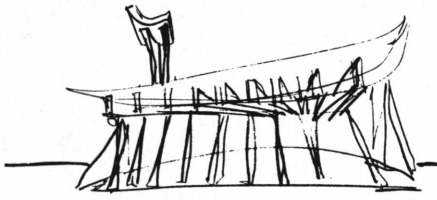
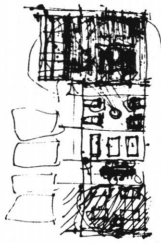

## Contents:

|                                  |     |
|----------------------------------|-----|
| Approved                         | i   |
| Dedication                       | ii  |
| Inspiration                      | iii |
| Abstract                         | iv  |
| Contents                         | v   |
| Site                             | 1   |
| Desire                           | 5   |
| Seaplane house, foundation       | 8   |
| Seaplane house                   | 9   |
| Seaplane house, structure        | 10  |
| Seaplane house, elevation        | 11  |
| Path                             | 12  |
| Lighthouse, day 1                | 13  |
| Lighthouse, day 22               | 14  |
| Lighthouse, day 39               | 15  |
| Lighthouse, day 51               | 16  |
| Lighthouse, day 72               | 17  |
| Lighthouse, subtle discourse     | 18  |
| Lighthouse, plan at 102'-8"      | 19  |
| Lighthouse                       | 20  |
| Lighthouse, threshold            | 21  |
| Lighthouse, door and details     | 22  |
| Lighthouse, roof plan            | 23  |
| Lighthouse, roof elevation       | 24  |
| Wet Northface Teal Winery, day 1 | 25  |
| Vita                             | 26  |

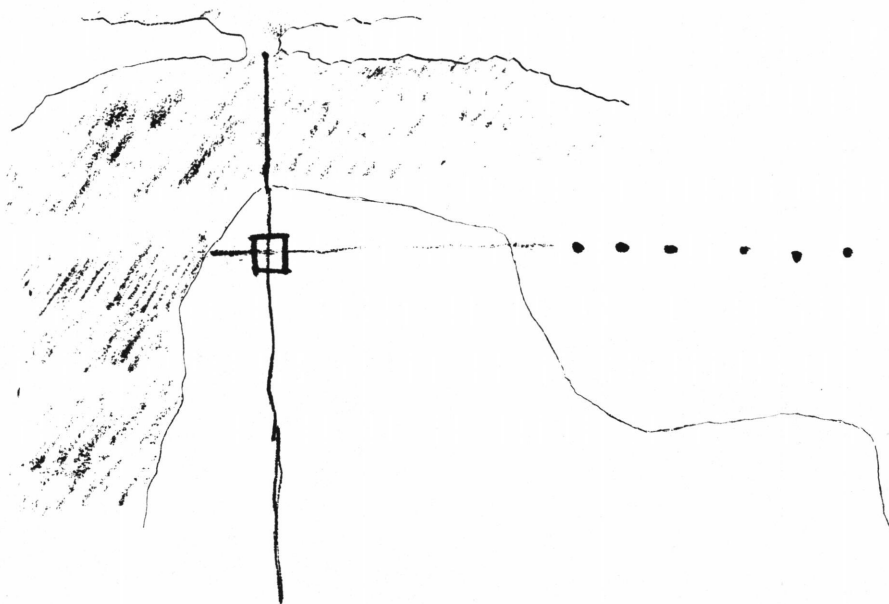

... the reason for living was to get ready  
to stay dead for a long time. Wrote Faulkner.



Eskimos have 27 different words  
for "snow". Origin unknown.



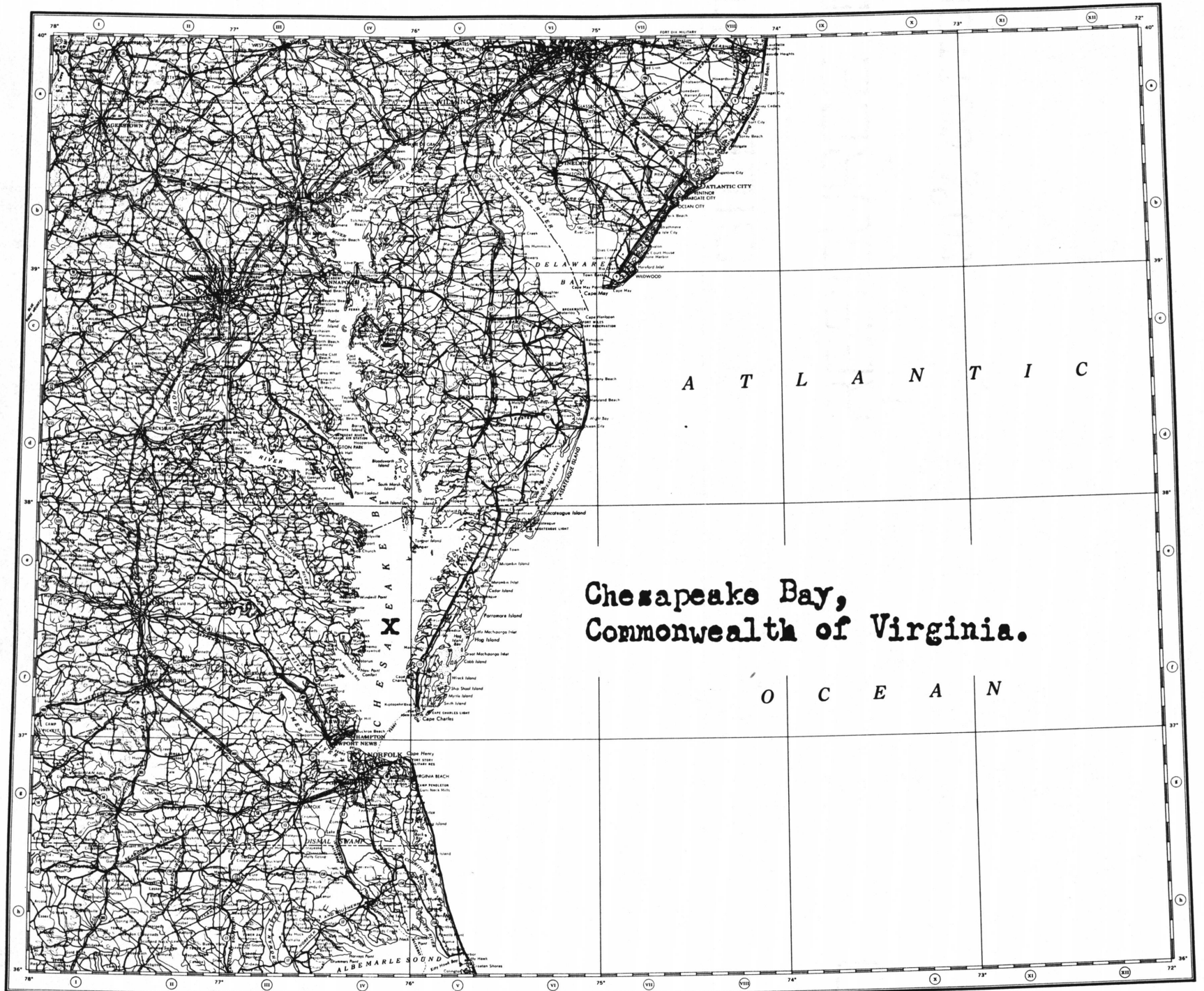

The land was beautiful, and one of the most pleasant in the whole world . . . . Heaven and earth never agreed better to frame a place for man's habitation. . . . Wrote Captain John Smith about the Chesapeake Bay.



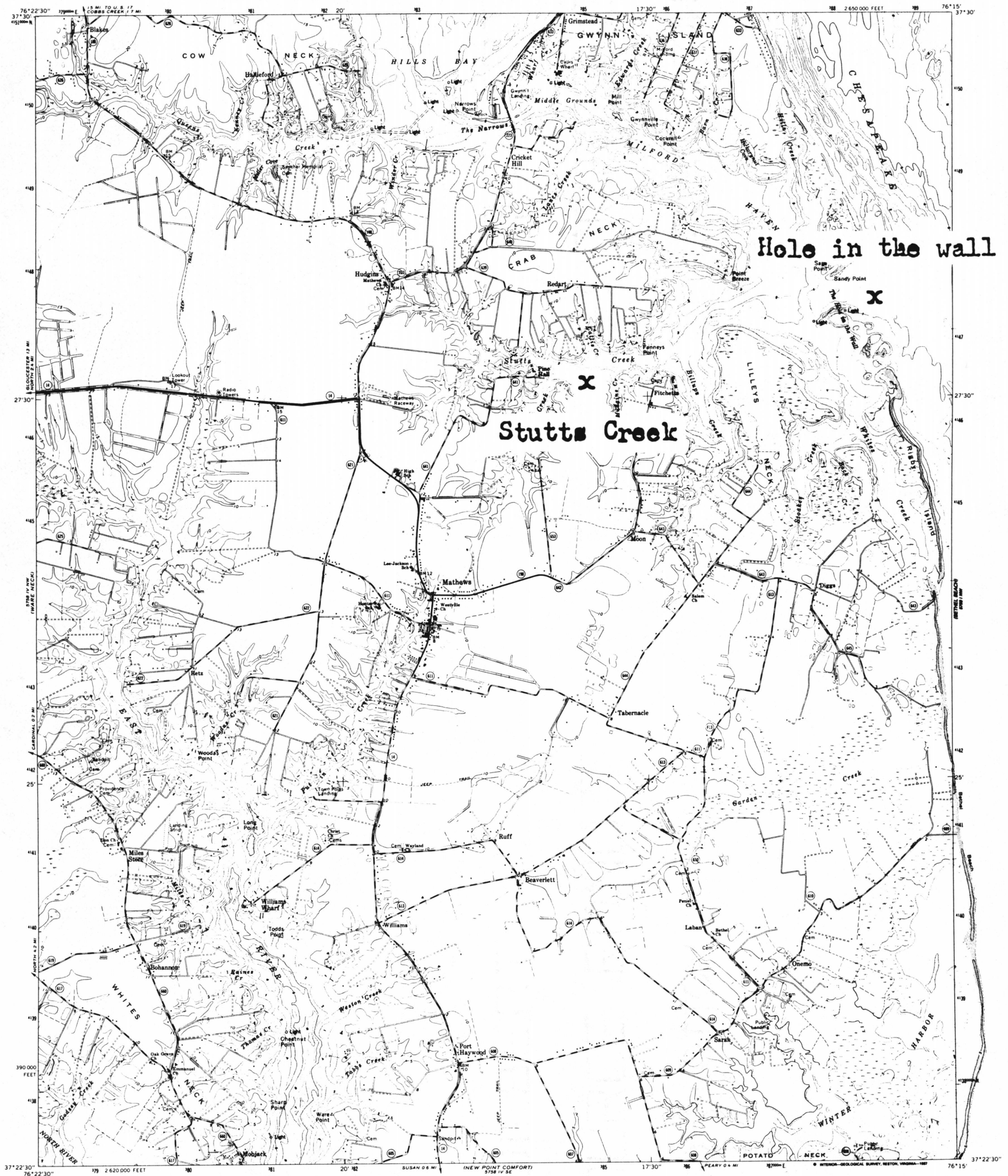

Hole in the wall

Stotts Creek

Commonwealth of Virginia  
Mathews County.

The sea will grant each man new hope; as a sleep, brings dreams.  
Wrote Columbus.

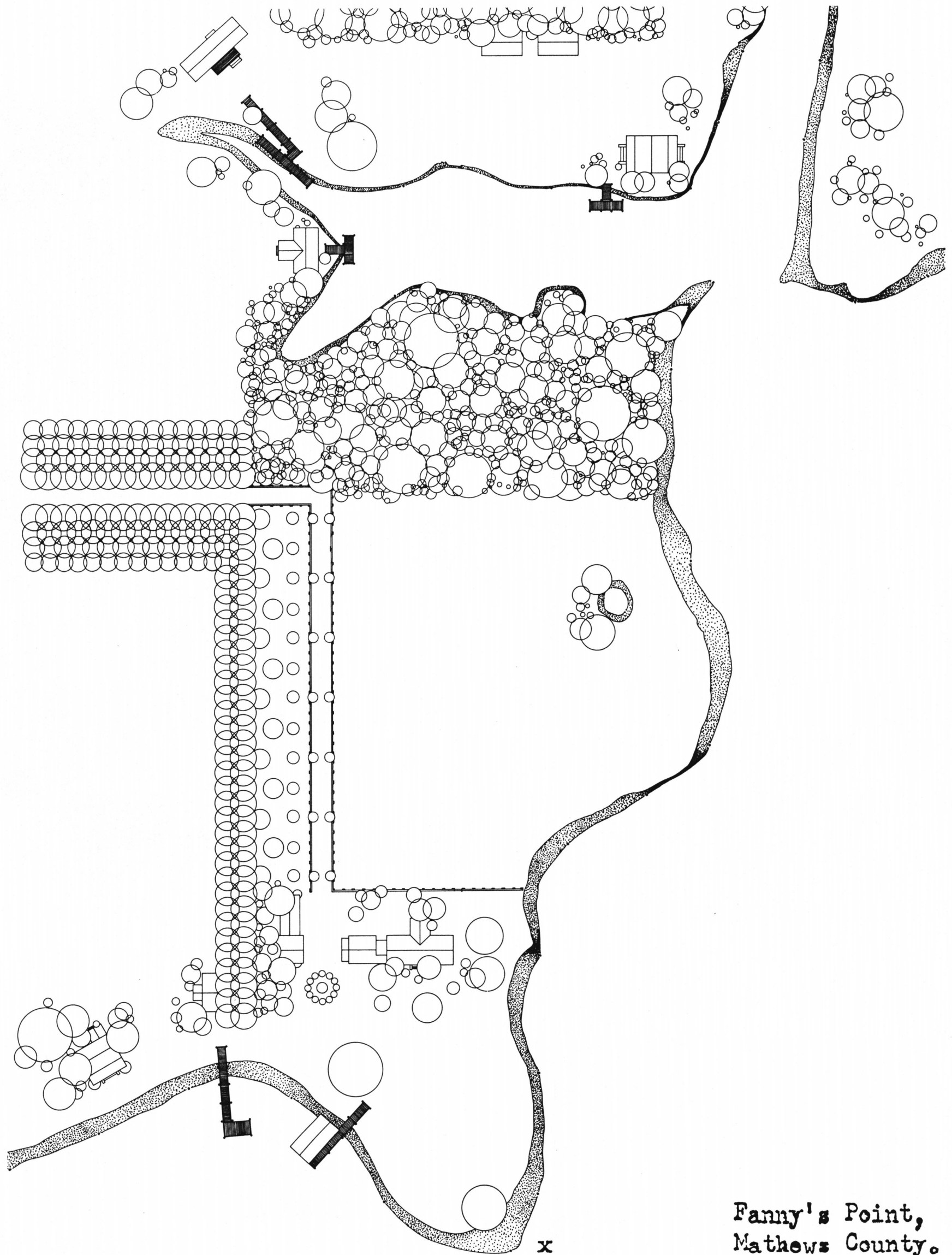

Fanny's Point,  
Mathews County.

All words are only words. Words we remember  
become religion. Newport, Virginia.

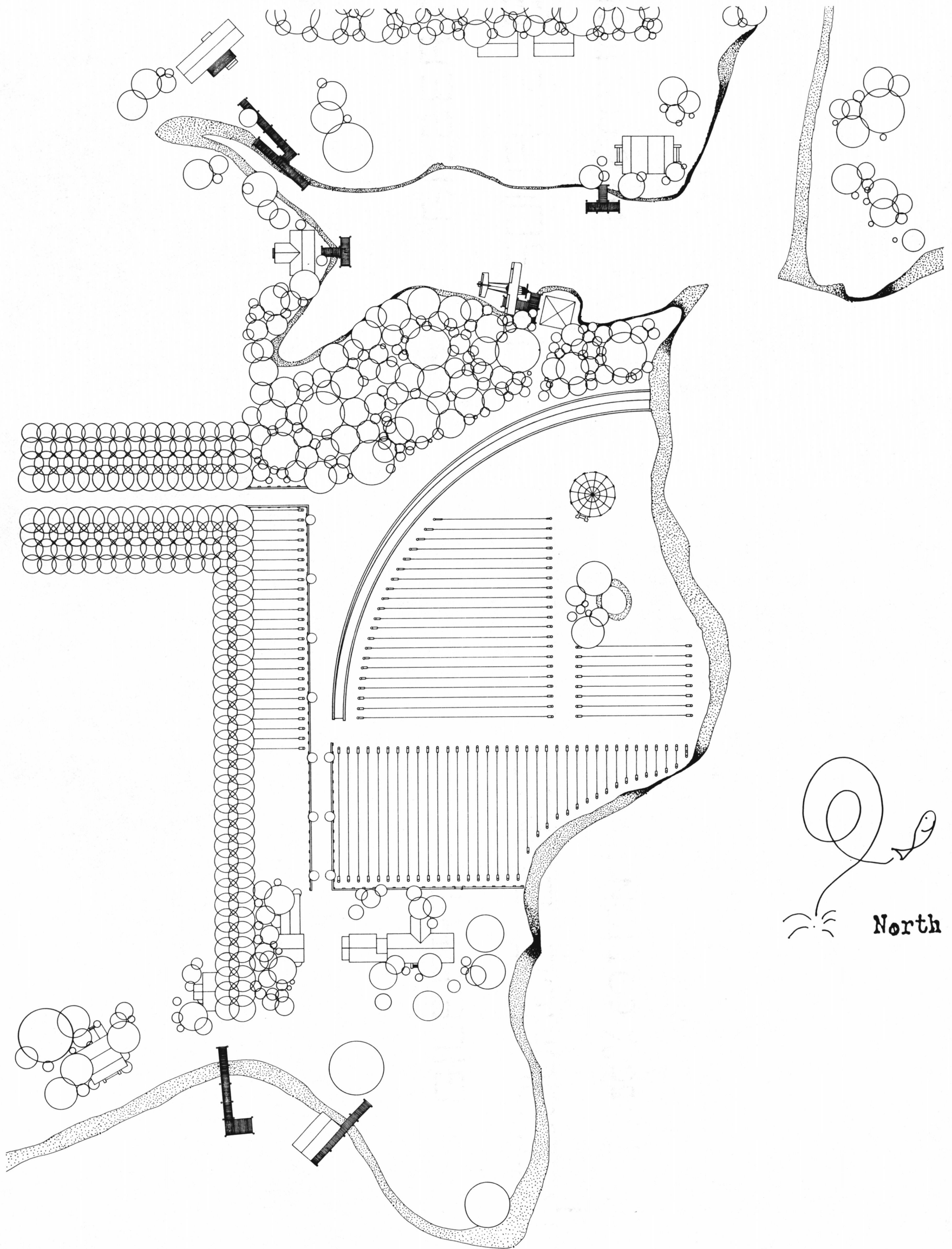

You cannot teach people, but you can offer milkweed friesssee and invite them for dinner. Said Garnett.



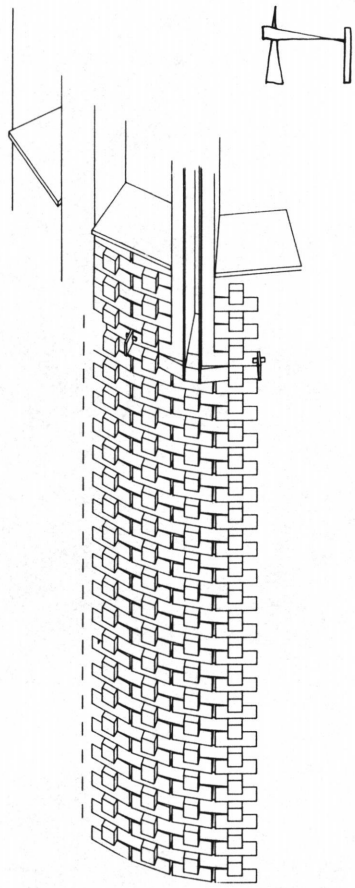

Art is an abstraction. Draw it out of nature, dream about it, and think more of the resulting creation. the only way to reach God is to fellow the divine master's example and Create. Wrote Gauguin.

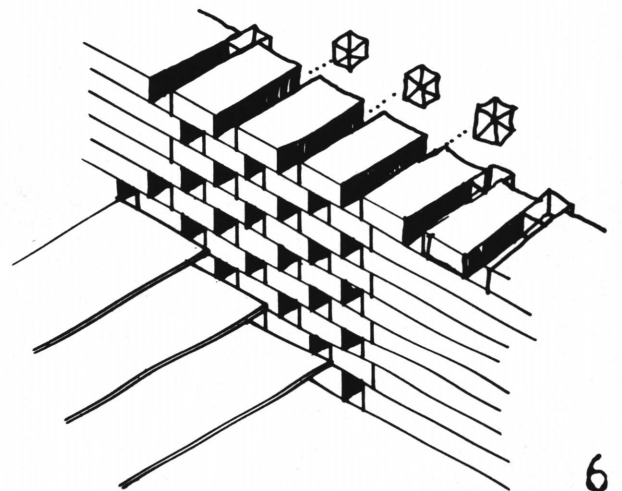
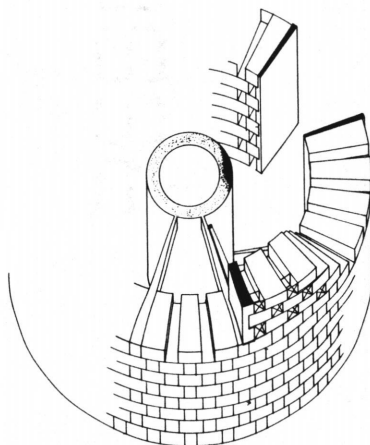
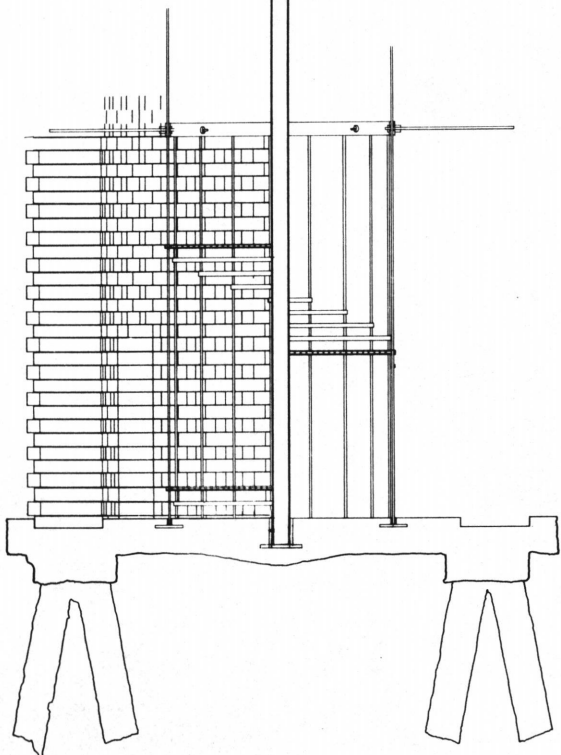
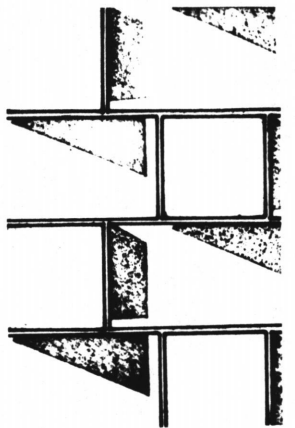
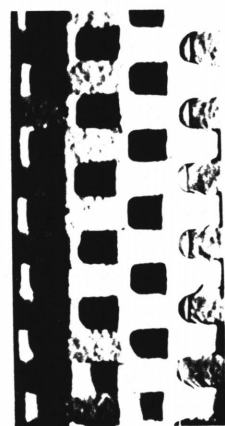
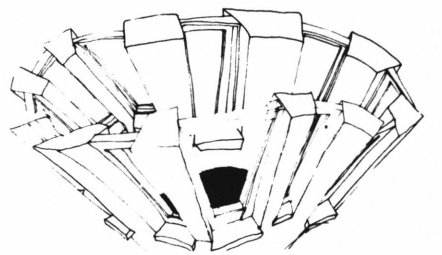
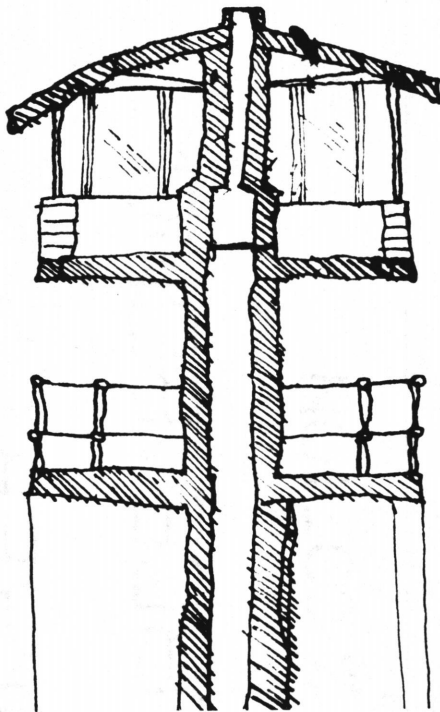
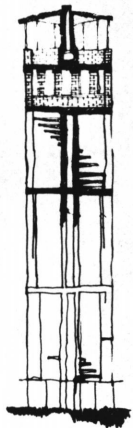
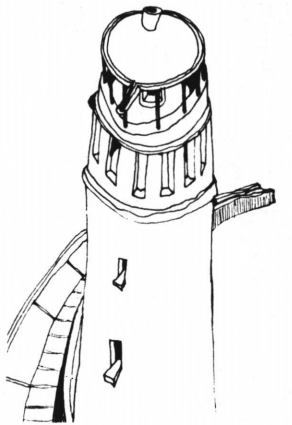
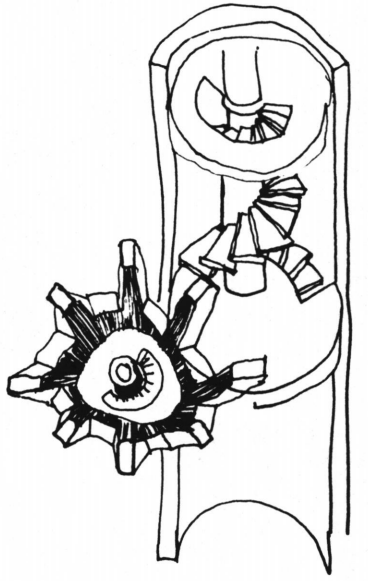
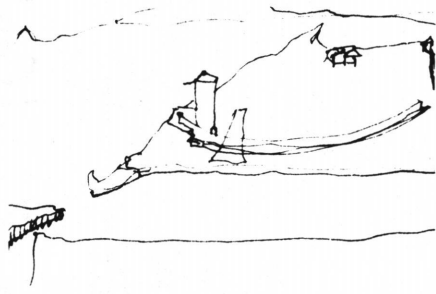
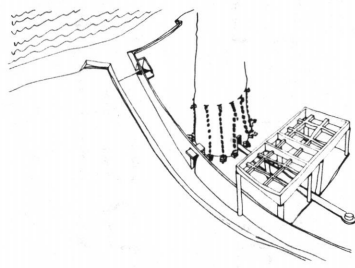

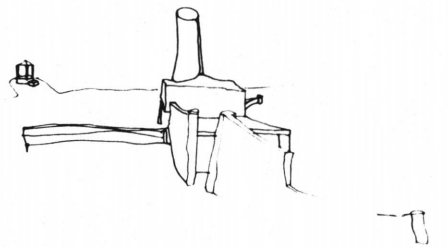
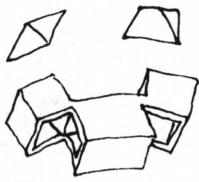
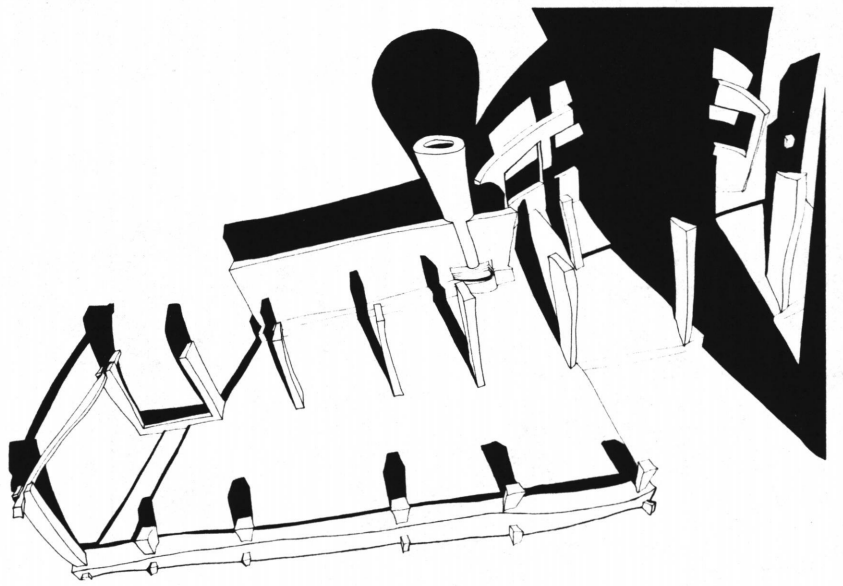
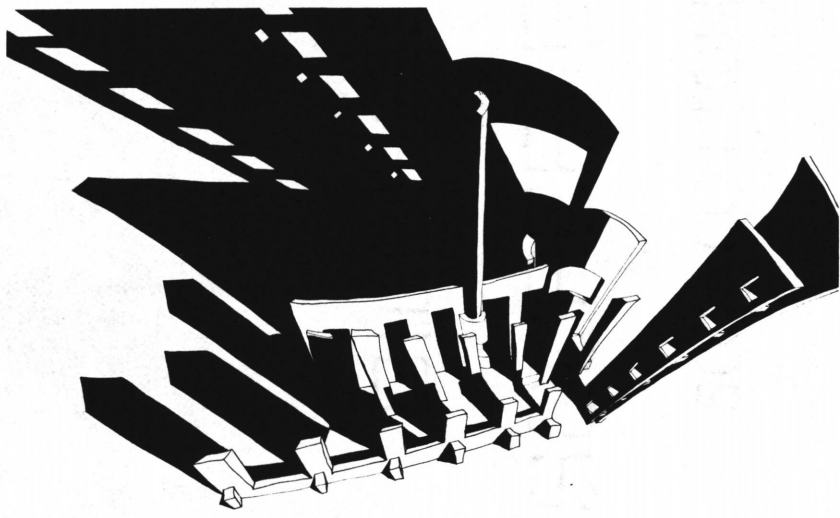

If they lie to you once; they will keep lying as long as you let them get away with it. Said Benny the barber.

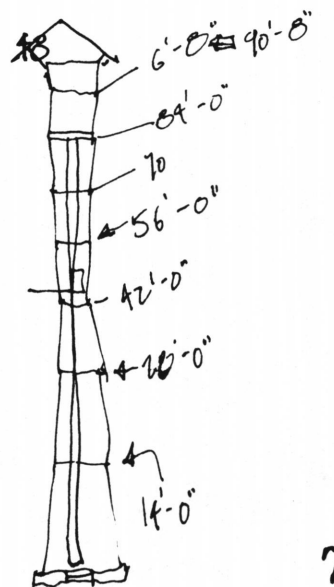
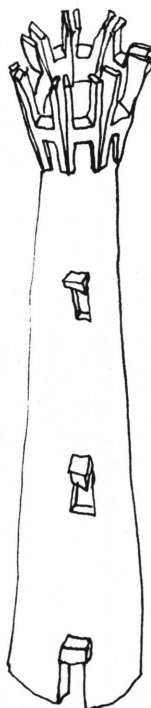
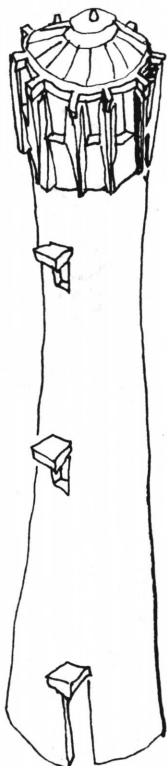
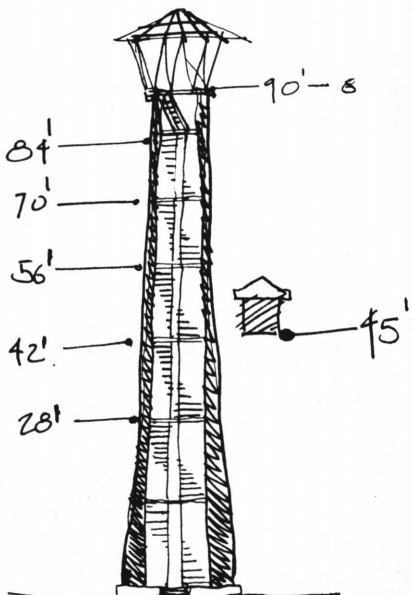

You know what to do. Said Glen.  
No, I don't. I said.  
Yes you do. He said.  
No, I really do not know what to  
do. I emphasized.  
Yes you do. He said.  
Listen Glen, I don't know what  
to do, so drop it. I shouted.  
Yes you do, In your heart you  
know what to do. He said.

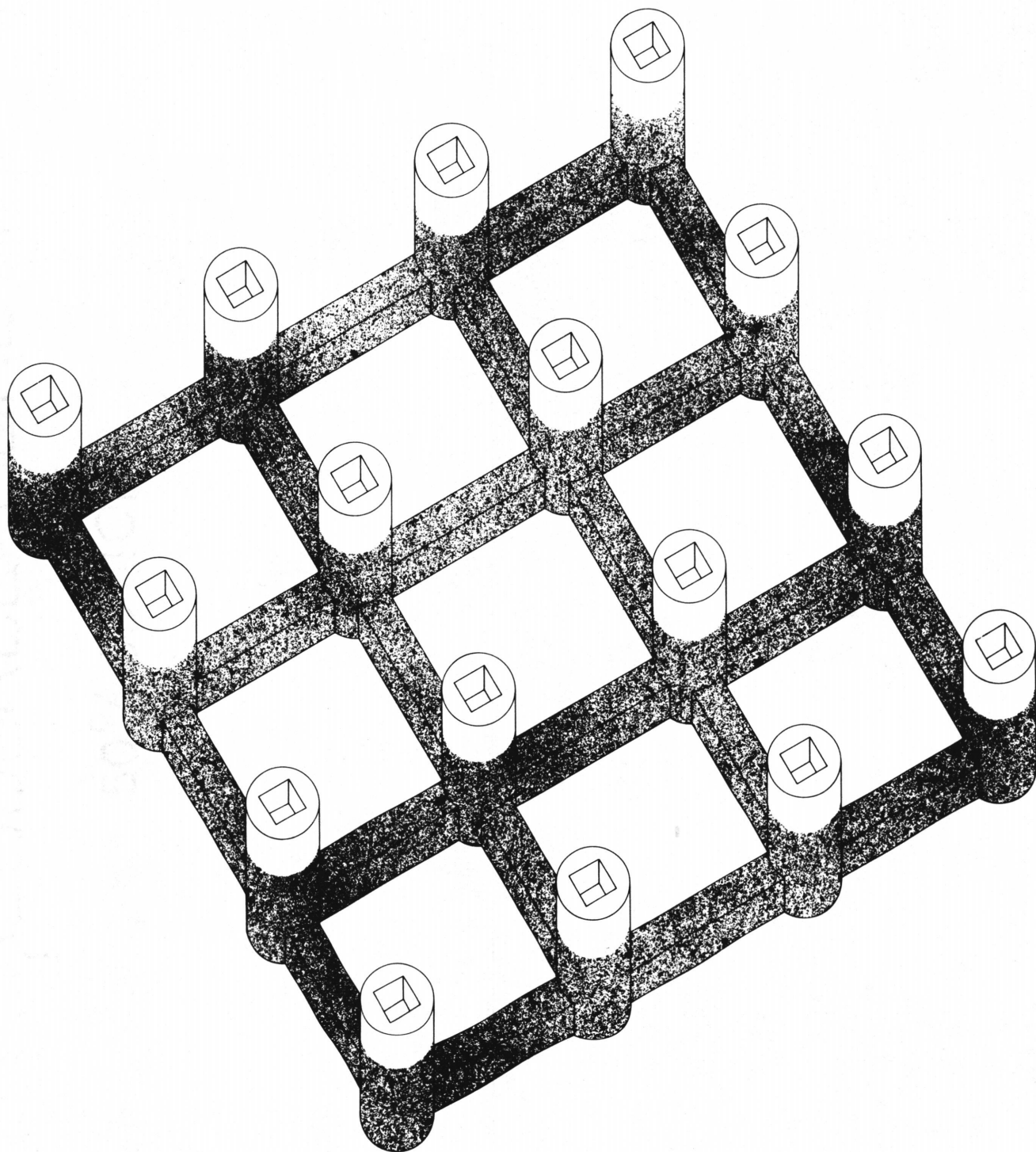



I recall the same wander lust in  
understanding completely a thing,  
as in exploring an unlimited land.  
Dutch Harbor, Alaska.

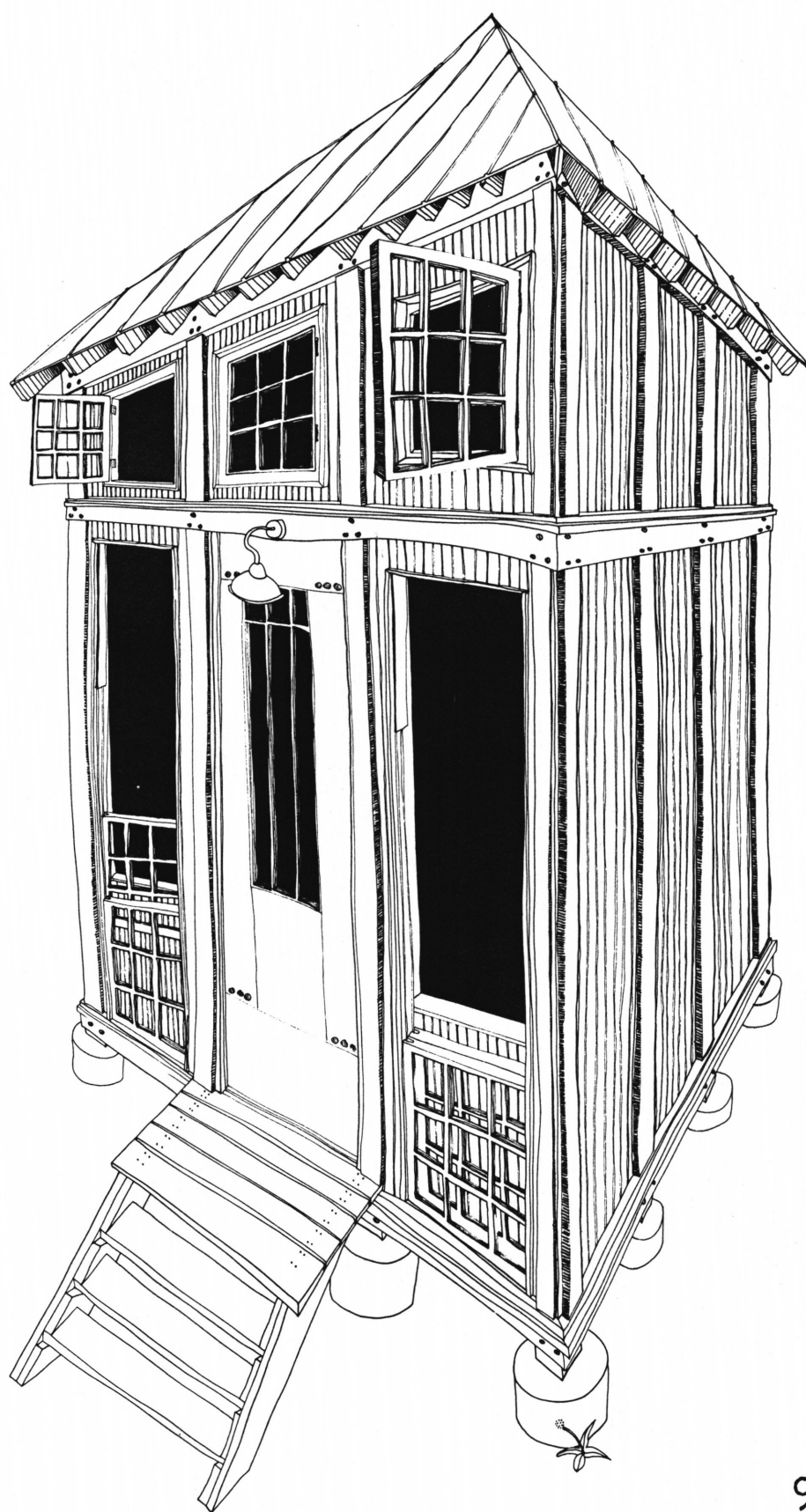

An honest man's pillow is his peace  
of mind. Spoke Mellencamp.

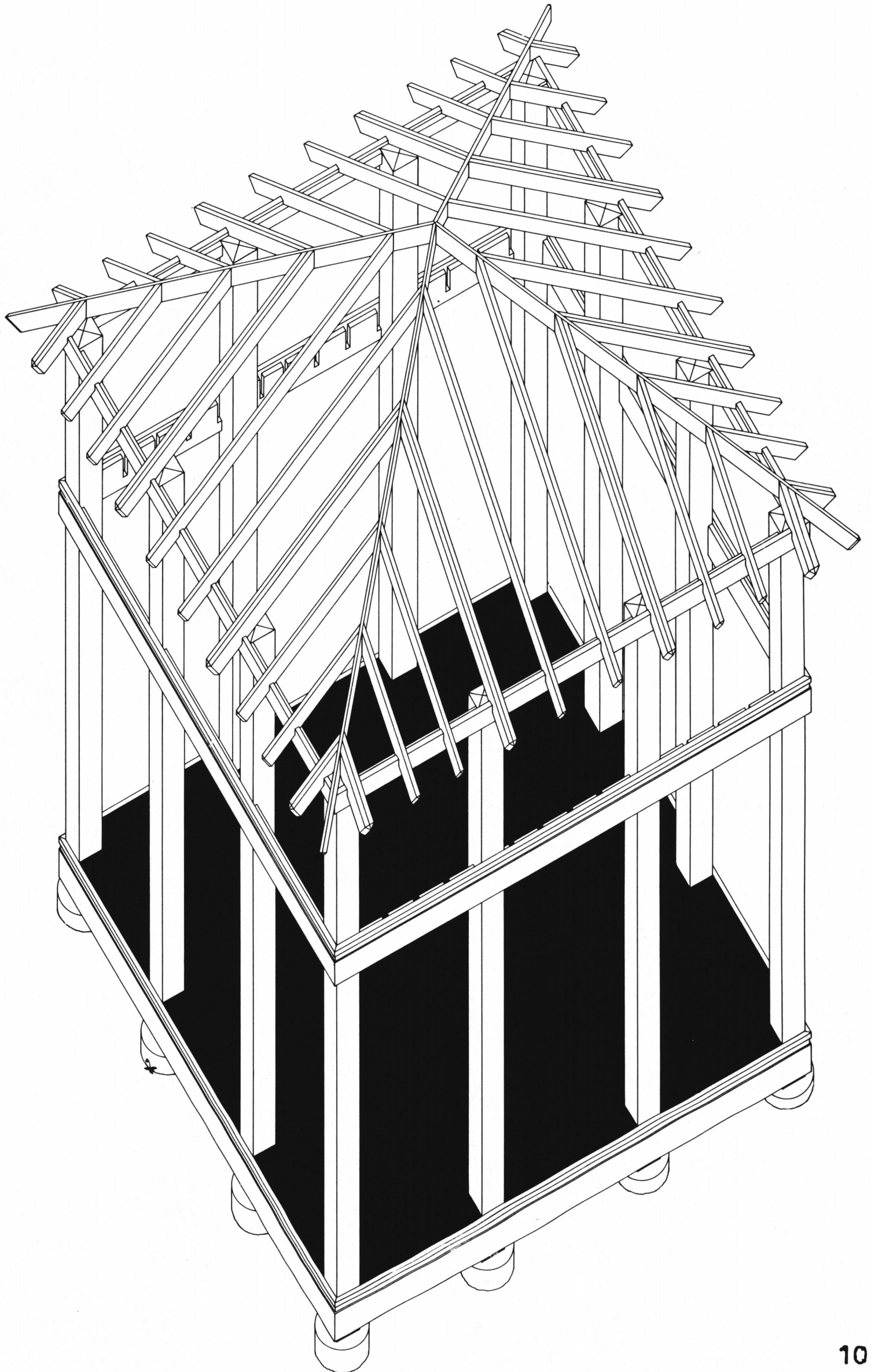

Architecture is said to be a true mirror of the life and social behavior of a period. Wrote Gropius.

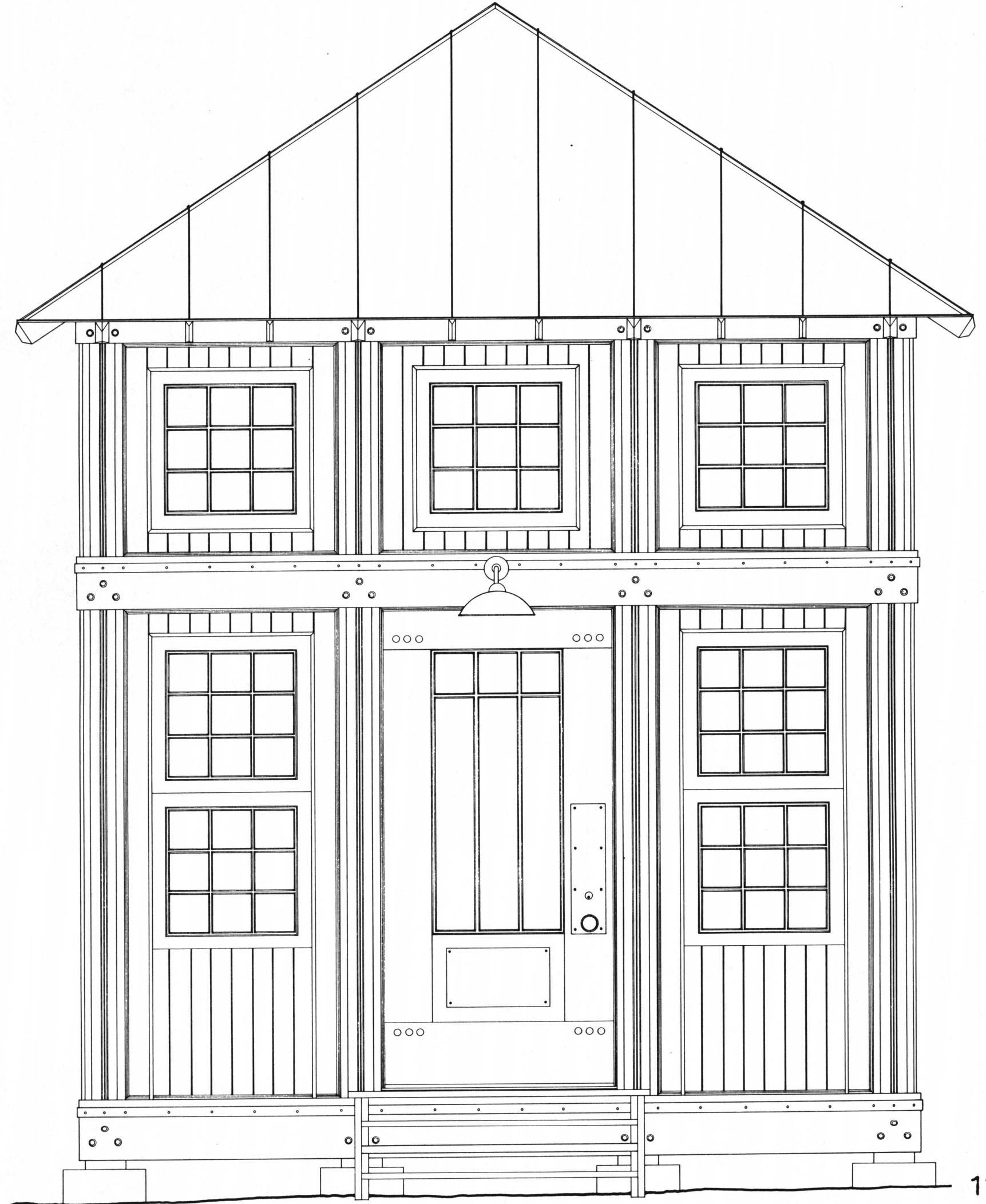



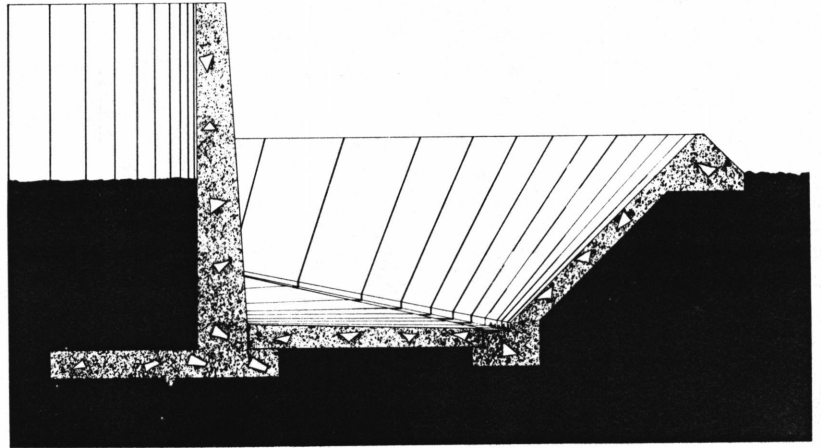
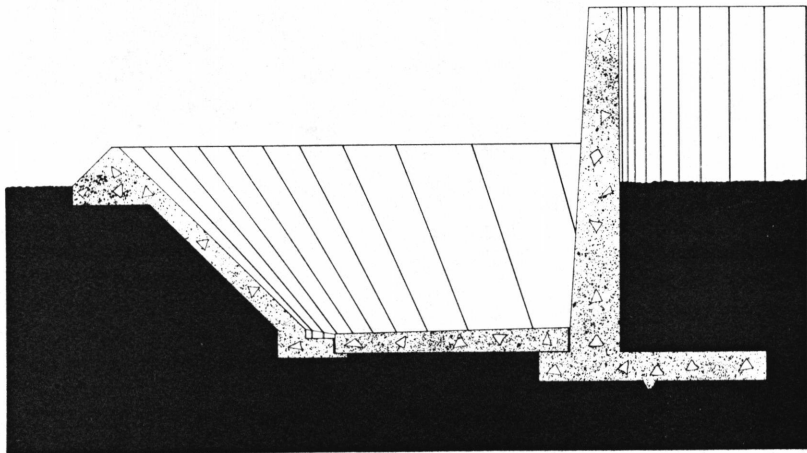
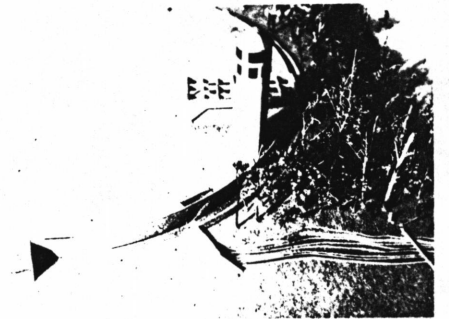
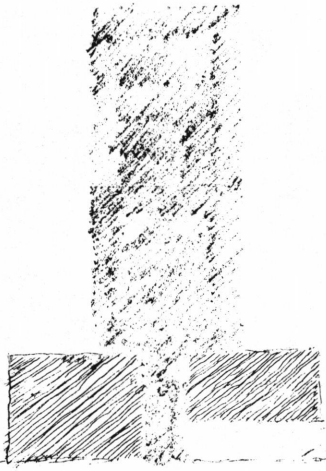
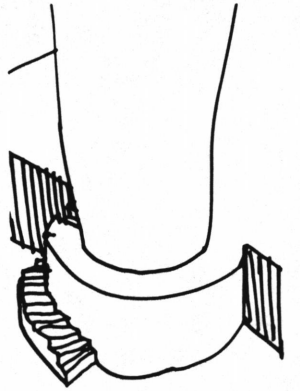
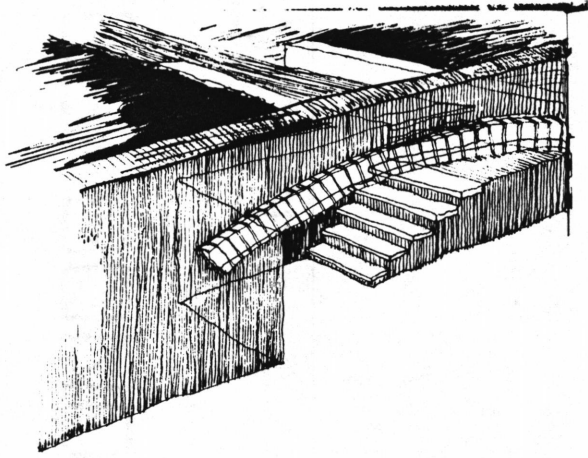
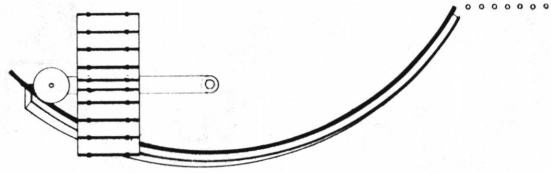
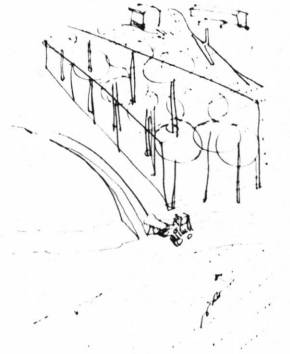
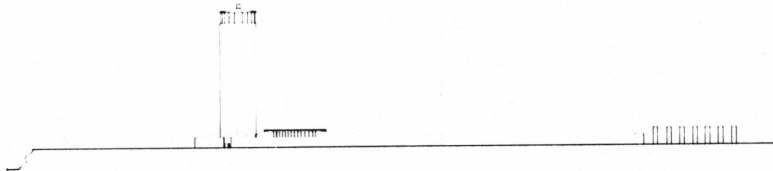
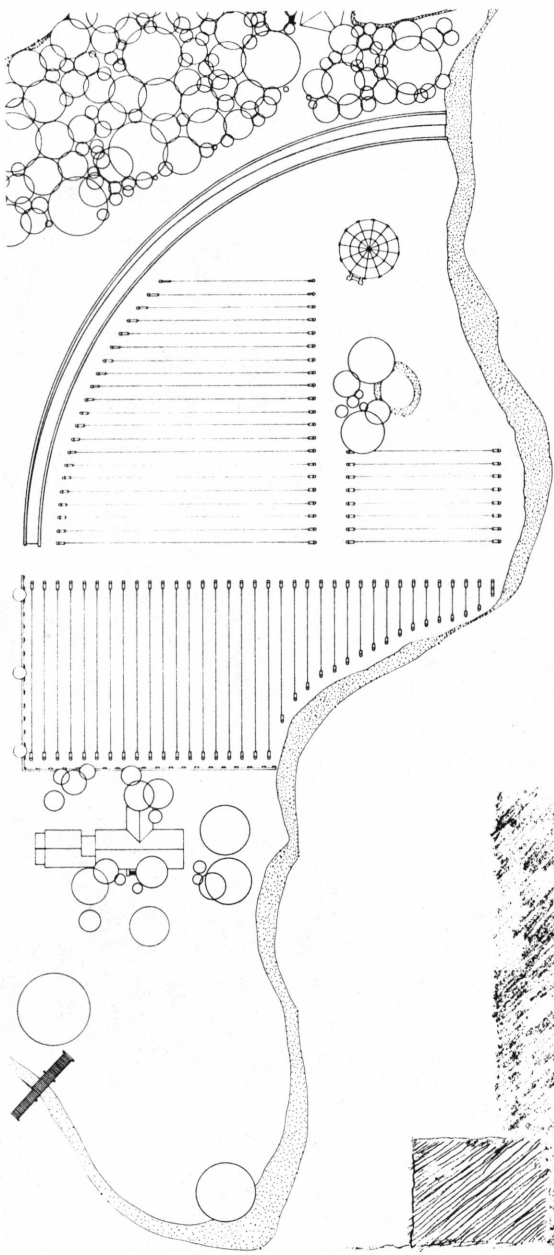

He walks around. His shadow walks around.  
Wrote Faulkner.

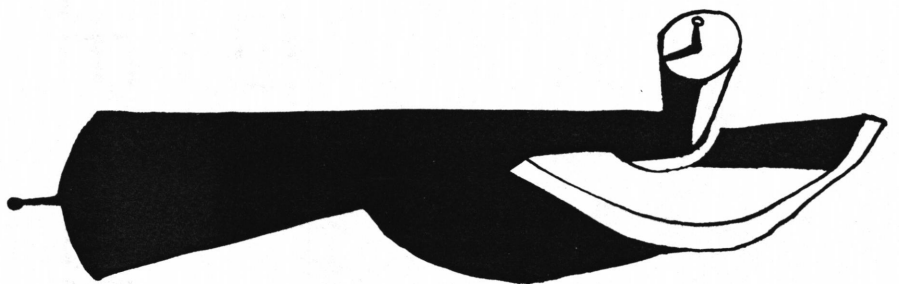

... friends waste time on each other. Wrote Kirsten.

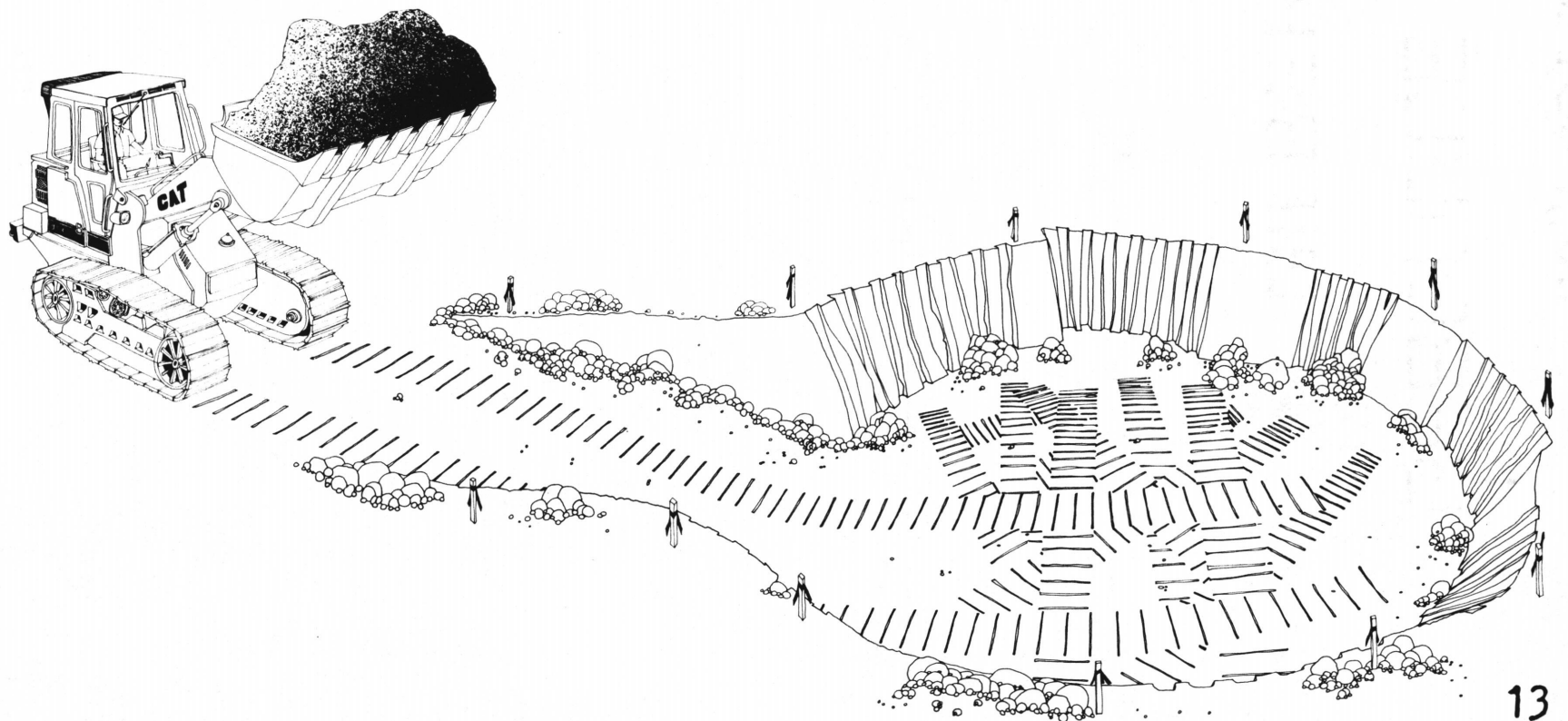

I don't know about this architecture stuff,  
I have talked to alot of people about how  
hard it is. How competative it is, how hard  
you have to work, how hard it is to get a  
job.... Said my father. Relax Buddy, Leonard  
will make it if that is what he wants.  
Said Papa Simpson, in the fall of 1984.

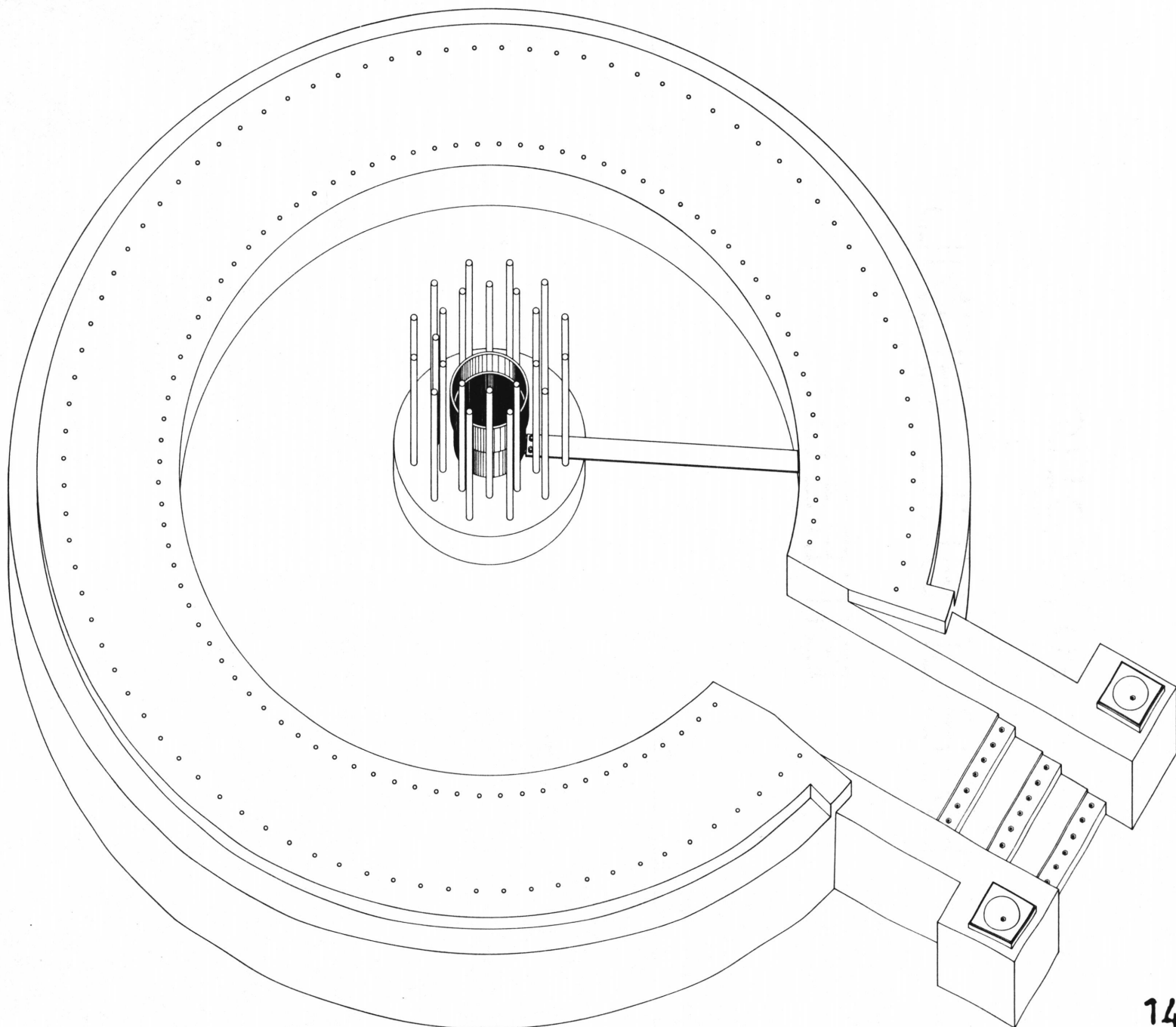



One factor in the choice of architecture  
as a profession must surely be a willing-  
ness to commit oneself in stone. Wrote Arnheim.

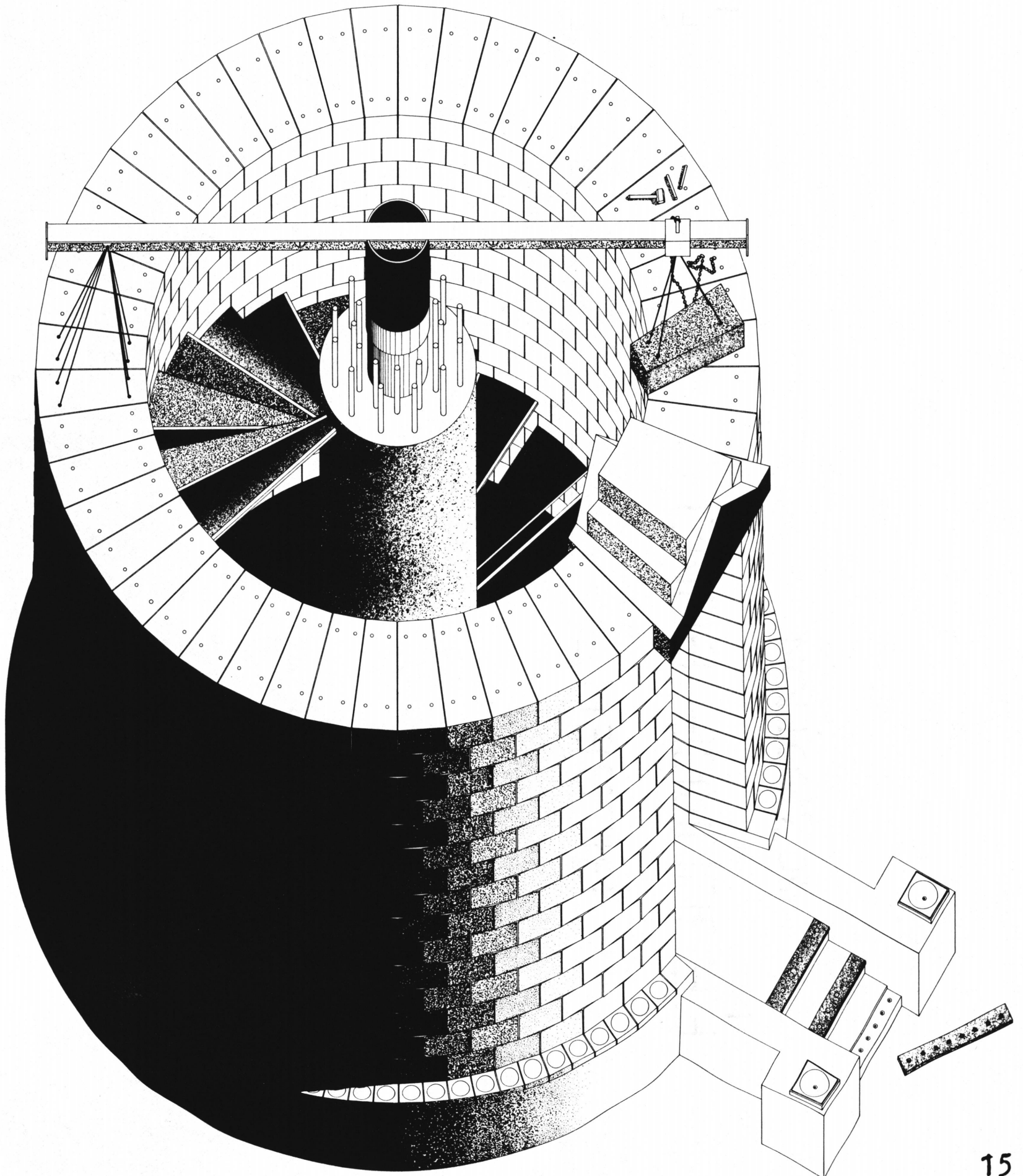
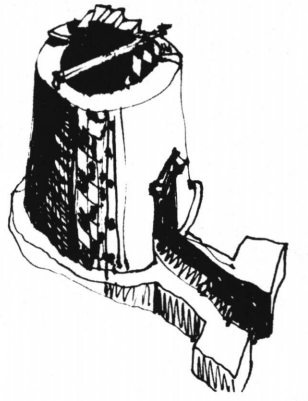

Do what you think,  
but don't limit it  
by what you know.  
Said Egger.

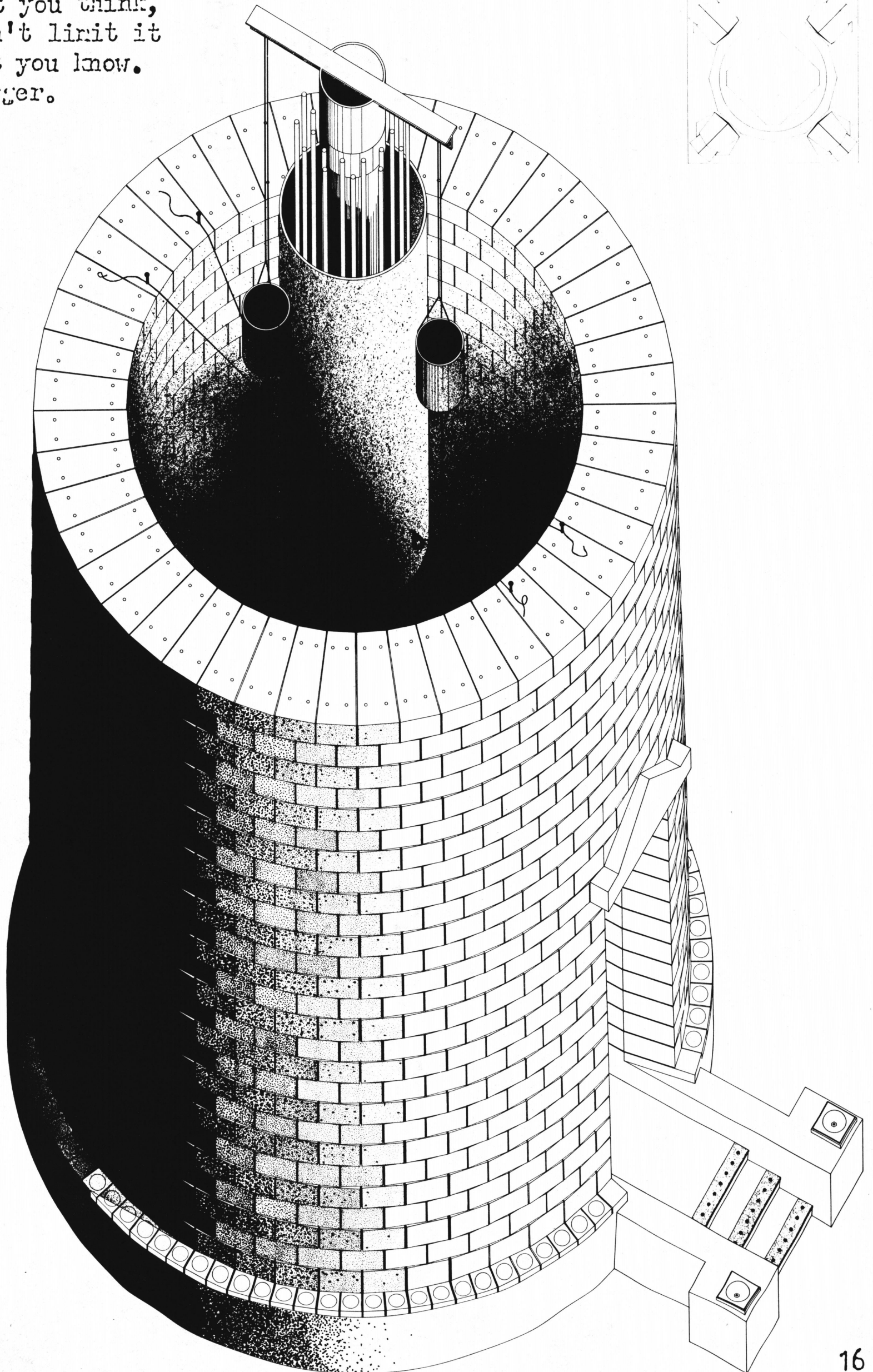



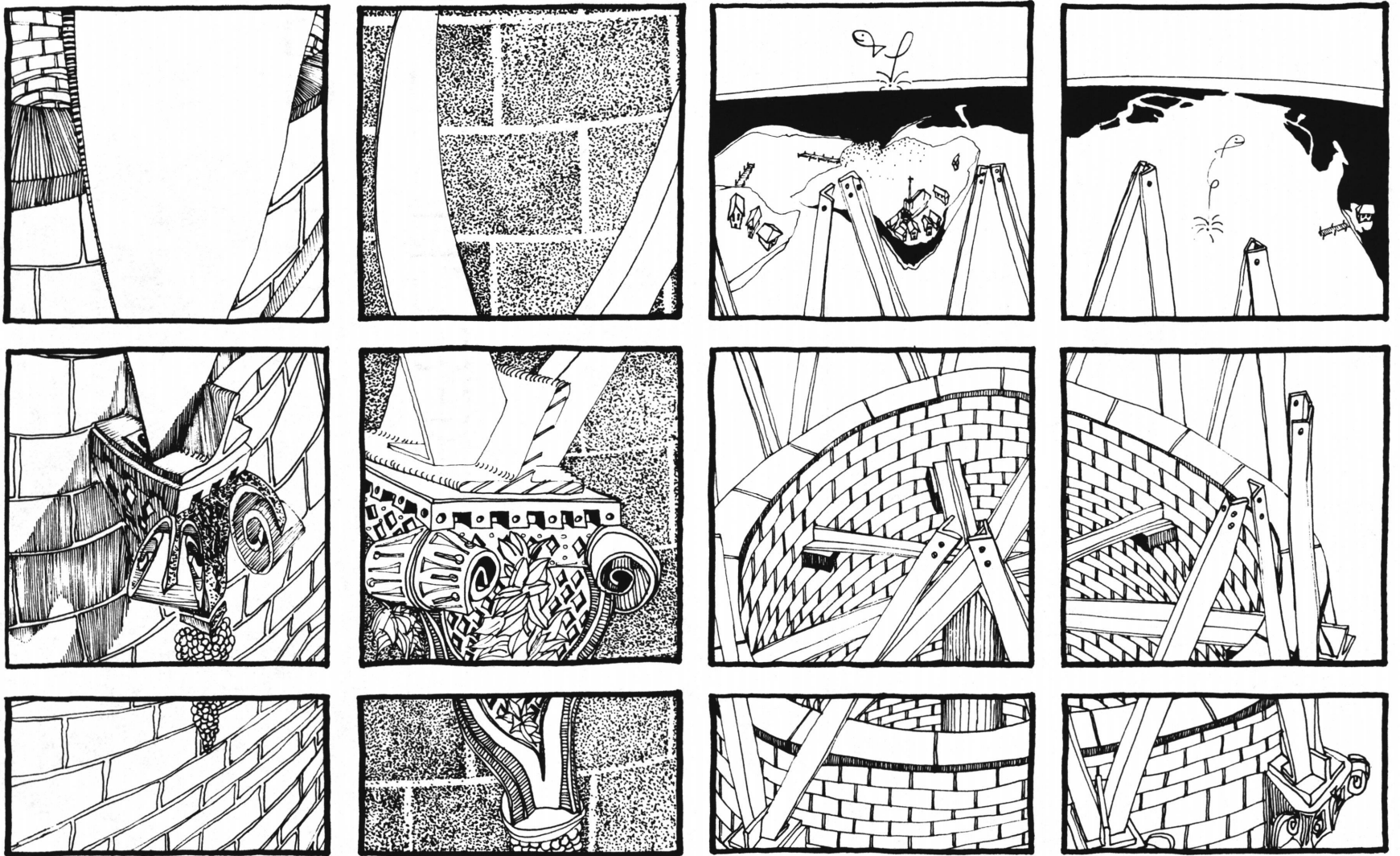

A parallel bar is often used to force an incomplete sketch. This is not possible. Santa Cruz, California.

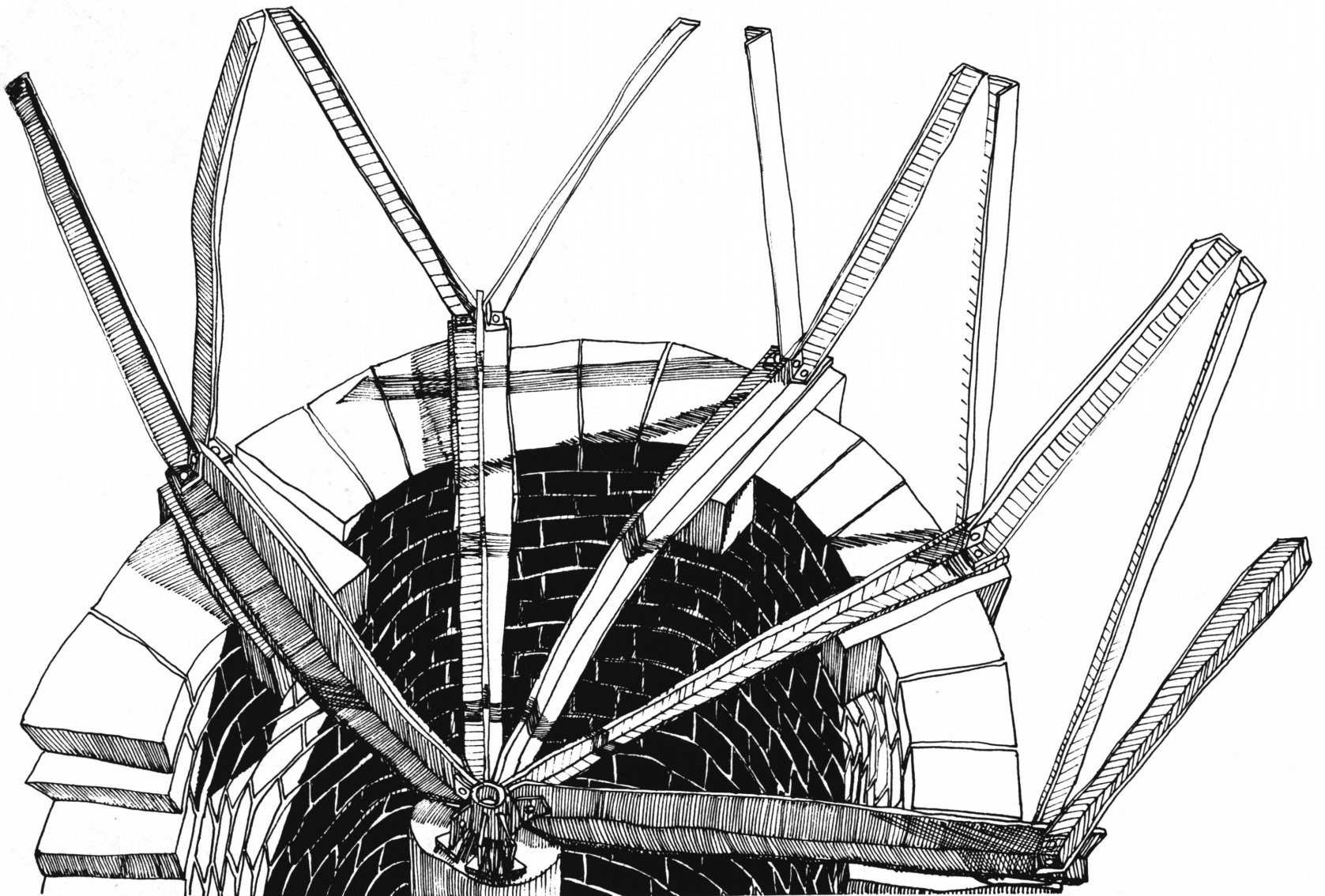

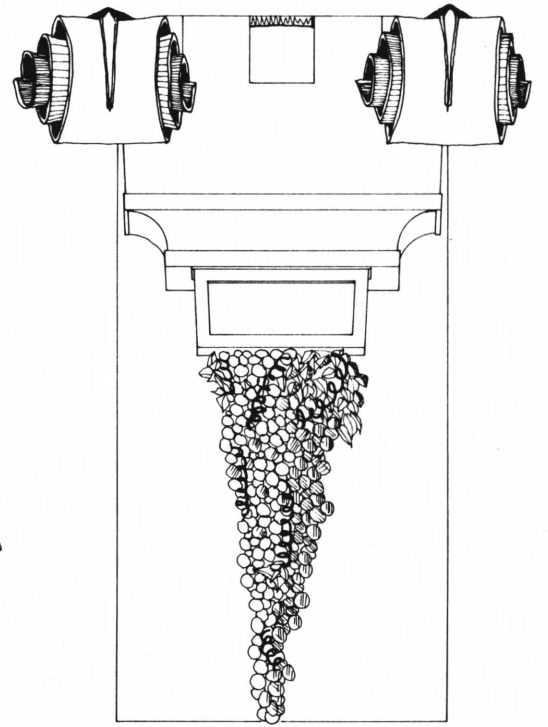
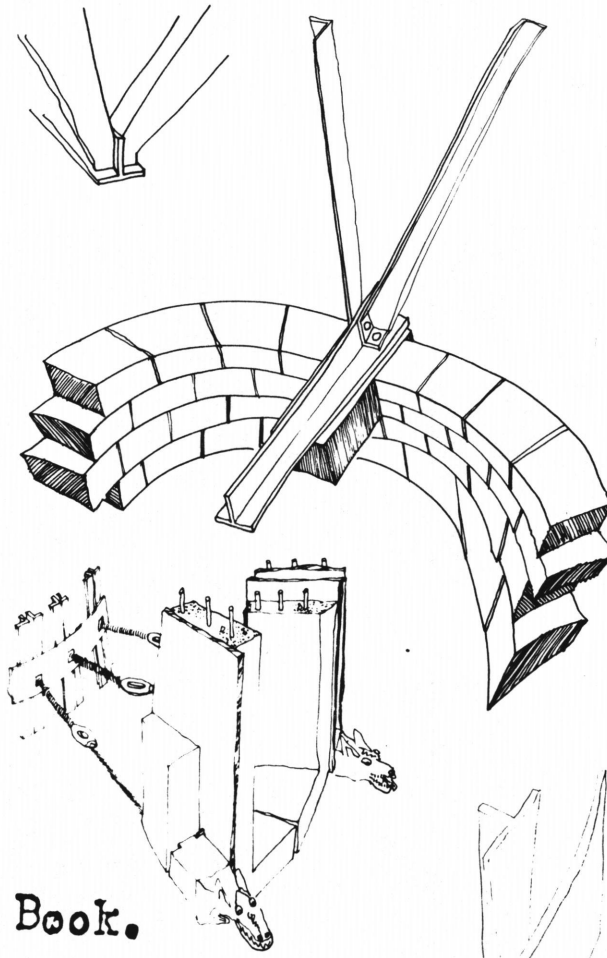
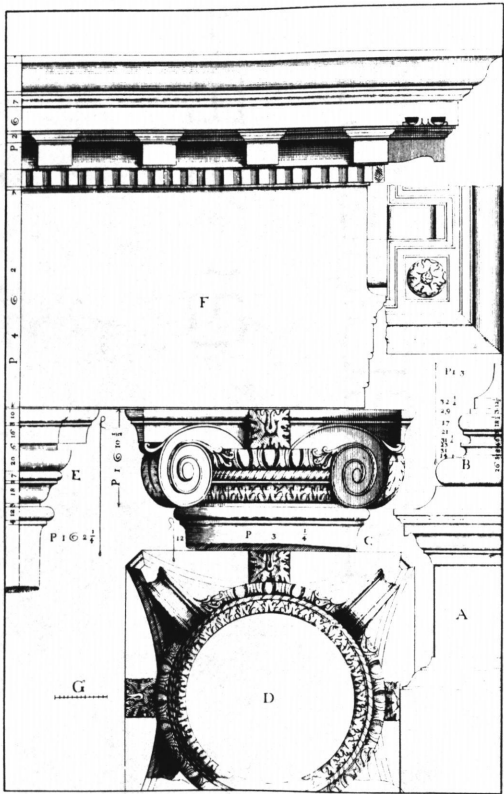

Andrea Palladio, Fourth Book.  
Chapter XXIX; XCIV.

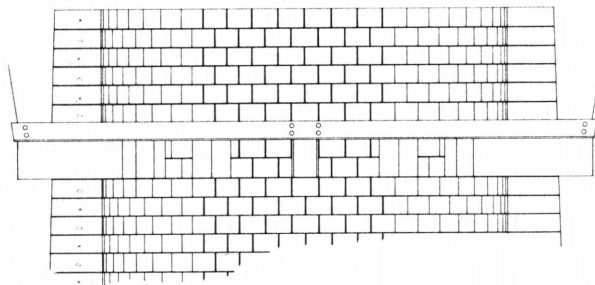
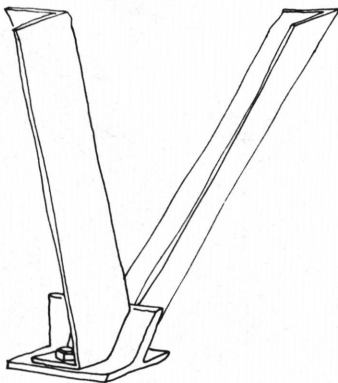

I think it best not to know everything  
about something you do. First, the doing  
remains a good experience; and second,  
you appear more honest. Delle, Utah.

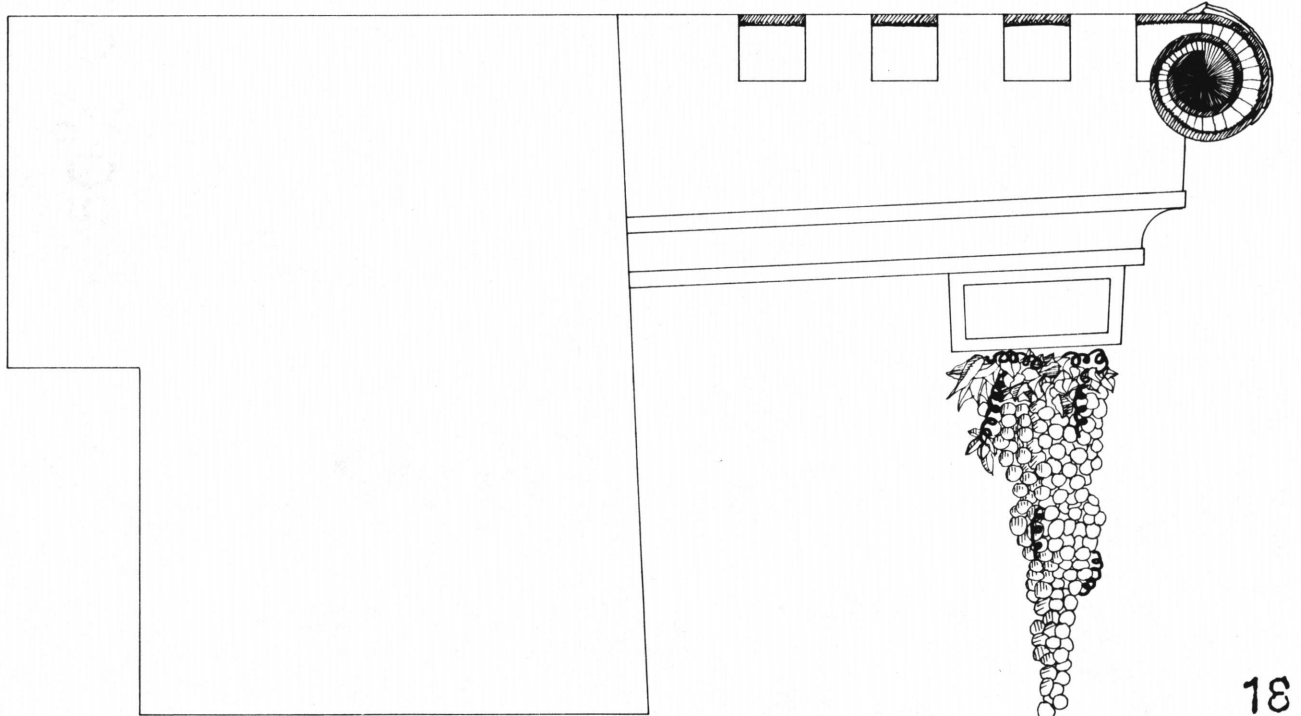
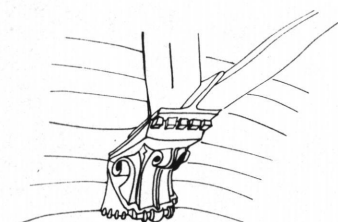
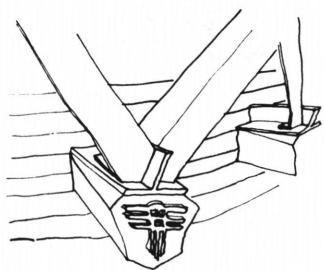
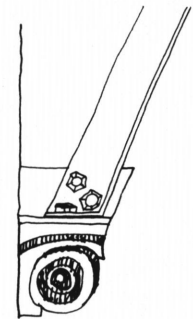
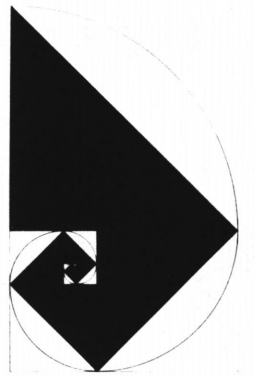



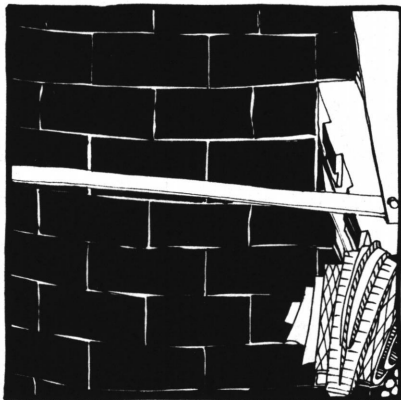
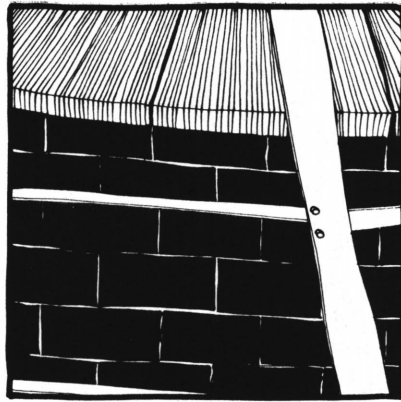

A man has got to know his limitations.  
Said Clint.

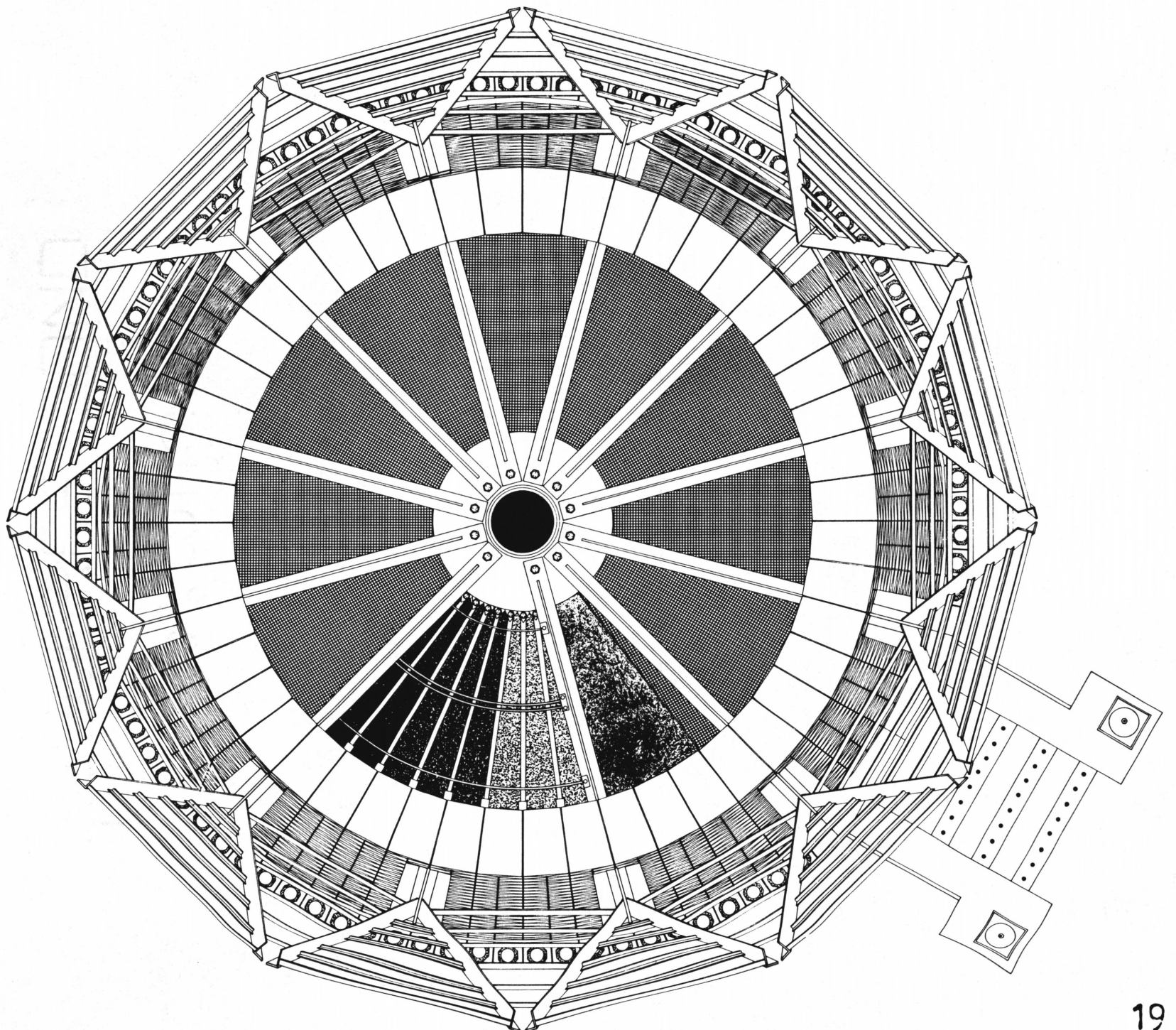

But after all it is what we  
have done that makes us what  
we are. Spoke Croce.

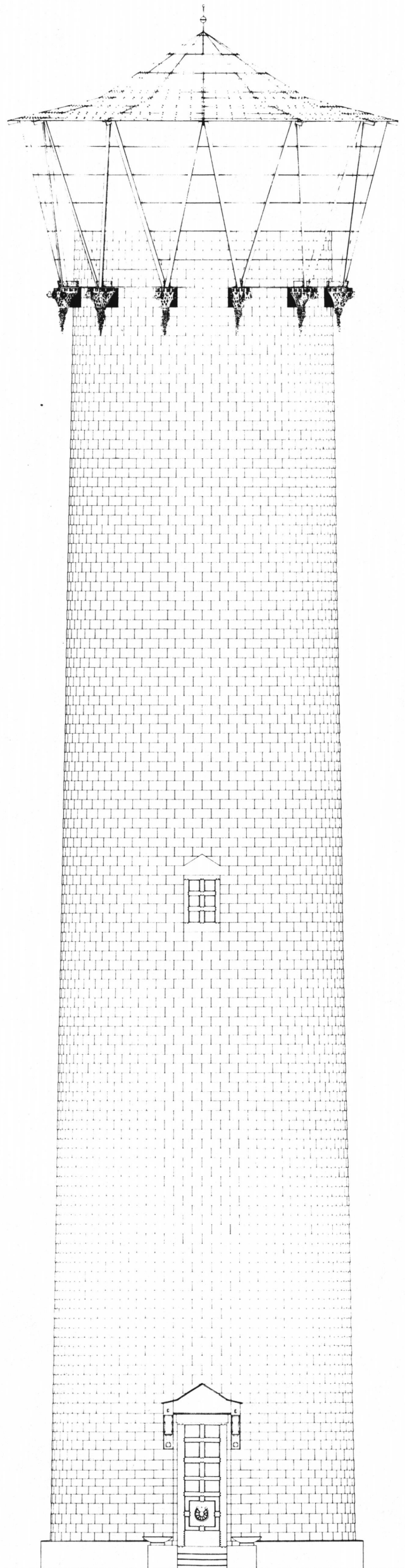

↑  
:  
:



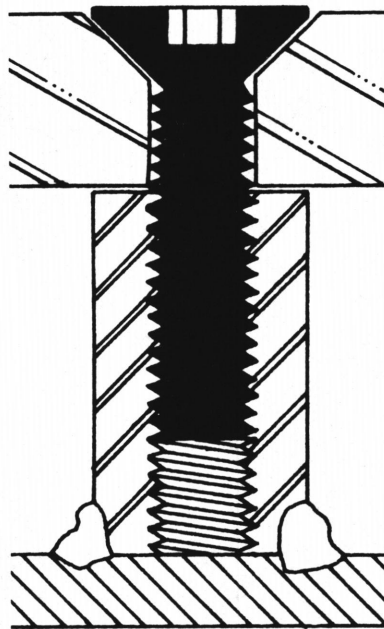
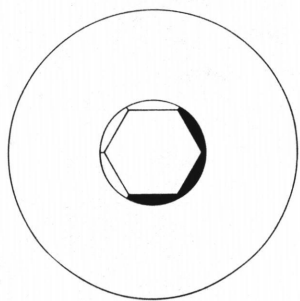
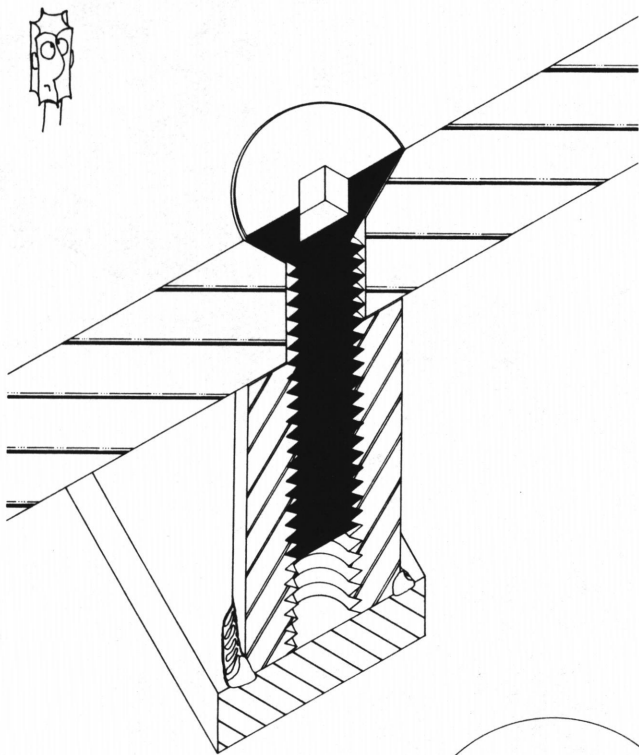
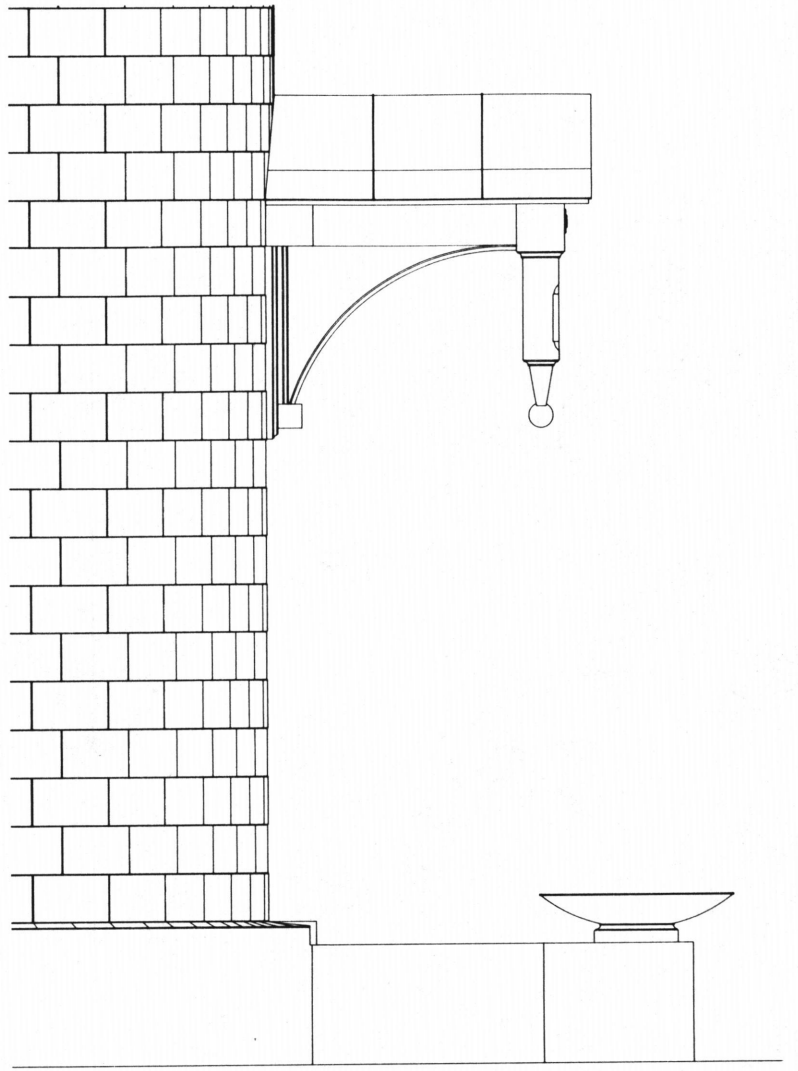
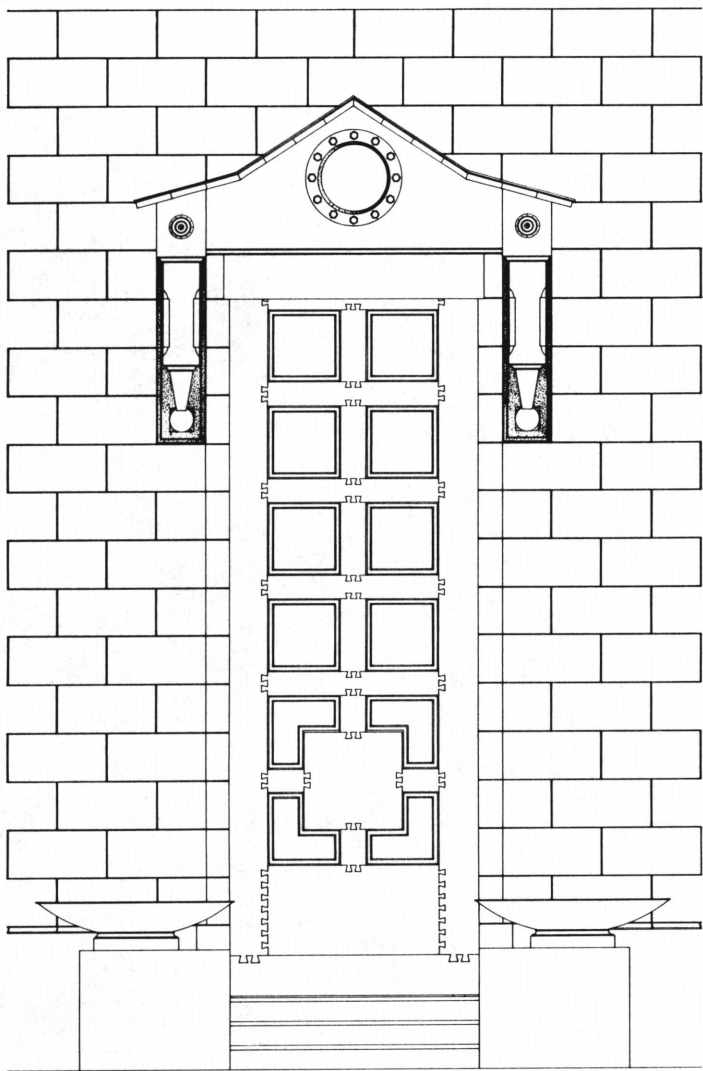

Maybe if you can't change the world,  
 you should just change yourself.  
 Spoke Petty.

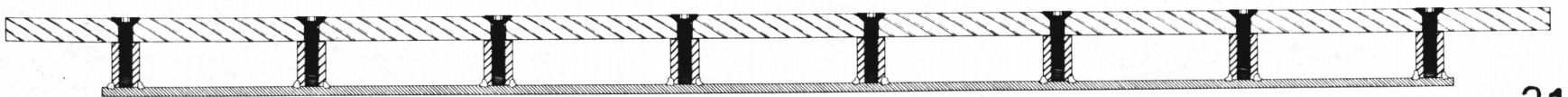

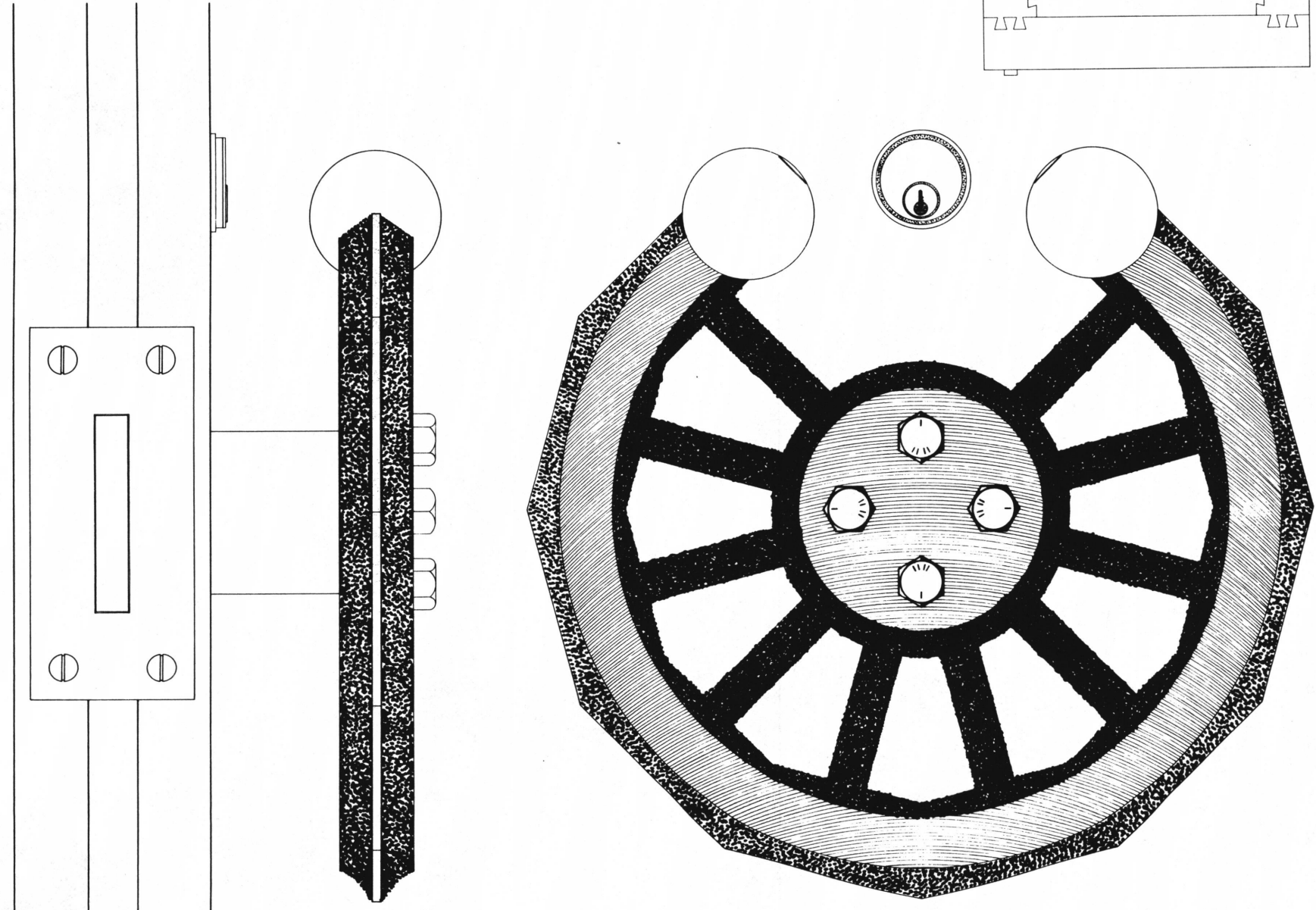
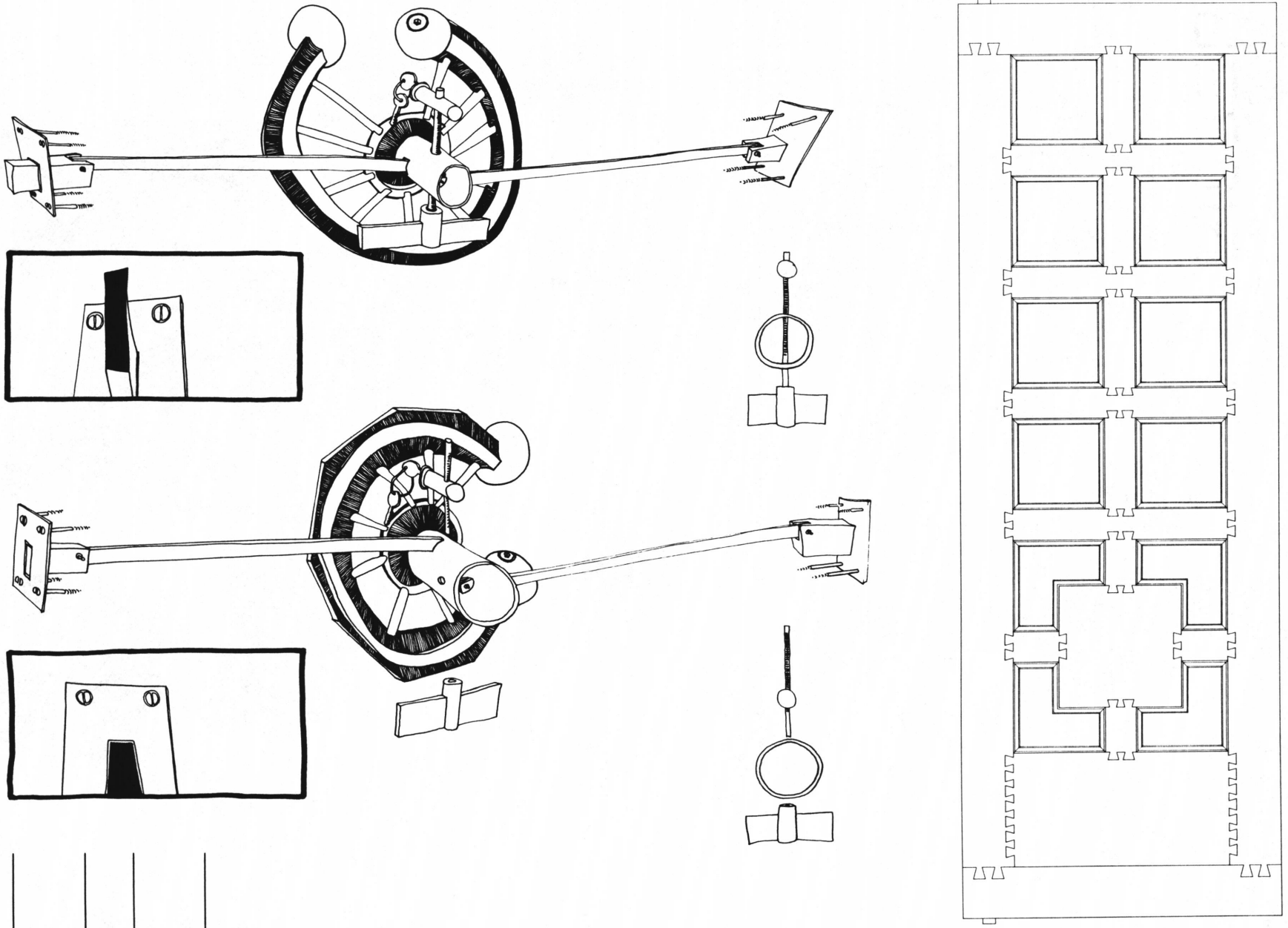

Mistakes are so important.  
Santa Cruz, California.

... seems blind ambition, replaced  
their intuition. Spoke Buffett.

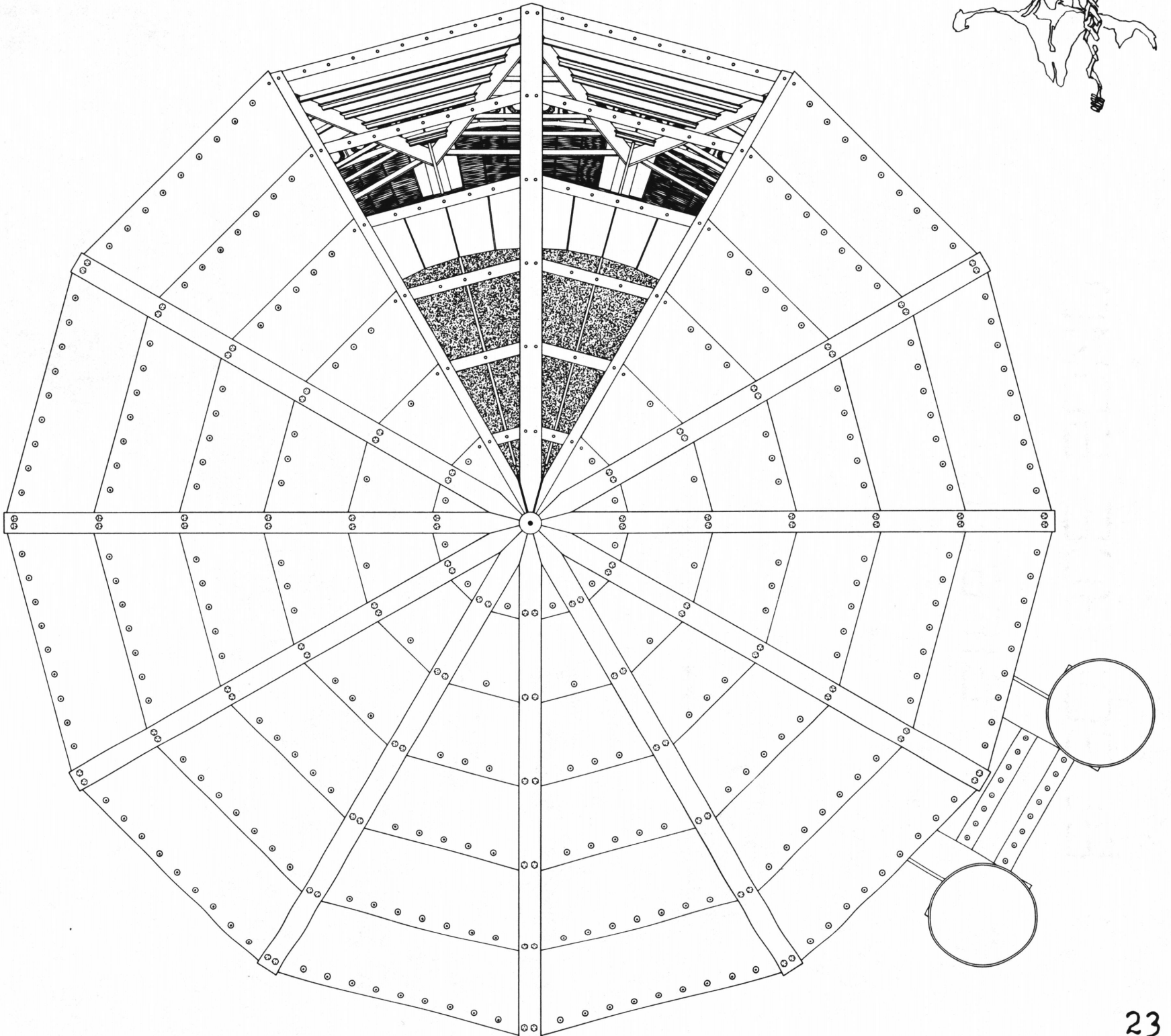
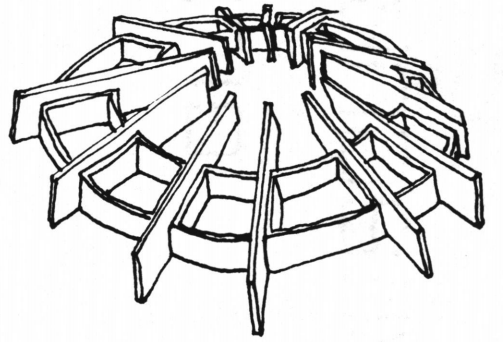
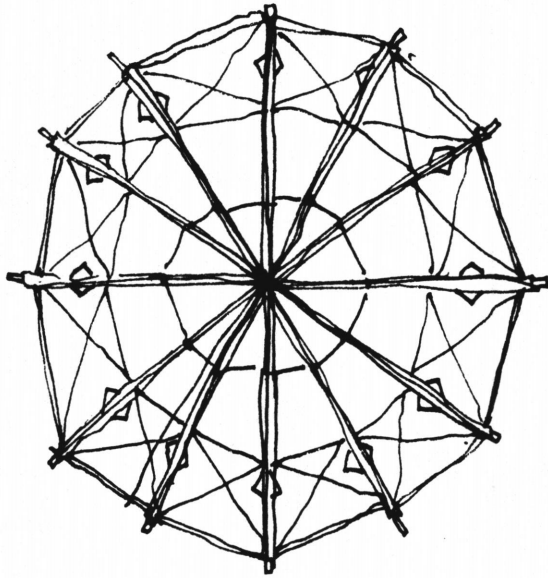
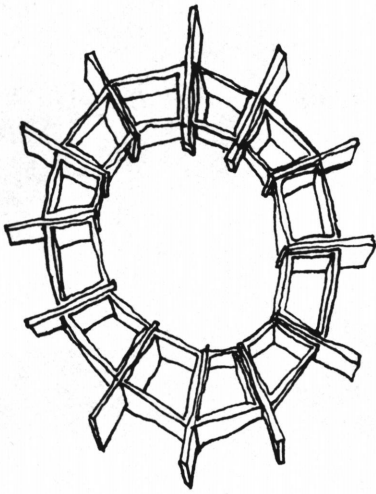



When you have to shoot, shoot. Don't talk.  
Said the Ugly.

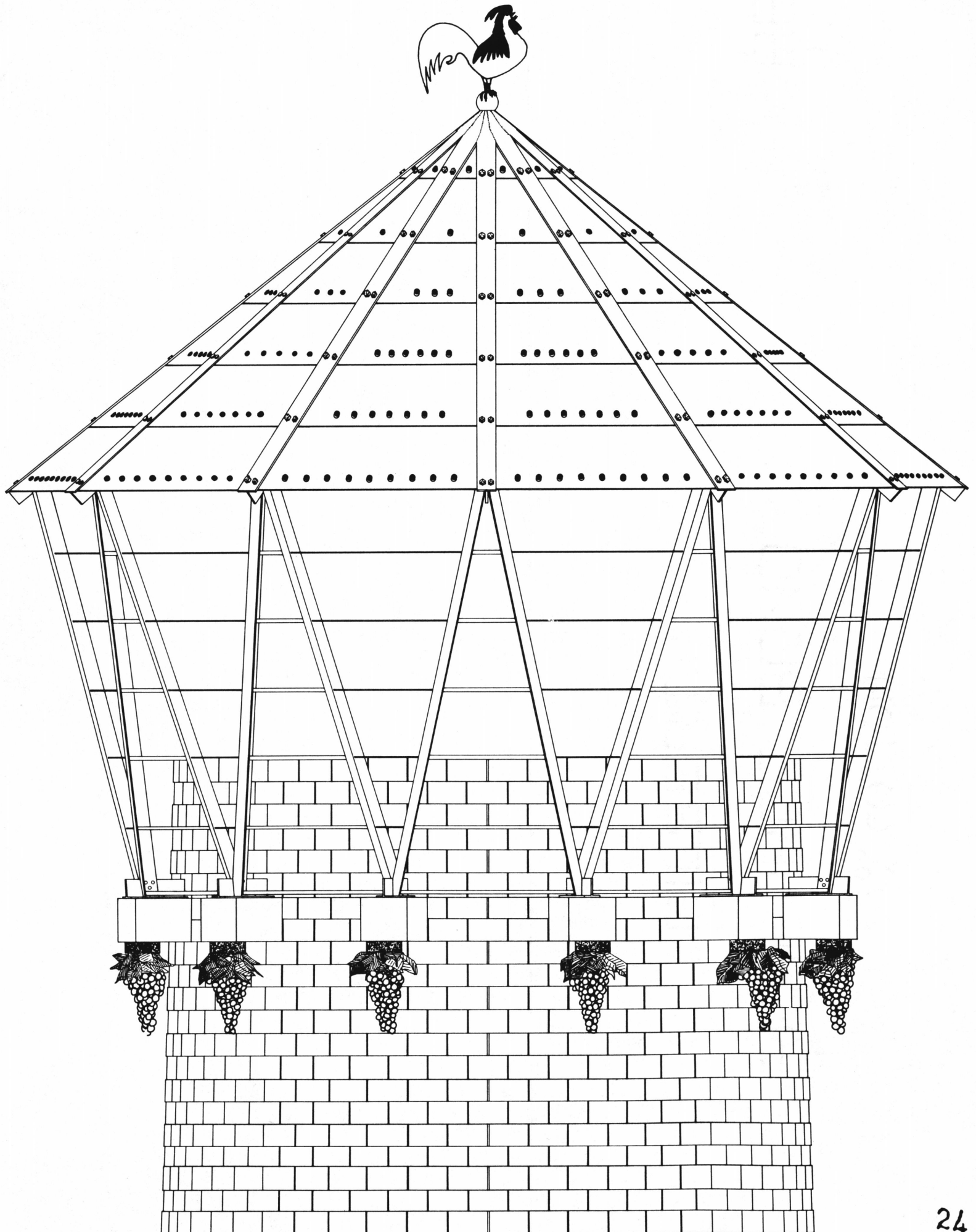

Starting from zero; got nothing to lose. Spoke Chapman.

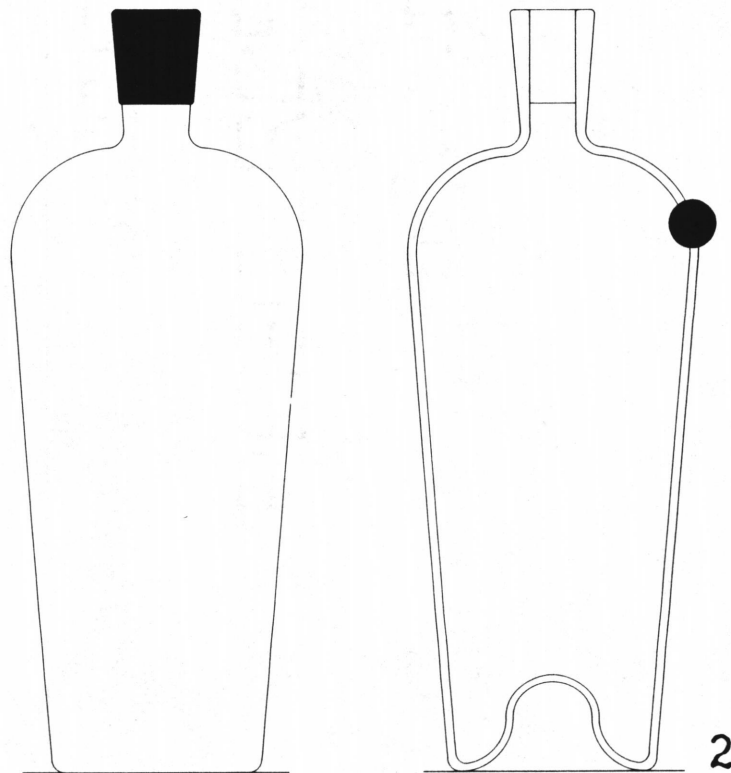
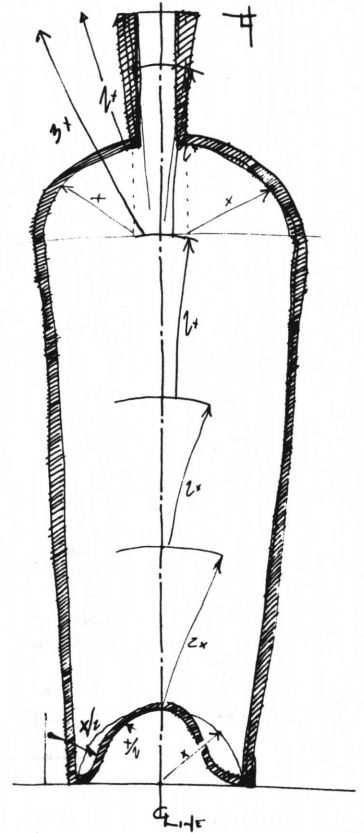
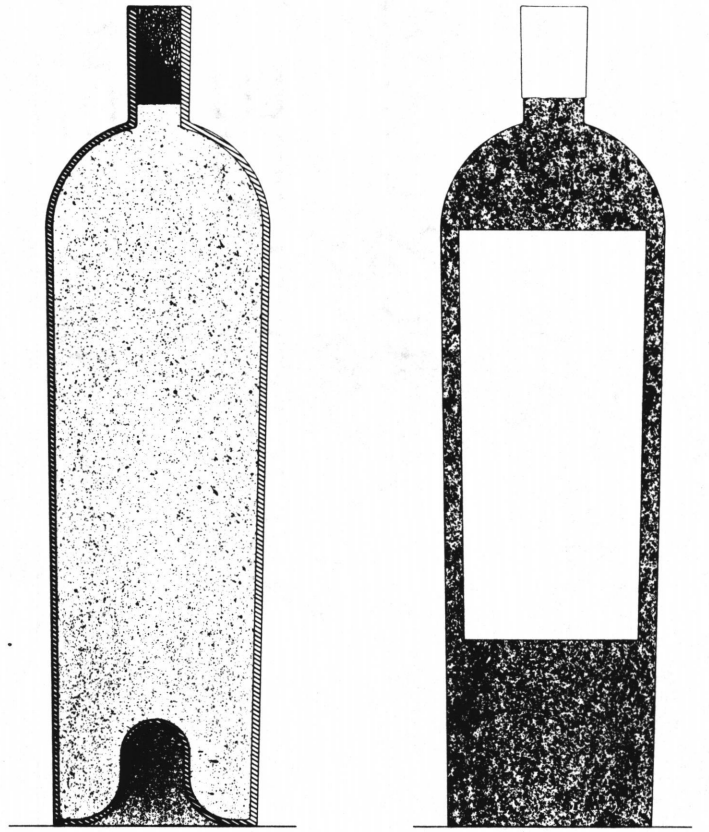
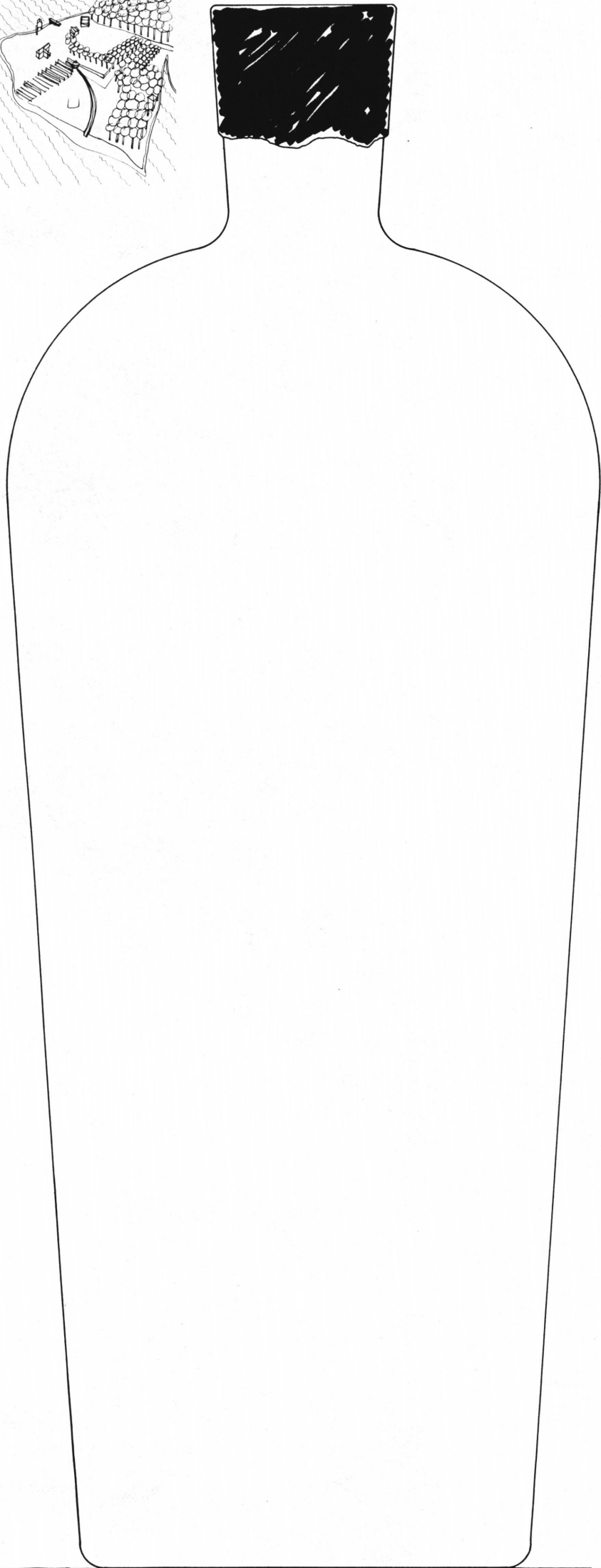
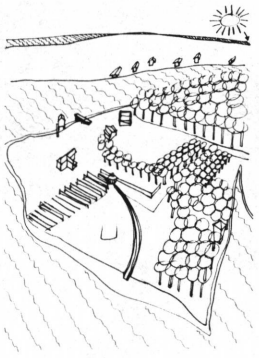

**The vita has been removed from  
the scanned document**