

DEVELOPING A DIALOGUE BETWEEN OLD AND NEW

NORTH CAROLINA UNIVERSITY CENTER FOR ART AND ARCHITECTURE

By Sam Sing Bai Yue

THESIS SUBMITTED TO THE FACULTY OF
THE VIRGINIA POLYTECHNIC INSTITUTE AND STATE UNIVERSITY
IN PARTIAL FULFILLMENT OF THE REQUIREMENTS FOR THE DEGREE OF

MASTER OF ARCHITECTURE

APPROVED _____
MICHAEL J. O'BRIEN, CHAIRMAN

JOSEPH C. WANG

BENJAMIN F. EVANS

January 1990
BLACKSBURG, VIRGINIA

DEVELOPING A DIALOGUE BETWEEN OLD AND NEW

by

Sam Singbai Yue

Committee Chairman: Michael J. O'Brien
Architecture

(ABSTRACT)

In the preservation of a small historic church, a state-wide education center for the arts is proposed due to the similarity of their inherent and adaptive nature in function.

A similar sized, new building mass with a contemporary design style is added to the old church; it will also utilize a competitive contrast to the old church in its design. The integration of the old and the new buildings will find new meanings within historic preservation.

ACKNOWLEDGEMENTS

The early part of my life was a long, dark and tough journey back in China. I only had six years of standard elementary education, then I worked hard labor for nine years in the rice fields of an uncultivated countryside during the cultural revolution. Even when the regular system returned after the revolution, I was sent to a Chinese medical school against my own wishes. It was not until I came to the United States that I felt my life began to change for the better, and I was free to pursue my goal of studying architecture. I enjoy my life here in the United States and I have received endless help from my family, friends, and professors during my school years.

I would like to express my sincere gratitude to those who are extremely important to my life and study: _____ and _____, who guided and directed me in adapting to a new environment; _____ and _____, who have been my long time friends and teachers, and from whom I have learned to speak the language and understand the nature of architectural design; _____ and _____, who guided and advised me throughout my thesis development. My sincere admiration goes to my uncle, _____ who not only provided me with the opportunity to come to the United States, but also gifted me with constant support. But most of all, I would like to give special attention to the memory to my grandparents who raised me and taught me, patiently, throughout my career; but, unfortunately, they were never able to see the fruition of my completion of this thesis. Therefore, I would like to dedicate this thesis to them, _____, for I will never forget their kind and gentle faces for the rest of my life.

CONTENTS

ABSTRACT-----	i
ACKNOWLEDGEMENT-----	ii
INTRODUCTION-----	3
PROBLEM-----	5
OBJECTIVE-----	6
PROJECT-----	7
RESOLUTION-----	9
DESIGN DEVELOPMENT-----	13
SUMMARY AND EVALUATION-----	21
PROGRAM-----	25
BIBLIOGRAPHY-----	26

INTRODUCTION

With the passage of time, each building erected becomes a potential marker of history. As they age, some will require protection and preservation because of their historical and social value, while the less important are replaced with newer construction.

Historically, fire, blight (decay), and war were the primary causes that led to replacement and regeneration of the city core. The fires of London, Chicago, Shanghai, and Rome are all good examples of this. Following the resultant burnout or decay, new structures were added that replaced the position, if not function, of the previous ones.

Today growth on the local, national, and even global scale has reached an almost exponential rate. The economic pressure to replace the older landmark structures with newer ones has increased over the past 100 years to a level where the original urban fabric of the downtown is now threatened. There remain few visible historical records, as most of its buildings are less than 20 years old.

Now we are seeing newer, bigger, and taller buildings are often replacing entire blocks of downtown areas where landmark buildings once stood. Replacement, instead of renovation has become the standard approach to urban renewal.

The economic viability and necessity of the replacement process is vital; it would be foolish to contend otherwise. Instead proposed redevelopment should be monitored comprehensively and managed in such a way as to integrate the older fabric in the new, not obliterate it. The older buildings need to be first categorized and assessed as to their potential for re-utilization, and then preserved.

For various economic reasons every building cannot be retained and preserved or there would in fact not be any future growth; only eventual stagnation. Re-integrating older forms into the newer fabric will, in fact, provide a visible and constantly evolving narrative of the core's history.



Uptown Charlotte in the early 1920's

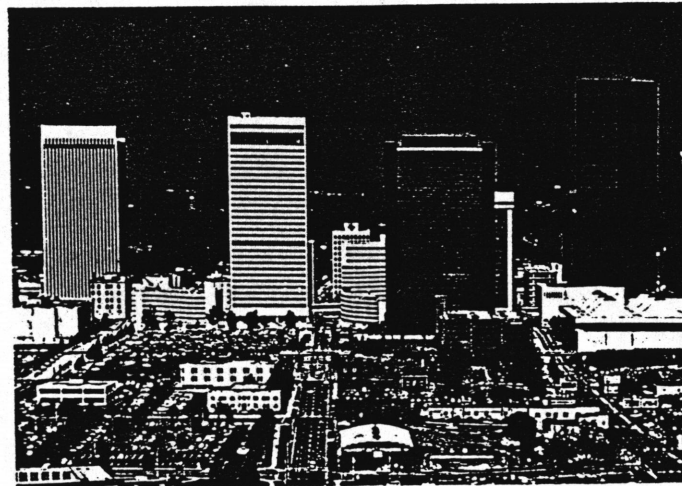

Uptown Charlotte in the early 1980's

So it is not only that a buildings literal or historical specific value must be analyzed but often it is landmark or community value. Using its group specific value is often the weakest link in supporting its preservation.

Instead, the necessity for an urban region to be able to retain and rely on its visible history becomes, in fact, a more widely viable reason for preservation.

In the discussion of preservation, two issues stand out. The first is the determination of which buildings are worthy of preservation. The second is how best to preserve them.

In order to resolve these issues a comprehensive, objective, and simple evaluation needs to be made of all buildings having potential for preservation. Each should possess either some intrinsic historic significance (cultural, political, social, or economic) or architectural significance through uniqueness of form, structure, material, or texture that would strongly differentiate it from other structures in the immediate vicinity.

While giant cathedrals and temples are more obviously valuable for preservation, many smaller and less grandiose buildings still hold great importance and significance for the overall fabric. The First Reformed Baptist Church of Charlotte is one of these smaller, older buildings. For an urban region to retain and rely on its visible history it becomes necessary to protect and preserve the landmark and community value these smaller buildings represent.

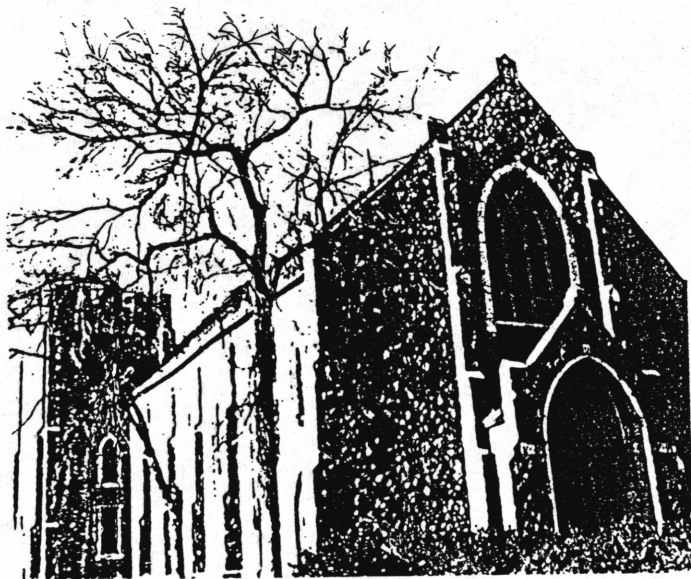

First Reformed Baptist Church 1923-27, Charlotte, N.C.

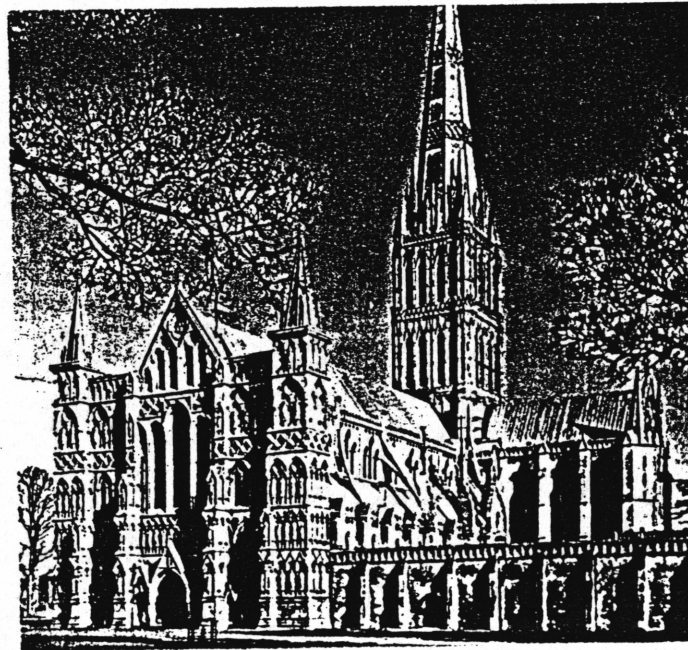

Salisbury Cathedral 1220-58, Salisbury, England

THE PROBLEM

The most common response to the preservation of older buildings today is simple rehabilitation. The building's exterior is cleaned, painted, or otherwise rehabilitated to make it appear newer. Then the interior is reconstructed to serve a new and often different function. Tax abatement or deductions are provided by the state and federal governments to entice the development community to pursue these projects.

Unfortunately, this response is not always an appropriate one for every preservation project, because each building contains individual problems. Most often renovation projects fail due to their inability to deal with the crucial issue of visual symbolism inherent in a structure of its type.

To preserve and revere every building erected simply because of its mere existence would, however, be a mistake. Simple preservation of each building would defeat the elegance history provides and would bring about eventual stagnation. Instead, an attitude that promotes integration needs to be fostered. An integration of old and new, new and old; a newer function into an older form and the older form into the newer fabric.

Integrating the visual symbolism inherent in an original structure is the biggest problem. The past three attempted rehabilitations of the FBC, first an office building, then a restaurant, and finally a condominium project, all failed from the inability to deal with this primary issue. Integration of the existing shell into a newer, larger complex, while allowing the older church to contrast against and create a balance with a newer facility was the solution pursued. Through the programmatic use of the formal setting for performance and gallery functions, the ritual and congregational functions were redirected and revitalized.



Great Pacific Patagonia Store (renovated)
Boston, Mass.

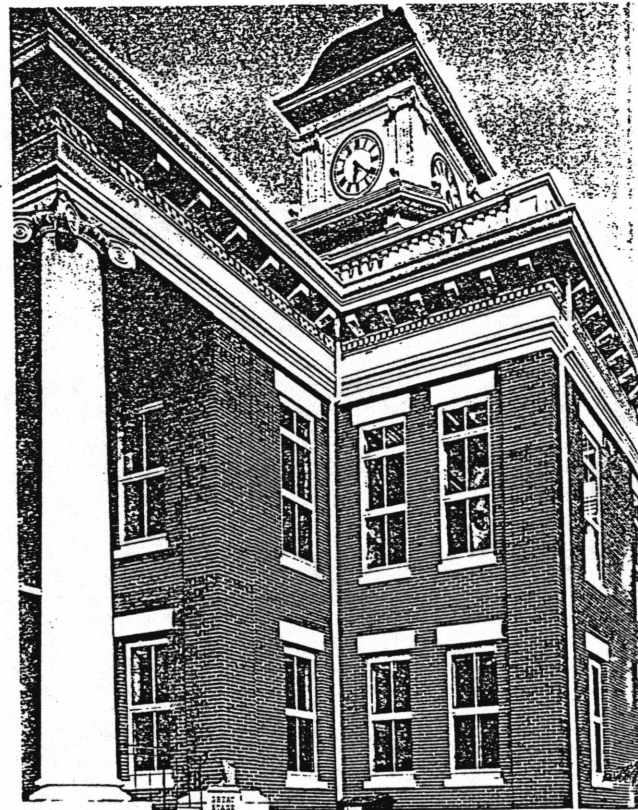

Washington County Courthouse (renovated)
Jonesborough, Tenn.

OBJECTIVE

The objective of this study is to demonstrate a design experiment on the revitalization of historic property as an alternative to the demolition or renovation of an existing building. The approach of this experiment is to redefine an existing building into a newer, larger structure with a modern framework. It is expected that through the creation of a sensitive dialogue between the existing structure and a new one, each part would maintain its own character while communicating with each other in a compatible and harmonic tune.

A building is not simply an object, it is a marker of time, culture, and technology. An old building provides a window to the time when it was erected. A new building presents an opportunity to reflect its own time. When the two stand together as one picture, it can become an enlightened composition. The New York Times architectural critic, Ada Louise Huxtable, puts it best when she states, "The past and the present together are a knock-out aesthetic."

Using the concept of integration, the development of a new building adjacent to an older one leads to a dialogue which, in turn, creates a new complex. Both buildings are equally vital to the new complex's existence, become dependant on each other's presence, and can then be appreciated more fully through vocabularies established within the dialogue. Thus the old building may be reinterpreted through the new construction, as the new structure finds meaning in the existing one.

THE PROJECT

Charlotte, a metropolitan area with a population of over 500,000, is located in an urban region centered on the border between the Carolinas. Located midway between the coastal and the mountain areas in the middle of the Piedmont, it has truly become the central "Downtown" of the entire region.

The original settlement was formed upon the intersection of two major Indian trade routes. These would eventually become the two main axes of the city, Trade Street and Tryon Street, upon which the current street grid system is based.

Within the last five years, a freeway belt loop has been built at the edge of the city core. It has bounded and defined city's inner urban area, effectively acting much as the walls had in medieval times.

The FRB Church complex located on the eastern axis, North Tryon Street, was chosen. Positioned immediately adjacent to the inside of the beltway on this main axis, it held the potential to act as a physical and symbolic gateway to the city core. This sector of the urban core is composed primarily off municipal, cultural, and arts oriented enterprises. It Houses most of the city's art galleries, design firms, restaurants, and existing performing arts facilities.

Built in the early 1920's, it continued to function as a church until its closing in the late 1970's, when the new suburban-based congregation outgrew the building and subsequently built a newer church closer to their homes in the suburbs.

It then sat vacant, changing ownership at least a half of a dozen times, occupied mostly by vagrants and pigeons. In 1985, a fire broke out and burned out the entire interior leaving only a masonry shell. It appeared that the form of the remaining shell could be integrated into an institutional facility that required a formal, ritually oriented space.

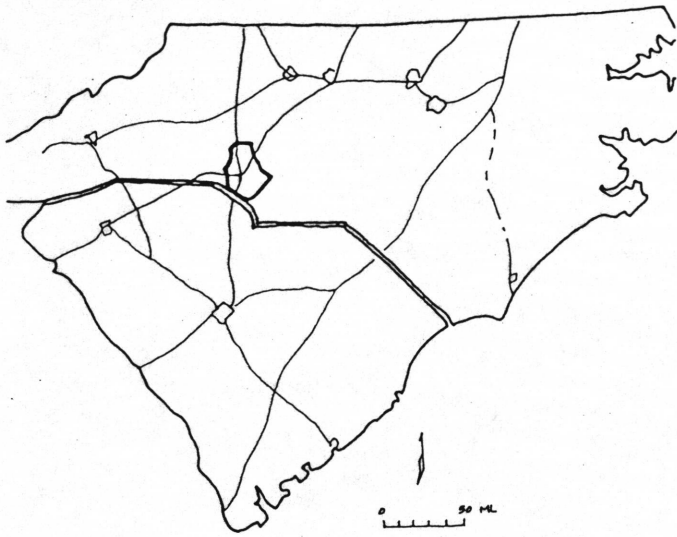

THE CAROLINAS: Charlotte is located at the geographical center of North and South Carolina.

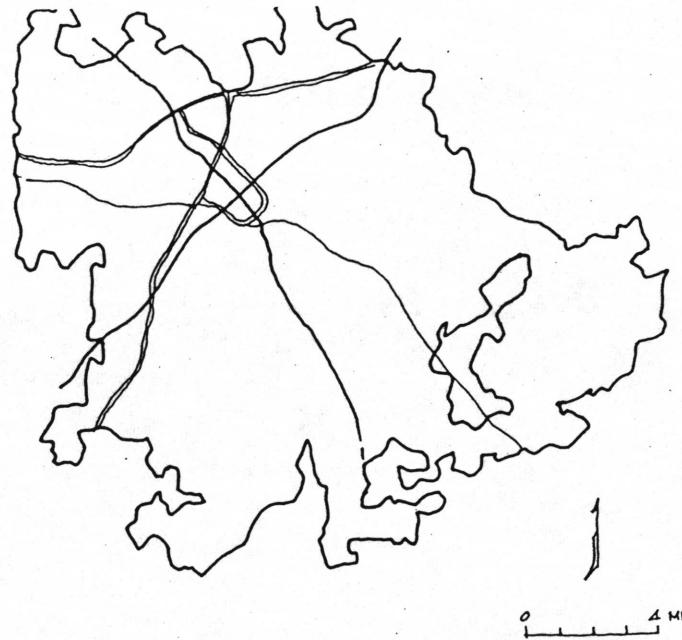

CHARLOTTE: The city is centered on the crossing of two main street, Trade and Tryon.

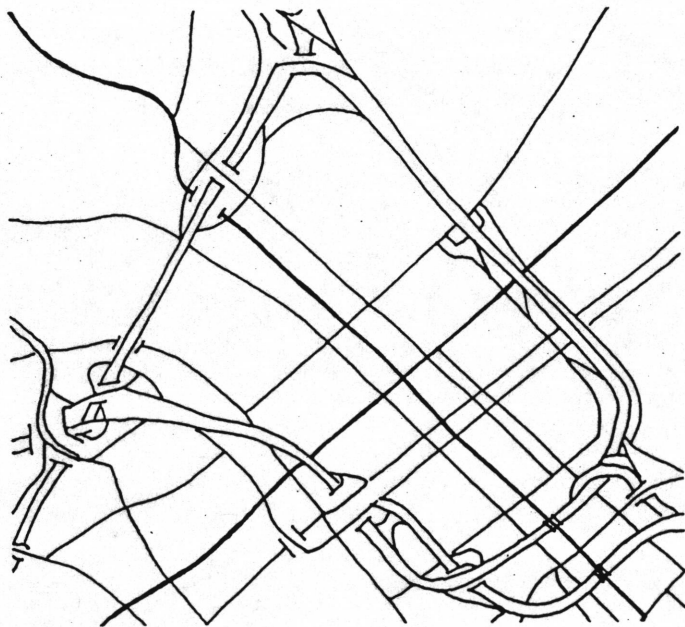

UPTOWN AREA: The freeway loop now forms a boundary for uptown Charlotte.

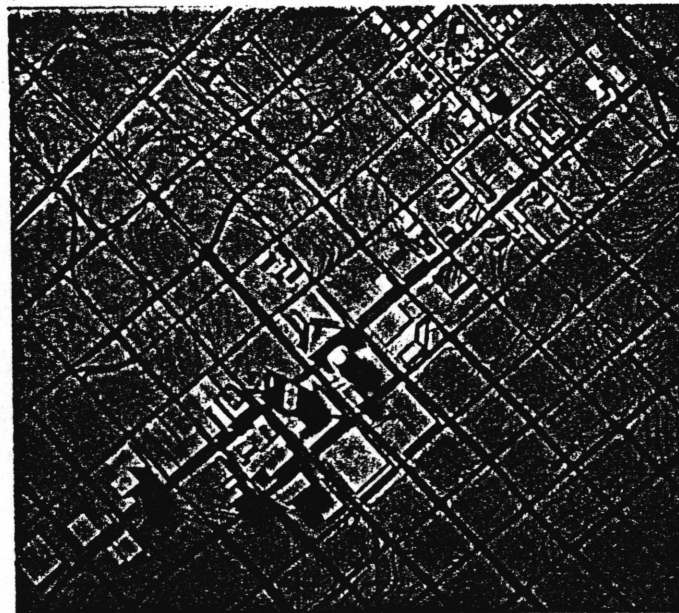

URBAN CORE: The CBD is a concentration of high-rise construction, while the arts district is restricted to low-rise.

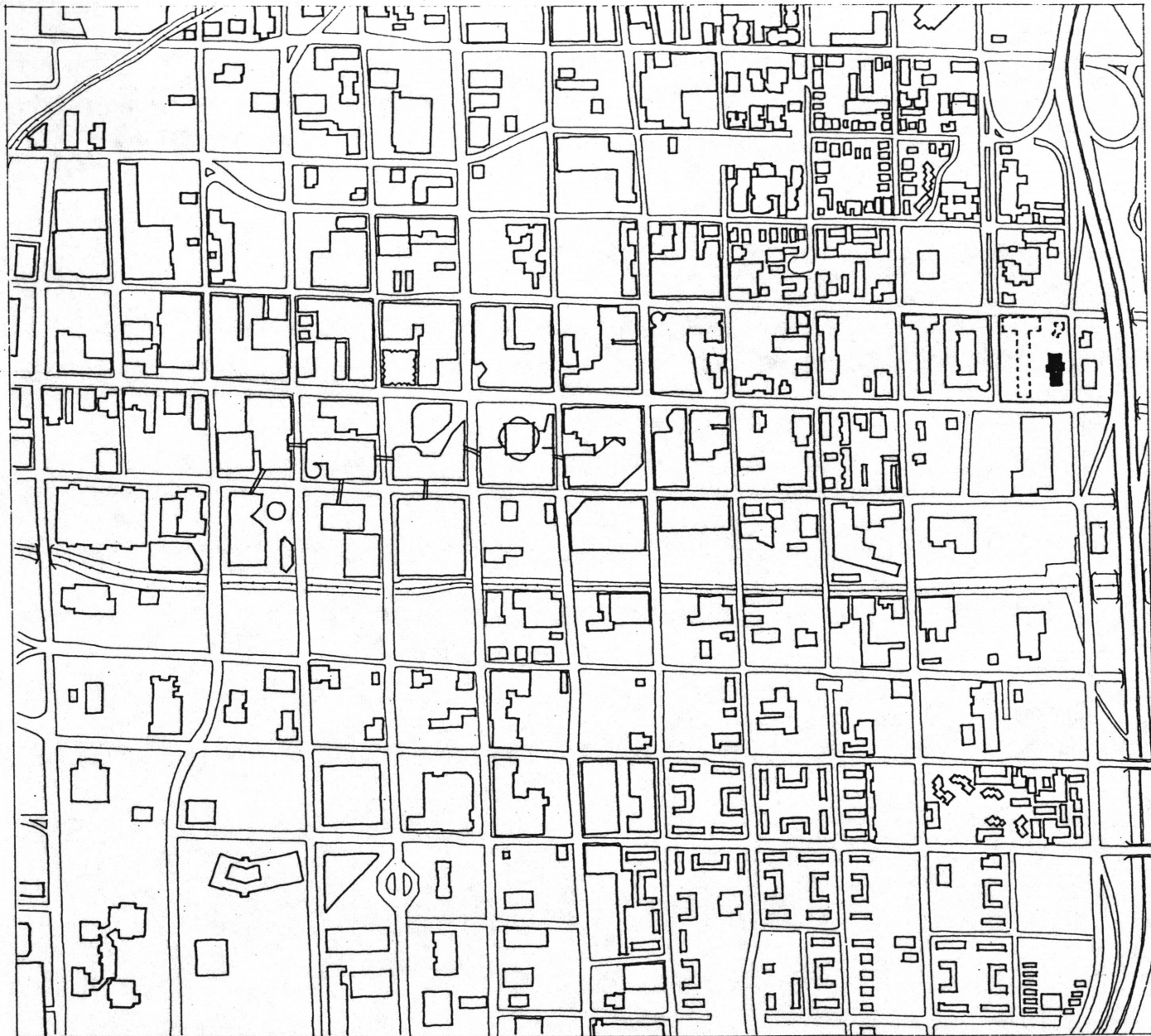

UPTOWN CHARLOTTE

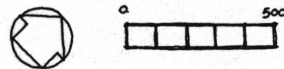

Given the location in the arts district and the gateway position to the city, the development of a state-wide educational facility for the visual and performing arts is a most appropriate re-vitalization of the site.

It is proposed that each of the 16 major state institutions of North Carolina would send 10 students annually to this University Center for the Arts to exchange and interact with the other students in an urban environment. Faculty from each institution would be invited in addition to local professionals from each of the art disciplines. In addition, two outstanding artists, one visual and one performing, would be awarded a one year residence to participate in this program.

The purpose is to increase the dialogue and relationship between the schools, the visual and performing arts, as well as between the arts and the community itself.

RESOLUTION

In the examination of a newer building's immediate impact on its older neighbor, three crucial physical factors must be singled out as the most important. These are height, surface, and mass. Success of the two separate identities becoming a whole is measured by the depth of dialogue created, they should provide a strong visual relationship. Height, surface, and mass are all essential aspects specific to this dialogue.

Since each building serves as a representation of its time and culture, the dialogue between the two should be developed through careful manipulation of design style, construction technology, material, and overall geometric shape. The visual impact of the new complex is directly derived from the interrelationship of building height (including cornice height), surface composition, and mass. That is, the alignment and overall proportions of the two buildings together must be very conscious and responsive to each other. A few good examples are the Jewett Art Center in Wellesley Mass., The Boston Public Library, and The Charlotte National Bank. If not, dialogue is not formed, and it remains only in a state of discord.

These examples possess the creation of dialogue, the basis that seems to arise through the manipulation of point-counterpoint, or contrast between the old and new. This is because the old and the new are relative to each other. When together, the old appears older, the new seems newer. Even though it is the idea of making the difference of contrasting old and new, the contrasting of a new building against an old one is much more than that. The real difference is our responsibility towards our environment, and sensitivity towards history, beauty and so forth.

Generally, there are two basic approaches to contrast. A bold, vigorous one or a contained, smooth and meticulous one.

The first type of contrast is one of exaggeration. It deals mostly with the contrast of size, because the

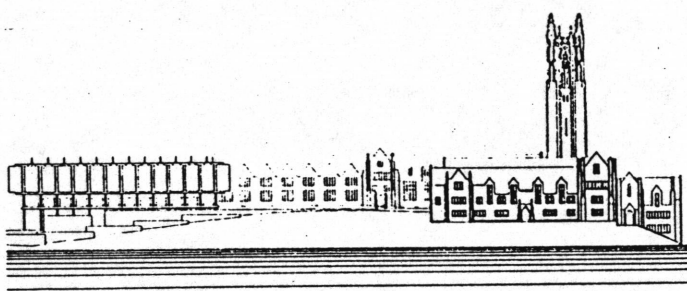

Jewett Arts Center 1970's, Wellesley, Mass.



Charlotte National Bank parking deck 1988, Charlotte, N.C.

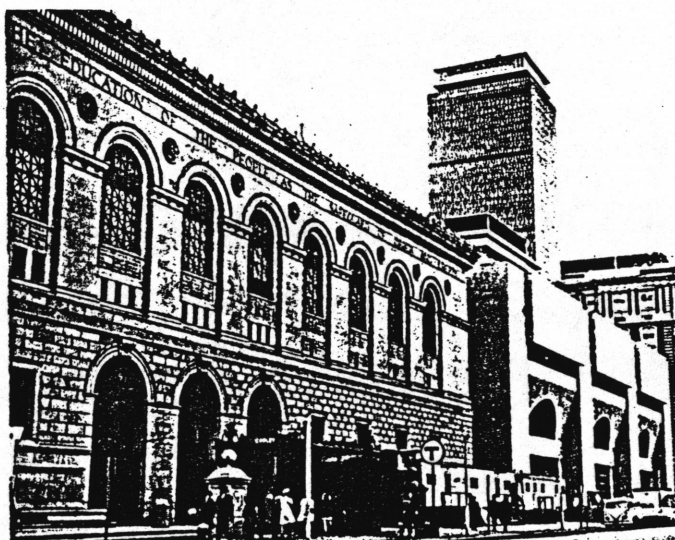

Boston Public Library 1973, Boston, Mass.

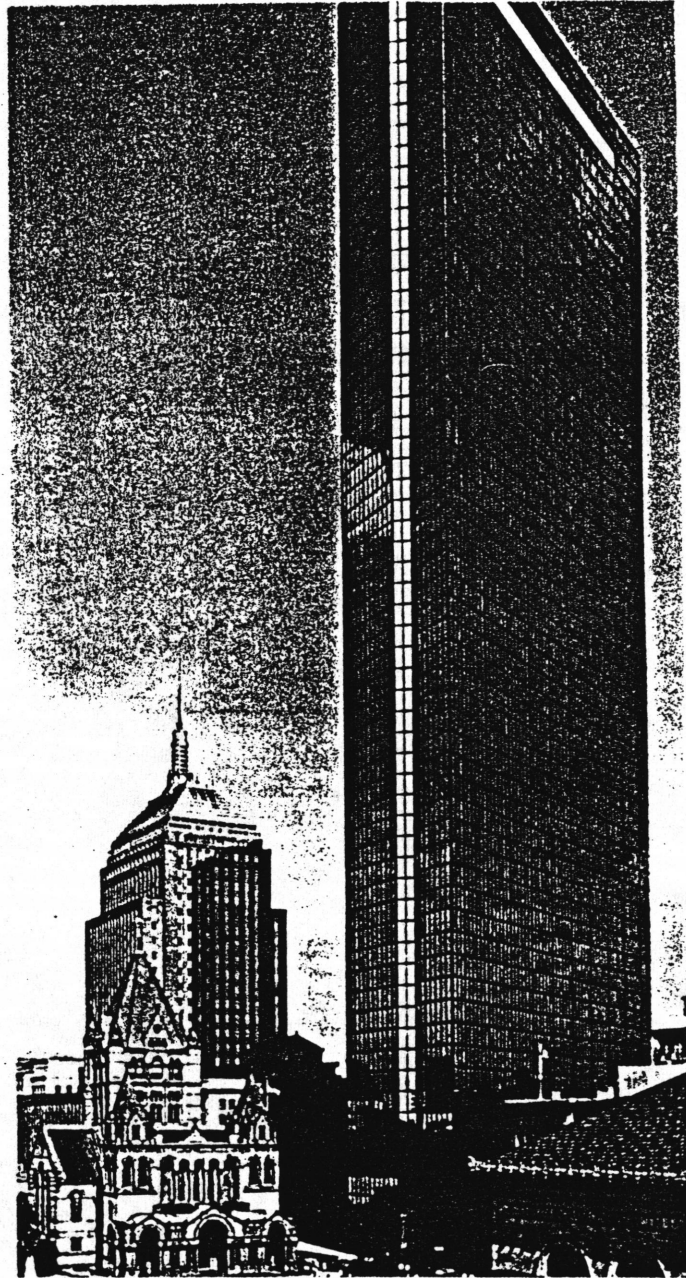

Trinity Church 1847-77, and John Hancock Tower 1967-76,
Boston, Mass.

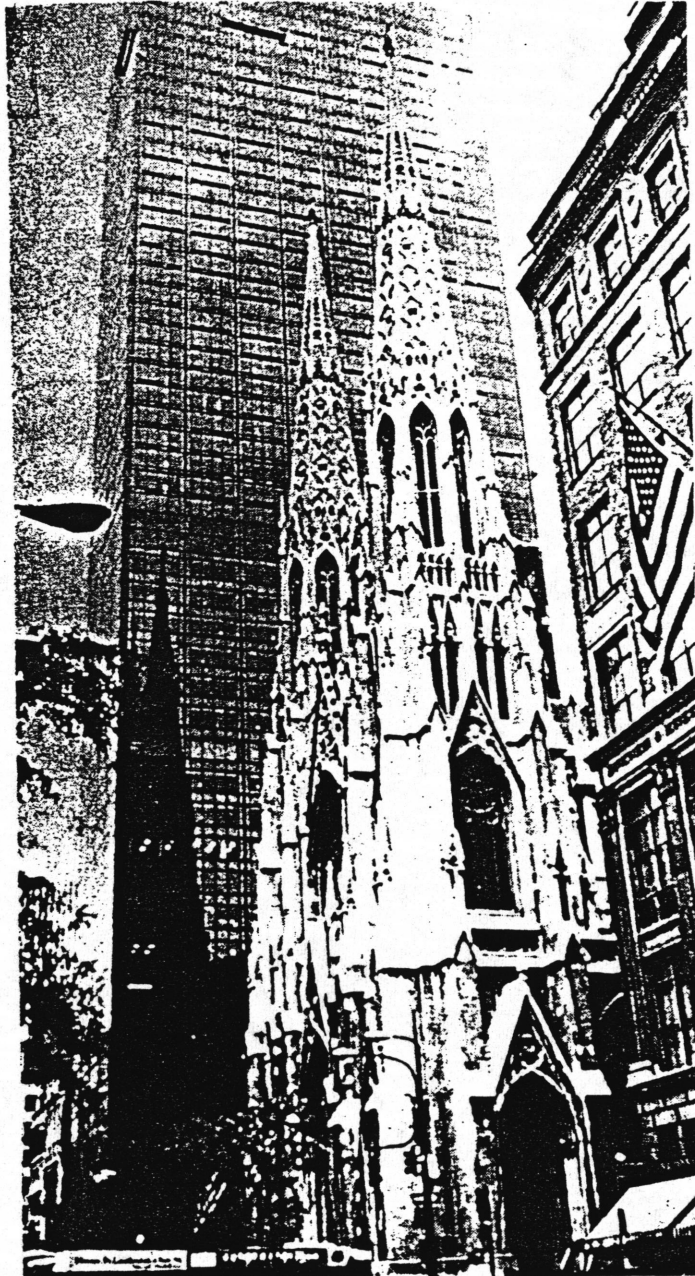

St. Patrick's Cathedral 1858-79, and Olympic Tower 1977,
New York, N.Y.

differentiation in building mass is always the first visual reading we obtain. So, in order to achieve a positive result, new buildings are built in greater heights or with textural surfaces that contrast with the building materials of the relatively intricate and sculptured old ones. The Trinity Church in Boston and the St. Patrick's Cathedral in New York are evident examples where neighboring developments utilize the rich sculptural forms of these historic buildings. The new, vertical, reflecting glass curtain walls of the John Hancock Building in Boston and The Olympic Tower in New York, both reflect and contrast the intricate sculptural surfaces of their neighbors.

In terms of contrast by exaggeration where the building itself is the subject of redevelopment, there are a number of ways to approach the original structure. An example of this is a smaller addition to a larger, older building as in the new entrance portico for Spirit Square in Charlotte. The older building can also be embraced by a group of similarly characteristic new ones, as in the new Canadian Center for Architecture in Montreal.

This type of contrast sets the new building as a backdrop so that the old ones may appear to stand out and attract more attention. The intricate sculptural form, exposed fine detail, and nature of the surface material of an older building would be revealed more explicitly when set against a totally opposite background. Meanwhile, the newer building exhibits an image of gigantic power and size, high-tech modern material and construction, and rich political and economical visibility as a result of the contrast.

However, in many cases this size and height contrast approach is limited by location, orientation, and political issues such as zoning restrictions. The FRB Church of Charlotte is such an example. Located in what is now designated as the arts district of the city, height restrictions were imposed to assure that the overall ambiance and low-rise character of the area would be preserved. Therefore high-rise alternatives are not feasible. Under these circumstances the contrast must be developed through more contained means, with the compatibility between the two contrasting buildings becoming an important measure of success. A new structure,

in circumstances where the overall contrast cannot be dramatically rendered, must be designed to contrast sensitively and compatibility with the older structure by embracing it, not antagonizing or mocking it. If not, it will damage and ultimately destroy the ambiance that was to be preserved to begin with.

In order to develop this compatibility most effectively, a dialogue must be developed between the new and the old.

Dialogue between forms with respect to detailing and construction issues is by far one of the most important opportunities. Although construction technologies are often similar (masonry, load bearing walls, steel and composite roof structures, etc.), assemblies and technologies available to present construction offer a wide palette to choose from.

All the above aspects are to create a visual dialogue. However, without linkage, the two parts still remain separate. This linkage can be almost anything that connects the two. A room, a bridge, or a row of columns are physical linkages. On the other hand, visual discontinuation between the building facades can increase the level of contrast through the creation of a dark shadow.

The two distinct forms can be linked by a common element at their juncture. By utilizing state of the art construction methods to expose and delineate the new facility composition, a dialogue between the two forms is developed.

To avoid grafting the two forms and destroying the delicate balance between them, an active mechanical joint like a rail car coupling must be developed.

However, the simple inclusion of building elements alone is not a formula to create instant visual dialogue. The designer needs to make a sensitive determination of a building's essential characteristics, to assess which aspects should come to the front as the common denominator. Whether materials, scales, rooflines, or facade rhythms are most crucial, the most important aspect must be recognized and utilized as the basis for the design determination of the new building. There are instances when repeating material is



Canadian Center for Architecture 1989, Montreal, Quebec

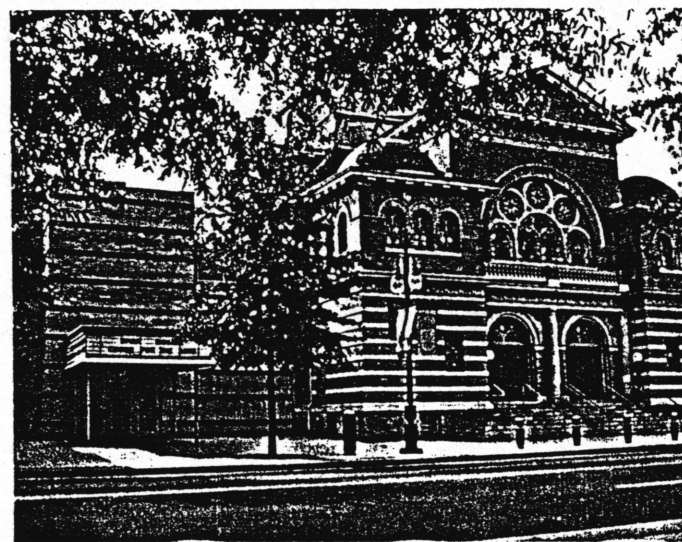

Spirit Square new entrance 1984, Charlotte, N.C.

enough, so long as the other elements are not in too great a discord. There are times when keeping in scale is enough. Still there are times when an even roofline is all that matters. But often times all of these factors can become superficial imitation. As Michael Graves said, "Idealization of the superficially well-behaved buildings place priority on 'good manners' in design; but surely architecture rises questions of greater interest than manners."

Capturing and harnessing the spirit of a project is the key to the success of weaving, combining and contrasting the timelessness of the old and the energy of the new.

DESIGN DEVELOPMENT

The primary step was to perform an analysis of the other secondary buildings on the site. The existing strip motel development held no significance and was in an overall poor structural condition. The small two-story manse in the rear of the church was in relatively good condition and could be saved if required, but was itself not of great merit historically or architecturally. Given these conditions, both buildings should be removed.

The second step was to reinforce the gateway position of the site in the city fabric. The first full block inside the freeway loop bridge, the site needed to serve as the transition zone between commercial development to the south-west and the residential areas to the north-east.

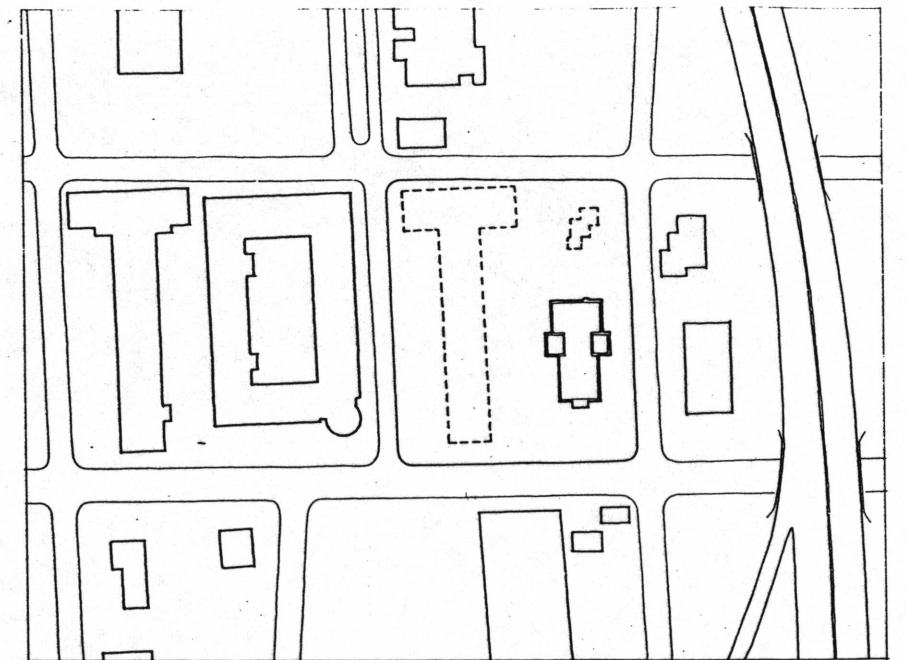
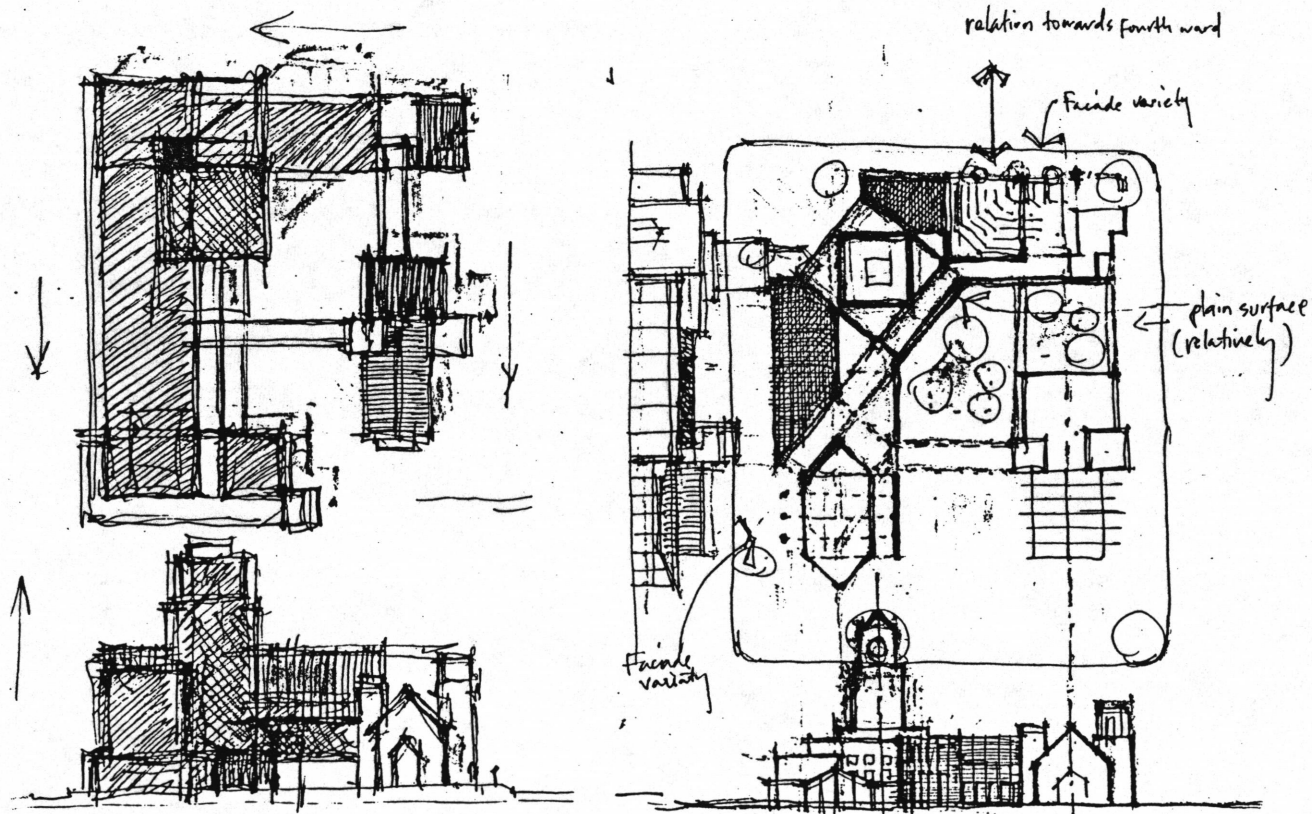
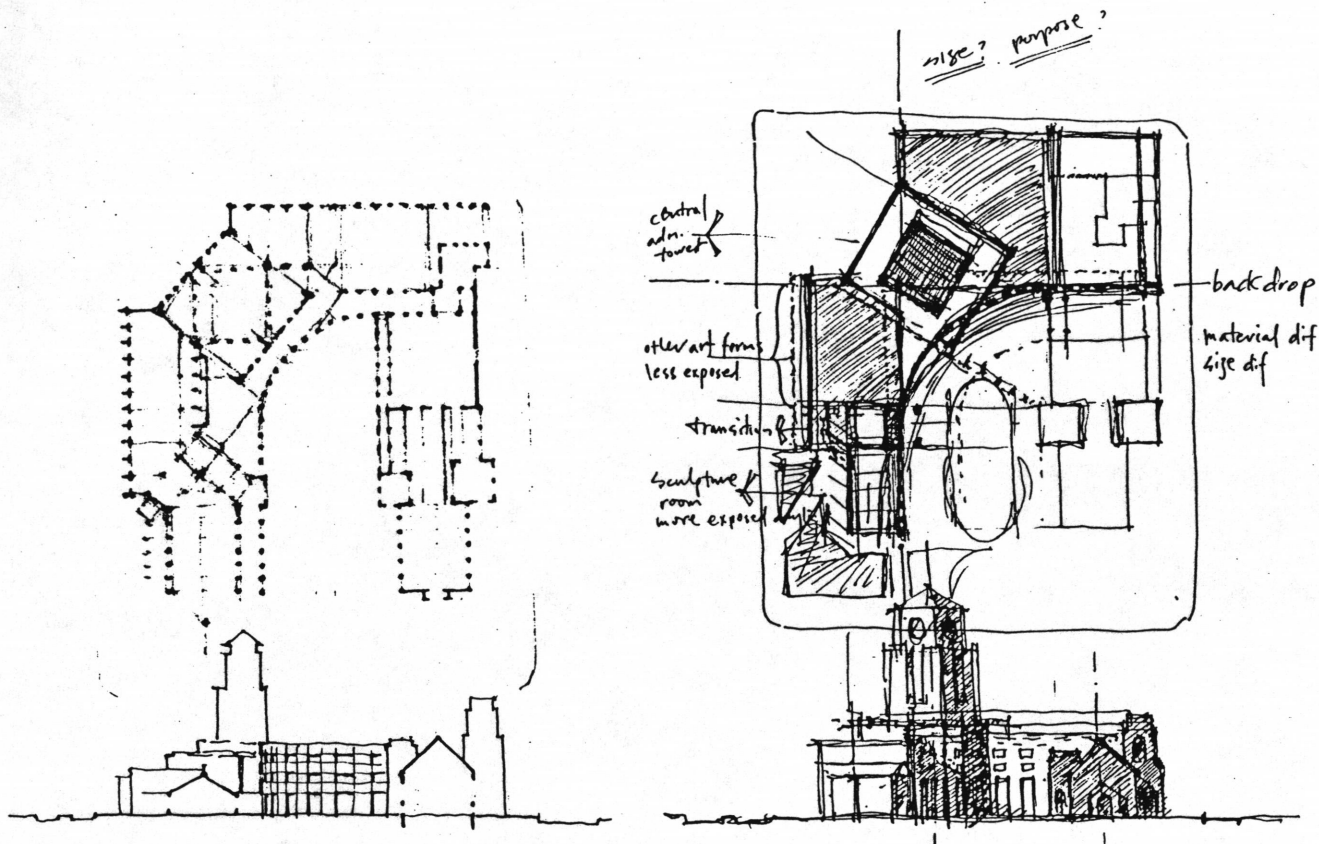

SITE DIAGRAM

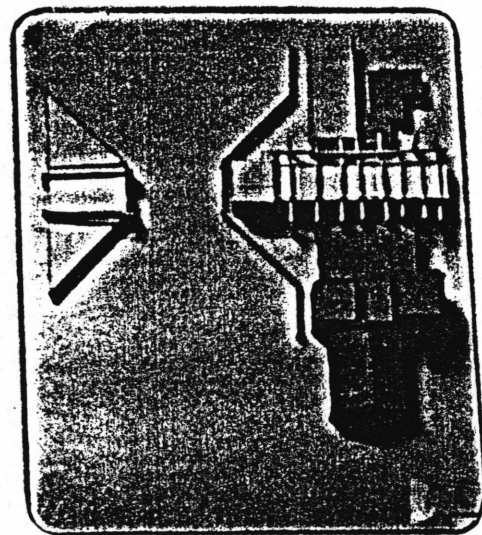
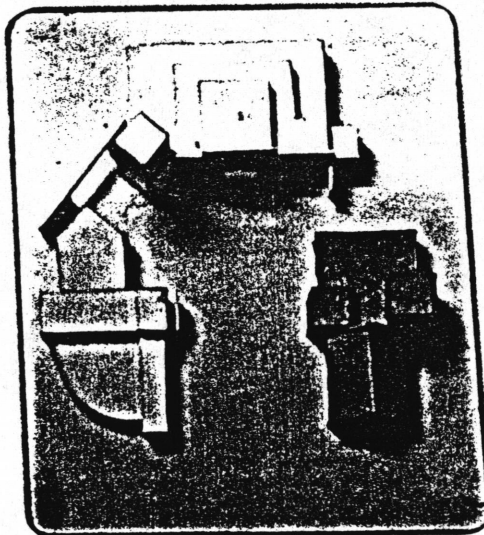
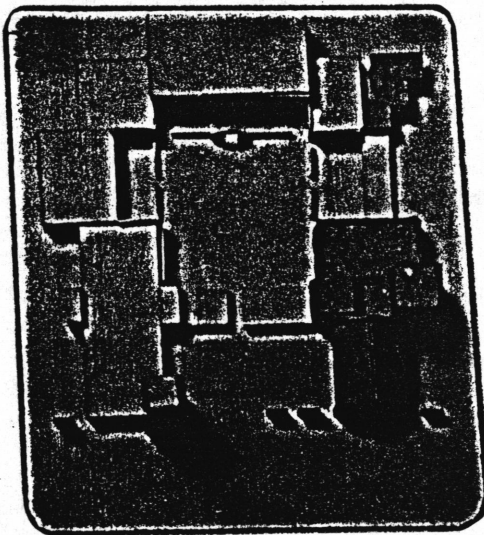
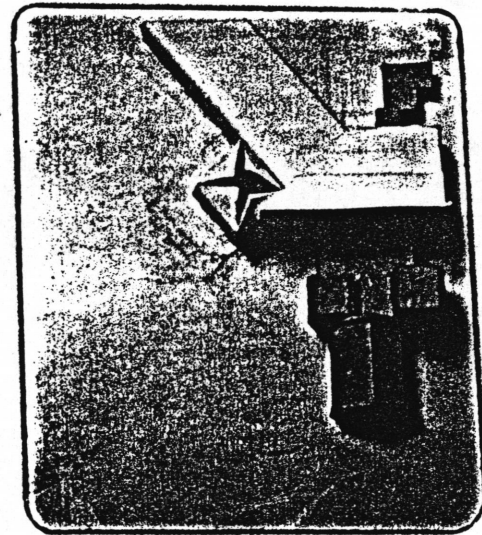
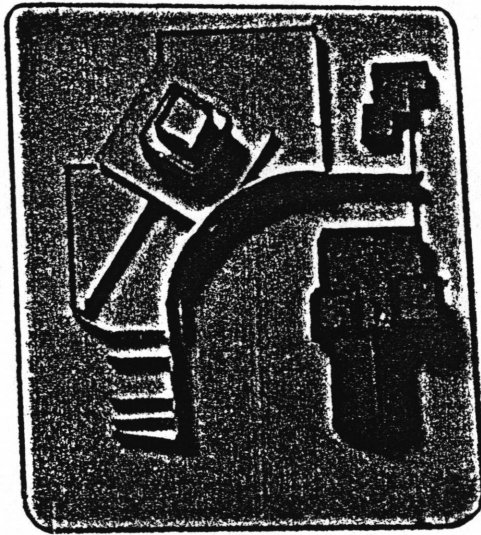
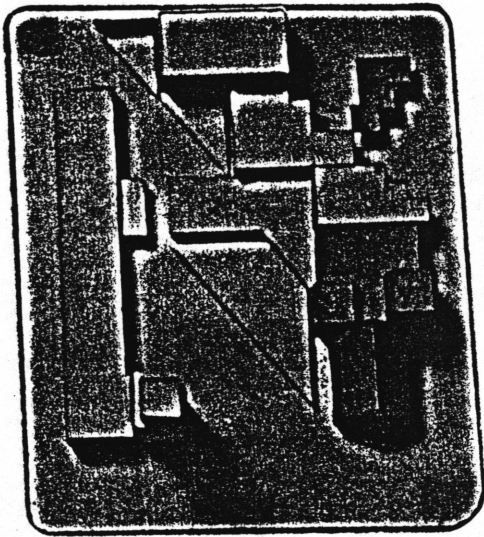

An axis is developed parallel to the freeway and perpendicular to Tryon Street allowing the main elevation to face downtown and the arts district. By reorienting the "front" of the building in this way and consolidating the project massing along this primary axis, the site then anchors the arts district and serves as a distinct marker of the inner urban core's edge. The transitional nature of the site is strengthened by the introduction of a secondary cross axis formed by the two open rectangular plazas. These public areas establish a sequenced and increasingly private buffer zone into the residential areas.

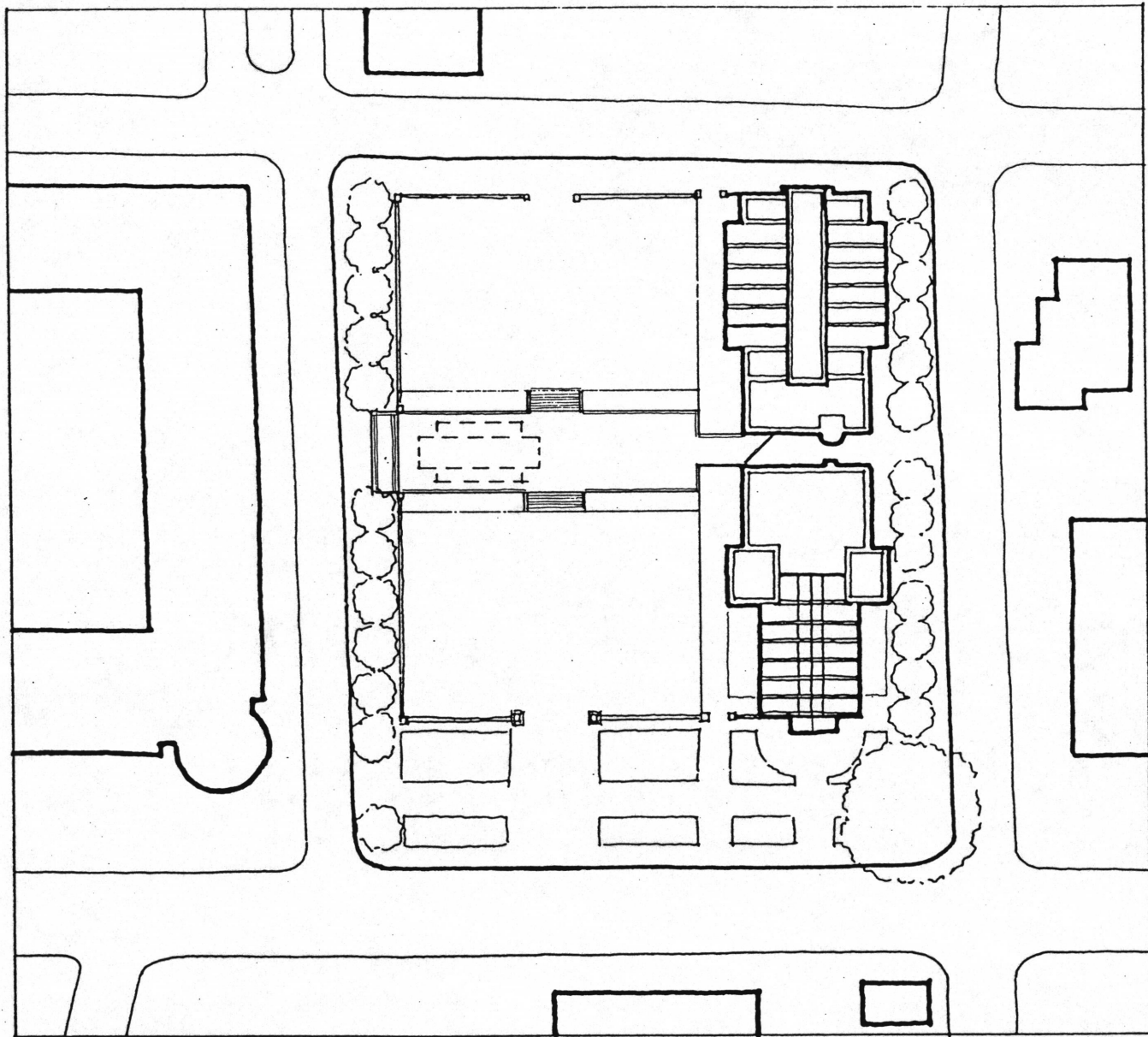

SITE PLAN

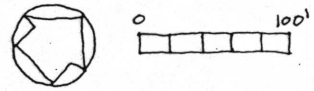
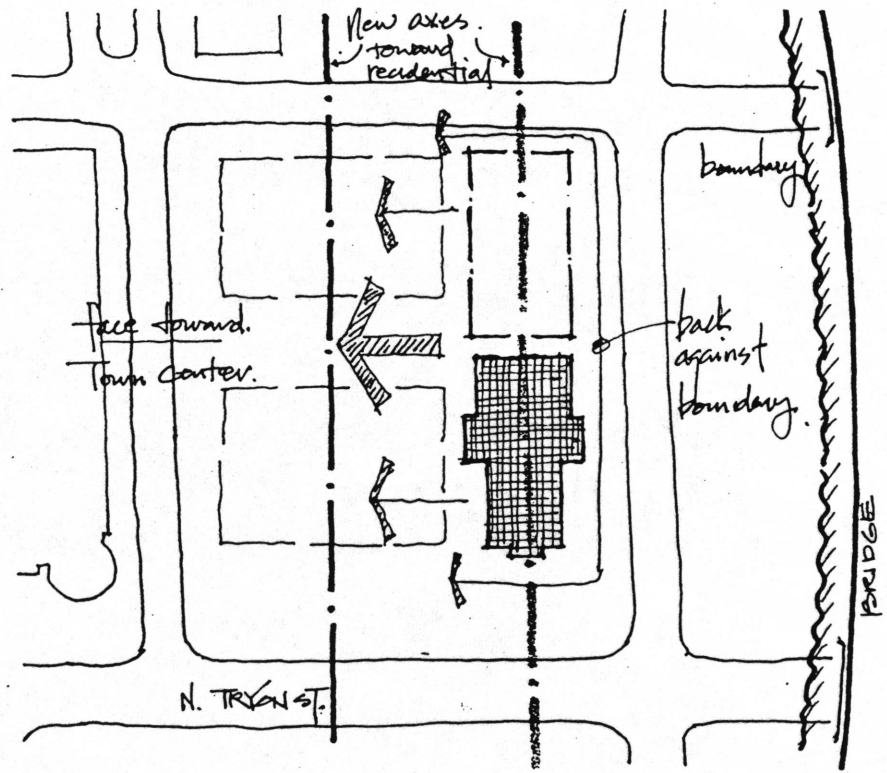
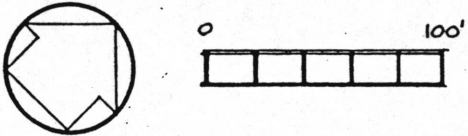

FLOOR PLANS

The lower plan houses the reception, lobby, administration, and permanent prop storage areas serving the performing arts functions. The visual arts side contains a gallery space for exhibits; studios for sculpture, painting and pottery, and two workshops. The ground floor of the connecting atrium volume serves as the entry and the linkage zone for both vertical and horizontal movement.

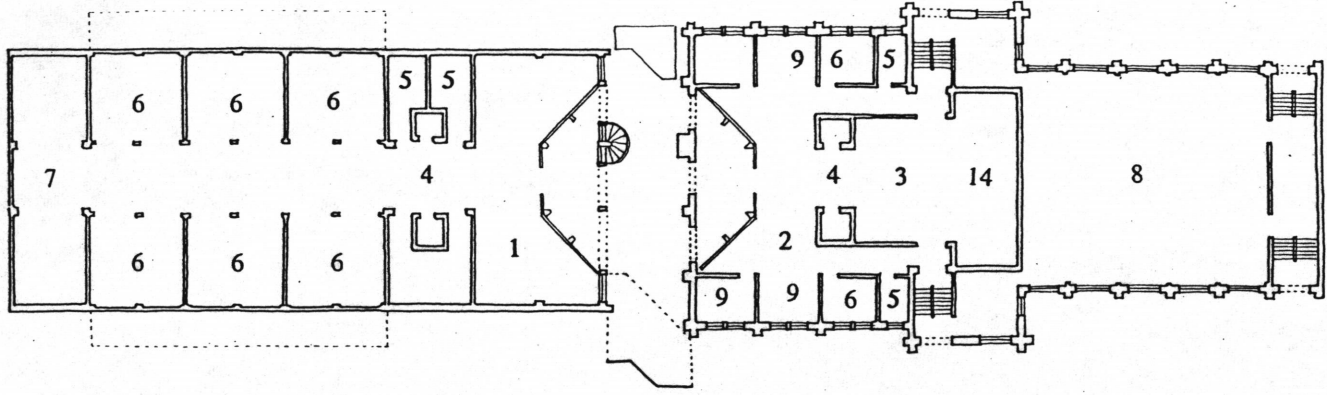

FIRST FLOOR PLAN

The second floor plan serves as the main entry level for outside visitor access, for both visual and performing arts. The lobby and reception functions for the visual arts school are located on this floor off the entry atrium. The library and the conference areas are located on this level serving the entire complex. The bridge connecting the future visual arts gallery to the main building attaches the atrium volume. Smaller practice, office, and storage areas are located around the auditorium space in the existing building, serving the performing arts faculty and functions.

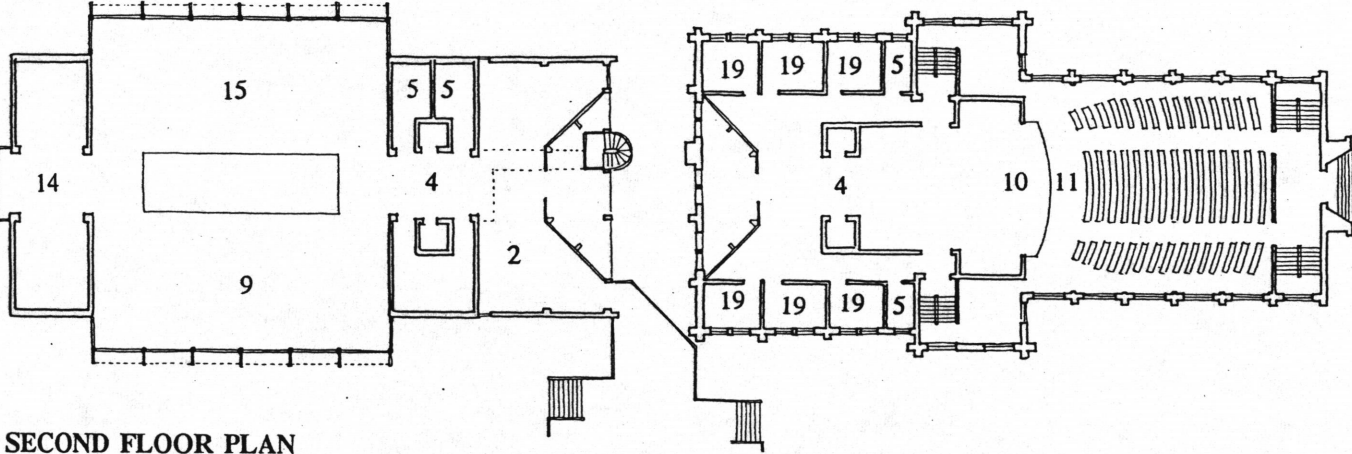

SECOND FLOOR PLAN

The third floor plan houses the art and architectural drawing studios, and a lecture room in the new building. The old building contains all the dressing rooms, control rooms, and performance support facilities.

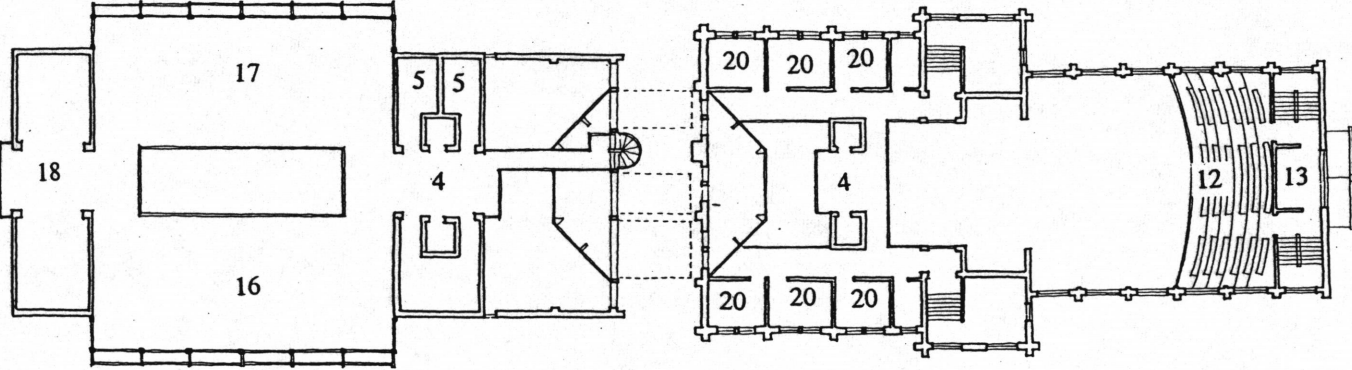

THIRD FLOOR PLAN

- 1. Gallery
- 2. Lobby
- 3. Reception Area
- 4. Circulation
- 5. Rest room
- 6. Studio/Classroom
- 7. Workshop
- 8. Storage
- 9. Office
- 10. Stage
- 11. Main Auditorium
- 12. Upper Level Auditorium
- 13. Control room
- 14. Conference room
- 15. Library
- 16. Architectural studio
- 17. Art studio
- 18. Lecture room
- 19. Practice room
- 20. Dressing room

ELEVATION AND SECTIONS

The two level, six bay configuration of the main section in the new building is derived from the main auditorium of the old building.

The rhythmic order of light and dark volumes existing in the old structure is carried forward into the new structure. The entry is off the center courtyard. The performing arts progression is 1.Lobby/shaded, 2.Auditorium/lighted, 3.Entry/shaded. The visual arts progression is 1.Lobby/shaded, 2. Studio atrium/lighted, 3.Workshop/shaded.

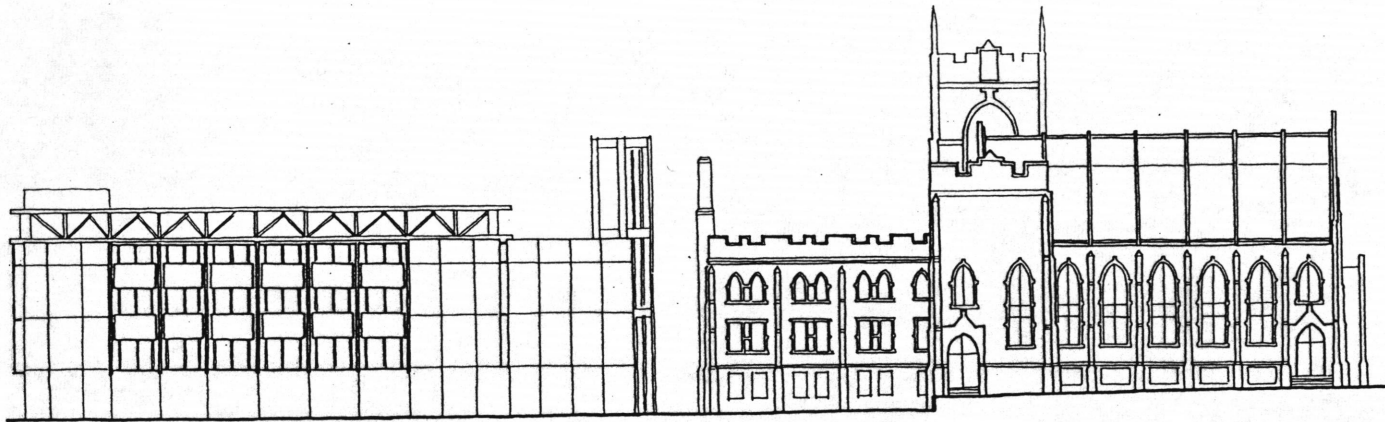

MAIN ELEVATION

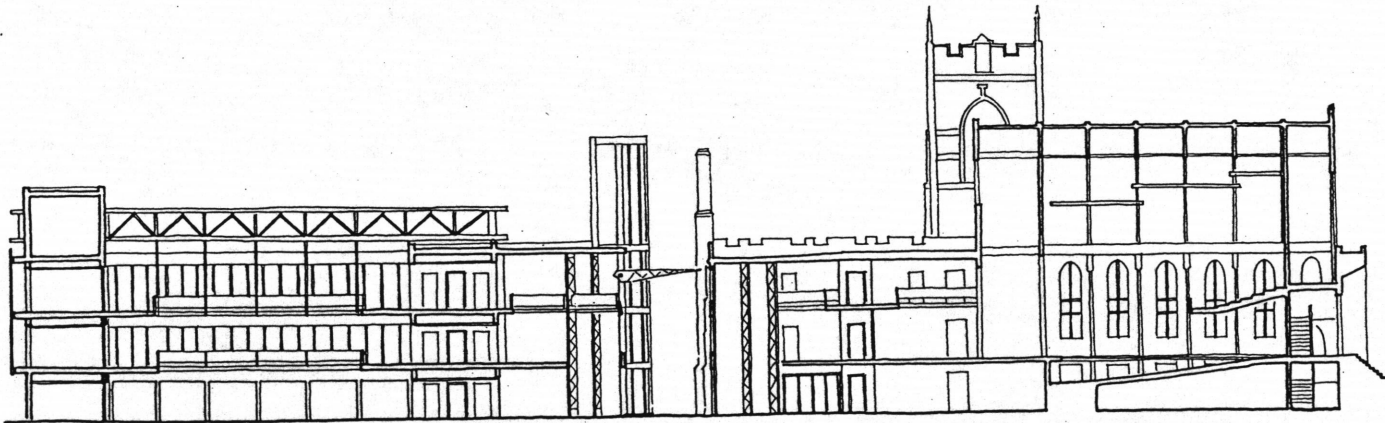

MAIN SECTION

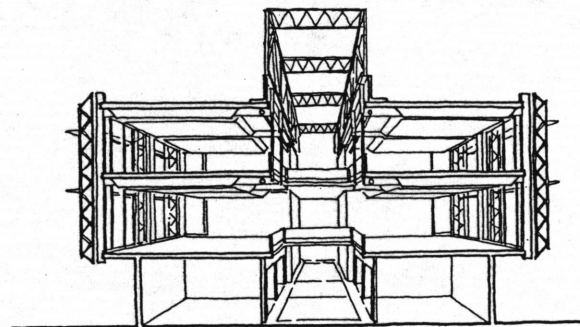

CROSS SECTION

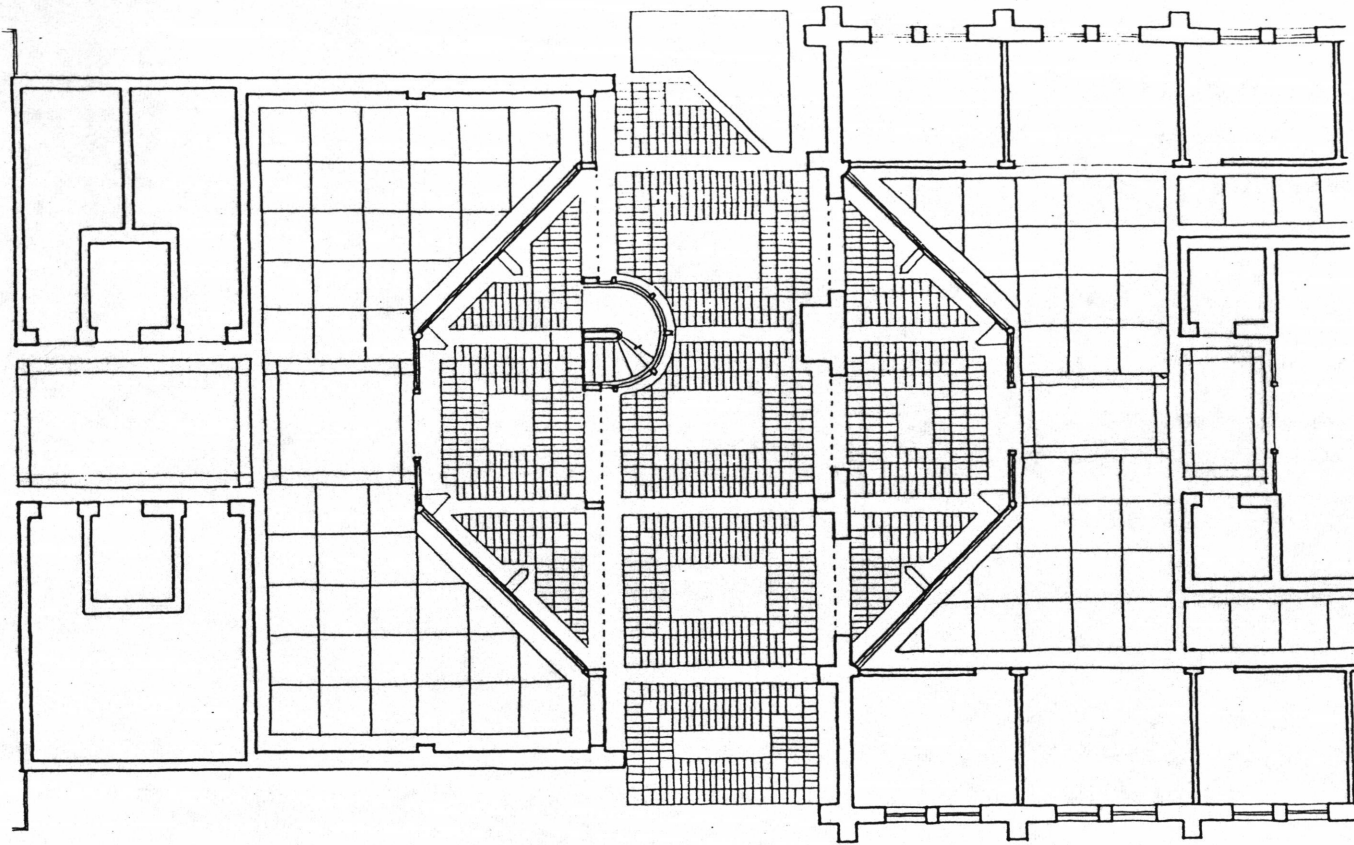

JUNCTION PLAN

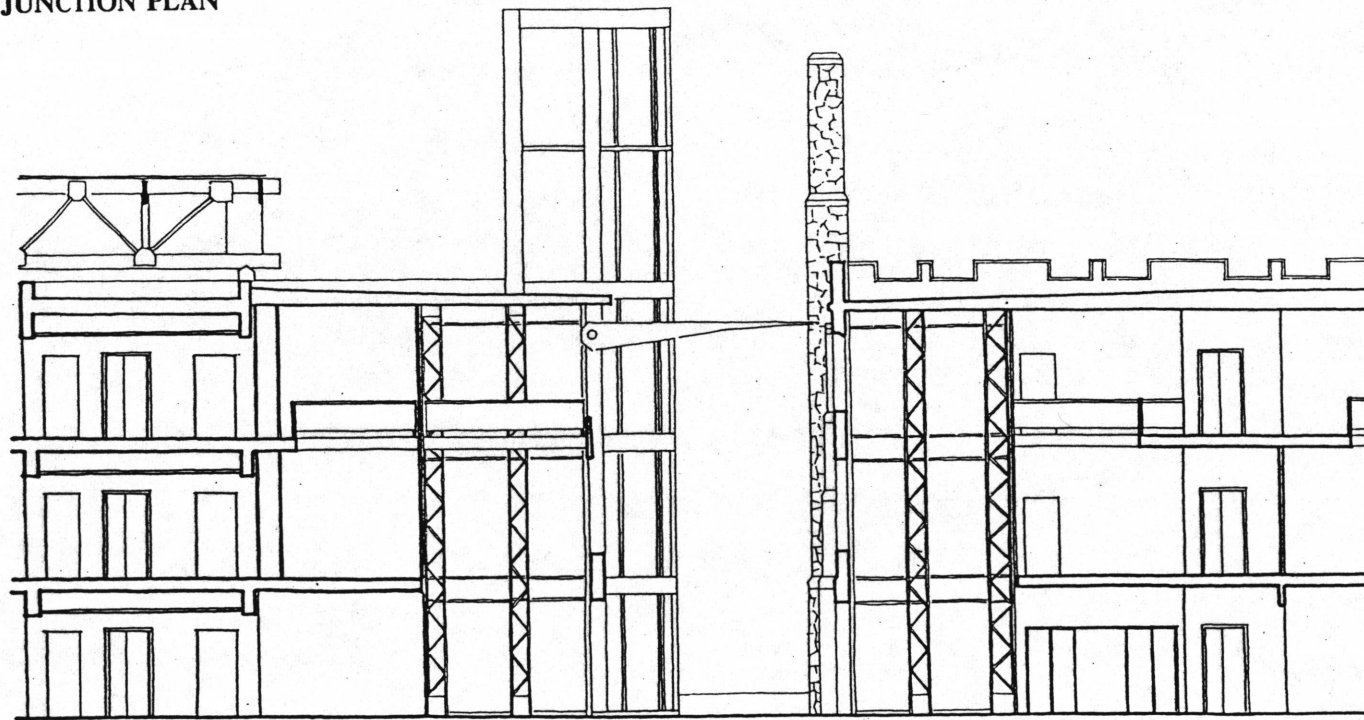

JUNCTION SECTION

THE LINKAGE

The two buildings are discontinued visually, but the junction is the space to provide the linkage between the two structures. The junction is the transition zone between the outside and the inside of the building, and the entry distribution volume between the two building functions. As such it is capable of responding to the changing environmental conditions. Three mechanical retractable roof planes allow shade and cover when desirable, making the volume an adjustable and dynamic one. The geometry of the plan is derived from the extension of the cross axial bridge connecting the lobby annex to the main complex and the core axis of the two buildings. Further triangulation forms a regular octagon. This shape is then stronger, like the couple between two railroad cars.



JUNCTION PERSPECTIVE

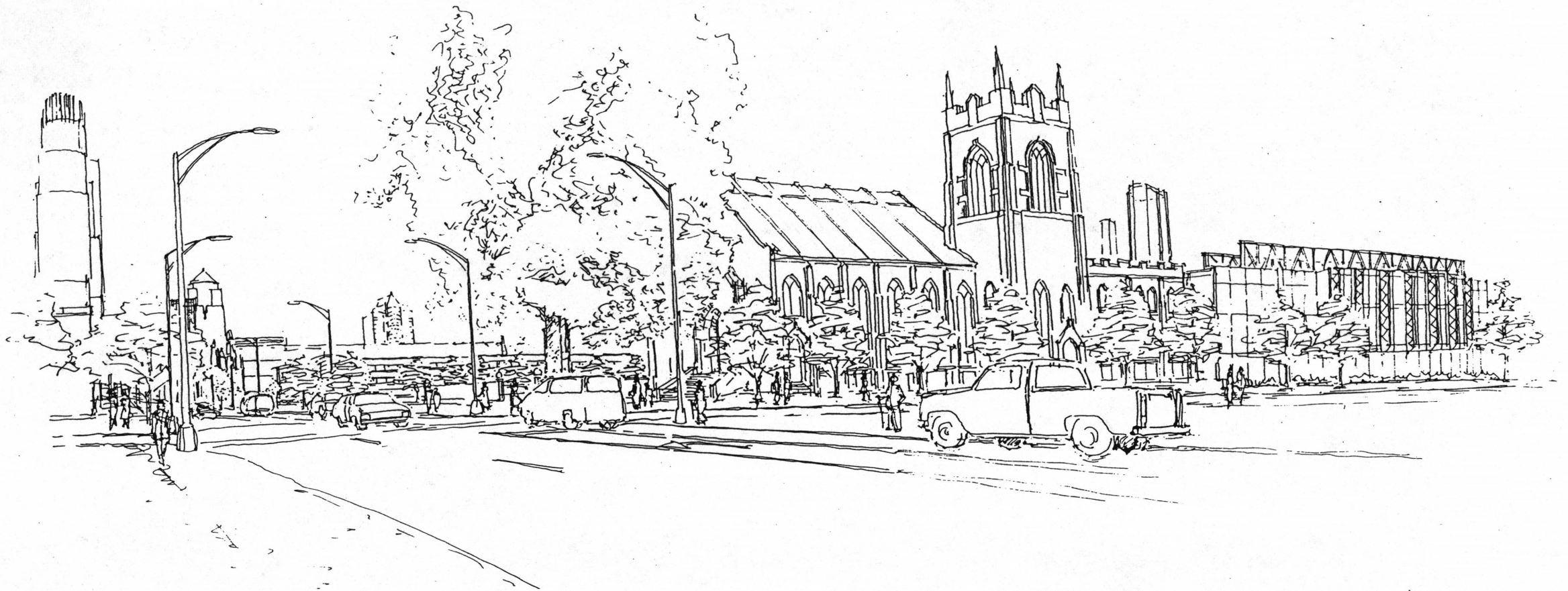

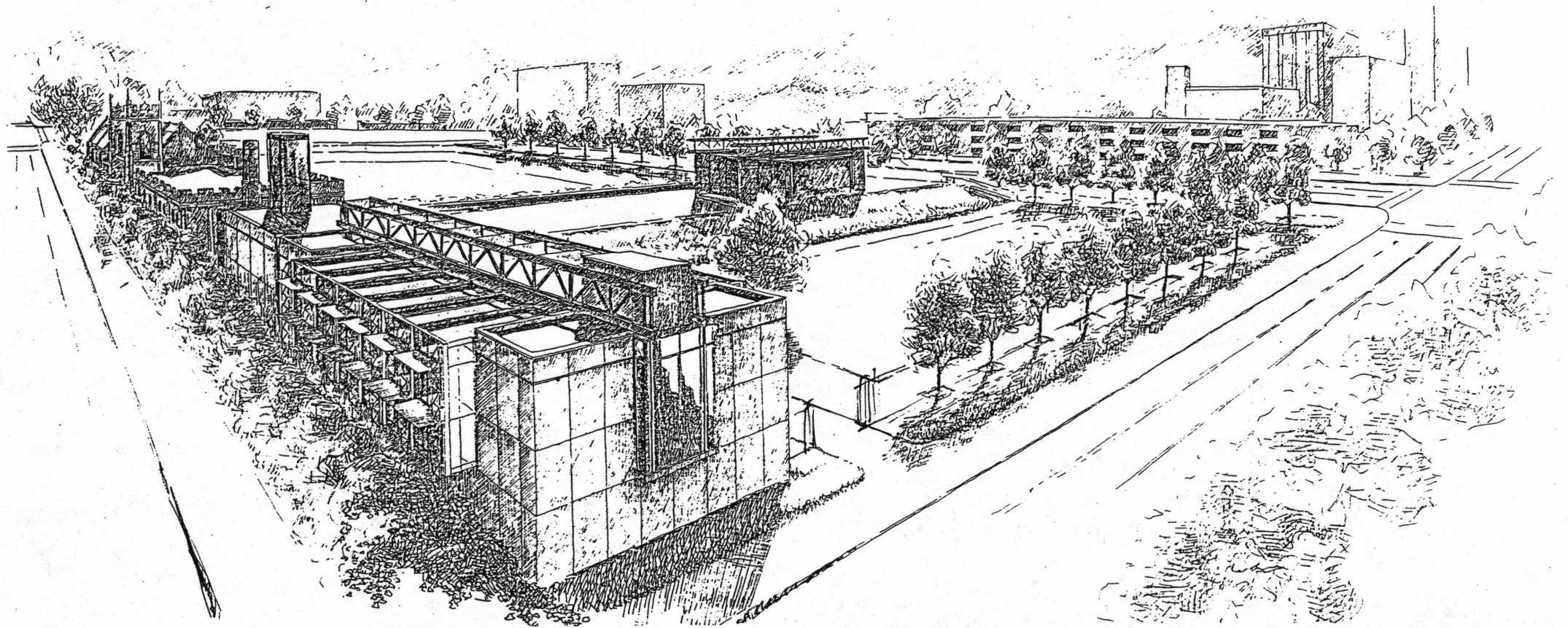
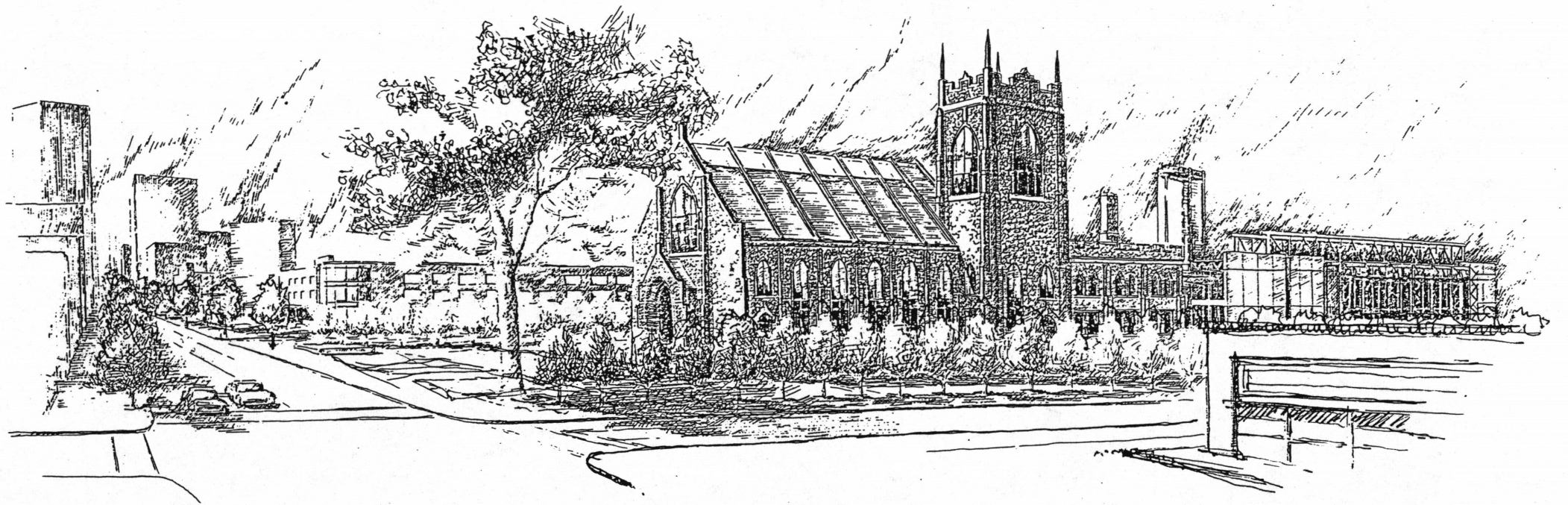

SUMMARY AND EVALUATION

New property development in American urban areas is rapidly depleting cities' inventories of older and often historic structures. This is leaving an urban core devoid of the richness and diversity that is characteristic of vibrant city centers around the world. Through historic property redevelopment, a city's visual environment can be retained and enriched. Defining and preserving various layers of history will provide markers of time against which newer layers can be applied.

The approach to historic property redevelopment presented in this book is neither renovation nor replacement, instead it proposes the re-incorporation of an older existing building into a newer building. Each of them can then become a portion of a new complex.

In terms of aesthetic and physical composition, the establishment of a formal dialogue between the older and newer structures is crucial to the synthesis of a new scheme. The success of a re-integration would depend largely on the appropriate level of the dialogue between the new and the old.

Thoroughly understanding the formal character of an existing structure is essential for the creation of dialogue. Since the overall dimension perceived from the composition of height, length, and width provides the initial visual impact, by adding a newer mass of equalized proportion adjacent to the existing one, the first step toward achieving a dialogue of formal compatibility is realized (fig. 1). Upon this foundation, other issues of geometry, spatial order, technology and building materials can all be investigated to develop the dialogue much further.

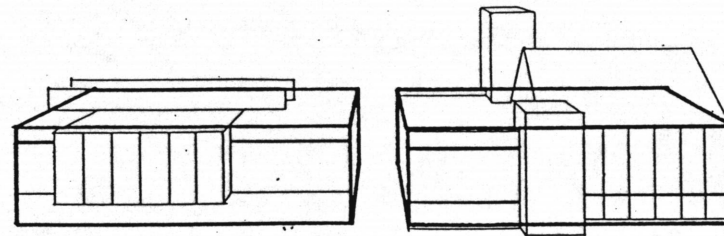

Figure 1

However, there are times when the old building does not have a general form or basic configuration, and its overall dimension is not so easily perceptible. Then this initial visual impact of mass becomes insignificant. For example, excluding the towers and the pitched roof, the FRB church has a basic body form that is barely noticeable, even though

it is balanced by a new proportional mass; evidently, without other elements of relationship, this alone will not be enough to stand for the dialogue.

The geometric composition of the building facades is one of the main elements for achieving a good contrast. The superimposition of a smaller vertical rectangle on a larger horizontal main rectangle is the premise of the existing structure facade composition, by repeating the main rectangle of the new structure, an overall harmony can be maintained. Then the superimposition of a floating horizontal rectangle in the composition of the new structure allows for the contrast between the two facades (fig. 2).

The level of difficulty for the recognition of the basic configuration of existing facade composition is related to the complexity of the facade itself. Therefore, for a building with a complicated facade, it may not be realistic to develop a simple facade relationship. The FRB church, however, has a fairly simple facade. Its basic rectangular shapes, uniform material, single cornice, and base lines provide all the opportunities for establishing a dialogue. Eventhough the projected elements may not be the same size, the general idea is captured.

The six part segmentation of the new building's cantilevered bay is the response to the rhythmic division of the main section of the existing sanctuary (fig. 3). Echoing the proportion and scale utilized in the old composition maintains the compatibility. Nevertheless, the exposed steel structure and large glass panels of the bay represent the newer technology in contrast to the expressed masonry and stained glass cathedral windows of the older structure.

Recognizing the rudiments of the existing facade is the key principle. There could be opening patterns, material or color specifications, column shapes, articulations of the wall, or other elements to generate a dialogue; yet the transformation of a feature on the new structure is the key to the success of the dialogue. The feature element of the FRB church, besides the bell tower, is the six bay cathedral windows. Maintaining the rhythm and extending the glass window to the full height of two floors on the new structure

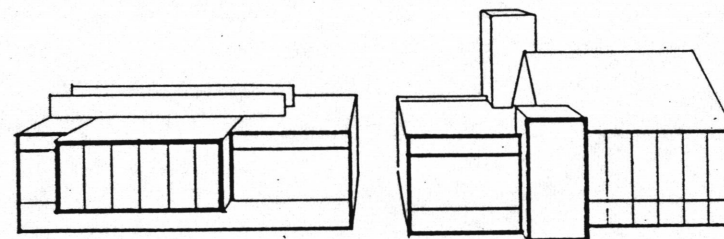

Figure 2

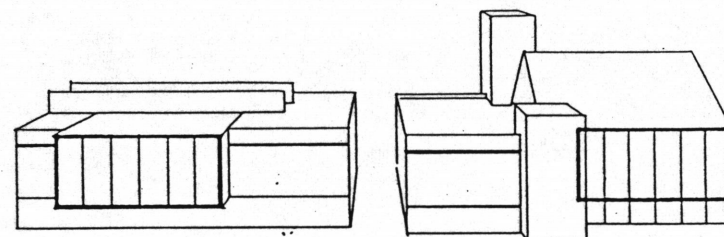

Figure 3

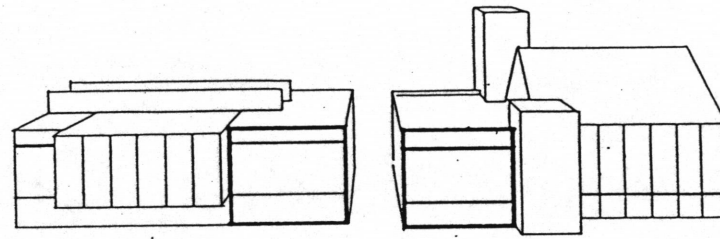

Figure 4

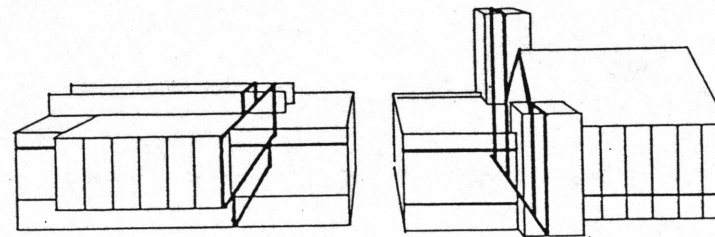

Figure 5

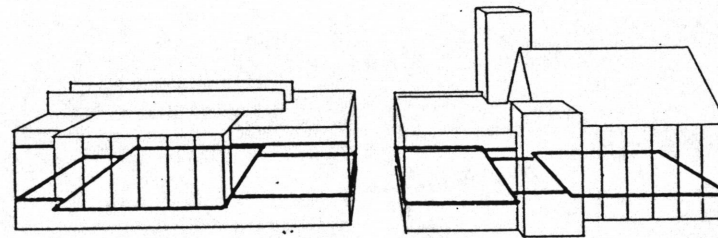

Figure 6

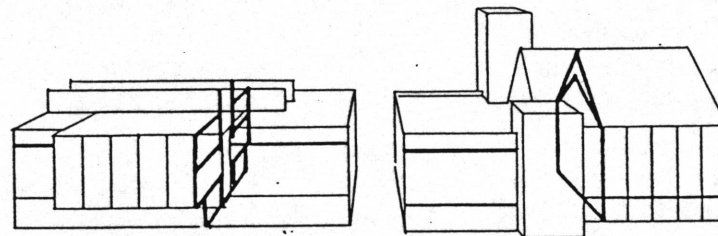

Figure 7

may be a proper interpretation for a compatible contrast.

Framing the entry separation of the two structures with an identical geometric composition allowed a visual cue that there was something special happening between the two forms in the area of the "slice" (fig. 4). The resultant symmetrical alignments in materials, base, and cornice lines give a regular, constant, and stable appearance. However, the punched window openings, expressed columns, and random masonry joints of the older facade and the smooth, solid flat panel construction of the newer facade brought out an intimate contrast at the pedestrian scale.

A visually compatible entry separation will lead to visually compatible facades. However, the separation is not a formula for all old buildings because it only happens when the entrance is separating the two structures. Even if it does happen like the FRB church, the contrast and alignment alone will not be able to carry the full responsibility of the dialogue.

While exterior appearance presents the first visual impact, and provides sectional composition, spatial order, and structural delineation, an equally compatible contrast will create another dimension between the old and new structures. In the new building, the pattern of the three rectilinear shapes of the cross section stacked horizontally on top of each other is in contrast with the section pattern of the old building where three shapes were lined up side by side, vertically (fig. 5). The spatial order is reflected on the overall geometric composition of the main floor plan, where the new building's order is developed as a narrow-wide-narrow assembly in response to the wide-narrow-wide order of the old building (fig. 6). To represent and expose the modern technology, the new building was composed of a suspended steel structure at the bay in order to create a column free main floor activity hall in contrast with the traditional post and beam structure of the old building (fig. 7), while extending the integrity of the exposed church structure to the new building.

Neither sectional composition nor spatial order will provide much visual comparison. Besides providing certain architectural references, it is almost impossible for one to experience these hidden variations. The structural

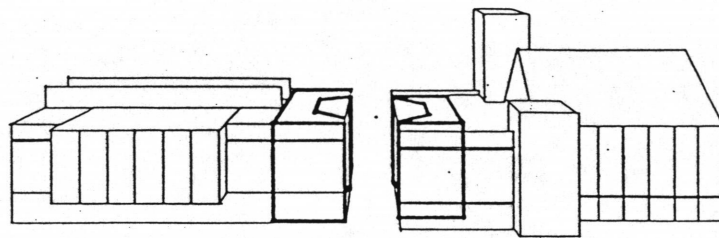

Figure 8

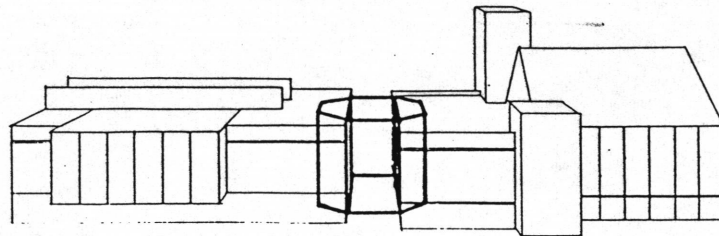

Figure 9

delineation, however, will be able to provide opportunities for extended comparison. That is because the older buildings usually are very typically constructed with structure exposed even though some extensively detailed elements may be involved. The FRB church is a good example of this construction. Its exposed columns indicate the traditional post and beam structure. By developing a solid, poured in place concrete wall and a modern construction of a suspended main bay, further contrast is realized.

There is a Chinese proverb which describes a vivid sketch of a dragon: "Adding eyes properly will make the dragon alive." Instead of standing side by side with an entry in one building or the other, now the two buildings are face to face and a common ground is shared equally by both and owned by neither. By carving out a similarly shaped lobby volume from each structure at the facing end, the dialogue between the two is further symbolized and reinforced (fig. 8). The missing trapezoid shape at the lobby of both buildings combined with the central rectangular "slice" creates a regular octagon. This invisible object is not only to provide a transitional zone between the opened and the closed, but also to reinforce the concept of a dynamic linkage between the two buildings (fig. 9).

Creating a proper linkage is extremely important for the complex, since the two structures are not physically connected. Developing a face to face lobby space at each end of the structures not only reinforces the main entrance to the complex, but also increases the level of dialogue between the two buildings. The invisible octagonal space may not be perceived as a hitch, but once one is in the space, the similarities can be visualized at each sub-entry.

History's mark on a city should never be fully erased, it should instead be cared for and tended to like a garden. This visibility of the passage of time is one of the city's most vital treasures. Changing and replacing the contents are not the only means for growth.

A city's growth is truly the layering of time; and the past present, and future should be reinforced and felt by those walking down its streets.

PROGRAM

The complex is made of two parts

A. New structure

To house the Admin. and the Department of visual art.

Administration

Offices for secretary	1-2	units
Faculty office / Dean	2	units
Conference Room	1	unit

Art

Art studios/Review room	2-3	units
Printing	1	unit
Sculpture	1	unit
Sewing	1	unit
Pottery	1	unit
Workshop	1	unit
Review room	1	unit

Architecture

Studios / Review room	3	units
Lecture room	1	unit

General

Rest Rooms

Mechanical

Storage

Circulation

B. Old Structure

To house the department of performing arts.

Music

Vocal and instrument		
Practice	6	units
Performing		
Studio / Dressing	6	units
Lecture Room	2	units
Shop	2	units
General		
Office	2	units

Rest Rooms

Storage

Circulation

Auditorium

Seating for 500
(both levels)

Rest Rooms

Break Room

BIBLIOGRAPHY

1. Old and New Architecture: Design Relationship
National Trust for Historic Preservation. 1980
2. Annapolis Historic District Design Guidelines for New Construction
Robert Lamb Hart. Architects and Planners. 1979
3. Renovation Awards. 1980-87
4. Contemporary Design in a Historic Context
John W. Lawrence. Historic Preservation.
Jan-Mar 1971
5. Commercial Renovation 1981-87