

THE MORPHOLOGY OF PLACE

by

O. L. Tom Thompson

thesis submitted to the faculty of the
Virginia Polytechnic Institute and State University
in partial fulfillment of the requirements for the degree of

Master of Architecture

approved

William W. Brown, Chairman

Benjamin Evans

Thomas A. Koontz

Michael J. O'Brien

Blacksburg, Virginia

August, 1992

Whatever space and time mean,
place and occasion mean more.
For space in the image of man is place,
and time in the image of man is occasion.

-- Aldo Van Eyck, 1962

THE MORPHOLOGY OF PLACE

acknowledgments	iv
introduction	1
a place along the New River	3
the site	4
the project	5
conclusions	27
abstract	28
bibliography	29
vita	30

to for your faith and support

and to for your love and understanding

introduction

Just as each snowflake that falls to earth has its own unique structure and appearance, so it is that no two places where people build are identical. While the structure and features of a site may not always be distinctive, the perceptions and experiences related to them are unique. It is this consciousness that gives a site a certain exclusiveness, a special quality that can be called sense of place.

In his book "Form and Purpose", Moshe Safdie examines the duality of the architecture of Jerusalem, a city that, until the Six Day War of 1967, was divided by concrete walls and barbed wire. He writes:

Here were two communities, each built at the same time, and two housing solutions. On one side there was a group of people, untrained and uneducated, who were dealing successfully by themselves with an environmental problem that directly concerned them. On the other side, there was a professional group, highly trained and sophisticated, backed by a social-welfare system, and having all the best intentions in the world -- and the result was an unacceptable environment. This posed a whole series of questions for me about the design process, questions that for many in our generation have become important issues. ¹

Safdie goes on to explain that the uneducated Palestinian refugees were successful because the environment they created expressed a sense of wholeness. They built houses, alleys and courts that adapted to the hilly topography and were sensitive to the surrounding environment. The responsiveness of the parts contributed to the making of a successful whole.



¹ Safdie, Moshe. Form and Purpose. Houghton Mifflin, Boston, 1982, p.23.

Christian Norberg-Schulz explores a similar idea in "Genius Loci." He writes of Kevin Lynch's concepts of spatial structure -- the node or landmark, path, edge and district -- as denoting "those elements which form the basis for men's orientation in space." ² Norberg-Schulz then expands this thought to say that the character of a place can be created by the "form and substance of the space-defining elements."

Upon these thoughts was based this project and design thesis: to develop a method of making architecture which, through order, structure, form and orientation embodies in its design the unique features of the region and the site.

As a means of developing this methodology, a site was chosen that exhibited unique physical features and a strong regional character. The connection between the building form and the elements of the site could thus be more easily perceived.

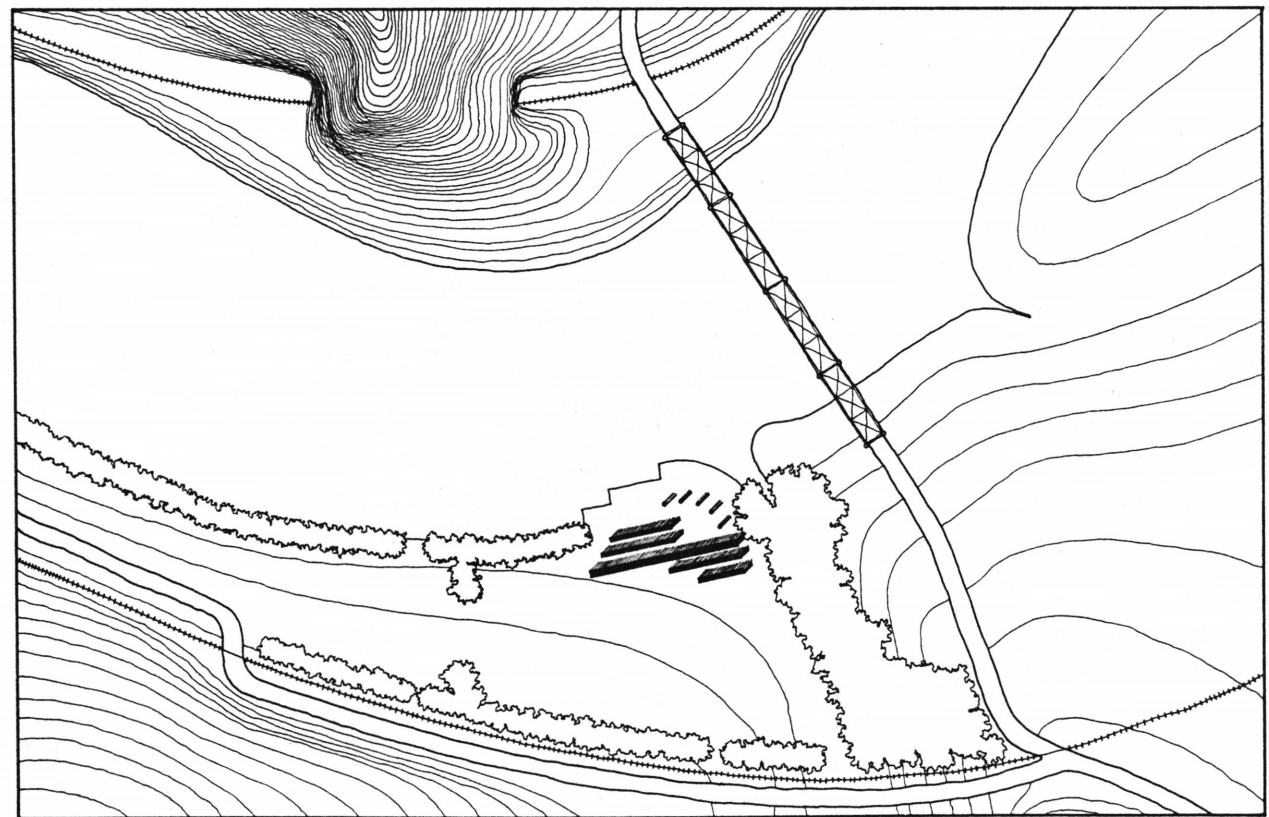
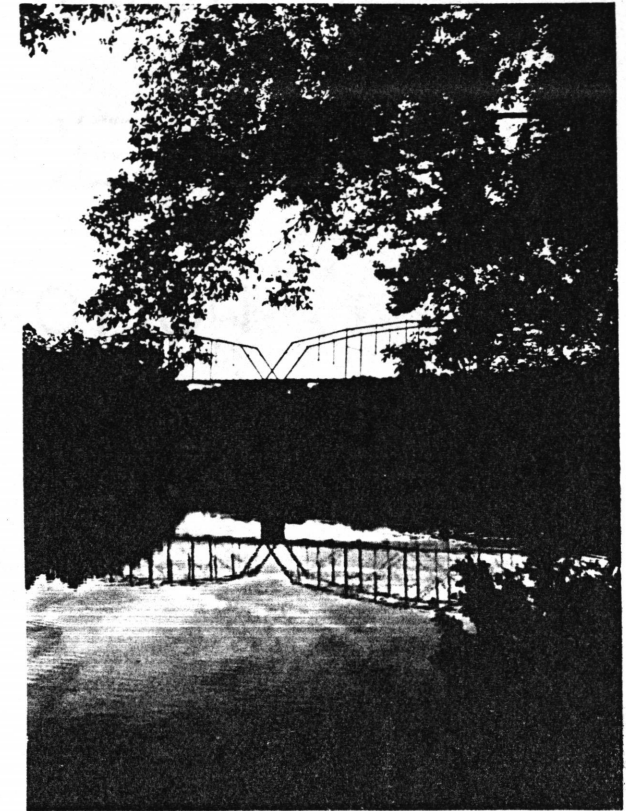
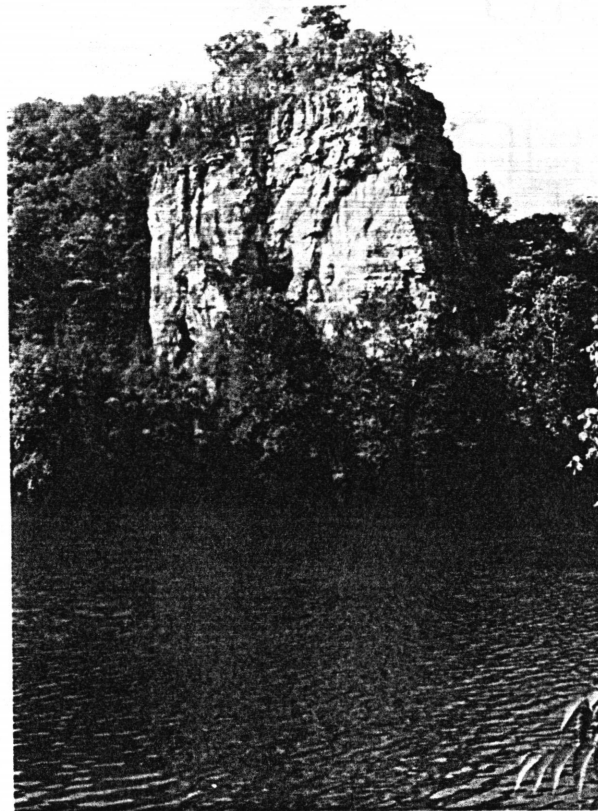

² Norberg-Schulz, Christian. *Genius Loci*. Rizzoli, New York, 1980, p.12.

a place along the New River

The New River of southwestern Virginia is among the world's oldest waterways. It had already found its course when the Blue Ridge Mountains grew up around it half a billion years ago. The banks rose steeply from the river basin, while the water continually carved away at their bases. Here was created a distinctive system of natural architecture, one of paths and walls. Paths of water, walls of stone.

Today, the New River is recognized for recreation more than any other use. So it is an appropriate task to make a place to fulfill this need, a place to be shared by people young and old, individuals and groups. A place where tube floaters, canoeists, waders and others can gather and enjoy the natural beauty of the New River Valley.

The objective of this project is to create a work of architecture that can bring people together along the river and offer to them a sense of place; a place that recalls the uniqueness of the region and its history; a place that is rooted in the earth, in harmony with the walls and paths of the river valley; an architecture that is based in nature and made with care; an architecture that, in the words of Aldo Van Eyck, "facilitates man's homecoming."

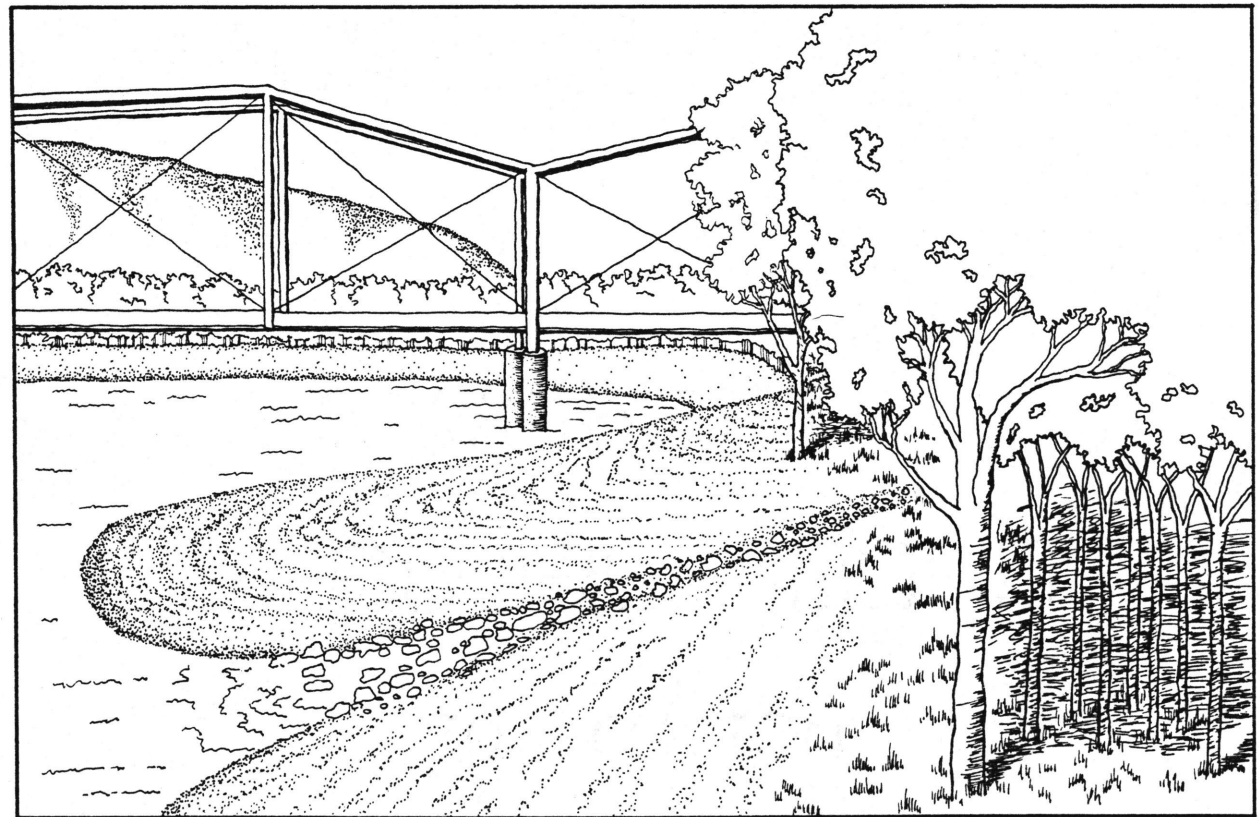

the site

The project site is a meadow located on the New River just outside the town of Pembroke, Virginia. It is bounded to the west by the river and to the east by a railroad line. To the north is Doe Creek, an intermittent stream, and to the south is a small grove of pear trees.

Across the river to the west is the most dominant natural feature of the area. Castle Rock is a bluff three hundred feet tall, carved out by the waters of time until it became a sheer cliff. In the morning hours the sun illuminates its face, revealing its structure – stratified layers of sediment, laid down grains at a time, then fused together by the force of gravity. In the evening the richness of this texture disappears, replaced by a vivid silhouette that casts its shadow across the water to the eastern bank.

Just to the north of Castle Rock is another strong reminder of the power of the river: one of the few bridges to span the New River in this area. Built in the early twentieth century, it is a lightweight, steel truss structure, resting on concrete columns which rise up from the rock bed beneath the water. Its presence as a connection between the two banks makes this place special, demonstrating the power of the river and the will with which man attempts to conquer it.

These two features, one natural and one manmade, attest to the strength and importance of the role played by the New River in this mountainous region. Their presence and structure became important factors in several decisions during the course of this project.

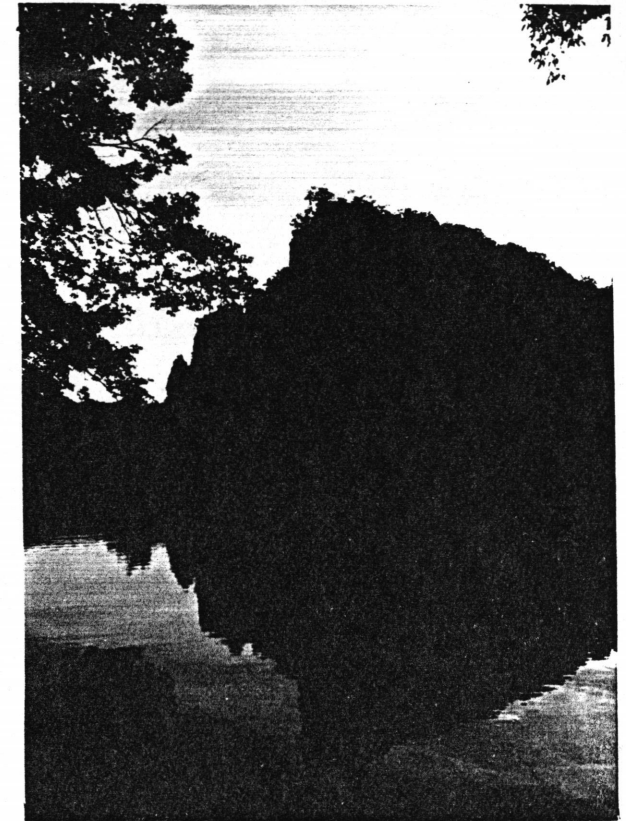
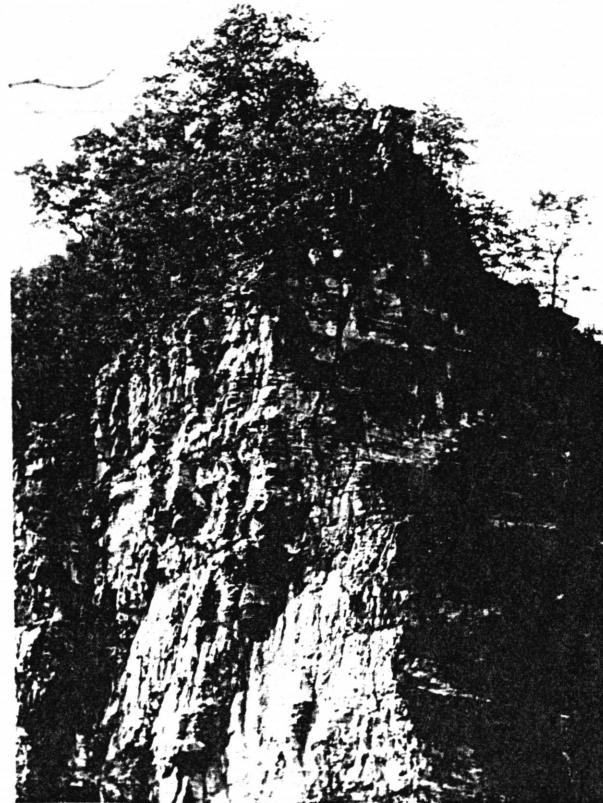

the project

Two important ideas were suggested by the site; the ideas of a path to the river and a gathering place along the edge. Architecture would order the path leading to the meeting place of the meadow and the river. Here would be the place where people would gather together to enjoy the water.

Along the river bank is a thick grove of trees that forms a visual barrier between the meadow and river. From the natural architecture of paths and walls came the primary elements and order of the project, a series of parallel walls that make a path leading to the river's edge and form a continuation of the natural wall. These load-bearing walls are cast in place, medium aggregate concrete. They are cast in layers eighteen inches deep and of varying aggregate types, placed on the site in a manner not unlike the way in which Castle Rock and its surroundings were formed.

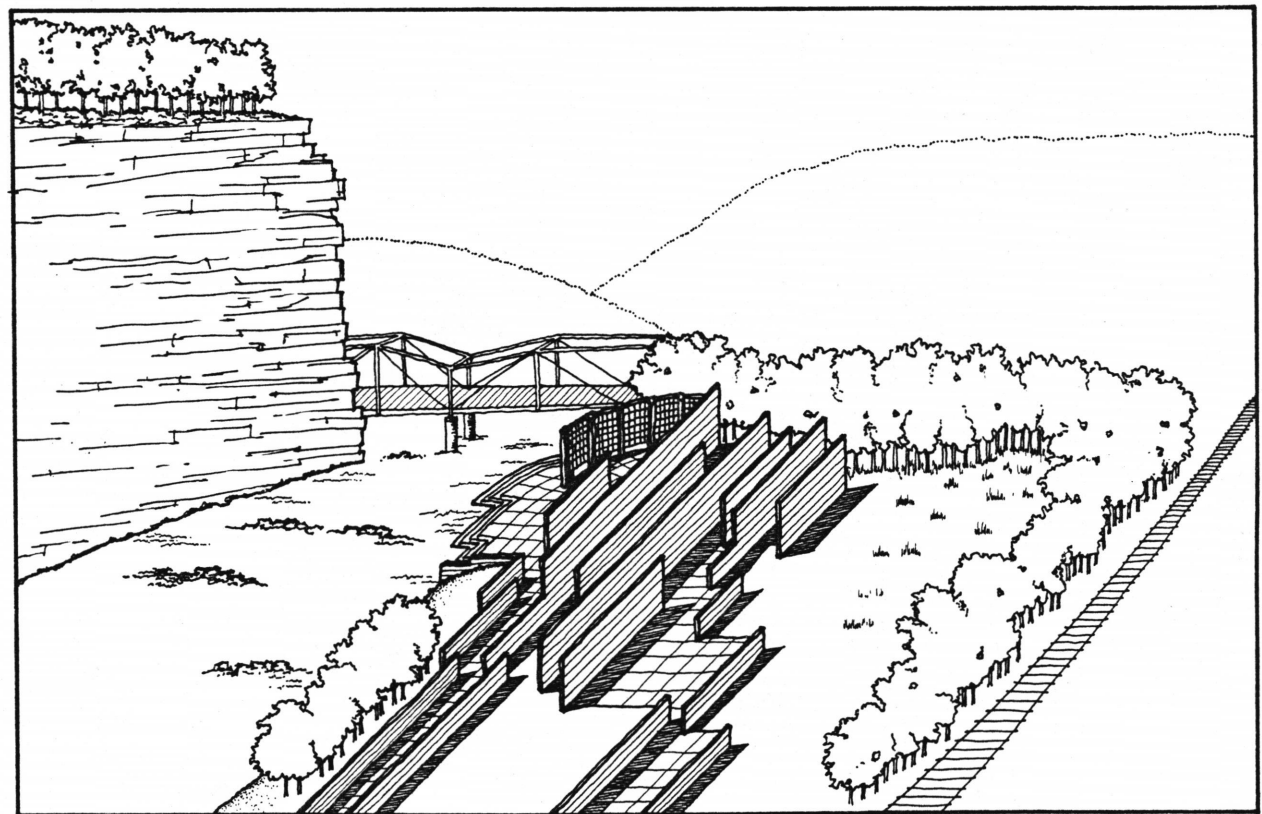
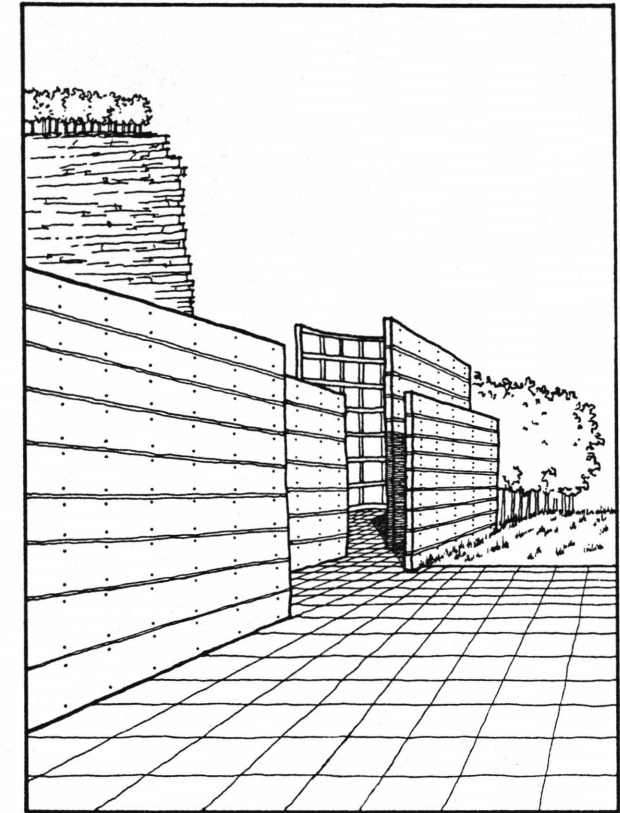
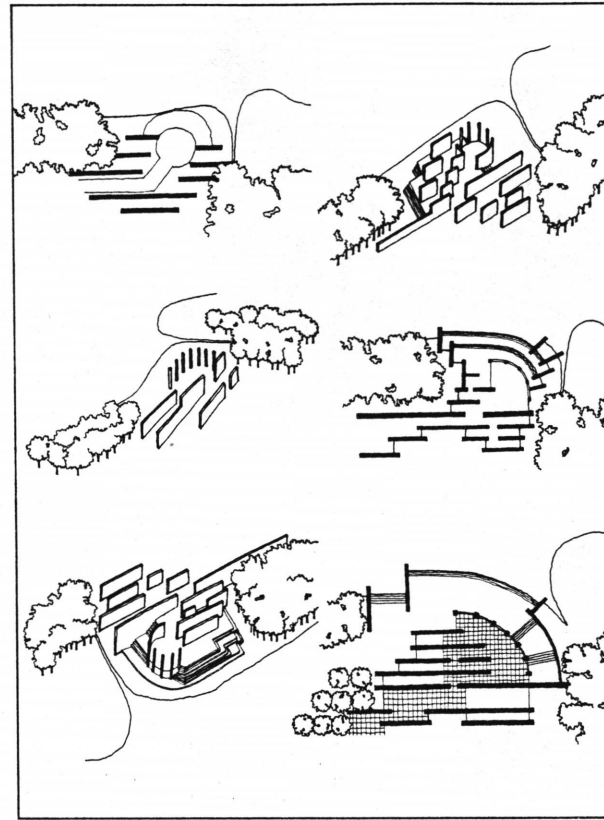

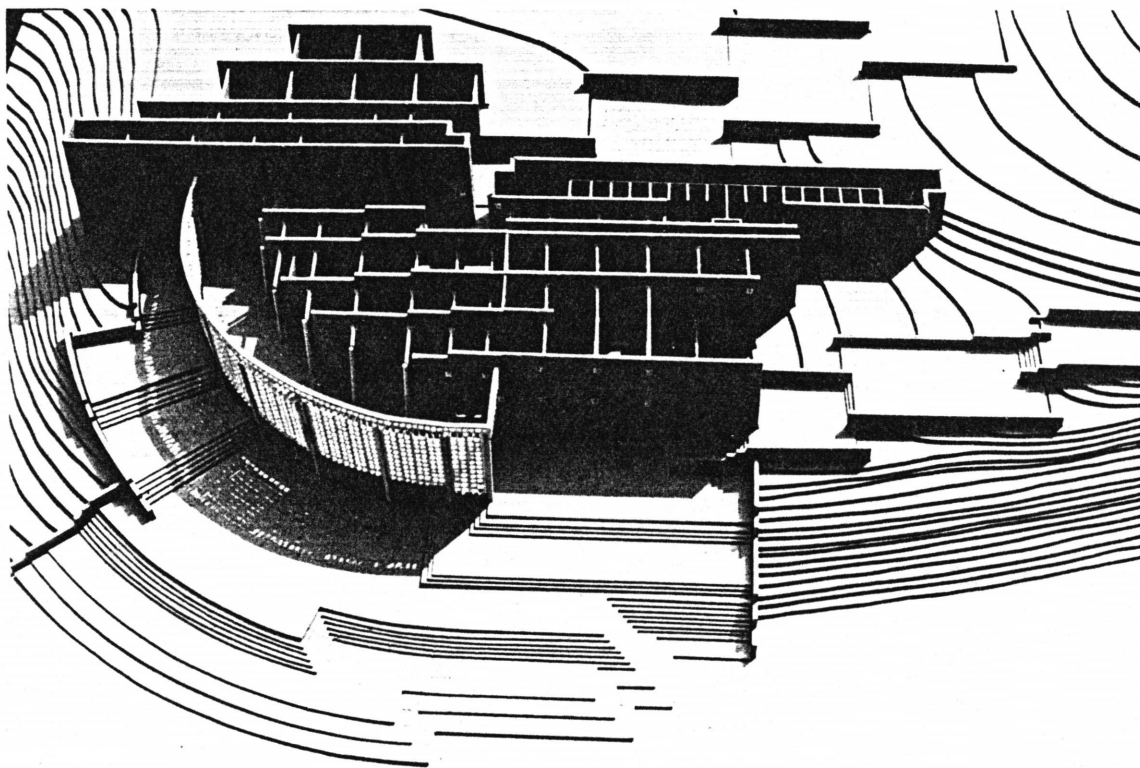
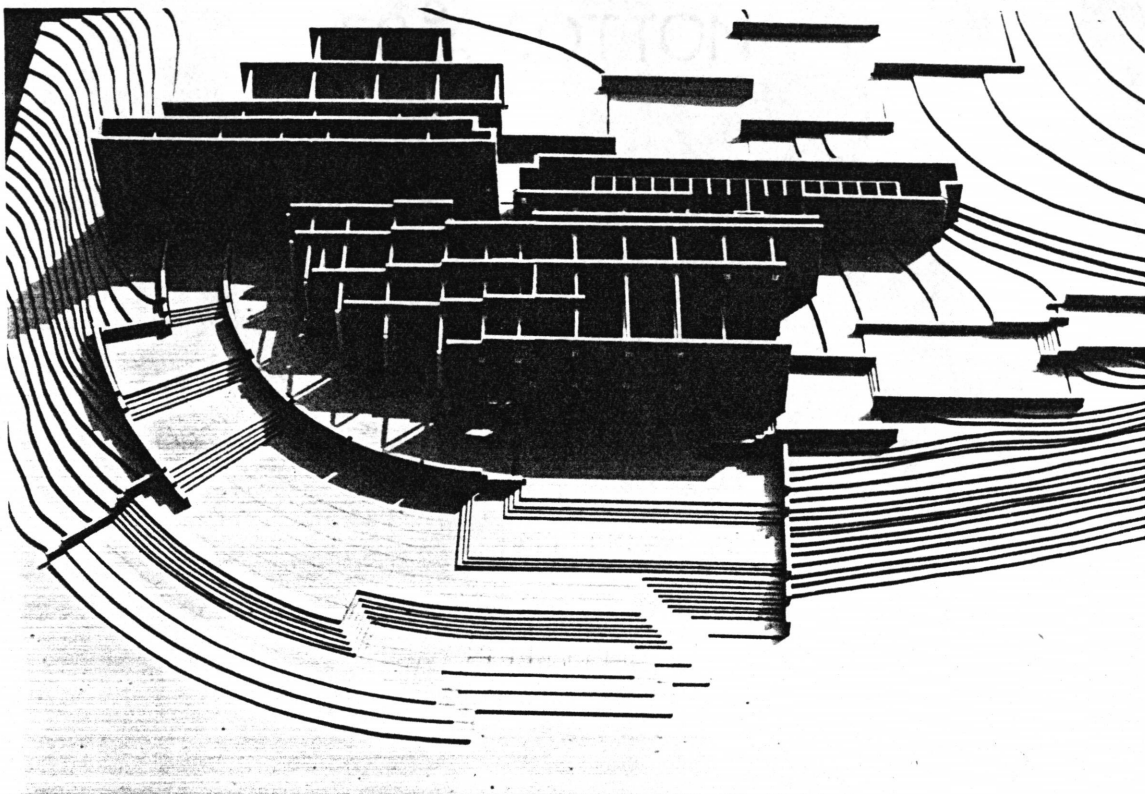

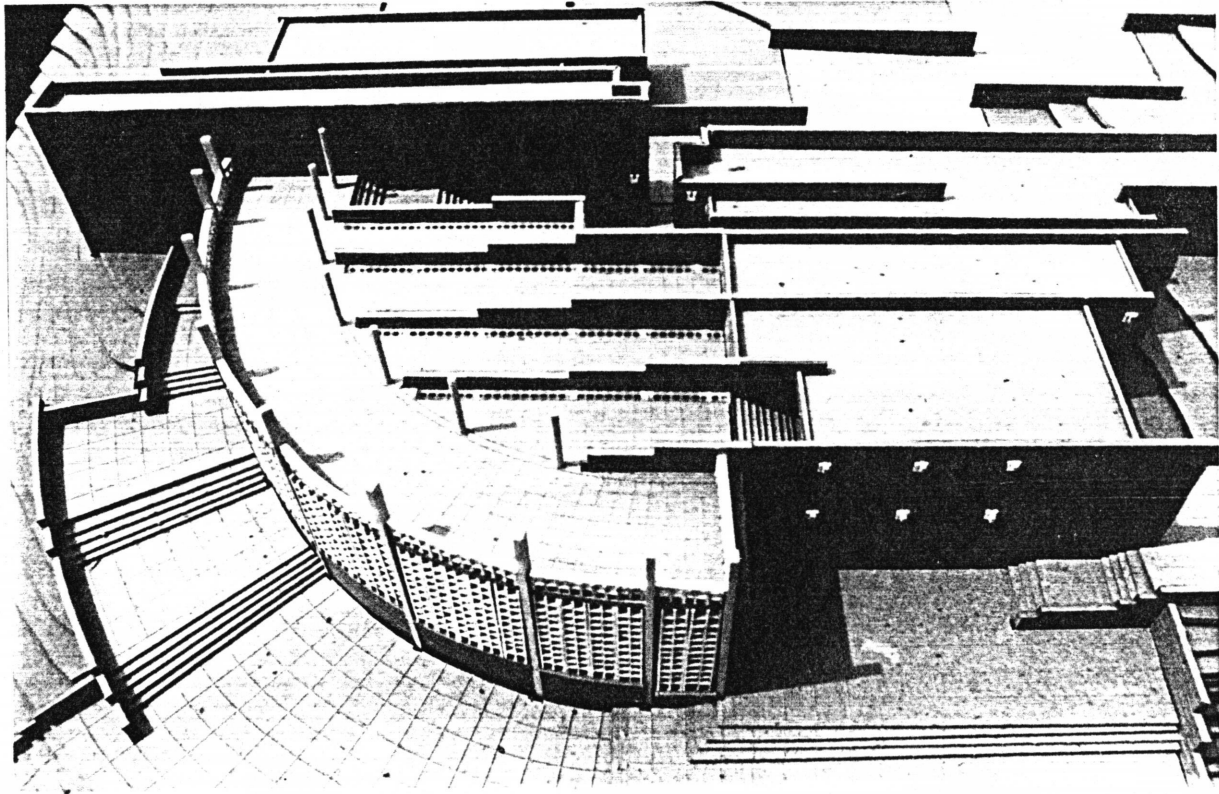
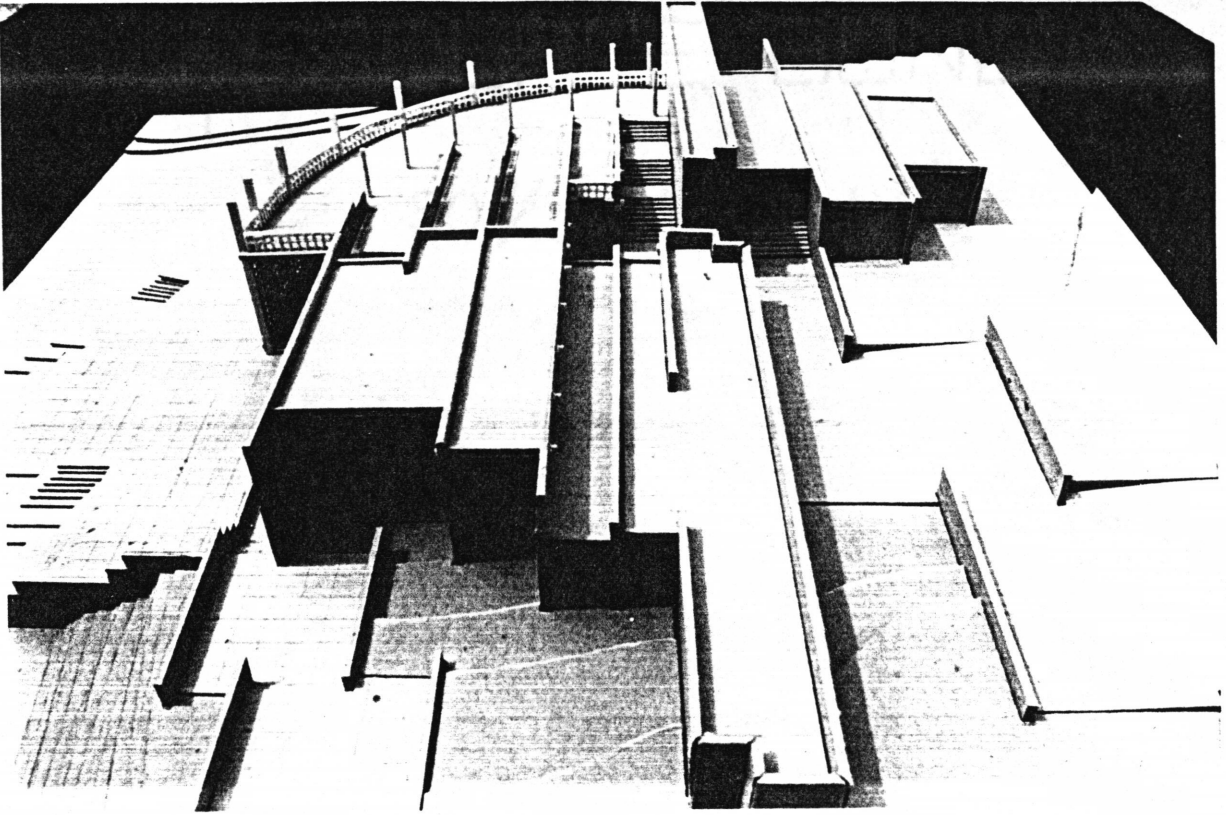

Supported by the cast walls are precast, fine aggregate, concrete beams, cradled in precast carriers that fit into the layers of the walls. The beams, in turn, support a concrete slab roof and second level terrace. Strips of glass block set in a concrete framework reinforce the presence of the walls, increasing the visual separation and independence of the walls and roof.

Between the parallel walls, the floor ramps down toward the river, encouraging an awareness of the slope of the land. The ramps wind back and forth, turning out toward the site and back in again, giving views first of the trees, then of the bridge and finally, of Castle Rock.

Partition walls are made of eight-inch, half-block, concrete masonry units in a stack bond. These provide shear strength for the cast concrete walls, as well as the division of space for rooms. Turning some of these blocks on edge allows for the introduction of air and daylight into the rooms.

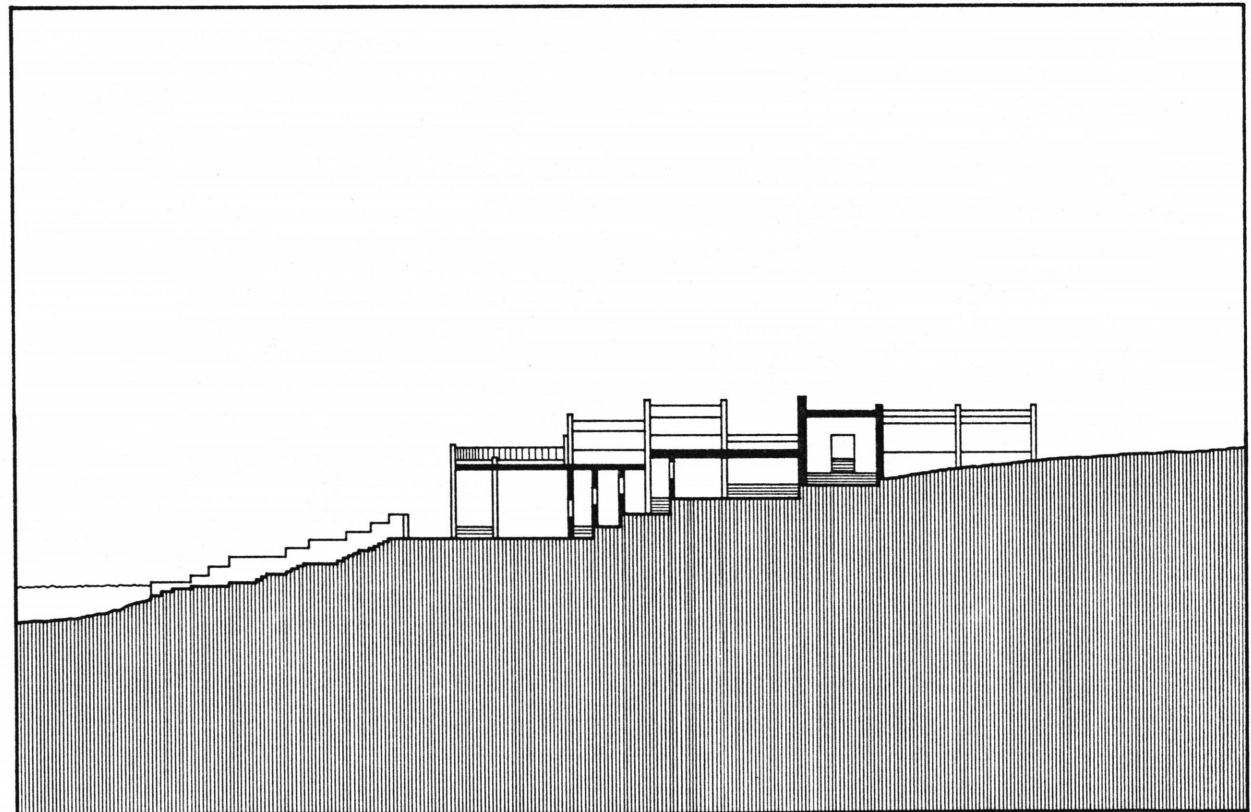
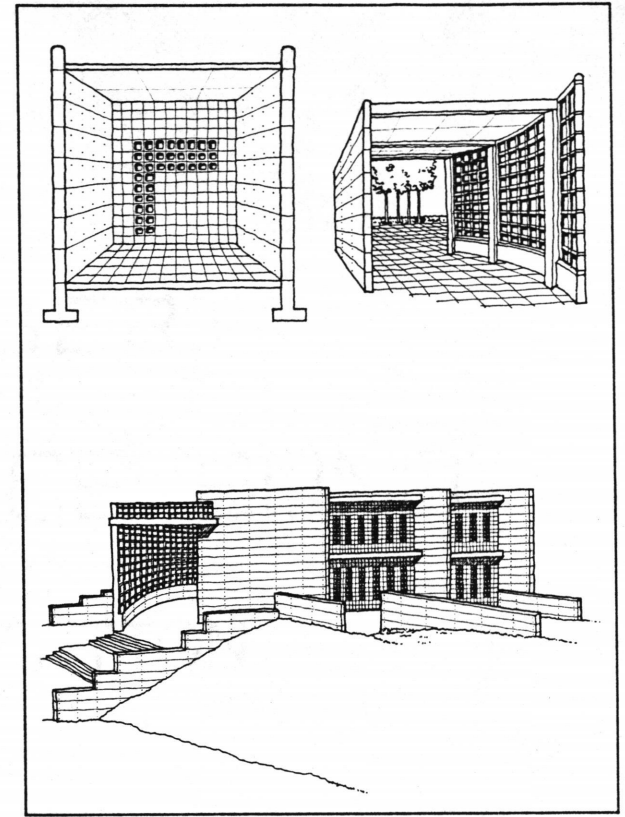
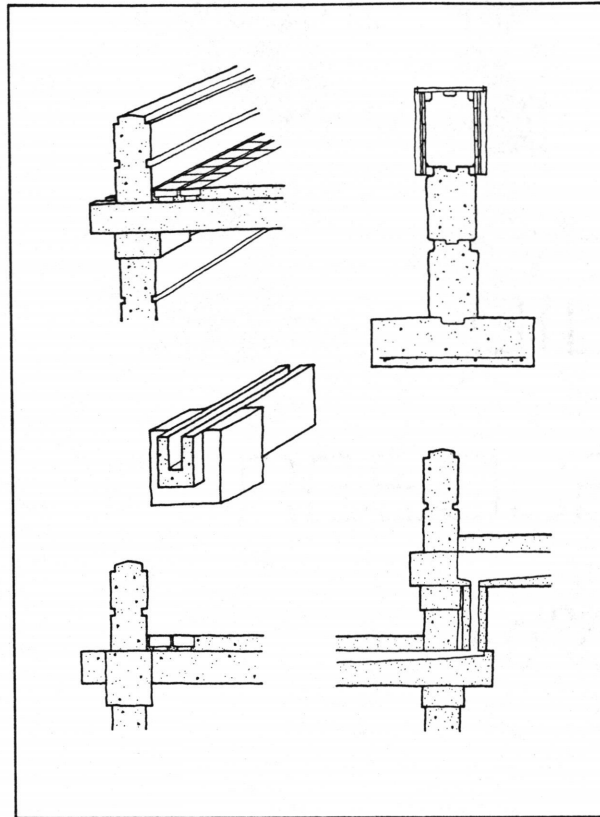

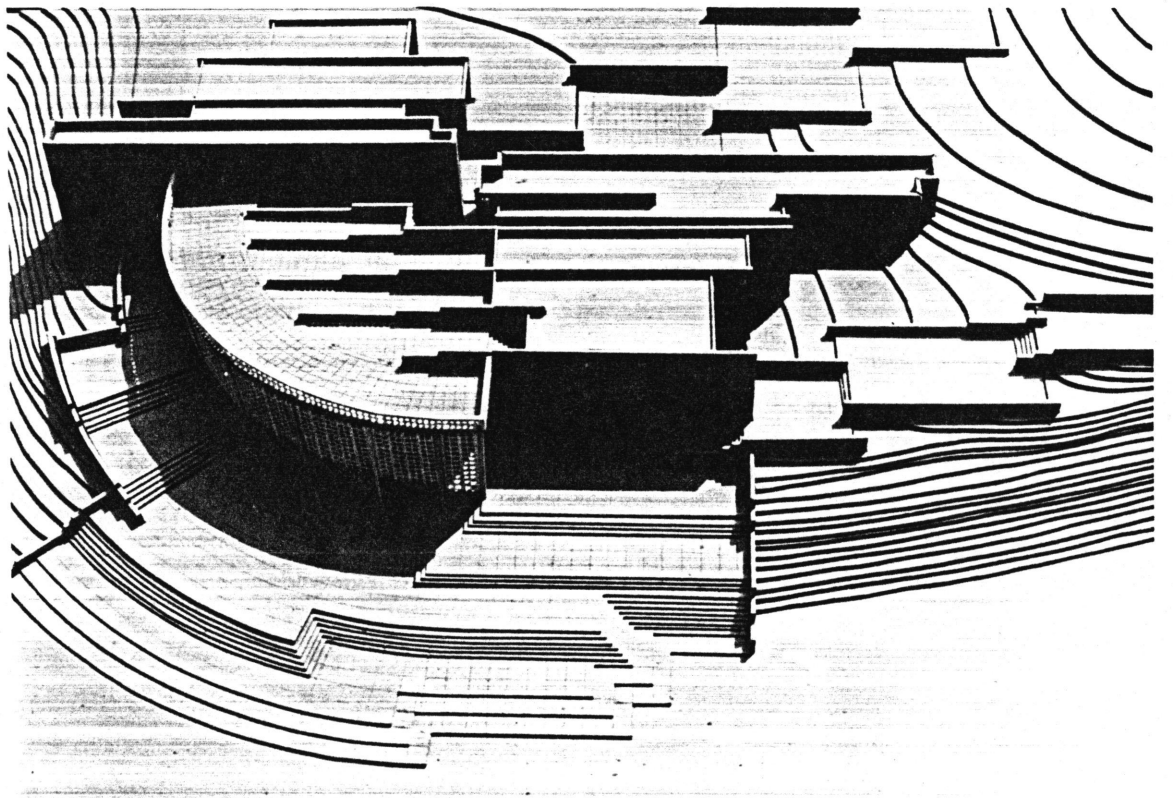
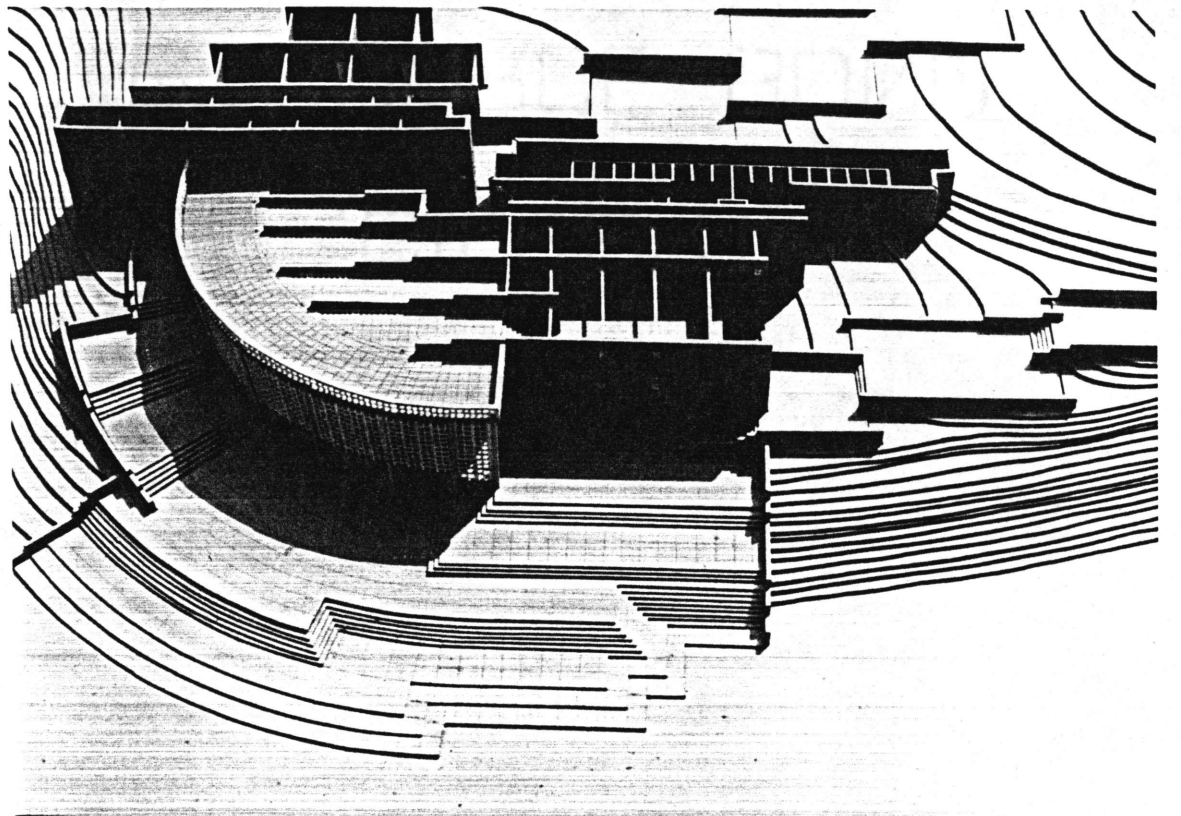

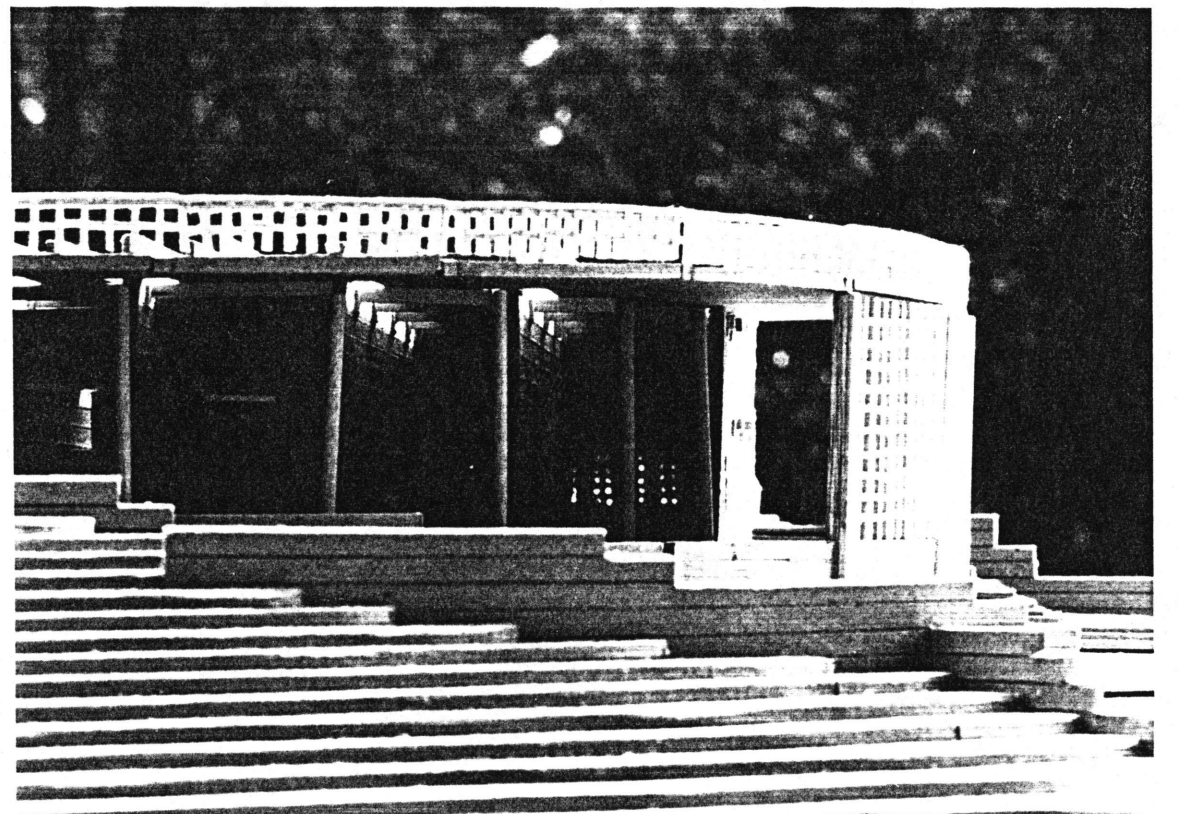
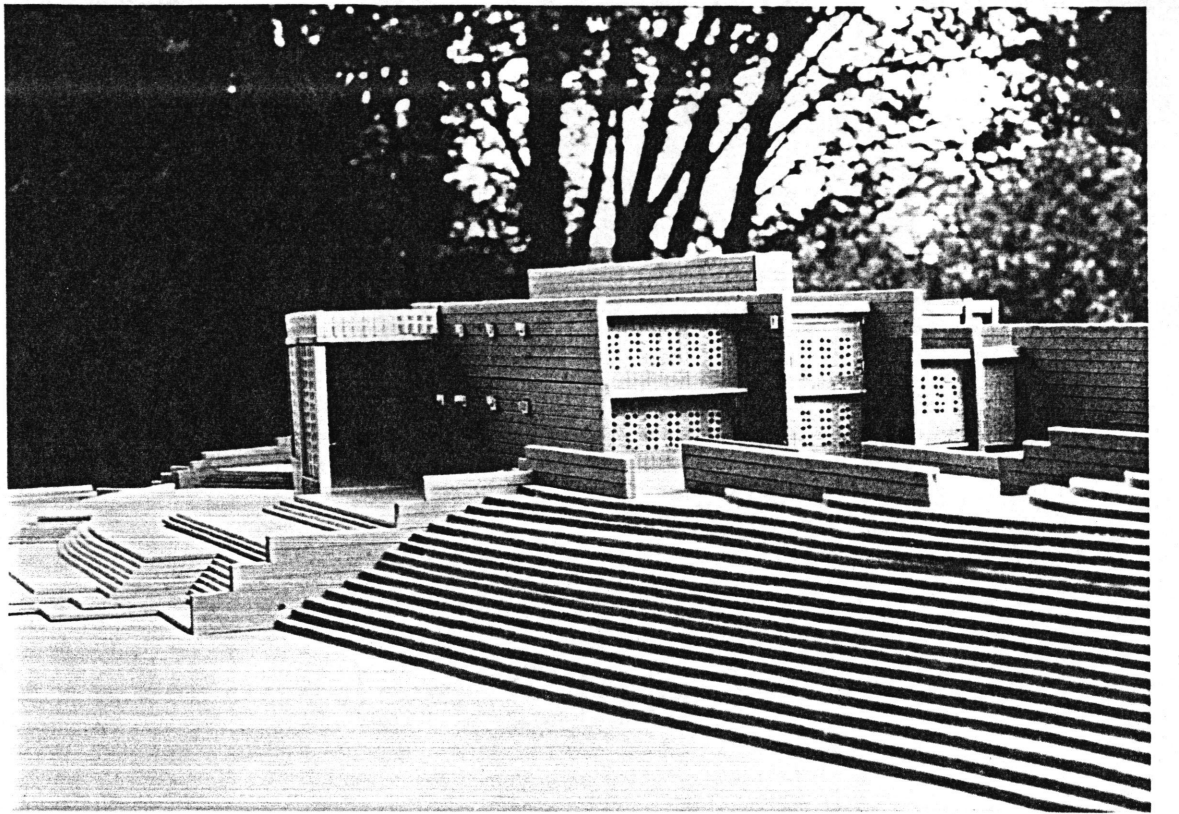

Terminating the path, and responding to the meeting place of Doe Creek with the river, is a curved, open egg-crate wall. Made of precast concrete sections that are tilted up into place, the wall forms a transparent layer between the path and the site and frames the views to the outside. On the second level it allows for an open terrace with commanding views of the surrounding valley.

The terminus of the path is the gathering place, a series of concrete platforms that reach out into the water. As the level of the river rises, the platforms disappear one at a time beneath the water, to reappear again when the river recedes, working in harmony with the dynamics of the river.

In the center of the platforms is a naturally filled pool of water. Rainwater from the roof and terrace flows through the beams into small collecting pools. From these collectors the water is channelled along the base of the curved wall, disappearing under tiles and cascading down concrete steps, until it reaches the large pool. When the pool fills, the water flows out over the last few platforms, making its way to the river, to begin the next leg of its never-ending journey.

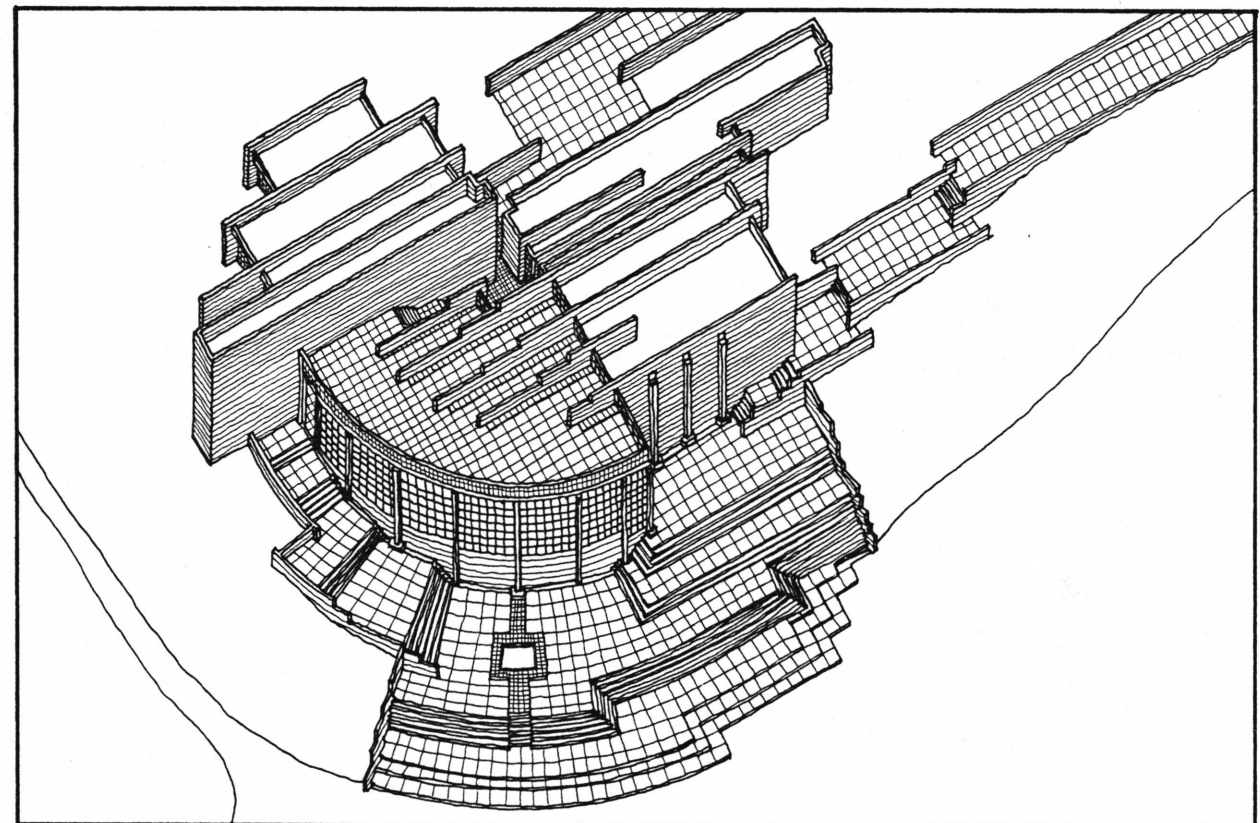
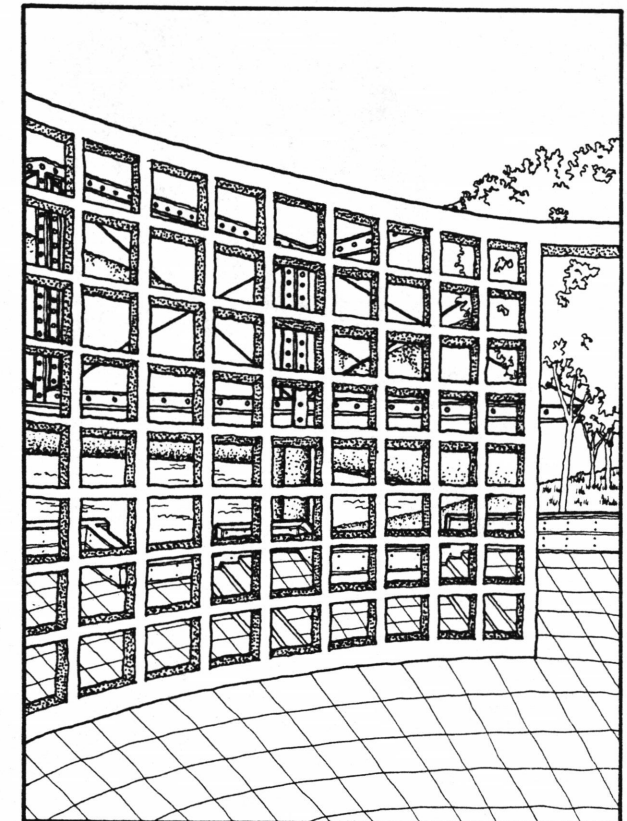
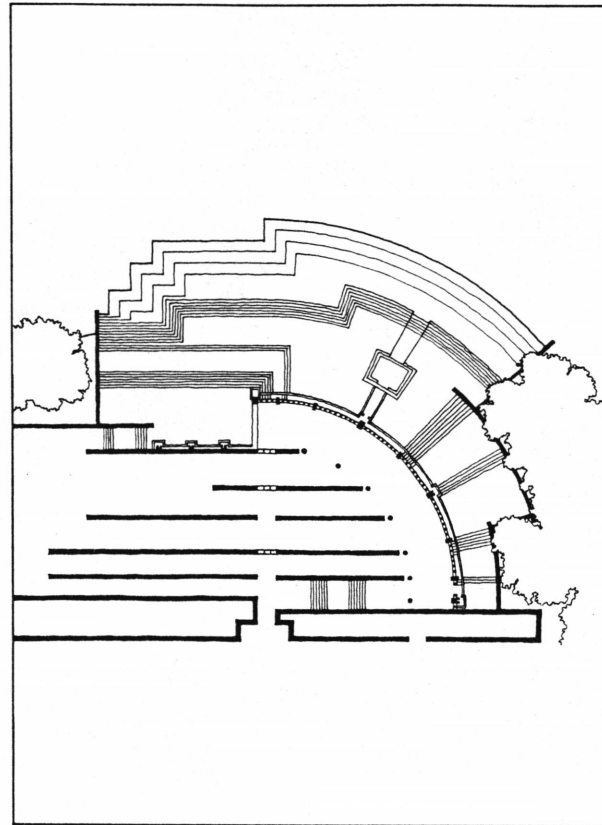

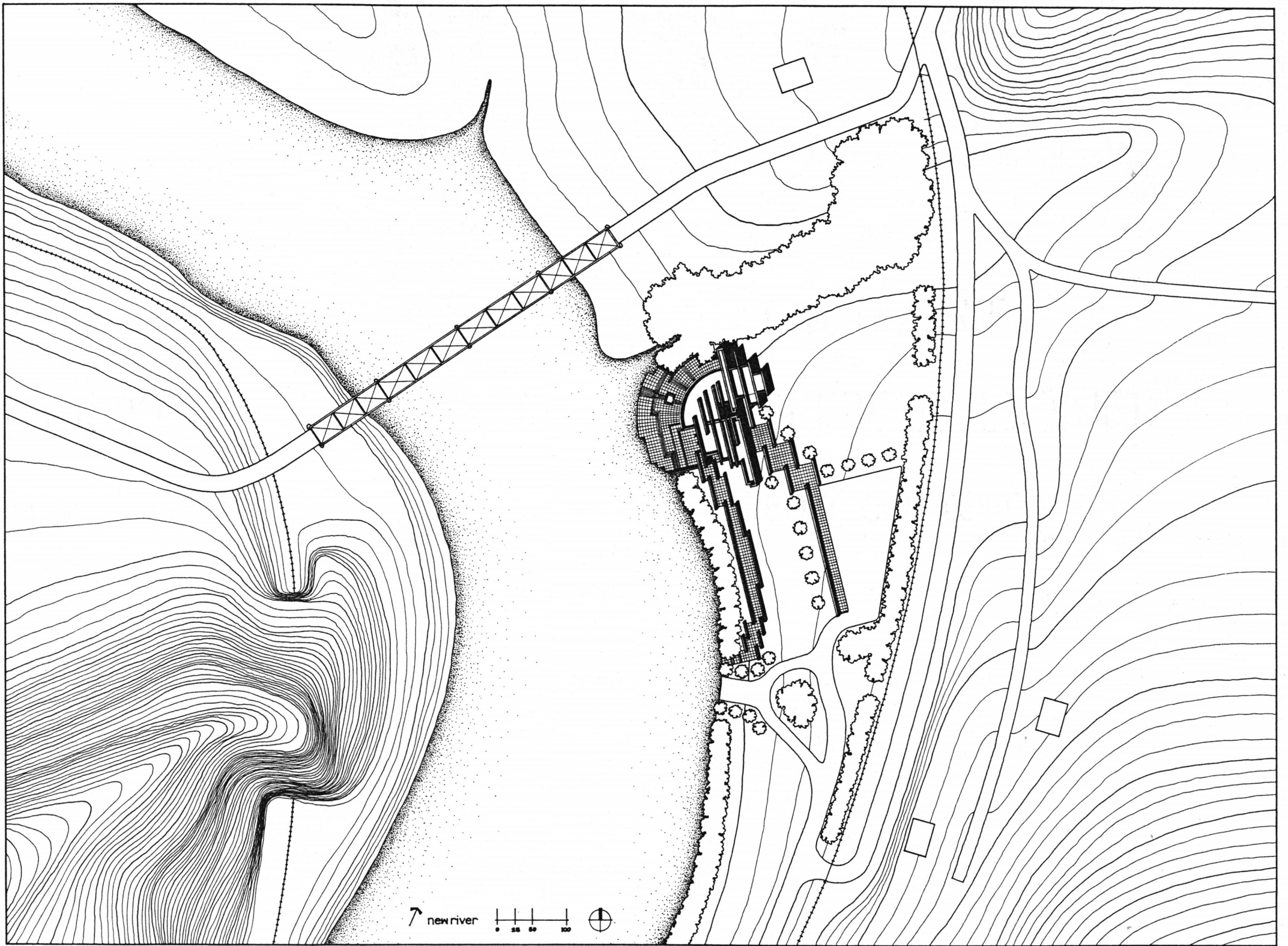

site plan

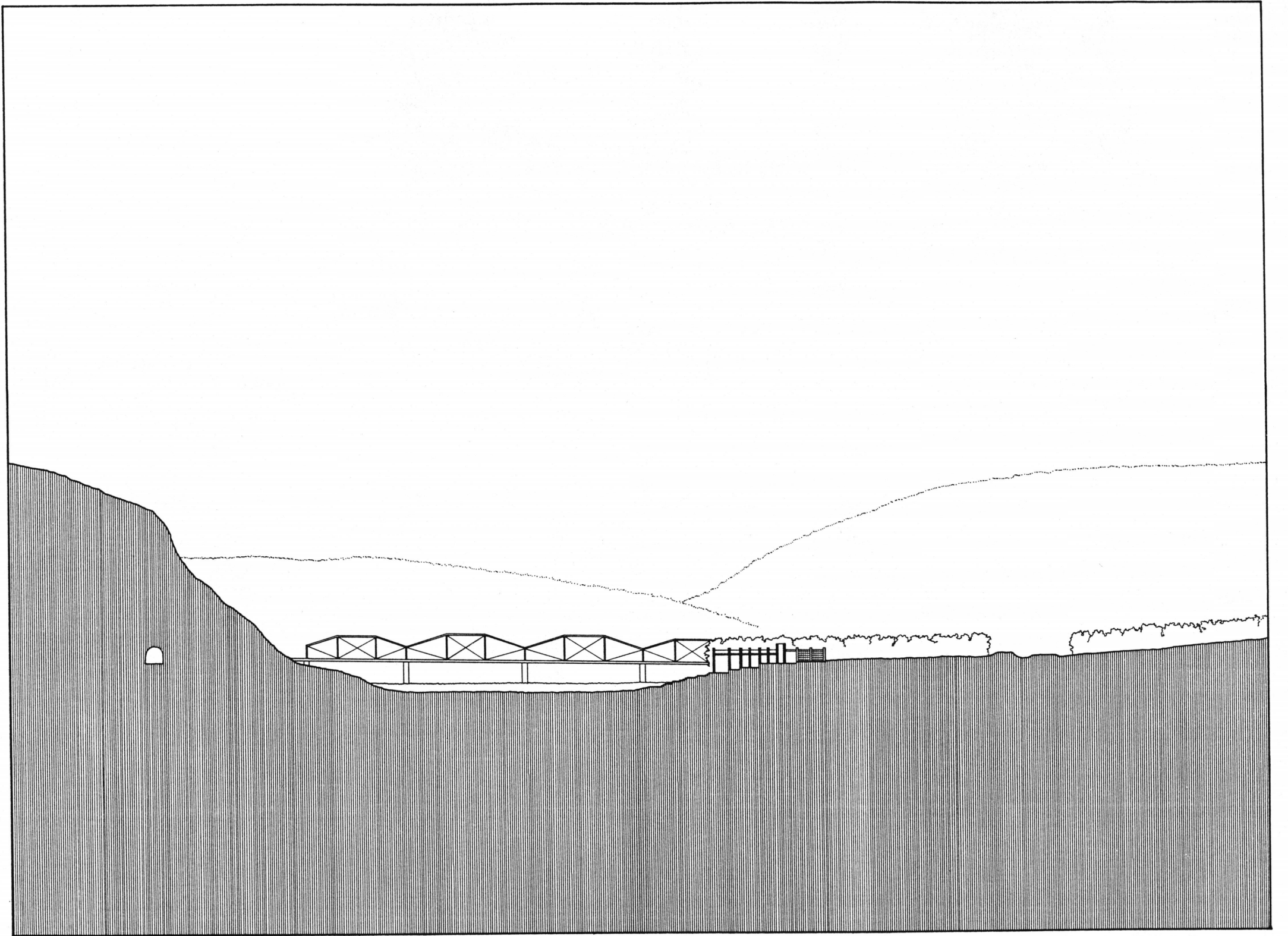

site section

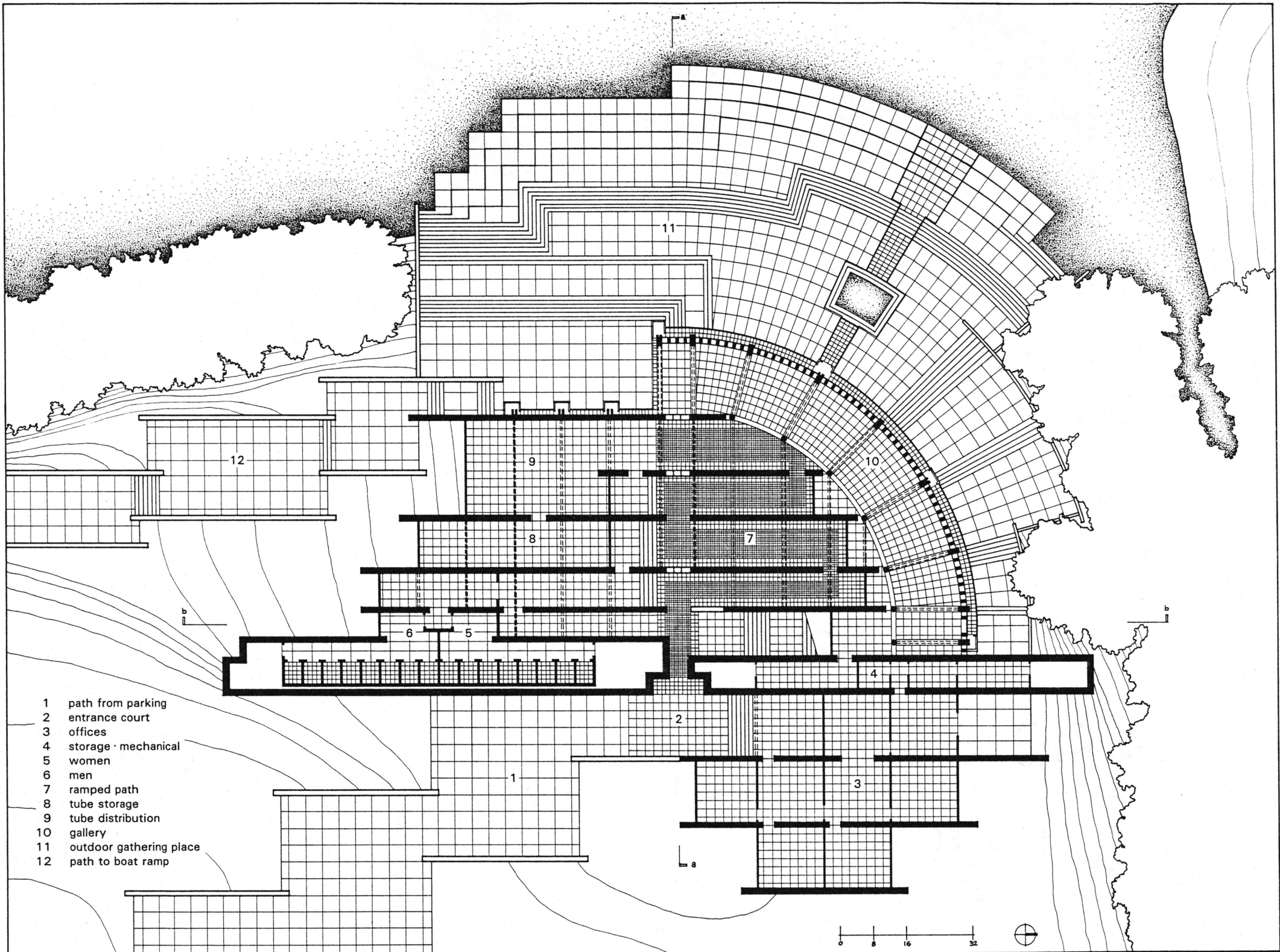

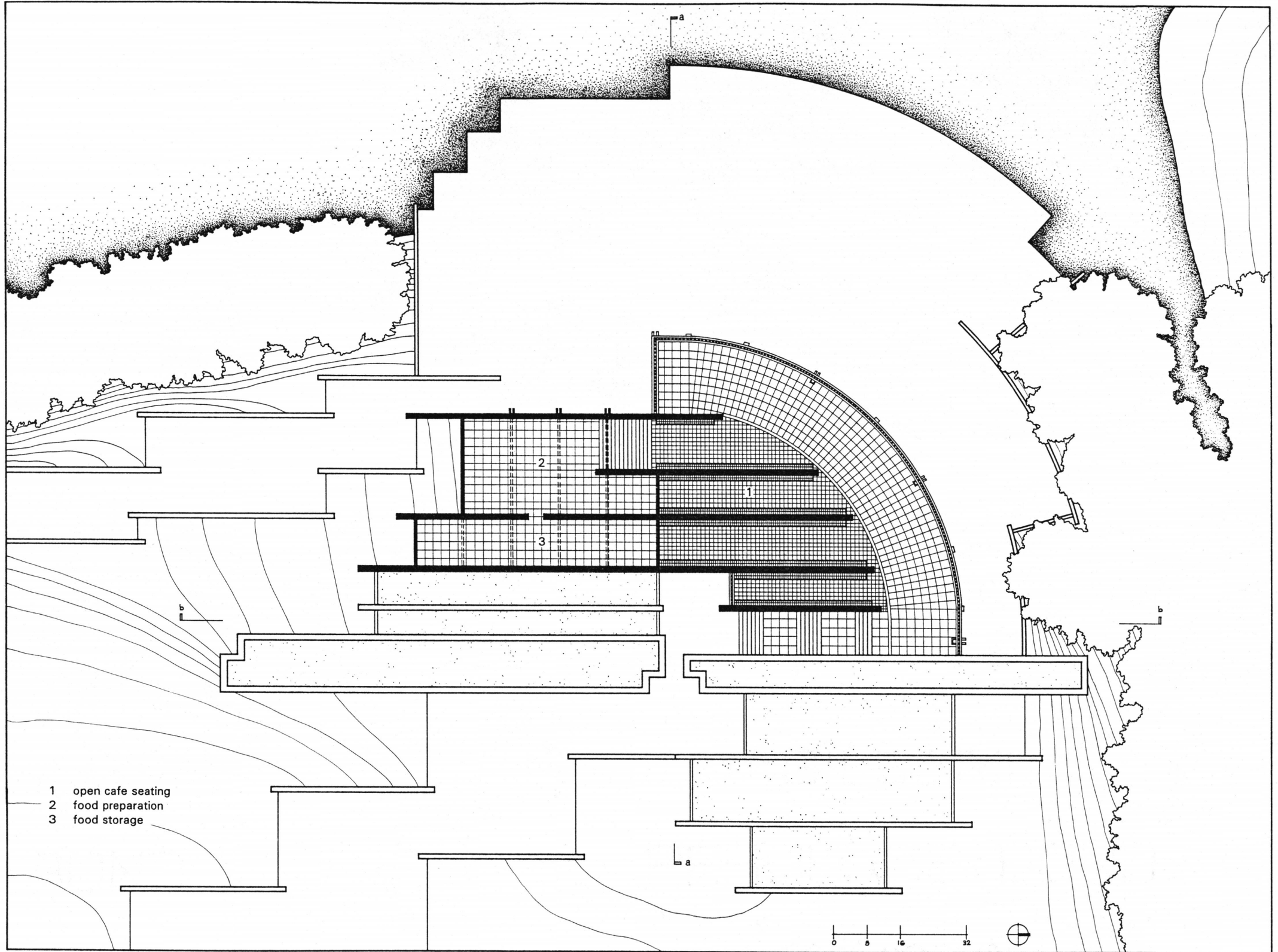

second floor plan

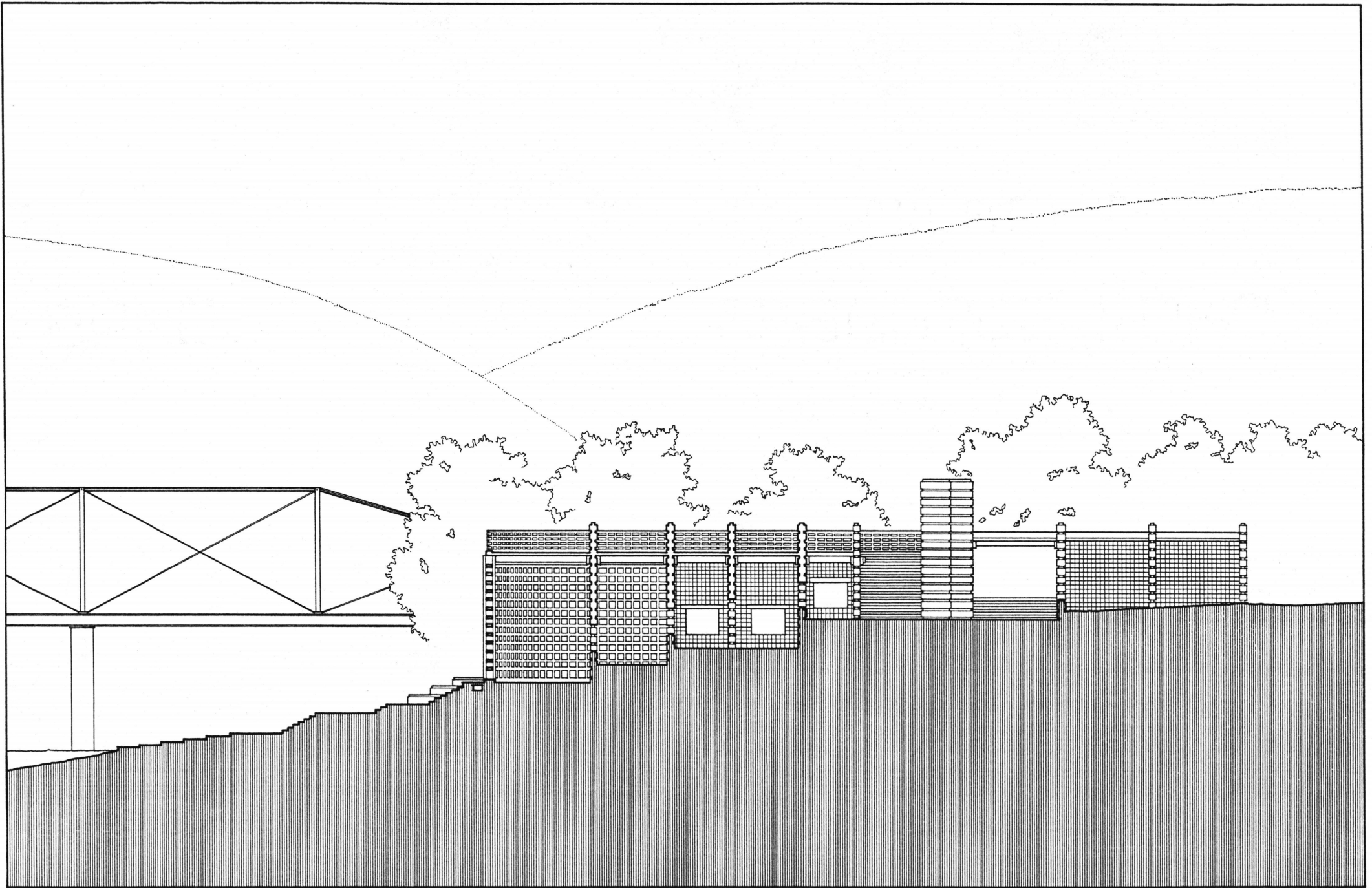

section a · a

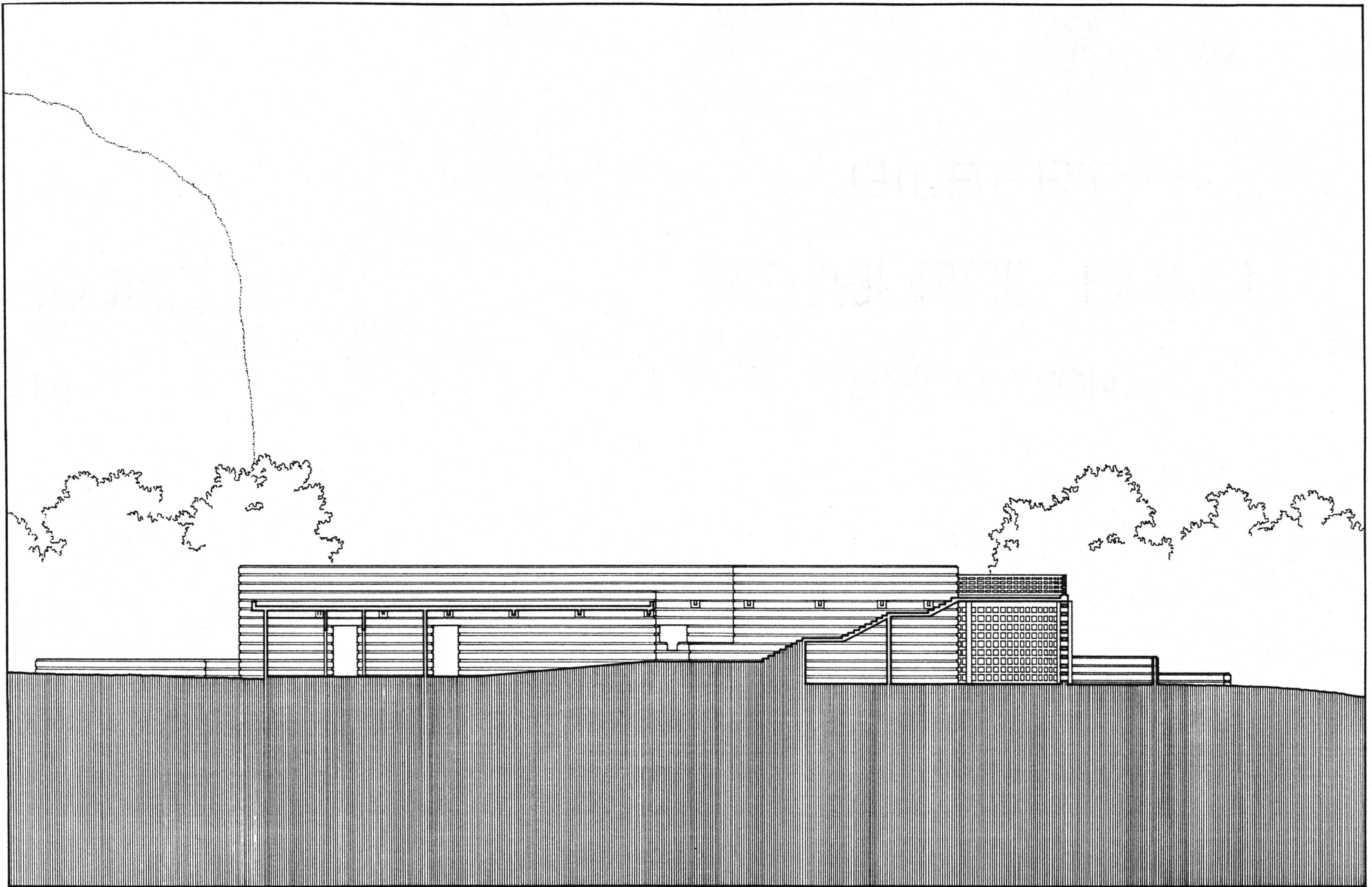

section b · b

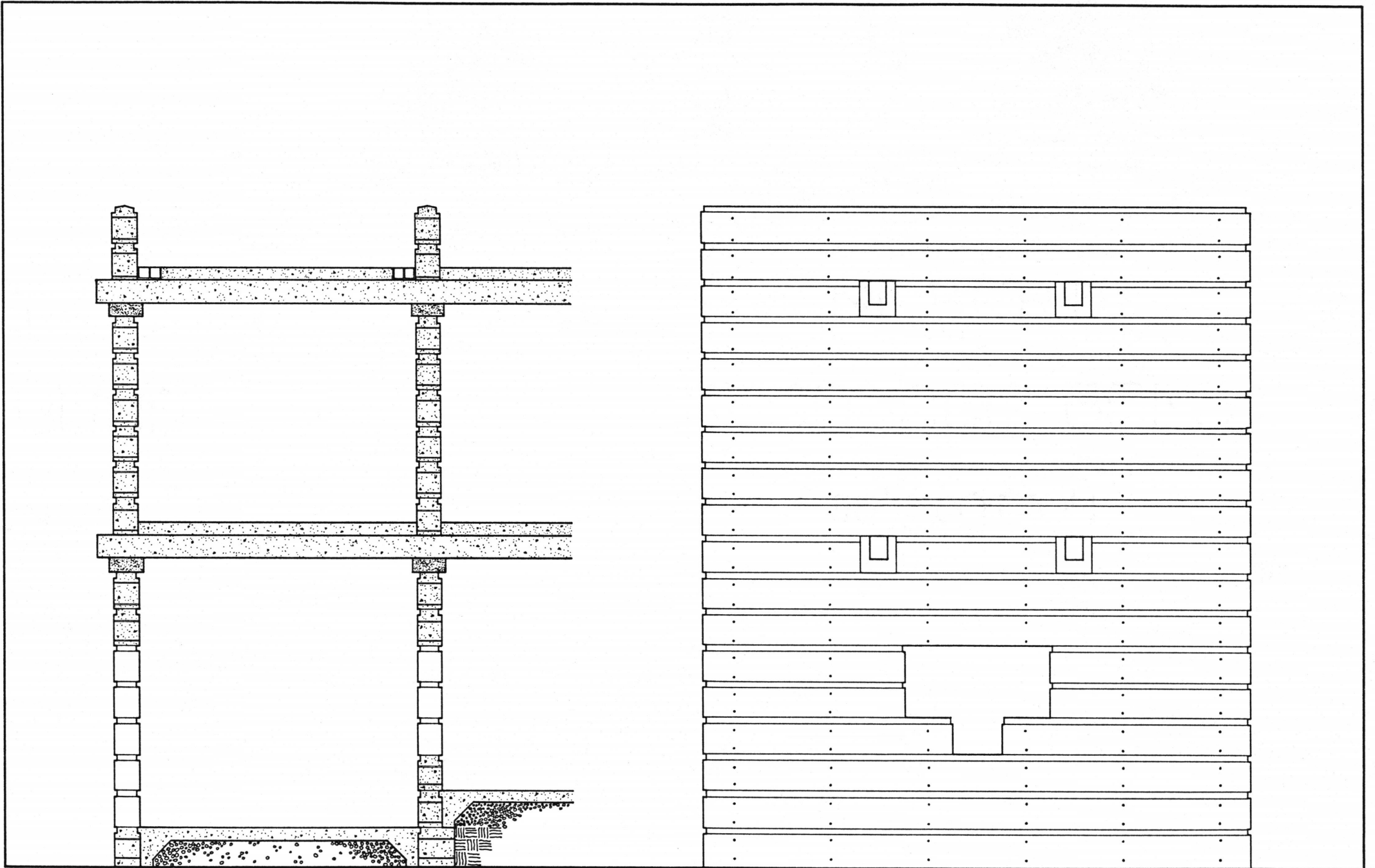

section · elevation

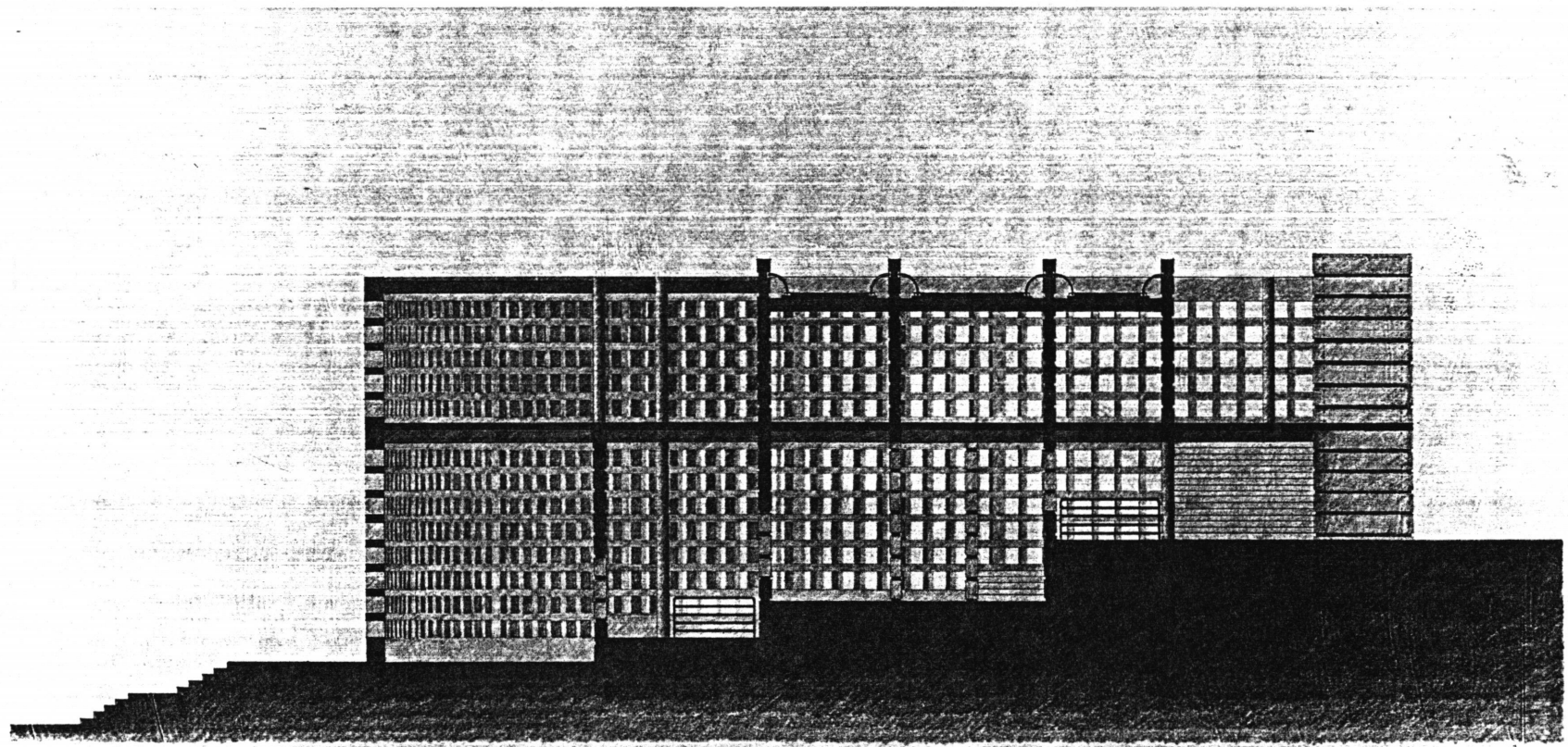

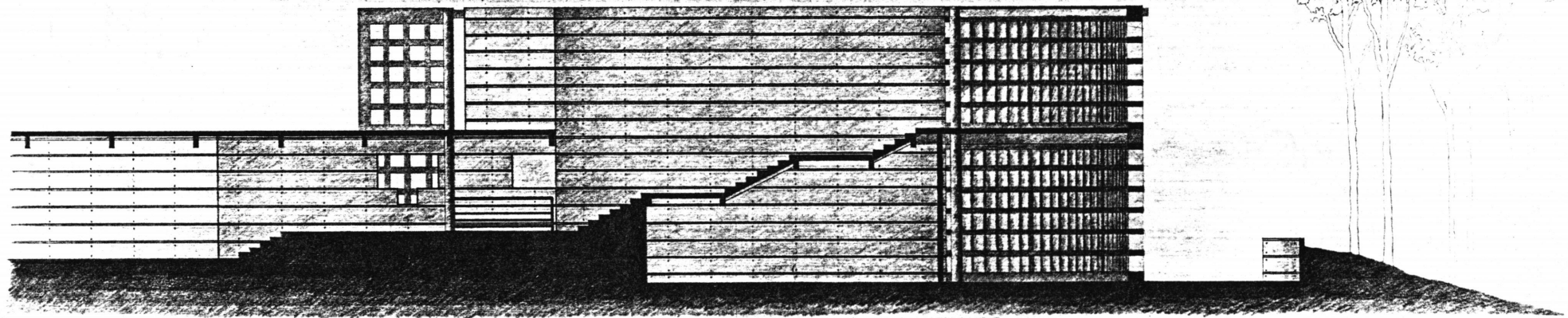

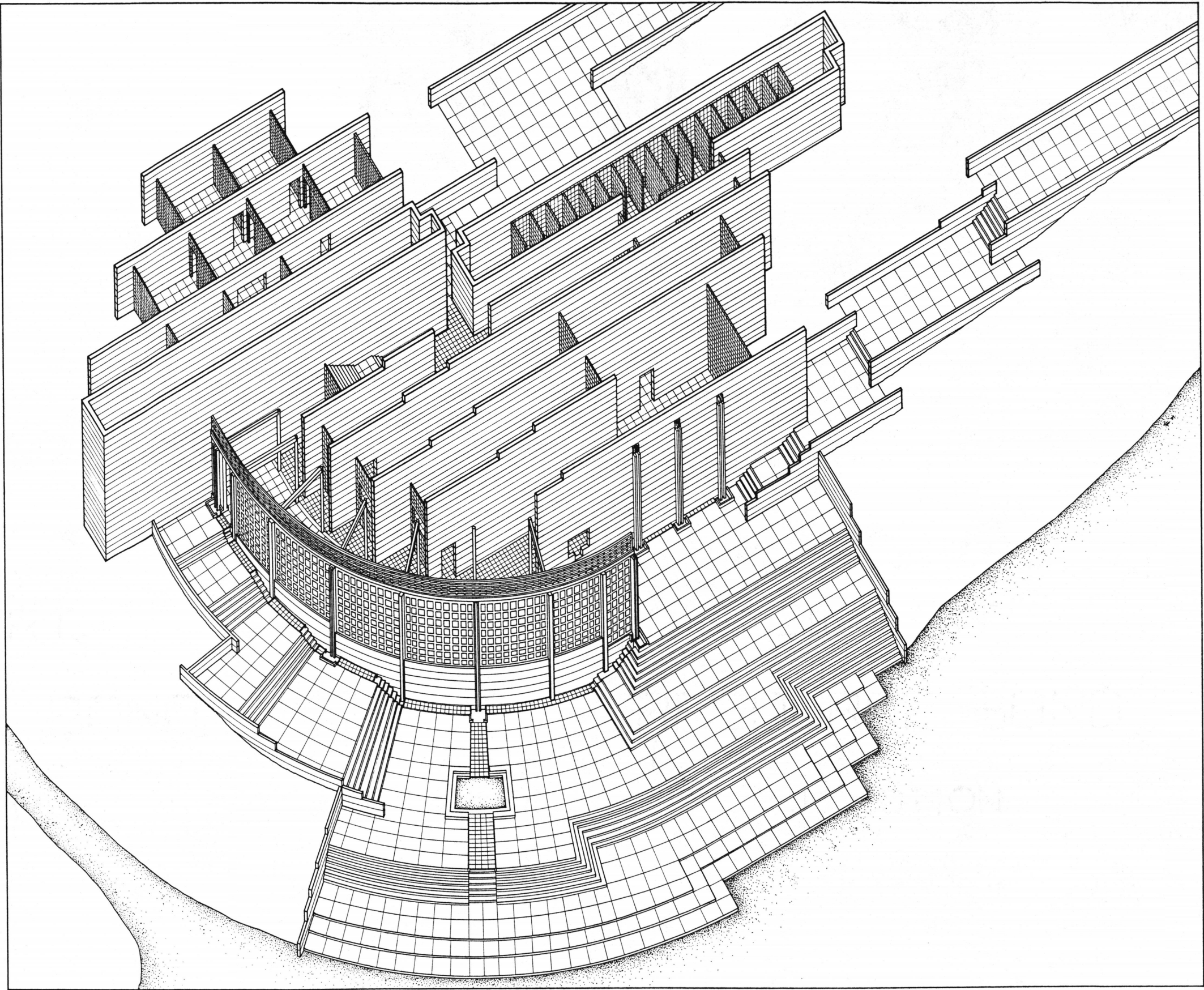

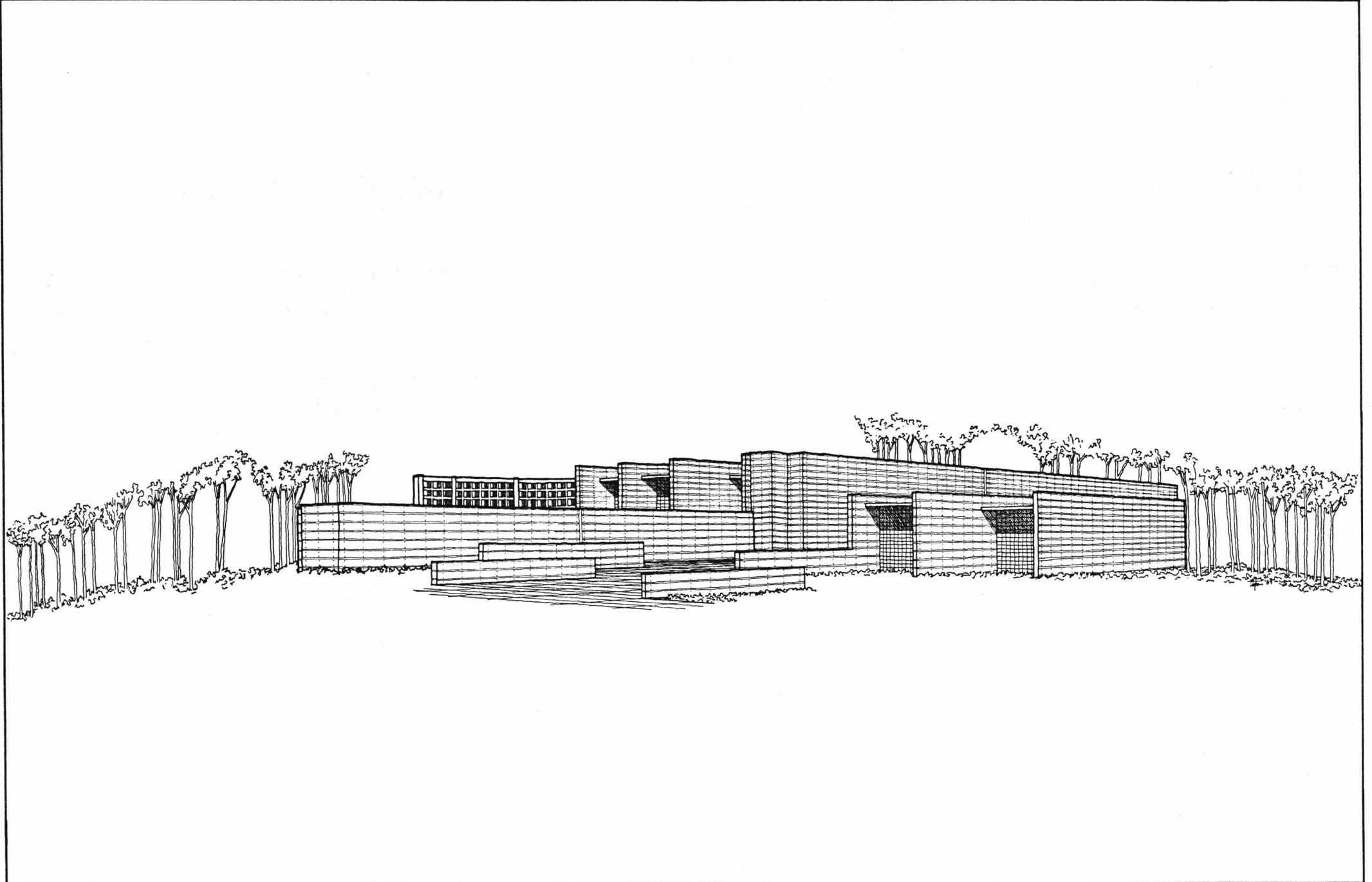

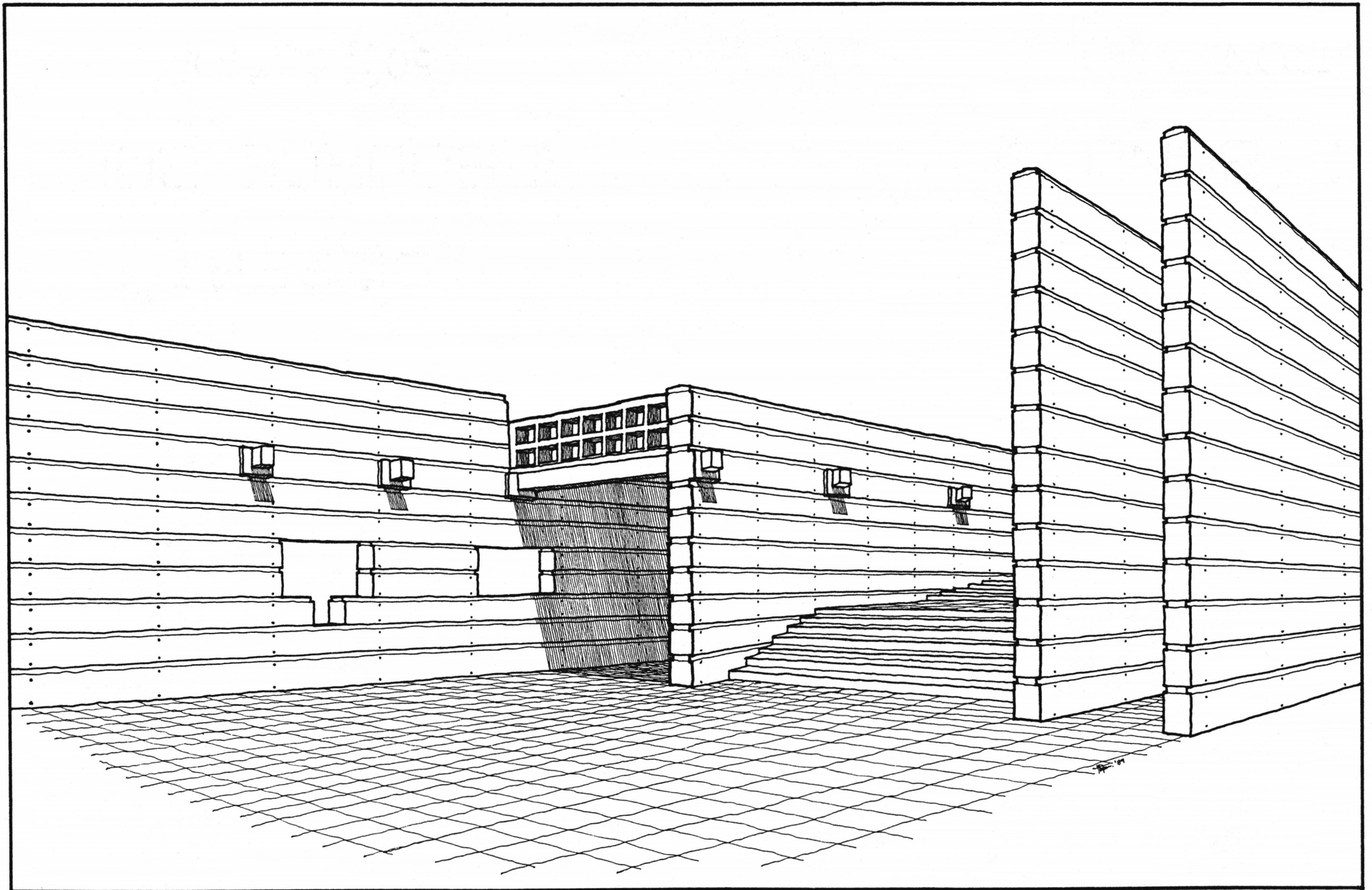

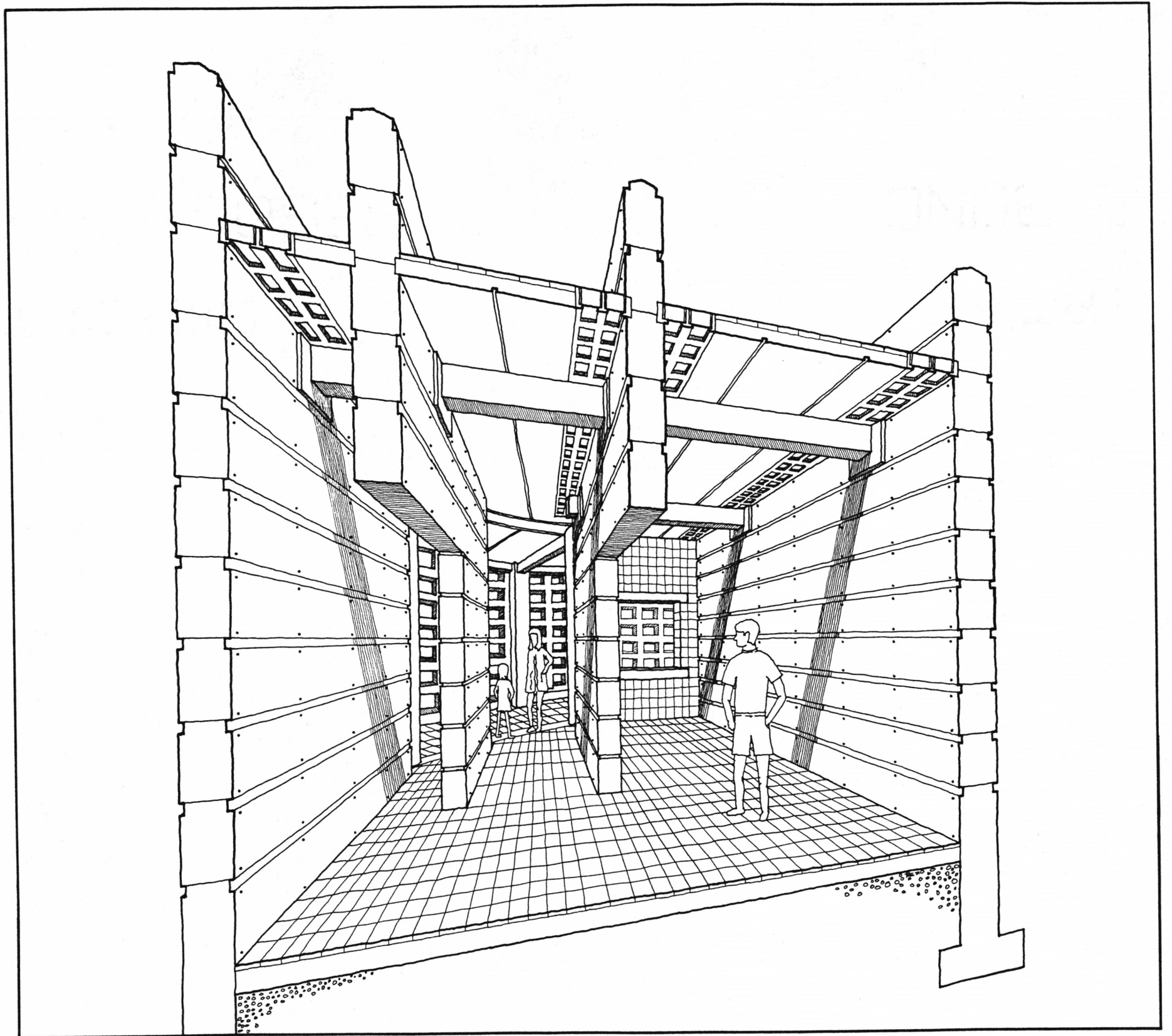

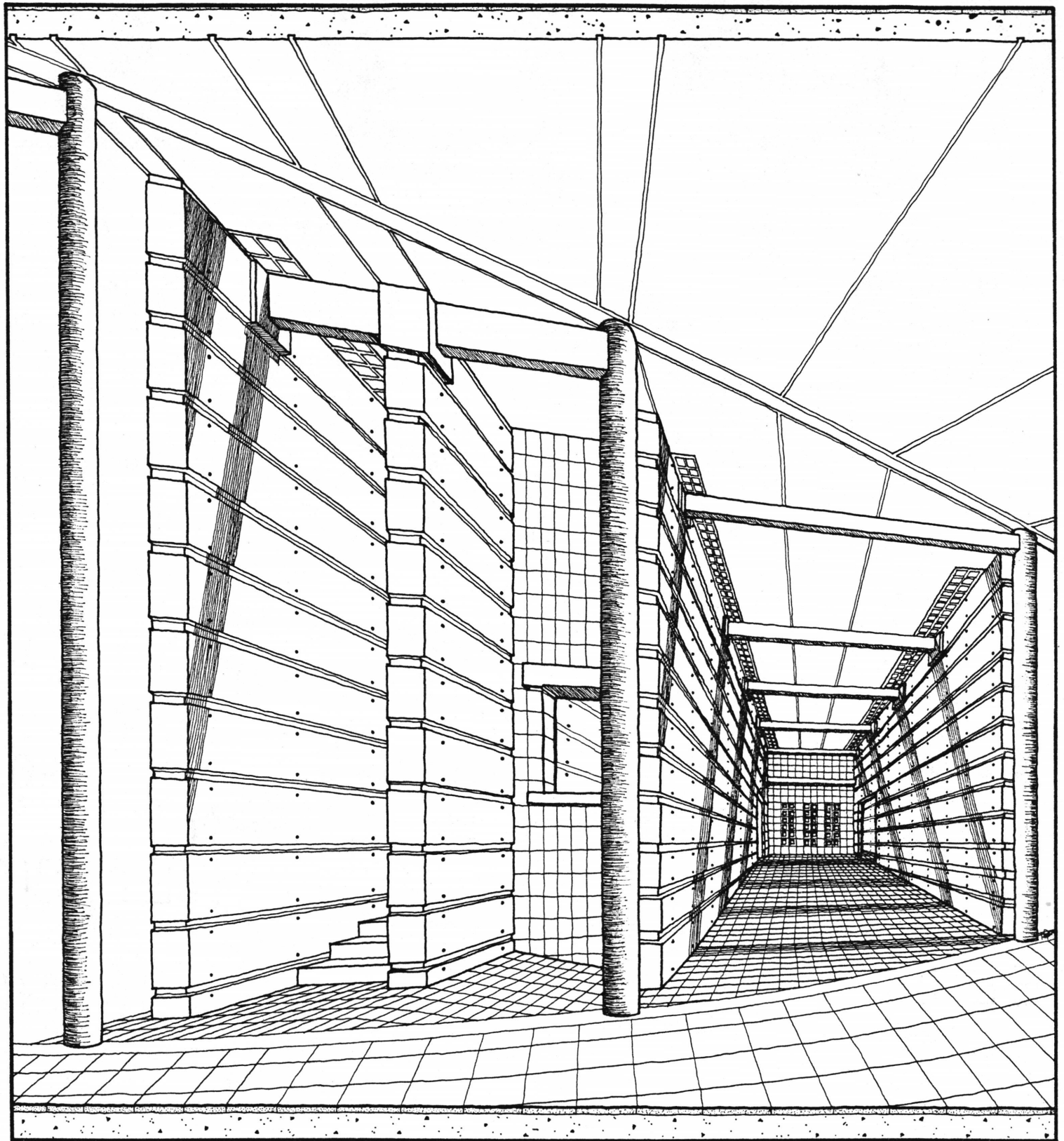

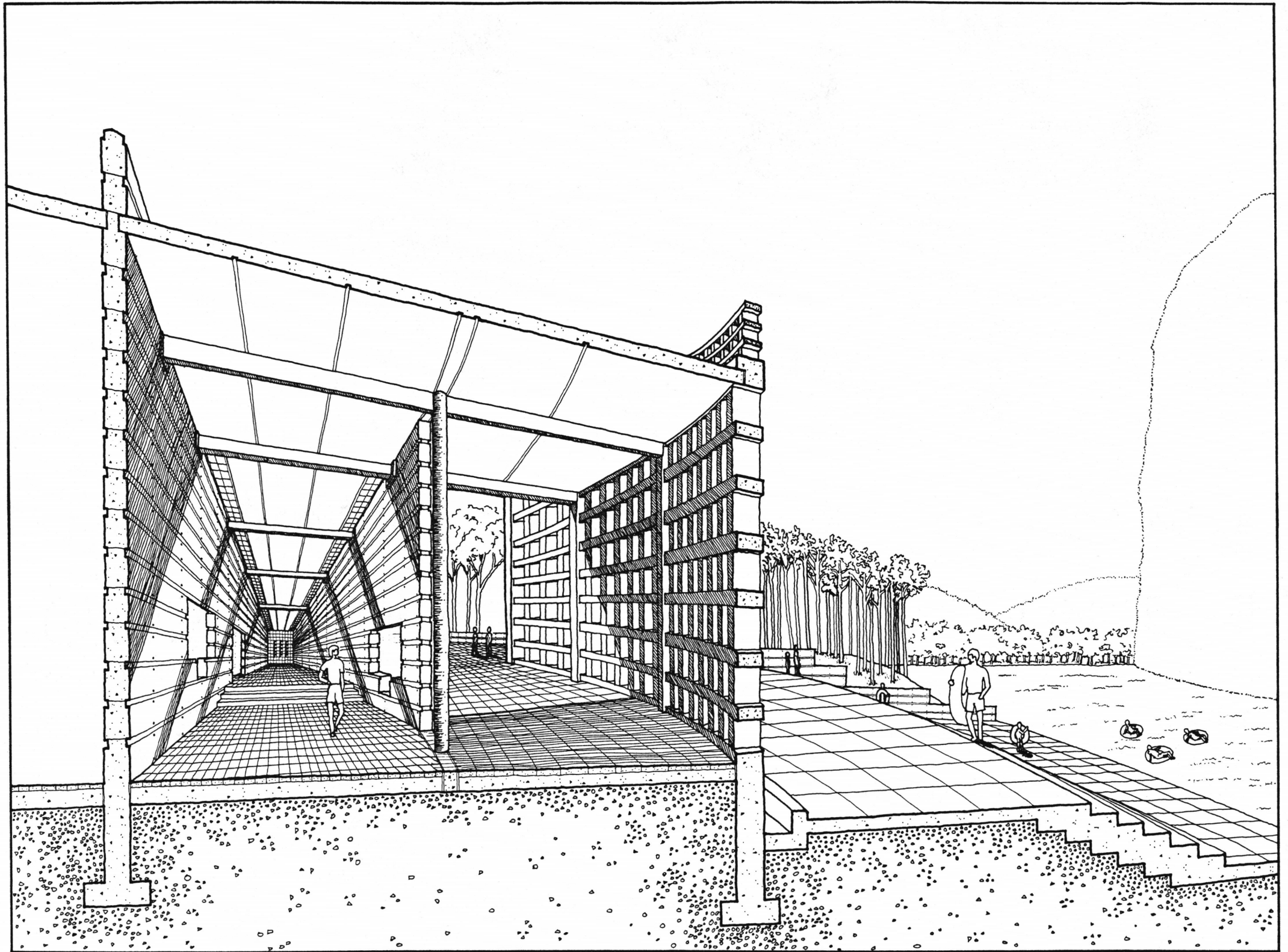

conclusions

The intent of this project was the development of a methodology for architectural design that draws from the region and the site, to make a building that has a sense of place paralleling that of its site. The first step toward accomplishing this was the establishment of priorities. The design was to respond to the context of the area, both natural and manmade. A place for people to gather and enjoy the surroundings was to be provided. But most importantly, the order and structure of the architecture had to have a sound basic concept upon which other decisions could be based.

The primary order of the walls and paths originated with the river valley and the wall-like grove of trees along the water's edge. The layered method of construction was a means of incorporating the stratified nature of Castle Rock into the structure of the building. The path defined by the walls slopes down toward the river in a series of ramps, winding back and forth, revealing views of the bridge and the river, finally, at the exit exposing Castle Rock. The platforms are the meeting place of land and water, forming an edge of steps that respects the power of the river, while making a place where people can gather.

The end result is a building that incorporates the uniqueness of the site into its design in incremental ways. The elements of the architecture respond to their surroundings first individually, then as a collective whole.

In retrospect, the greatest struggle was the development of the method by which the basic concept could be established. The real breakthrough occurred with the discovery that the context could be studied as elements of structure, form and order. With this better understanding of the parts, the result was a clearer view of how to respond to the whole. With this came the discovery of one method of making architecture. And then came the realization of the true meaning of the thesis: discovery.

abstract

The intent of this project was to develop a method of making architecture which incorporates into its design the unique features of the site and region.

The site was chosen because of its unique physical features and strong regional character. The ideas of the layering of the walls was derived from the strata of a nearby bluff. The form of the building, a series of parallel walls, was an interpretation of the natural architecture of the region and the site. The curved wall that terminates the path through the building originated as a response to the meeting of a stream and the river.

Out of this project came a building design that developed from the site in an incremental way. The architectural elements respond to the site through their individual form and structure, then as a collective whole.

bibliography

Benedikt, Michael. *For an Architecture of Reality*. Lumen, New York, 1987.

Morisawa, Marie. *Streams*. McGraw-Hill, New York, 1968.

Norberg-Schulz, Christian. *Genius Loci*. Rizzoli, New York, 1980.

Rykwert, Joseph. *On Adam's House in Paradise*. MIT Press, Cambridge, Mass., 1981.

Safdie, Moshe. *Form and Purpose*. Houghton Mifflin, Boston, 1982.

Griffin, Fritz and Millet, Marietta. *Shady Aesthetics*. *Journal of Architectural Education*, Spring/Summer, 1984, p. 43.

Hein, Piet. *Of Order and Disorder*. *Forum*, December, 1967, p. 64.

Pallasmaa, Juhani. *Tradition and Modernity*. *Architectural Record*, May, 1988, p. 27.

Pallasmaa, Juhani. *The Social Commission and the Autonomous Architect*. *Harvard Architecture Review*, v. 6, p. 115.

Van Eyck, Aldo. *place and occasion*. *Progressive Architecture*, September, 1962, p. 155.

**The vita has been removed from
the scanned document**