

A PROPOSAL
FOR
A HOUSE

by
PATRICIA L. CONRAD

Thesis submitted to the Faculty of the
Virginia Polytechnic Institute and State
University
in partial fulfillment of the requirements
for the degree of
MASTER OF ARCHITECTURE

Michael O'Brien, chairman

Heinrich Schnoedt

William Galloway

Valerie Gaddis-Purswell

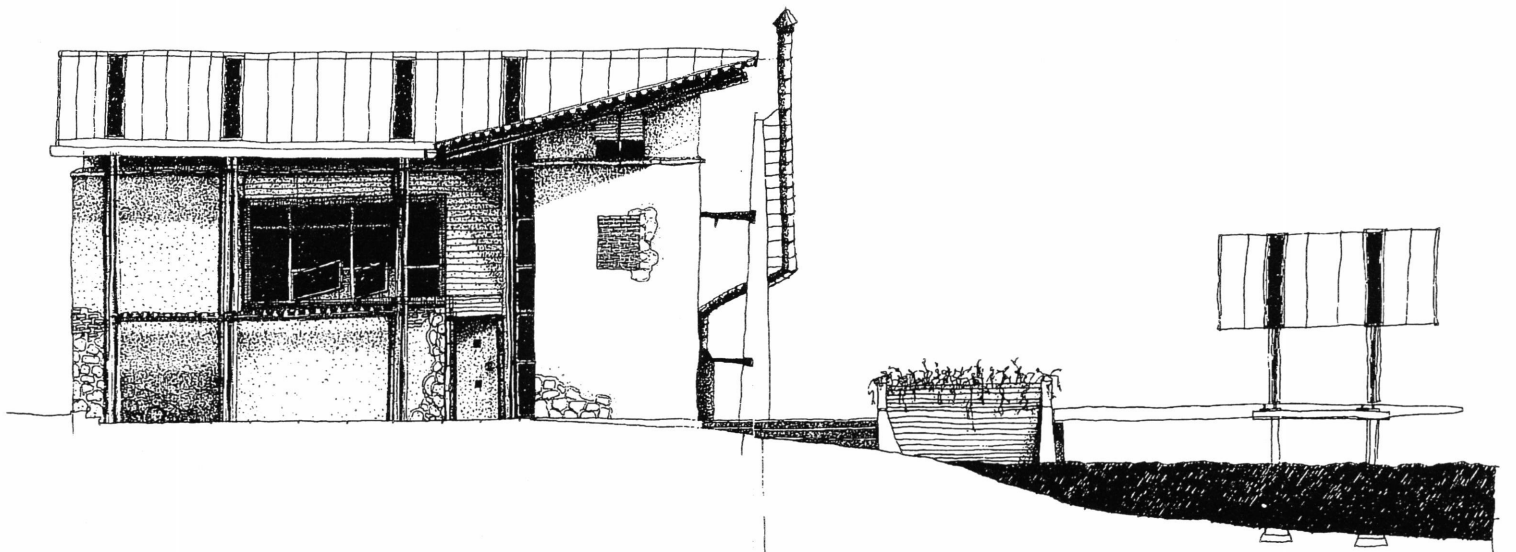

c.2

LD
5655
V855
1994
C667
c.2
Folio

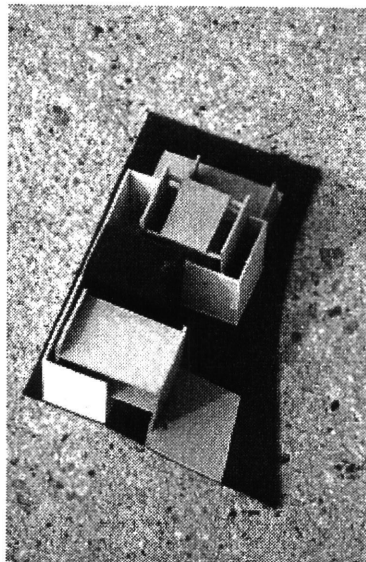
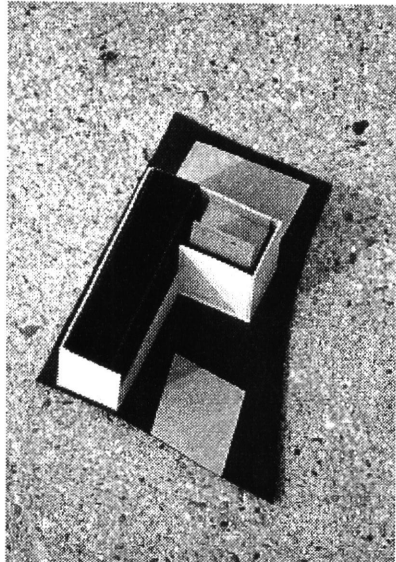
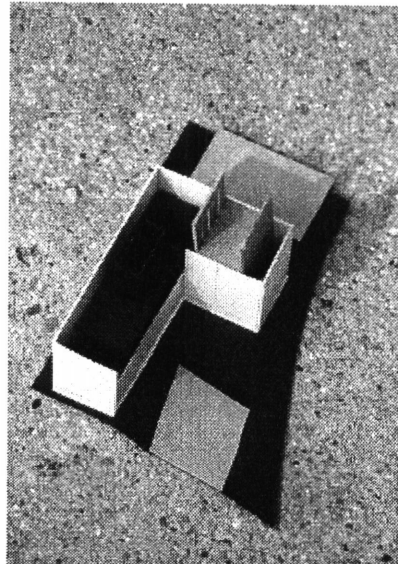
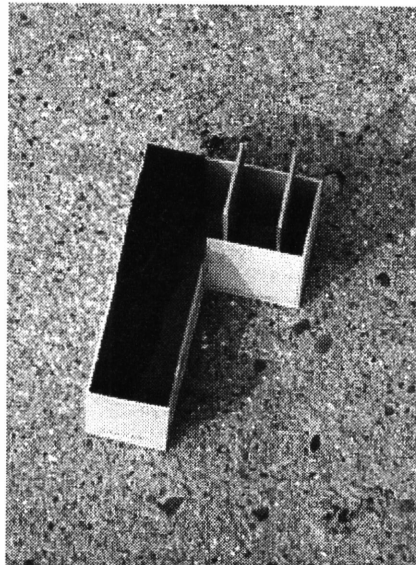

TABLE OF CONTENTS

ABSTRACT	5
LIVING IN A TOWN - RIVA SAN VITALE	6
POSSIBILITIES OF A SITE	10
CONSTRAINTS	12
SIX PREMISES	16
SUMMARY OF FINDINGS	19
THE DECISION	
THE COLUMN	20
FIRST FLOOR PLAN STUDY	28
PLACES OF A WALL	30
SECOND AND THIRD FLOOR PLAN STUDY	34
FINAL MODEL AND ELEVATIONS	38
DETAILS	42
GRAPHITE PLANS AND SECTION	46
APPENDIX - HILLSVILLE PROJECT	48
SOURCES CONSULTED	51
VITA	53



ABSTRACT

The presence and placement of elements and setting up a contrast of the old to the new, presents an opportunity to explore an existing ruin.

This thesis book is a presentation of exploration and findings.

contrast: 1. to compare in order to show unlikeness or differences: note the opposite natures, purposes, etc...

presence n. 1. state or fact of being present, as with others or in a place;...;
3. immediate vicinity; close proximity

'..identification is related to bodily form, whereas orientation apprehends spatial order. We could also say that they correspond to the architectural function of 'embodiment' and 'admittance'. Any environment thus, *embodies* meanings, at the same time as it *admits* certain actions to take place.'

- C. Norberg-Schulz, *The Concept of Dwelling*

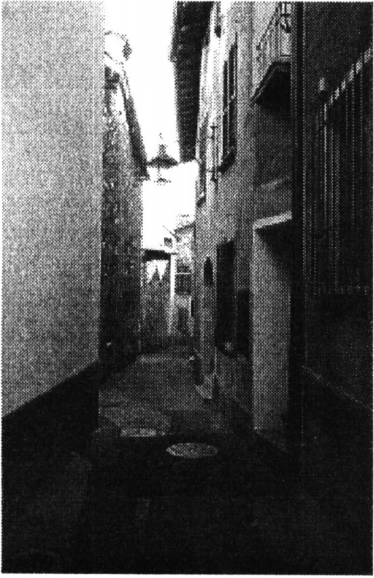

LIVING IN A TOWN

What does it mean to live in a town, not any town, but this particular medieval town located in Ticino, Switzerland? Walking within it, what do I see? What do I feel? What is the character of the spaces? In what way is this town important and different? I spend much time walking and sitting, taking

photographs and sketching, hiking in the surrounding mountains, and swimming in the lake below. Exploring, finding, talking to the people of the town. I sketch the places of the town. Searching. How can these sketches inform me?

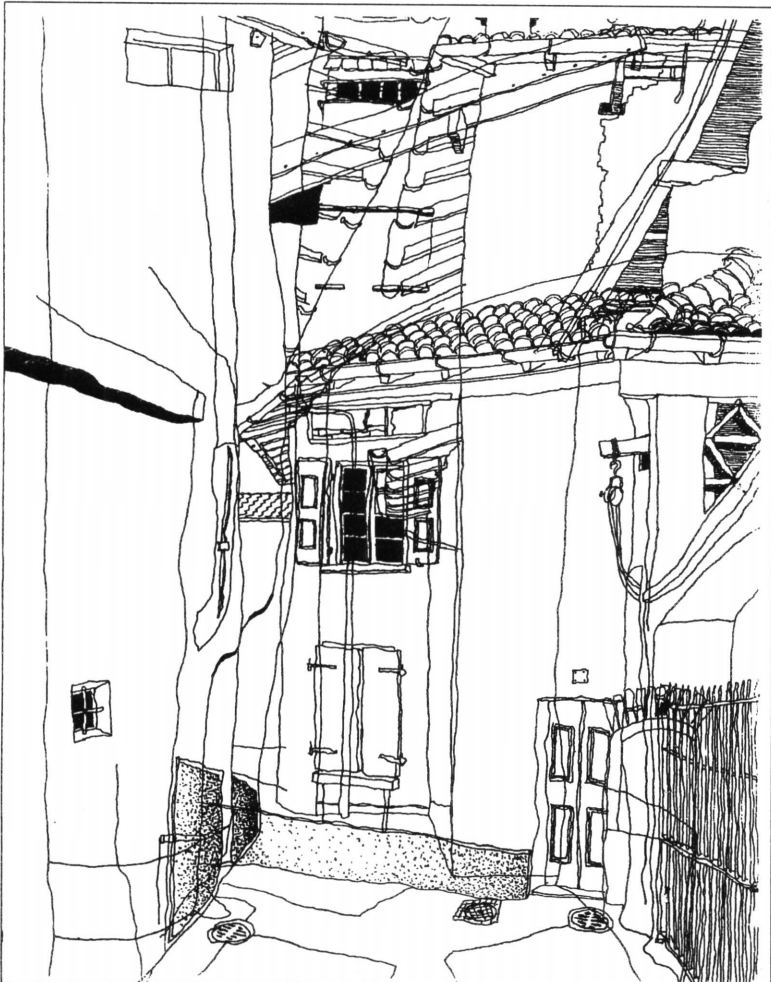

Overlaying different views, observed from one vantage point, offers information about how the street is seen. One can see how my height relates to buildings, the relationship of the street slope to the buildings, the extension of the roof over the wall, and the variety of openings. A cornucopia of events come together and make a rich, urban town. There is a richness in density that gives the street the character of rooms.

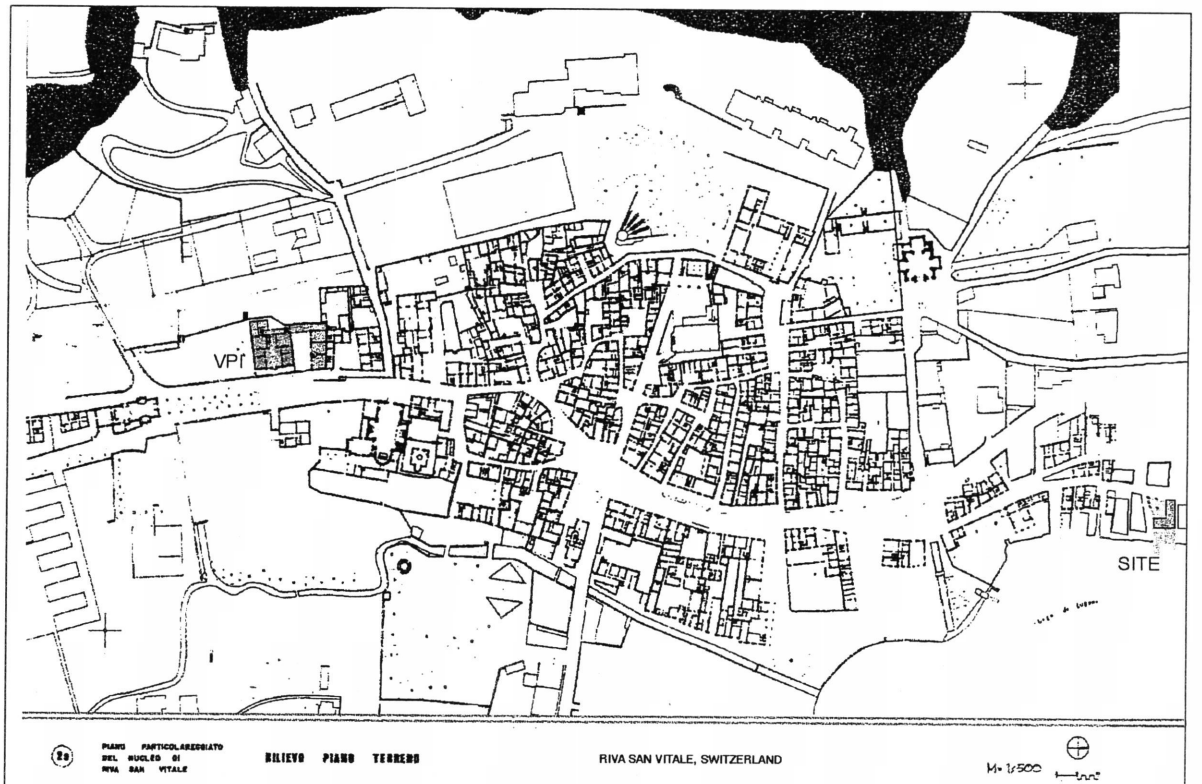
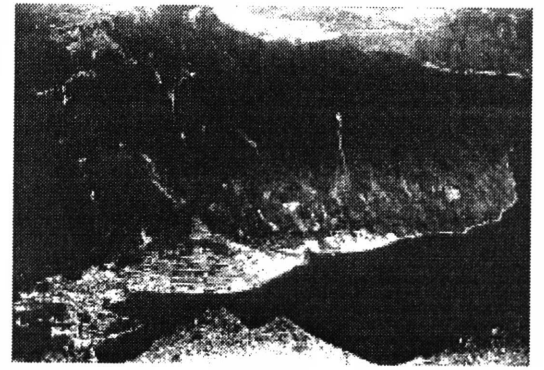
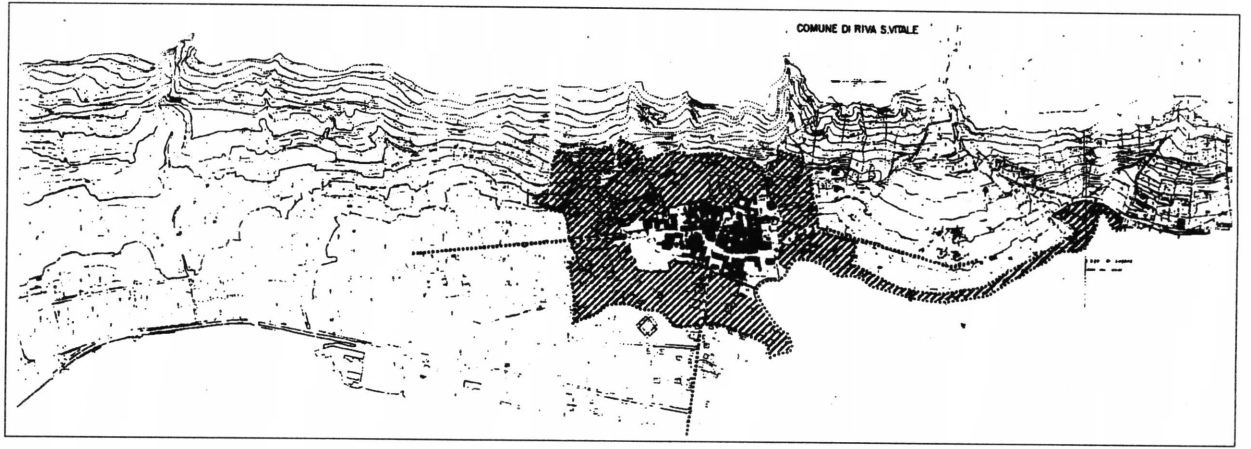



Riva San Vitale is an old town that dates back to its Roman foundations. An old Roman road is marked by a stand of oaks planted in front of a chapel. Does anyone remember why they are there?

The town is rich with potential discoveries. Compact, tall, enclosed spaces are everywhere. Winding streets, more like pathways, spill into other pathways or suddenly open up into courtyards. Rooflines follow the pathways and enclose it just a bit more with their own distinct outline that mimics the building below. There is more masonry than seems possible. All forms are used - concrete block, stone, brick, and terra cotta. Timber is used as roof supports, with clay tile on top to keep the rain out.

Tall places. Three story walls appear to be much higher as I pass between them. These walls give nothing away as there is no indication where one house begins and another ends. Suddenly, an opening breaks through the solidity of the wall into a private courtyard beyond.

Each event adds to the richness of the town; even the electrical wires do not detract.

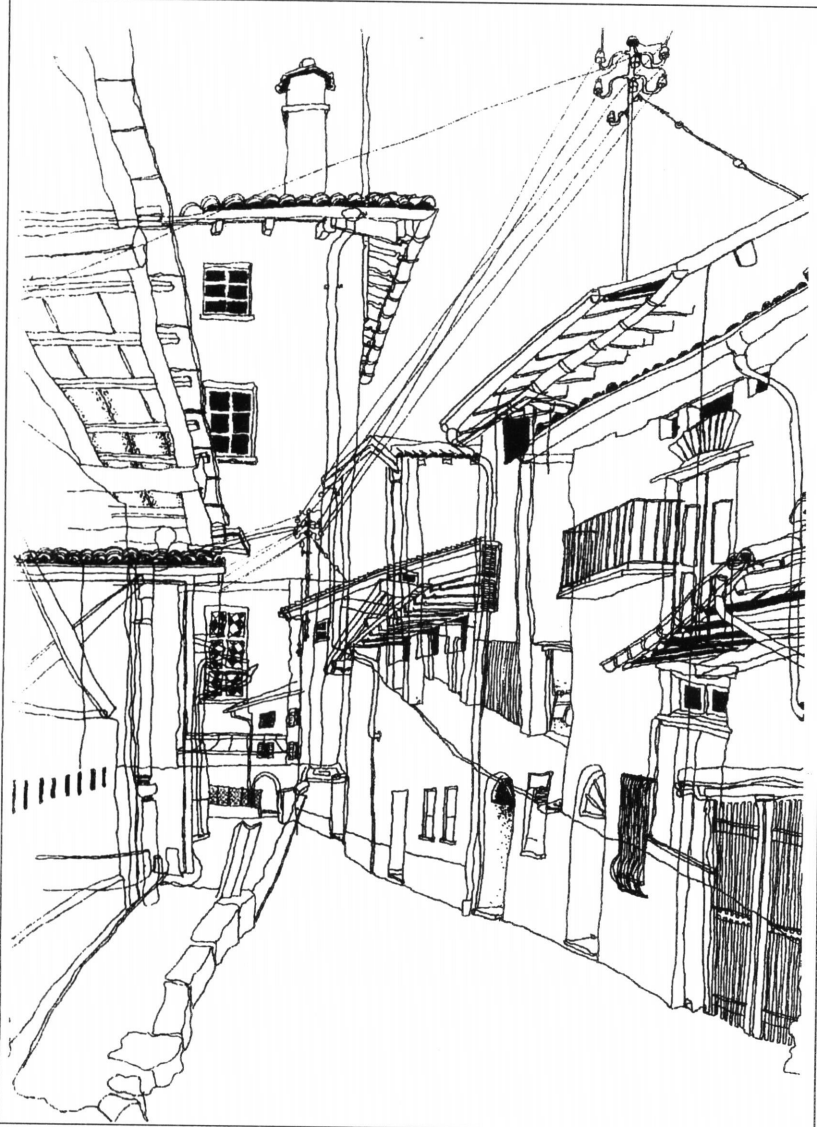

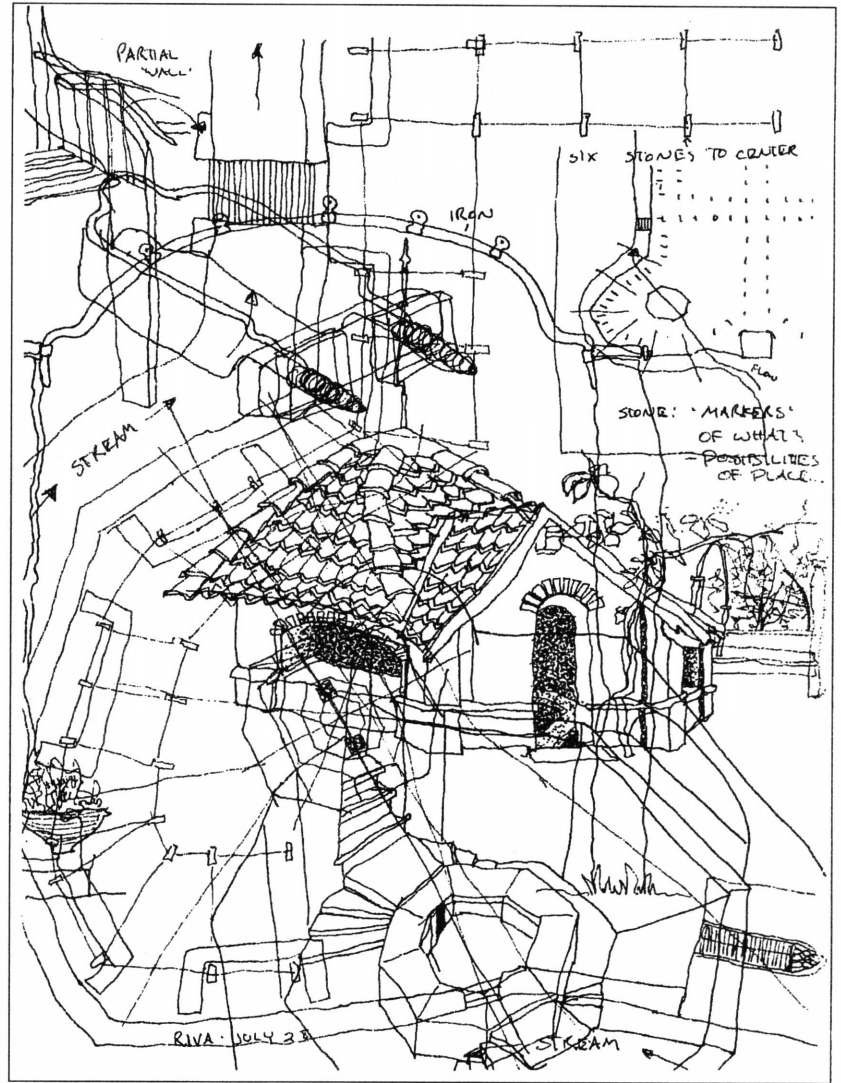

An old washhouse is hidden behind the 'wall' of dwellings that enclose a private world. Flowers, gardens, and a stream all exist behind the wall.

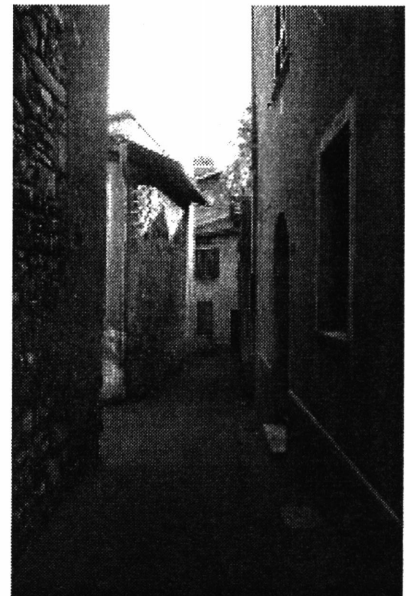

Density of space, tall structures, small rooms, openings that penetrate the canyon-type facades and spill into the street describes the character of the town. This place offers an opportunity for a straight-forward thesis that could be based on the same characteristics.

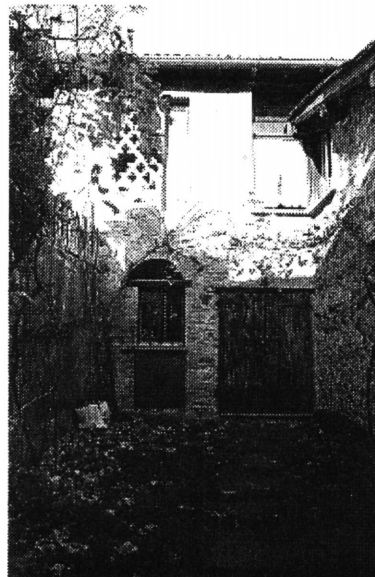
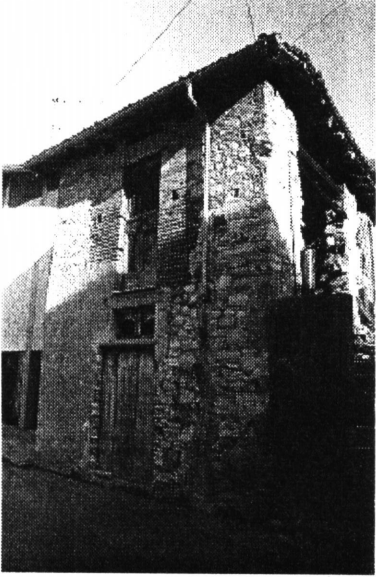

POSSIBILITIES

A barn burns down. All wood is consumed, leaving five stone columns, tall, massive, separated from the house. The house itself is in slow decay. It stands inches from the street. The structure is a ruin built in another time. Bricks and stone fill in the gaps, plaster partially covers the facade, but is mostly worn away by the elements.

The columns are supported by a thin block wall, plastered over and placed

in-between the base of the columns. Makeshift crossbracing supports them.

Instead of destroying a building, this town rebuilds its structures within and on top of older structures. It probably does not even occur to them to tear down and rebuild.

This structure intrigues me. How can I contribute to this place, this town? What materials would be used? What

would remain of the original structure? How to build something new within an old existing structure? I decide to explore this site as I did the town. What can be found?

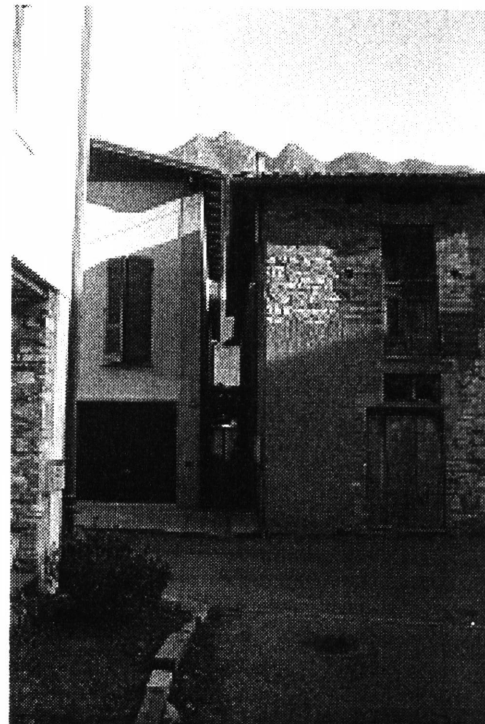

Constraint: A four foot wide crevice exists between the north wall of the site (existing wall) and the south wall of its neighbor.

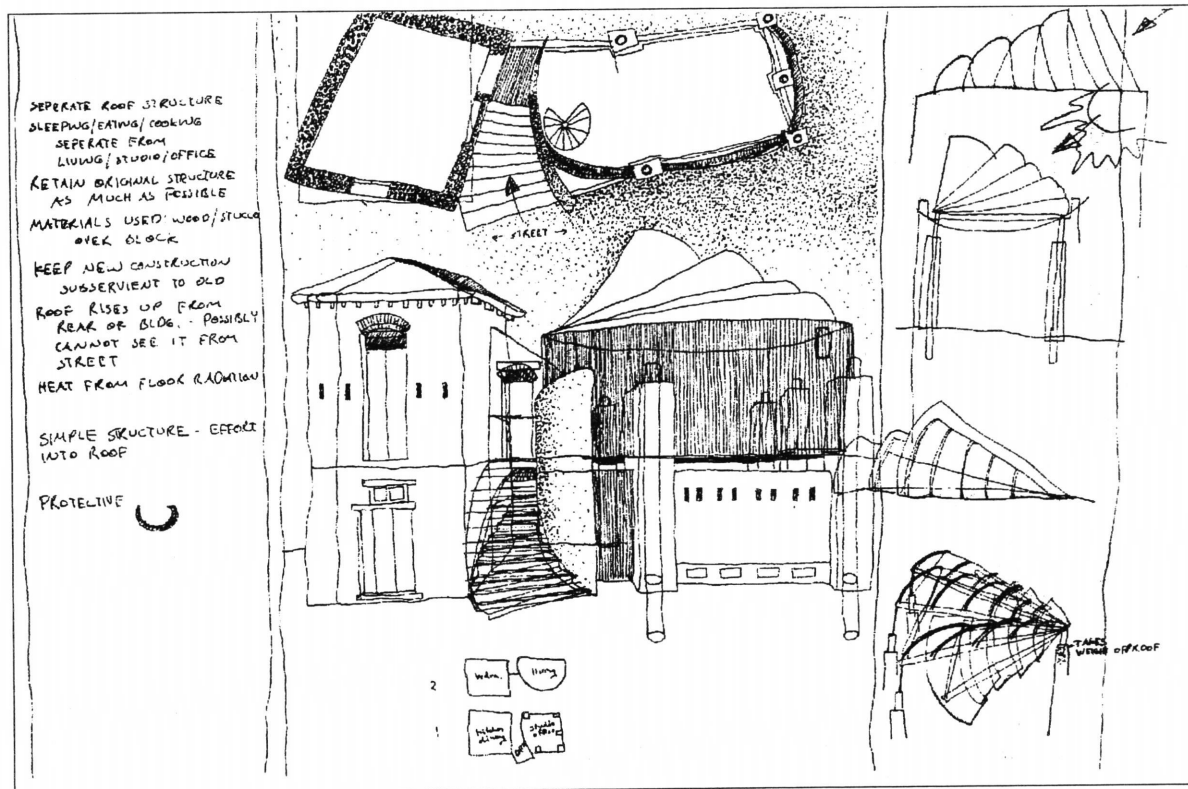

Initial site explorations. The original idea was to explore only where the old barn existed, located in the front part of the structure. This became too confining, so the site expanded to the entire structure (see sketches of plan below and site plan on the next page). The roof is extremely important, since light is at a minimum due to local terrain and the height of town structures. The roof is also a place for expression, to reach for the sky.

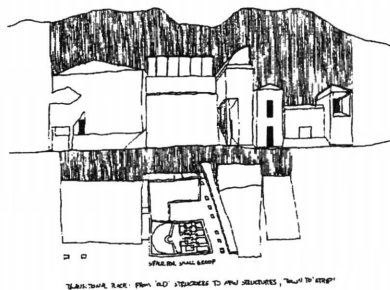
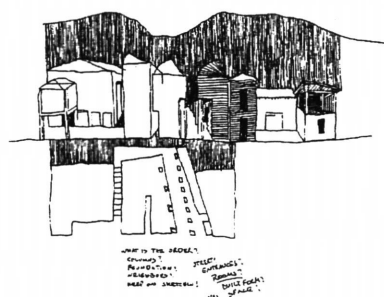

Constraint: The south neighbor sits at a diagonal to the site. See plan on next page.

Constraint: Six inches or less is the distance of the front facade to the street.



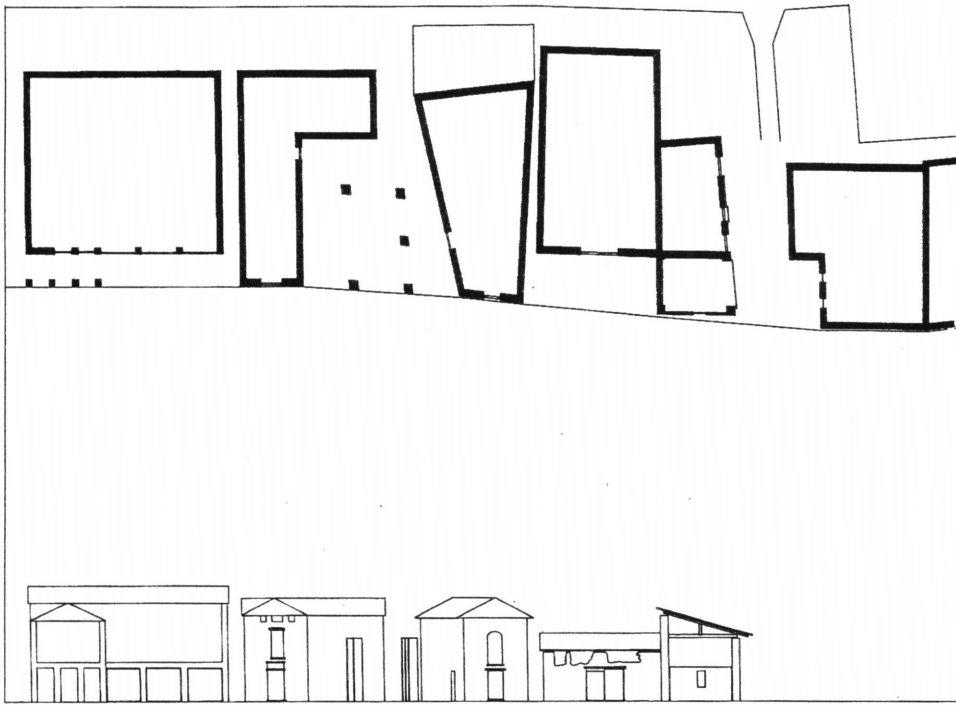

CONSTRAINTS

The thesis site at first was bound by the front part of the structure, where the barn had burnt down. It became evident that this was not enough for a house, and therefore the entire structure became the site.

The dimensions of the interior are a width of eleven feet, length of fifty feet, and a wall height of twenty feet. The structure sits six inches from the edge of the street and approximately twenty feet from the waters edge. The north wall rests four feet from the south neighbor. The south neighbors north wall is at a diagonal to the site. In-between this wall and the five columns is a shared entrance to the houses from the street. Due to these dimensions, it was apparent that the new structure must grow upwards to accommodate the rooms necessary.

Another level of constraints occurred when the decision was made to allow the wall to become a place for special moments. This wall became a 'room' of its own, a foot and a half thick, that was penetrated in places by doors and windows.

Inherent to the project is the issue of an existing ruin and how it relates harmoniously with a new structure. Major questions revolved around a separation between the old and new elements, specifically, how much of a separation is necessary and to what end, and how are the natures of the old and new elements allowed to co-exist?

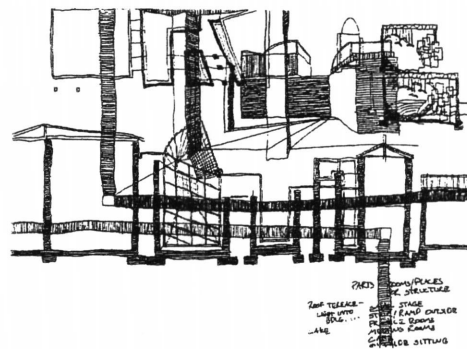
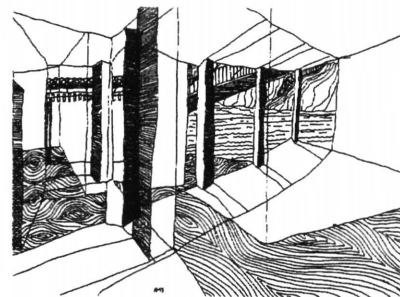

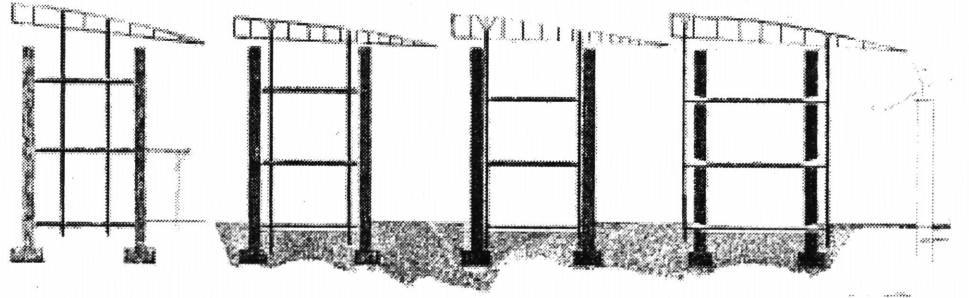

Exploration of the column to the wall relationship. As there is not much space within (only eleven feet wide), this eventually determines placement of the column to be very close to the wall.

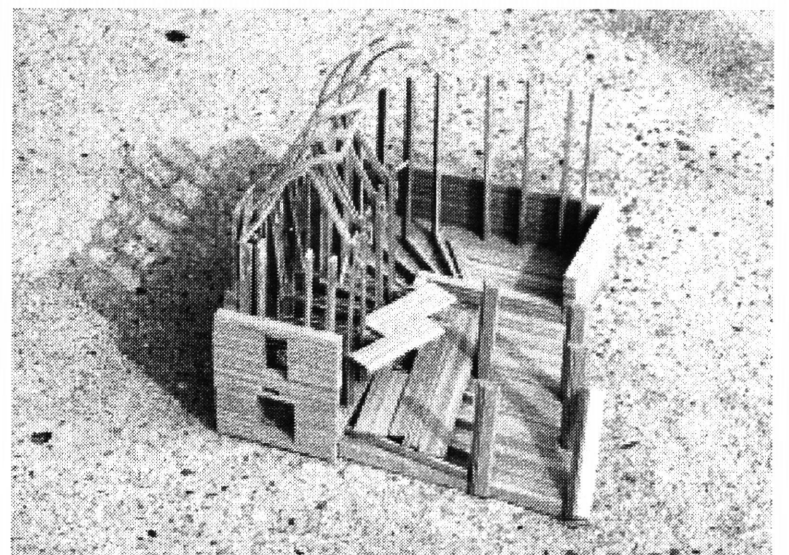
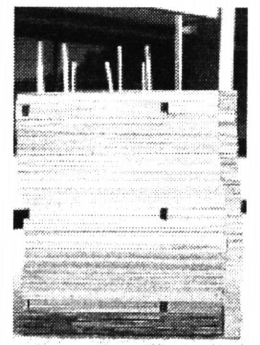
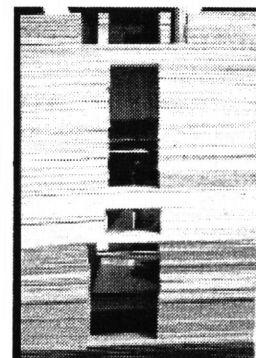
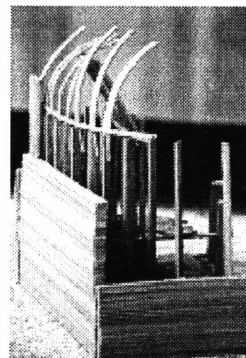

Early model exploration of structure. The new structure is responsible for supporting the floors and the roof. It also organizes interior rooms. How it can contribute to outside places is an issue that runs throughout the project.

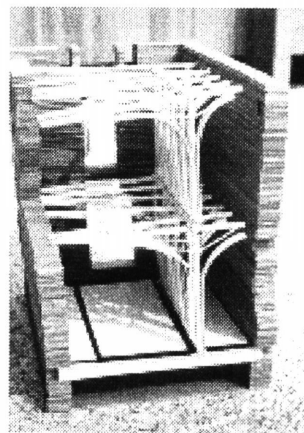
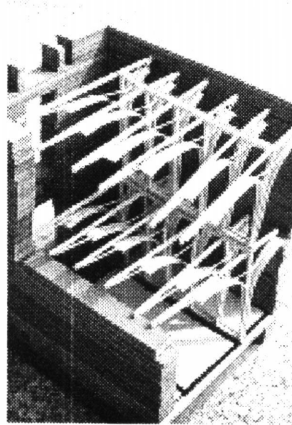
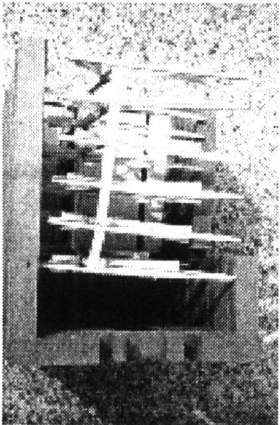
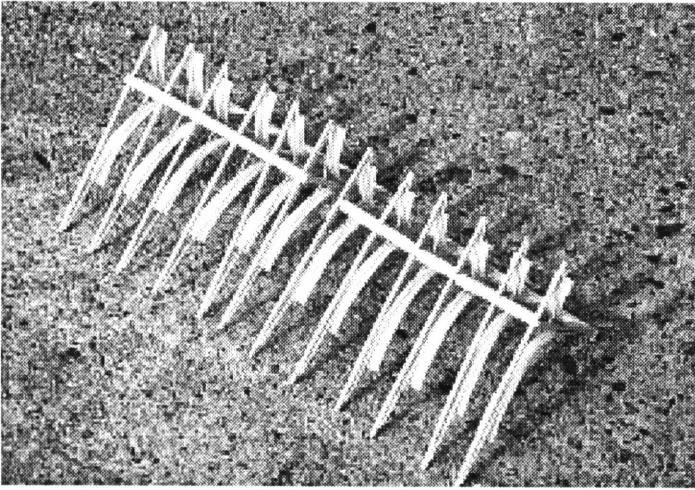

Model studies of the floor, ceiling, and structure. The idea of exposing the structure carries throughout the project investigation, and of how it relates to the wall. Does it penetrate the wall? Support the wall? Can it extend beyond the boundary of the wall?

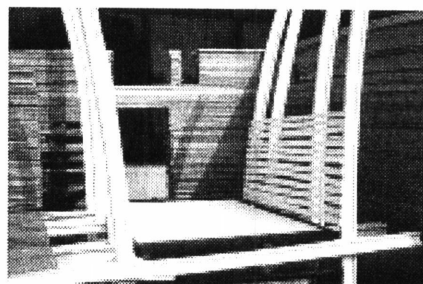
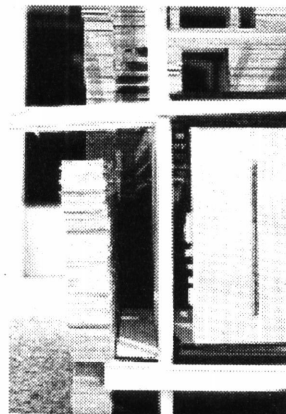
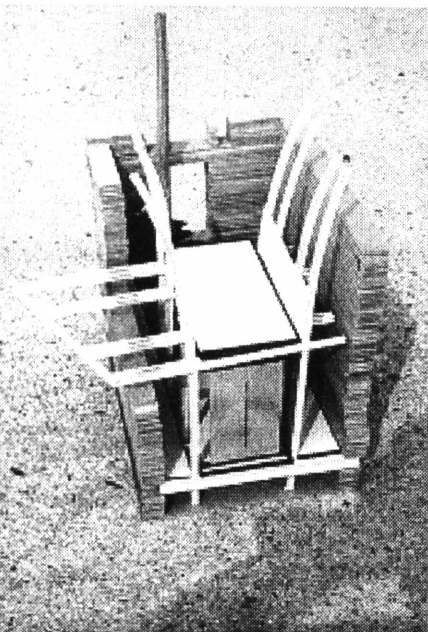
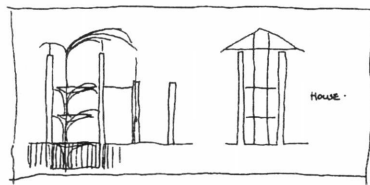

How to best go about knowing this place? Where do I begin? I decided to work with what I already know. This eventually became my most reliable resource. Make what I know, draw what I know...and go from there.

The wall for the model was made based on its characteristics, such as the thickness (a foot and a half), the height (approximately twenty feet), its material (layered stone), and that it is

completely enclosed. Openings for windows and doorways occur where it was deemed necessary by the original builders, and then changed by later owners.

It became necessary to step back and look at the possibilities of how the interior structure could make rooms and a roof within the wall. The studies on the following pages explore this question.

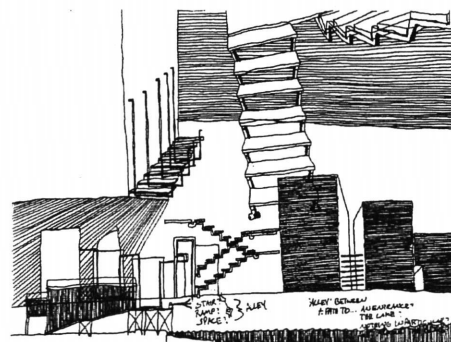

Initial study sketches. What happens in-between the existing five columns and the wall, or between the walls of the north neighbor and the north facade? Idea of in-between, transitory places originates and carries throughout entire project. Roof question also runs throughout project and changes shape up to the final model. Although, the structure and character of filtering in light remains constant.

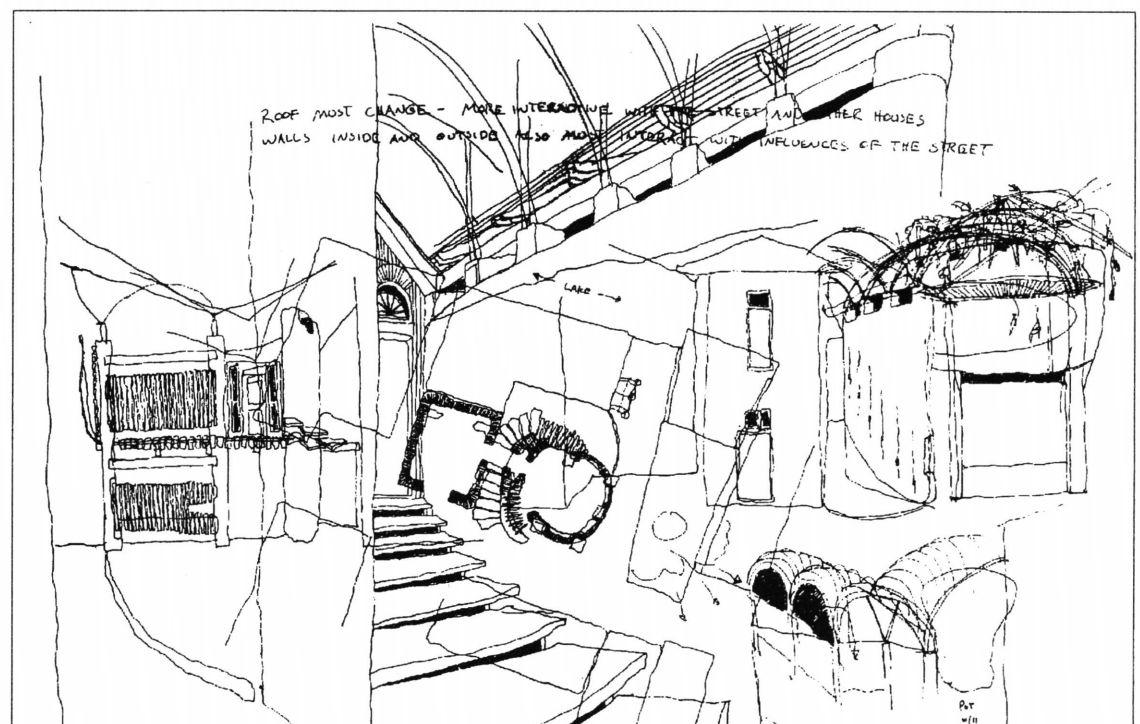

SIX PREMISES

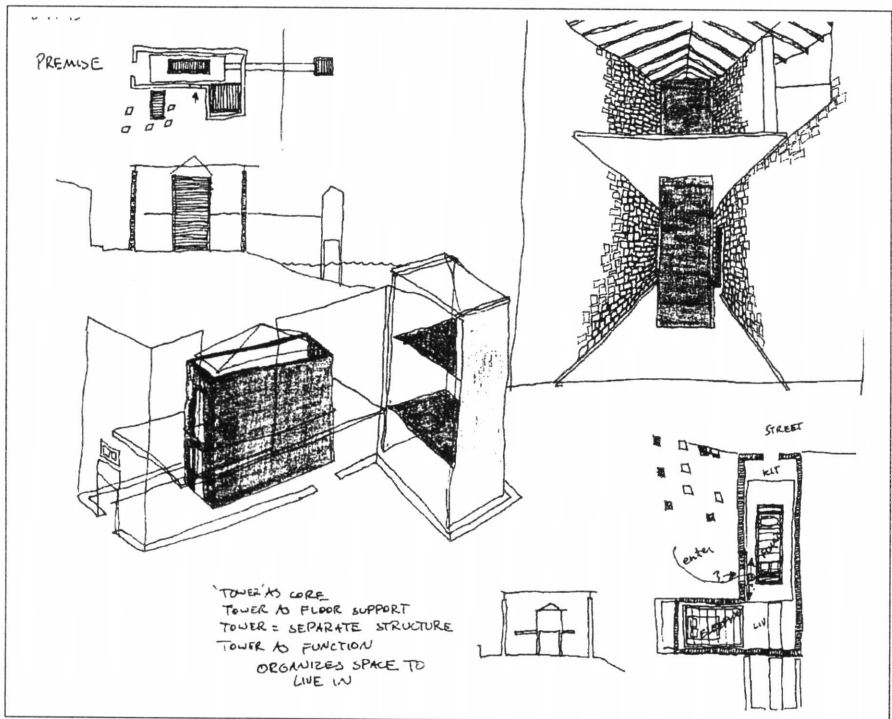

Premise 1: Four separate rooms, two within the wall, two without. Four towers which define places, to structure the house.

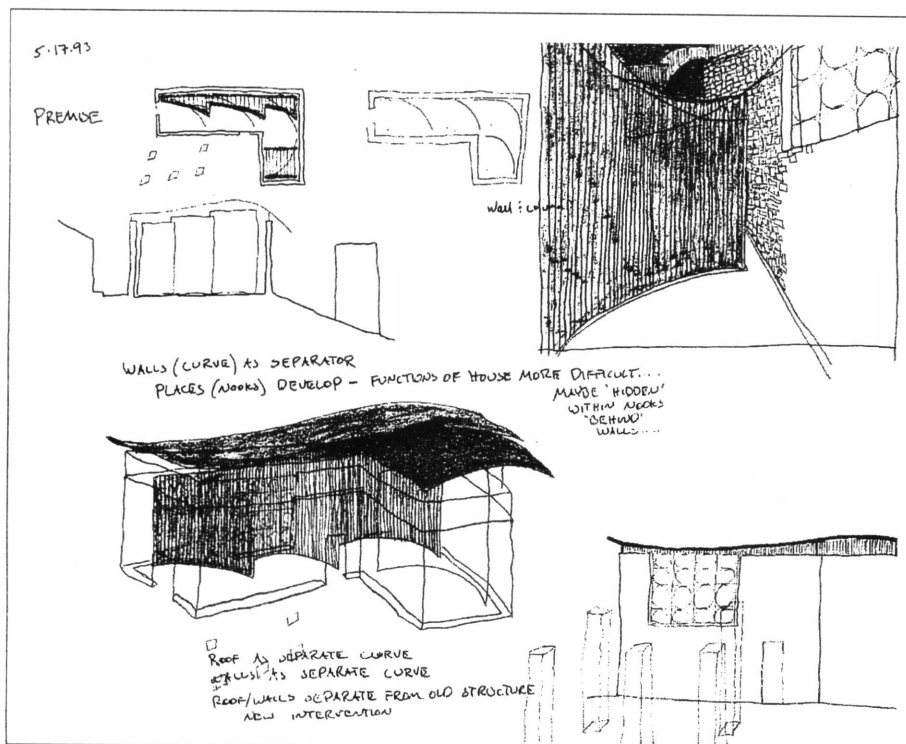
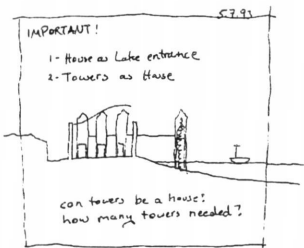
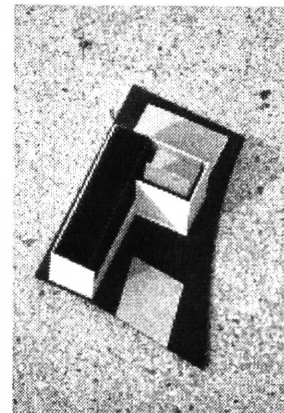

Premise 2: A curve, or several curves makes rooms and a roof. Still a separate entity within the wall. Curve of roof suggests a relation to the outside.

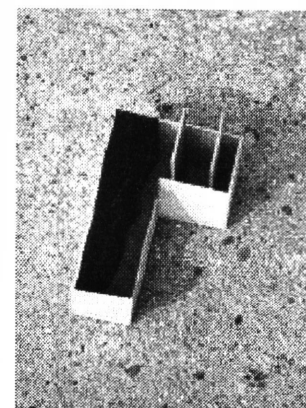

Premise 3: Towers that make rooms and define them. Different heights that allow for a curved roof. Towers that can be inside or outside. House as transition to lake.

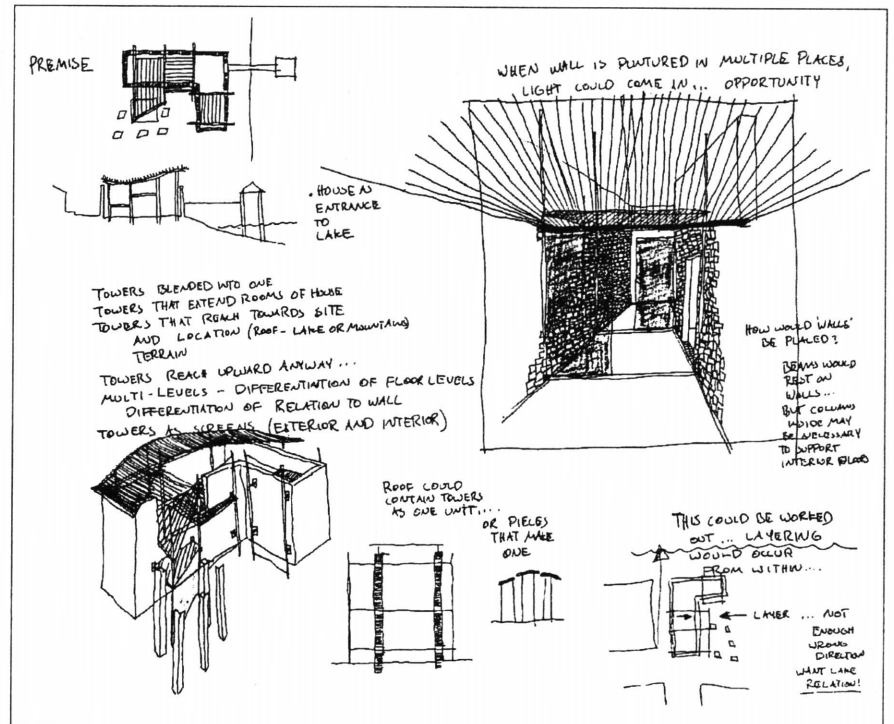
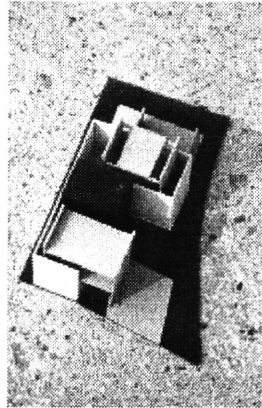

Premise 4: Towers as columns, not solid walls. Columns are rectilinear pieces similar to existing five exterior columns. In plan, idea of flow or how to walk through spaces from one room to another. Also, how to ascend from one level to another. Placement of towers; how many towers?

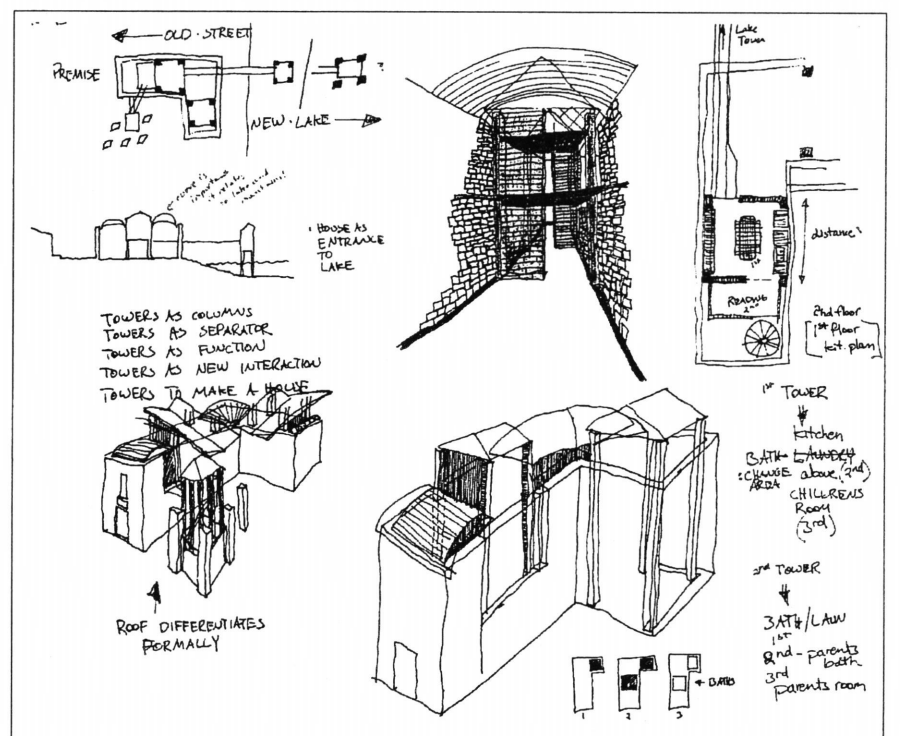

SIX PREMISES

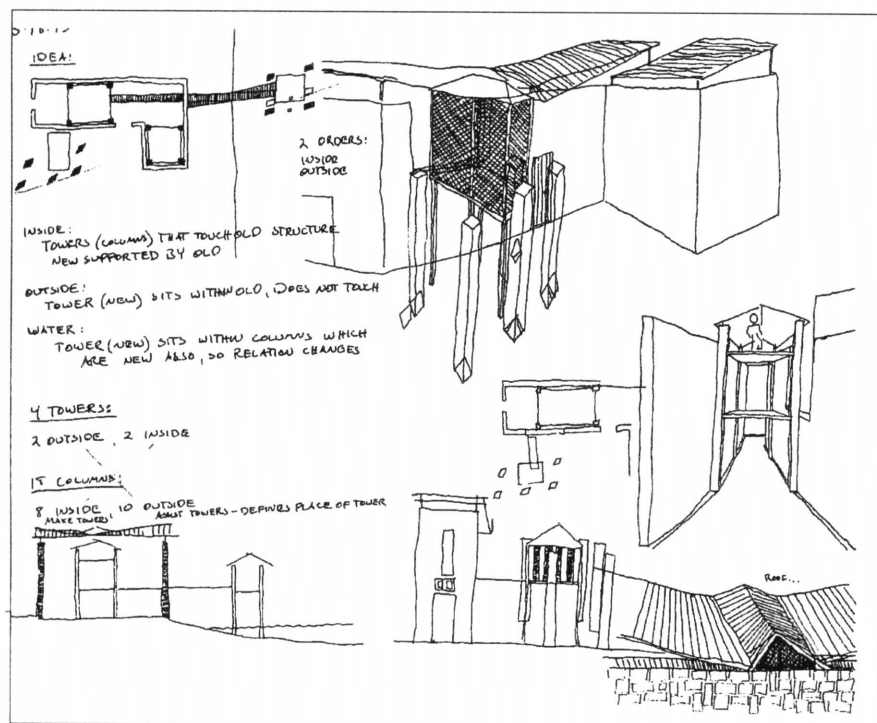

Premise 5: Possibly two kinds of tower, those within and those without. How high is a tower? Two, three levels? How are the exterior towers? One set within the five columns? Are they supported by them? Tower in the water...how is this one different or similar to the others?

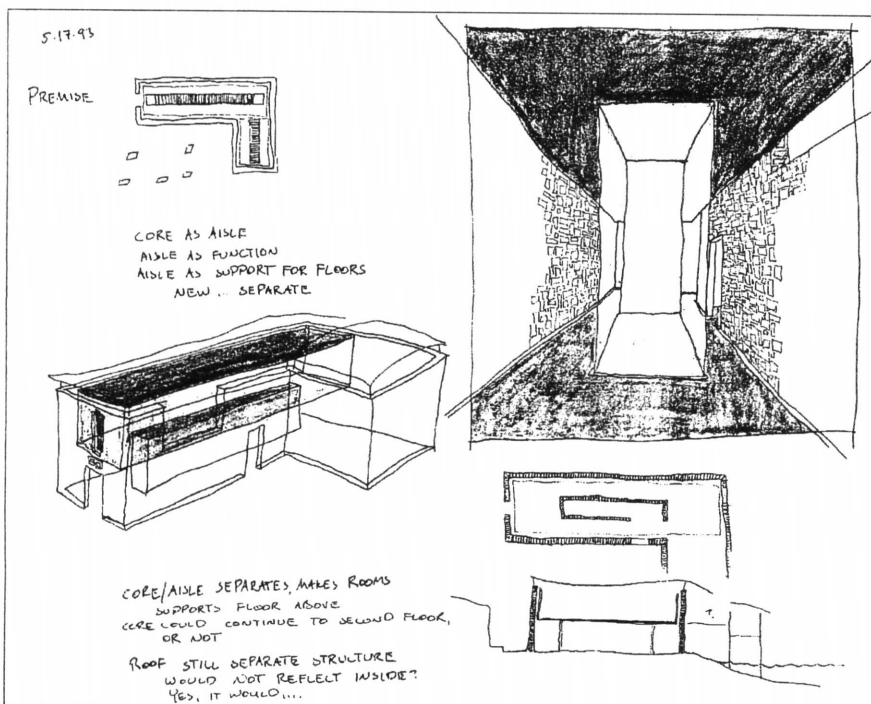
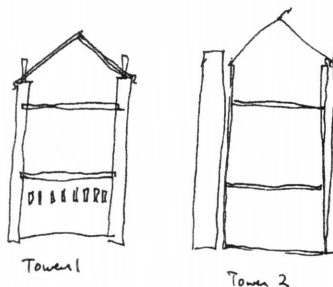
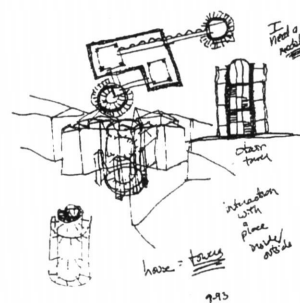

Premise 6: Separation of functional aspects of house. Can this 'core' define the rooms within? Are four towers necessary? How is the roof defined in this situation?

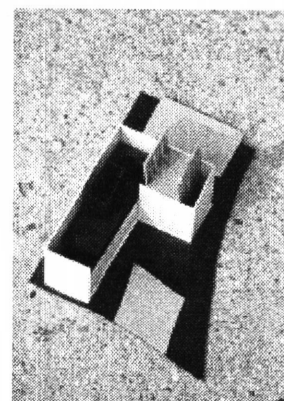

SUMMARY OF FINDINGS

It is apparent that the existing wall is vital to the project. The wall not only provides boundaries that enable me to work and design within, it also provides a remnant of another era, and therefore makes this thesis dependent on its presence. No matter what I propose on the site, it would be an act of this time, this era, juxtaposed with an earlier time. This ruin offers an opportunity to explore building a new structure within the confines of the old, and to contrast their character.

Premise 5 was selected for its organizational possibilities and the column-to-wall relationship. The idea of placing the new within the old whether it is located inside the wall or within the five masonry columns originates from this premise. A minimal intervention is decided upon due to space constraints inside, which contributes to the ordering of rooms. Conclusively, steel columns and beams were selected as the primary load bearing material for the floor and roof.

Contrasting steel to stone not only presents a differentiation in appearance, the inherent methods of construction and structural capacity also contribute significantly to the phenomenon of contrast.

The chapters following are a continuation of study and refinement. The goal is to maintain the qualities of the wall and the steel and to make the contrast apparent.

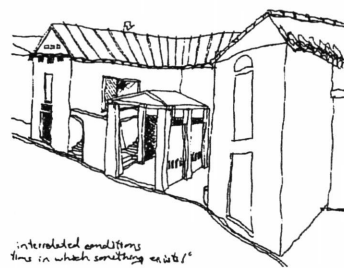

interrelated conditions
time in which something exists!

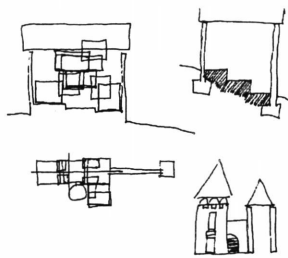

Graphite study of possible structure that supports two towers designed for functional aspects of house (two cores). Third lake tower studied...question arises of relation of lake to house, house to lake, the transition and overlapping of these places.

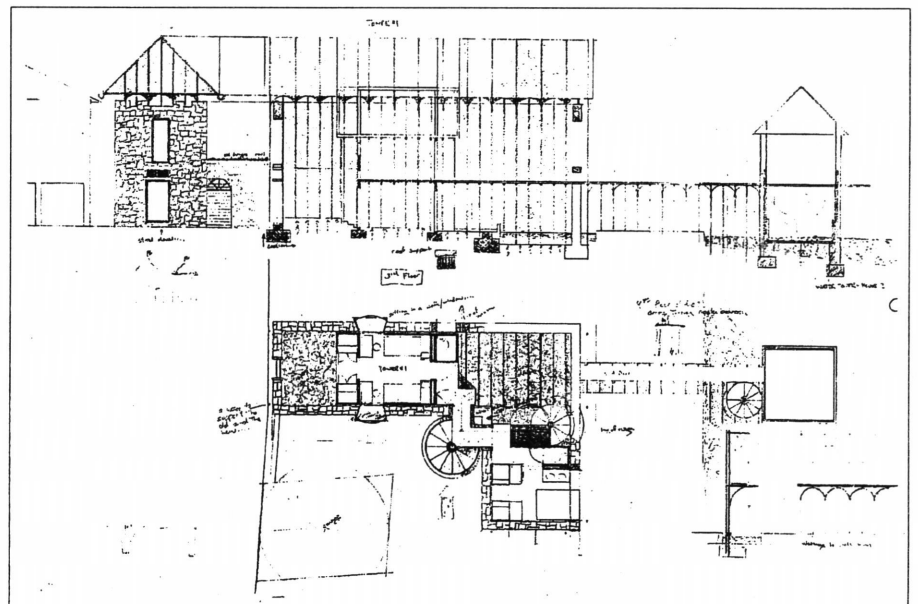

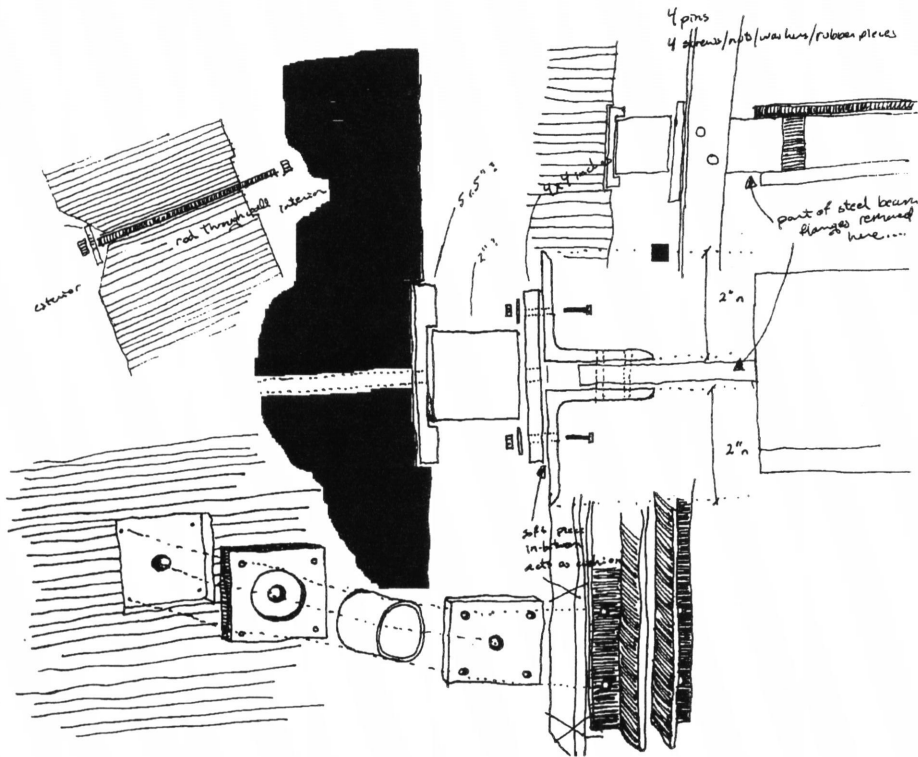

THE COLUMN

Primary criteria established are that materials are easily obtained and assembled, the design is repetitive, and lateral ties through the wall will support the wall.

The column also supports the floor and the roof. The ties through the wall occur at each floor, and a series of designed elements connects the column to the wall. Outside, the wall is cut away slightly and countersunk

to keep water out and to allow a bolt to recess within the exterior facade.

The column is braced at a distance of approximately four inches from the interior wall surface by a cylindrical spacer. This allows for the fluctuations and irregularities of the wall which the spacer accommodates, while maintaining the precision of the column within the overall structure.

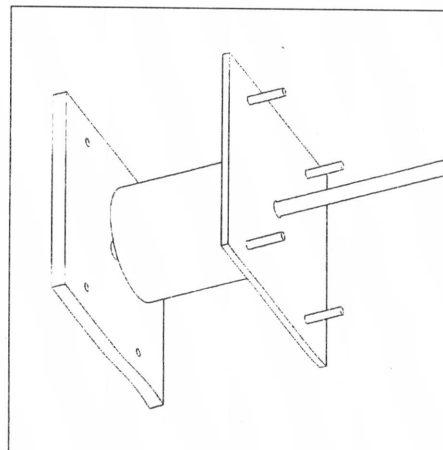
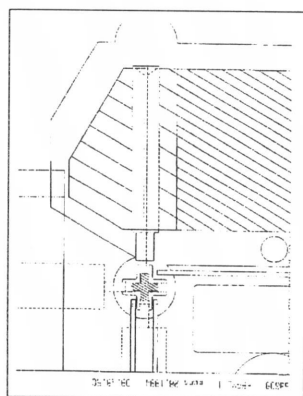
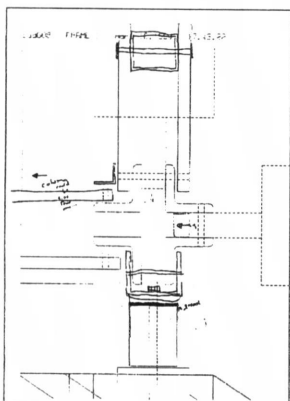

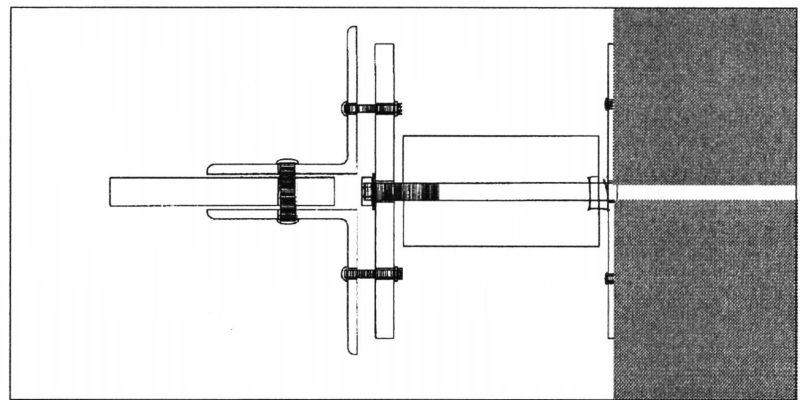
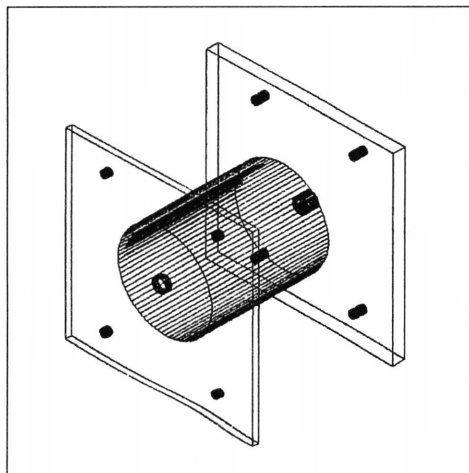
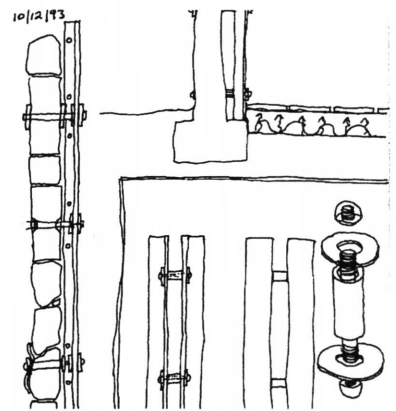
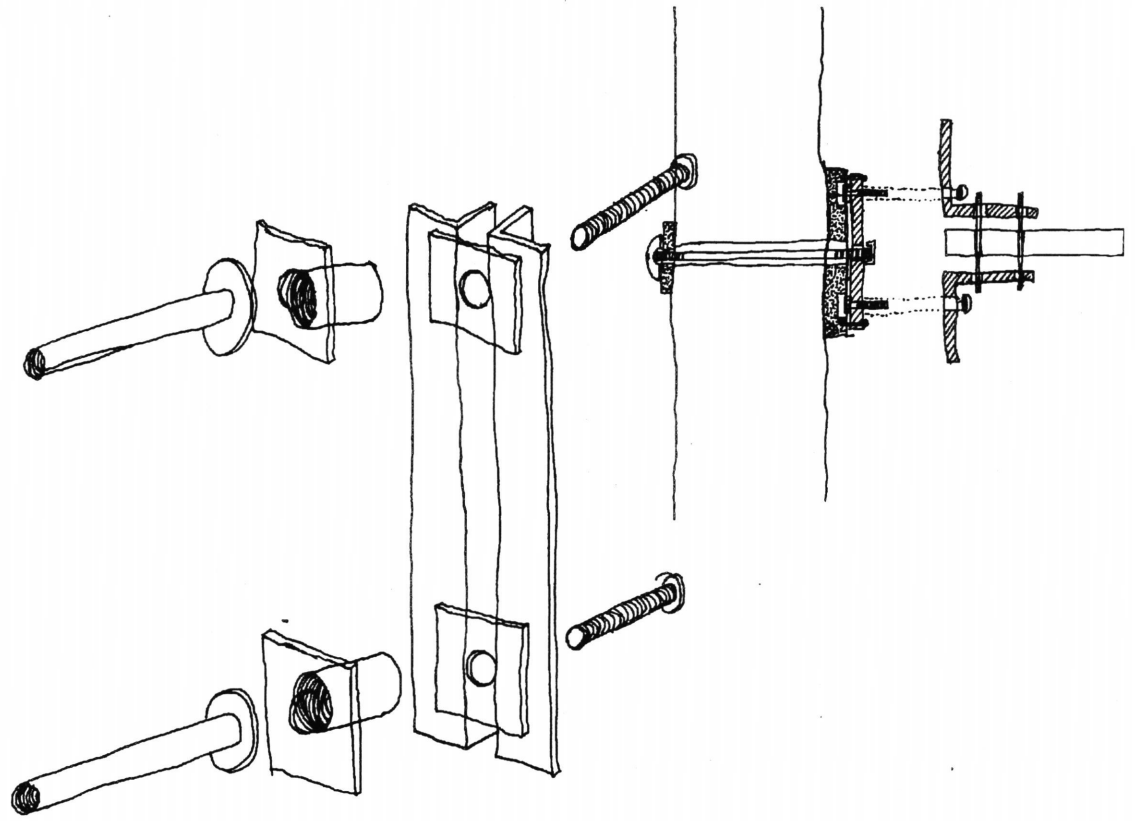

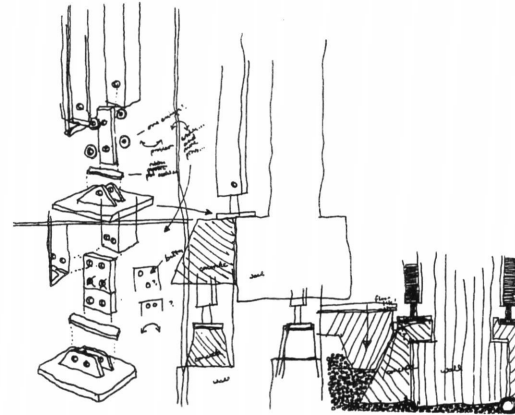
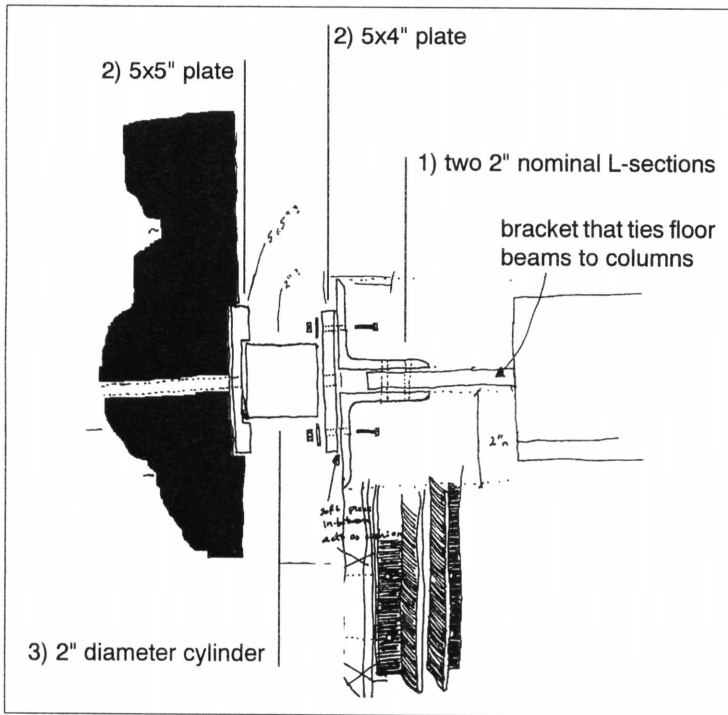

The column is designed to rest on the original foundation of the wall and is placed approximately four inches from the interior wall surface. All parts are easily made and assembled of aluminum plates, steel bolts and angles.

These parts consist of (refer to diagram above and photograph below): 1) two, 2" nominal steel L-sections, 2) two aluminum plates (5x4" and 5x5"), and 3) an aluminum cylinder 2" in diameter, 3" in length. (This cylinder is the spacer which rests in-between the two plates and is held in

place by a slight indentation milled into the 5x5" plate that fits the diameter of the cylinder.)

The smaller (5x4") of the two plates braces the two L-sections while the larger (5x5") plate is pinned to a concrete pad raised slightly from the wall at the point of penetration through the wall (see closeup photograph on the next page).

One bolt, just under one foot, ten inches long, runs through the middle of the two plates and the cylinder,

then penetrates through the wall where another aluminum plate and nut hold it together from the exterior facade.

A concrete cylindrical form is designed as the piece in-between the wall and the steel bolt. This part is preformed and placed within the opening to be cut through the wall.

These parts comprise one column. The column occurs fourteen times throughout the house, while the lateral tie through the wall occurs three times on each column, forty-two total (see axon on page 26).

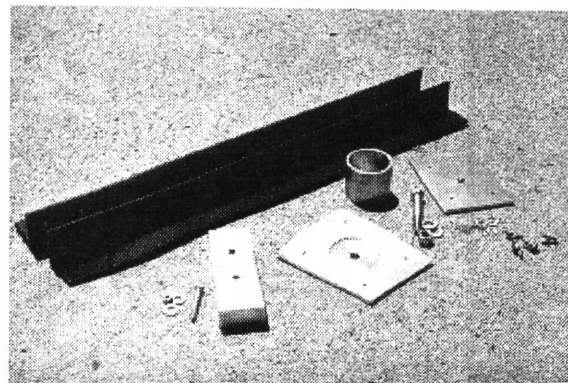
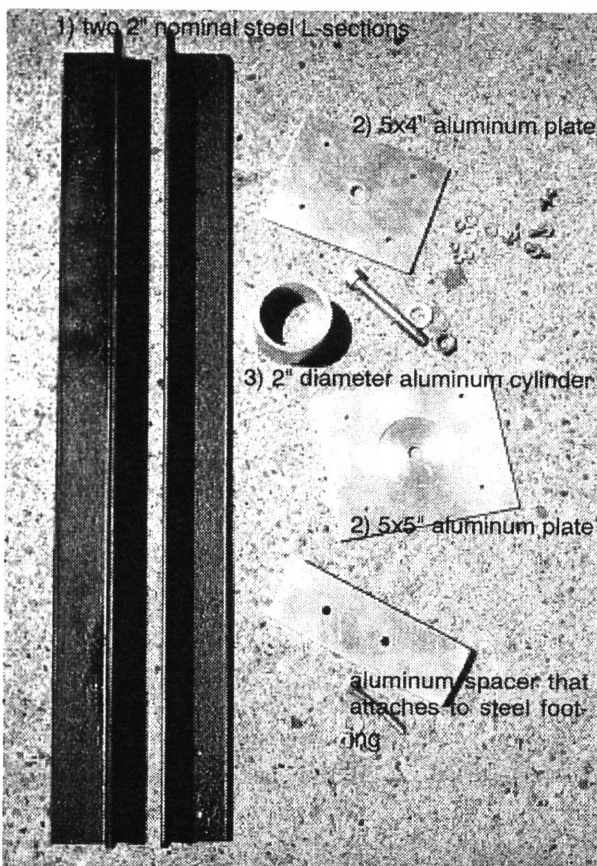

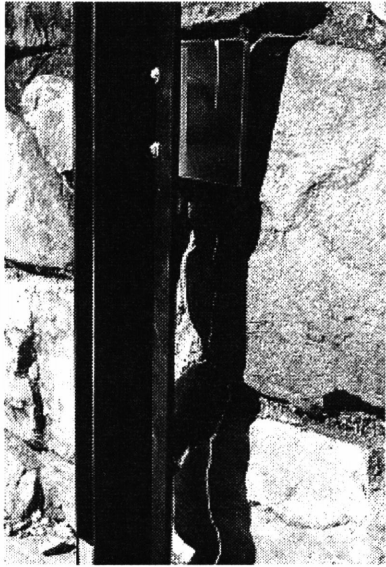
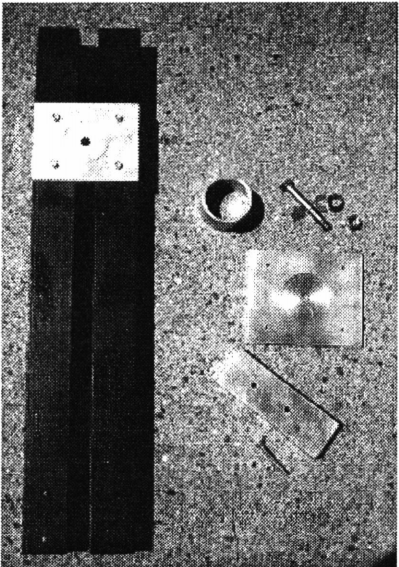
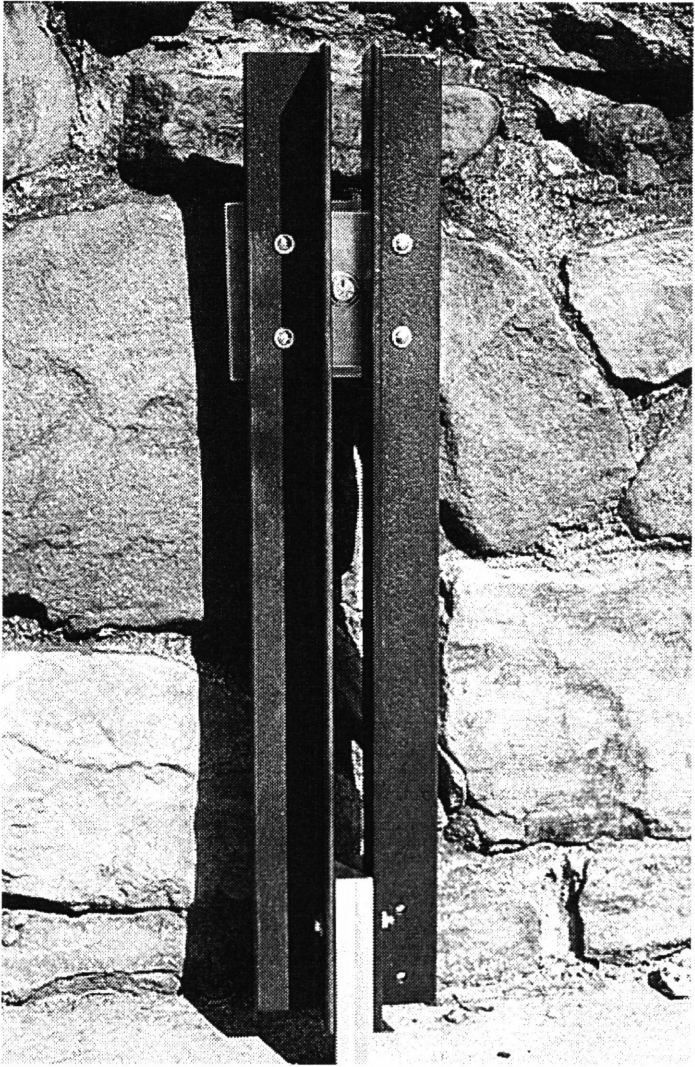

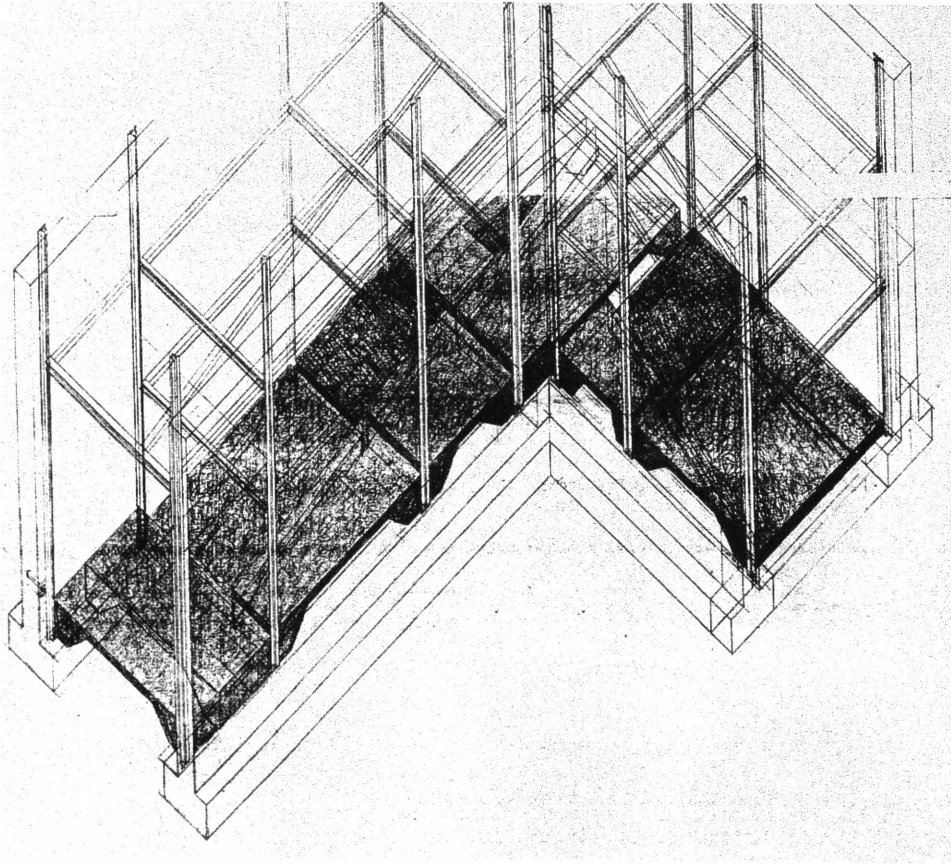

Room dimensions determine the placement of the main columns. Columns and floor rest on the wall foundation. Additional foundation support is probably necessary. The following models have basically the same interior structure. Questions target more specifically the roof, the five columns, and the lake. Earlier proposed towers are no longer present as separate entities, however in this model one surfaces again as a possible connection to the lake.

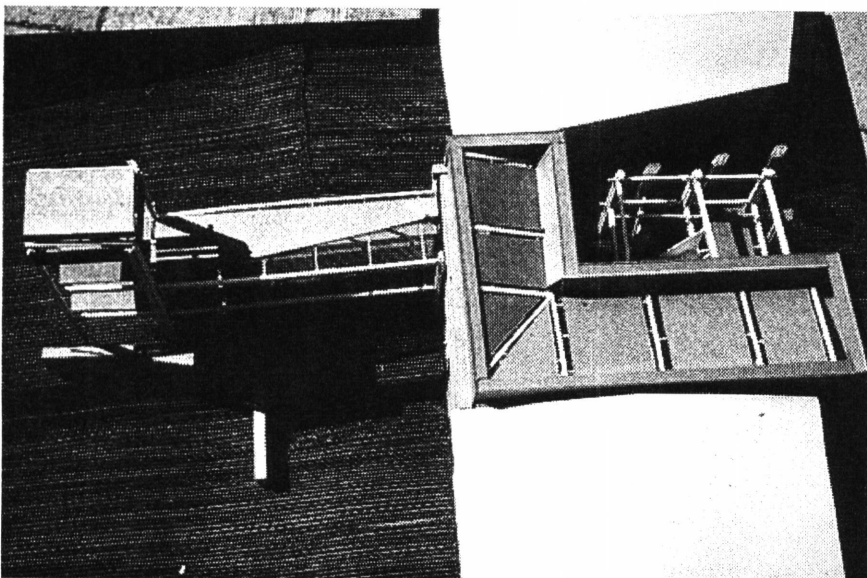
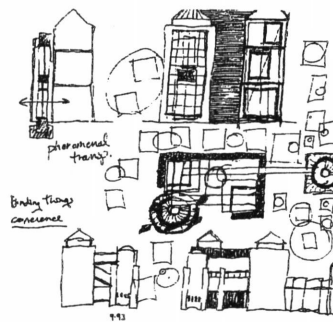
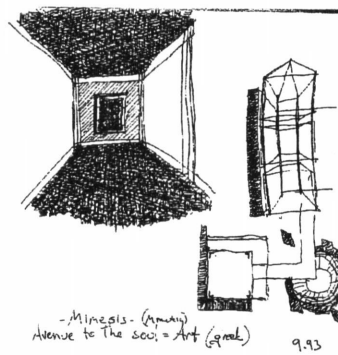

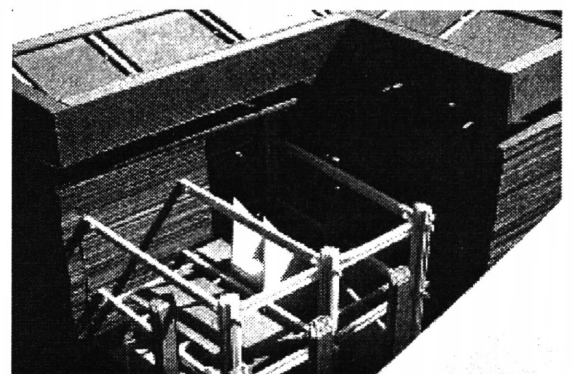
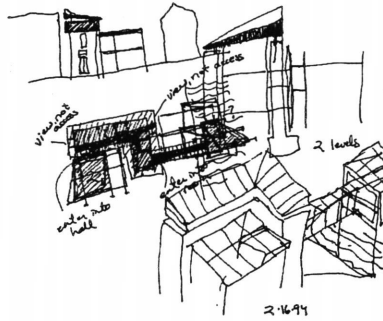
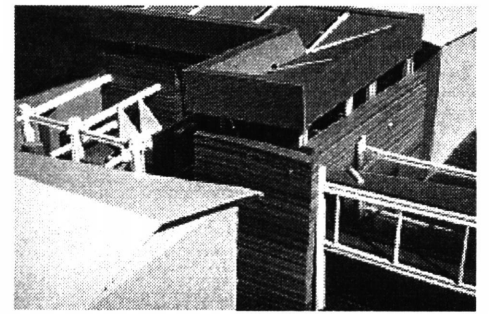
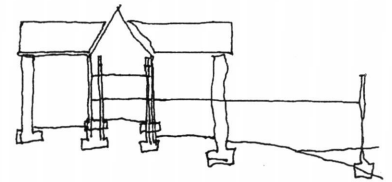
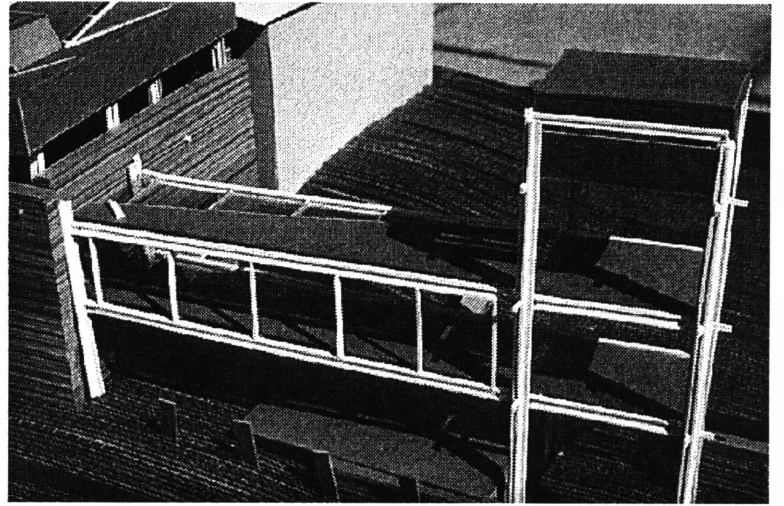
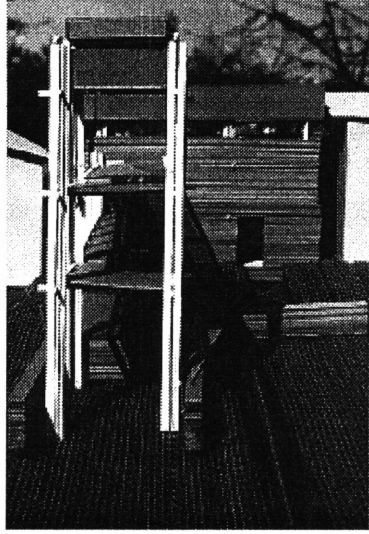

In this model, I explore how wall and roof meet. Specifically, the roof is an extension of wall. Inside, the wall ends four feet up from the floor. The chapter on details presents a possible solution.

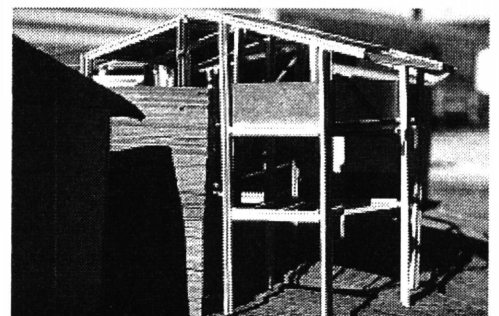
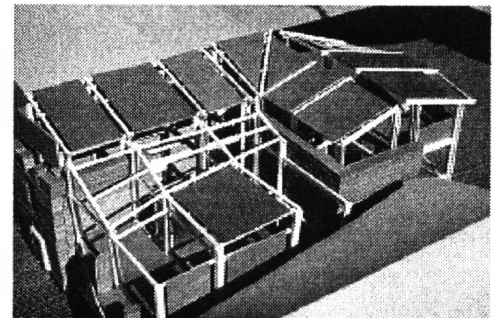
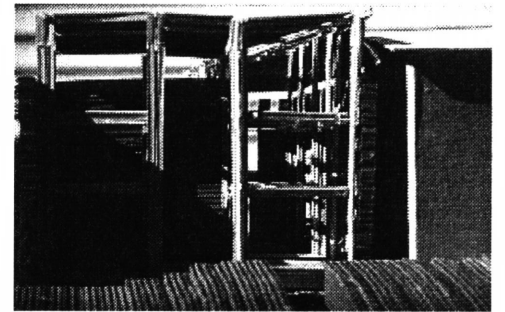
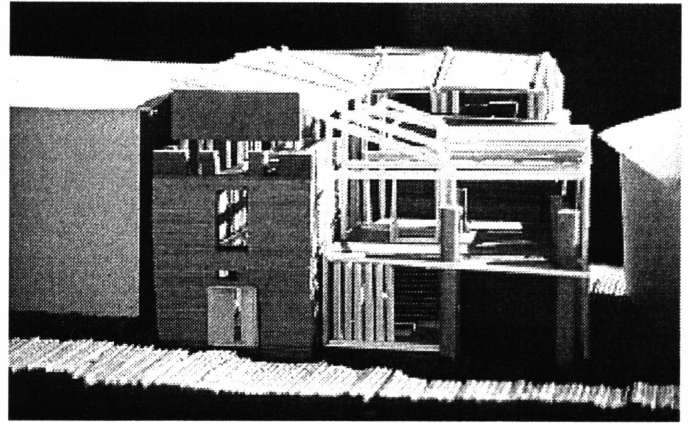

The roof now has a slope that extends down towards the five columns. This slope is angled to the south to catch as much precious sunlight as possible. Beams are exposed to make a place for windows to light the interior third floor.

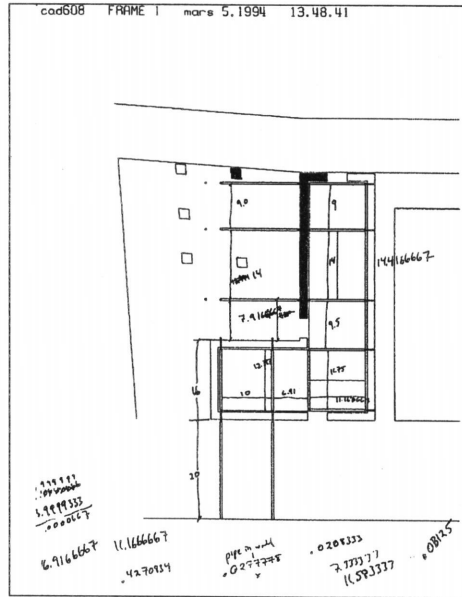
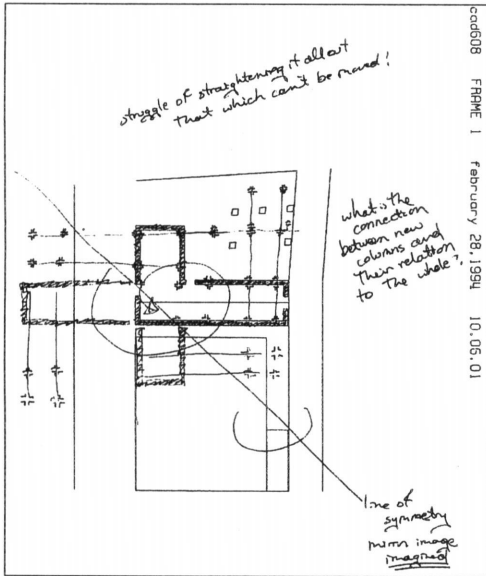

FIRST FLOOR PLAN STUDY

Drawing and modelling on the computer proved to be useful particularly regarding the question of scale. This series is an example of the process involved.

1) Column and beam locations are determined by room dimensions.

2) Stairways are formed around this constant. 3) Elements of the rooms are developed accordingly. 4) A fireplace is desired, and becomes a part of the old wall. A first connection to the lake is studied.

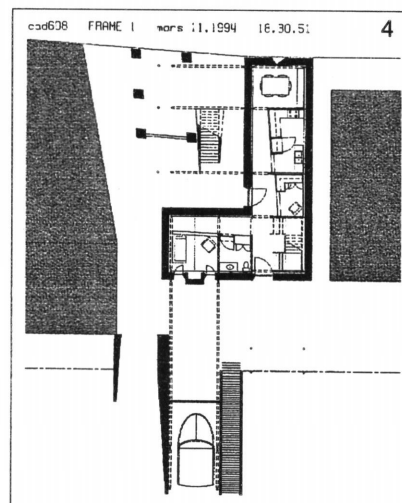
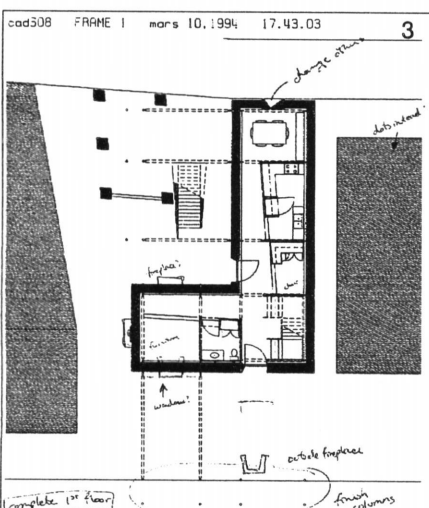
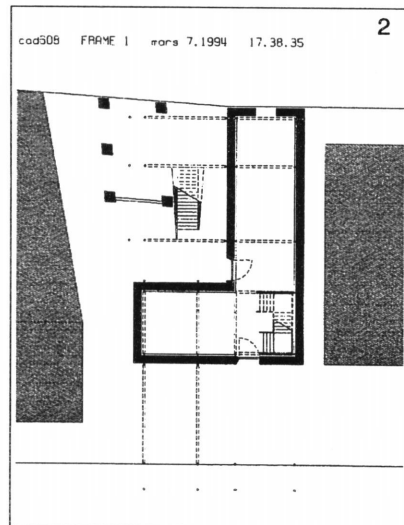
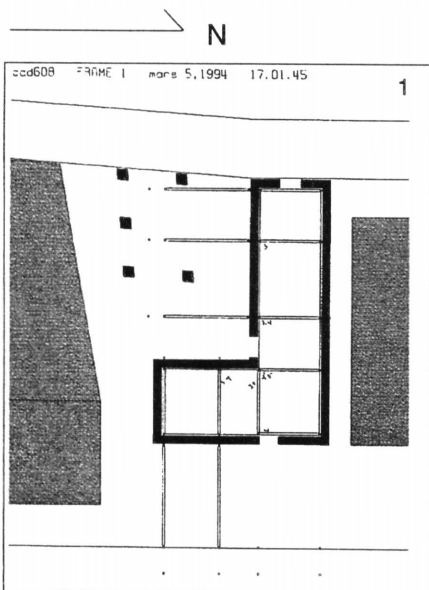

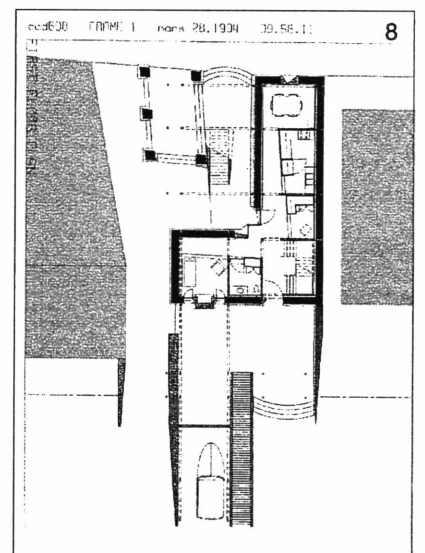
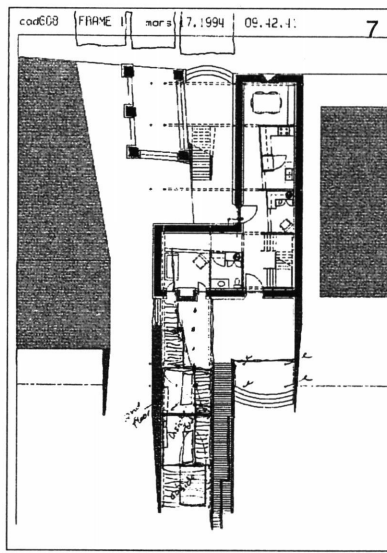
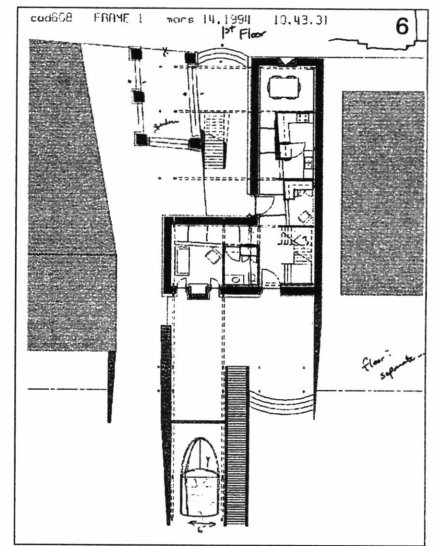
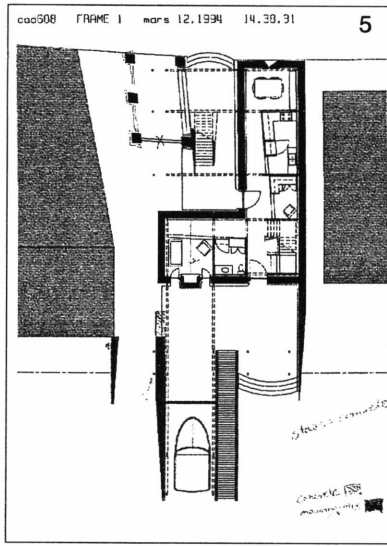

5) Exterior terraces are placed on the street and the lake sides of the house. 6) Area between the five columns becomes more distinct by adding several steps between the columns to separate it from common ground. 7) Angle of room elements to the wall is questioned, but not changed until later.

Exploration of the lake terrace continues throughout the study. 8) Small changes occur, specifically the location of hot water heaters (look closely at the closet space in the bathroom).

Page 36 contains more recent versions of all three floor plans.

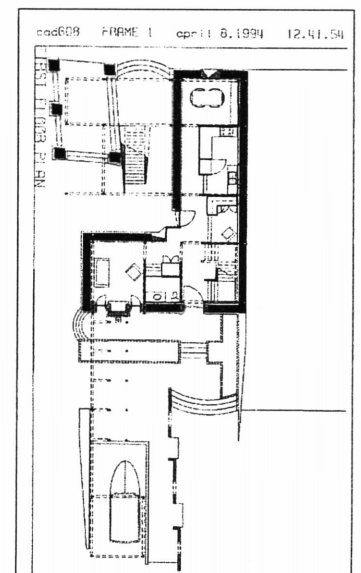
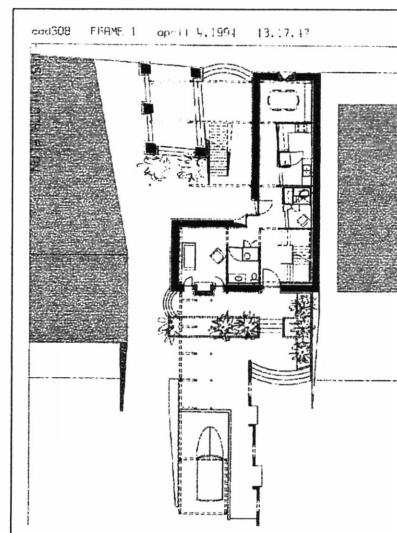
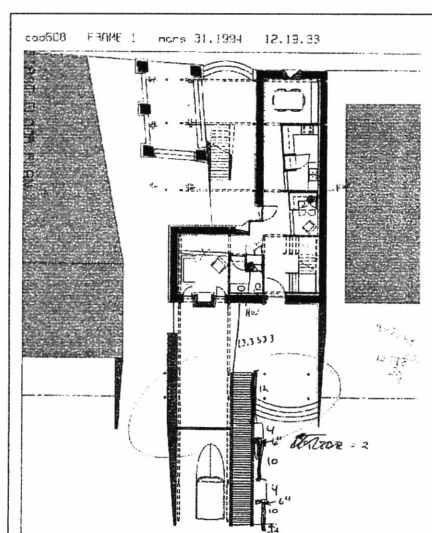

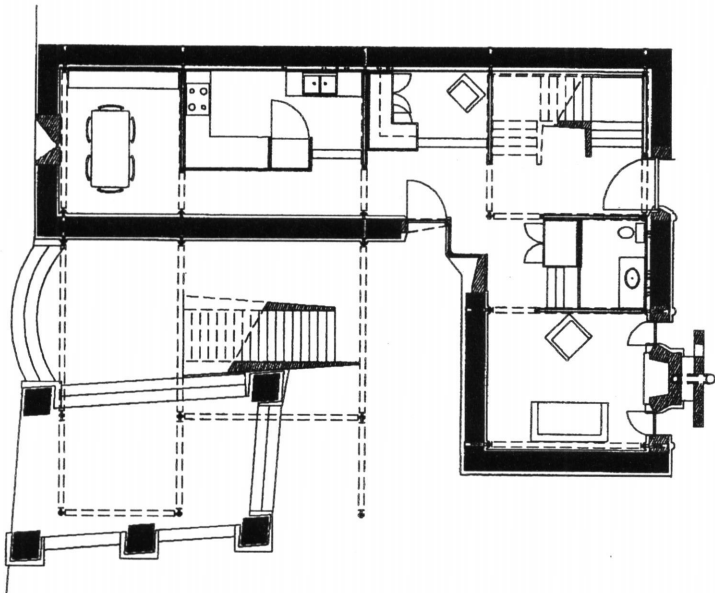

PLACES OF A WALL

Findings:

What can a corner become? How can it become a place to be celebrated? The corner announces the entrance to the house, which is within the 'courtyard' and off the street. A corner can be a place to stand within, it can be a window or a floor. Glass encloses this corner and defines the shape of the floor held within.

A corner can be a room for one person, maybe two. A place to see without being seen.

A corner can bring light into a dark place. The corner exists within and extends beyond the confines of the wall.

The wall defers to the corner. It is in fact, cut away and replaced with the new structure. The corner that is built is a mirror image of its former self, in specific placement and in shape. Materials used are of the language of the new structure. An intermediary piece is introduced that becomes the

in-between or transitory element that embraces the wall and supports the corner. (See sketch on pg. 32.) Its character is that of an in-between element. Smooth to the touch (like glass) and made of concrete, formed at the site, and placed like stone.

Early study of possible corner condition. Plan view and view from interior looking outwards.

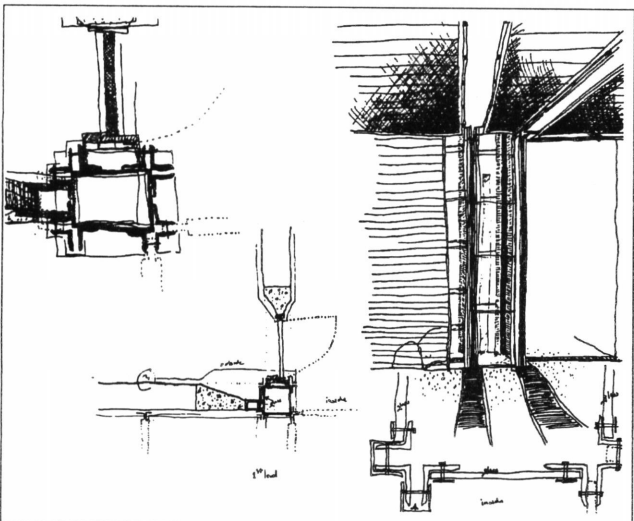

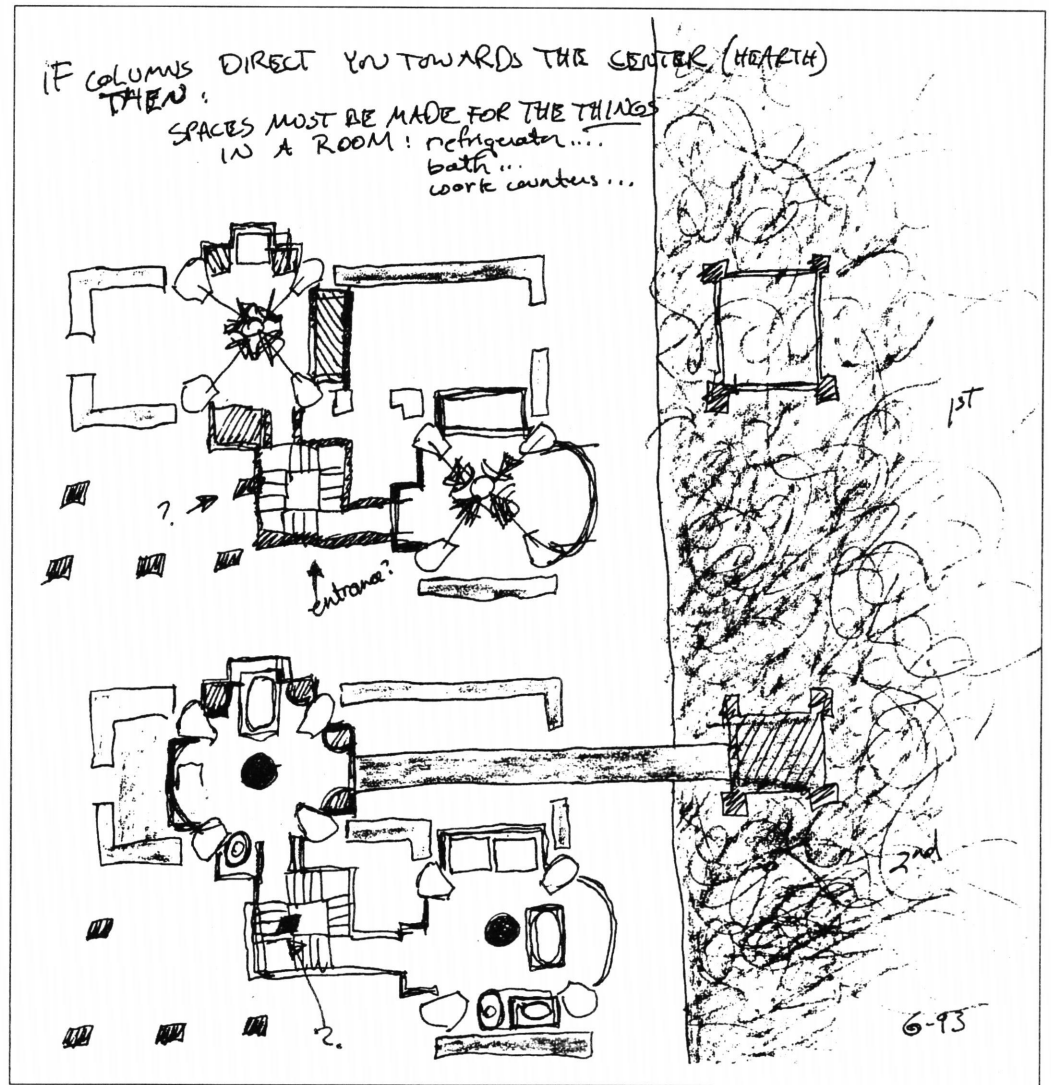

Study of two towers as separate entities and how they might penetrate the existing wall. Also looking at how these towers could become rooms and make places for the elements of a house.

Exterior
 Walls should reflect interior aspects

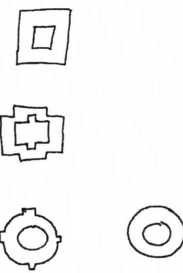

First floor and second floor plans shown. One of two places (fireplace is the second) where the wall defers to new structure through demolition.

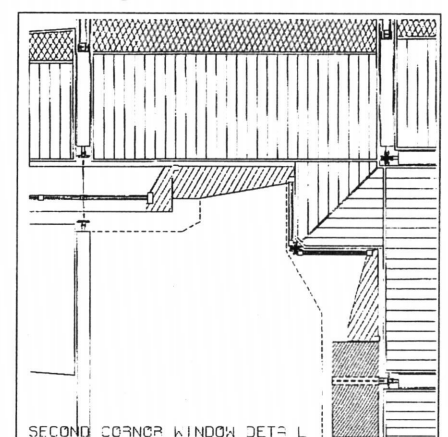
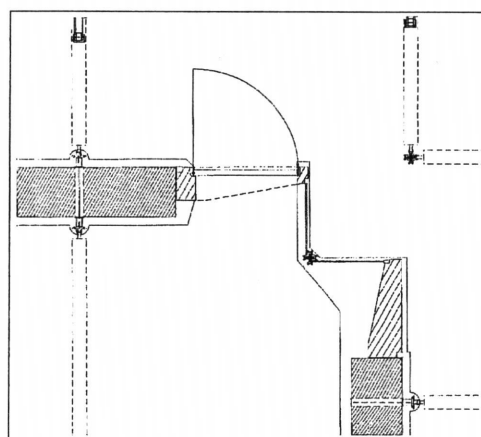

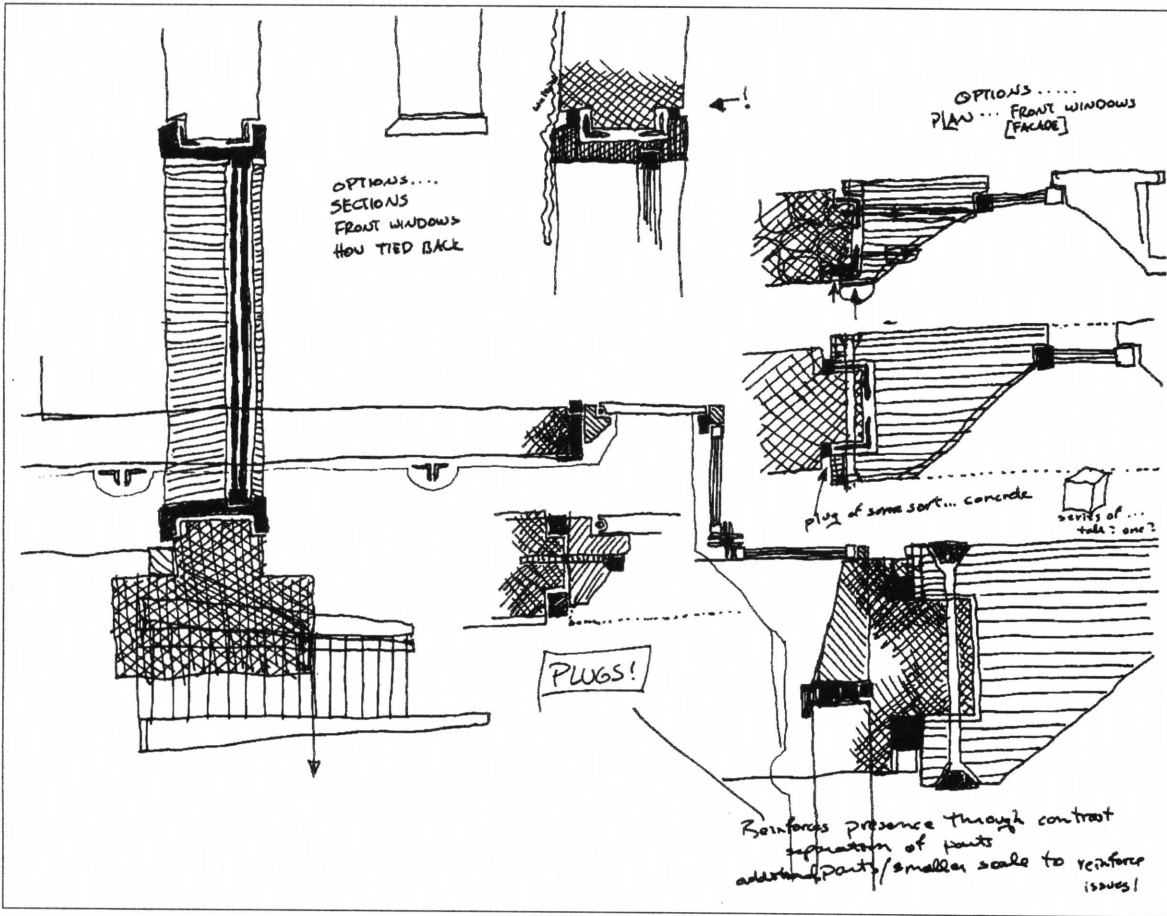

Connections between the original wall, the pre-cast pieces, and glass.

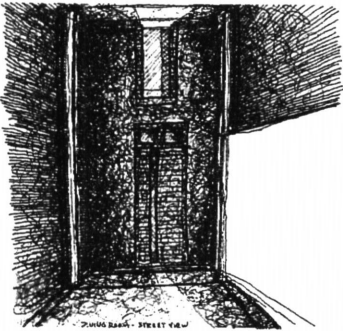

Final decisions on how a wall can become an event. Sketch shows the window to the street from the dining room. The ceiling is the bottom of the third floor. The plot below shows how the window becomes a room for the street.

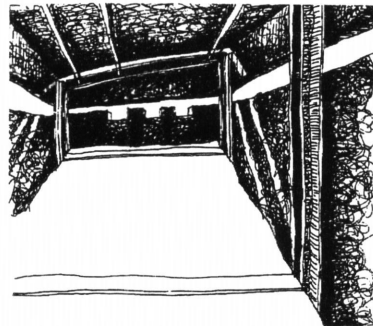

Third floor windows. In the plot below, note the penetration decisions of the column through the wall and of the windows through the wall. The windows on this floor also become elements of the street as the first and second floor windows do.

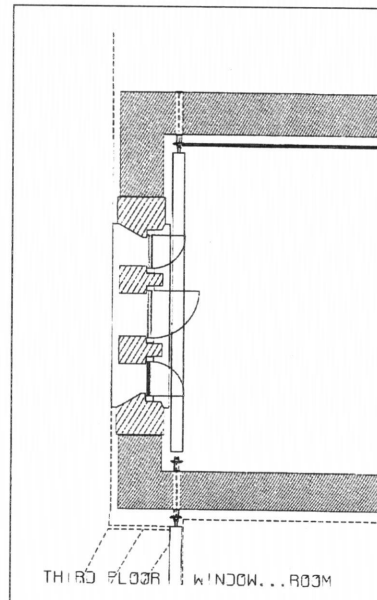
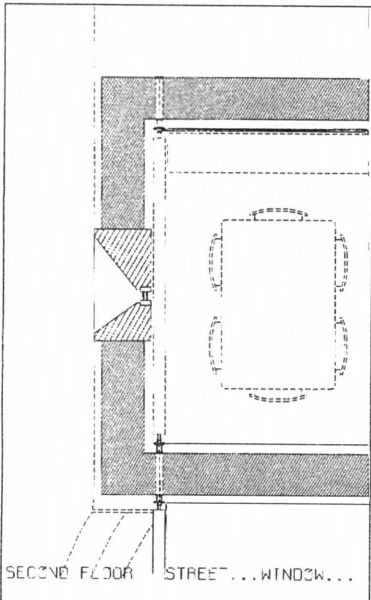

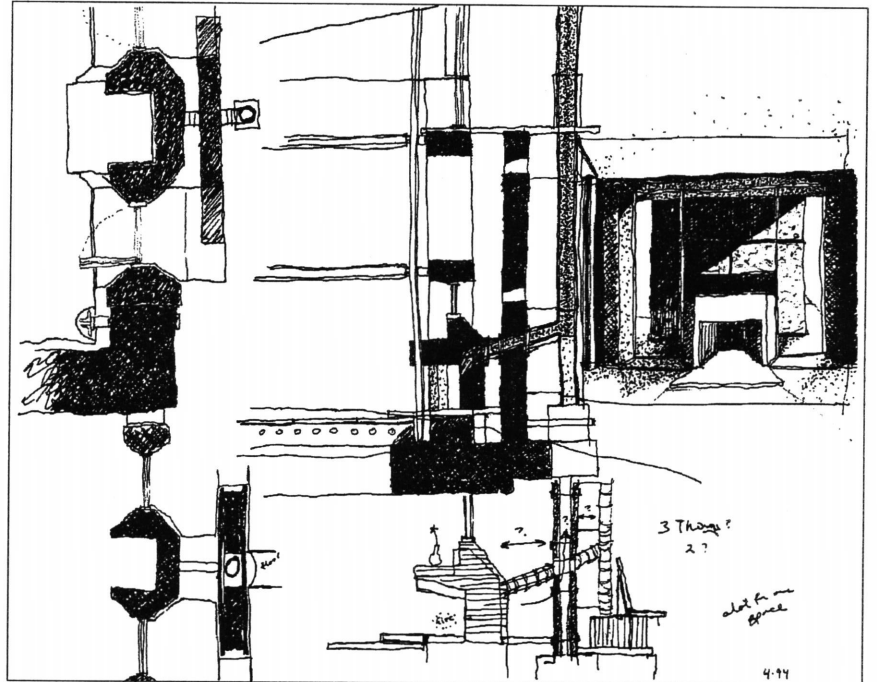

View of fireplace and wall from the inside ground floor room. Studies of fireplace and wall.

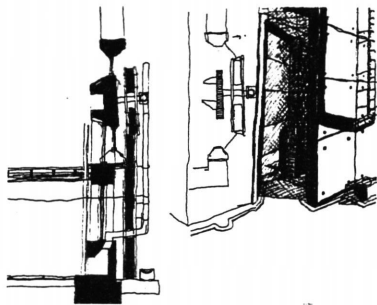

The wall is cut out and moved slightly away from its origin. It reshapes itself into a fireplace on the ground floor, and then, in the form of a wall, it extends out and up to the roof. The wall sits four feet from the edge of the old wall, and is actually reconstructed with poured-in-place concrete. It provides a place to enter or exit the rear of the house, it provides a level of privacy for the rooms on the ground and second floor, it makes the rooms appear larger, and it blocks direct sunlight.

The new wall also creates another moment of transition between two places, the inside and the outside. The four foot distance it sets up begins to suggest this simultaneity. This is a familiar theme that runs throughout the project, starting with the connection designed to penetrate the old wall (see pg.20).

The plots below show how the wall relates to the first, second and third floors.

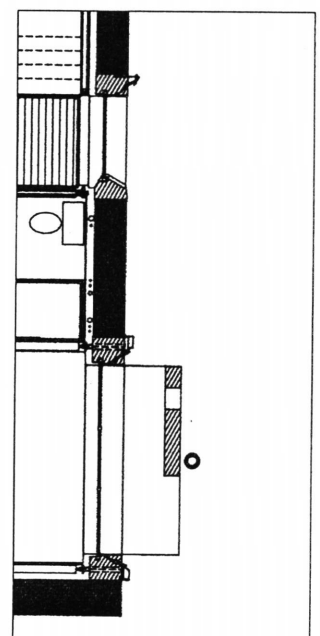
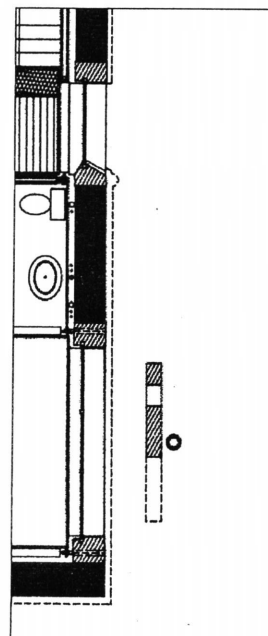
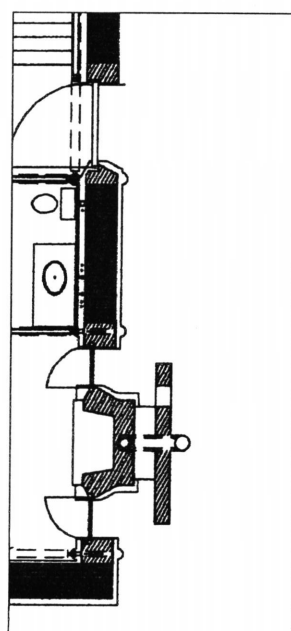

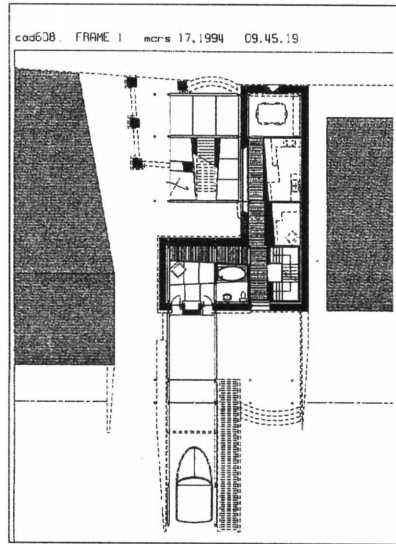
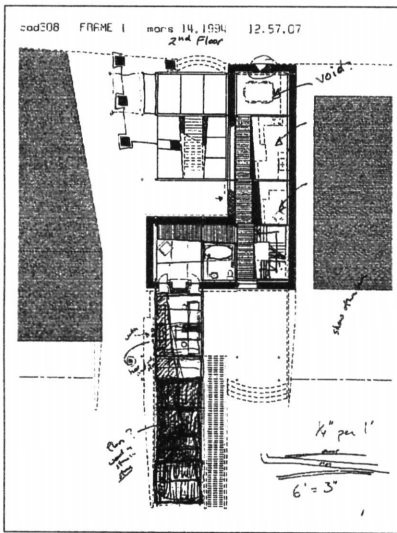

SECOND FLOOR PLAN STUDY

The series of plans presented are a continuation of studies done during the design process. They show the level of interaction between the computer output and my hand. The second floor series in particular looks more specifically at the terrace to the lake (changes can be seen in the plots). The first floor series presented earlier (pg.28) explores interior rooms.

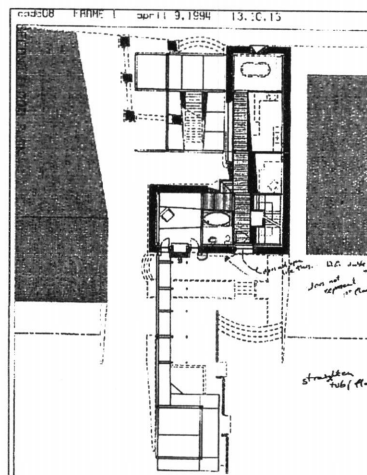
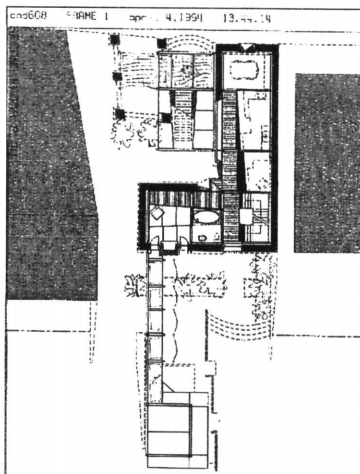
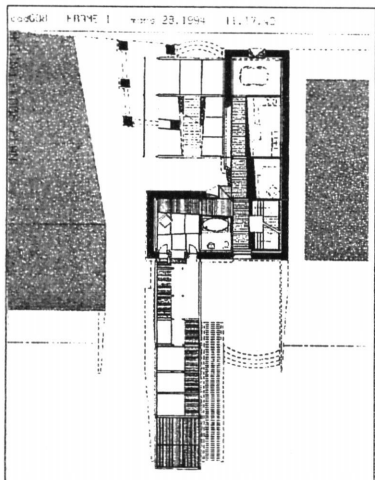
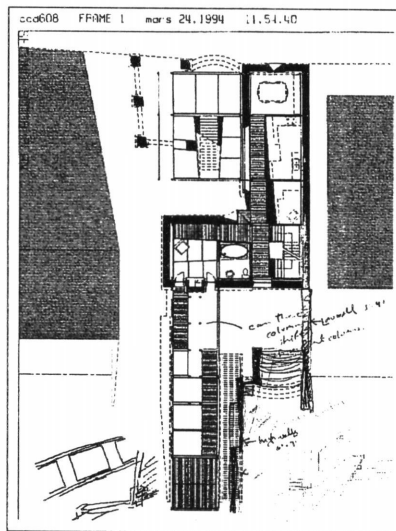
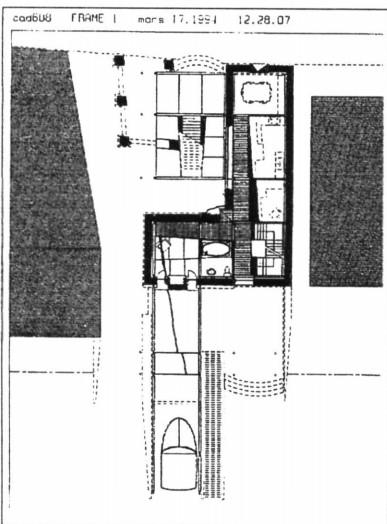

THIRD FLOOR PLAN STUDY

The idea of rooms as separators continues on the third floor. The elements of a room, such as a closet or a laundry area, make the barriers that exist, especially between more private rooms. A hallway penetrates through several rooms to complete its destination to the bedrooms. Even the hallway is a part of each room,

like the closet or laundry. I do not think of it as separate from the rooms that it passes through.

The plans on the following page show the decisions.

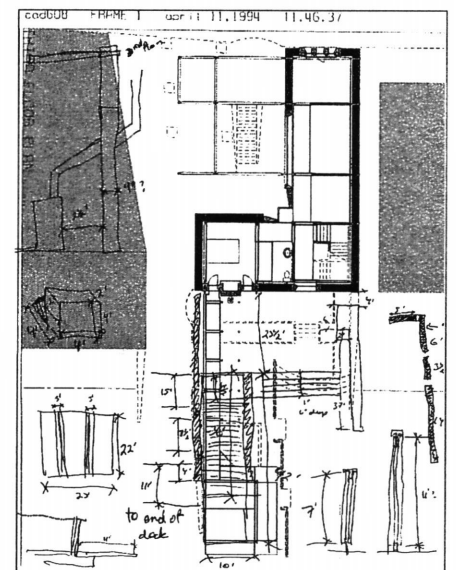
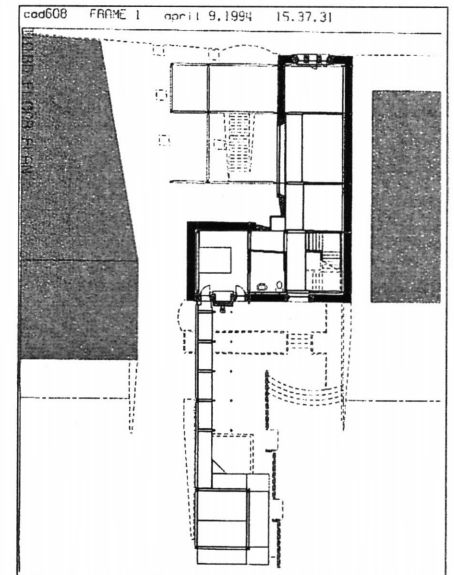
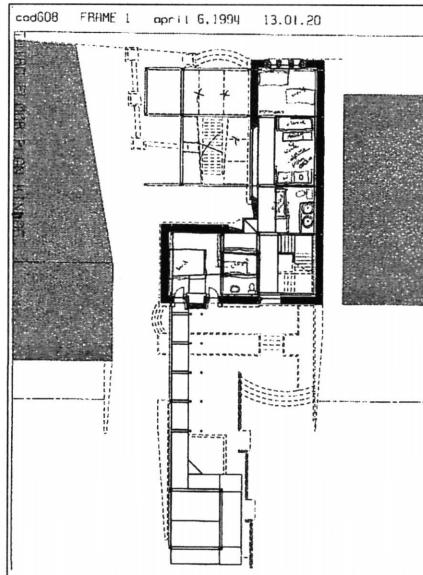

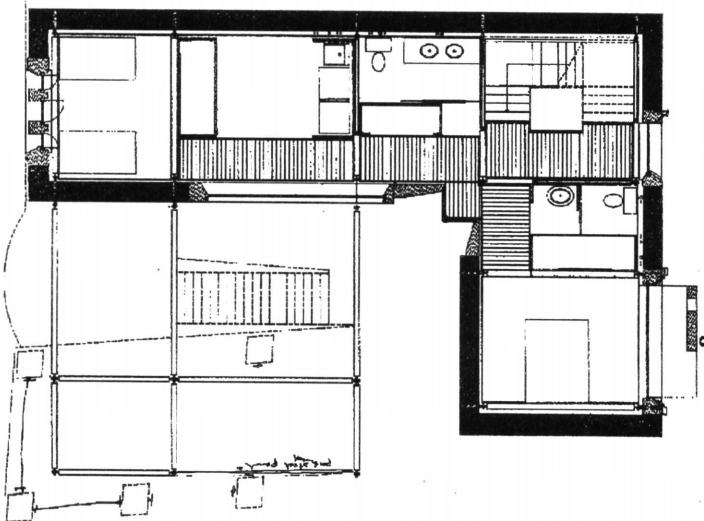
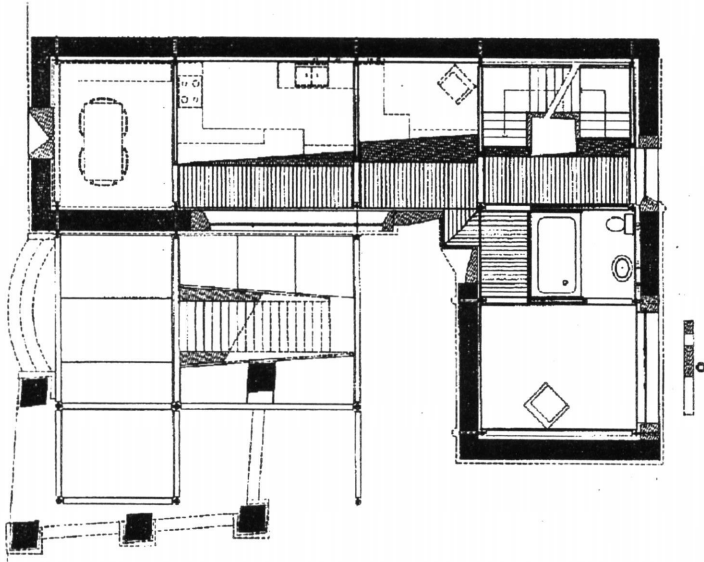
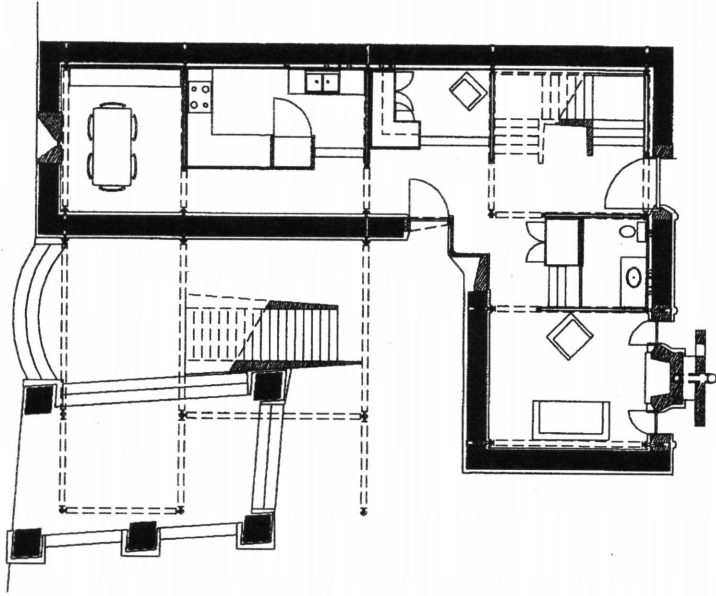

FINAL PLANS

First Floor

A living and working floor. A place to gather as a family and with friends. Dining, kitchen, front entrance, bath and family room are all located on this level.

Second Floor

An in-between place. Open to the floor below over the dining, kitchen and entrance rooms. It is a place to watch others from above or just to sit in the sun. A large window opens out to the second level terrace. This window does not extend down to the first floor, it begins at the second level and rises upwards to approximately six inches above the third floor. The bridge-like second floor filters light that flows into the kitchen below from this window.

Third Floor

A private, sleeping floor. Bedrooms for the children and the parents are separated to provide privacy by a working/laundry room, two baths, and a stairwell. This level is lighted by a clerestory window that rests on the two facades facing the five columns and by the skylights that expose the roof structure.

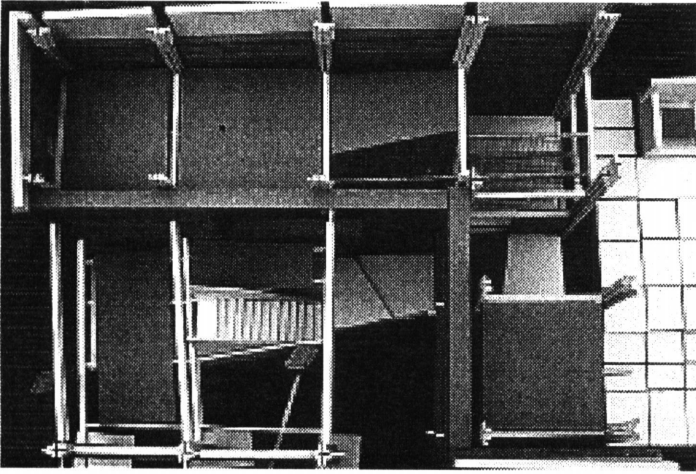

Birds-eye view of new structure nested within the old wall.

FINAL MODEL AND ELEVATIONS

'...he manages to turn walls into entrances and entrances into places, thus rendering accessible what is solid. Transitional places which invite people to stay.' 'In fact, what actually happens is that familiar ingredients and shapes are brought together in a particular way which releases them from their established functions and fixed meanings. Thus relieved of this load and in a new setting, they evoke fresh associations. By shifting the point of focus, portions of what was thought to constitute

an indivisible whole assume other meanings and characteristics and thus are free to fulfill other functions.' 'This brings us to cubists again, and in particular to the early collages of Picasso and Braque; to the way everyday objects and materials are taken out of their accepted context and placed in a new one, altering their significance, which in turn sets off sequences of new associations.' - Herman Hertzberger, *Hubertushuis*, Aldo Van Eyck, p.26

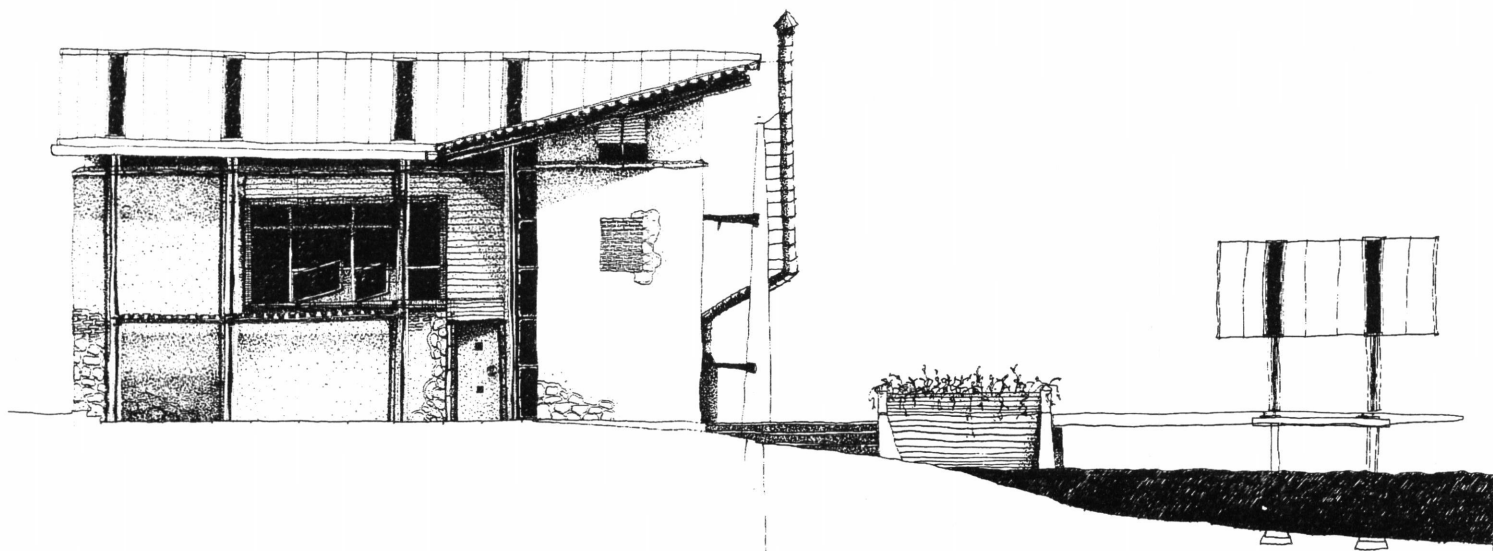

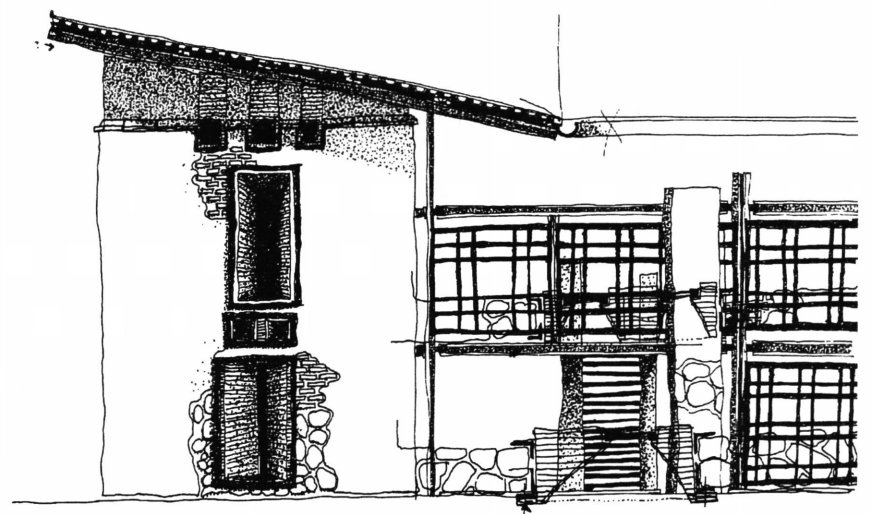
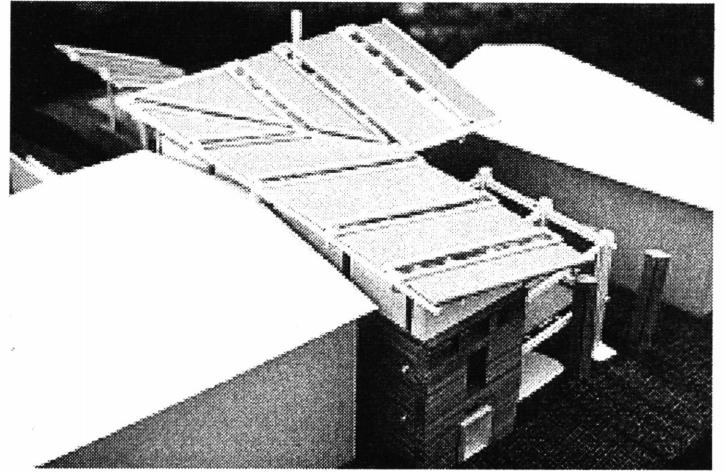

STREET FACADE (WEST FACADE)

capone steel, needs rust protection!



View of how the new rests within the old.

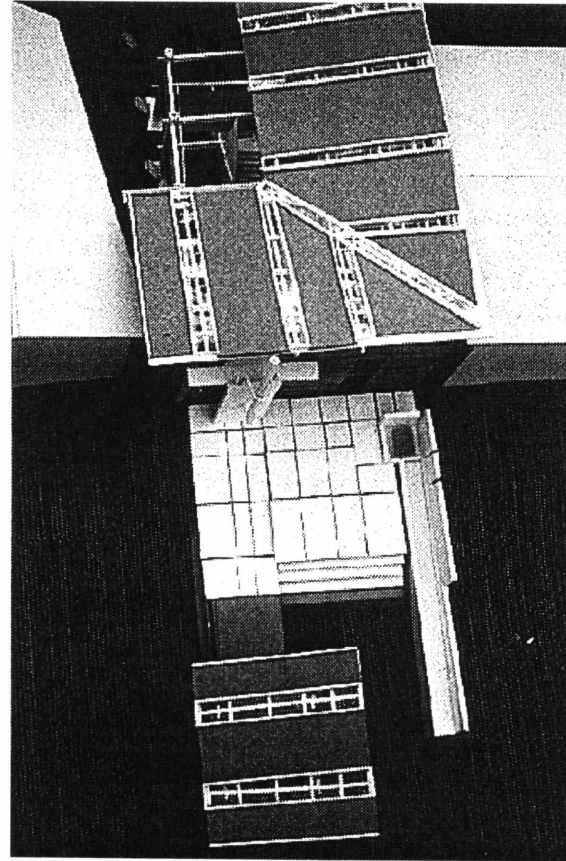

Birds-eye view of model. The terrace is designed to meet the lake. Its pieces are made up of the same stone as that of the inside.

An exterior view of the fireplace and third floor four foot wide balcony. The old wall is cut and pushed out approximately four feet from its origin. (Actually, this 'new' wall is rebuilt using poured in place concrete.) Its placement begins to suggest an extension of the realm of house which exists not only inside but also outside of the wall.

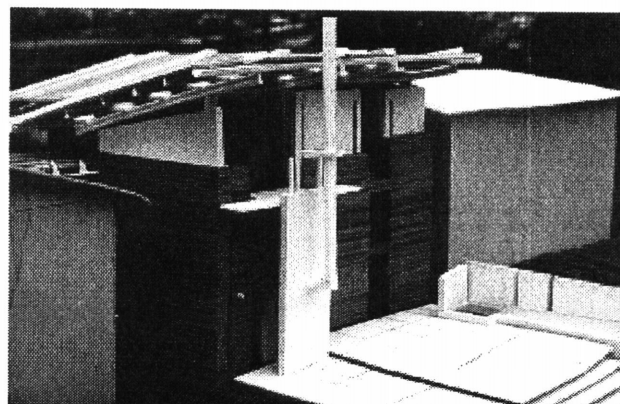
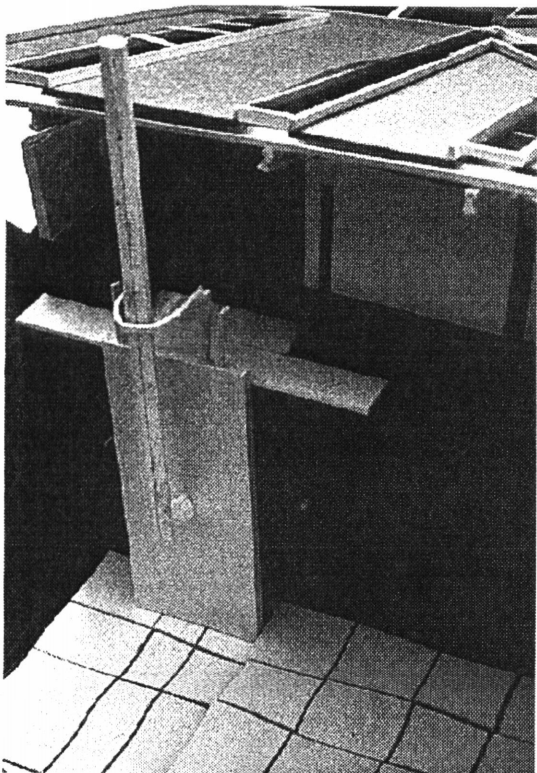

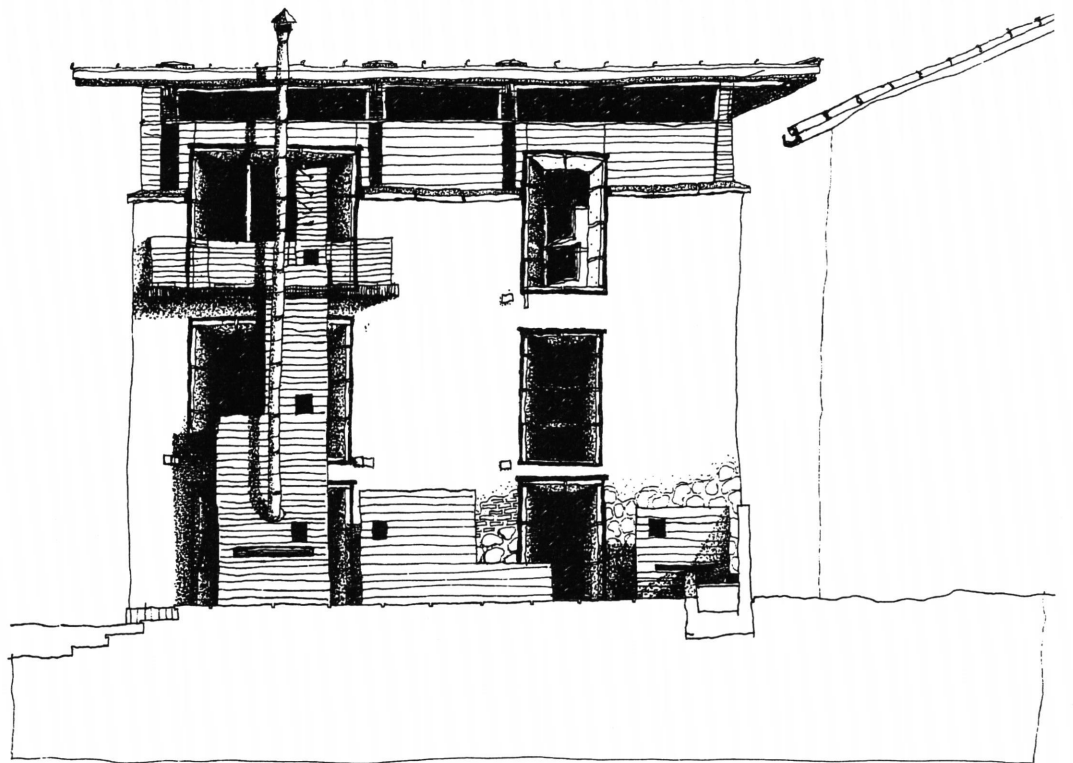

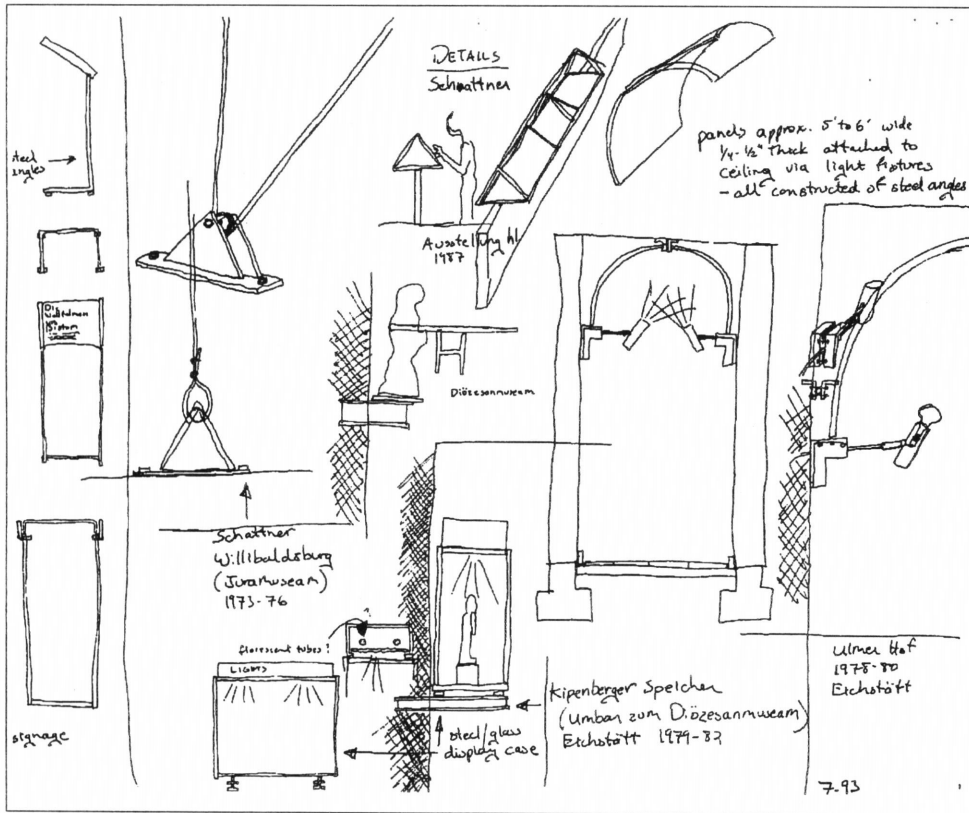

DETAILS

Schattner and Scarpa are strong influences in my work. Schattner's orphanage in Eichstätt was of particular influence in making decisions about the steel structure. (See sketches below.)

Scarpa's Castelvechio became a resource for thinking about floors. Particularly, the transition that can occur from the wall to the floor articulated

by changes in materials. This transition supports the idea of deferring to the fluctuations of the old wall. Scarpa continues to defer to the will of the wall throughout the project by placing designed objects some inches from the wall, instead of against the wall, or even in the middle of the room. The result is that the old and the new exist together in harmonious tension.

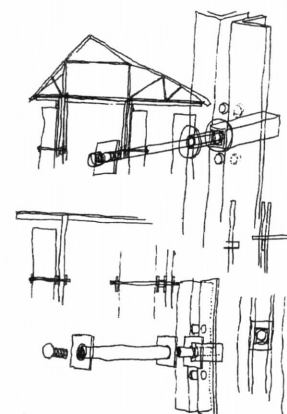
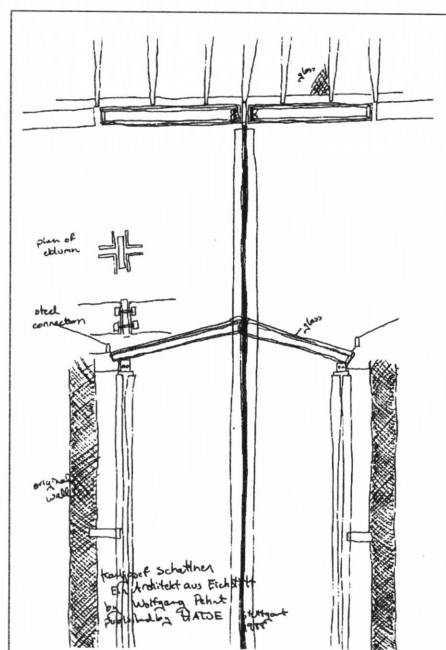

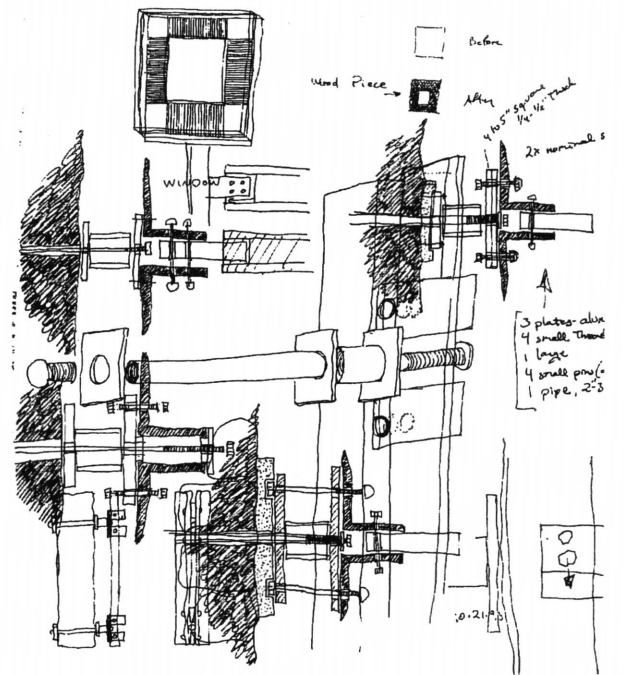

Exploration of column and its connection to and through the wall. The concrete pad can be seen in this study, which is located at the penetration point through the wall.

Schattner study of the Halle des Alten Waisenhauses in Eichstätt.

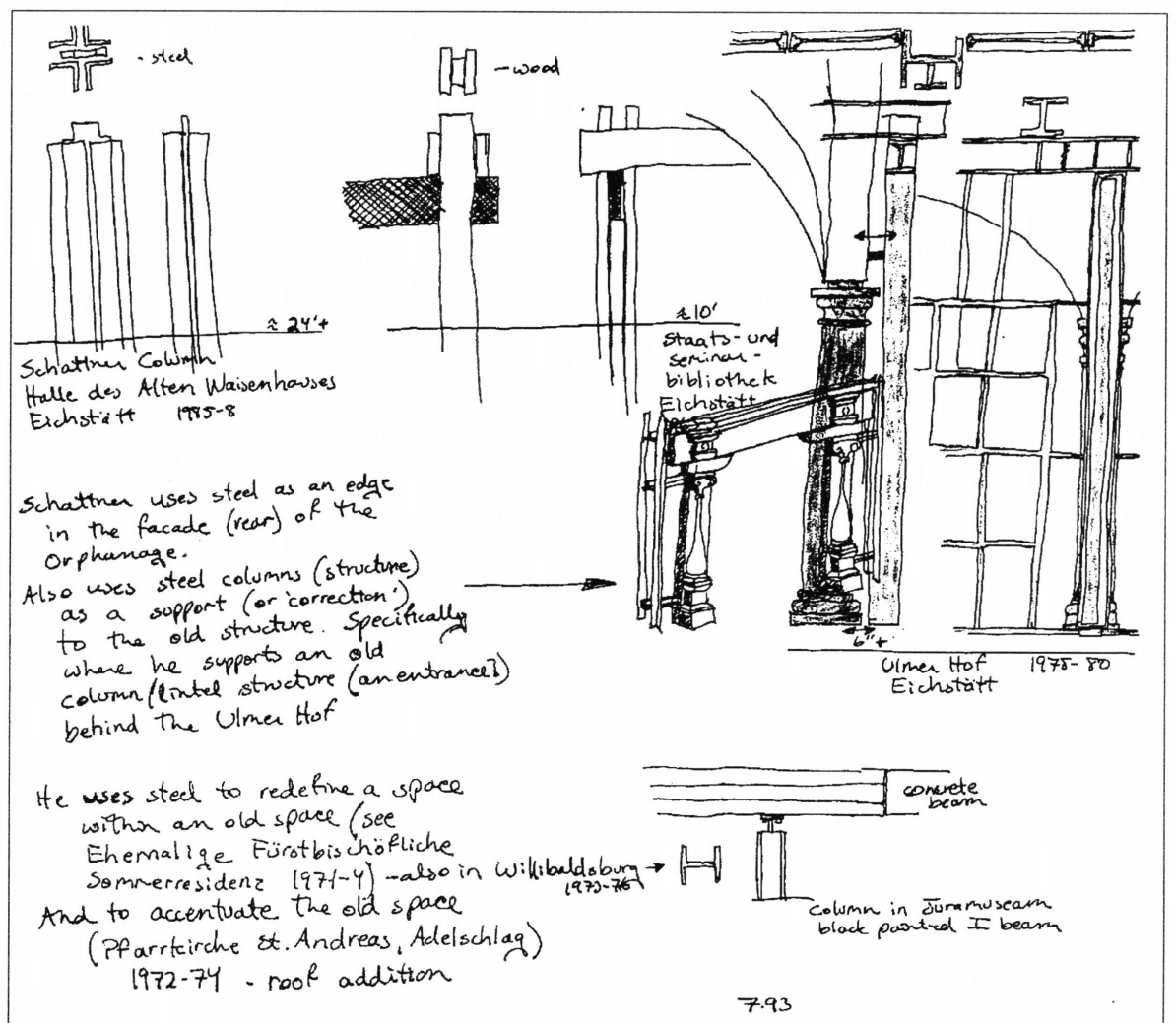

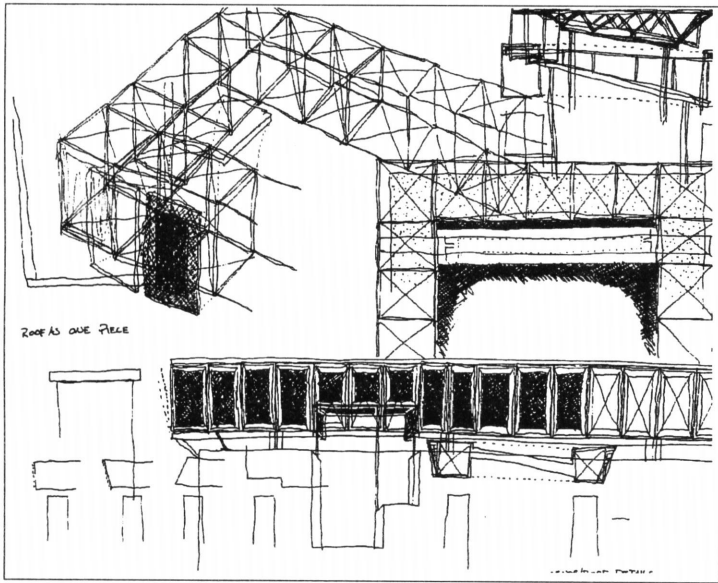

The answer to the roof question was found within the realm of parts and elements. It had been decided early on in the project that the steel column would support the roof.

The area between the roof and wall became another opportunity to explore the idea of the in-between, as designed for the windows and doors throughout the project. A precast concrete cap is proposed as an ending to the wall. This piece acts as a transitory part that completes the wall below it and holds the concrete block or

glass above it. The block wall reaches up to meet the roof. (Also see section on the final model and elevations on pg.38.)

Concrete block is placed on the walls where the roof is at its highest point from the wall (north and east facades) and on the two ends (street facade and the short south facade). Where the roof is at its lowest point to the wall (on the two facades that face the five columns), the precast cap holds a glass clerestory.

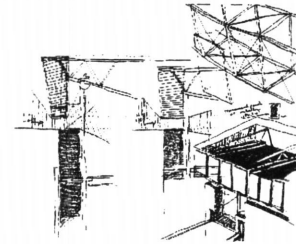

Early roof studies. Question of how roof and wall meet is explored.

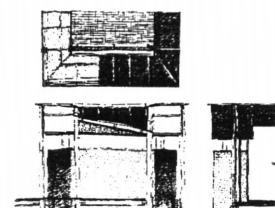
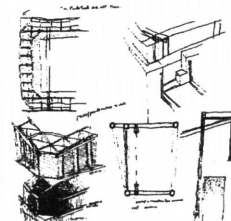
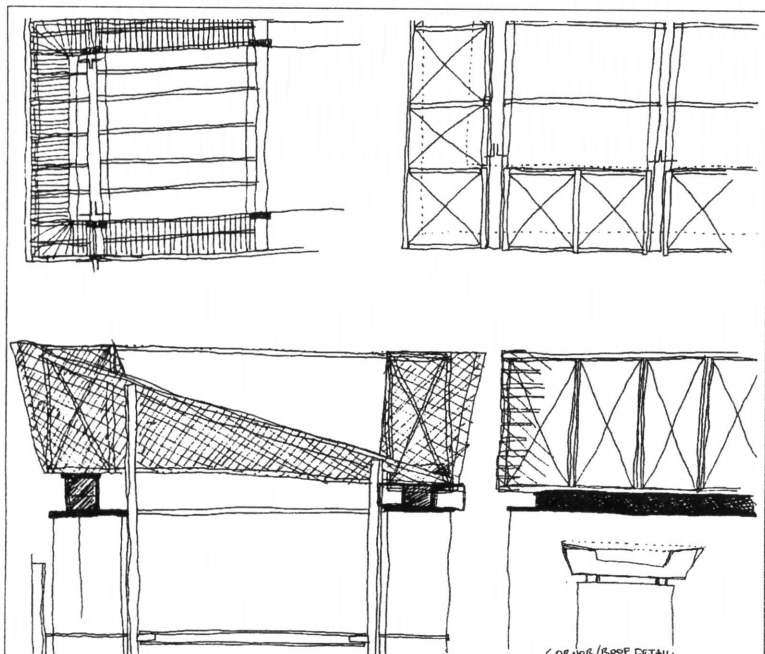

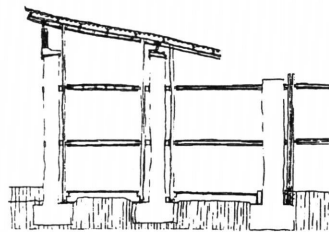
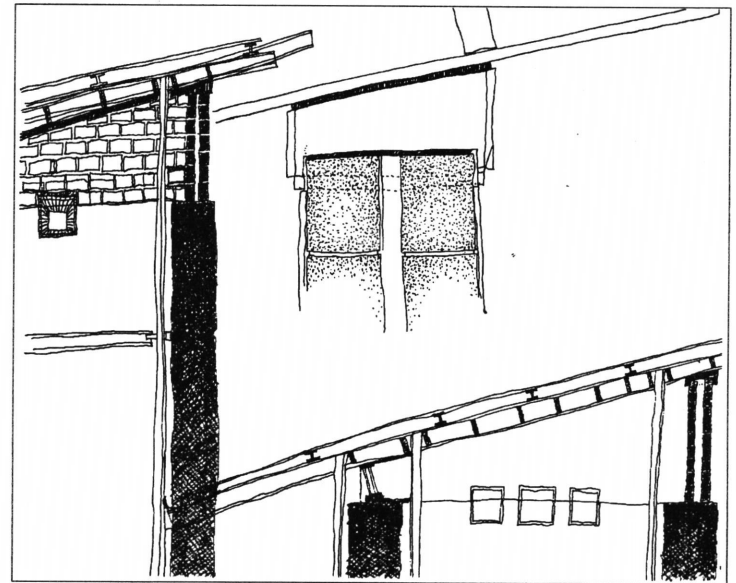

The roof is comprised of several layers of elements. The layers are made up of steel beams that support the elements and span over and beyond the entire house, corrugated steel sheets that rest between the beams (the edge of which is revealed - see elevation on pg.38), and a standing seam tin roof that rests on the corrugated steel.

Each beam is exposed and becomes a window to the sky. The glass pieces

are wider than the beams they are designed to fit over.

The gutter runs along the lowest edge of the roof and is attached above and slightly out from the beam, and just below the level of the standing seam roof (see sketch below). The edge of the roof extends over and bends down into the gutter, but only far enough to allow rain water to flow in, and not back up under the tin.

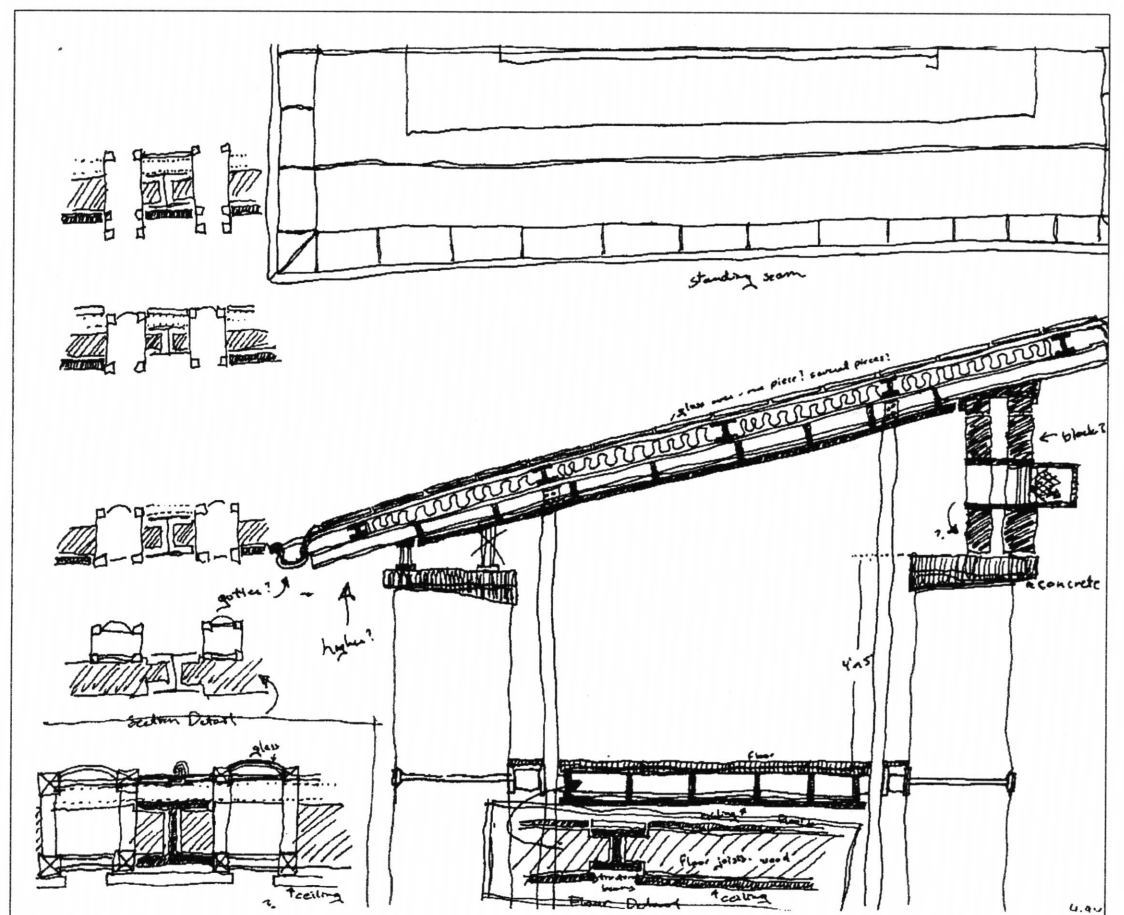

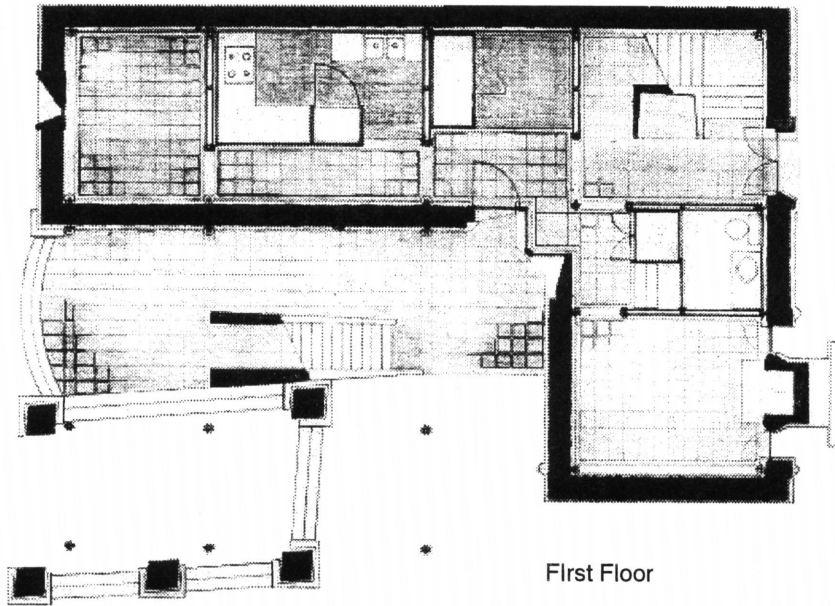

First Floor

GRAPHITE PLANS AND SECTION

This set of drawings do not represent a final design. However, it is necessary to discuss their content and presentation. The mediums of graphite and color pencil have the potential to lend themselves to a particular presence of which was sought after throughout this thesis. For example, in the first floor plan above, the floor is drawn in as it would exist and shaded in to suggest a sheen or texture, which then presents possible materials of which it could be made.

A description of the character of material also occurs within the confines of the original stone wall. An attempt was made to describe its character through media usage also. It can best be seen on the opposite page in the third floor plan. Note the slight distinction made between the old wall and the precast concrete pieces that occur throughout the plan at each window or door opening. This differentiation was intentional and distinguished by a slight hue change.

The character of the precast pieces is different and similar to that of the wall and of the glass, and literally rests within the realm of the old wall and becomes a part of the language of the wall.

Due to the importance of the in-between moments and of distinguishing them from the ordinary, it was necessary to make drawings such as these to visually describe the project for the senses, along with the pragmatic description.

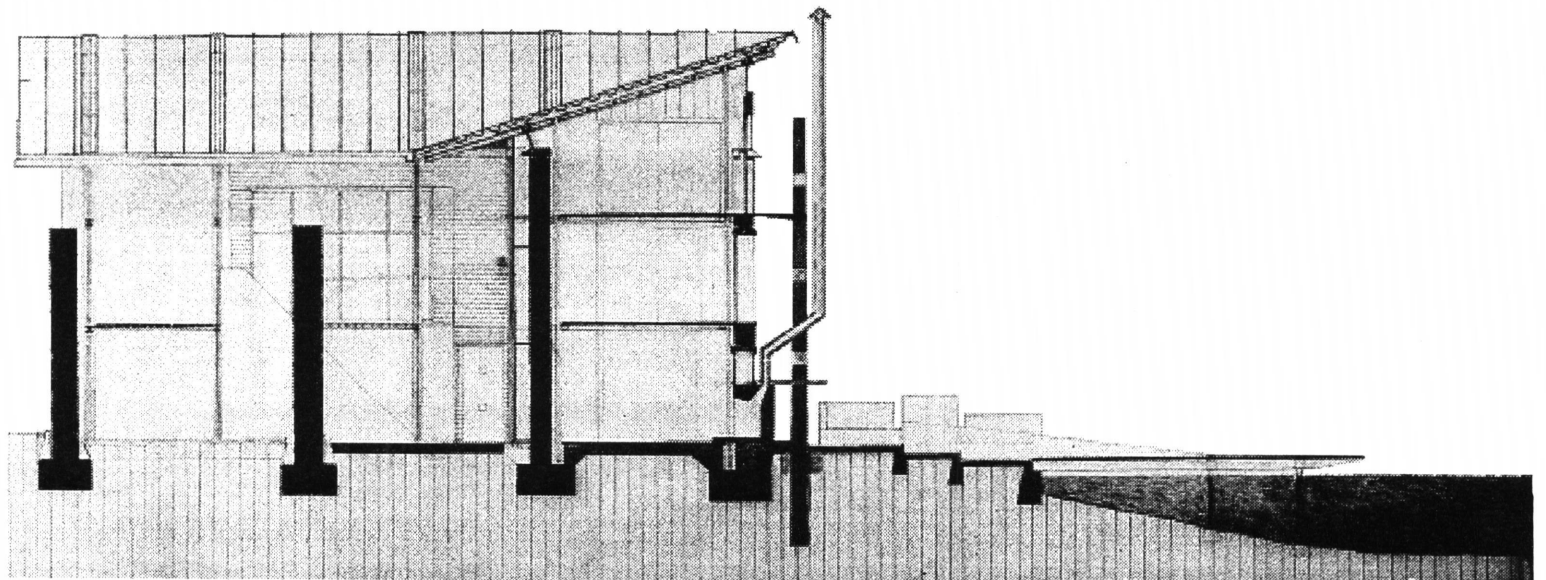

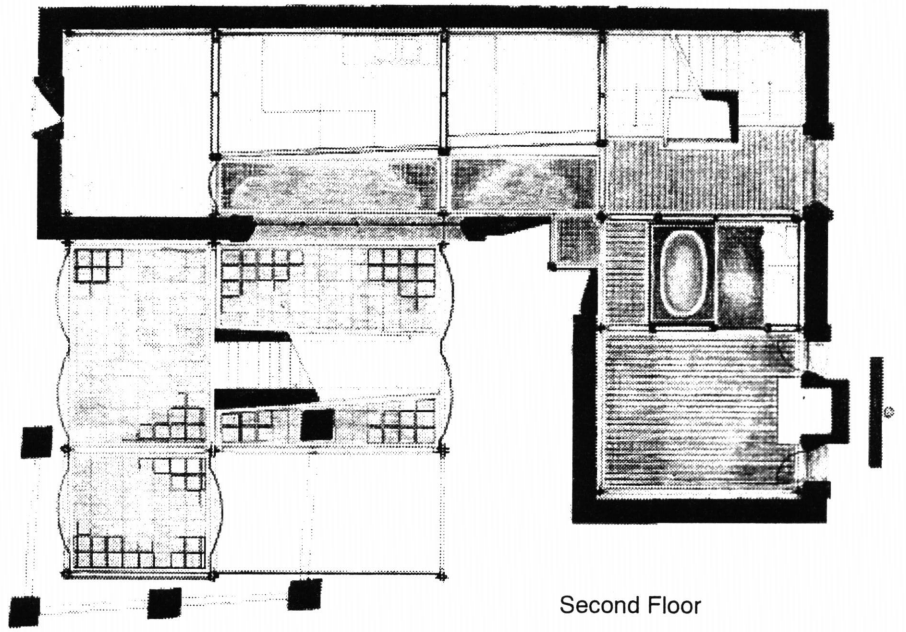

Second Floor

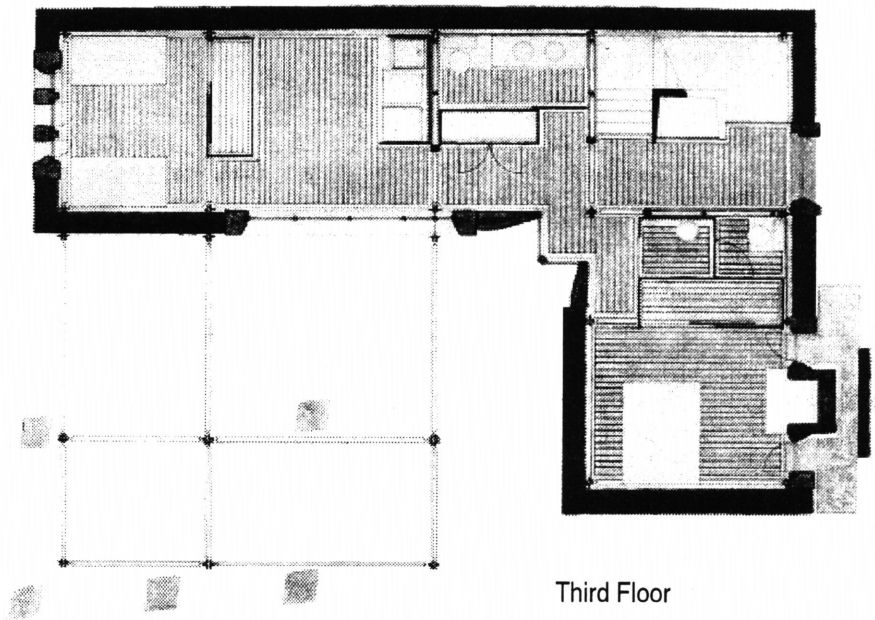

Third Floor

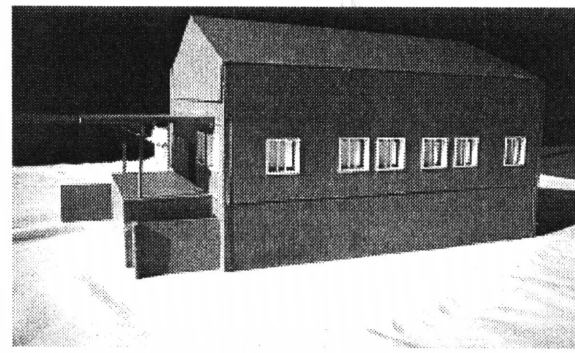
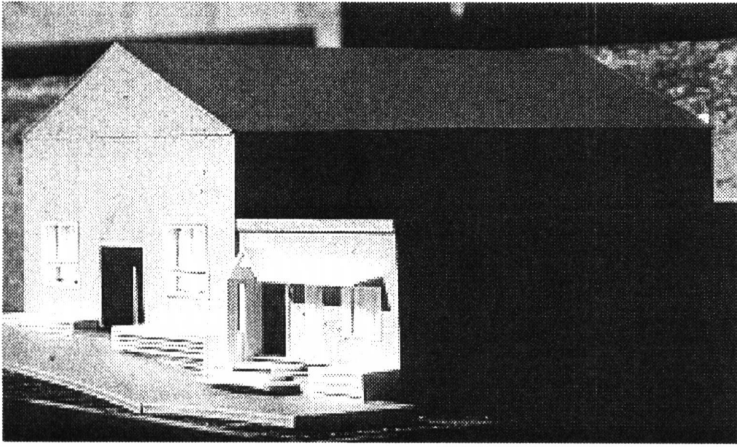

Main street facade. There are several things to note in these three photographs. 1) The window panels were designed to assist in unifying the exterior facades and interior walls, and to distinguish the museum as unique (see caption on p. 49 for elaboration). 2) A ramp was proposed to provide for handicap accessibility from the rear parking lot (see photograph to the right). 3) The main entrance is located on the Main street side of the building, yet, parking for the museum is only available in the back. As most visitors would require parking, it was determined that they would enter the museum from the rear entrance. As such, this entrance is proposed as the main doorway to the building. Since the existing doorway is only three feet wide, I proposed that the window to the right of it should become the door, while the original door becomes a window. This occurs twice, on the Main street facade (above) and the rear facade (to the right).

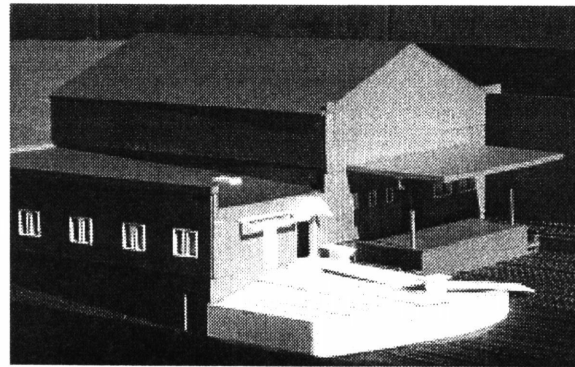

APPENDIX - HILLSVILLE PROJECT

In 1993, I had the opportunity to propose a conceptual design to the Hillsville Historical Society located in Hillsville, Virginia to reconfigure two existing buildings into one meeting and museum space. The Community Design Assistance Center (CDAC) located in the Department of Architecture and Urban Studies, was contacted by the Hillsville committee to assist them in researching the design and cost possibilities for their project.

As the project leader (working with a Building Construction student and a Landscape Architecture student), I maintained the budget, researched funding possibilities at local, state and federal levels, and proposed a design for the museum, storage, and administrative spaces. Handicap accessibility was a primary consideration, especially from outside parking and inside due to a change in floor levels between the two buildings (they share a common wall).

Documentation for this building did not exist. Therefore, it was necessary to measure and photograph the building ourselves.

Although it was not required by the client, I determined that a model of the proposed museum was imperative to assist the client in visualizing the proposed spaces. A model was made with elements or parts that could be removed to reveal the floors below. Not only did the client readily receive the model for public display, the photographs taken and presented to them of this model were irreplaceable in our discussion of the design proposed.

The Hillsville project was conducted at the same time as my thesis project. This concurrent focus had a major impact on the thesis development.

The most important event was that it assisted me in thinking of the Riva house as actually being built. I began to think in terms of the particularities of building and making. The steel model designed (see page 20) was being refined on the computer at about the time I was making the model for Hillsville. The steel pieces used to make the column were collected at that time also. This was the turning point of the thesis.

A similar yet more subtle influence was a thinking and designing in terms of parts. Not just small parts, but components such as a roof, a wall, a ramp, and how these things can come together and make a place. The thesis became the arena in which I was able to explore down to the level of tiny detail.

The last influence I will discuss has to do with findings. The proposal for the Hillsville client included a window design that attempts to unify the two buildings, and that would filter and direct light. After the museum model was made, I could see the effect of that light filtering around the panel (see photo to the right), the panel appears to float in the center of the window.

This project enabled me to find Architecture within the realm of constraints, clients, and practicalities. What I have found most unexpectedly, became the avenue for the thesis to soar.

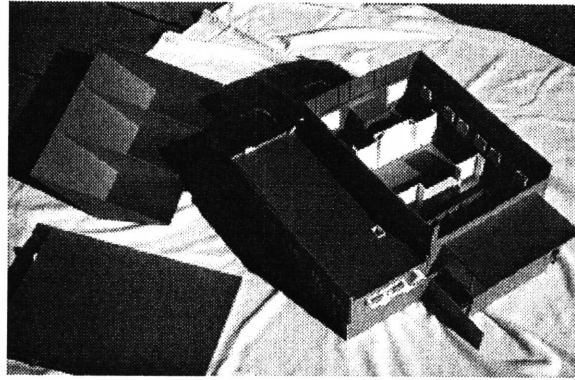

The roof is set aside to show the display room of the museum. The portion of the building next to this room is the administrative space and gift shop (it is covered by its roof).

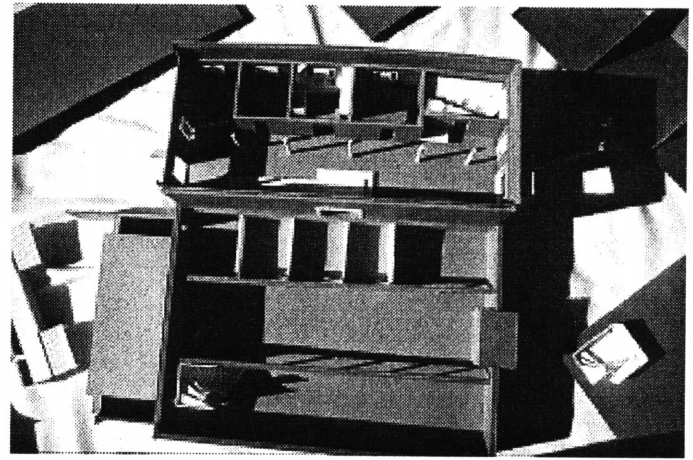

Parts or elements of the structure are disassembled to expose the stairwell and storage rooms in the basement level under the museum.

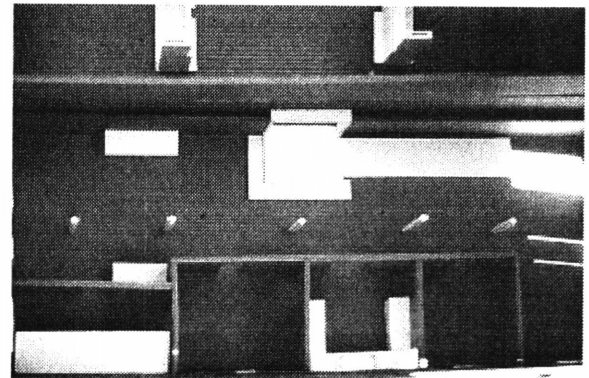

Handicap accessibility was a top priority. Here, a ramp is proposed that addresses the eighteen inch differential between the two floors.

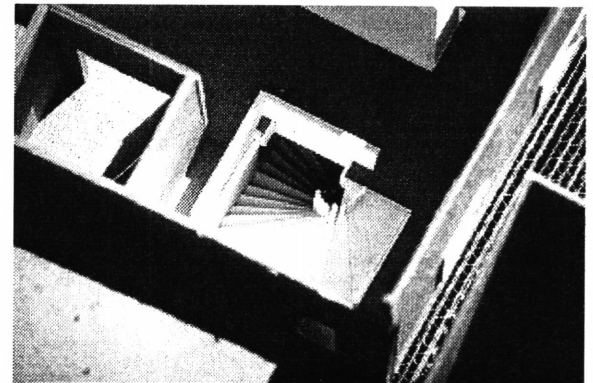

The original building does not have interior access to its basement level. A stair is proposed that is wide enough to accommodate display items that might be stored in the basement .

A secondary consideration was to control the natural light throughout the display and administrative buildings. The existing single-pane windows do not fit well and therefore air flows through easily. Here was an opportunity to design a window panel that can occur throughout the entire structure with minor modifications in dimensions and that could be constructed by the client to help ease cost. The panels are designed to be adjustable to minimize the direct sunlight. In the evening, interior lighting would filter out in such a way that the building would be distinct from its neighbors.

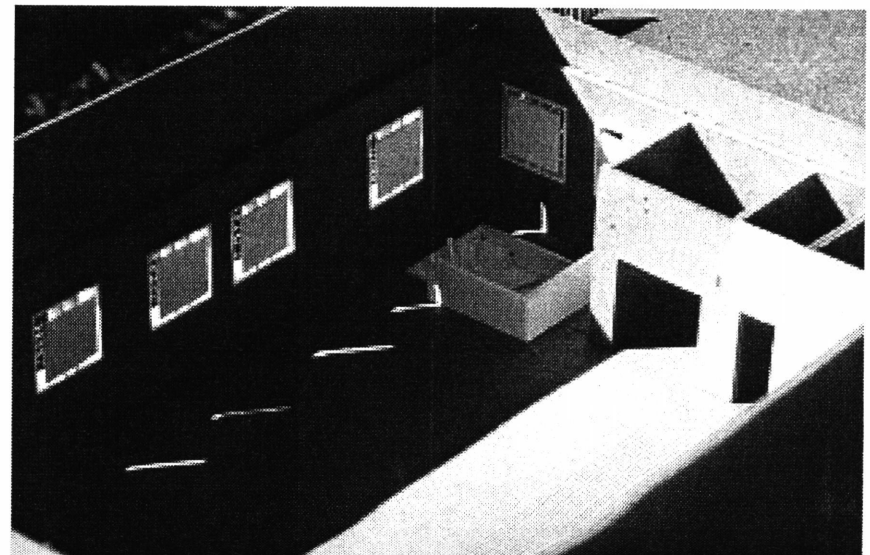

SOURCES CONSULTED

Brancusi, Constantin, Bird in Space Sculpture Series

Frankl, Victor, 'Man's Search for Meaning', 1984, Simon and Schuster, Inc.

Gleizes and Metzinger (Robert Herbert, ed.), 'Modern Art on Art', *Cubism*, 1964, Prentice-Hall

Hertzberger, Herman, 'Hubertshuis: Aldo Van Eyck'

Kandinsky, Wassily, 'Concerning the Spiritual in Art', 1977, Dover Pub., Inc.

Langer, Susanne, 'Feeling and Form', 1953, Charles Scribner's Sons

Rilke, Rainer Maria, 'Letters to A Young Poet' translated by Stephan Mitchell, 1986, First Vintage Books

Rossi, Aldo, presentation and working drawings

Rowe, Colin, 'Mathematics of the Ideal Villa', *Transparency: Literal and Phenomenal*, 1990, MIT

Saarinen, Eiel, 'The Search for Form in Art and Architecture', 1985 Reprint, Reinhold Pub. Corp.

Scarpa, Carlo, Castle del Vechhio, Verona

Schattner, Karl Josef, work in the city of Eichstatt

Scheffler, Ulrich Ernst, 'Liebieghaus Museum alter Plastik Frankfurt am Main', 1991

Schultz, Christian-Norberg, 'The concept of dwelling - on the way to figurative architecture', Rizzoli International Pubs., Inc., 1985

'There are two more images I should like to leave the reader for the inspiration they may offer (her). The one is so enigmatic and occurs so seldom that it still thrills multitudes, causing some to tremble. Sudden night in daytime, sun and moon married: the eclipse. The other is gentle, and equally enigmatic (but it occurs so often): that wonderful period, sometimes long and sometimes short, when both day and night are simultaneously present and experienced as twin phenomenon in a temporal in-between realm: twilight. Eclipse and twilight are doorways to the interior of vision.' - Aldo Van Eyck in Herman Hertzbergers, *Hubertushuis*, p. 44