

# TREADWELL MEMORIAL

## FRANCES DOWNEY

Thesis submitted to the faculty of the Virginia Polytechnic Institute and State University  
in partial fulfillment of the requirements for the degree of

Master of Architecture  
in Architecture

H. Scott Gartner, Chair

V. Hunter Pittman

Elizabeth Grant

December 16, 2014  
Blacksburg, Virginia

Keywords: Alaska, Memorial

# TREADWELL MEMORIAL

FRANCES DOWNEY

## ABSTRACT

This is a memorial to gold mining in Southeast Alaska. The structure takes visitors from the Treadwell trail onto the edge of a popular local beach, reclaiming a forgotten place that was once the largest gold mine in the world. A tangible tribute to this obscure period of history, this building kindles a connection between artifacts and the community. It is a liminal space, connecting ocean and mountain, past and present, civilization and wilderness. An investigation of the Treadwell Gold Mining complex influenced its form and function. Its foundation is two deep concrete footings that achieve stability in the loose tidal flat sand. Its building assembly is a result of model studies to understand the connections between the central wall, roof, and floor. This is the end result of a desire to build a meaningful place in Alaska.



# ACKNOWLEDGEMENTS

I would like to thank Scott, Hunter, and Elizabeth for helping me find value in my work.

I would like to thank my fellow Hokies for creating a supportive environment to come to work everyday.

I would like to thank my father for providing perspective.

I would like to thank my mother for encouraging me to move to Alaska.



*Tradition is a matter of much wider significance. It cannot be inherited, and if you want it, you must obtain it by great labor. It involves, in the first place, the historical sense [...] and the historical sense involves a perception, not only of the pastness of the past, but of its presence; the historical sense compels a man to write [or, to design] not merely with his own generation in his bones, but with a feeling that the whole of the literature [architecture] ... has a simultaneous existence and composes a simultaneous order. This historical sense, which is a sense of the timeless as well as of the temporal and of the timeless and of the temporal together, is what makes a writer [architect] traditional. And it is at the same time what makes a writer [architect] most acutely conscious of his place in time, of his contemporaneity. -T.S. Eliot*

T. S. Eliot, points out the value of tradition as well as the difficulties of grasping and maintaining it. I believe his views are directly applicable to architecture.

In architecture, how do we create a sense of cultural continuity and rootedness?

I was taught in my architectural education that intrinsic form, detached from a particular place and time, is more honest and more pure than form that is specific to practical constraints and an actual place. What I realized during this thesis is that this belief requires some reexamination. I learned that an examination of the history of the site can be a powerful creative inspiration towards architecture.

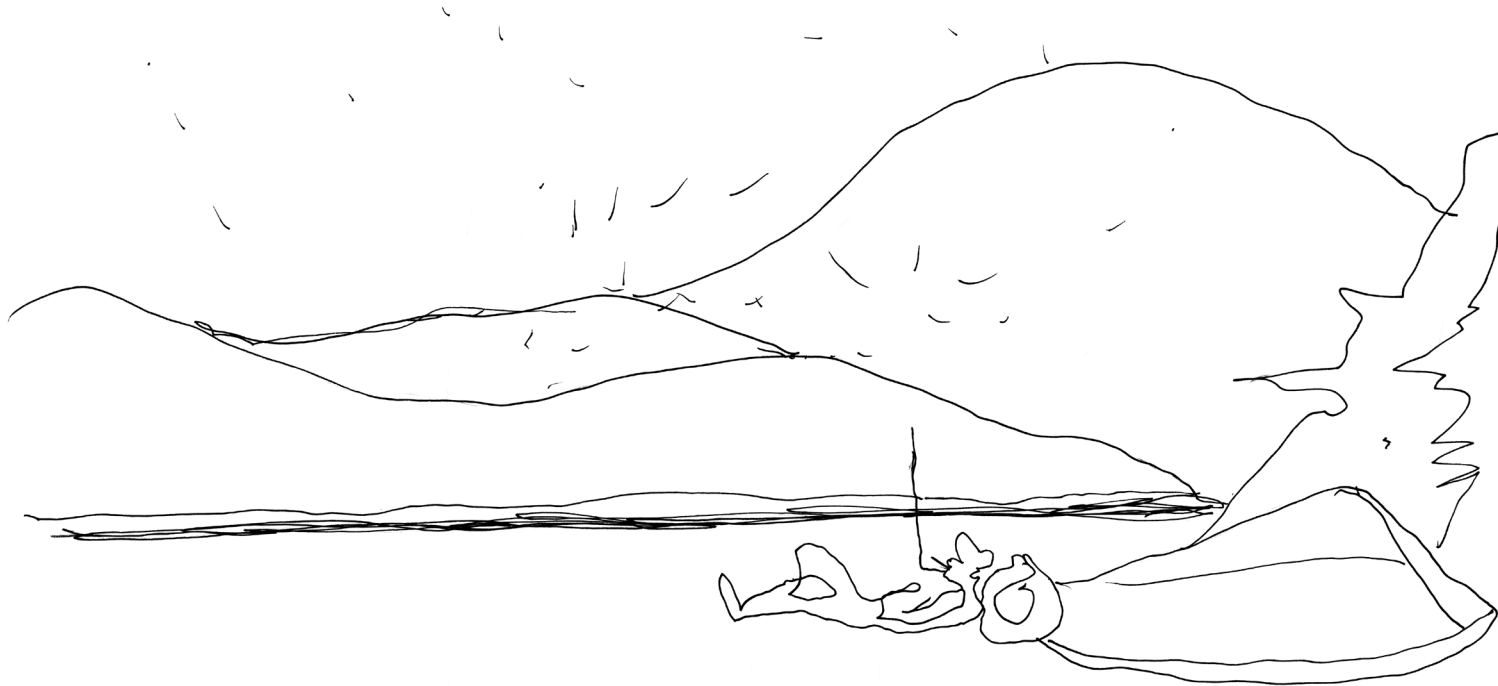

We shall not cease from exploration  
And the end of all our exploring  
Will be to arrive where we started  
And know the place for the first time.

“Little Gidding” - T. S. Eliot

## TABLE OF CONTENTS

Treadwell, Alaska:	1
Treadwell Gold:	3
Treadwell Today:	5
Mine Inspiration:	7
Mining Memorial:	13
Method:	27
Process of Discovery:	43

# LIST OF FIGURES

Figure 1. Architect on the Docks Photo.....iv	Figure 35. Low Tide Sketch.....16	Figure 69. Study Model Photo C.....36
Figure 2. Sandy Beach Sketch.....vi	Figure 36. Final Model Photo B.....17	Figure 70. Study Model Photo D.....36
Figure 3. Glacier Sketch.....viii	Figure 37. Memorial Entry Sketch.....17	Figure 71. Model Process.....38
Figure 4. Site Section Sketch.....1	Figure 38. Final Model Photo C.....18	Figure 72. Section Model Photo A.....39
Figure 5. Alaska Map.....2	Figure 39. Footings Sketch.....18	Figure 73. Section Model Photo B.....39
Figure 6. Juneau Map.....2	Figure 40. Final Model Photo D.....19	Figure 74. Detail Drawing A.....39
Figure 7. Site photo.....2	Figure 41. Final Model Photo E.....19	Figure 75. Section Model Photo C.....40
*Figure 8. Historic Treadwell Photo A.....3	Figure 42. Inside View Sketch.....19	Figure 76. Section Model Photo D.....40
Figure 9. Treadwell Now Photo.....3	Figure 43. Path Sketch.....20	Figure 77. Section Sketch.....40
*Figure 10. Historic Treadwell Photo B.....4	Figure 44. Final Model Photo F.....20	Figure 78. Structural Study Model A.....41
*Figure 11. Historic Treadwell Photo C.....4	Figure 45. Site Plan Drawing.....21	Figure 79. Structural Study Model B.....41
*Figure 12. Historic Treadwell Photo D.....4	Figure 46. Plan Drawing.....22	Figure 80. Detail Drawing B.....41
*Figure 13. Historic Treadwell Photo E.....4	Figure 47. East Elevation Drawing.....23	Figure 81. Detail Drawing C.....42
*Figure 14. Historic Treadwell Photo F.....4	Figure 48. West Section Drawing.....24	Figure 82. Structure Photo.....42
Figure 15. Sandy Beach Sketch.....5	Figure 49. West Elevation Drawing.....24	Figure 83. Mood Sketch.....43
*Figure 16. Historic Treadwell Photo G.....5	Figure 50. North Elevation Drawing.....25	Figure 84. Mine Concept.....44
Figure 17. Treadwell Now Photo A.....6	Figure 51. South Elevation Drawing.....25	Figure 85. Sketches of Place A.....45
Figure 18. Treadwell Now Photo B.....6	Figure 52. North Section Drawing.....25	Figure 86. Sketches of Place B.....46
Figure 19. Treadwell Now Photo C.....6	Figure 53. Section Drawings.....25	Figure 87. Glacier Sketch.....47
Figure 20. Mine Section Study A.....7	Figure 54. Rainy Day Sketch.....26	Figure 88. Northern Lights Painting.....48
Figure 21. Mine Section Study B.....7	Figure 55. Model Context.....28	Figure 89. Boundaries Sketch.....49
*Figure 22. Historic Treadwell Photo H.....8	Figure 56. First Model Drawing.....29	Figure 90. Transformation Sketch.....49
Figure 23. Treadwell Site Drawing.....8	Figure 57. First Model Photo A.....30	Figure 91. Wing Building Drawing.....50
*Figure 24. Historic Treadwell Photo I.....8	Figure 58. First Model Photo B.....30	Figure 92. Tower Drawing A.....51
Figure 25. Conceptual Site Section A.....9	Figure 59. Section Model Photo.....31	Figure 93. Tower Drawing B.....52
Figure 26. Conceptual Site Section B.....10	Figure 60. Section Model Sketch.....31	Figure 94. Lighthouse Drawing.....53
*Figure 27. Historic Treadwell Photo J.....11	Figure 61. Concept Model A.....32	
Figure 28. Mining Tool Sketch.....11	Figure 62. Concept Model B.....32	
Figure 29. Conceptual Sketches.....12	Figure 63. Tunnel Sketch.....32	
Figure 30. Memorial Sketch A.....13	Figure 64. Model Study Photos.....33	
Figure 31. Memorial Sketch B.....14	Figure 65. Model Study Sketches.....33	
Figure 32. Final Model Photo A.....15	Figure 66. Structure Axon Drawing.....34	
Figure 33. Below the Memorial Sketch.....15	Figure 67. Study Model Photo A.....35	
Figure 34. High Tide Sketch.....16	Figure 68. Study Model Photo B.....35	

All images and photographs were produced or reproduced by the author with the media noted, unless otherwise stated.

\*all historic photographs on pages 3, 4, 5, 8, and 11 obtained from Alaska State Library- Historical Collections digital archives.

# LIST OF SOURCES

1. Decker, Julie. True North: New Alaskan Architecture. Salenstein, Switzerland: Braun, 2010: 21-22. Print.
2. McIver, Kevin Lee. Death of an Empire: Collapse of the Treadwell Gold Mine: A Multimedia History Book. Place of Publication Unknown: Groovy Outdoors, 2013. Print.
3. Kelly, Sheila. Treadwell Gold: An Alaska Saga of Riches and Ruin. Fairbanks, Alaska: University of Alaska Press, 2010. Print.

# I: TREADWELL, ALASKA

In 2009, I moved northwest from Maryland for a job in America's Last Frontier. I was very moved by Alaska. The Alaskan landscape conveys a silencing sense of endless time and the transitoriness of human culture. It is a land of immense scale and sublime natural beauty. Everywhere one feels like they are at an edge, a fragile boundary between civilization and untamed nature.<sup>1</sup>

I often found myself standing on what is known as Sandy Beach, formed from the fine sand tailings leftover from processing millions of tons of ore to release gold. I'd look out on the channel over the rows of rotting pilings that had once been the busiest wharf in Alaska. This was the staging area for the Treadwell story: here ships unloaded miners, machinery, coal and oil, engineers, tourists, and families that supported the Treadwell town. The town was gone.

After coming back to the Lower 48- otherwise called "America" by Alaskans even today- I realized few outside of the local residents know the story of the Treadwell Empire---its ultimate collapse---and its fade into history.<sup>2</sup>

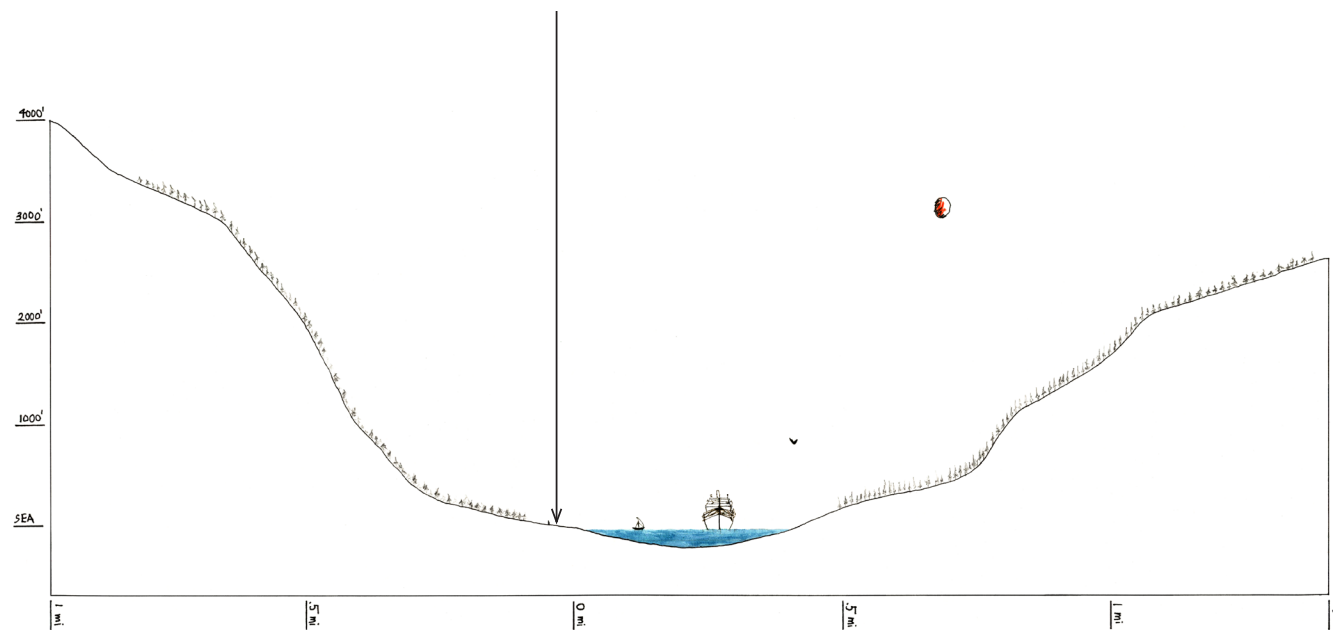

Site:  
Longitude: -134.38°  
Latitude: 58.270° N



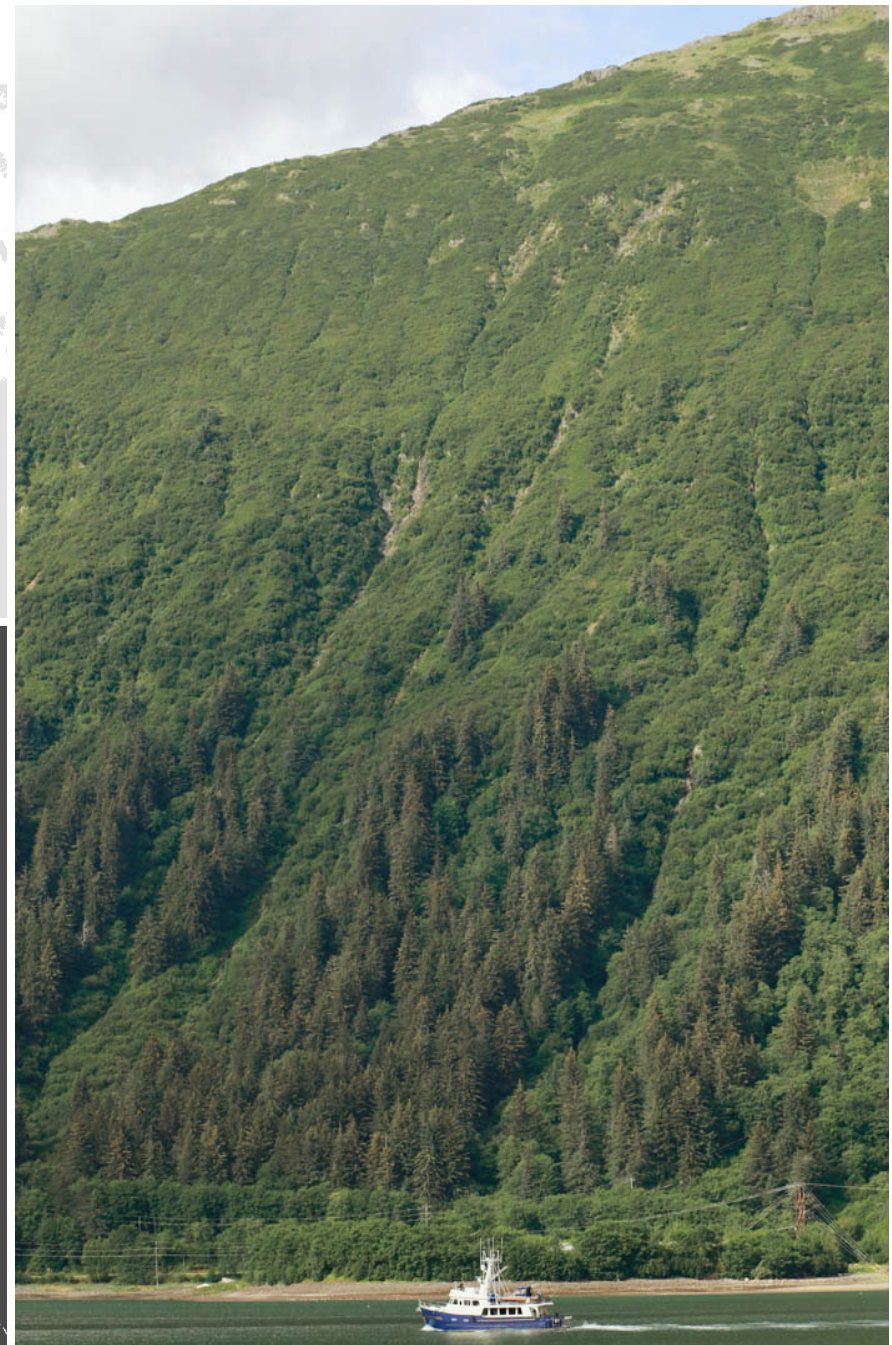
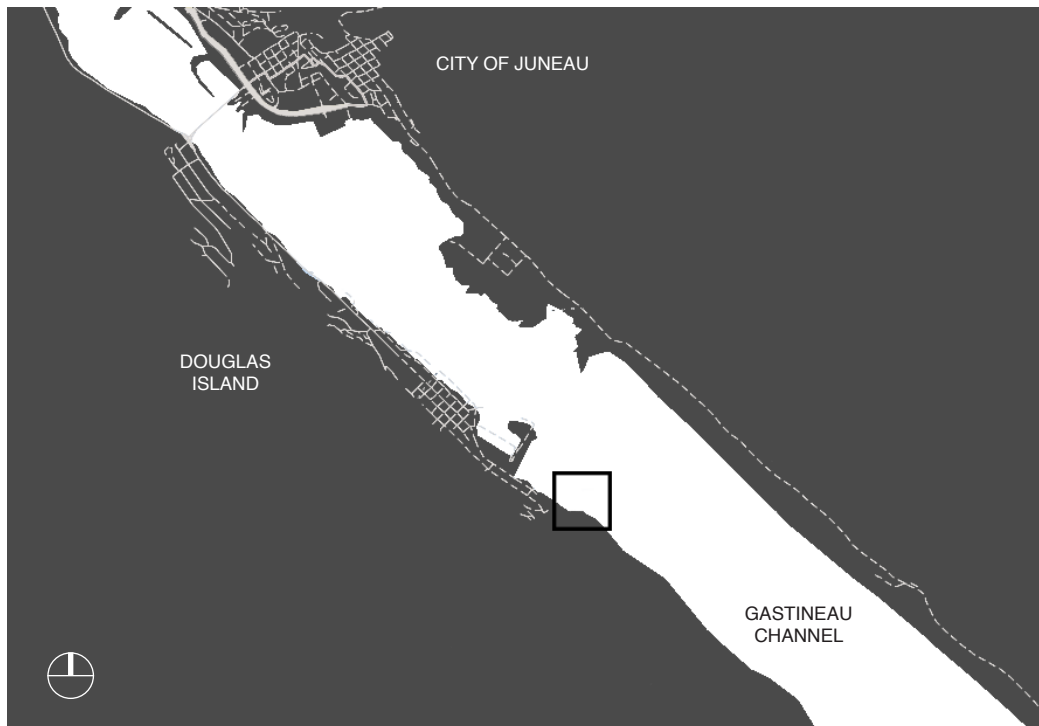
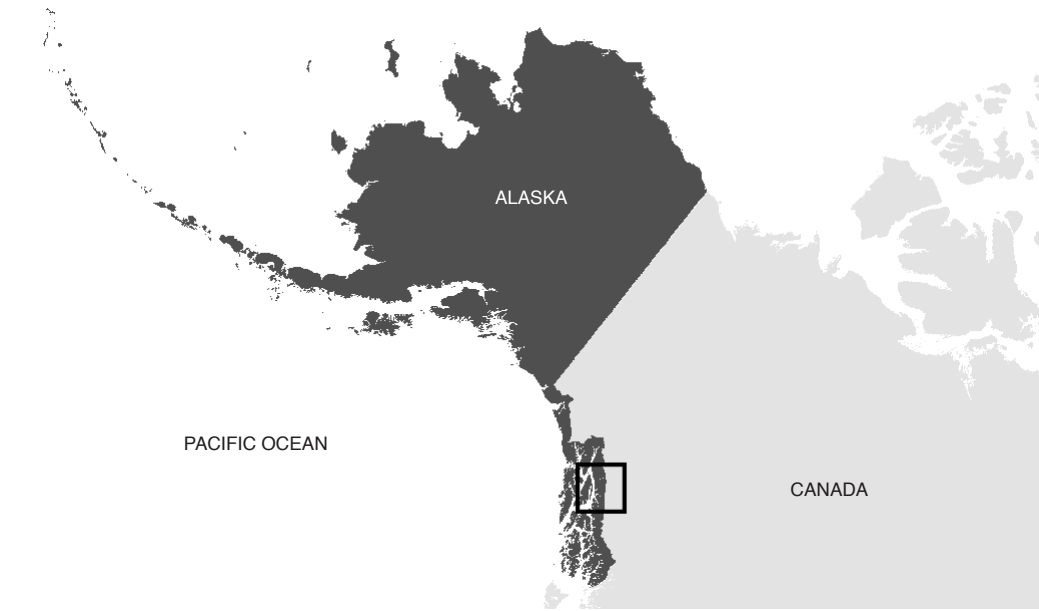



## II: TREADWELL GOLD

The Treadwell settlement began its life serving the first gold prospectors of the Alaskan territory. Over the course of four decades, starting in 1882, the town of Treadwell achieved fame as the largest hard-rock gold mine in the world, creating more wealth than the Klondike Gold Rush.

Between 1881 and 1922, over 3 million ounces of gold were extracted, worth four billion dollars. The coastal settlement served as the first hub of commerce in the North, and is credited with opening up development and tourism on the great northern frontier.

The coastline was an unstable patchwork of hundreds of cavities, reaching a half mile down into the earth and out under the Gastineau Channel.

On April 21, 1917 extraordinarily high tides in the Gastineau Channel clawed at a crack in the mine's surface and flooded three of the town's four mines. The mines went silent and hundreds of workers left within days. The town burned down in 1926, leaving the shoreline back to nature.



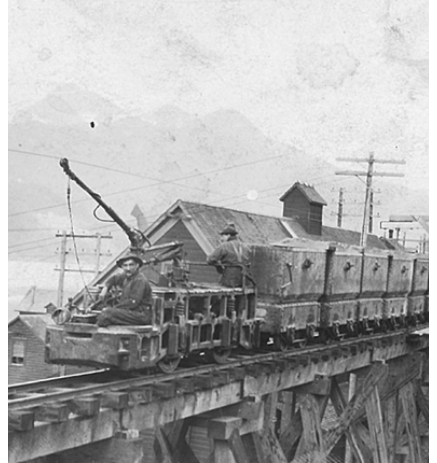
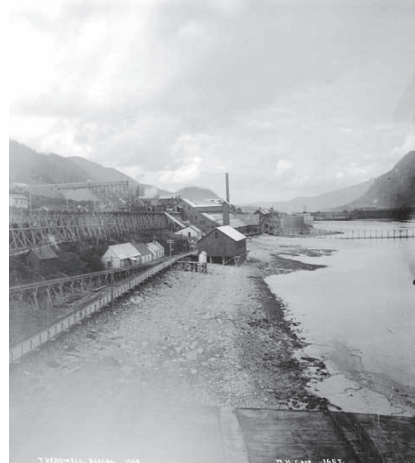
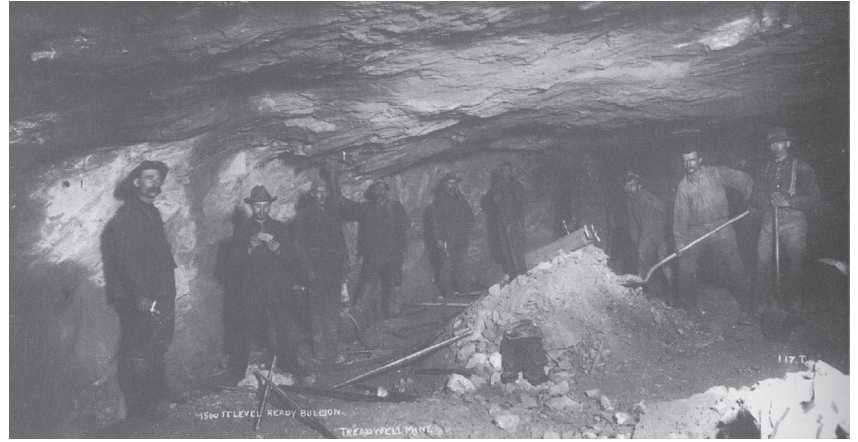



### III: TREADWELL TODAY

Remains of the historic Treadwell town are visible along a public trail on Douglas Island across the Gastineau Channel from downtown Juneau. Dog walkers and the high school cross country team using the trail pay little attention to the remains in their local woods.

Ancient ruins of massive concrete foundations and rows of rotting pilings are all that remain of the Treadwell story. Scattered along the trail are a few wooden markers with ambiguous labels like “the Vaults,” “New Office Building,” and “Cave-in.” The temperate rainforest has reclaimed the coastline with dense alders, Sitka spruce, blueberries and salmonberries. Rusting shells of steam pipes, ore cars, metal scraps, and railway tracks are scattered throughout the underbrush which is honeycombed with unstable sink holes.

Sandy Beach is a popular local hangout spot that allows bonfires. During the summers, massive cruise ships float making their way to Juneau. Over 60,000 tourists pour in and out of the city each day, eager to tour the local glaciers and icefields.

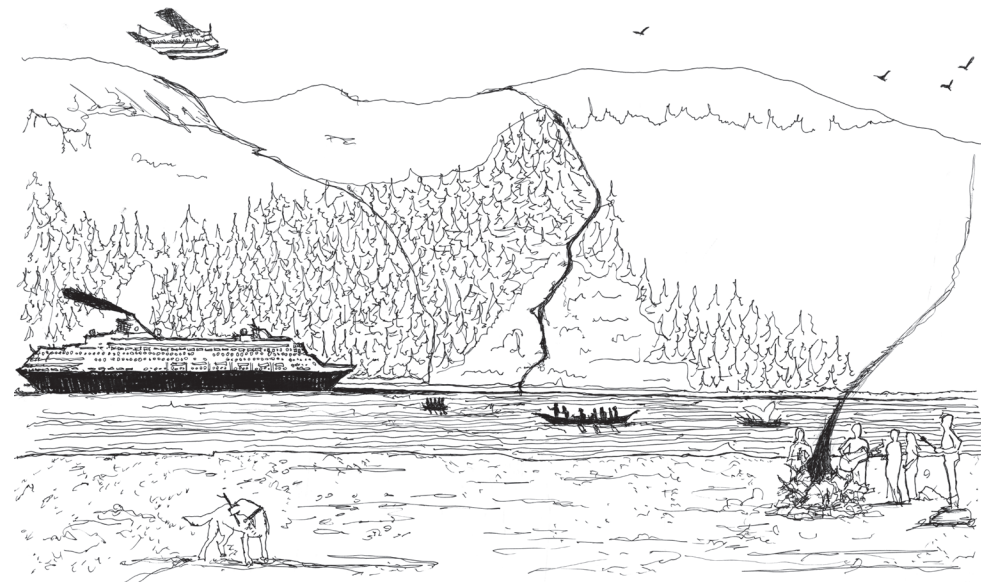







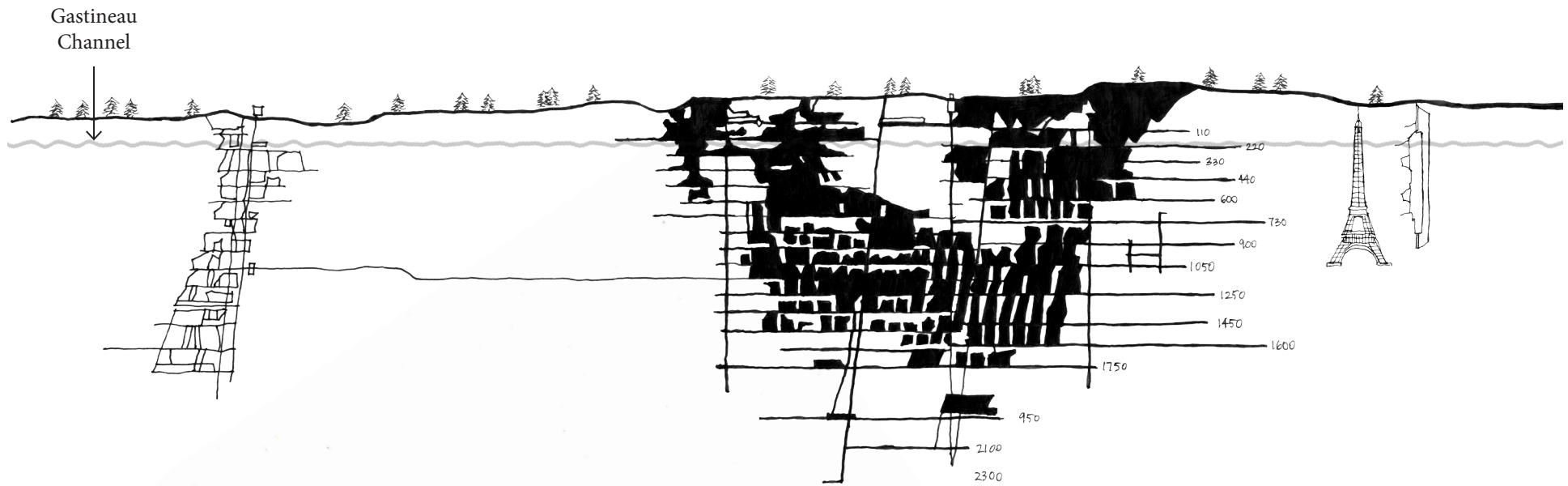

#### IV: MINE INSPIRATION

I used the Treadwell mine as inspiration. I discovered there were over 300 miles of tunnel, cutting half a mile deep into the earth. I researched the original buildings and learned their stories.

More than 200 wooden buildings supported the mines and housed miners and their families along the two mile stretch of steep shoreline. The gritty utilitarian settlement boasted an indoor swimming pool, finely appointed Turkish baths, a clubhouse with movies, dances, billiards, and a library with two thousand books.<sup>3</sup>



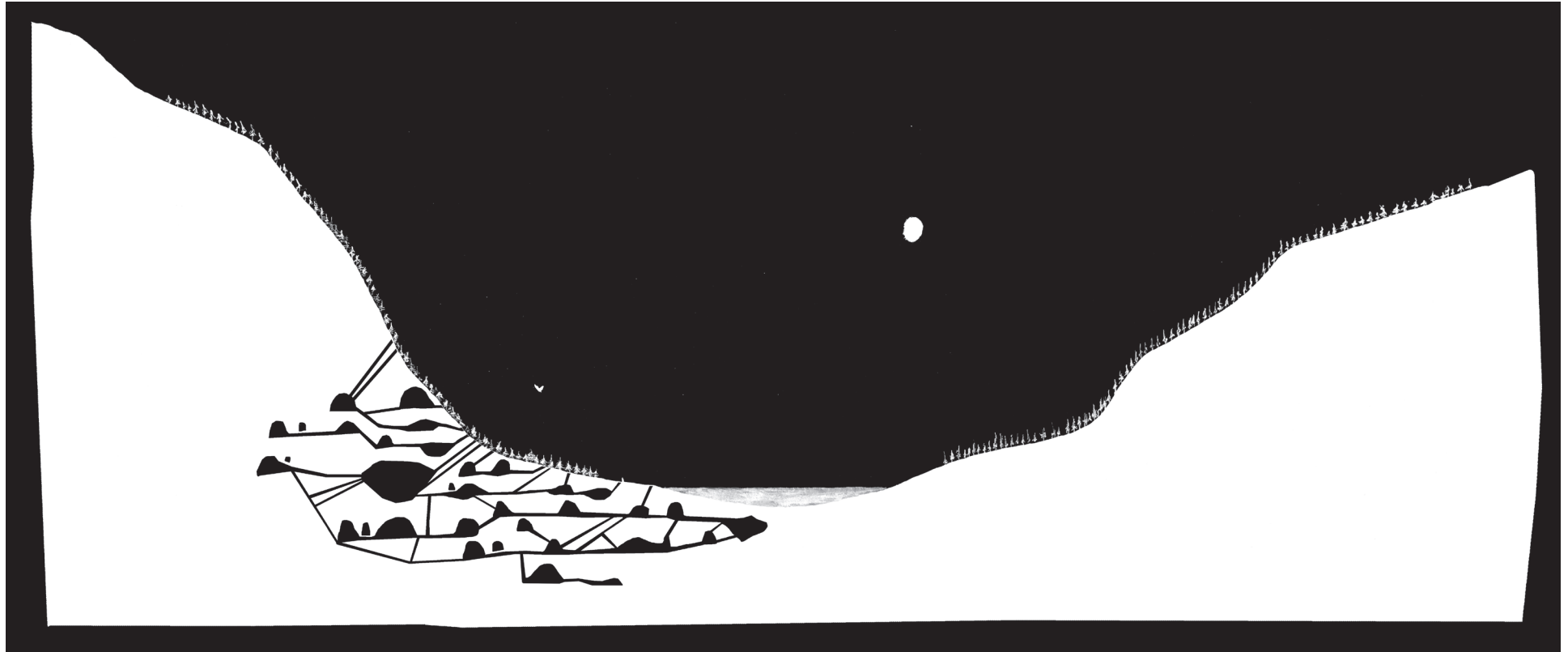



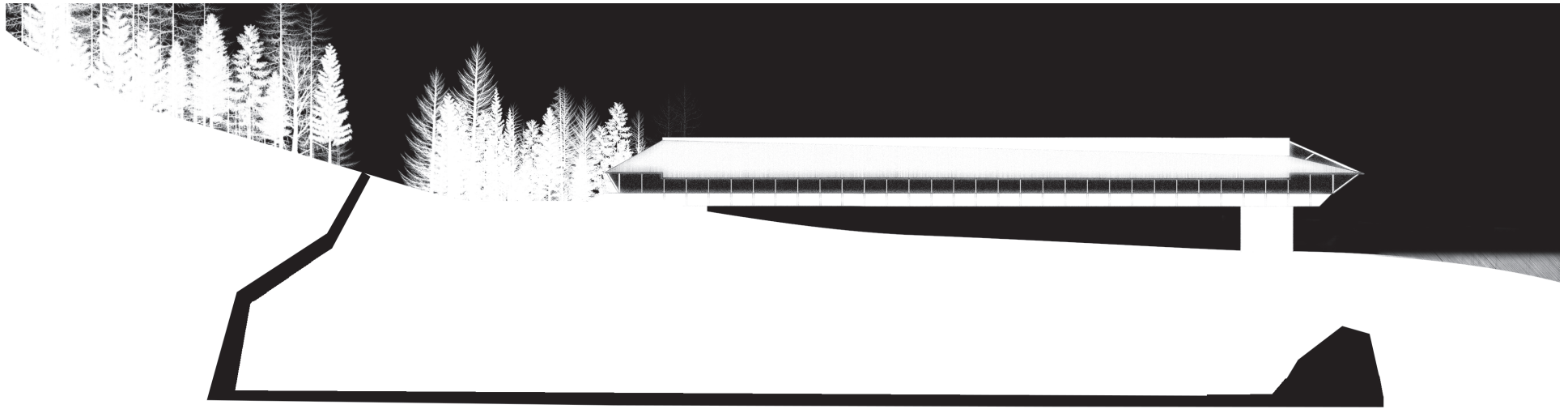
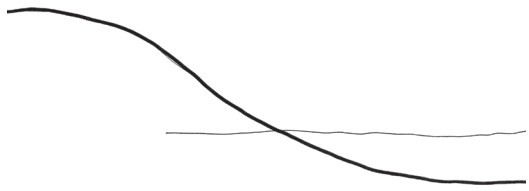

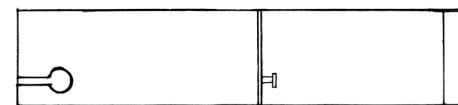
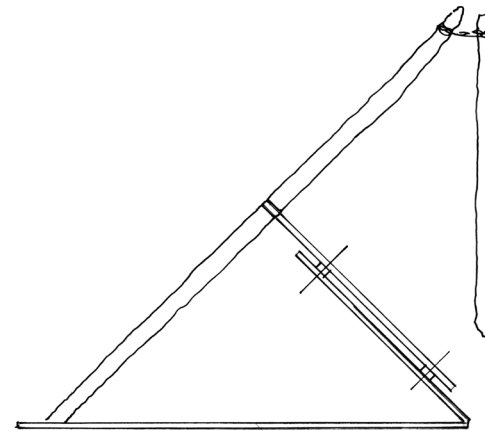

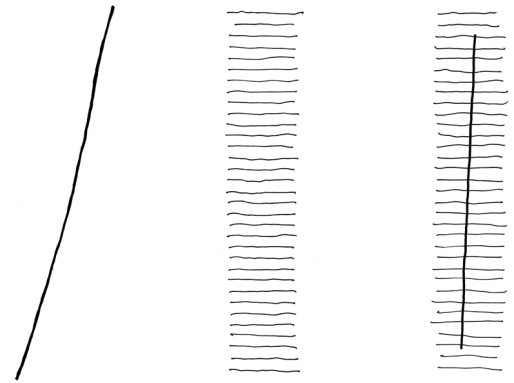
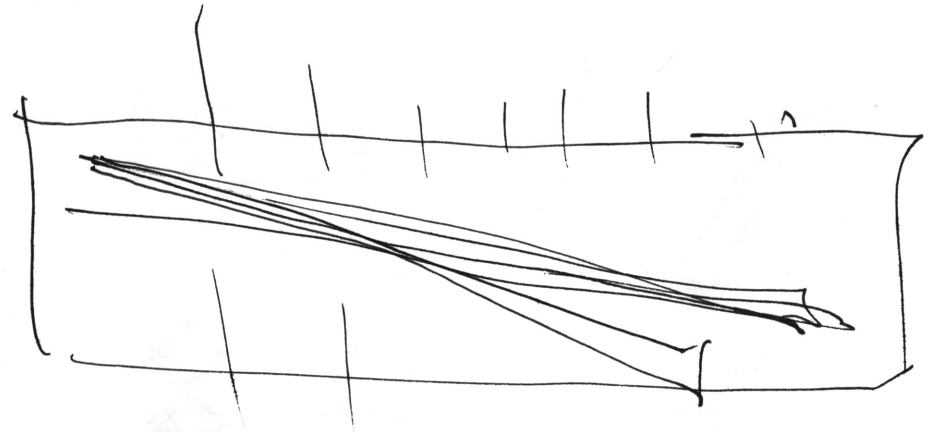
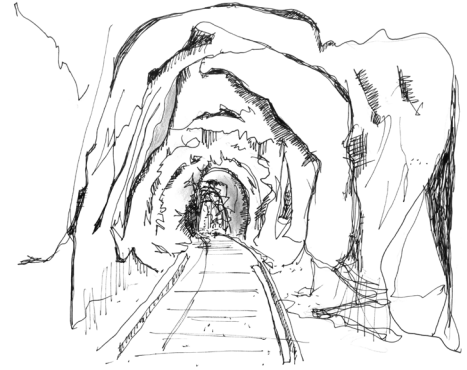

## V: MINING MEMORIAL

The design was propelled by reclaiming the original Wharf site, maintaining the relationship to the water, and memorializing the Treadwell Mine history.

Artifacts of the Treadwell Mine and Douglas Island are anchored into the structure. They are compiled from donations of memorabilia, including various mining tools (picks, shovels, lunch pails, metal tokens signifying a day's work) and photographs.

The framed narrowing walkways allude to the mine tunnels. The visitor travels the compressed walkways from the forest canopy out onto the Gastineau Channel. The rhythmic wood rafters pay homage to the typical mining material.

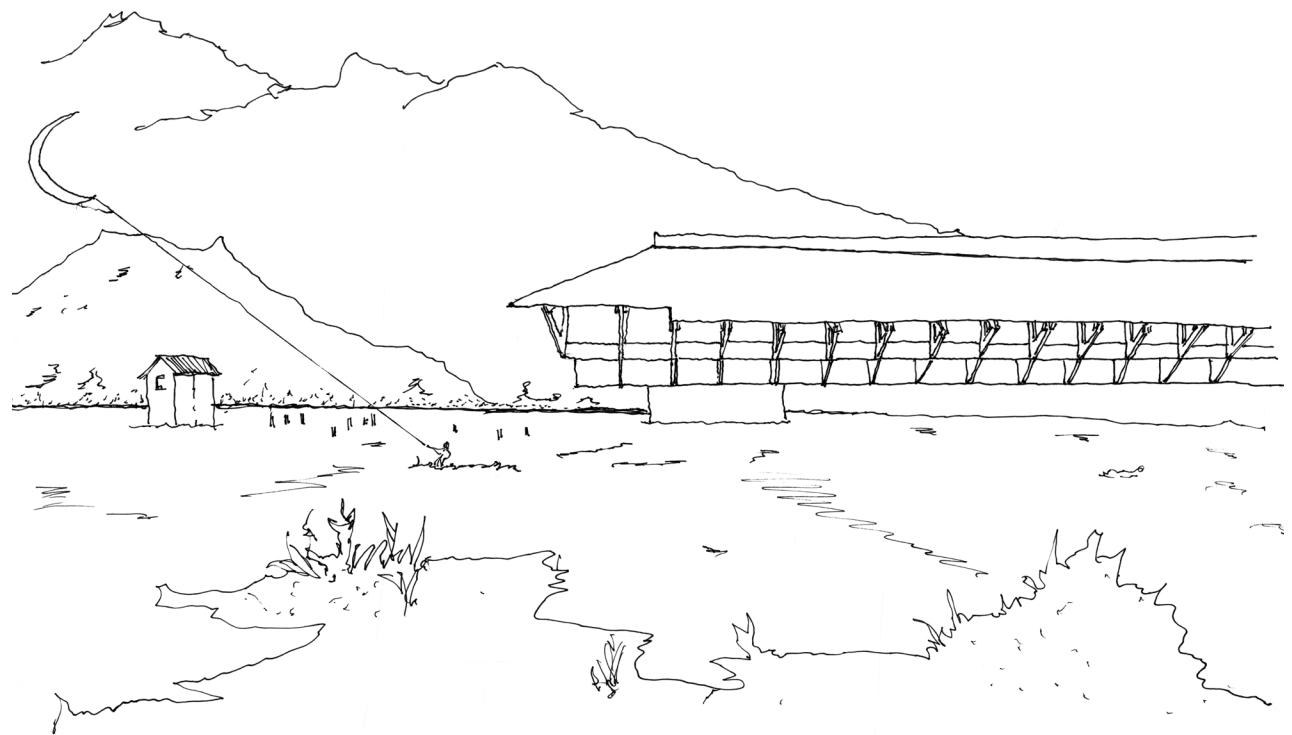

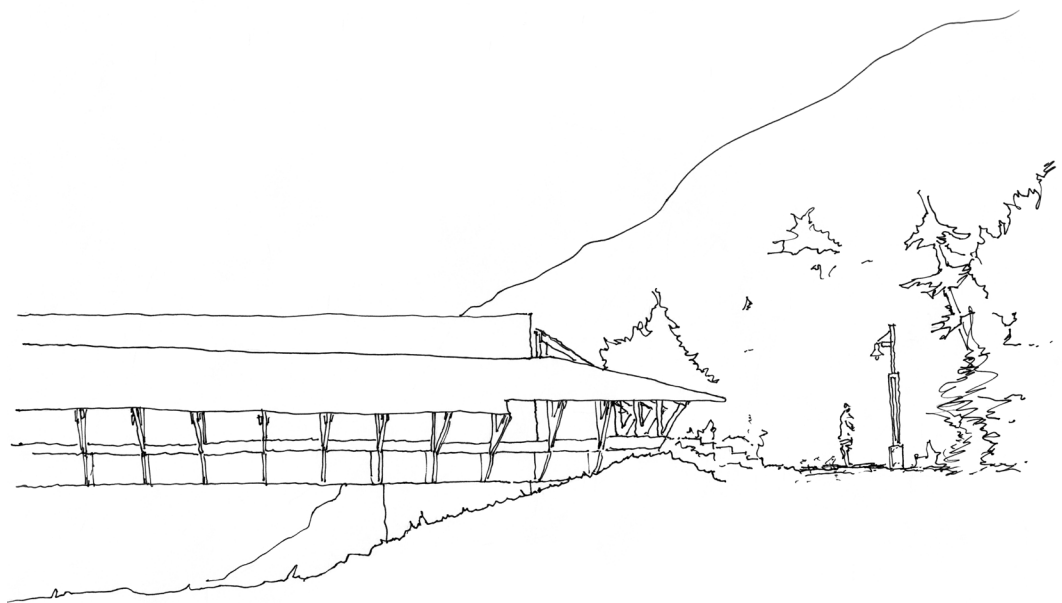

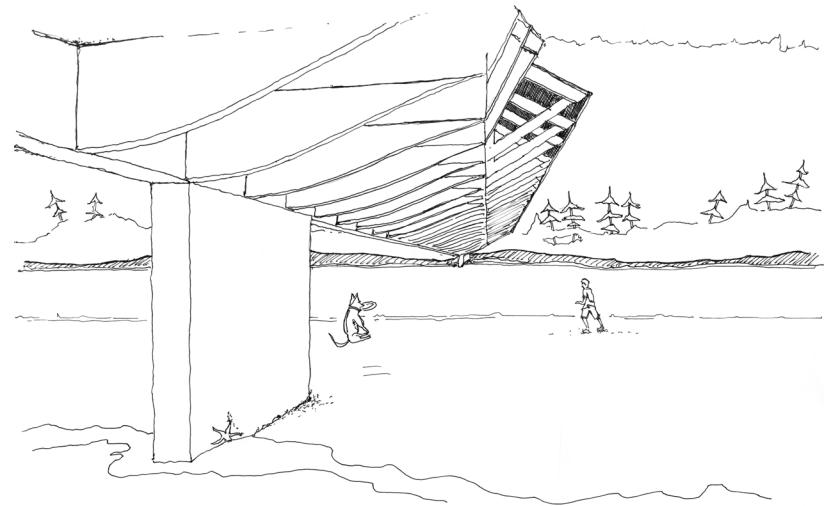



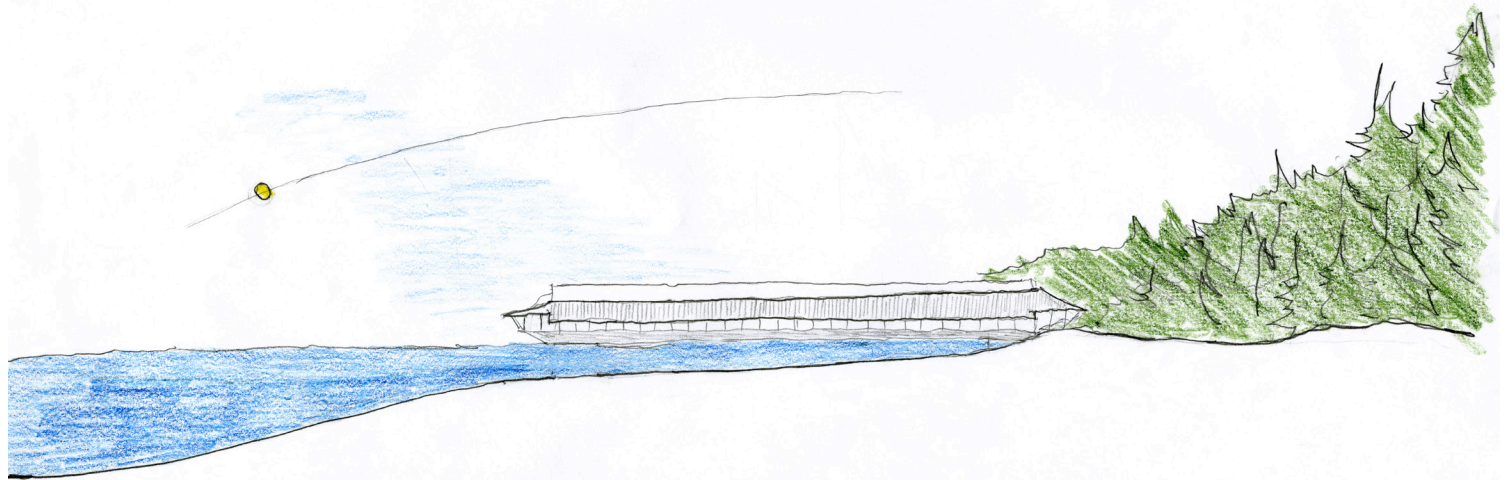
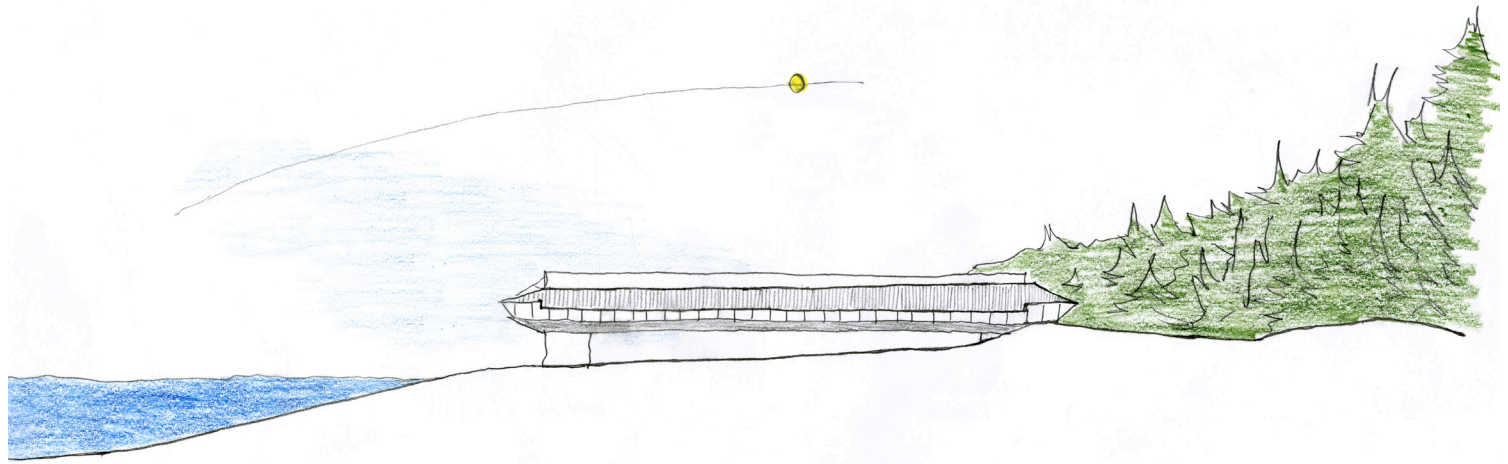





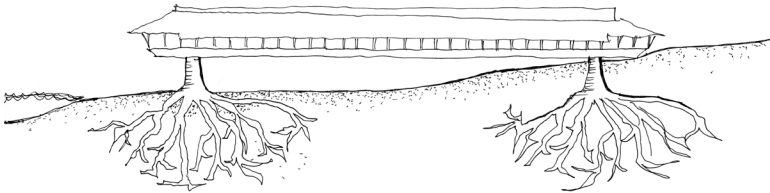
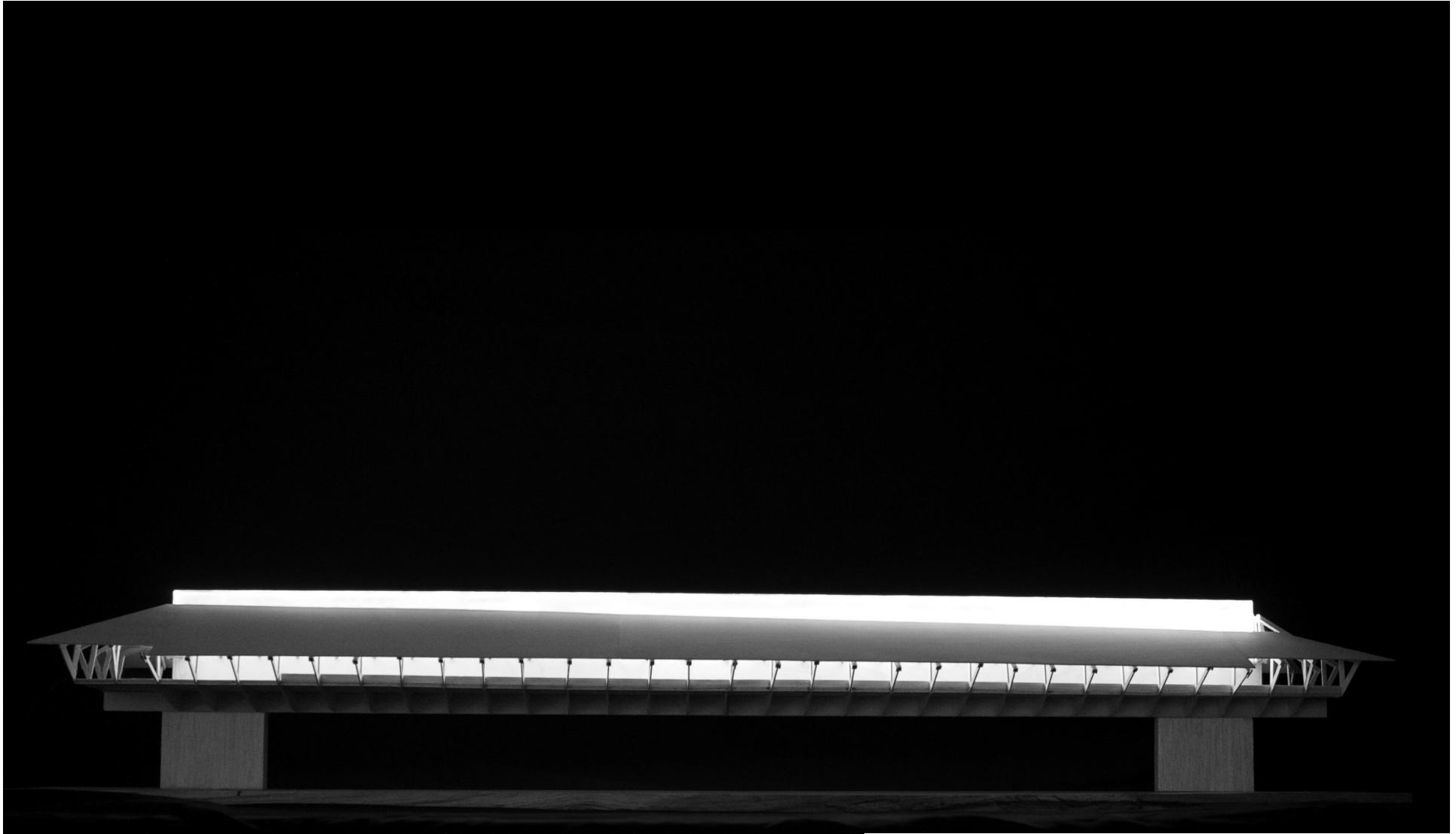

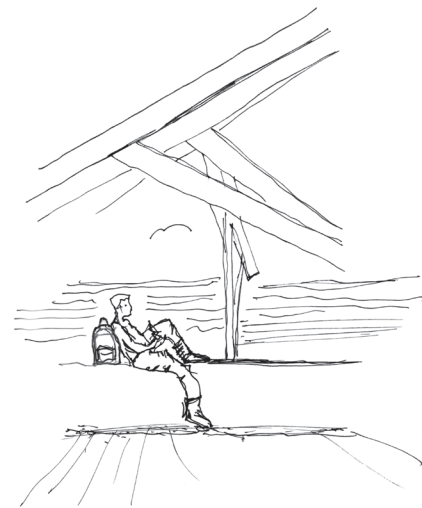
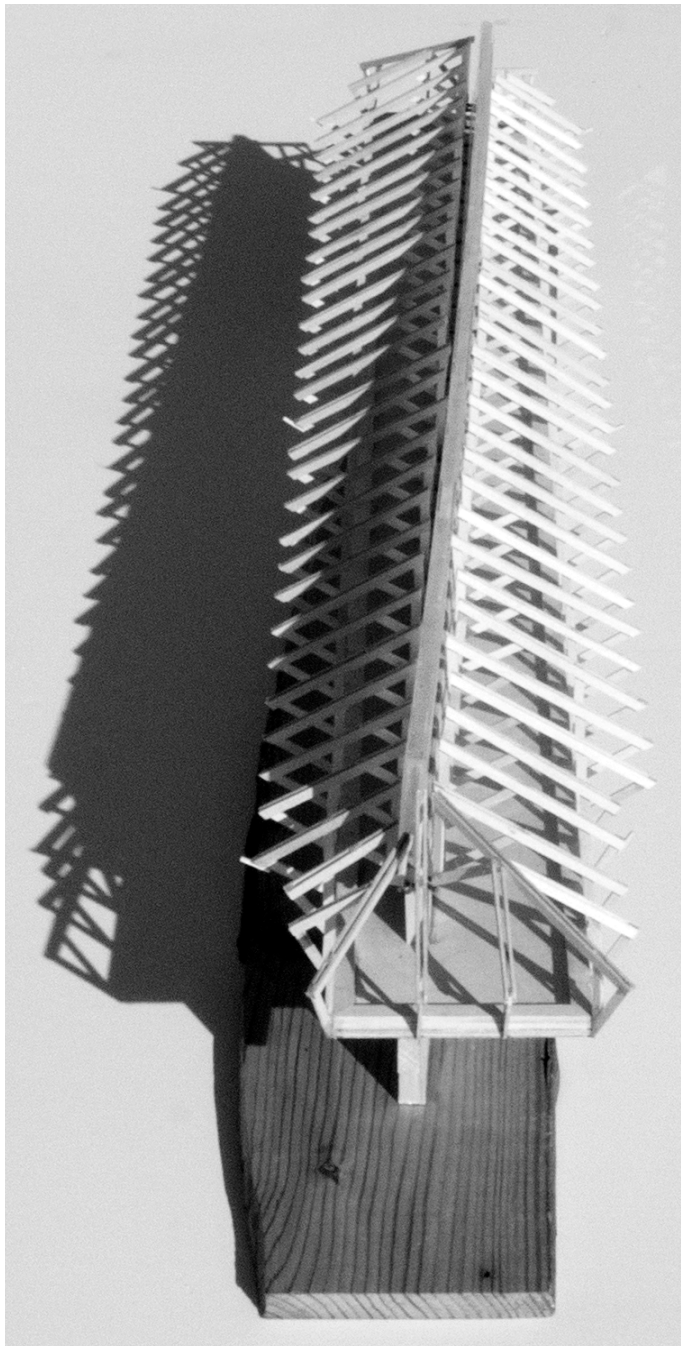

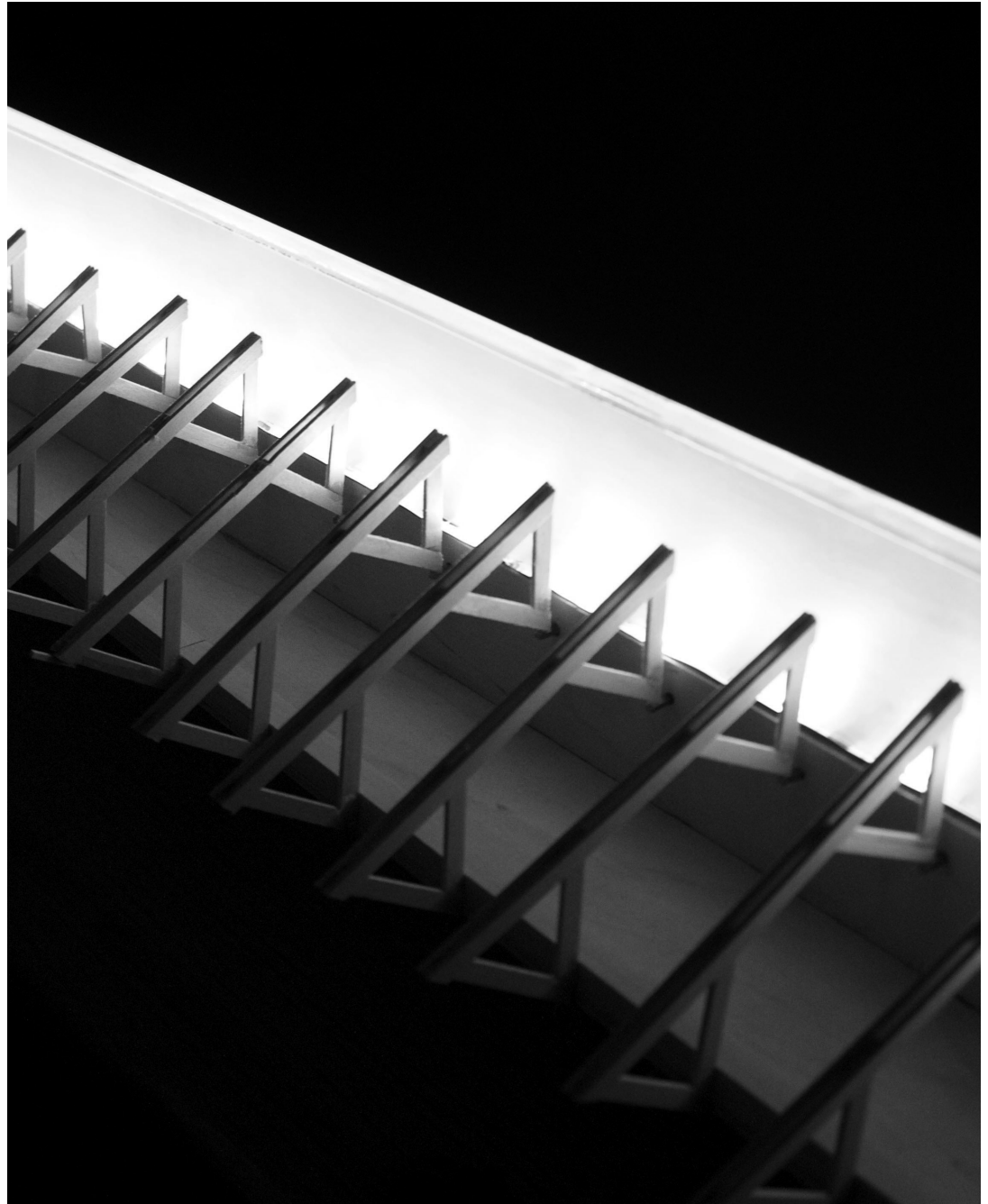
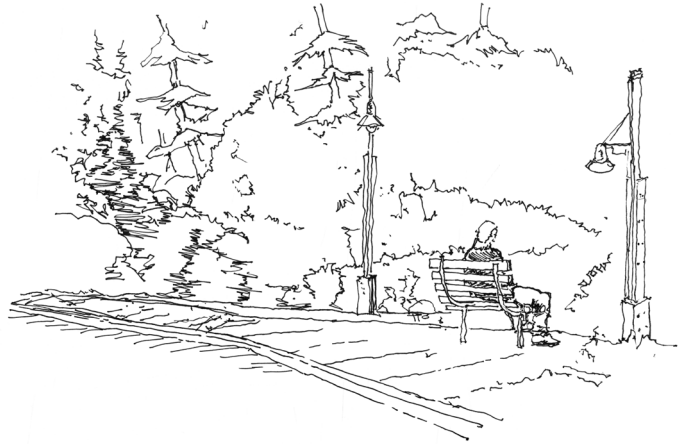



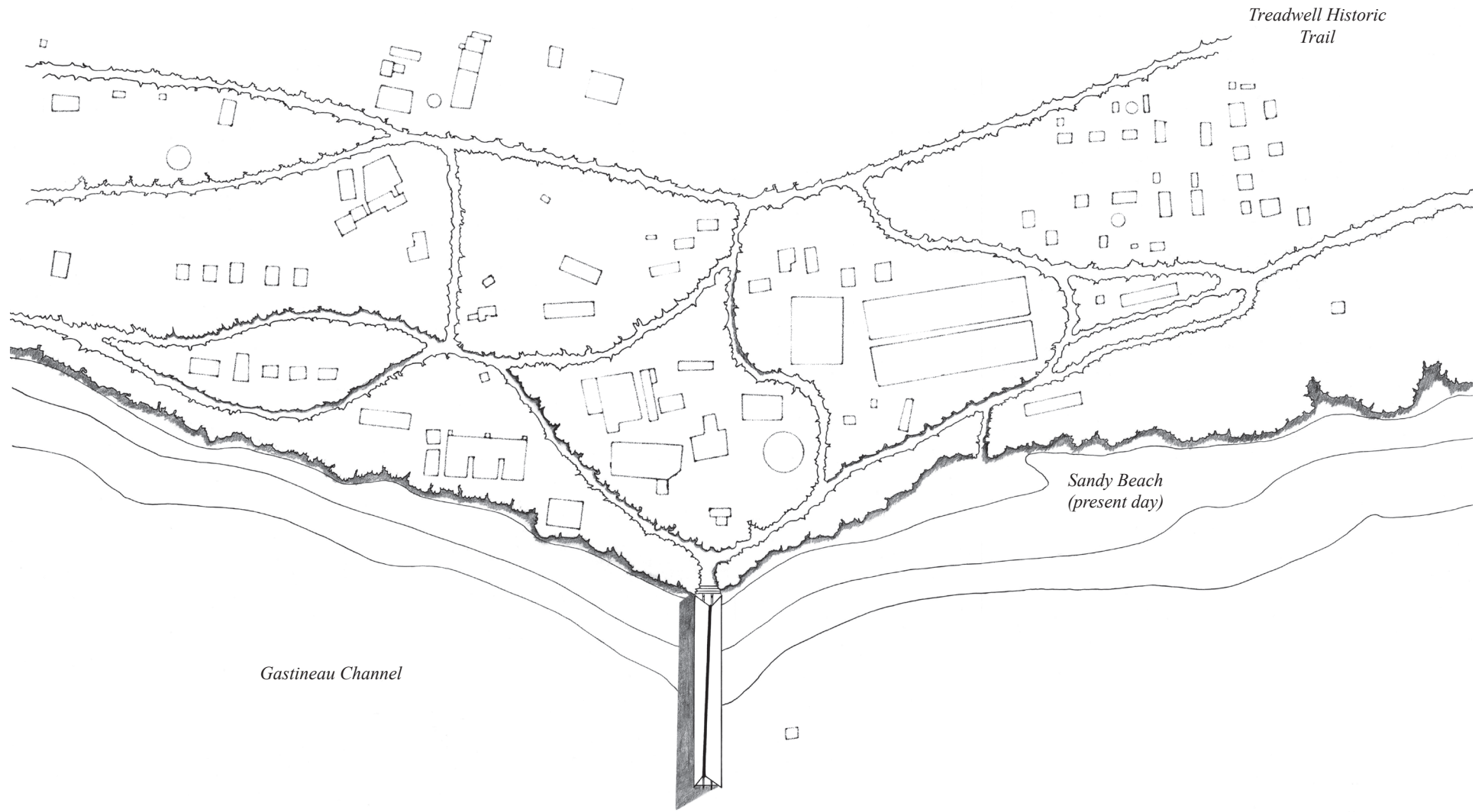

*Gastineau Channel*

*Sandy Beach  
(present day)*

*Treadwell Historic  
Trail*

SITE PLAN



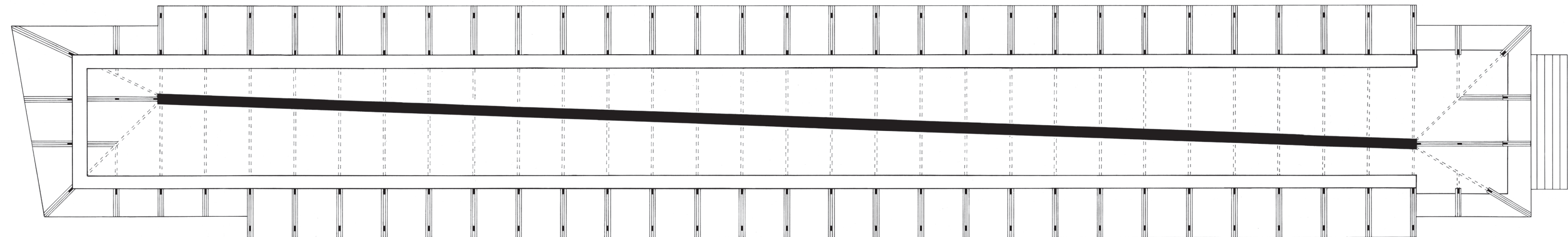

PLAN

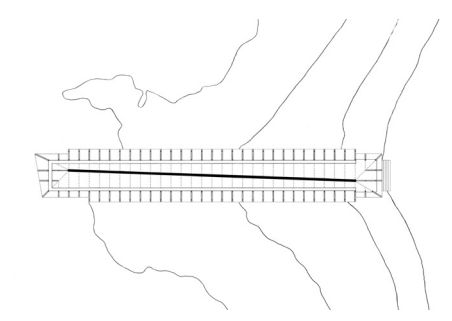
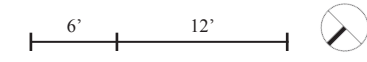

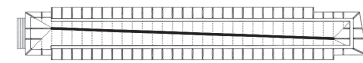
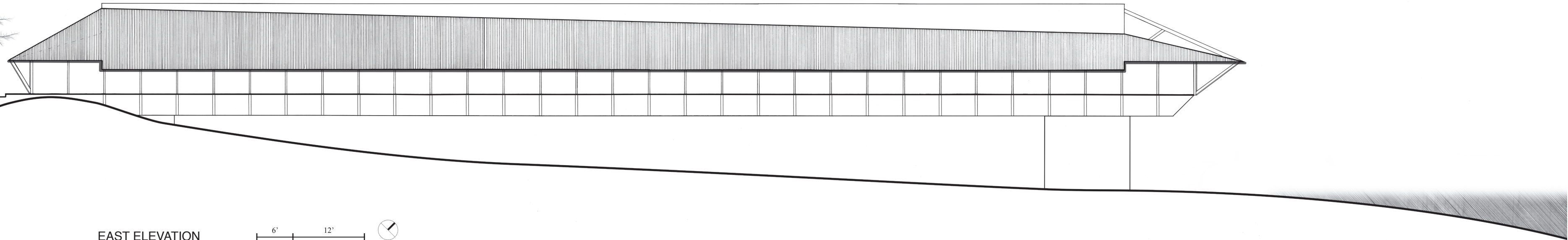

EAST ELEVATION



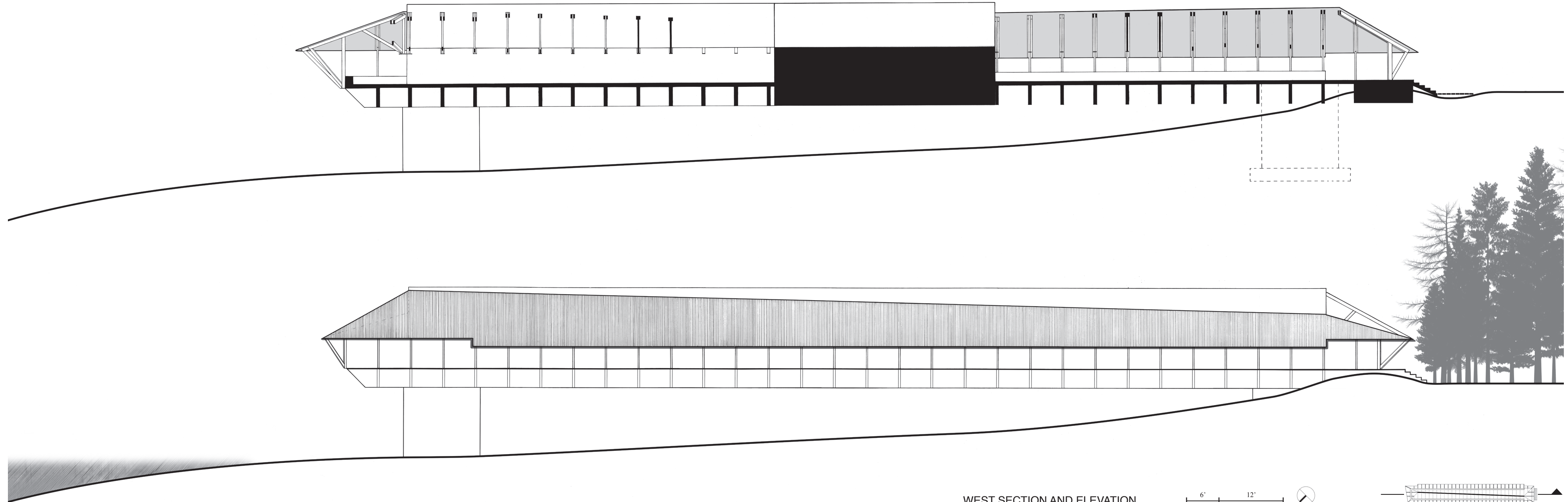

WEST SECTION AND ELEVATION

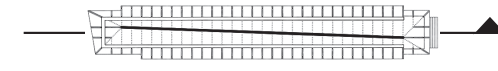
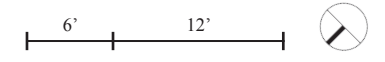

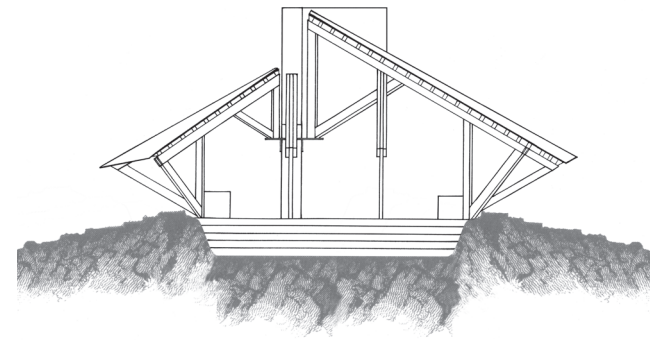

NORTH ELEVATION

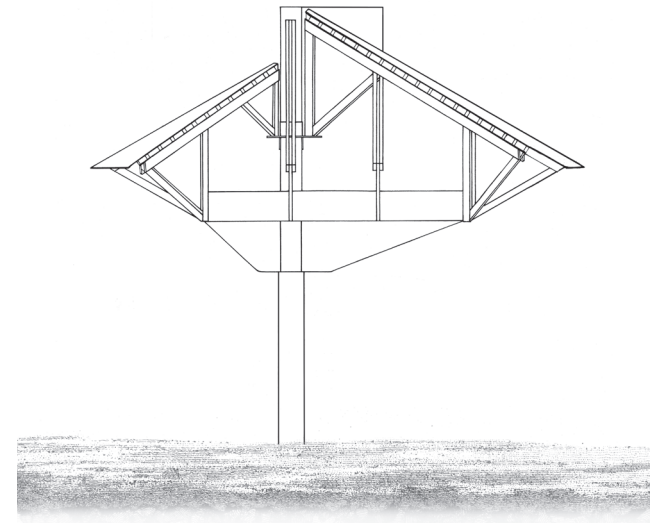

SOUTH ELEVATION

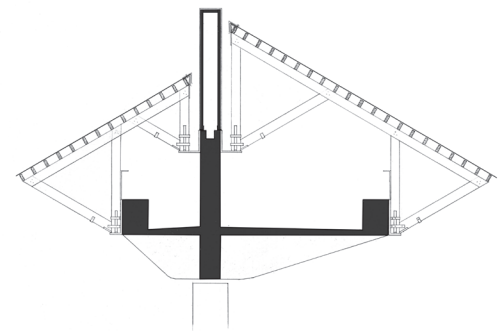

SECTION

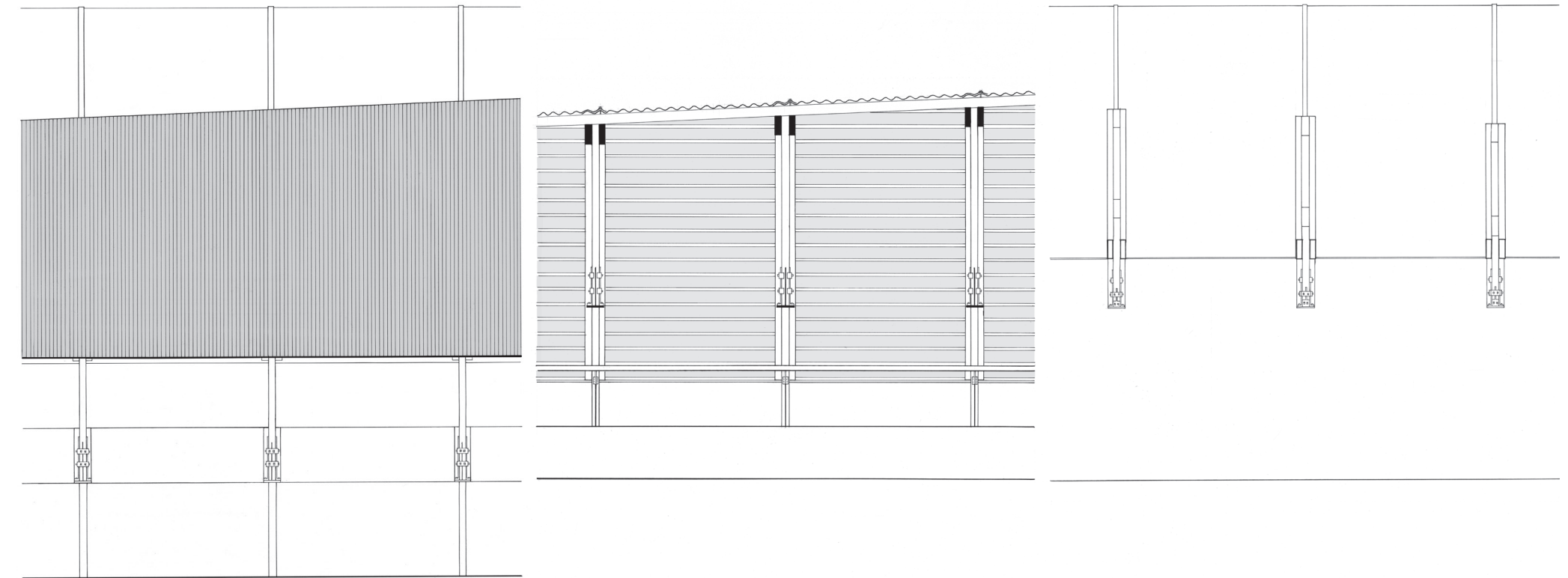
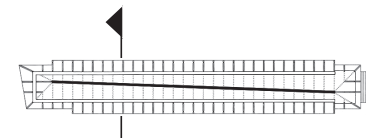
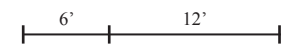



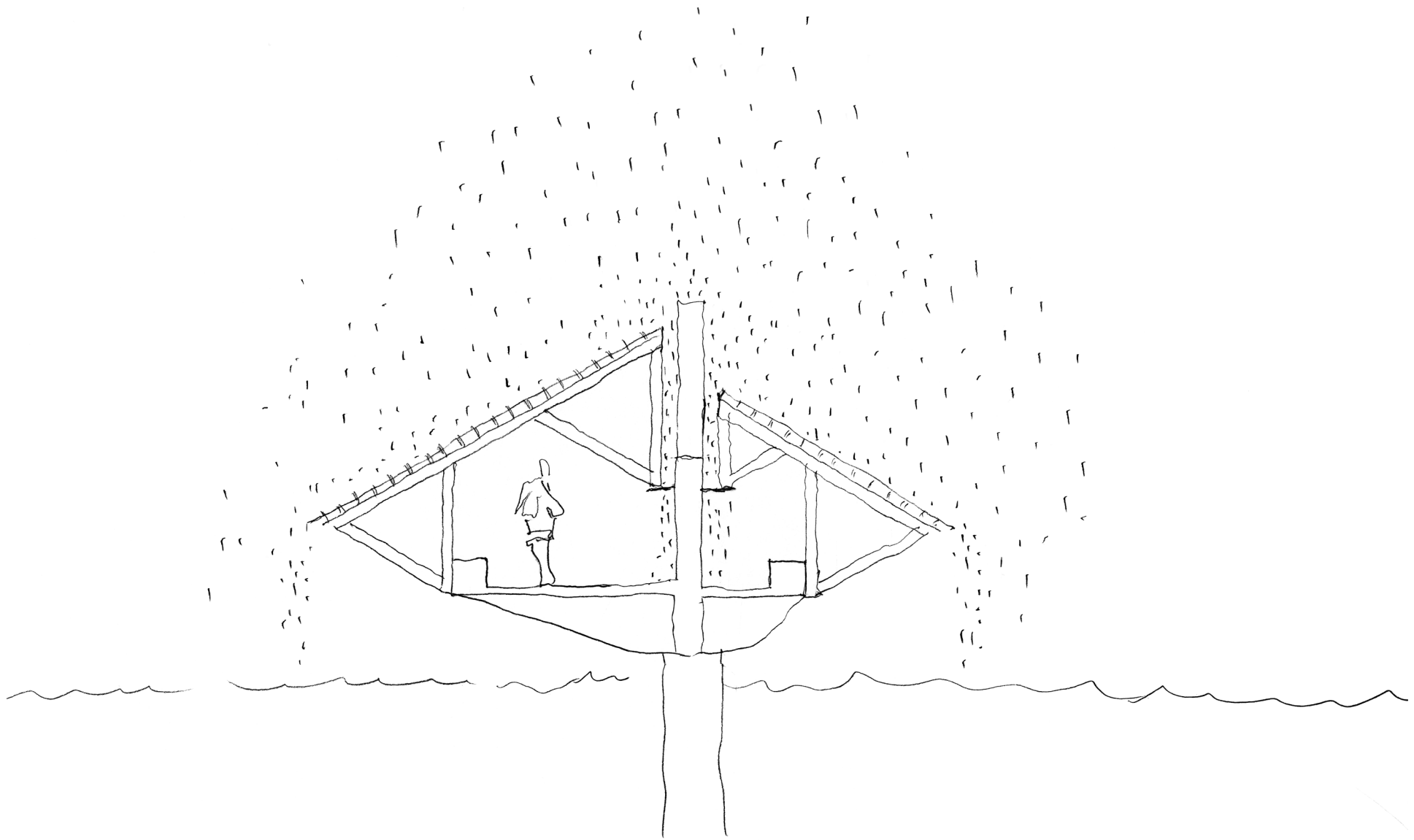

## VI: METHOD

My search for representation and expression was fueled through the making of models.

My details were generated from an analysis of the models considering perceptual judgments, structural integrity, and function. The repeating joint detail became a creative catalyst to build section models.

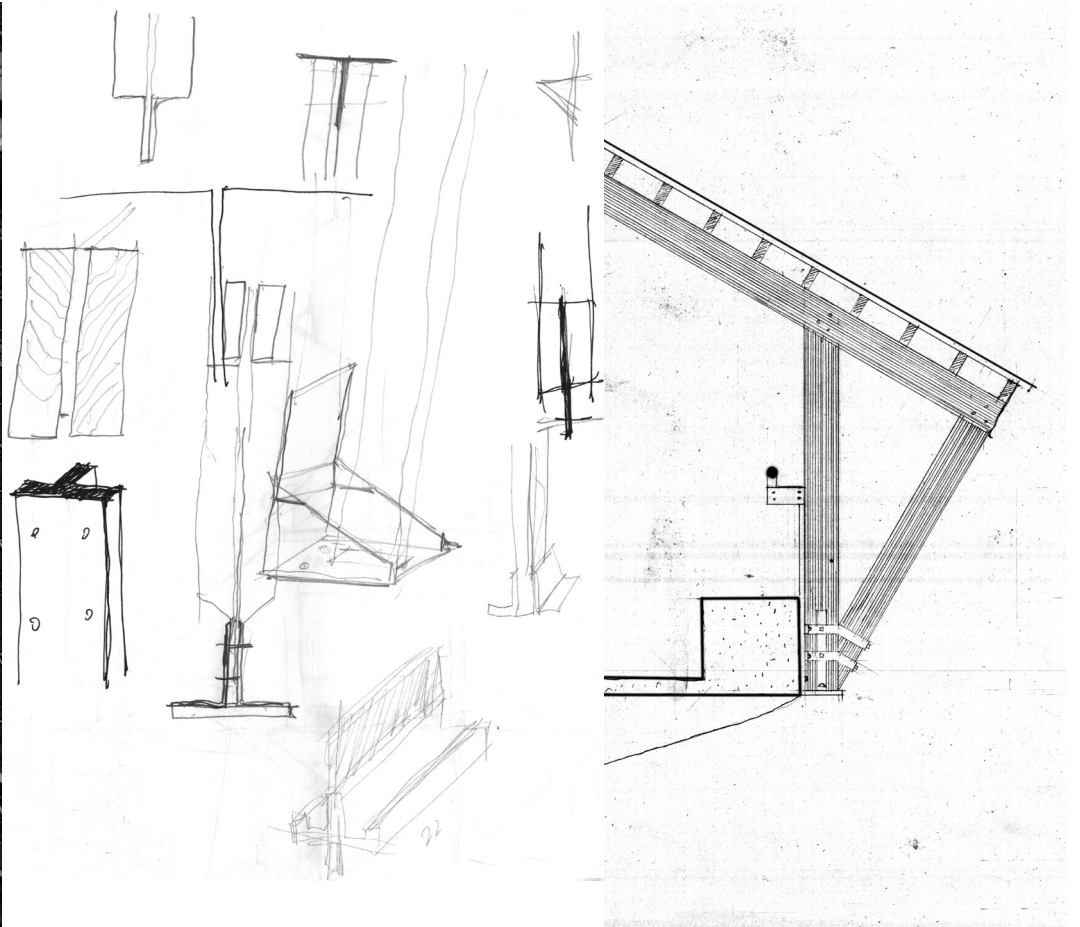

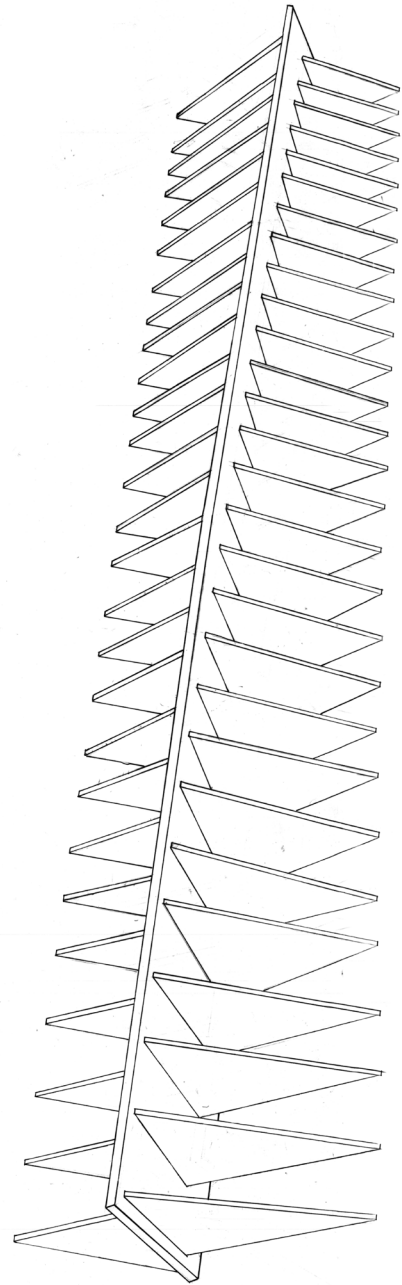

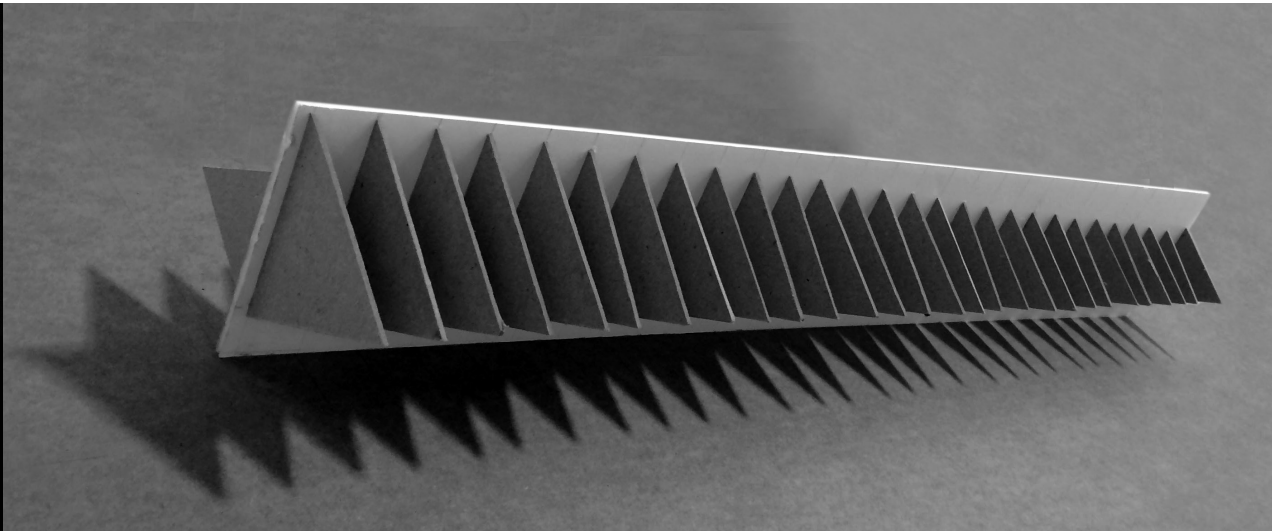
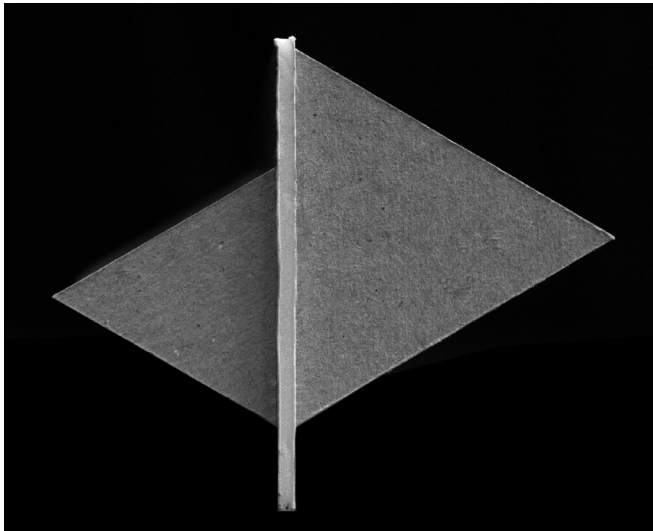

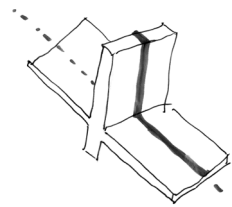
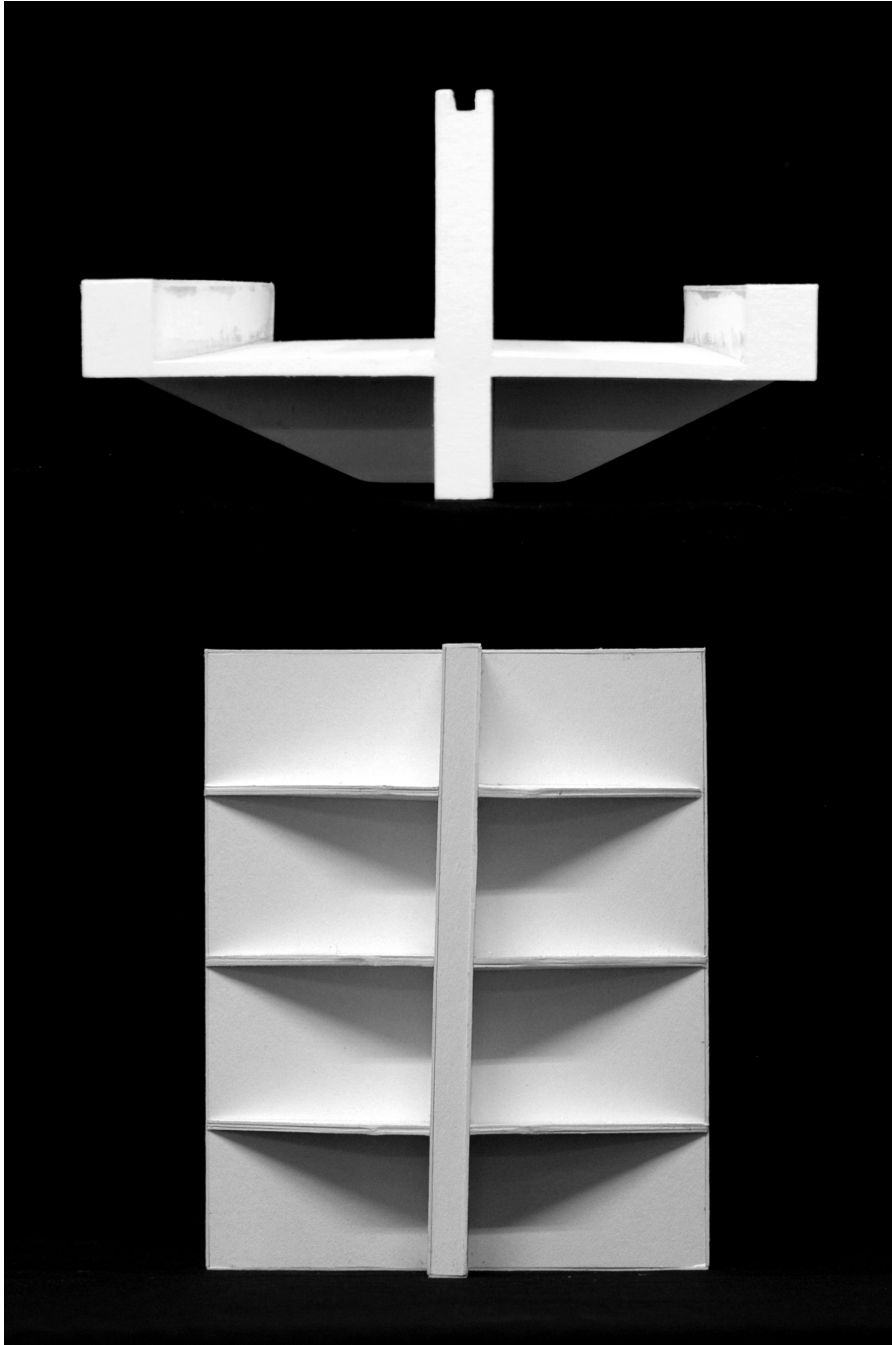



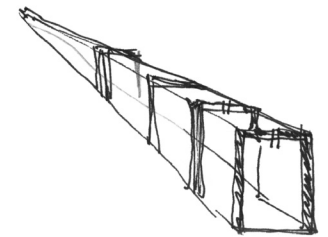
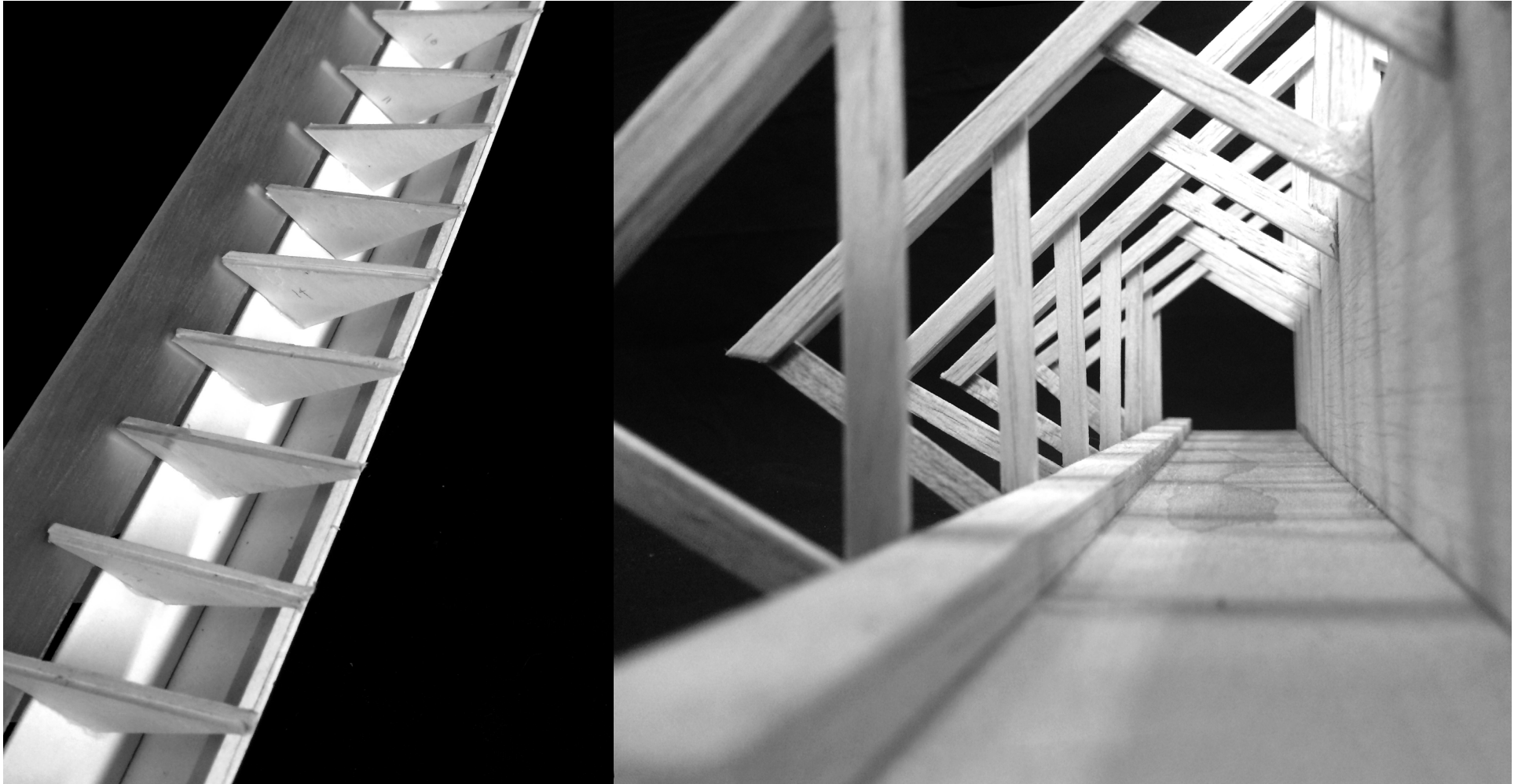

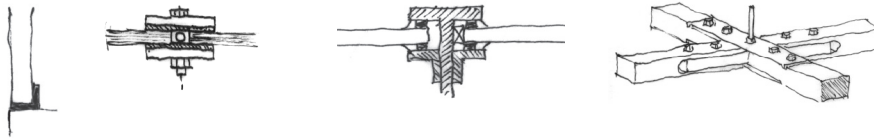
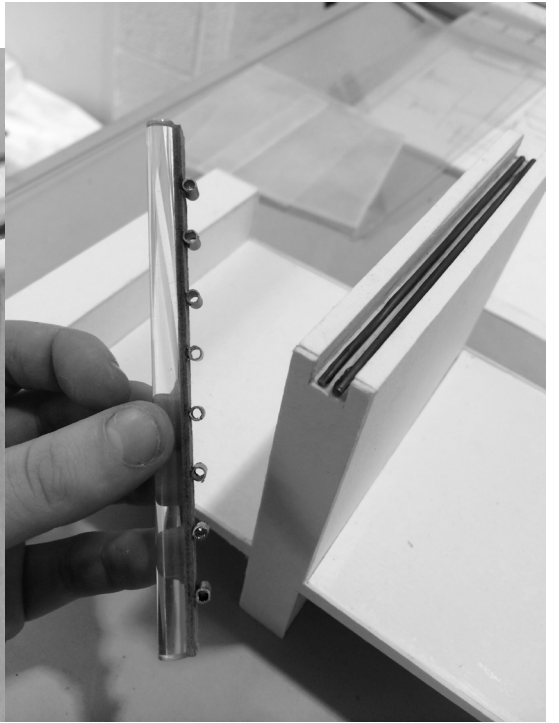
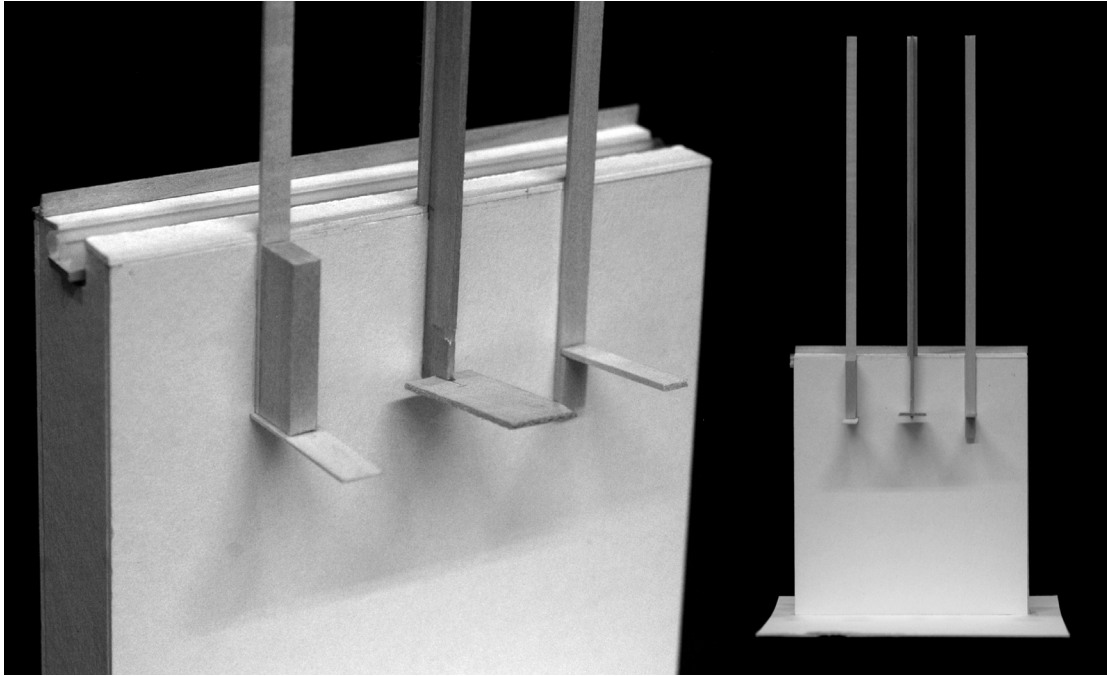



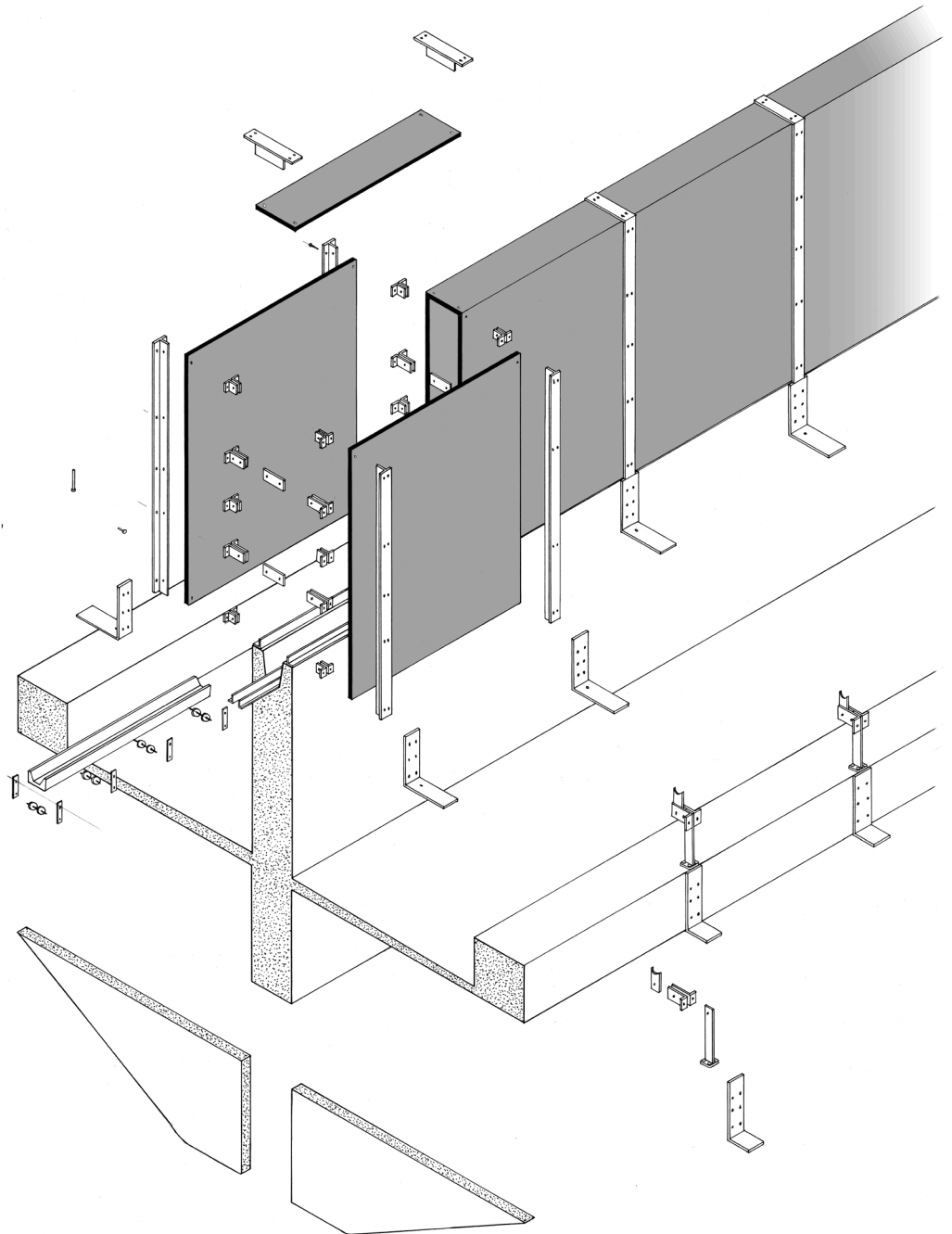

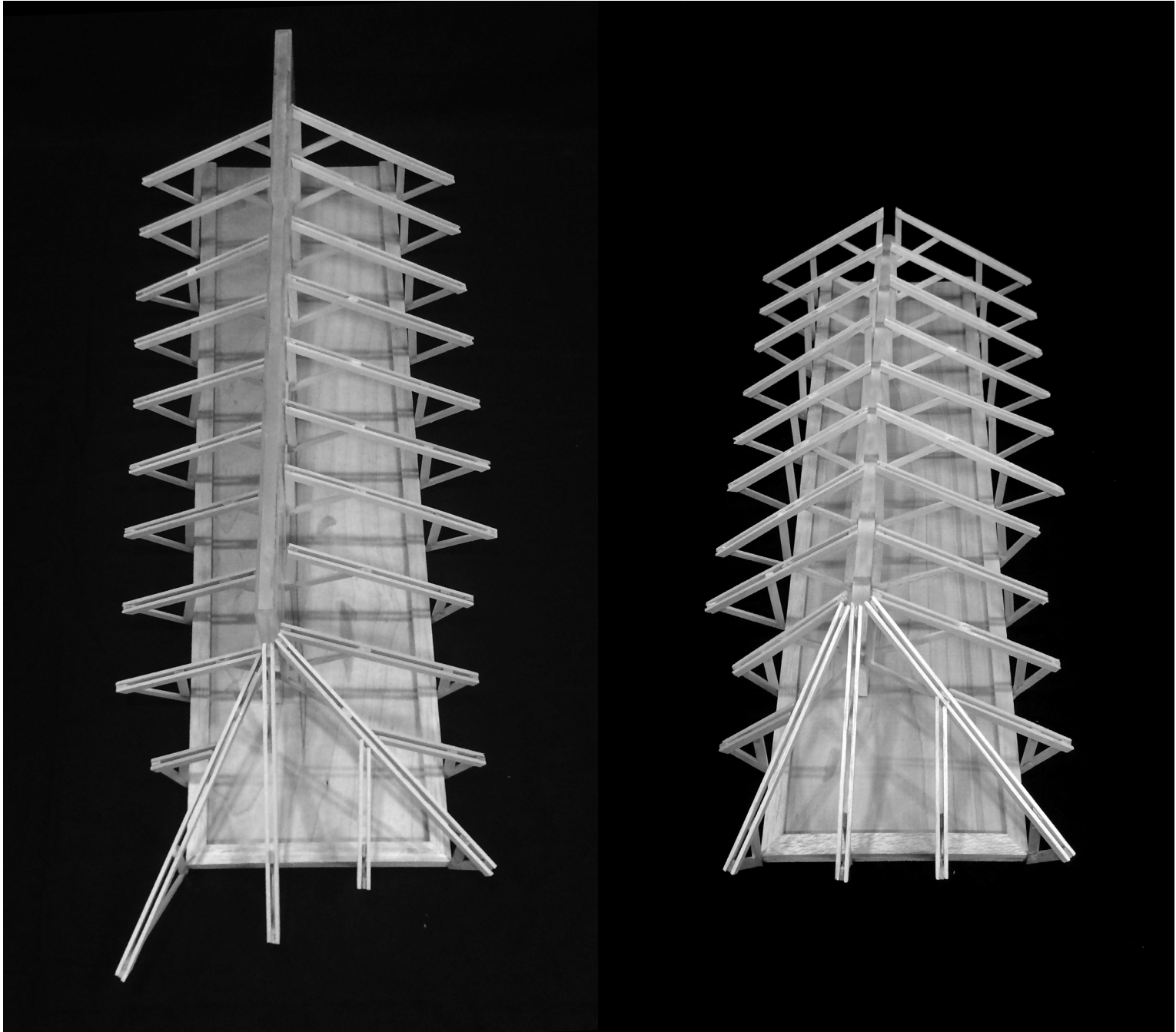

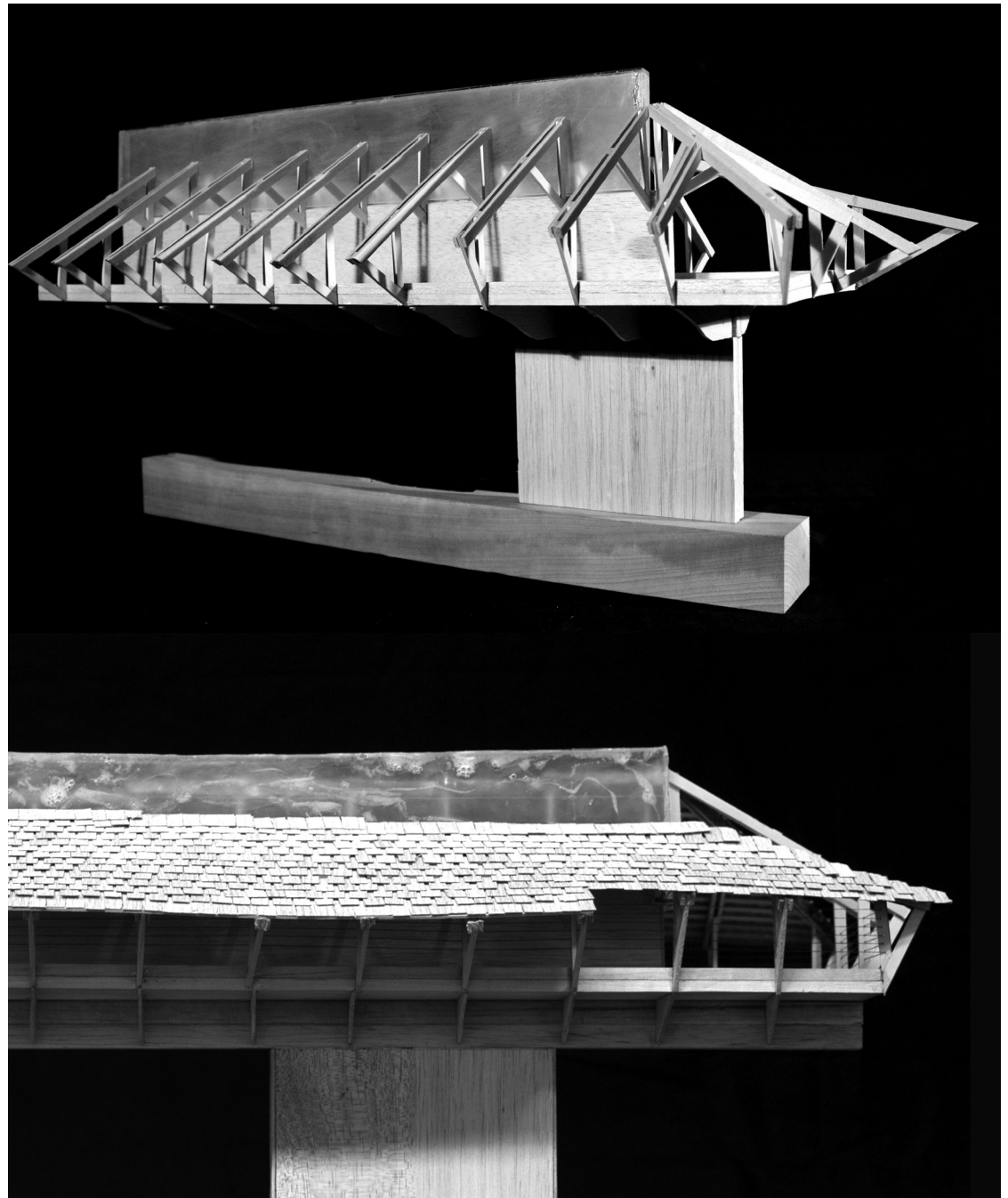





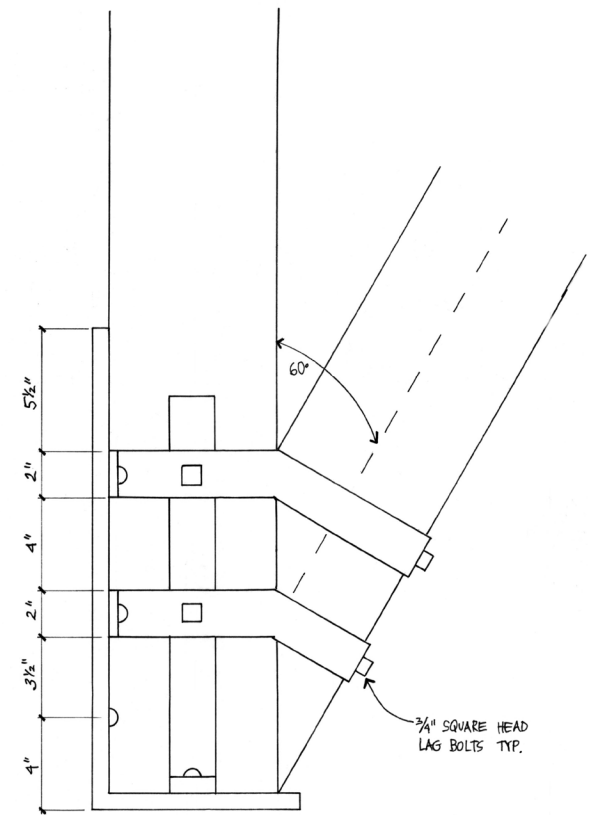
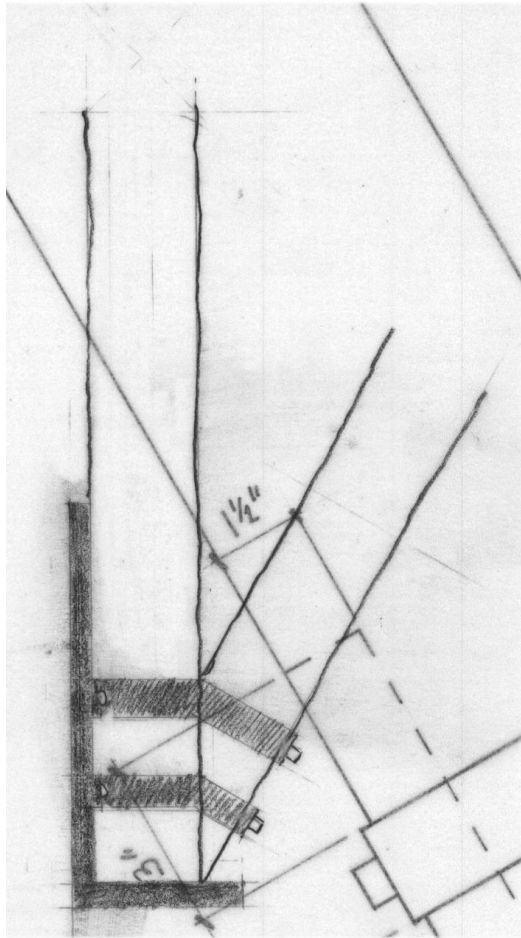



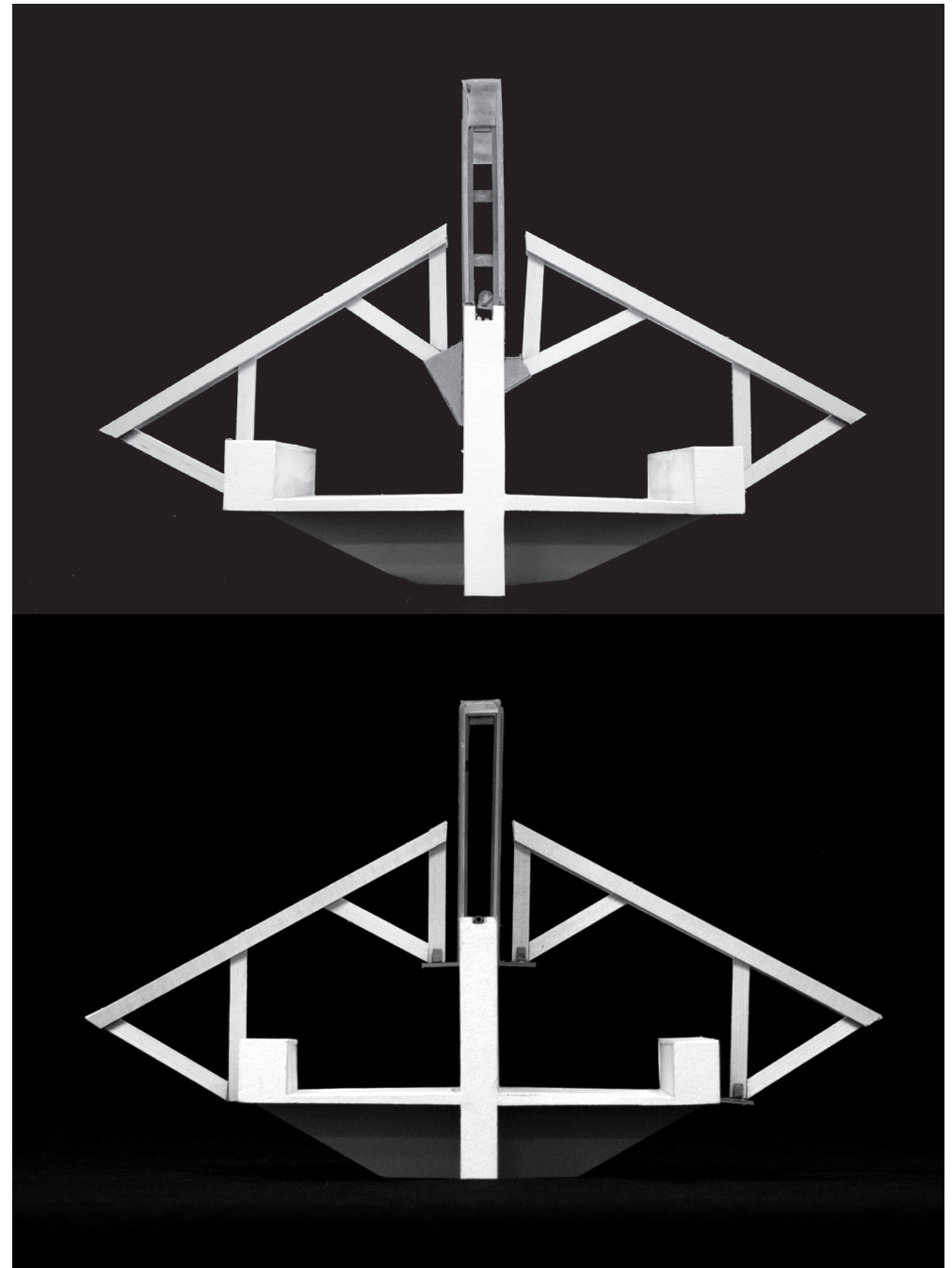
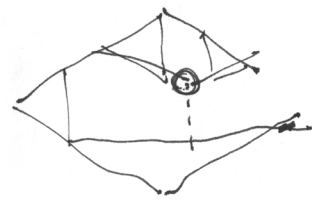





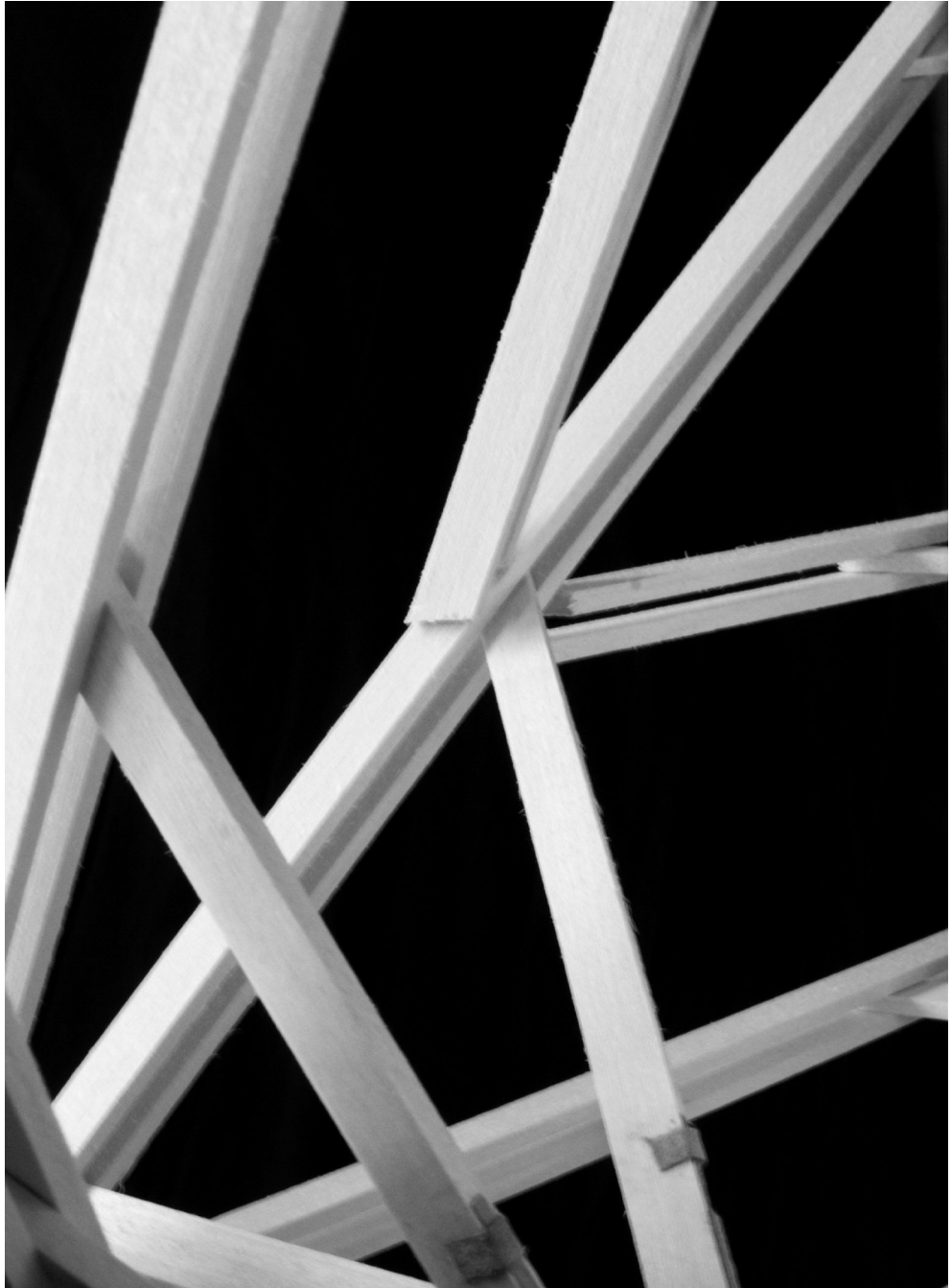
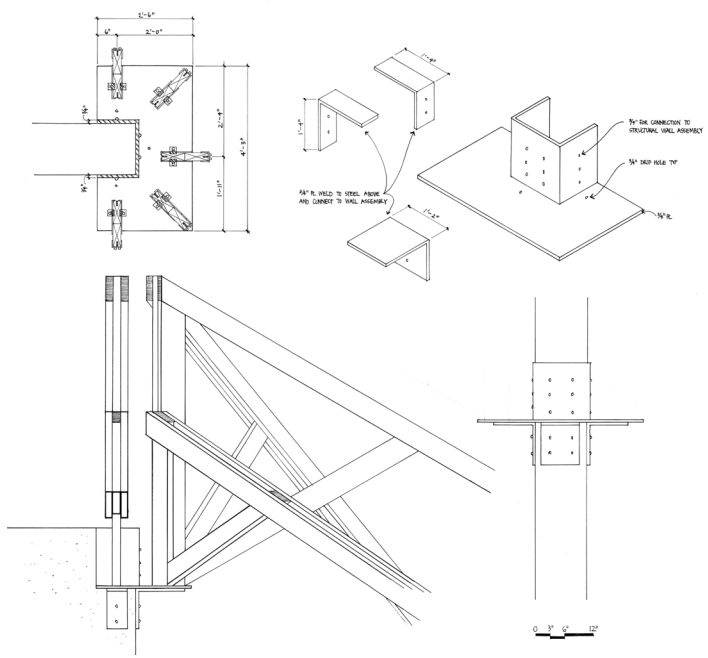



## VII: PROCESS OF DISCOVERY

When I was lost in my thesis, I explored the idea of place.  
There is a lot of value in the mystique of the environment.

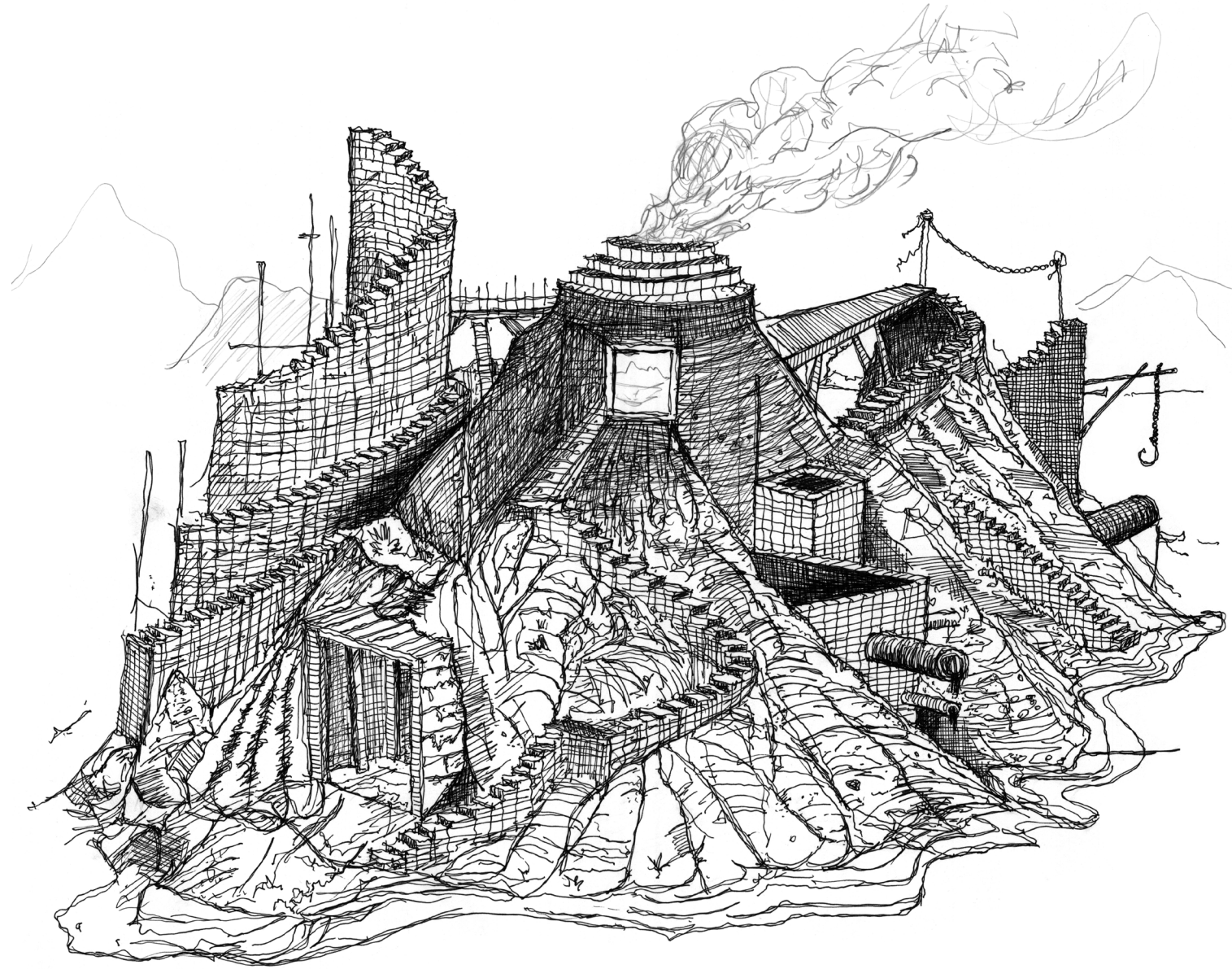



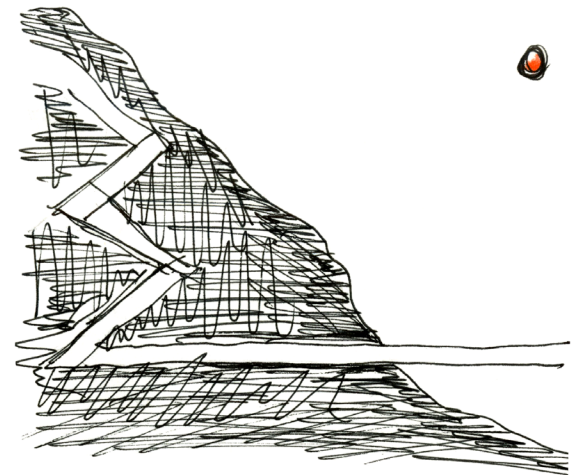
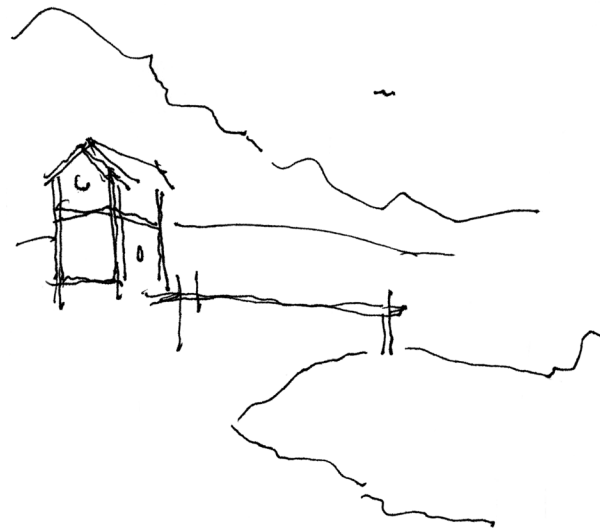
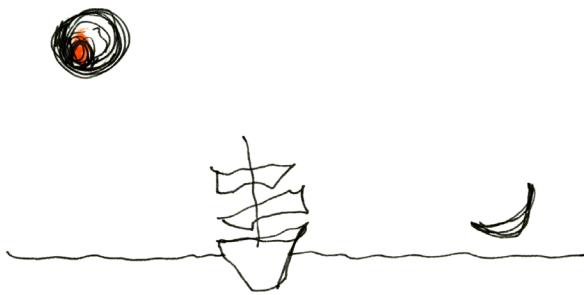
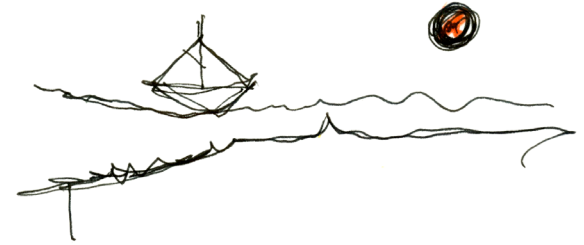
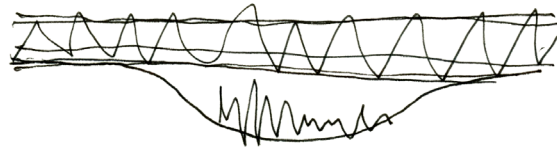
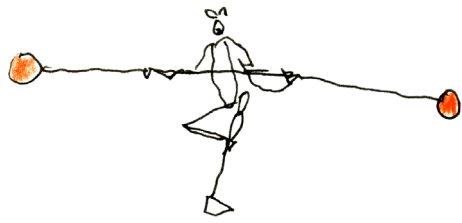



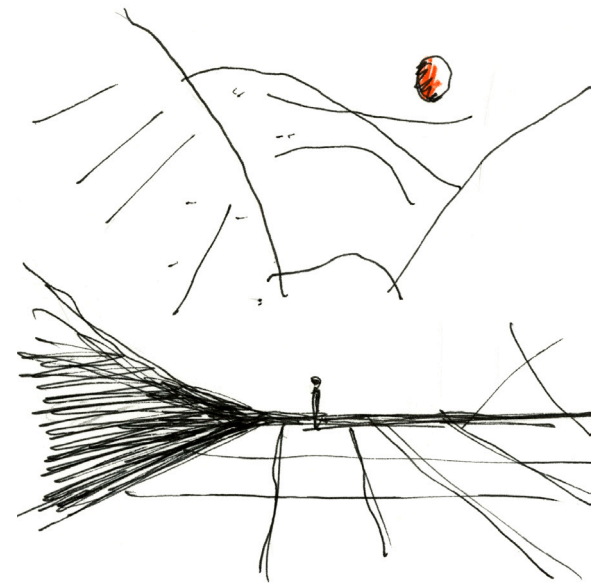
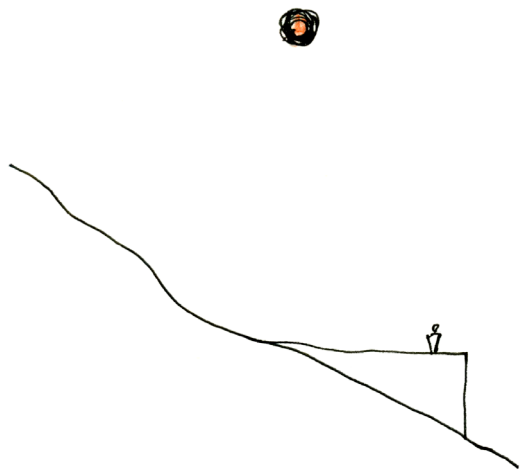
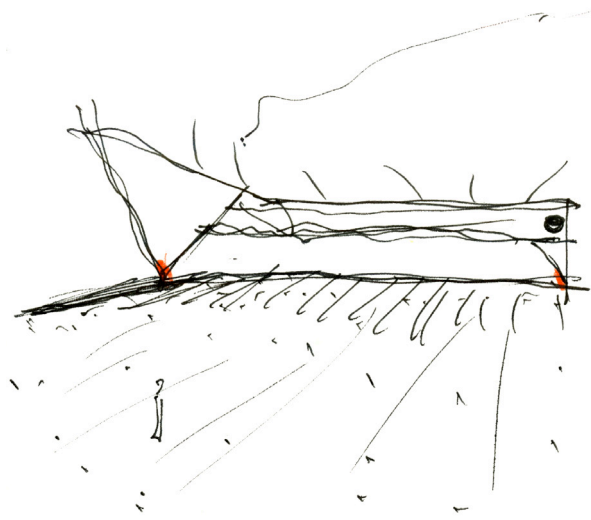
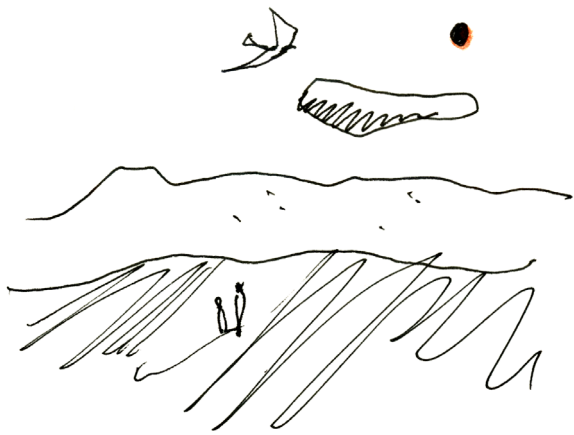



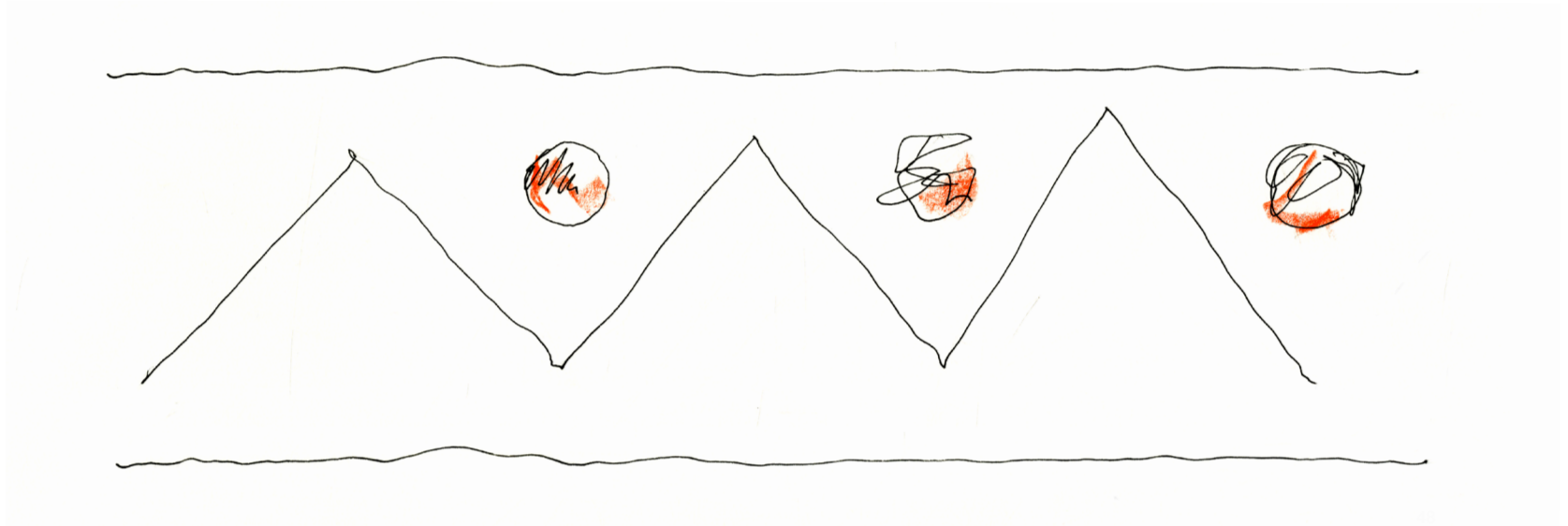
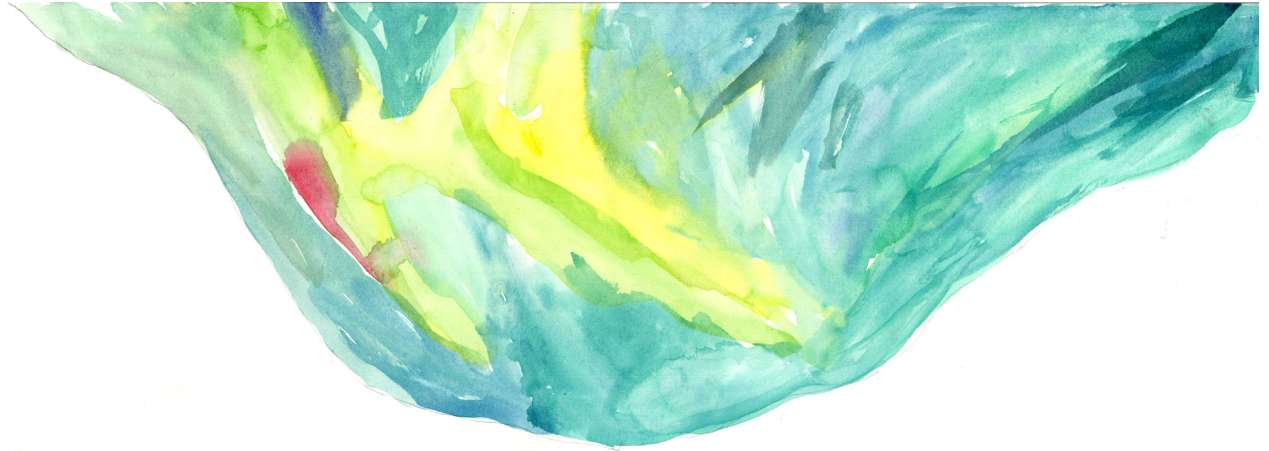



TRANSFORMATION  
OF WING . . . .  
BODY OF BIRD

HOW TO  
USE WINGS  
IN A BUILDING

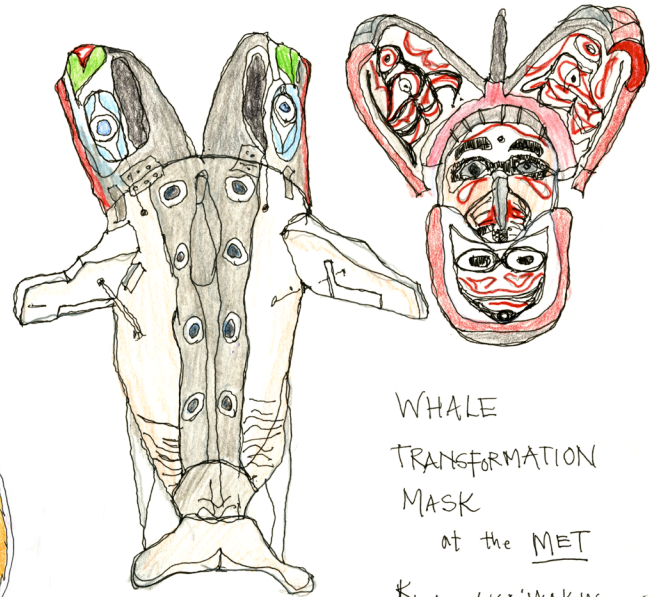
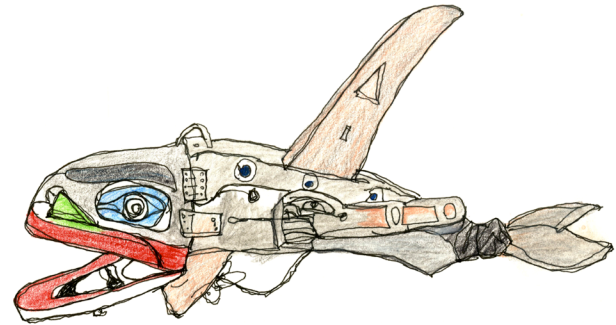

WHALE  
TRANSFORMATION  
MASK  
at the MET  
KWAKWAKA'WAKW B.C.



