

THE STABILITY OF PORTALS IN ROCK

by

Gary K. Rogers

Dissertation submitted to the Faculty of the
Virginia Polytechnic Institute and State University
in partial fulfillment of the requirements for the degree of

DOCTOR OF PHILOSOPHY

in

Mining and Minerals Engineering

APPROVED:

C. Haycocks, Chairman

M. Karmis, Department Head

J.M. Duncan

G.H. Luttrell

G.J. Faulkner

May, 1989

Blacksburg, Virginia

THE STABILITY OF PORTALS IN ROCK

by
Gary K. Rogers
Committee Chairman: Dr. C. Haycocks
Mining and Minerals Engineering

(ABSTRACT)

Portals are frequently an exceedingly difficult area in terms of ground control due to the near-surface, weathered, and highly discontinuous rock mass conditions. Surface and subsurface failures involving portals were analyzed using over 500 case histories which were organized into a database. Critical factors contributing to both stability and instability were isolated, and failures were classified according to location. Correlations between rock mass classes and types of portal failure were made and a four step stability analysis methodology defined. To determine critical sections of portal approach cuts for stability analysis, the Geomechanics Classification System was appended with discontinuity orientation adjustments. The most common type of failure for active portals, that of 'Crown Face Overbreak' failure, was investigated and modelled for design and support purposes. Results are confirmed using case study data. Excavation and support guidelines, based on database information the predicted failure zone from the 'Crown Face Overbreak' model are provided.

ACKNOWLEDGMENTS

I dedicate this work to my wife, , for her undying love, patience, and encouragement; and to my family, without whose support and guidance I could never have attained this goal.

The author would like to thank his advisor, Dr. C. Haycocks and committee members; Dr. M. Karmis, Dr. J.M. Duncan, Dr. G.H. Luttrell, Dr. G.J. Faulkner, and Dr. T. Jones, as well as the staff members of all the cooperating mining, quarrying, and tunnelling companies, along with the various state and federal agencies who have made many valuable contributions to this research project.

Special thanks go to Dr. T. Brekke of the University of California - Berkeley, G.S. Brierley of Brierley & Lyman; D. Cavers of Hardy BBT Limited; D. Decker of Pittston Coal; C. Dell; H. Kennedy of Virginia Lime; T.R. Kuesel, R.F. Flanagan, and W.H. Hansmire of Parsons Brinckerhoff; A.M. Petrofsky of Jacobs Associates; R.H. Robinson of Pincock, Allen & Holt; M. Seijo of the WV Dept. of Energy; R.E. Steffens of Duke Power; and Dr. Y. Zhou for their extremely valuable assistance and concise thoughts on portal design.

This research is based on work supported by the Mining and Mineral Resources Research Institute which is funded by the U.S. Bureau of Mines. Opinions, findings, conclusions, and recommendations herein presented are those of the author and do not necessarily reflect the views of the sponsor.

TABLE OF CONTENTS

ABSTRACT	ii
ACKNOWLEDGEMENTS	iii
TABLE OF CONTENTS	v
LIST OF ILLUSTRATIONS	viii
LIST OF FIGURES	viii
LIST OF TABLES	xiv
1.0 INTRODUCTION	1
1.1 PROBLEM AND PURPOSE	1
1.2 SCOPE AND RESEARCH OBJECTIVES	2
2.0 BACKGROUND AND LITERATURE REVIEW	4
2.1 PORTAL DEFINITION	4
2.2 NOMENCLATURE	4
2.3 HISTORY	11
2.4 TYPES OF PORTALS	16
2.4.1 NATURAL	16
2.4.2 MAN-MADE/UNPLANNED	17
2.4.3 HAZARDS OF UNPLANNED PORTALS	18
2.5 PORTAL USES	21
2.6 PORTAL DESIGN FACTORS	24
2.6.1 STATE OF STRESS	24
2.6.2 VOISSOUR ARCH AND PLATE THEORY	26
2.6.3 INSTRUMENTATION	29
2.6.4 SEISMIC RISK	31
2.6.5 DAMAGE ALLEVIATING MEASURES	32
2.6.6 REMEDIAL MEASURES	33
2.6.7 EXTENT OF SUBSIDENCE/COLLAPSE	34
2.6.8 SEALS	35
2.6.9 COST	39
2.6.10 SUBSURFACE CONTRACT SPECIFICATIONS	39
2.6.11 REGULATORY LEGISLATION	40
3.0 PORTAL CASE HISTORY DATABASE	45
3.1 LITERATURE SOURCES	46
3.2 FIELD STUDIES	47
3.2.1 GEOLOGICAL MAPPING	47
3.2.2 SCHMIDT HAMMER TEST	48
3.2.3 SPECIMEN SAMPLING	49
3.2.4 LABORATORY TESTING	49
3.2.5 LONG-TERM BEHAVIOR	50
3.3 INDUSTRY COMMENTS	50
3.4 NATURAL PORTALS	51

3.5	DATABASE ORGANIZATION AND TREND ANALYSIS	52
3.5.1	NAME/NUMBER	57
3.5.2	LOCATION	57
3.5.3	TYPE OF PORTAL	57
3.5.4	DATE BUILT	61
3.5.5	AGE	61
3.5.6	SHAPE	61
3.5.7	DIAMETER	62
3.5.8	WIDTH	65
3.5.9	HEIGHT	65
3.5.10	CROSS SECTION	66
3.5.11	ROCK MASS	66
3.5.12	DIFFICULTY	67
3.5.13	LENGTH OF DIFFICULTY	72
3.5.14	FAILURE CLASSIFICATION	79
3.5.15	SUPPORT UTILIZED	86
3.5.16	DRIVAGE METHOD	90
3.5.17	DRIVAGE SECTION	91
3.5.18	REFERENCE	92
4.0	PORTAL FAILURE CLASSIFICATION	98
4.1	EXTERNAL FAILURE TYPES	99
4.1.1	OVERALL MASS SLIDE	99
4.1.2	UPPER SLOPE SLIDE	105
4.1.3	OUTER RIB SLIDE	111
4.1.4	UPPER SLOPE SUBSIDENCE/COLLAPSE	115
4.2	INTERNAL FAILURE TYPES	132
4.2.1	CROWN FACE OVERBREAK	132
4.2.2	INTERNAL COLLAPSE	137
4.3.3	INVERT FAILURE	143
4.3.4	SEAL RUPTURE	146
5.0	PORTAL DESIGN ANALYSIS	149
5.1	ANALYSIS OPTIONS	149
5.2	ROCK MASS CLASSIFICATION SYSTEMS	152
5.2.1	TERZAGHI'S ROCK LOAD METHOD	153
5.2.2	'Q' SYSTEM	158
5.2.3	GEOMECHANICS (RMR) SYSTEM	165
5.2.4	ROCK QUALITY DESIGNATION (RQD)	166
5.2.5	ROCK QUALITY RATING (RSR)	166
5.3	STABILITY ANALYSES METHODOLOGY	167
5.3.1	SITE CHARACTERIZATION	167
5.3.2	OVERALL SLOPE STABILITY ANALYSIS	170
5.3.3	APPROACH CUT SLOPE STABILITY ANALYSIS	173
5.3.4	UNDERGROUND STABILITY ANALYSIS	177
6.0	PORTAL DESIGN ADVANCES	181
6.1	RMR MODIFICATIONS FOR SLOPE STABILITY ASSESSMENT	181
6.2	CROWN FACE OVERBREAK MODEL	189
6.3	EXCAVATION/SUPPORT GUIDELINES	203

6.3.1 EXCAVATION	203
6.3.2 ROCK REINFORCEMENT	207
6.3.3 SHOTCRETE	209
6.3.4 STEEL SETS/PORTAL CANOPY	211
6.3.5 DESIGN PHILOSOPHY	212
7.0 SUMMARY, CONCLUSIONS, AND RECOMMENDATIONS	219
7.1 SUMMARY	219
7.2 CONCLUSIONS	222
7.3 RECOMMENDATIONS	225
REFERENCES	227
APPENDIX 1: PORTAL NOMENCLATURE AND DEFINITIONS	257
A1.1 NOMENCLATURE	257
A1.2 DEFINITIONS	267
APPENDIX 2: PORTAL AND INDUSTRY REFERENCES	271
A2.1 PORTAL REFERENCES	271
A2.2 INDUSTRY REFERENCES	273
APPENDIX 3: INDUSTRY COMMENTS	276
A3.1 CONSERVATIVE DESIGN	276
A3.2 INFORMATION AVAILABLE	276
A3.3 DEPTH TO TURN-UNDER	276
A3.4 PROPRIETARY INFORMATION	277
A3.5 LOCATION	277
A3.6 SUPPORT	278
A3.7 FAILURE	279
A3.8 PRACTICAL METHODOLOGY	279
APPENDIX 4: PORTAL DATABASE - TABLE FORMAT	280
APPENDIX 5: SARMA/HOEK CODE LISTING	304
VITA	318

LIST OF ILLUSTRATIONS

<u>Figure</u>	<u>Page</u>
Figure 2-1. 3-D External View of a Portal in a 45° Slope (portal axis perpendicular to slope).....	6
Figure 2-2. 3-D Internal View of a Portal in a 45° Slope (portal axis perpendicular to slope).....	7
Figure 2-3. Front View (Perpendicular to Portal Centerline Axis) of a Portal in a 45° Slope (portal axis perpendicular to slope).....	8
Figure 2-4. Cross Sectional (Portal Centerline Axis) View of a Portal in a 45° Slope (portal axis perpendicular to slope)....	9
Figure 2-5. Plan View of a Portal in a 45° Slope (portal axis perpendicular to slope)....	10
Figure 2-6. Turning-Under a Mine Portal, Circa 1530.	12
Figure 2-7. Similarity of Plate Fracture Theory to 'Crown Face Overbreak' Failure at Portals.....	28
Figure 2-8. Example Design for a Mechanically Placed Portal Seal for Wet Conditions at Cabin Creek, West Virginia.....	38
Figure 3-1. Portal Type Distribution.....	60
Figure 3-2. Portal Shape Distribution.....	64
Figure 3-3. Portal Rock Type Distribution.....	69
Figure 3-4. Portal Rock Structure Distribution.....	70
Figure 3-5. Portal Difficulty Distribution.....	74
Figure 3-6. Portal Span VS. Length of Difficulty - Subsidence/Collapse Failure.....	76

Figure 3-7.	Portal Span VS. Length of Difficulty - Crown Face Overbreak Failure.....	77
Figure 3-8.	Portal Span VS. Length of Difficulty - Internal Collapse, Outer Rib Slide, Upper Slope Slide, and Invert Failure...	78
Figure 3-9.	Portal Failure Distribution.....	82
Figure 3-10.	Abandoned Portal Failure Distribution...	83
Figure 3-11.	Portal Failures Per Rock Mass Type.....	84
Figure 3-12.	Portal Failure Classification Correlation with Rock Mass Type.....	85
Figure 3-13.	Portal Support Classification Distribution.....	89
Figure 3-14.	Portal Drivage Method Distribution.....	94
Figure 3-15.	Portal Drivage Methods - Specific Breakdown.....	95
Figure 3-16.	Portal Drivage Section Distribution.....	97
Figure 4-1.	Cross Sectional (Portal Centerline Axis) and Plan View of the Portal Overall Mass Slide Failure.....	100
Figure 4-2.	Portal Overall Mass Slide Failure of a Railroad Tunnel in New Zealand.....	101
Figure 4-3.	Cross Section of the Unterstein Tunnel Overall Mass Failure.....	102
Figure 4-4.	Portal Overall Mass Slide Failure of the Pontesei Reservoir Tunnel.....	103
Figure 4-5.	Overall Portal Failure of the James River Limestone Quarry Natural Portals..	104
Figure 4-6.	Cross Sectional (Portal Centerline Axis) and Plan View of the Portal Upper Slope Slide Failure.....	107
Figure 4-7.	3-D View of a Portal Upper Slope Slide in a 45° Slope.....	108
Figure 4-8.	Plan View of a Portal Upper Slope Slide in a 45° Slope.....	109

Figure 4-9.	Cross Sectional View of a Portal Upper Slope Slide at a Dolomite Quarry Above Abandoned Underground Workings.....	110
Figure 4-10.	Cross Sectional (Perpendicular to Portal Centerline Axis) and Plan View of the Outer Rib Failure.....	112
Figure 4-11.	3-D View of an Outer Rib Failure in the Right Outer Rib of a Portal Approach Cut in a 45° Slope.....	113
Figure 4-12.	Plan View of an Outer Rib Failure in the Right Outer Rib of a Portal Approach Cut in a 45° Slope.....	114
Figure 4-13.	Cross Sectional (Portal Centerline Axis) and Plan View of the Upper Slope Subsidence/Collapse Failure.....	117
Figure 4-14.	3-D View of the Initial Subsidence/Collapse Failure of a Portal Driven Parallel to a 45° Slope...	118
Figure 4-15.	Cross Sectional (Perpendicular to Portal Centerline Axis) View of the Initial Subsidence/Collapse Failure of a Portal Driven Parallel to a 45° Slope.	119
Figure 4-16.	Plan View of the Initial Subsidence/Collapse Failure of a Portal Driven Parallel to a 45° Slope...	120
Figure 4-17.	3-D View of Subsidence/Collapse Failures of Portals Driven into a Highwall.....	121
Figure 4-18.	Cross Sectional (Portal Centerline Axis) View of Subsidence/Collapse Failures of Portals Driven into a Highwall.....	122
Figure 4-19.	Plan View of Subsidence/Collapse Failures of Portals Driven into a Highwall.....	123
Figure 4-20.	3-D View of the Initial Subsidence/Collapse Failure of an Inclined Portal (-30°) Driven from a Horizontal Surface.....	124

Figure 4-21. Cross Sectional (Portal Centerline Axis) View of the Initial Subsidence/Collapse Failure of an Inclined Portal (-30°) Driven from a Horizontal Surface..... 125

Figure 4-22. Plan View of the Initial Subsidence/Collapse Failure of an Inclined Portal (-30°) Driven from a Horizontal Surface..... 126

Figure 4-23. 3-D View of the Long-Term Subsidence/Collapse Failure of an Abandoned Portal in a 45° Slope Illustrating a Typical Portal Subsidence Trough..... 127

Figure 4-24. Plan View of the Long-Term Subsidence/Collapse Failure of an Abandoned Portal in a 45° Slope Illustrating a Typical Portal Subsidence Trough..... 128

Figure 4-25. 3-D View of the Long-Term Subsidence/Collapse Failure of an Abandoned, Inclined Portal (-30°) Driven from a Horizontal Surface..... 129

Figure 4-26. Cross Sectional (Portal Centerline Axis) View of the Long-Term, Subsidence/Collapse Failure an Abandoned, Inclined Portal (-30°) Driven from a Horizontal Surface..... 130

Figure 4-27. Plan View of the Long-Term Subsidence/Collapse Failure of an Abandoned, Inclined Portal (-30°) Driven from a Horizontal Surface..... 131

Figure 4-28. Cross Sectional (Parallel and Perpendicular to Portal Centerline Axis) Views of Portal Crown Face Overbreak Failure..... 135

Figure 4-29. 'Crown Face Overbreak' As Observed in Bell Pit Mining..... 136

Figure 4-30. Cross Sectional (Portal Centerline Axis) and Plan View of Portal Internal Collapse Failure..... 138

Figure 4-31.	Typical Propagation of Internal Collapse Failure.....	139
Figure 4-32.	3-D View of the Propagation of Internal Collapse to the Surface in a Portal Driven Parallel to a 45° Slope.....	140
Figure 4-33.	Cross Sectional (Perpendicular to Portal Centerline Axis) View of the Propagation of Internal Collapse to the Surface in a Portal Driven Parallel to a 45° Slope.....	141
Figure 4-34.	Plan View of the Propagation of Internal Collapse to the Surface in a Portal Driven Parallel to a 45° Slope...	142
Figure 4-35.	Cross Sectional (Portal Centerline Axis) and Plan View of Portal Invert Failure.....	145
Figure 4-36.	Cross Sectional (Portal Centerline Axis) and Plan View of Portal Seal (Man-made) Rupture Failure.....	148
Figure 5-1.	Nebulous Support Range from Terzaghi's Rock Load Concept.....	159
Figure 5-2.	Modified Terzaghi Rock Load Categories for a Portal Driven into a 45° Rock Slope with a Mass Density of 170 PCF....	160
Figure 5-3.	Portal Driven into a 60' Pre-split Highwall.....	161
Figure 5-4.	Modified Terzaghi Support Design Analysis for Portal Driven into a 60' Vertical Highwall.....	162
Figure 5-5.	Stepped/Planar Portal Failure Model Used for SARMA/HOEK Analysis Example....	174
Figure 6-1.	Derivation of Dip Categories for the Proposed Discontinuity Orientation Adjustments for Near-Vertical Rock Slopes.....	187
Figure 6-2.	Example of Discontinuity Orientation Adjustment for a Portal Approach Cut in a Discontinuous Rock Mass.....	188

Figure 6-3.	Portal Half-Dome, 3-D and Sectional Views.....	196
Figure 6-4.	Half-Dome Over Initial Portal Excavation (e.g. after one 5' round)....	197
Figure 6-5.	Half-Dome and Arch Zone Over Portal Excavation (e.g. after three 5' rounds).	198
Figure 6-6.	RMR and Span Versus 'Crown Face Overbreak' Heights.....	199
Figure 6-7.	'Crown Face Overbreak' Values - Low Moor Mine.....	200
Figure 6-8.	'Crown Face Overbreak' Values - Bad Creek Project.....	201
Figure 6-9.	'Crown Face Overbreak' Values - Laurel Mountain Mine.....	202
Figure 6-10.	Example of Portal Rock Reinforcement....	217
Figure 6-11.	Multiple Support Systems Utilized at the Main Access Tunnel Portal - Bad Creek Project Case History.....	218
Figure A1-1.	3-D View of a Portal in a 45° Slope (portal axis parallel to slope).....	258
Figure A1-2.	Cross Sectional (Portal Centerline Axis) View of a Portal in a 45° Slope (portal axis parallel to slope).....	259
Figure A1-3.	Plan View of a Portal in a 45° Slope (portal axis parallel to slope).....	260
Figure A1-4.	3-D and Cross Sectional (Portal Centerline Axis) View of a Inclined Portal (-30°), Driven from a Horizontal Surface.....	261
Figure A1-5.	Plan View of a Inclined Portal (-30°), Driven from a Horizontal Surface.....	262
Figure A1-6.	3-D and Plan View of Multiple Portals in a 45° Slope (portals perpendicular to slope).....	263

Figure A1-7.	3-D View of Portals Driven Into a Highwall (portals perpendicular to slope).....	264
Figure A1-8.	Cross Sectional (Portal Centerline Axis) View of Portals Driven Into a Highwall (portals perpendicular to slope).....	265
Figure A1-9.	Plan View of Portals Driven Into a Highwall (portals perpendicular to slope).....	266

<u>Table</u>		<u>Page</u>
Table 2-1.	Ground Control Regulations Affecting Portal Design.....	43
Table 3-1.	Example of Synopsis Database Format - Pilots Peak Mine Portal.....	54
Table 3-2.	Excerpt from the Table Database Format - Pilots Peak Mine Portal.....	55
Table 3-3.	Information Gathered for the Portal Database.....	56
Table 3-4.	Abbreviations for Portal Type.....	59
Table 3-5.	Abbreviations for Portal Shape.....	63
Table 3-6.	Abbreviations for Rock Mass Type.....	68
Table 3-7.	Abbreviations for Rock Mass Structure...	68
Table 3-8.	Abbreviations for Difficulty.....	73
Table 3-9.	Abbreviations for Failure Classifications.....	81
Table 3-10.	Abbreviations for Support Classifications.....	88
Table 3-11.	Abbreviations for Drivage Methods.....	93

Table 3-12.	Abbreviations for Drivage Section.....	96
Table 5-1.	Revised Terzaghi Rock Load Design Coefficients.....	155
Table 5-2.	Example of a Portal Failure Back Analysis Using the SARMA/HOEK Code.....	175
Table 5-3.	Results of SARMA/HOEK Analyses.....	176
Table 6-1.	Rating Adjustment for Discontinuity Orientations, Geomechanics Classification System.....	184
Table 6-2.	Effect of Discontinuity Strike and Dip Orientations in Tunneling.....	185
Table 6-3.	Proposed Discontinuity Orientation Adjustments for Near-Vertical Rock Slopes.....	186
Table 6-4.	Portal ($\leq 36'$ Dia.) Excavation/Support Guidelines for the Geomechanics Classification System.....	215
Table A3-1.	Portal Database - Table Format.....	280

1.0 INTRODUCTION

1.1 Problem and Purpose

Portals, which are the surface entrances to underground excavations, are frequently overlooked and yet difficult areas in terms of ground control. This is due primarily to the weathered, highly discontinuous, and stress-relieved condition of near-surface rock masses. To further complicate the problem, because the portal comprises an interface between the surface and subsurface, two engineering approaches are required for portal design and construction, those of rock slope and tunnel engineering. However, specific information on portal related failures and/or guidelines for portal design and construction do not exist, and many traditional design methods are inadequate for utilization in this complex three-dimensional boundary area.

The following excerpts are typical of those made in reference to portals:

"Frequently, the most difficult ground is at the portals. Except in the best of rock, the first rounds near the portal can result in large overbreak or slides of the surface rock at the portal (Wilbur, 1982)."

"The portal, the beginning of the tunnel, is often that portion where the engineer will encounter the most unpredictable rock conditions on the job (Craig and Brockman, 1971)."

"The end of a tunnel is often the beginning of an open cut; the location of the change of section is always a matter demanding careful consideration by the designing engineer (Legget, 1939)."

"It has occurred more than once that an incorrectly selected portal has broken down shortly after commencement of excavation and has had to be abandoned for another site (Szechy, 1966)."

Hence, the purpose of this research was to define types and locations of portal related failures and investigate the stability of portals in rock, specifically focusing on primary failure types, pertinent factors affecting stability, and design methodology.

1.2 Scope and Research Objectives

The research scope includes man-made, active and abandoned, and natural sites, which are situated in near-surface, discontinuity controlled rock masses subject only to gravitational stress fields. Both successful and unsuccessful portal excavations, with inclinations within 35 degrees of horizontal, are considered. Failures may be external or internal, and there are no age or surface geometry restrictions.

The research objectives of this investigation are as follows:

- a) Define the portal and its features.
- b) Investigate key factors that may affect portal stability.
- c) Compile a portal database with dimensional, rock mass, support, and excavation information, collected from a literature review and field investigations.
- d) Garner comments on portal design philosophy and construction practices from key industry personnel.
- e) Classify and illustrate the various types of portal failures and correlate with rock mass classes.
- f) Select the most appropriate design/analysis techniques and investigate their applicability to portals.
- g) Determine a systematic approach to portal design and analysis.
- h) Model the most common type of portal failure.
- i) Provide portal excavation and support guidelines.

2.0 BACKGROUND AND LITERATURE REVIEW

2.1 Portal Definition

For the purposes of this research, the following definition of a portal is utilized:

portal - [From the Latin porta, meaning gate]
The approach or entrance to a bridge or tunnel (Webster's, 1977). The approximately horizontal entrance (e.g. $\pm 35^\circ$ from horizontal) to an underground excavation, which typically consists of both an approach cut and a section of underground entry. The minimum length of the portal zone is considered to be approximately two spans, one span outby (e.g. outward) the portal interface, and one diameter inby (e.g. inward) the portal interface.

2.2 Nomenclature

To enable a detailed discussion of portals, their difficulties, and design, it is necessary to divide the portal area into definable regions (e.g. Crown Face, Upper Slope, Portal Interface, etc). Figures 2.1 to 2.5

illustrate and help identify these various regions as they are found in a portal driven perpendicularly into a 45 degree rock slope. The regions that constitute the portal zone are defined in Appendix 1. Conventional tunnelling and mining nomenclature have been utilized as much as possible in naming different portal regions. Various other types of portal geometries are also illustrated in Appendix 1.

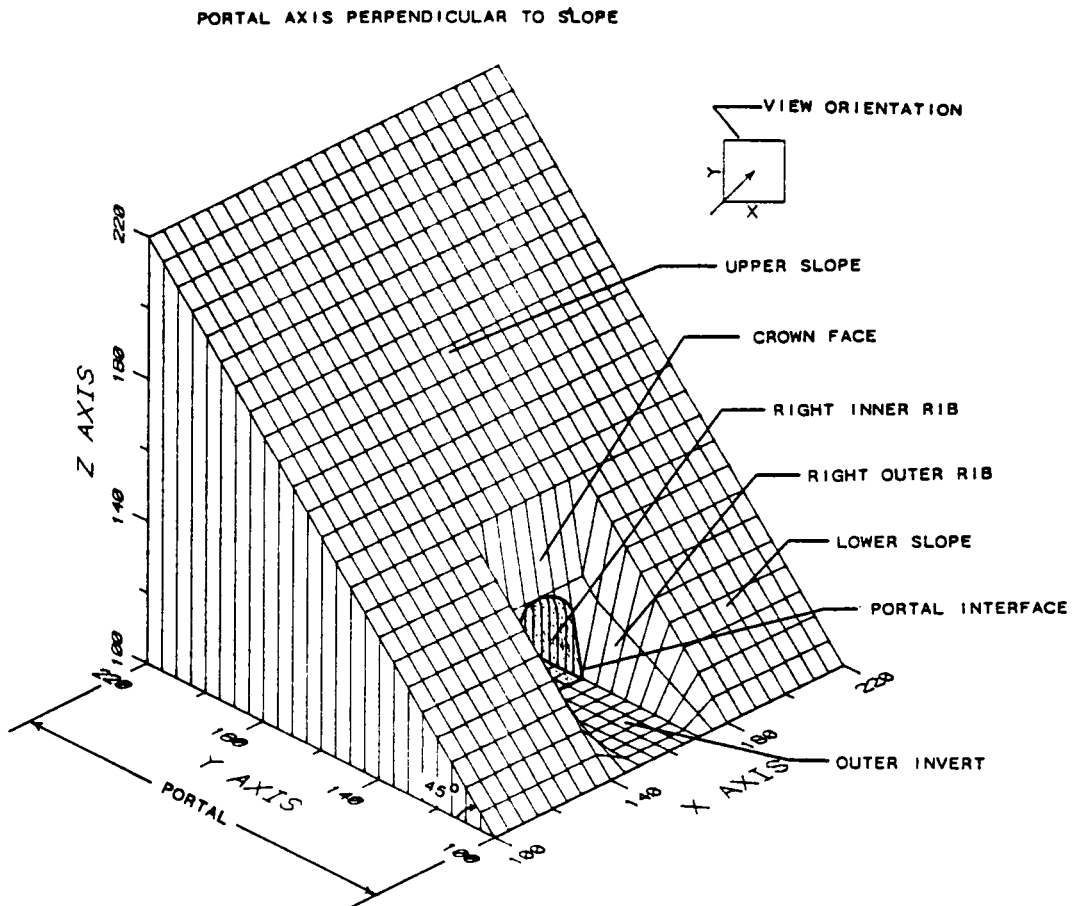

Figure 2-1. 3-D External View of a Portal in a 45° Slope (portal axis perpendicular to slope).

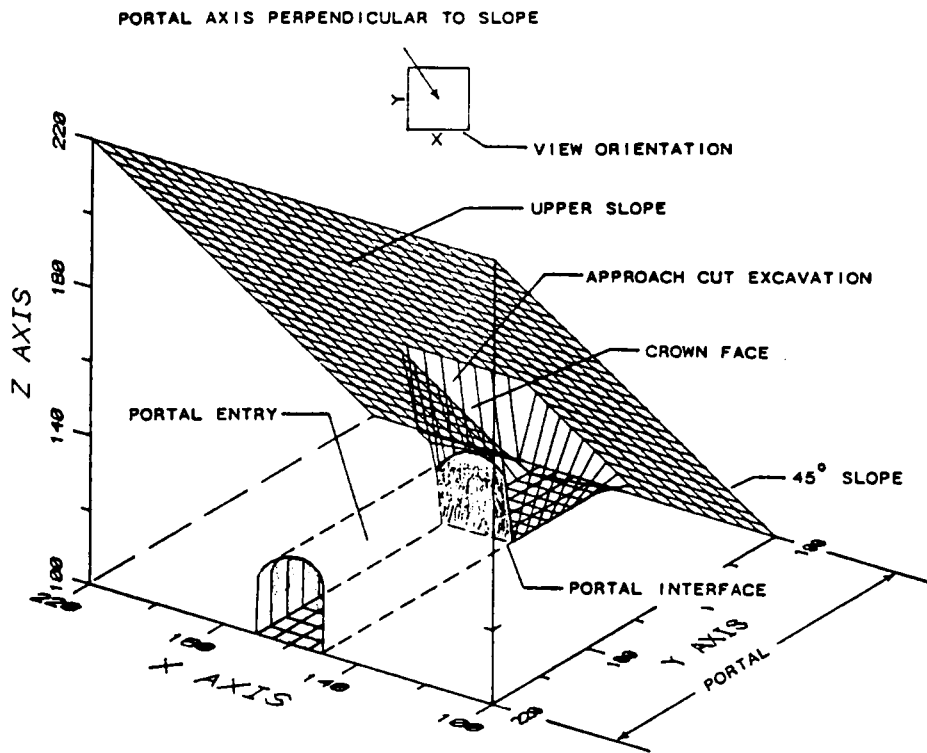

Figure 2-2. 3-D Internal View of a Portal in a 45° Slope (portal axis perpendicular to slope).

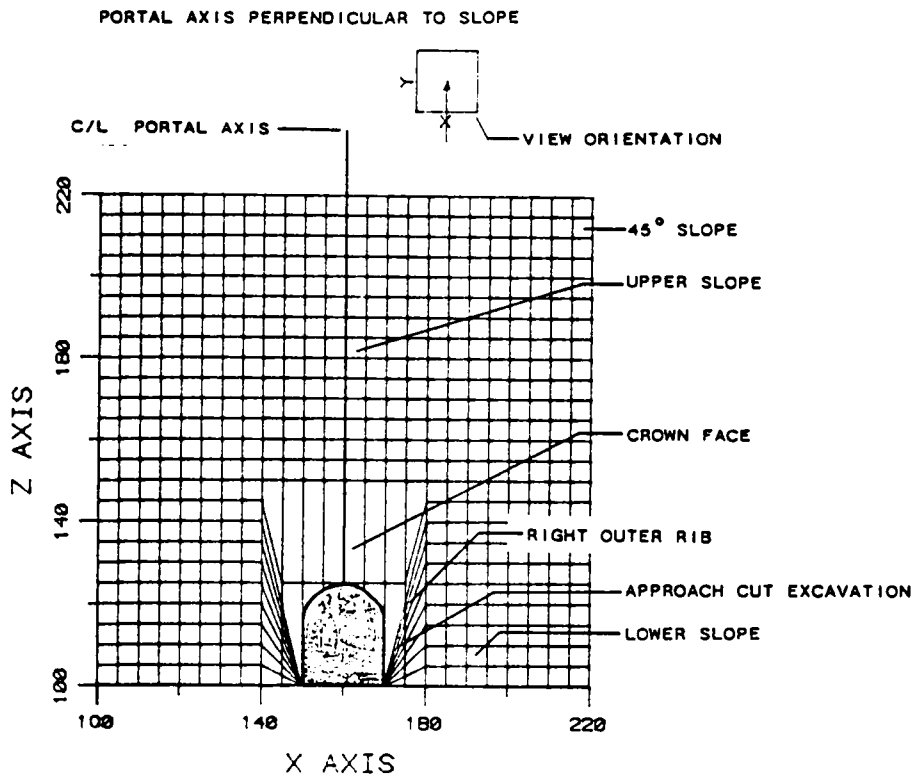

Figure 2-3. Front View (Perpendicular to Portal Centerline Axis) of a Portal in a 45° Slope (portal axis perpendicular to slope).

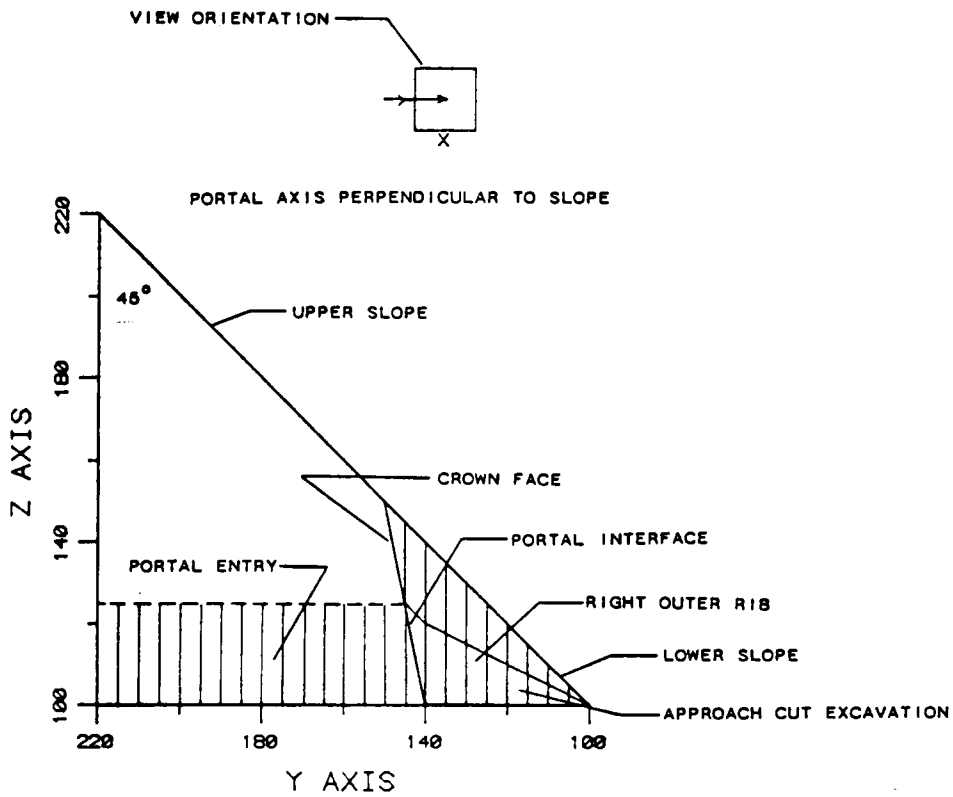

Figure 2-4. Cross Sectional (Portal Centerline Axis) View of a Portal in a 45° Slope (portal axis perpendicular to slope).

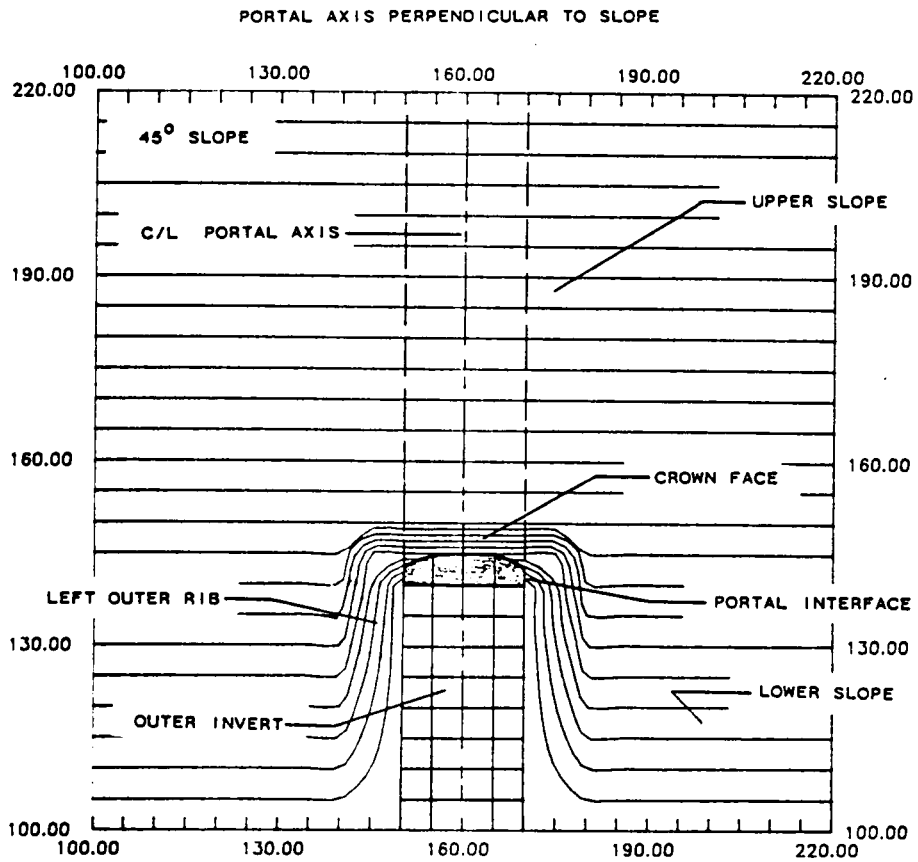

Figure 2-5. Plan View of a Portal in a 45° Slope (portal axis perpendicular to slope).

2.3 History

Researching the stability (e.g. dimensions, failures, support utilized) of historic underground excavations is frequently difficult due to a lack of detailed documentation and illustrations. However, in the case of portals, there is usually more definitive documentation, as it is easier to portray the entrance to an underground excavation (Stewart, 1962; Trench and Hillman, 1984; Willett, 1979). Illustrations of early works are actually of great benefit in terms of tracking the evolution of portal support techniques, locating long-since abandoned portals, and assessing long-term stability behavior. Furthermore, they clearly show that problems have long existed at portals. For example, the earliest known portal excavation illustration (presumably a German wood cut), shows what appears to be the initial tunnelling or 'turning under' at the portal of a mine in 1530 (Bobrick, 1981). Refer to Figure 2.6. The excavation, cut into a hillside, is approximately 7 feet high. The only supports visible are a vertical post and cap piece at the portal interface and there appears to be less than one diameter of cover. Other illustrations of this period are very similar in that they often show the portal area as being the only portion of the tunnel that is supported (Agricola, 1556).



Figure 2-6. Turning-Under a Mine Portal, Circa 1530 (Bobrick, 1981).

The earliest known engineering reference relating to the design of portals is as follows (Agricola, 1556):

Where torrents, rivers, or streams have by inundations washed away part of the slope of a mountain or a hill, and have disclosed a vena dilatata, a tunnel should be driven first straight and narrow, and then wider, for nearly all the vein should be hewn away.

Later, within the same text:

To prevent a mountain or hill, which in this way has been undermined, from subsiding by its weight, either some natural pillars and arches are left, on which the pressure rests as on a foundation, or timbering is done for support.

Thus, early engineers realized that in mining the tabular or sheeted deposits, the initial portion of the tunnel, the portal, could not be driven as wide as that possible further inby, in the workings. The second passage also shows the realization of an undermining type of failure and the necessity for artificial support in addition to only partial extraction practices. It is interesting to note the reference to both natural pillars and "arches". This referral to arches may well be in terms of the final roof profile between ribs, that is, stable roof conditions after minor sloughing failure in the crown face area. Additional references by Agricola, augmented by excellent period illustrations of portals, are also made

regarding the use of lagging and the necessity of backfilling the voids behind the timbering.

One of the most famous portals in literature is the "Portal dell'Inferno", or the gate of hell from the works of Dante with the noted words 'All Hope Abandon, Ye Who Enter In!', inscribed in the crown face over the portal's 'lofty arch' (Dante, c. 1300). The key words to note here are "lofty arch", which indicate a high, arched-shaped portal. Of course, portal arch construction techniques/styles, both in mining and architecture, had been perfected by earlier cultures.

Comparisons between the previously mentioned early portal illustrations from the 16th century and those of later 20th century coal mine portals (Cohen, 1984) and other period portals show almost identical portal structures/techniques. With the advent of the industrial revolution in the 19th century, masonry construction such as multi-layered brick and massive quarried stone techniques were utilized more for support than of appearance (Mayo, 1982, Trench and Hillman, 1984). This trend continued with the use of mass concrete structures in the late 19th and early 20th centuries. Only within the past 40 years have portals undergone a dramatic change, generally tending to be larger in section (e.g. greater than 30' spans) due to various project requirements. This change was made possible by rapid advancements in

excavation and support technology as well as an improved understanding of ground control. For example, the first recorded use of rock bolts for a civil engineering application was in 1950 at a portal in the 'Crown Face' region (Corps of Engineers, 1980). Additionally, although the use of gunite is well documented as early as the 1930's (Railway Age, 1937), shotcrete usage has been accepted by the mining and tunnelling industry as a key support method only in the past twenty years (Overlie and Rippentropp, 1987).

From an historical perspective on portals, (Agricola, 1556; Bobrick, 1981; Cherniack, 1986; Cohen, 1984; Dillon, 1976; Dillon, 1985; Sloane, 1970; Stewart, 1962; Trench and Hillman, 1984; Willett, 1979) several very important observations may be made:

- a) Portals have been troublesome and failure-prone areas since man first started to tunnel.
- b) Innovative and heavier than average support features were commonly used.
- c) Overburden depth (e.g. turn-under cover) tended to be as shallow as possible to limit the amount of approach cut excavation.

- d) Portals were designed to the smallest possible dimensions to avoid unnecessarily heavy loading conditions.
- e) Without portal structures or facades, failure can quickly obscure and hide a portals' existence.

2.4 Types of Portals

Portals may be classified as either natural, man-made/unplanned, or man-made/planned. The first two classes of portals constitute geological engineering problems when encountered on a project site, the solutions of which are basically approached in the same manner as a stability assessment of the third and final portal class, man-made/planned (e.g. active or yet-to-be-built portals), which is the primary focus of this research. The investigation of both natural and man-made/unplanned portals has provided invaluable insight into the long-term behavior of man-made/planned portals. These unplanned types of portals are described along with some of their potential problems/hazards.

2.4.1 Natural.

Portals classified as "natural" consist of subsurface

voids found in nature, such as caves, vugs, and lava tubes. These portals may be encountered as they were naturally formed at the surface, or produced via near-surface excavation. For example, open pit quarry operations in limestone and dolomite formations, such as those at the James River Limestone Quarries, Buchanan, Virginia, quite often uncover karstic openings, which appear as natural portals in their highwalls (Olmedo, 1987). Several natural portal case histories are included in the database as examples of large, un-supported spans, in medium to high-quality rock masses (Hempel, 1975).

2.4.2 Man-Made/Unplanned.

Portals in this class normally consist of abandoned portals that exist as they were originally developed on the surface, or as abandoned subsurface excavations that are intersected during the course of normal project operations. For example, today's large surface mines which are able with current technology to profitably remove substantial amounts of overburden, such as the Austinville Limestone Quarry, Austinville, Virginia, can and often encounter abandoned subsurface workings (Olmedo, 1987). These old subsurface workings will, like the abovementioned natural karstic cavities, form unplanned portals in the pit walls and benches. The investigation of many of these portals and their inclusion in the database has aided in the

formulation of long-term stability trends and support requirements.

2.4.3 Hazards of Unplanned Portals.

Unplanned portals, both natural and man-made, may constitute significant engineering problems/hazards in the following six aspects: 1) location and detection; 2) future collapse and/or settlement; 3) dangerous impoundment or transfer of water; 4) pollution and/or erosion from drainage; 5) legal constraints on abandoned mines; and 6) legal problems of an 'attractive nuisance' (Clarke, 1986; U.S. Dept. Interior/OSM, 1983; Jacobs, 1975).

One of the most difficult aspects of an unplanned portal lies in its precise location. Unless a surface subsidence feature is evident or a portion of the old surface infrastructure remains, portals often readily blend into the local landscape and disappear. This error is carried into current maps and aerial photographs (Lewis, 1977). Thus, when a project is in the initial planning stages, old maps and publications should be checked for any indication of past excavations, and the local populace should also be questioned as to the history of the area, and other indicators of underground cavities should be investigated, especially if there is reason to suspect subsurface workings.

The cost of accurately locating all such voids via

exploratory drilling or other subsurface void detection methods is prohibitively high and normally beyond the budgetary constraints of all but specialized civil endeavors (e.g. dams, metro systems, underground hydro stations, etc.). Furthermore, the success rate for complete void detection from these methods is relatively low (Belesky and Hardy, 1986; Butler, 1983; Cooper, 1983; Curro, 1983; U.S. Army Corps, 1977).

A common method of detecting abandoned portals, is from their drainage (e.g. reddish iron and manganese deposits are common in Appalachian coal mining districts). Federal agencies that are responsible for the reclamation of abandoned portals not only rely heavily on drainage for portal location, but also include this as a factor for their priority rating. In addition to the pollution potential, erosion from the springs that issue from abandoned portal mouths may constitute a hazard. Environmental regulations and/or abandoned mine status may control and severely restrict construction activities at such sites. The more severe the drainage, the higher priority the rating for mitigation (Seijo, 1988).

One of the greatest threats presented by an undetected portal is the likelihood of excessive settlement and/or complete collapse, which can affect adjacent structures. Natural and abandoned portals are very unpredictable and an accurate stability assessment is extremely difficult. The

common approach is to either avoid them entirely or completely backfill with a drained, reinforced material (Skelly and Loy, 1973; Pettman, 1984).

Another hazard that may occur as a result of portal collapse, is that of a sudden release of a water impoundment, locally known as a 'blow out'. An example of this occurred in 1968, at the edge of the campus of West Virginia Tech, Montgomery, West Virginia (Rogers, 1980). Typically, one or two seal ruptures occur a year in southern West Virginia; however, to date they have not resulted in any loss of life (Seijo, 1988).

Additionally, there is the threat of dangerous transfer of water from impoundments. Should a portal go undetected in the planning and development of a reservoir site, there is the possibility of a dangerous transfer of water when the pool is filled.

Another tragic problem often encountered when dealing with abandoned or open portals of any type, is that of an attractive nuisance. Many fatal accidents from unlawful entry have occurred. Unfortunately, even gating and/or sealing is not always enough to prevent unauthorized access.

2.5 Portal Uses

The various uses of portals, both active and abandoned, in the areas of access, ventilation, drainage, lighting, exploration, and support show the overall importance of the portal to an underground excavation, and in turn, the necessity of a safe design utilizing appropriate ground control measures.

The primary use of the portal is to provide access to an underground excavation, mine, or tunnel. The time period that the portal is required to provide access will vary. For a small scale contract type of mine, commonly seen today in the eastern coal fields, the design life may be less than a year; however, for larger underground mines in the United States, portals are required to give stable access for the life of the mine, 20 to 30 years. For some coal mining projects in the United Kingdom, life spans may be 80 years or more (Whittaker, et al., 1984). The design life for civil works projects (e.g. highway and water tunnels, powerhouses) may be measured in terms of 50 to 100+ years. Hence, the end use, in terms of project type, will govern the level of design (e.g. level of conservatism) and support a portal will receive.

For mining and civil works alike, ventilation facilities quite often form an integral and very complex part of a portal structure. These expensive and often

massive facilities commonly dictate the final portal location, design, and support requirements.

Another use for portals is that of a pump station. The two basic locations for pump stations in an underground excavation are at the low point of the excavation and at the portal. The low point or sump pump station will collect water via gravity flow and pump to the portal station where the water may be discharged into settling ponds, sewers, or open bodies of water, depending of course on local environmental regulations (Bendelius, 1982). In the same vein, collecting galleries and dams have been built at portals forming underground reservoirs to collect water for domestic and industrial use.

Since portals are located at the surface, they are subjected to the existing site surface/weather conditions. Hence, storm and flood gates, avalanche canopies/sheds, and ice protection facilities may be installed (Bendelius, 1982).

Another common use for the portal is lighting adjustment. The concept of gradual adjustment of lighting is most important in dealing with portals because a certain amount of time is necessary for the retina component of the eye to adjust to the interior level of lighting of a tunnel. One of the first examples of aiding the illumination of a tunnel via portal enlargement was by the Romans in the excavation of the Ponlipio Hills tunnel

(Legget, 1939). Currently, it is common practice to combine the function of a light screen with that of a protective canopy of (Marszalowicz, 1982).

Unplanned portals, such as caves or abandoned mines/tunnels, though typically considered an extreme detriment when encountered on a project site, may be of great value. If safely accessible, the use of an abandoned portal for exploration can provide much more valuable information than common drilling and geophysical methods, especially in terms of stability analyses (Rogers, et al, 1987). Furthermore, the addition of temporary support and ventilation measures to allow access may prove cost effective when weighed against other exploration techniques.

Another valuable use for unplanned portals is that of drainage. Drainage measures can be added internally via drilling, or the portal can be converted into one large drain by merely adding the appropriate drainage pipe and filter material. Even if the portal is unsafe to enter, it may be possible to insert prepared continuous lengths of drain pipe or wick into the portal thus guaranteeing some drainage even if further portal collapse should follow.

Unplanned portals may also be used for additional support via internal bolting systems or complete reinforced backfill. Either method converts a potentially dangerous cavity into a single large reinforcing element (e.g such as

a large dowel within the slope), that increases the shear resistance of the discontinuity/joint sets in the immediate vicinity.

2.6 Portal Design Factors

Items and factors that affect, directly or indirectly, portal design include the state of stress, instrumentation, seismic risk, damage alleviating measures, remedial measures, extent of subsidence prediction models, portal seals, costs, contract specifications, and regulatory legislation.

2.6.1 State of Stress.

When an excavation is made, the existing or in situ state of stress is changed and the stresses are redistributed or induced in the area around the excavation (Haimson, 1984; Hoek, 1981). Hence, one of the initial steps in the design of underground excavations is the determination, measured or estimated, of the pre-excavation or in situ state of stress (Brady and Brown, 1985; Hoek and Brown, 1980; Szechy, 1973).

Between the near-surface gravity loading zone and depths up to 1640 feet (500 m), the horizontal stress has been found to exceed the vertical stress (Hoek and Brown,

1980), although this is very site specific and primarily below drainage. However, little is known about the stress conditions of the near-surface boundary, where portals are located. In general, portals are assumed to be subjected to gravity only (e.g. vertical) loading conditions due to both the discontinuous rock mass character and results from numerical modelling. For example, in modelling near-vertical, gravity loaded rock slopes, research has shown that stress trajectories tend to parallel the face of a homogenous, isotropic, linearly elastic medium (Bhattacharyya, 1973). However, recent investigations have shown that it is possible for gravity-induced horizontal stresses to exceed the vertical component (Amadei, et al, 1987).

Unfortunately there is great scatter in the near-surface stress measurements and the measured values are often close to the accuracy limits of most stress measuring tools (Hoek and Brown, 1980). Thus, only in extreme cases, such as those encountered in high relief, valley side conditions (Selmer-Olsen, et al, 1982; Myrvang, et al, 1984), or in certain geological environments (e.g. heavy portal loading in an anticline), may near-surface stress conditions be assumed to vary significantly from generally accepted gravity loading conditions and have a notable effect on portal design.

2.6.2 Voussoir Arch and Plate Theory.

Researchers have been investigating the behavior of immediate roofs that are comprised of multiple beams/plates for over 100 years (Brady & Brown, 1985). These early studies found that the lateral load from the uppermost beams was not transferred vertically to the lower beams. Instead, this load was transferred to the ribs of the excavation. This lateral load transfer and associated mobilization of friction between the upper beam surfaces was termed arching (Fayol, 1885). Later investigators established the correlation between immediate roof behavior (e.g. arching) and the voussoir arch in masonry structures (Evans, 1941). Hence, the concept of a voussoir beam in the rock units comprising the immediate roof of a subsurface excavation was introduced. Realistically, one of the common types of portal interface overbreak failure (e.g. 'Crown Face Overbreak' failure as described in Section 4) may be described as a three-dimensional voussoir type of failure. Hence, several important insights toward the failure mechanisms that regulate this failure may be gleaned from recent investigations (Beer and Meek, 1982; Seedsman, 1987; Sterling, 1980). The most important is that the strata that comprise the roof cannot be modelled by continuous, elastic beams or plates. This is due to the behavior of the individual rock blocks (e.g. the voussoirs) formed by the cross joints or induced fractures (e.g.

stress relief phenomena).

Hence, simple voussoir arch theory provides some insight into the failure mechanisms involved: however, the current two-dimensional models with vertical jointing do not accurately portray the three-dimensional failures and complex structure as typically encountered at the portal interface.

Another similar concept considered for the analysis of overbreak failure at the portal interface is that of elastic plate or beam theory which assumes that the rock mass in the crown of the excavation is comprised of a series of plates or beams ((Beer and Meek, 1982; Daemen and Jeffrey, 1983, Sepher and Stimpson, 1988; Sharp, et al, 1984; Singh, et al, 1980). These beams or plates are gravity loaded by their own weight, and thus the crown span is designed so that the allowable stress is not exceeded.

Several portals driven in horizontally bedded strata were observed to have stepped failures (e.g. the steps known as corbels in architecture terminology) in the crown at the interface as illustrated in Figure 2-7. The depth of this multi-plate failure tended to extend approximately one-half the portal span in by the interface, and corresponds to the triangular, end-fracture pattern or yield lines of a rectangular roof plate (Beer and Meek, 1982). Each plate follows the same trend, with the upper plates being inset due to support provided via the lower

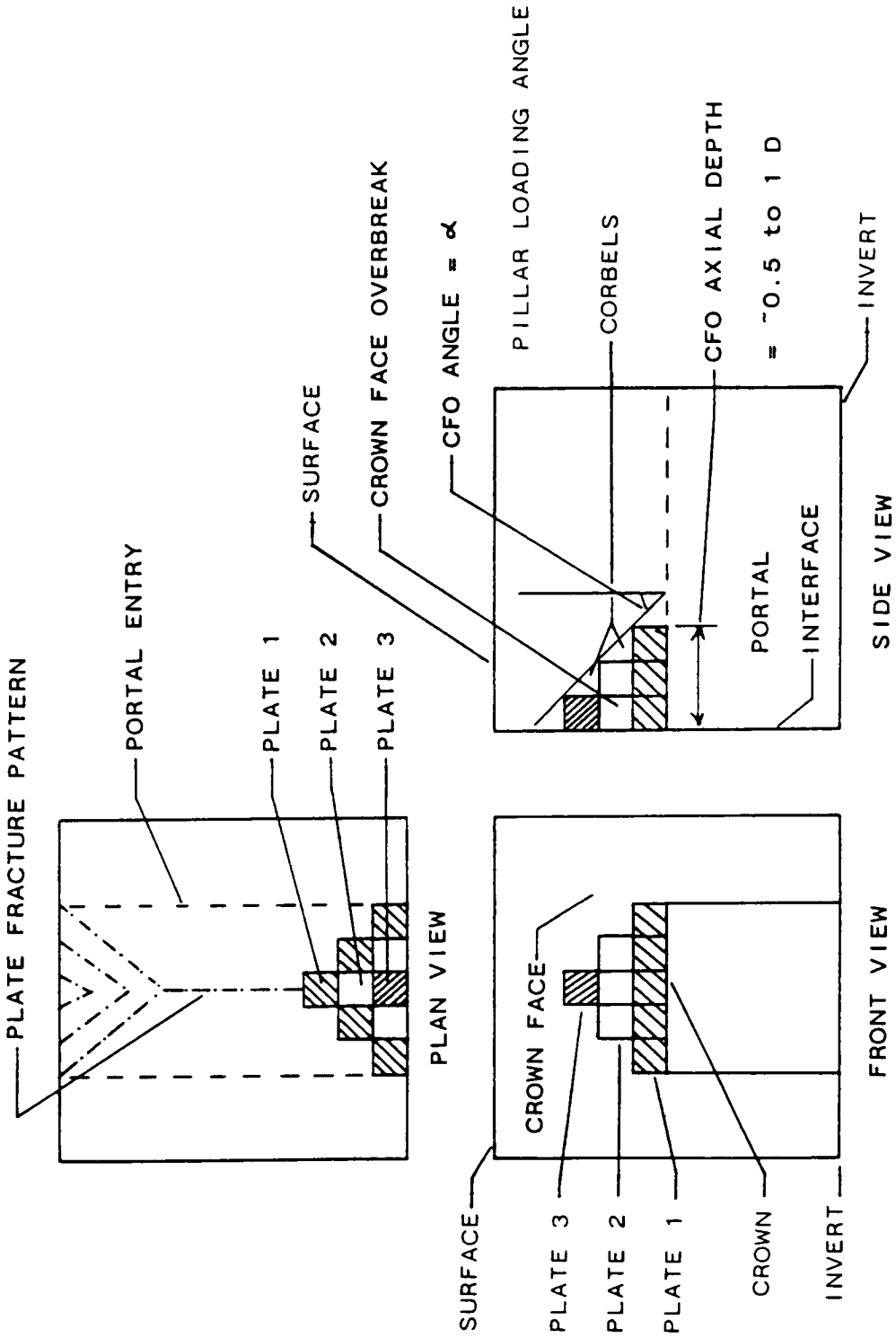

Figure 2-7. Similarity of Plate Fracture Theory to 'Crown Face Overbreak' Failure at Portals.

corbels. Thus, plate fracture theory helps to affirm field observations as to the extent of this type of failure in by the interface; however, like the voussoir arch model, it is still too simple to be utilized for three-dimensional, discontinuous rock mass modelling purposes.

2.6.3 Instrumentation.

When a portal cut is excavated and/or a portal is driven, the surrounding rock mass undergoes a redistribution of stress. This redistribution is associated with a change in shape or deformation of the rock mass. Deformations, when excessive in portal areas, may lead to increased support costs and hazardous working conditions. Thus, it is sometimes necessary to install instrumentation at a portal for one or more of the following three reasons (Bieniawski, 1984; Bienawski and Maschek, 1975; Davies, 1976; Kidd, 1976; Jones, 1985; Muller, 1978; Tyrrell, 1976; U.S. Army Corps, 1983, 1987; Wilson and Mikkelsen, 1978, Wong and Kaiser, 1985; Ziegler, 1972):

- a) To measure basic rock mass properties and characteristics such as strength, modulus of deformation, anisotropy, and water table regime for design purposes.
- b) To detect and measure the changes in a geologic mass

due to the excavation of the portal. Rates of displacement from such instrument stations are utilized for support verification (e.g. NATM and other observational design methods) and failure prediction for the initial or remedial measures.

c) To detect and measure changes in the portal structure or adjacent structures such as utilities and buildings due to the portal excavation.

The most common types of instrumentation at portals, utilized for the abovementioned purposes, are surface monuments, convergence monitoring points, extensometers, and piezometers. The settlement as measured at portals tends to be large for most portal excavations, as compared to measurements further in by the interface, and are often only exceeded by settlements in extremely difficult subsurface conditions (e.g crossing a syncline) (Steinheuser, et al., 1983)."

Obviously, each portal will have different requirements as to instrumentation (the majority of portals are not instrumented); however, if measurements are to be made, budget limitations will govern the type, duration, and number to be performed. Once the instrumentation budget has been established, considerations as to limited site accessibility, instrument sensitivity, durability, and

number, along with data purpose/responsibility should be made.

2.6.4 Seismic Risk.

Research on the seismic stability and behavior of shallow tunnels has shown that these structures are less susceptible to damage than surface facilities (Jacobs, 1975), and that most damage occurs near the portal (Pratt, et al, 1979). Specifically, it was found that no damage occurs in tunnels with a peak estimated surface ground acceleration of less than 0.19g. Minor damage, which includes damage due to shaking, rock falls, and minor cracking of linings but does not include partial collapse, was observed between the value of 0.19g and 0.5g. Major damage, which includes large rock falls, severe cracking, and collapse, was found to occur at values above 0.5g (Owen, et al, 1979).

Though historical data on earthquake damage is unavailable for areas such as the eastern United States, damage to mine portals (e.g. collapse) from seismic shock due to explosion has been documented (Dillon, 1976; Stafford, 1978; Milan, 1981). Furthermore, there is added concern for the eastern U.S. since seismic hazard design has been relatively lax or more typically, non-existent even though extremely large earthquakes have been historically documented (Gleick, 1988). Hence, this

region is largely unprepared for such an event, even though the probability of such an event occurring before the year 2000 is between 75 to 95 percent, and before the year 2010 nearly 100 percent (Associated Press, 1988; Smith, 1987).

Hence, with the aid of surface seismic risk maps for the United States, which are based on historic seismicity (e.g. intensity 5 or greater) and the corresponding surface damage (Pratt, et al, 1979), seismic loading concerns should be included in portal design. Without more definitive information, portal zones and the associated surface structures should be designed for a minimum 0.2g peak acceleration. For more conservative designs accelerations as high as 0.5g may be considered (Long and McClure, 1965). Specifically, tunnels and portals are best designed against seismic motion and the associated dynamic rock mass displacements through improved construction practices to ensure better rock-support interaction (Abramson, et al, 1986; Howells, 1972; O'Conner, et al, 1986; Owen, et al, 1979; Pratt, et al, 1979).

2.6.5 Damage Alleviating Measures.

Current trends in portal design utilize damage alleviating measures which typically consist of various types of machine excavation along with careful and/or enhanced methods of blasting. These methods have been proven to improve the rock mass stability (Hoek and Brown,

1980; Tedd, et al., 1983). Rock sawing, which falls within the category of machine excavation, has been utilized to make the initial cut around the portal perimeter in relatively soft rock masses, thereby providing a free face for blasting and reducing the amount of damage to the surrounding rock mass (U.S. Army Corps, 1980). A method of blast enhancement that has been utilized to reduce damage and overbreak, especially when turning-under at the interface, is that of close line drilling on two to three inch centers around the tunnel perimeter (Legget, 1939).

2.6.5 Remedial Measures.

Remedial measures are sometimes necessary for portals in order to mitigate deteriorating stability conditions. The four most common remedial measures utilized at portals are; 1) drainage, 2) geometry revision, 3) freezing, and 4) grouting.

Probably the most important, and most often neglected aspect of portal design, is that of proper and well-maintained drainage provisions, which prevent excessive water pressures that lead to instability (Bendelius, 1982; Brawner, 1986; Buttner, 1987; CANMET, 1977; Hoek and Bray, 1981). Many of the portals visited during the course of the investigation initially had adequate drainage facilities; however, due to a lack of maintenance, these facilities fell into disrepair and were not able to perform

their intended function. In several instances, insufficient drainage measures exacerbated portal failure. To solve this problem, existing surface and subsurface drainage facilities should be routinely renovated.

The second most common remedial measure is that of geometry revision. In particular, it is quite common to either extend the portal approach cut further into the rock mass to overcome weathered or other disadvantageous conditions, or to flatten the approach cut slopes and to include a crown bench within the design (Kuessel, 1988).

Ground freezing is sometimes used as a remedial measure, though typically only in highly fractured or weathered rock masses for larger span portals. It has been most widely used to prevent excessive inflow when advancing through water-bearing strata, especially in the development of inclined slope portals (Aerni and Mettier, 1981; Jones, 1982).

Grouting is utilized instead of freezing for enhancing the stability and/or preventing excessive water inflow in more discontinuous rock masses. In highly weathered rock masses, grouting has also been successfully utilized to prevent surface settlement (U.S. Army Corps, 1973, 1984).

2.6.7 Extent of Subsidence/Collapse.

A problem often encountered when dealing with abandoned portals is that of predicting the length of potential

surface expression (e.g. subsidence trench or collapse zone) from a subsidence/collapse failure. There are of course many possible complex subsidence prediction methods for approaching this problem (Bieniawski, 1986; Peng, 1986); however, since portal collapses are characterized by chimney collapse features (Karfarkis, 1986), a very simple method based on bulking theory may be utilized (Dunrud, 1984; Terex, 1970). This theory is based on the expansion of an rock mass when transferred from the in situ state (e.g. bank) to a loose state. Hence, the projected height of caving/bulking may be predicted. The intersection of this height and the ground surface gives the axial (centerline) extent of the subsidence/collapse trough.

2.6.8 Seals.

Once the usefulness of a portal is complete, various abandonment designs and plans are typically implemented. These abandonment designs are intended to alleviate problems relating to collapse, drainage, and unauthorized access. Today, most subsurface excavations are covered by regulations that mandate abandonment provisions; however, there are many thousands of portals across the country that are not covered by legislation and therefore remain as very serious hazards. In partial response to this problem, abandoned portals (e.g. coal and non-coal mining related excavations only) that were deserted without abandonment

provisions are currently being sealed and reclaimed as part of the Surface Mining Control and Reclamation Act of 1977 (Public law 95-97). In the Eastern United States alone, there are an estimated 31,372 abandoned mine portals. With reclamation costs varying from \$27,000 to \$32,000 per project, a nationwide portal mitigation cost of approximately 1.1 billion dollars has been projected (e.g. approximately 10% of the total Abandoned Mine Lands project cost of \$12 billion) (U.S. Dept. of the Interior, 1983).

Hence, abandoned portals comprise an extremely large group of excavations requiring intervention at an enormous cost, necessitating a brief discussion as to abandonment methods as an aid to stability assessment. Currently, portals are abandoned or closed via four general methods: a) backfilling (e.g. wet seal or dry soil/pneumatic stow), b) constructed seals, c) blasting, and d) barricading.

The most valid method to ensure stability of a portal is that of backfilling to form a solid portal seal utilizing available fill materials. These materials may be placed by mechanical, hand labor, hydraulic pumping, and/or pneumatic stowing. Such a seal can prevent collapse, minimize subsidence effects, restrict unauthorized entry, and allow or not allow for drainage from the underground excavation. Figure 2-8 illustrates a seal designed for wet conditions (Seijo, 1988; WV Dept. of Energy, 1987).

The majority of constructed portal seals are designed

from a drainage and/or ventilation standpoint rather than the overall stability of the immediate area. For active mines, portal seals are constructed in such a manner as to prevent air leakage and allow for drainage. For abandoned works, seals are usually designed to allow limited access, and free drainage, depending on the quality of the water. Special designs are required when abandoned excavations are utilized as reservoirs for domestic water supplies, with masonry or concrete seals installed at or slightly inby the portal interface.

Blasting a portal seal involves collapsing the strata surrounding the portal interface. The depth and extent of blasting depends upon site geometry, and is considered a rapid and inexpensive method to deny access. Long-term stability and drainage assessments are difficult to assess with this method; hence, it is not often utilized.

Barricades are normally installed at or around the portal interface to impede access and typically consist of grates or fences. Past experience in cave and mine gating has proven that it is extremely difficult to design and construct a structure that will completely deny unauthorized access. In addition, environmental concerns over endangered species may govern the decision to allow partial access via barricading.

Thus in terms of portal design, seals should be able to mitigate subsidence and impoundment problems; however, due

Figure 2-8. Example Design for a Mechanically Placed Portal Seal for Wet Conditions at Cabin Creek, West Virginia (WV Department of Energy, 1987).

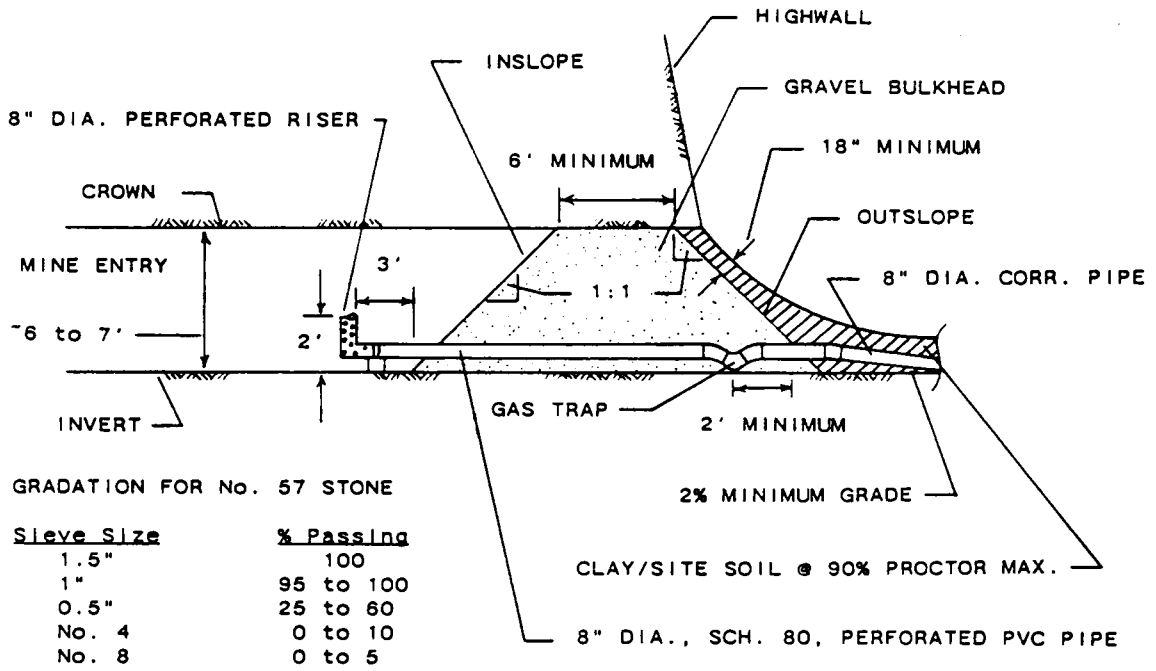

to current construction practices and short-sighted designs, long-term problems are expected. Further research in the area of portal seal design is warranted, especially in terms of long-term water impoundment capabilities. Recent advances with geotextiles in the field of soil mechanics (e.g. reinforced earth structures, wick drains, drainage strips, etc.) could readily be utilized for improved portal seal designs.

2.6.9 Cost.

Portal costs are normally not considered significant (Industry References, Appendix 2, Buntain, 1981); however, delays and problems in the portal area can be extremely critical in terms of project scheduling and the contractual budget. Also, portal costs decrease as the angle of drive below horizontal increases (Buntain, 1981).

2.6.10 Subsurface Contract Specifications.

The majority of underground construction projects in the United States use a competitively bid, firm, fixed-price contract (Cording, et al, 1971). This type of contract, unfortunately, causes a number of problems for portal construction in terms of inflexibility, changed conditions, and unknown conditions.

Due to the inflexible nature of this type of contract plus reliance on the contractor for the portal support and

excavation design, the use of improved and/or specialized technology which is highly advantageous at portals, is often discouraged, resulting in unnecessarily costly construction and long-term rock mass damage.

Changed conditions are common and result in an unnecessarily large number of claims, disputes, and litigation. For example, the most common change order in the tunnel business, and often the first exercised on a project, is that of portal approach cut slope angle modification (Kuesel, 1988).

Due to typically unknown subsurface conditions, the contractor covers a portion of his risk acceptance with a "cushion", thus further increasing the cost of underground excavation. Disadvantageous and difficult conditions at the portal exacerbate this problem.

Hence, improvements in the abovementioned contractual areas will help minimize underground construction costs, increase the use of new technology, reduce claims and litigation, and hopefully provide a more cooperative working atmosphere between the owner/client and subsurface contractor.

2.6.11 Regulatory Legislation.

Regulatory legislation will often dictate several aspects of portal support design and influence the construction sequence (California Mine Safety Orders, 1973;

California Tunnel Safety Orders, 1973; Kozak, 1978). Generally, portal legislation pertains to either ventilation and fire prevention or ground control. Ventilation and fire prevention legislation typically requires offset fan houses, construction-free zones near portals, the use of fire resistant materials for adjacent structures and fire-doors, and explosive/combustible material storage regulations. As to ground control, portals are commonly regulated by a combination of various subsurface and open pit ground control regulations. Refer to Table 2-1. Depending on the location and use of the portal, these regulations may or may not be applicable and enforcement varies with each regulatory agency. More stringent regulations are encountered when dealing with the subsurface portion of the portal zone (e.g. portal entry) than the surface portion (e.g. approach cut). State regulations may even specify minimum web thickness between adjacent portals (Decker, 1988). Furthermore, subsurface regulations are additionally restrictive when working in a potentially explosive atmosphere.

Therefore, given the ambiguous nature of the portal as to its location and support requirements, the addition of the clarifying definition of the "portal" as "a zone comprised of subsurface and surface regions" to enacted legislation, would be extremely beneficial in terms of regulatory body enforcement and contractual specifications.

For current planning purposes, however, a conservative approach utilizing the most stringent regulations, whether surface/open pit or subsurface, is recommended.

Table 2-1. Ground Control Regulations Affecting Portal Design (California Mine Safety Orders, 1973; Kozak, 1978).

Article 13. Ground Control.

8441 (a) Every working place underground shall be kept securely supported with timber, steel sets, or otherwise protected by installing wire mesh, rock bolts, gunite, shotcrete, or a combination of methods when necessary for the safety of workers.

8441 (b) All sets, ... , shall be of adequate design and installed so that bottoms will have sufficient anchorage to prevent pressures from pushing them inward into the tunnel. Adequate lateral bracing shall be provided between sets to stabilize the support.

8441 (e) Adequate protection shall be provided for workmen exposed to the hazard of falling ground while installing tunnel support systems.

8441 (f) Tunnel portal excavations shall be adequately protected by sloping, benching, installing wire mesh and/or rock bolts, or equivalent methods.

.....

Article 12. Ground Control - Surface.

6984 (3-1). Face of Bank of Pit. (a) All reasonable precautions shall be taken to free the face or bank of the pit from loose materials that may be dangerous to employees. (b) Where practicable, the face of the pit shall be given a slope as to minimize the danger of rock falling on employees. (c) (3-3) Whenever the division considers that the height and condition of the face constitutes a serious hazard to employees, it may require the installation of a bench or other suitable method of working.

6986 (3-2). Overburden. (a) No person shall be permitted under a face or bank where stripping operations constitute a hazard. (b) Where employees are endangered by materials rolling or sliding down the slopes above a pit, such employees shall be removed from the danger area or shall be protected by barriers, baffle boards, screens or other devices that afford equivalent protection.

Table 2-1. (Continued).

6987. Floors of Pits and Quarries. (a) Sufficient mapping or exploratory drilling shall be performed to locate dangerous underground excavations.

6988 (3-8). Face Inspection and Control. (a) A daily inspection shall be made of faces and banks where men are exposed to falling or rolling materials. The inspection shall be made by a competent person who shall dislodge or make safe any material dangerous to employees, or shall cause such material to be dislodged or made safe. (b) (3-9) No person shall be permitted to work near a face made unsafe by primary blasting, rains, freezing or thawing weather, or earthquakes, until the face has been inspected and made safe. (c) At least once a week, or oftener if necessary, a competent person shall inspect the top of the face or bank for cracks that may indicate the imminence of slides or movement of the face.

6989 (3-4). Protection of Workers at the Face. (a) No work shall be permitted above or below men at the face if such work endangers their safety.

.....

Article 12. Ground Control - Underground.

6990 (3-20). Timbering - General. (a) Every working place in the mine shall when necessary be kept securely timbered or otherwise supported to prevent injury to employees from falling material.

Article 46. Dangerous Excavations at Underground Mines.

7178. Dangerous Excavations. (a) (20-20) Access to unattended mine openings shall be restricted by gates or doors, or the openings shall be fenced and posted. (b) (20-21) Every dangerous surface excavation in which work has been discontinued, including any tunnel, mine shaft, pit, well, septic tank, cesspool, or other abandoned excavation, shall be securely covered over, fenced, or otherwise effectively guarded and appropriate danger notices shall be posted.

3.0 PORTAL CASE HISTORY DATABASE

Previous research in ground control problems in the areas of multi-seam mining interaction and subsidence have demonstrated the value of empirical approaches via establishment of case history databases (Karmis and Agioutantis, 1985; Zhou, et al, 1987; Zhou, 1988). Thus, to form a logical basis for portal failure identification and classification, overall trend analysis and excavation/support guidelines, a portal case history database was constructed. This database covers a wide variety of both man-made and natural portals and provides a means by which the mining and tunnelling industry, government agencies, and universities can easily and readily access information on portals. The database information was compiled from field investigations, literature, and industry comments, and is considered the minimum necessary for assessment of the relative stability of the portal zone, whether of planned, active, or abandoned status.

The database has been organized into a dual reference system. For rapid reference, an abbreviated table containing entries for all 500 case histories was established and is listed in Appendix 4. For a more detailed view and/or clarification, a one to three page

synopsis has been established for each portal, along with an overall listing of the portals and references (Rogers, 1989). This database is available upon request from the Department of Mining and Minerals Engineering, Virginia Polytechnic Institute and State University, Blacksburg, Virginia.

3.1 Literature Sources

Information and data concerning portals in the available literature is sparse. Few articles and/or reports deal with the subject of portals in sufficient detail to be included within the database, unless some form of difficulty was encountered during construction or the portals' life (Martin, 1987). Unfortunately, in the absence of any problems, specific portal design, support, and construction information was not normally provided, although useful information was often extracted from portal photographs, both current and dated, in terms of difficulty and design (Craig and Brockman, 1971). Tunnel design literature frequently has brief references noting that portals are dangerous and problem prone areas and that particular precautions should be taken (Legget, 1939; Szechy, 1973; Wilbur, 1982); however, these recommended precautions are typically not mentioned.

To avoid unnecessarily weighting portal failures in the database and to ensure collection of sufficient data for trend analysis, case history information on successful portals was included, when design and support information were provided or could be inferred. Articles, specifically pertaining to portals, were also separately referenced in Appendix 1.

3.2 Field Studies

Of the 500 portals comprising the database, 145 (e.g. 29%) were visited. Initial field investigations involved detailed geological mapping, field index tests, specimen collection, and laboratory testing. Information from these studies was utilized later for stereographic and two-dimensional limit equilibrium analyses, and rock mass classifications (Refer to Section 5). These early studies assisted in the formation of the categories within the portal database, as well as in the development of the portal failure classification system.

3.2.1 Geological Mapping.

Portals, even in rather complicated rock mass structure, can be well mapped geologically and structurally due to the three-dimensional exposure of excavated rock

faces in the approach cut. Planned portals are best investigated through outcrop mapping in conjunction with vertical, horizontal, and inclined bore holes. Mapping can frequently be facilitated by use of existing software packages that includes data gathering, reduction, and analysis. The software package utilized in this research was "Rockpack" (Watts and Frizzell, 1987). This package allowed all external stability requirements to be analyzed via stereographic and two-dimensional limit equilibrium analyses. Refer to Section 5.

3.2.2 Schmidt Hammer Test.

A simple method of estimating the uniaxial compressive strength of rock is with the Schmidt hammer (Hoek and Bray, 1981). A Schmidt hammer was initially used as part of the normal portal field research investigation; however, it was found that readings could vary greatly over short spans, and consequently were not considered reliable for strength estimates. As expected, thinly bedded and highly fractured rock masses tended to give the highest dispersion of test data, but during the course of the field work, a reduction of the estimated values was noted for weathered rock surfaces. This reduction of compressive/shear strength along a weathered surface was discussed by Barton (Hoek and Bray, 1981), who suggested that the near surface material could have a strength of as low as one quarter the strength

of the unweathered fresh rock. Thus, even though the Schmidt hammer is somewhat unreliable for strength estimation purposes, it may be utilized as an index for the rough assessment of surface weathering on joint surfaces.

3.2.3 Specimen Sampling.

Collecting representative samples for laboratory testing (e.g direct shear) at portal sites was found to be a difficult endeavor due to the typically discontinuous, highly weathered conditions, and joint infill conditions. For the more weathered rock masses and thick joint infill, block samples that were carved and/or chiseled by hand proved to provide the least disturbed samples. Higher quality rock masses were sampled by removing large specimens from the field and sawing/coring test samples in the laboratory.

3.2.4 Laboratory Testing.

Laboratory testing performed as part of the initial field investigations proved that once a rock mass was identified, density, strength, and frictional characteristics obtained from the tests were typically within published bounds (e.g. in situ density, uniaxial compressive strength, residual angle of friction). Hence, published values were used in later field investigations for the rock mass classification, to save time and expense

(Goodman, et al, 1974; Hoek and Bray, 1981; Hoek and Brown, 1980; Miller, 1984; Nicholson, 1983; Wu and Sangrey, 1978). These values were spot checked for confirmation purposes.

3.2.5 Long-Term Behavior.

Most of the long-term difficulty and problems associated with portals were observed to arise from an inadequate assessment of loading conditions at the interface during planning and initial construction as well as oversteepened and poorly designed approach cut slopes. Problems were exacerbated by little or no maintenance, other than the occasional removal of fallen debris to improve access. In many cases, debris on protective canopies was allowed to accumulate to the incipient point of failure before remedial measures were taken. Surface and internal drainage provisions, such as invert and upper slope trenches, were also typically allowed to deteriorate. Hence, proper assessment of loading conditions at portals integrated with improved rock slope design in conjunction with maintenance programs would alleviate many of the long-term problems.

3.3 Industry Comments

As part of the information gathering process, inquiries

were sent to major U.S. tunnelling design firms and contractors. Many personal and telephone interviews were also conducted. The purpose of these inquiries and interviews was to ascertain general thoughts, prejudices, and practices in terms of portal design and construction. Overall, the responses were enthusiastic, showing genuine interest in the research. Of the many comments and views obtained, the thirteen major points are outlined in Appendix 3. Industry references are listed in Appendix 2 as opposed to Appendix 3 due to several requests for anonymity).

3.4 Natural Portals

To supplement the information on unsupported, man-made portals, natural or karstic (e.g. cave entrances) portals were also investigated via literature searches and field investigations. These portals were deemed important to this study due to their shallow location and long-term stability in a type of rock mass that can be generally characterized as massive to blocky/seamy (e.g. RMR's ranging from approximately 40 to 80), thus allowing relative span comparisons to be made with man-made structures in similar rock masses.

Dimensions for the 220 karst portals investigated

(located in twenty-six different limestone groups) varied significantly, often increasing in by the interface, thus furthering the theory of a less stable nature for the portal area. Though the maximum height was 70 feet and the maximum span was 120 feet, 95 percent of the portals had heights equal to or less than 20 feet, and spans equal to or less than 40 feet. Portal heights were observed to increase gradually with increasing span. Only five referenced failures were noted within this group, each located at the portal interface (Hempel, 1975).

From field investigations of natural portals, evidence of past instability was commonly observed in the form of overbreak in the 'Crown Face' area. This breakdown reduces the total portal interface area and provides a buttress type of support, thus enhancing long-term stability. Failure of the 'Crown Face' typically extended less than one span or diameter in by the portal interface. Furthermore, portals created by intersection with a man-made excavation such as a quarry operation were observed to be less stable and more unpredictable due to the blasting damage.

3.5 Database Organization and Trend Analysis

For trend analysis and practical utilization, a dual

reference system was established for the portal database. For initial data compilation, a detailed one to three page synopsis was established for each case history, as illustrated in Table 3-1. The synopsis format, which contains specific information in the key areas of rock mass classification, difficulty/failure description, and support/drivage methods, is available from the Department of Mining and Minerals Engineering, Virginia Polytechnic Institute and State University.

From the detailed synopsis format, a table containing abbreviated entries for all 500 case histories was established. Refer to Table 3-2 for an excerpt from this table which contains the example chosen for Table 3-1. The abbreviated form of the database, Table A4-1 in Appendix 4, allows the database to be presented within a manageable length; additionally, utilization is simplified. For example, the table can be used for quick reference, while the synopsis format may be used for detailed information or clarification.

The data chosen to be included within the database is listed in Table 3-3, and is further identified and discussed in the following sections. This was considered the minimum amount of information necessary to describe a portal for trend assessment purposes.

Table 3-1. Example of Synopsis Database Format - Pilots Peak Mine Portal.

NAME:	Pilots Peak Gold Mine [1].
LOCATION:	Pilots Peak, California, USA
TYPE:	Gold Mine
DATE BUILT:	Circa 1920.
AGE:	68+ years
SHAPE:	Rectangular
DIAMETER:	-
WIDTH:	6 (2' CFO failure)
HEIGHT:	4
CROSS SECTION:	24 Ft. ²
ROCK MASS:	Highly fractured metavolcanics with quartz joint filling and veins.
DIFFICULTY:	Portal collapse and 'Crown Face Overbreak' of 2'.
LENGTH OF DIFFICULTY:	Approximately 12' (e.g. 2 diameters).
FAILURE CLASSIFICATION:	'Upper Slope Collapse/Subsidence' (1), 'Crown Face Overbreak' (1).
SUPPORT UTILIZED:	None.
DRIVAGE METHOD:	Conventional and hand.
DRIVAGE SECTION:	Full-face.
REFERENCE:	(Orr, 1982; Field Investigation)

Table 3-2. Excerpt from the Table Database Format - Pilots Peak Mine Portal.

#	NAME, LOCATION	TYPE	#	AGE	SHP	DIA	WID	HT	CS	ROCK	DIF	LTH	FAIL	SUPPORT	DRI/SEC	REFERENCE
362	Pilots Peak, CA, USA *	M	1	68	R	-	6	4	24	M/HF	PEA	12	SC,CFO	N		C,H/FF (Field Investigation)

Table 3-3. Information Gathered for the Portal Database.

1. NAME/NUMBER
2. LOCATION
3. TYPE
4. DATE BUILT
5. AGE
6. SHAPE
7. DIAMETER
8. WIDTH
9. HEIGHT
10. CROSS SECTION
11. ROCK MASS
12. DIFFICULTY
13. LENGTH OF DIFFICULTY
14. FAILURE CLASSIFICATION
15. SUPPORT UTILIZED
16. DRIVAGE METHOD
17. DRIVAGE SECTION
18. REFERENCE

3.5.1 Name/Number.

The initial information is the name of the portal. This is generally taken as the name of the underground excavation, the name of the mining company, and/or the name of the city/community in which the portal is located (e.g. Bad Creek Project, Virginia Lime, Low Moor, respectively). If multiple portals exist, a numerical or directional identification is utilized (e.g. Low Moor # 7, Big Walker Mountain - North Portal, etc.). The name has been typically shortened for the table format. The number of portals is given following the name of the portal in the synopsis format, and as a separate line item in the table format. An asterisk following the name in the table format indicates that the portal has been visited by the author.

3.5.2 Location.

The location of the portal is provided as to site/city, state, and country in the synopsis format. The location in the table format was shortened to state and country.

3.5.3 Type of Portal.

Due to the different applications, philosophies, and life spans, it is desirable to know the ultimate use of a portal. Disparate support and construction philosophies are utilized for various types of portals (e.g. mining and civil projects). The mining project is typically of much

shorter life-span (e.g. 5 - 30 years), less conservative support, and hence, entails a lower factor of safety or higher factor of risk. Whereas, the civil works project, such as a pump-storage scheme, is designed with a much longer life-span (e.g. 50 - 75+ years), a more conservative support system, and hence, a higher factor of safety or lower factor of risk. For example, in a mine portal, the occasional loosening and falling of a piece of rock is to be expected; however, in a civil project, such as an interstate highway tunnel portal, such an event would not be permissible. The five general types of portals: 1) Road/Highway, 2) Rail, 3) Hydro/Water, 4) Mine, and 5) Other; along with their abbreviations for the tabular format, are shown in Table 3-4. The 'Other' category includes natural portals (e.g. caves), experimental portals, etc. In both formats, if the information is unknown or more likely, unavailable, a hyphen will be utilized.

Figure 3-1 illustrates a breakdown of the portal types from the 500 case history database. Note that mine portals (40%) comprised the largest single group of portals in the database. These are followed by hydro/water project portals (24%), highway/road portals (21%), railroad portals (13%), and other portals (2%).

Table 3-4. Abbreviations for Portal Type.

#	TYPE	ABBREVIATION
1.	Road/Highway	H
2.	Rail	R
3.	Hydro/Water	W
4.	Mine	M
5.	Other	O

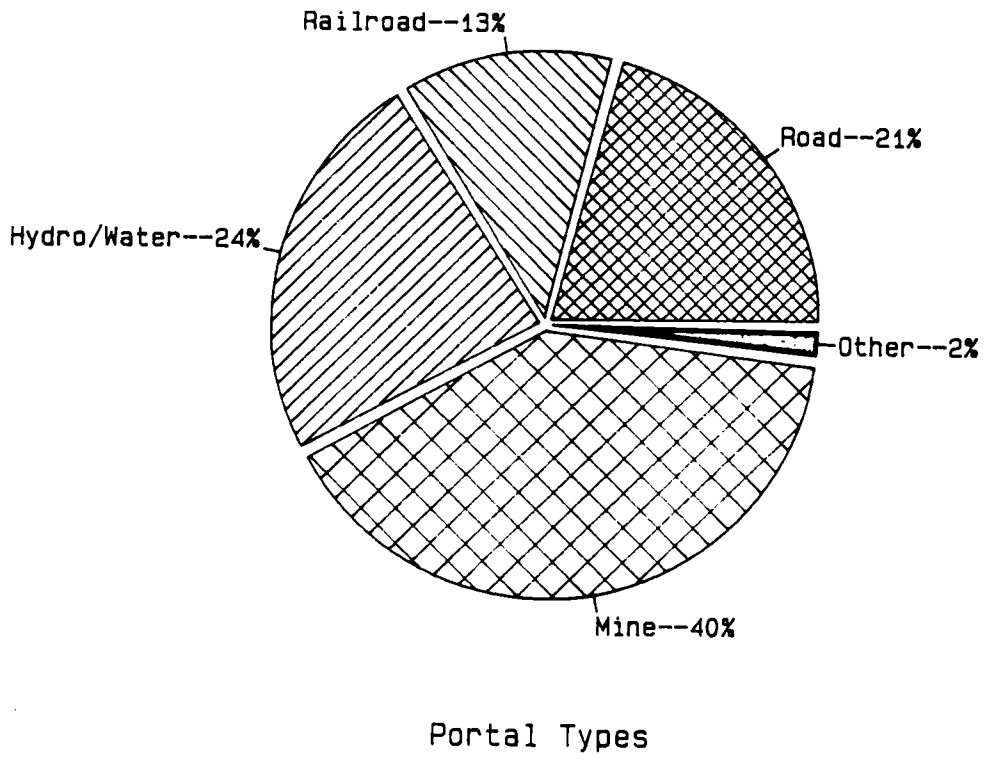

Figure 3-1. Portal Type Distribution.

3.5.4 Date Built.

The date of excavation is provided as this has a direct bearing on the stability assessment of a portal, both in terms of deterioration and construction methods/technology at the time of construction. For example, a mine portal that is 45 years old, without other information, could be expected to have suffered one or more types of difficulty and/or failure. A civil structure of the same age could be expected to show little other than minor hairline concrete cracks and spalling. As to the construction methods/technology, generally the older the structure, the more damage to the rock mass, via initial blast damage and long-term dilation. The date built replaced by portal age for the table format.

3.5.5 Age.

Based on the excavation date, the age in years through 1988 is given. The average age, from 478 recorded values (e.g. 96%), was 36 years with a standard deviation of 31 years yielding a mean construction/technology date of 1952. The age ranged from 0 to 147 years (excluding natural portals).

3.5.6 Shape.

Next, the shape of the portal, which may have a direct bearing on the long and short-term stability assessment, is

provided. For example, while circular shaped openings are generally considered to be very stable, especially when used with full ring sets, for some rock masses such as an interbedded sedimentary sequence, a rectangular opening may be preferred to prevent corbel loading in the upper corners. Table 3-5 lists the 5 basic shape categories chosen for the database. These categories are: 1) Horseshoe, 2) 'D', 3) Circular, 4) Rectangular, and 5) Other. The 'Other' category includes shapes such as trapezoidal and irregular.

Figure 3-2 shows the portal shape distribution for the database. Note that the 'Rectangular' (37%) and 'Horseshoe' (37%) shapes comprised the largest single categories, followed by 'D' (10%) and 'Circular' (10%) shapes. The 'Other' (3%) and 'Unavailable Information' (3%) categories were the smallest. The large 'Rectangular' category arises from the high proportion of mine portals, whereas the sizeable 'Horseshoe' category is related to the fact that this is the most popular shape used with conventional methods when 'turning under' a portal.

3.5.7 Diameter.

Tunnels and portals are often described by the actual or equivalent diameter in feet. For the purposes of this research, the term 'diameter' is interchangeable with 'span'; however, for both database formats, a value is

Table 3-5. Abbreviations for Portal Shape.

#	SHAPE	ABBREVIATION
1.	Horseshoe	H
2.	'D'	D
3.	Circular	C
4.	Rectangular	R
5.	Other	O

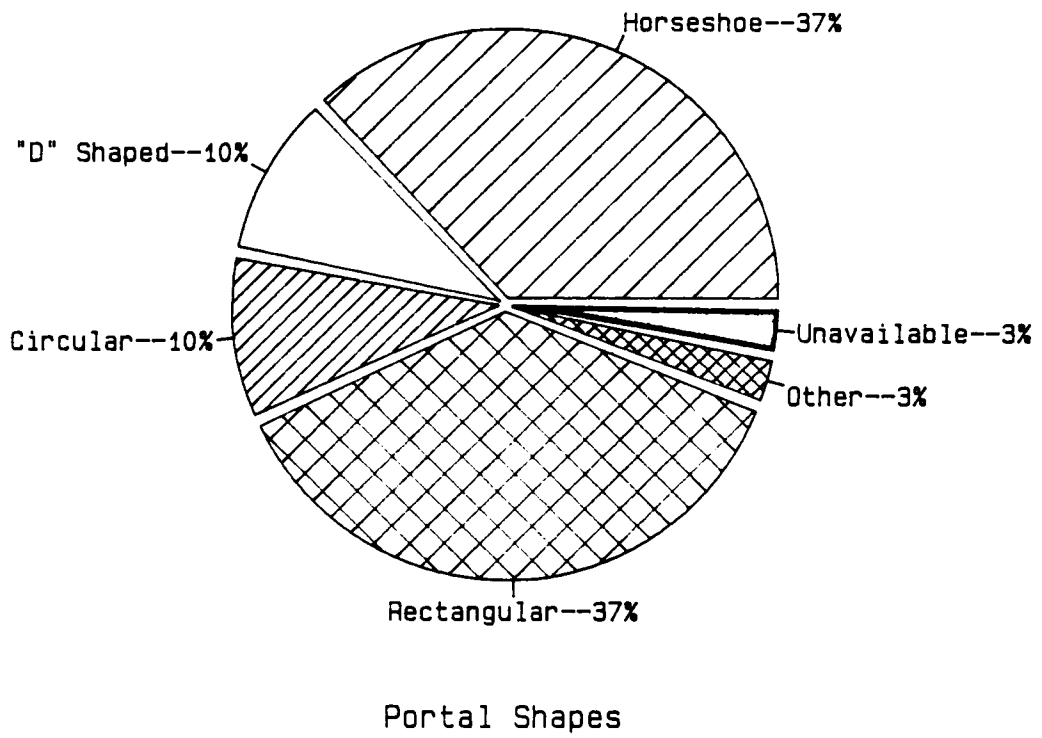

Figure 3-2. Portal Shape Distribution.

given only when available for the case histories. English units are used as standard for this research, and the metric value, if given, is shown in parenthesis.

Of the 500 portals, only 67 diameter values (e.g. 13%) were obtainable. No effort was made to convert rectangular or horseshoe shapes into equivalent diameters. The mean diameter was 23 feet with a standard deviation of 10 feet.

3.5.8 Width.

The width or span of the excavation is provided in feet for both synopsis and table formats. Since the portal is a near-surface excavation that is structurally dependent on discontinuity frequency and spacing for stability, the span is a key element in any stability assessment.

424 span values out of the 500 portal database (e.g. 85%) were obtained, giving a mean span of 21 feet with a standard deviation of 15 feet. The span values ranged from 5 to 120 feet.

3.5.9 Height.

The height of the portal in feet, though not generally as critical as the span, is also provided in both formats for completeness.

416 height values out of the 500 portal database (e.g. 83%) were obtained, giving a mean height of 17 feet with a standard deviation of 13 feet. The height values ranged

from 2 to 60 feet.

3.5.10 Cross Section.

The cross section in square feet is provided in both database formats when available. Typically, this value is only reported for larger underground excavations, and hence very few cross section values were available for the database. The category was left in the database for future use, modification, or deletion.

3.5.11 Rock Mass.

The rock mass for each case history is described as to the general type, Table 3-6, and structural characteristics, Table 3-7. The three basic rock types are: 1) Igneous, 2) Sedimentary, and 3) Metamorphic. The rock structure has been divided into four broad categories to compensate for the frequently vague and non-specific information obtained from literature and industry sources. These four categories are: 1) Massive, 2) Blocky/Seamy, 3) Highly Fractured, and 4) Weathered/Decomposed. These categories were designed to approximate those of the Geomechanics Classification (Bieniawski, 1973, 1984). The Massive category corresponds to Class 1 (Very Good Rock) and Class 2 (Good Rock). The Blocky/Seamy category corresponds to Class 3 (Fair Rock), and subsequently, the Highly Fractured and Weathered/Decomposed categories

correspond with Class 4 (Poor Rock) and Class 5 (Very Poor Rock), respectively. Every effort was made to carefully interpret the rock mass description for each case history for the correct placement into one of the four broad categories by utilizing the typical ranges of class values as provided by the Geomechanics Classification. The trends ascertained from this rudimentary classification have proven very enlightening and are considered adequate for this research.

Figure 3-3 shows the rock type distribution for the database. Note that sedimentary rock masses (74%) form the largest single category. This is followed by metamorphic rock masses (12%), igneous rock masses (11%), and unavailable information (3%).

As to the rock structure distribution, Figure 3-4 shows that the 'Blocky/Seamy' (37%) category is the largest, followed by 'Highly Fractured' (36%), 'Massive' (13%), 'Weathered' (12%), and 'Unknown' (2%).

3.5.12 Difficulty.

Even though a portal may have not experienced one of the eight types of portal failure, it has probably experienced difficulty in one form or another. The categories of difficulty are listed in Table 3-8 along with their abbreviations. The six types of difficulty that may be experienced at portals are: 1) None, 2) Structures

Table 3-6. Abbreviations for Rock Mass Type.

#	ROCK TYPE	ABBREVIATION
1.	Igneous	I
2.	Metamorphic	M
3.	Sedimentary	S

Table 3-7. Abbreviations for Rock Mass Structure.

#	STRUCTURE	ABBREVIATION
1.	Massive	M
2.	Blocky/Seamy	BS
3.	Highly Fractured	HF
4.	Weathered/Decomposed	W

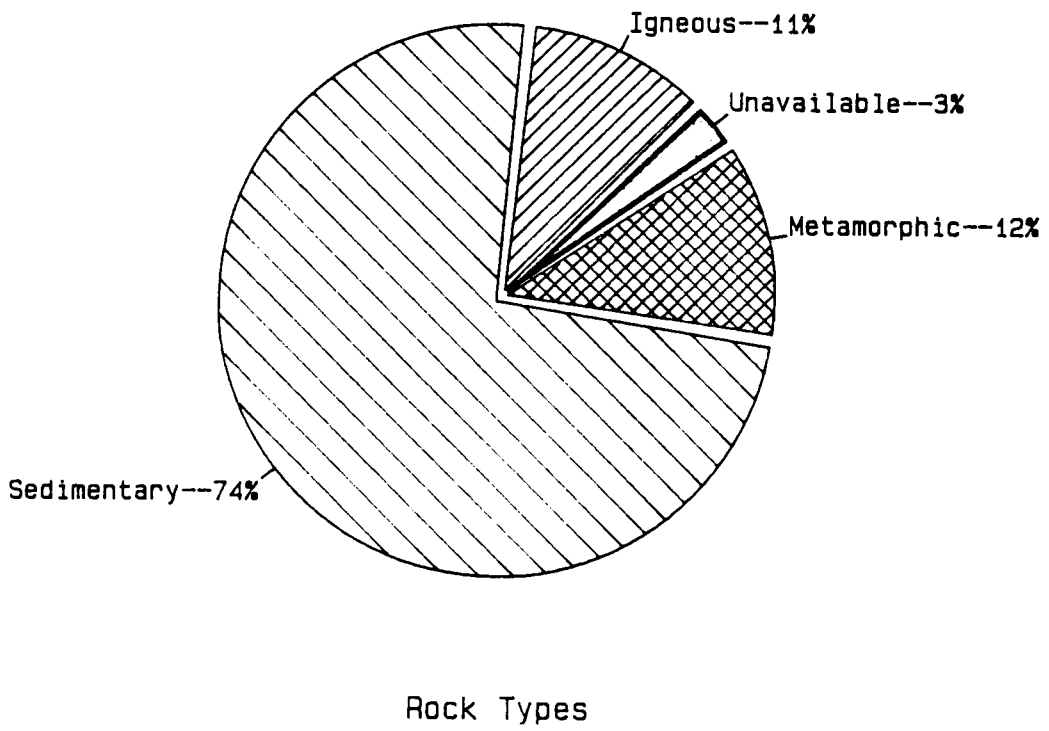

Figure 3-3. Portal Rock Type Distribution.

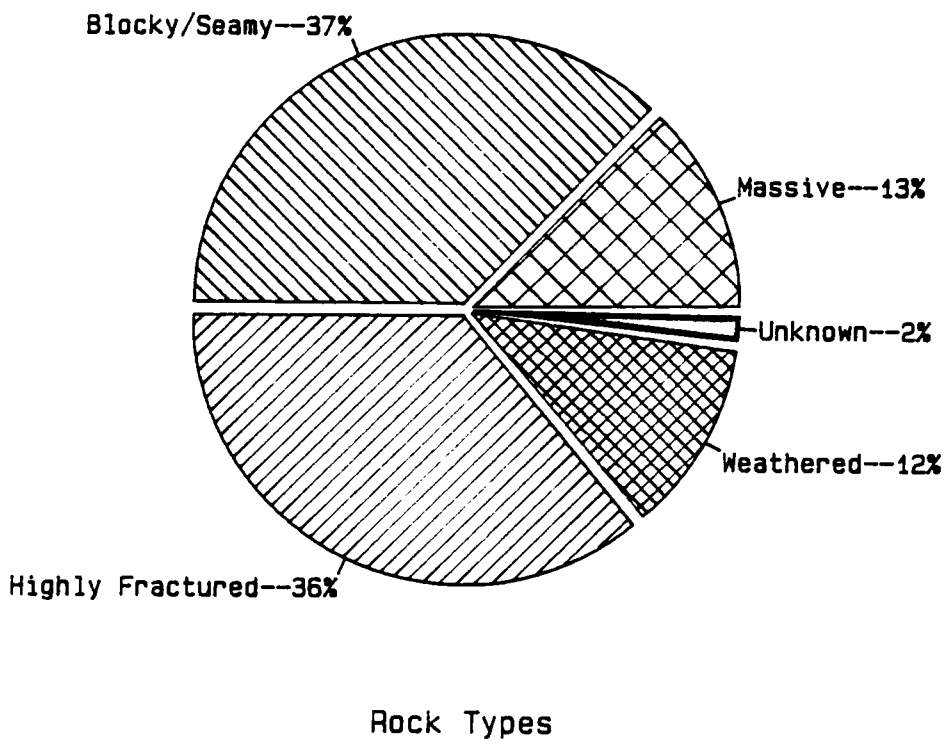

Figure 3-4. Portal Rock Structure Distribution.

Nearby, 3) Poor Ground Conditions, 4) Failure, 5) Abandonment and/or Relocation, and 6) Other. The 'None' category of course means that there were no difficulties reported. Since portals are near-surface excavations, the problem of 'Surface Structures' and their potential damage through blasting and/or settlement are often encountered. Also, in dealing with near-surface rock masses, 'Poor Ground' conditions are typically found (e.g. weathering, open/clay filled joints, etc.). The 'Failure' category denotes one or more incidents of one of the eight types of portal failure. If extremely difficult conditions and/or failure is found at a portal site, it is common practice to abandon the site and relocate a short distance away, hence, the 'Abandonment/Relocation' category. Also, after the useful life of a portal is complete, it is typically abandoned (e.g. mine and railroad portals), and is referenced in this manner. 'Other' types of difficulty such as seismic shock damage, natural or man-induced, are included in the final category.

Figure 3-5 illustrates the portal difficulty distribution. Not surprisingly, as industry comments and literature had forewarned, out of the 500 portal database, 57% of the portals had experienced one or more of the eight different types of portal failure. Furthermore, 53% of the portals were driven in ground conditions described as 'poor', with 30% of the portals either being classified as

abandoned and/or having to be relocated. Other difficulties accounted for 7% of the portals. Thus, with 2% unavailable difficulty information, and 16% of the portals encountering no reported difficulty, an overwhelmingly significant 82% of the portals in the database experienced failure and/or some form of difficulty.

3.5.13 Length of Difficulty.

The length of difficulty, in feet, is taken as the length along the centerline axis of the portal in which one or more of the abovementioned difficulties were encountered. It may also be the length of special portal support requirements. For example, a portal subsidence collapse that extended 50 feet in by the portal interface and 15 feet out by the portal interface would have a length of difficulty of 65 feet. Another example might be in the case of 30 foot long rock anchors being utilized to prevent excessive dilatant rock mass behavior. Here, the length of difficulty, unless otherwise specified, is taken as the distance that a special support technique, common only to the portal zone, was utilized (e.g. 30 feet).

Three hundred and eleven length of difficulty values out of the 500 portal database were obtained (e.g. 62%), giving a mean value of 59 feet with a standard deviation of 84 feet. The length of difficulty ranged from

Table 3-8. Abbreviations for Difficulty.

#	DIFFICULTY	ABBREVIATION
1.	None	N
2.	Structures Nearby	S
3.	Poor Ground Conditions	P
4.	Failure	F
5.	Abandonment/Relocation	A
6.	Other	O

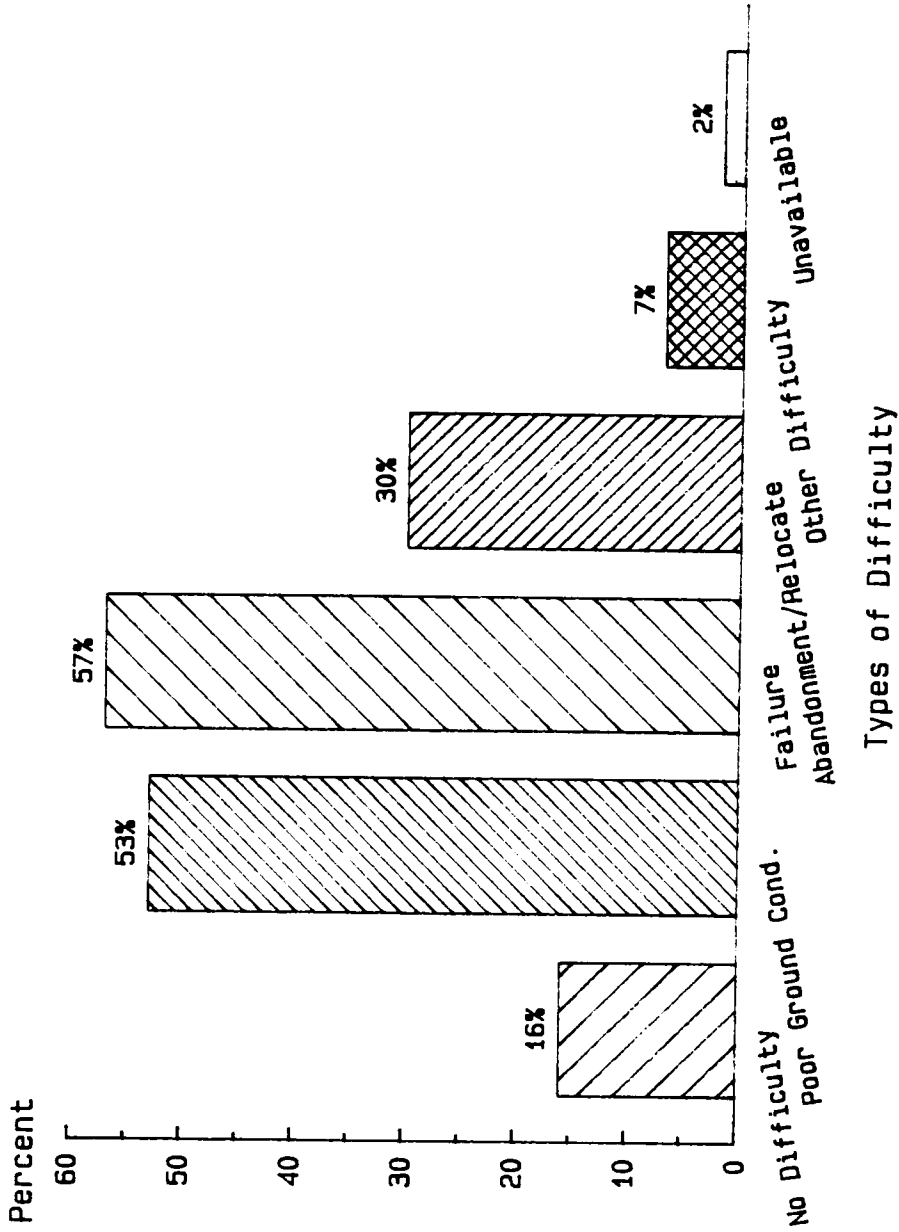

Figure 3-5. Portal Difficulty Distribution.

10 to over 500 feet.

Using the mean span of 21 feet and the mean length of difficulty of 59 feet, the length of difficulty may be expressed in terms of a number of portal spans or diameters. In other words, $59/21 = 2.91$ or approximately 3 portal spans. Hence, support projections, perhaps average to worst case scenario, may be based upon this mean length of difficulty. For example, a portal with a 20 foot span in average to difficult ground conditions can be expected to have, unless other information is available, approximately 3 spans or 60 feet of difficulty.

Further correlations between the portal span and the length of difficulty for specific failure classifications are shown in Figures 3-6 through 3-8. Note that the trend of an increasing length of difficulty with a decreasing quality of rock mass remains basically the same for each of the three figures. In other words, the length of difficulty increases with increases in discontinuity density. In practice, these figures may help to predict the extent of support required. For example, using Figure 3.8, for a projected 20' portal span, a length of difficulty for 'Massive' rock mass conditions of 18 feet or 0.9 spans is predicted. For 'Blocky/Seamy' conditions, this increases to approximately 34 feet or 1.7 spans; whereas, 'Highly Fractured' conditions predict a length of difficulty of 60 feet or 3 spans. The above prediction is

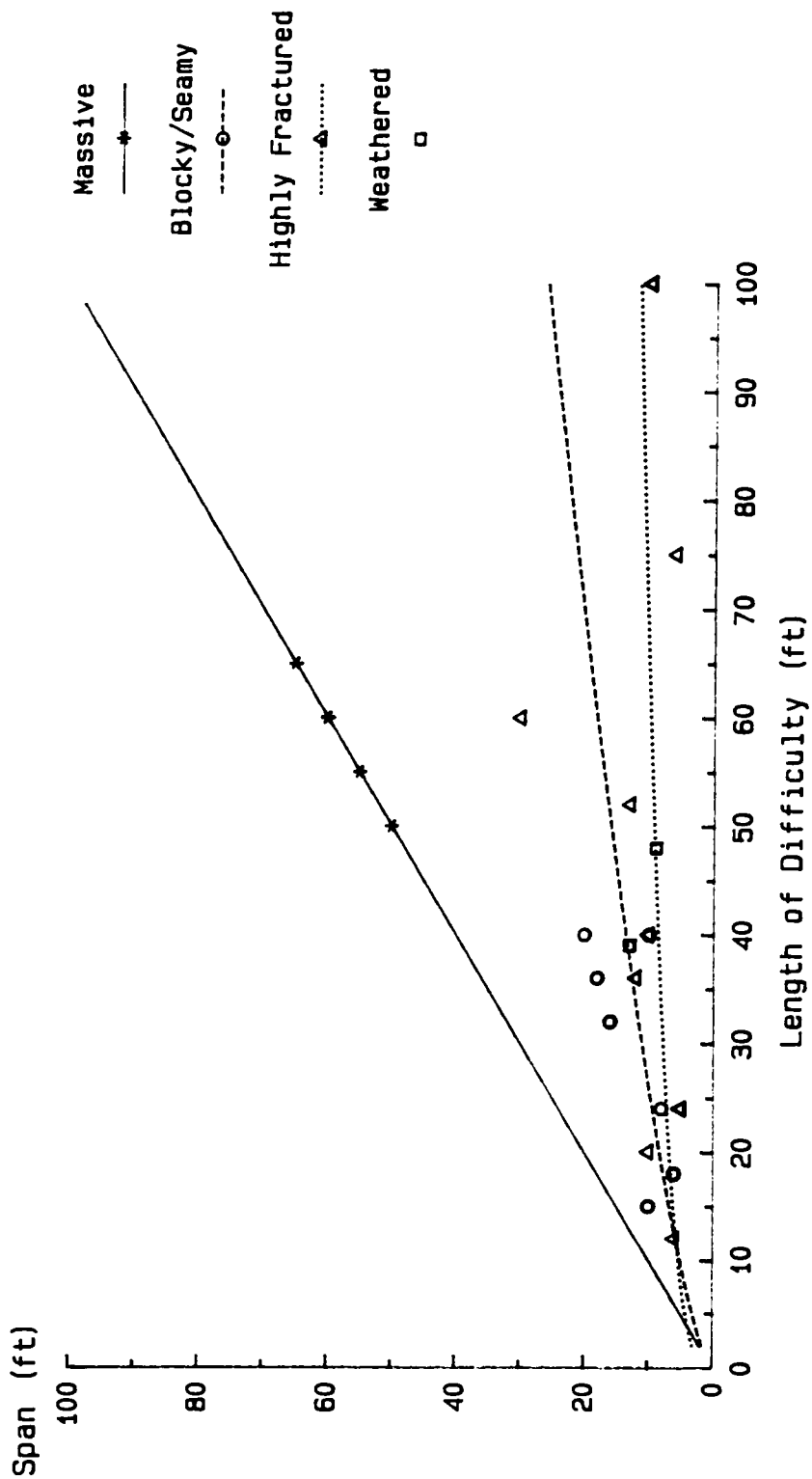

Figure 3-6. Portal Span VS. Length of Difficulty - Subsidence/Collapse Failure.

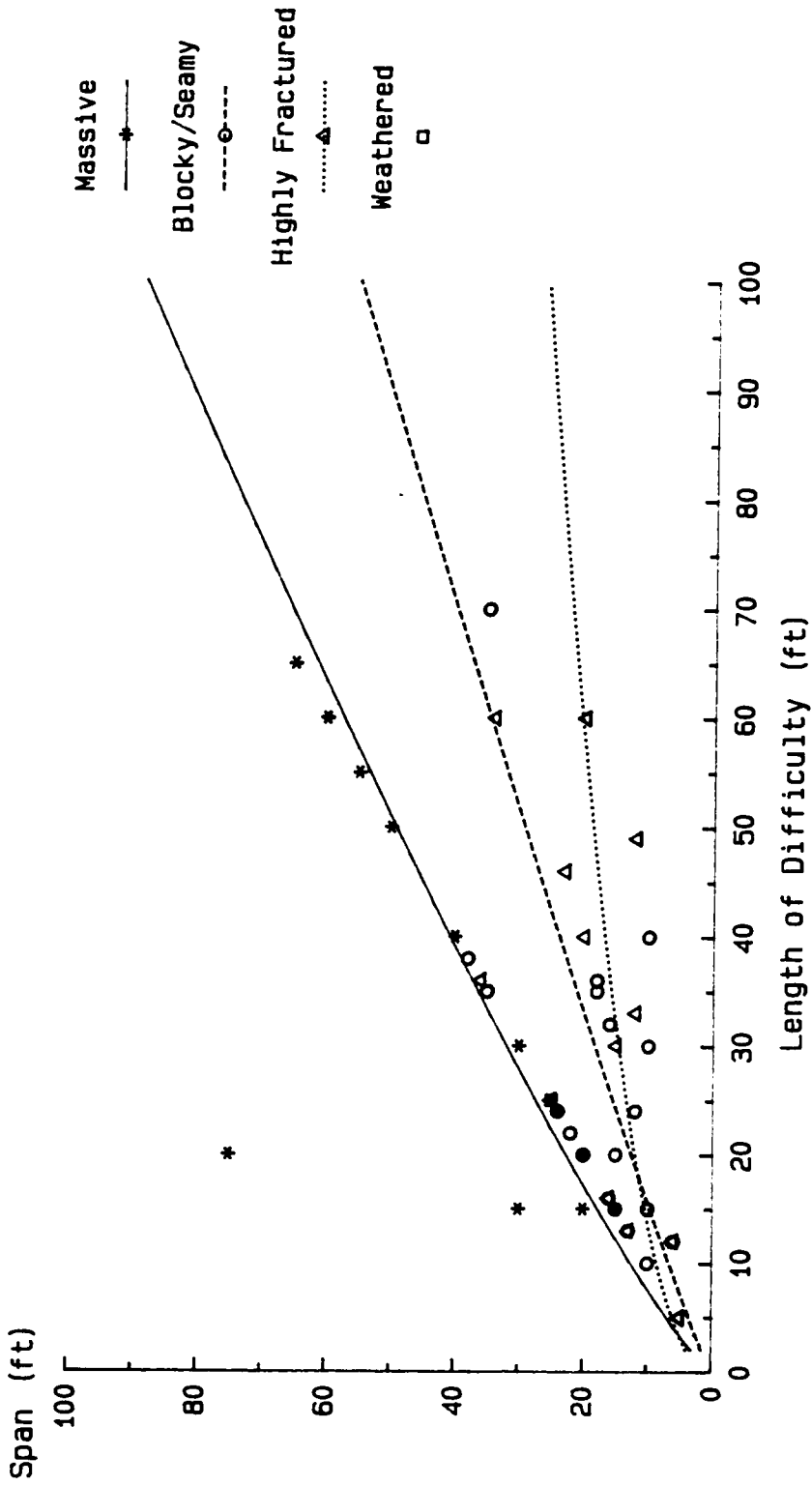

Figure 3-7. Portal Span VS. Length of Difficulty - Crown Face Overbreak Failure.

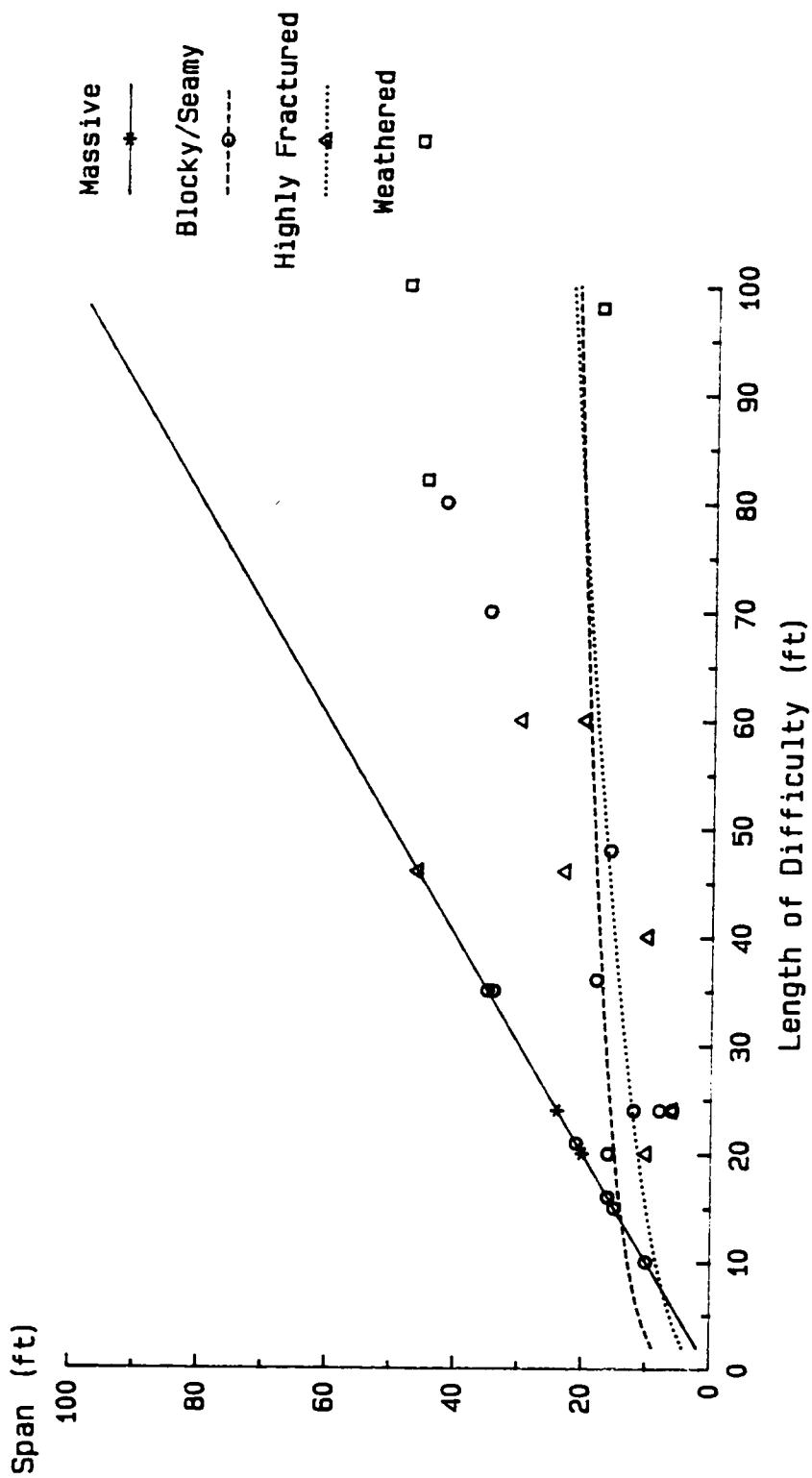

Figure 3-8. Portal Span VS. Length of Difficulty - Internal Collapse, Outer Rib Slide, Upper Slope Slide, and Invert Failure.

based not only on the actual length of the 'Crown Face Overbreak', but also on the other failures, since it is common to have multiple failures recorded for one portal in this database, and various lengths of support utilized. Hence, when planning for support zones, one would incorporate the entire predicted length of difficulty; however, if just planning for 'Crown Face Overbreak', the support will obviously be scaled down. 'Crown Face Overbreak' will be discussed in more detail in a later section.

3.5.14 Failure Classification.

The failure classification, which is discussed in detail in Section 4, consists of eight, location-based, types of portal failure. These eight types, which evolved during the initial phase of the database construction, are listed in Table 3-9 along with their abbreviations for the table format. They are: 1) 'Overall Mass Slide', 2) 'Upper Slope Slide', 3) 'Outer Rib Slide', 4) 'Subsidence/Collapse', 5) 'Crown Face Overbreak', 6) 'Internal Collapse', 7) 'Invert Failure', and 8) 'Seal Rupture'. More than one failure may be noted for a single portal case history.

The failure classification distribution is shown in Figure 3-9. This distribution is based on 345 failure incidents from 282 portals out of the 500 portal database.

Hence, 56% of the portals investigated had experienced one or more failure incidents. Note that the largest failure classification is that of 'Subsidence/Collapse' (36%), which is followed very closely by 'Crown Face Overbreak' (34%). Next is 'Internal Collapse' (10%), 'Upper Slope Slide' (8%), 'Outer Rib Slide' (5%), 'Invert Failure' (4%), 'Overall Mass Slide' (2%), and 'Seal Rupture' (1%). Note that if the types of external sliding were combined, they would total 15% and thus comprise the third largest failure classification.

An important point to note, is that the largest failure classification, 'Subsidence/Collapse', is significantly based upon abandoned portals (75%). Hence, the largest failure classification for existing and yet-to-be-built portals is that of 'Crown Face Overbreak'. Refer to Figure 3-10, which also notes that 30% of all portals investigated were considered abandoned, and that 49% of all reported failure incidents were from these abandoned portals.

Two very interesting correlations between portal failure classification and rock mass type are shown in Figures 3-11 and 3-12. First, Figure 3-11 shows that the majority of portal failures occur in rock that is classified as 'Blocky/Seamy' (44%). This is followed by 'Highly Fractured' (35%), 'Massive' (14%), and 'Weathered' (6%). Furthermore, Figure 3-12 specifically shows the correlation between individual failure classifications and

Table 3-9. Abbreviations for Failure Classifications.

#	CLASSIFICATION	ABBREVIATION
1.	Overall Mass Slide	OMS
2.	Upper Slope Slide	USS
3.	Outer Rib Slide	ORS
4.	Subsidence/Collapse	SC
5.	Crown Face Overbreak	CFO
6.	Internal Crown/Rib Collapse	IC
7.	Invert Failure	IF
8.	Seal Rupture	SR

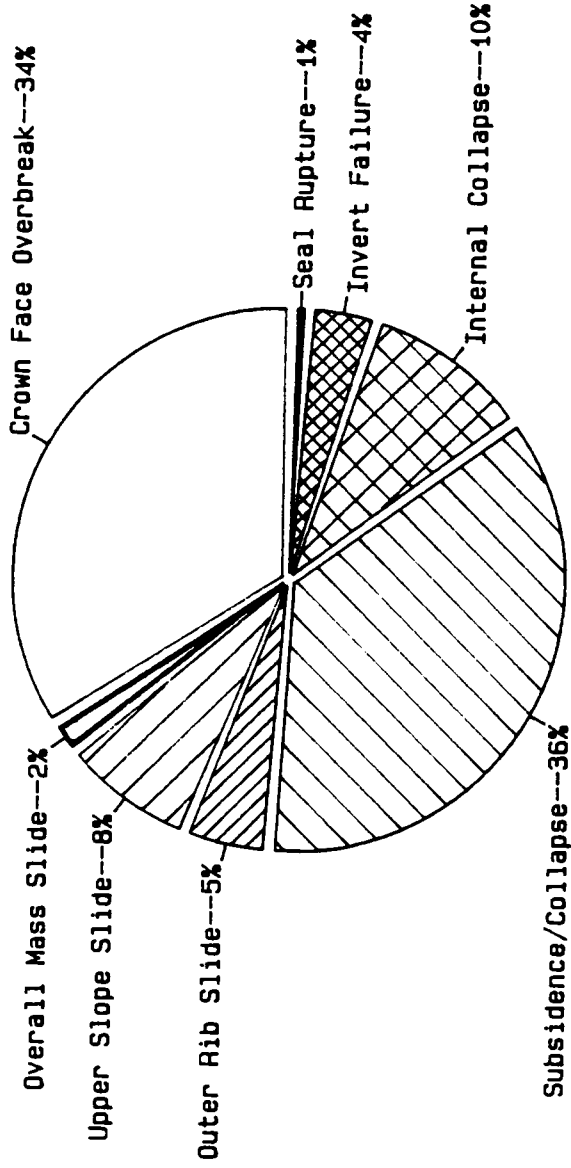

Failure Types

NOTE: 345 failure incidents were identified from the 500 portal database.

Figure 3-9. Portal Failure Distribution.

Percent of Failure Incidents - Abandoned Portals

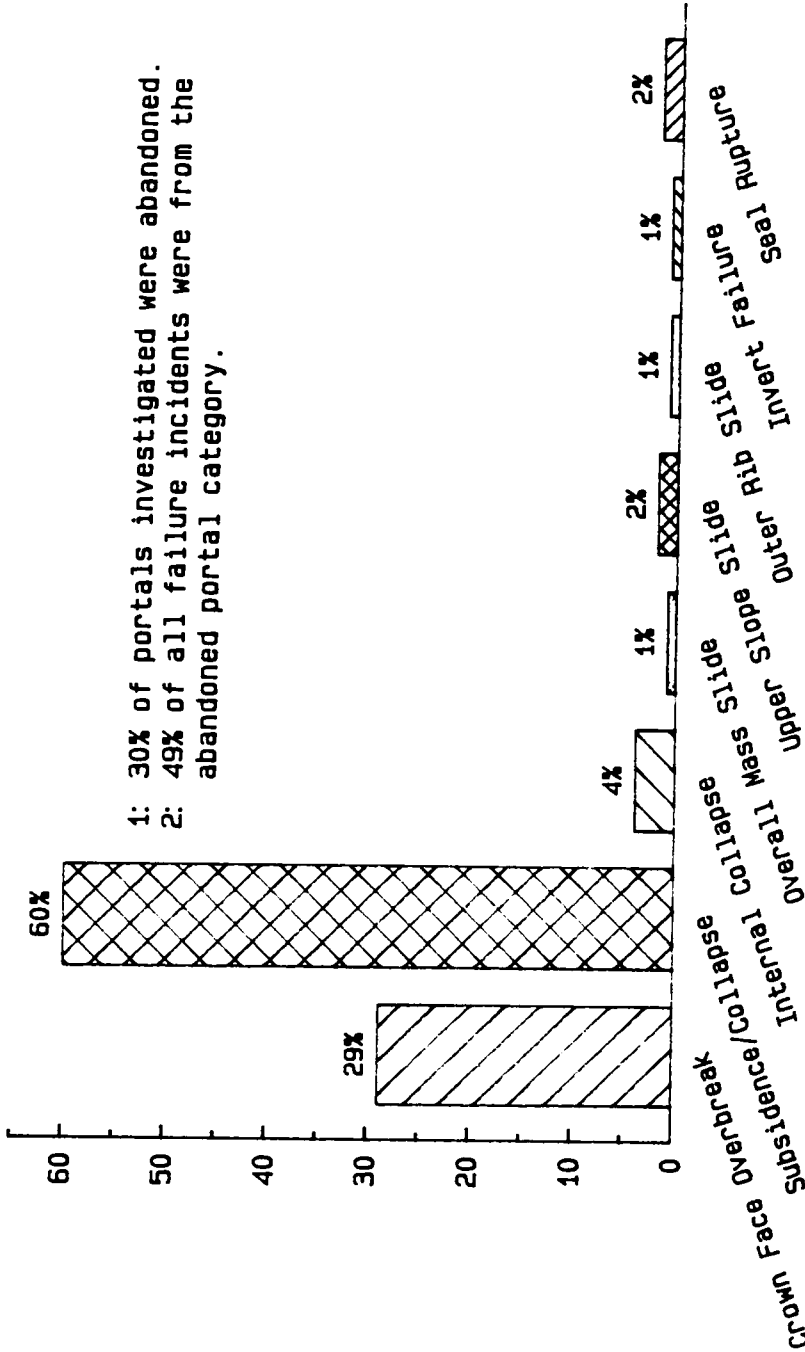

1: 30% of portals investigated were abandoned.
 2: 49% of all failure incidents were from the abandoned portal category.

Failure Type NOTE: 500 portal database.

Figure 3-10. Abandoned Portal Failure Distribution.

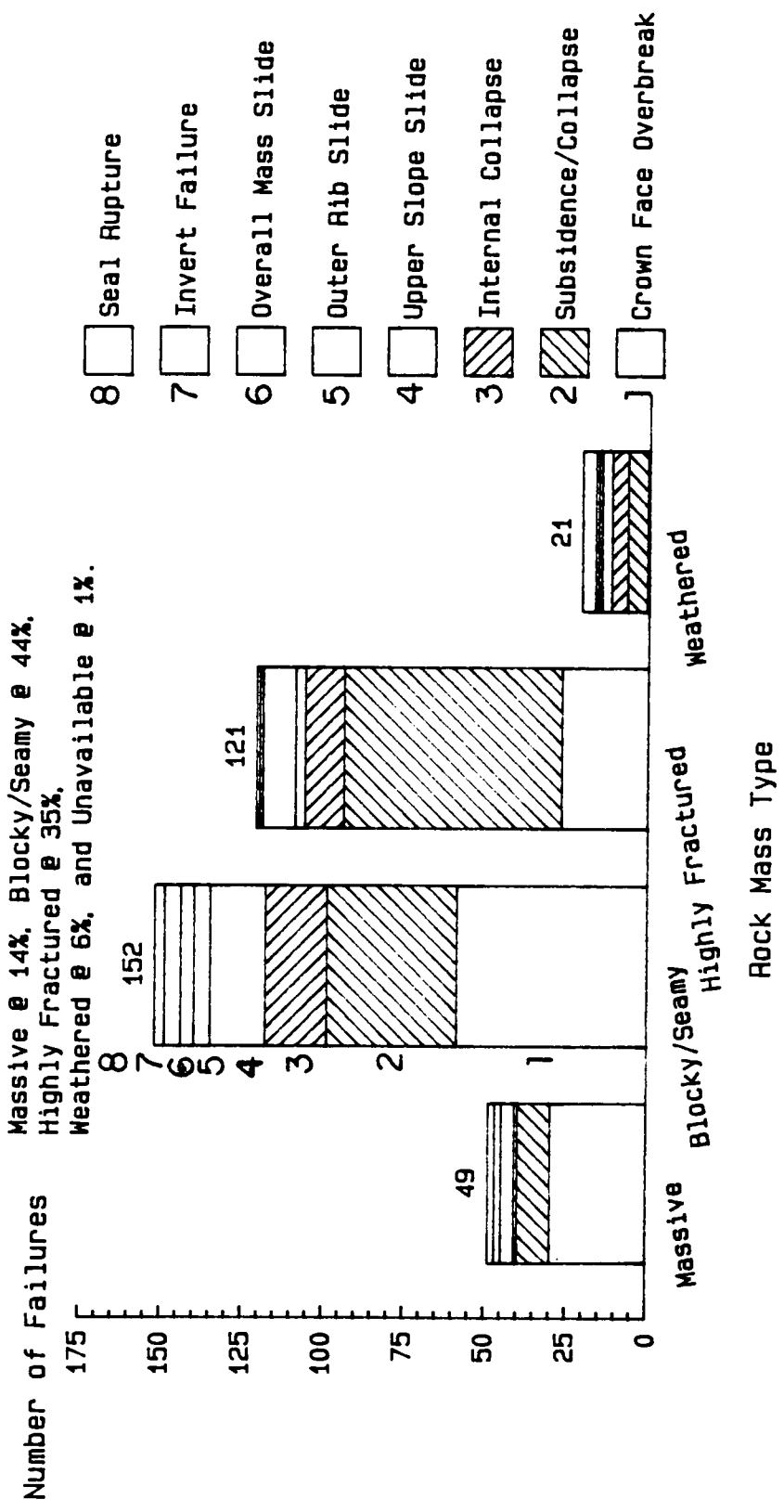

Note 1: 500 portal database.

Note 2: Failure types (e.g. column segments) are in the order listed, from bottom to top.

Figure 3-11. Portal Failures Per Rock Mass Type.

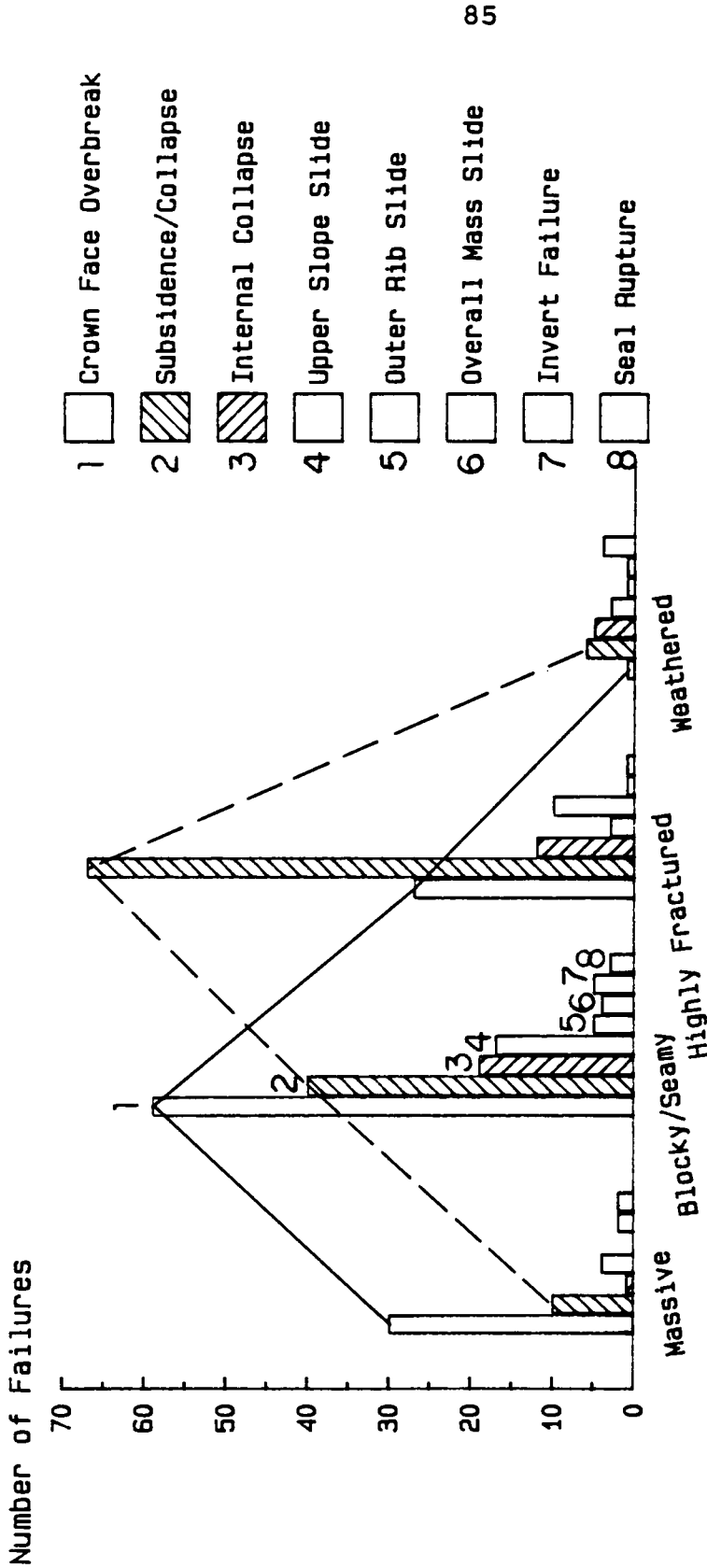

Note 1: 500 portal database.
 Note 2: Failure types (e.g. columns) are in the order listed, from left to right.

Figure 3-12. Portal Failure Classification Correlation with Rock Mass Type.

rock mass types. For example, note that 'Crown Face Overbreak' peaks in the 'Blocky/Seamy' category, while 'Subsidence/Collapse' peaks in the 'Highly Fractured' category. Thus, with knowledge of the rock mass characteristics and support system condition at a portal site, it is possible to predict potential short and long-term failure scenarios.

3.5.15 Support Utilized.

In the longer synopsis database format, the support methods were elaborated on in extensive detail when possible; however, for the table format, a simpler more concise categorization listed in Table 3-10 was utilized. So many different combinations of common subsurface support systems are utilized, that a more extensive breakdown was found to be overly complex and unmanageable. The more detailed analysis was also found to be biased by age. In other words, until the late 1940's, reinforcement was largely wooden or steel sets and concrete. From the 1940's to date, the trend has been to use rock bolts/anchors in combination with shotcrete and wire mesh. Thus, as technology improved, support methods changed for individual types of portals. The five general support categories are: 1) None, 2) Canopy, 3) Rock Reinforcement, 4) Portal Structure, and 5) Cut-and-Cover. The first category, 'None', is for those portals in which no support whatsoever

was utilized. The 'Canopy' category contains portals that use a protective structure outby the portal interface to prevent injury and/or damage from small falling/ravelling debris from the crown face and upper slope. 'Rock Reinforcement' refers to any rock support system, active or passive, used on the surface or underground at a portal site (e.g. rock bolts, steel sets, wire mesh, shotcrete, etc.). A 'Portal Structure' is a structure located at the portal interface that typically has a dual role of support and some other function. Examples of these are the elaborate portal structures that are built for interstate highway tunnels. These structures commonly house ventilation equipment in addition to providing mass buttress support. The last category of 'Cut-and-Cover' refers to portals where the conditions allow or necessitate that a section of the portal be excavated by common surface methods, constructed in the trench, and then covered.

Figure 3-13 illustrates the portal support classification distribution. With 8% of the portals investigated requiring no support and only 1% unavailable support information, approximately 91% of the portals utilized some form of support or protective structure. Specifically, 89% of the portals utilized rock reinforcement with other support categories, while 63% of the portals used rock reinforcement methods alone. Portal structures were utilized in 14% of the cases, and both cut-

Table 3-10. Abbreviations for Support Classifications.

#	SUPPORT CLASSIFICATION	ABBREVIATION
1.	None	N
2.	Canopy	C
3.	Rock Reinforcement	RR
4.	Portal Structure	PS
5.	Cut-and-Cover	CC

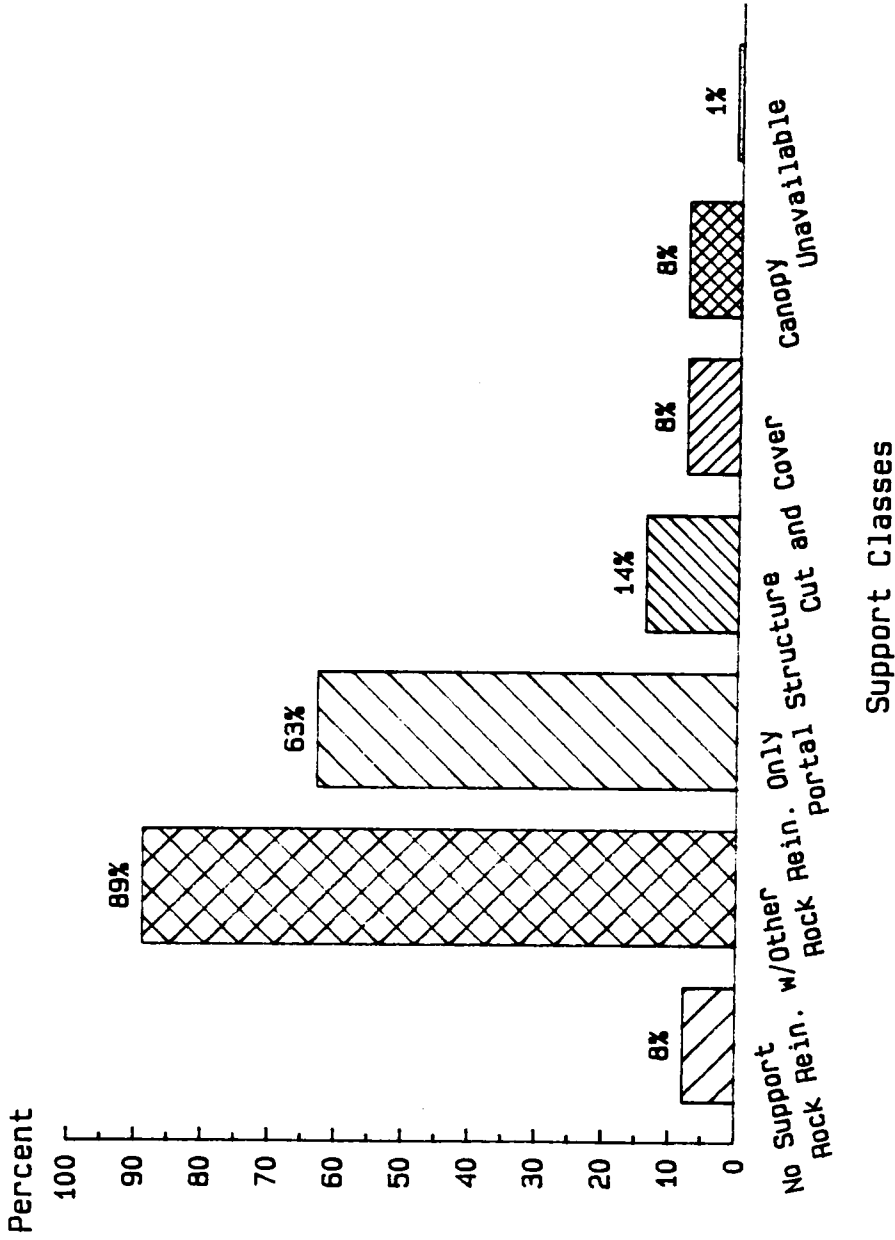

NOTE: 500 portal database.

Figure 3-13. Portal Support Classification Distribution.

and-cover methods and canopies each accounted for 8% of the cases. Specific support information gathered from the 500 portals in the database is utilized later in Section 6 as a partial basis for support guidelines.

3.5.16 Drivage Method.

It has long been recognized that the method of excavation affects the overall stability. Methods that less severely damage the rock mass (e.g. machine) tend to be more stable than conventional drill and blast methods. Hence, it is desirable to know the method with which a portal was excavated, both for assessing current and long-term stability, as well as for trend analysis. The four basic categories listed in Table 3-11 are: 1) Conventional, 2) Machine, 3) Hand, and 4) Natural. The 'Conventional' category refers to routine drill and blast excavation. 'Machine' excavation includes tunnel boring machines (TBM's), road headers, continuous miners, etc. 'Hand' excavation is typified by manual labor in combination with shovels, pneumatic spades, and other hand tools. Extremely difficult ground conditions often call for this method, though it is largely obsolete in all but third-world countries. The last category of 'Natural' refers to subsurface voids not made by man, such as caves, vugs, and lava tubes.

Figure 3-14 illustrates the distribution of the

abovementioned types of portal drivage methods.

Conventional methods, alone or in combination with other methods (86%), were utilized more frequently than all other methods. Conventional methods alone account for 43%, and conventional methods in combination with other methods accounts for another 43%. These are followed by 'Machine Only' methods (8%), 'Hand Only' methods (1%), 'Natural' features (2%), and 'Unavailable' information (3%). The specific breakdown for the various combinations of methods is shown in Figure 3-15.

3.5.17 Drivage Section.

Portals may be advanced by the abovementioned drivage methods in various drivage sections. The abbreviations for the six drivage sections, listed in Table 3-12, are: 1) Full-Face, 2) Heading and Bench, 3) Pilot w/Full-Face, 4) Pilot w/Heading and Bench, 5) Multiple Drifts, and 6) Natural. The first category of 'Full-Face' denotes a portal driven to the full excavation perimeter in one stage. Whereas, with 'Heading and Bench' operations, a top heading is typically driven down to the springline, and the lower bench excavated at some specified distance and time behind the advancing top heading. For general information gathering and pre-support techniques, smaller pilot headings are sometimes driven within the planned excavation perimeter of the portal. These pilot tunnels may be driven

for either Full-Face or Heading and Bench operations. For extremely difficult ground conditions, 'Multiple Drifts' may be driven around the perimeter of a portal excavation. Each drift is filled with concrete or used to provide some other rock support system before the center core is excavated. Finally, the last category of 'Natural', as in the previous section, refers to subsurface voids not made by man, such as caves, vugs, and lava tubes.

Figure 3-16 illustrates the distribution of the drivage sections. Unsurprisingly, with the heavy proportion of smaller mine and other types of portals, the 'Full-Face' section (62%) was the largest single category. This is followed by Heading and Bench (25%), 'Pilot w/Heading and Bench (5%), 'Multiple Drifts' (2%), 'Natural' features (2%), and 'Pilot w/Full-Face' (1%). 'Unavailable Information' only accounted for 3% of the cases.

3.5.18 Reference.

The final item included for each case history is the reference(s). A notation of 'Field Investigation' is included if the case history was studied in some detail by the author.

Table 3-11. Abbreviations for Drivage Methods.

#	DRIVAGE METHOD	ABBREVIATION
1.	Conventional	C
2.	Machine	M
3.	Hand	H
4.	Natural	N

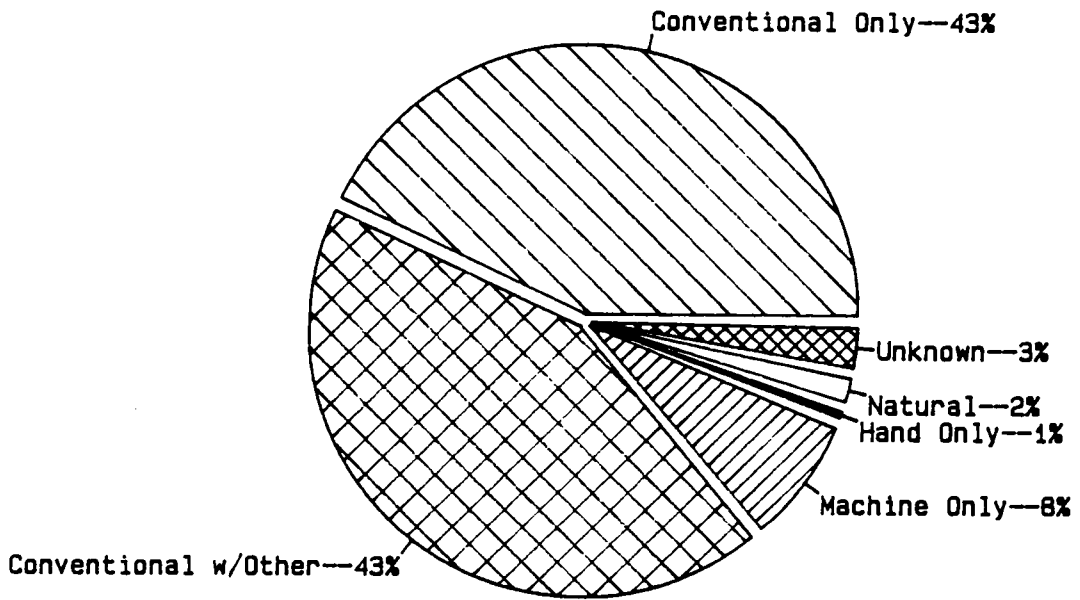

Drivage Methods

Figure 3-14. Portal Drivage Method Distribution.

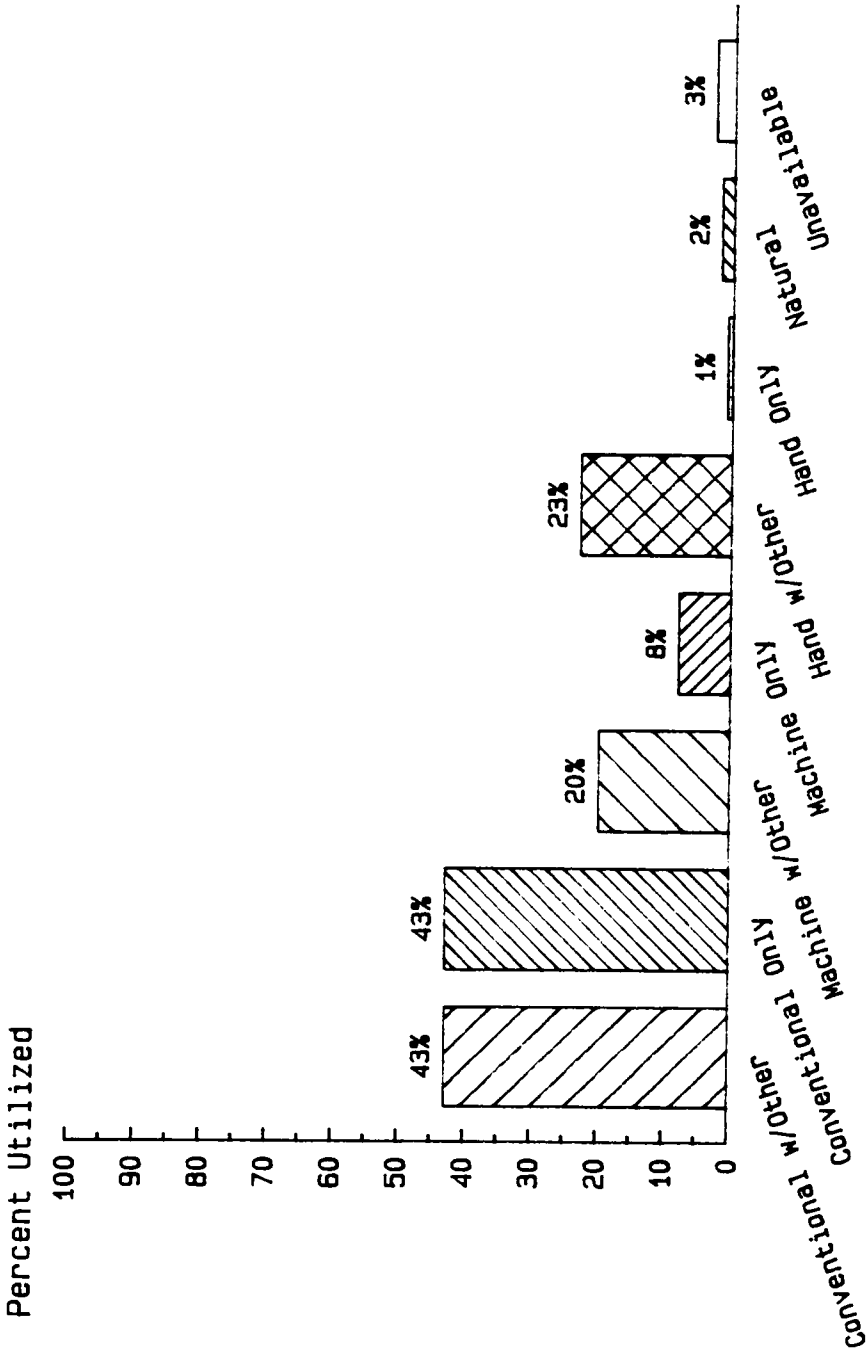

Drivage Methods NOTE: 500 portal database.

Figure 3-15. Portal Drivage Methods - Specific Breakdown.

Table 3-12. Abbreviations for Drivage Section.

#	DRIVAGE SECTION	ABBREVIATION
1.	Full-face	FF
2.	Heading and Bench	HB
3.	Pilot w/Full-Face	PFF
4.	Pilot w/Heading and Bench	PHB
5.	Multiple Drifts	M
6.	Natural	N

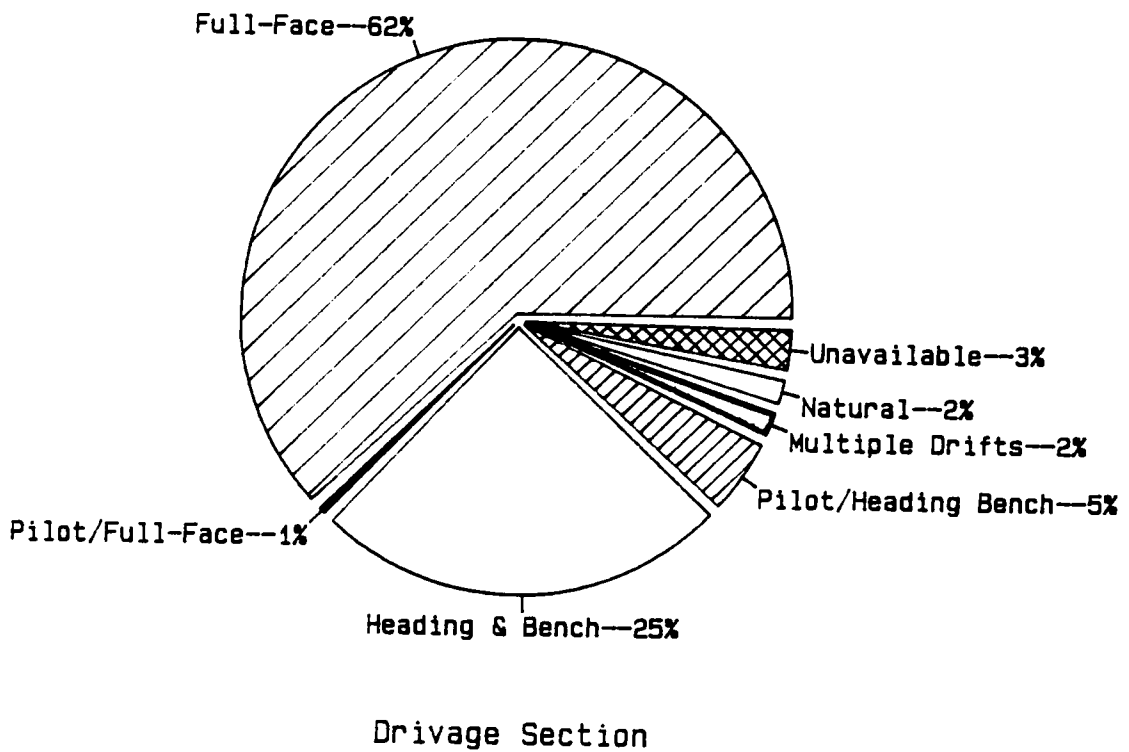

Figure 3-16. Portal Drivage Section Distribution.

4.0 PORTAL FAILURE CLASSIFICATION

A location-based portal failure classification system was developed from the database due to ease of documentation, practical application, and simplification. Most of the documentation obtained from the literature review and industry inquiries exists in a location-based format (e.g. roof fall, rib roll, floor buckling, etc.). Converting this data into another format (e.g. failure mechanism) would not be possible without an inordinate amount of extrapolation and hence, extreme error. Furthermore, describing failures by their location is both practicable and extremely understandable in terms of industry application. Also, the discussion of design techniques and excavation/support guidelines is greatly simplified.

The eight location-based failure classifications have been divided into either external or internal categories. External failures involve the portal approach cut and surrounding slopes, while internal failures involve the portal face and entry. The failure types that could logically fit in both groupings are categorized via consideration of the more serious consequences that result from the failure.

4.1 External Failure Types

The external types consist of the 'Overall Mass Slide', 'Upper Slope Slide', 'Outer Rib Slide', and 'Subsidence/Collapse' failure classifications.

4.1.1 Overall Mass Slide.

One of the least common types of portal failure, yet most disastrous, is the 'Overall Mass Slide'. In this type of failure the entire slope or highwall surrounding the portal fails. Figure 4-1 illustrates this type of failure. Very few options exist as to a solution for this type of failure other than abandonment and re-alignment, as was the case in the railroad tunnel in New Zealand shown in Figure 4-2 (Zaruba, et al, 1969; after Benson, 1940) and in the Unterstein Tunnel shown in Figure 4-3 (Zaruba, et al, 1969; after Wagner, 1884). However, Figure 4-4 illustrates how a special reinforced concrete brace was utilized to stabilize the Pontesei Reservoir Tunnel Portal (Zaruba, et al, 1969; after Capra, et al, 1960). Sometimes it may be possible to unload the upper slope area and thereby reduce the overall driving force of the slide. This technique was used to successfully stabilize the James River Limestone Quarry failure illustrated in Figure 4-5. Today, carefully planned exploration and investigative techniques tend to alleviate this problem.

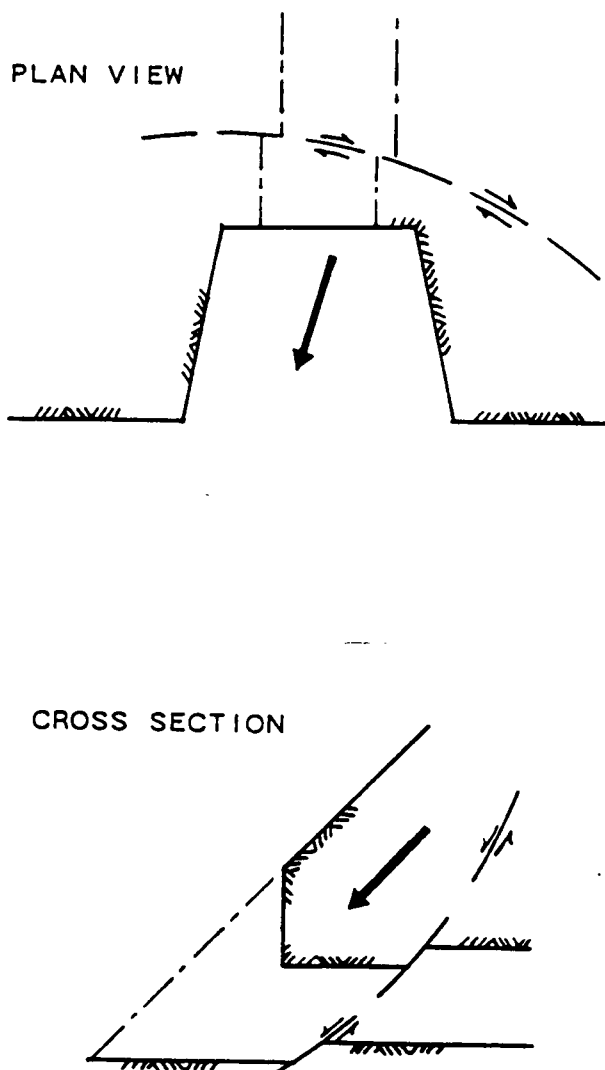

Figure 4-1. Cross Sectional (Portal Centerline Axis) and Plan View of the Portal Overall Mass Slide Failure.

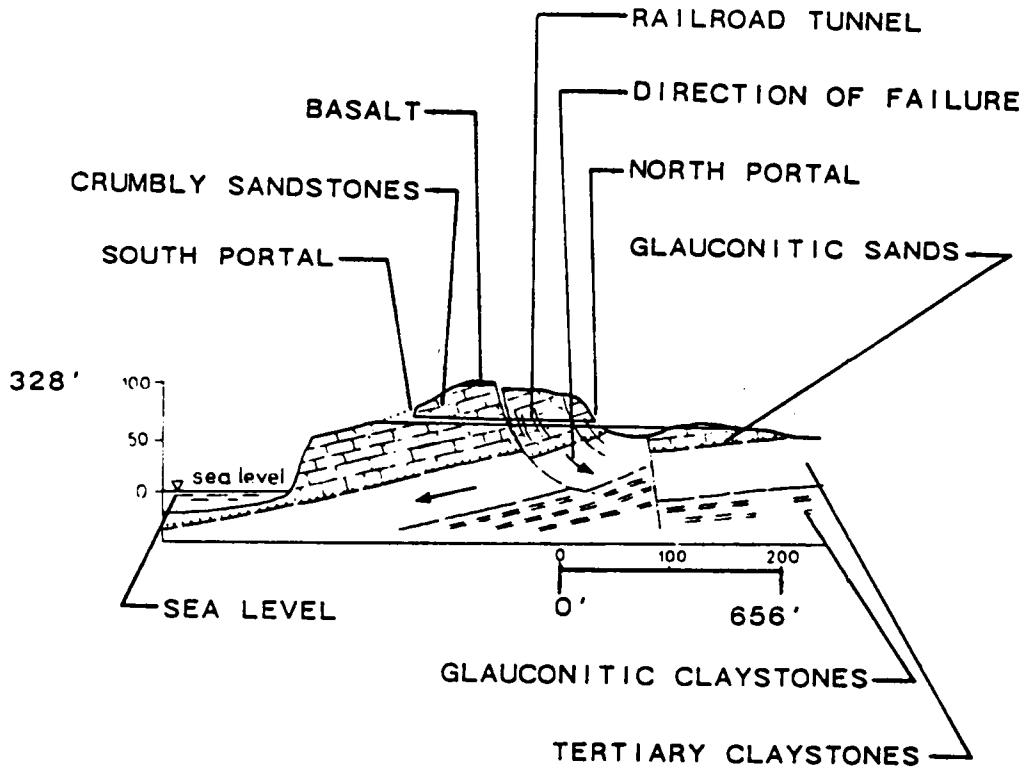

Figure 4-2. Portal Overall Mass Slide Failure of a Railroad Tunnel in New Zealand (Zaruba, et al, 1969; after Benson, 1940).

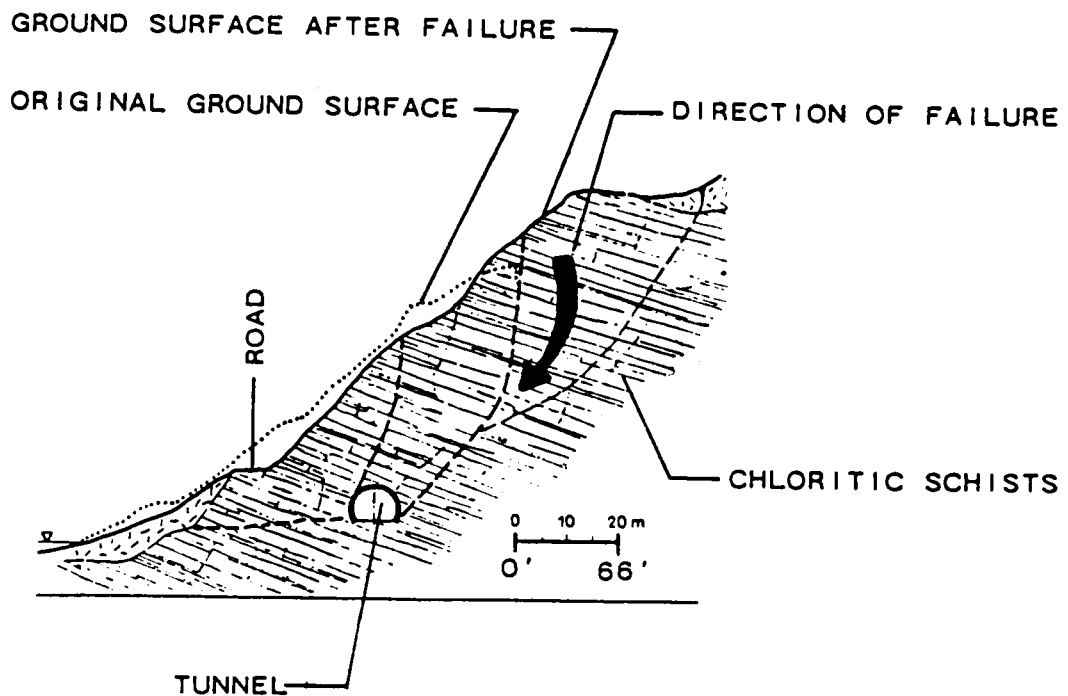

Figure 4-3. Cross Section of the Unterstein Tunnel Overall Mass Failure (Zaruba, et al, 1969; after Wagner, 1884).

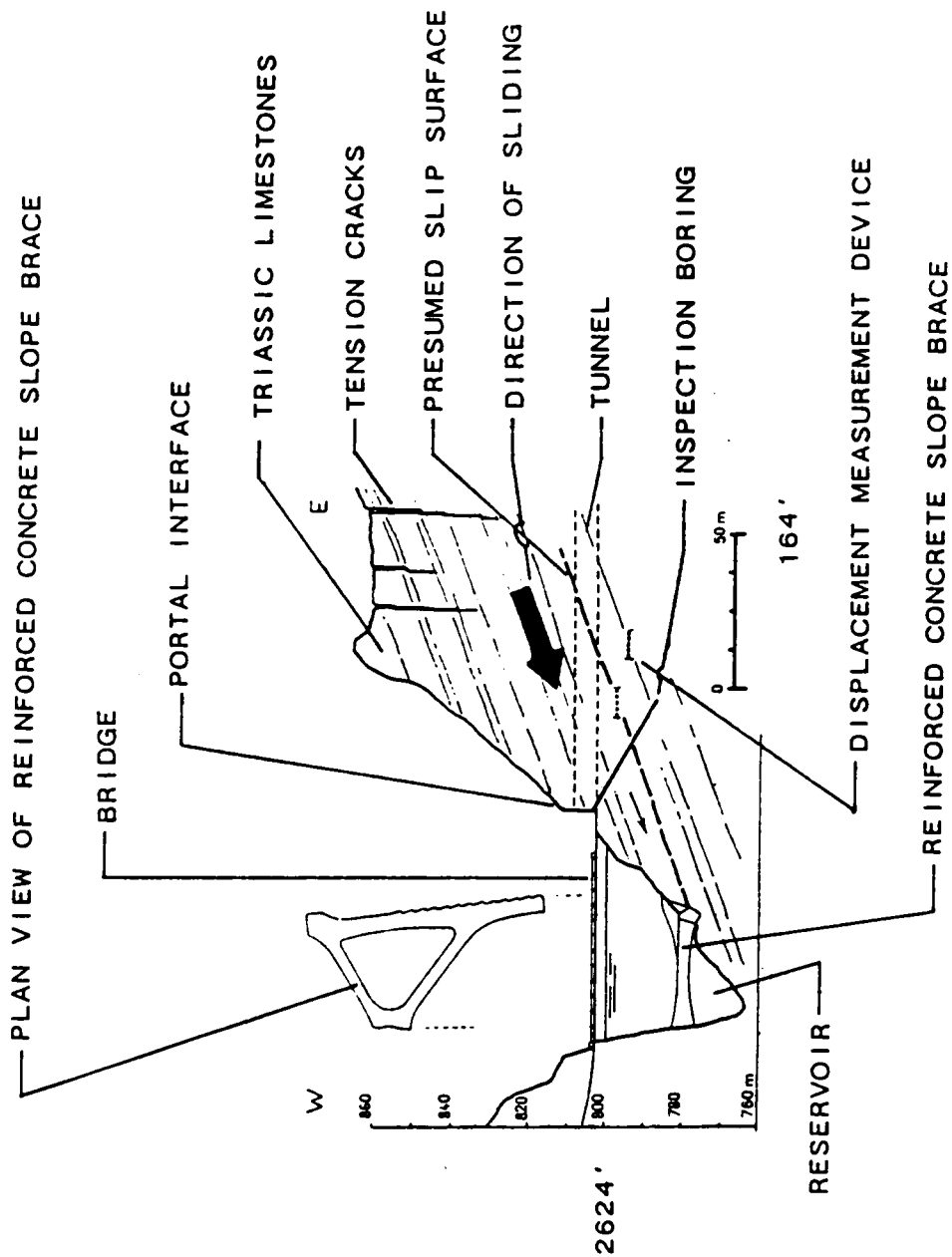

Figure 4-4. Portal Overall Mass Slide Failure of the Pontesei Reservoir Tunnel (Zaruba, et al, 1969; after Capra, et al, 1960).

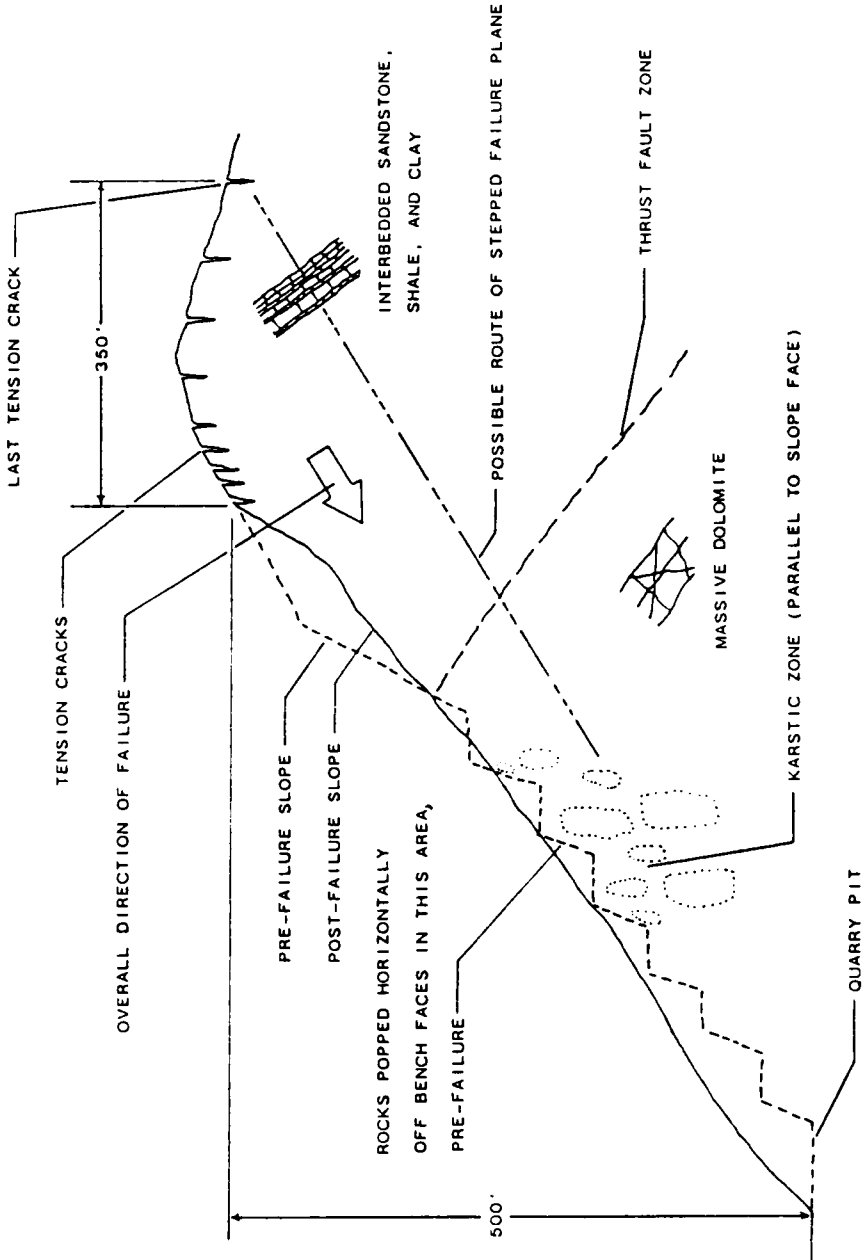

Figure 4-5. Overall Portal Failure of the James River Limestone Quarry Natural Portals (Rogers, et al, 1987).

4.1.2 Upper Slope Slide.

The 'Upper Slope Slide' type of failure is normally initiated by undercutting the toe of a slope, as noted in the following excerpt (Szechy, 1966):

"Conditions are especially unfavorable where weathered, loose, fractured layers slope toward the portal. If these are pierced by an approach cutting before a sufficiently resistant tunnel portal structure is built, the entire slope may be mobilized and sliding can no longer be arrested."

The slide usually extends from the crown face to a release surface such as a major joint or tension crack on the upper slope. All major types of rock slides (e.g. plane, rotational, wedge, toppling, buckling, etc.) may be encountered within this failure classification, although the typically short length of exposed slope helps prevent a greater number and extent of these failures. Refer to Figures 4-6 to 4-8. Ravelling and isolated rock falls from the upper slope, which result from weathering and freeze-thaw action and is basically considered a long-term maintenance problem, are also included within this classification.

The most serious concern with this type of failure is the threat of trapping men underground from slide material blocking the portal entry. An example of this occurred at the Drummond Coal Company of Nova Scotia, on May 15, 1968.

A rock fall at the main portal entrance trapped 49 men underground. Fortunately, no one was injured and the men were able to walk one mile to the only other exit, an air shaft, where they were lifted, three at a time, in a muck bucket to the surface (Beckley Post-Herald, 1968). If there had been multiple entries, this problem may not have been as serious; however, it is quite conceivable for a large rock slide to cover and/or collapse several portals if they are relatively close together.

Scaling, shotcrete, bolted wire mesh, cable anchors, buttresses, rock bolts, warning screens, and portal canopies are just a few of the methods that have been used to alleviate the 'Upper Slope Slide'. Generally, proper rock slope design and support measures, if necessary, will mitigate the potential for this failure; however, in the case of abandoned portals, such as those illustrated in Figure 4-9, failure prediction may be difficult due to previous blasting damage.

It should be noted at this point that the mere process of installing some of the abovementioned types of specialized ground control measures can be difficult and dangerous, sometimes resulting in fatalities (U.S. Department of Labor, 1986).

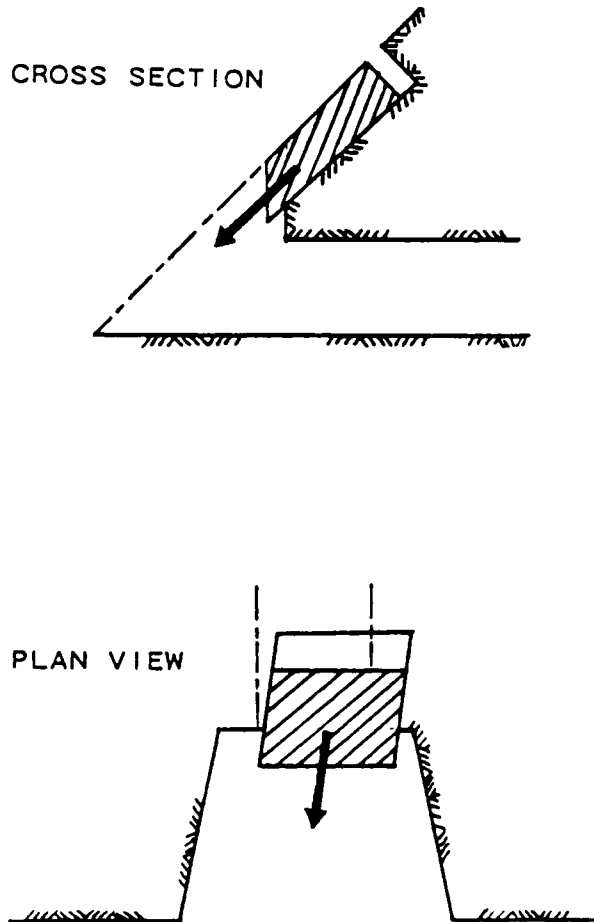

Figure 4-6. Cross Sectional (Portal Centerline Axis) and Plan View of the Portal Upper Slope Slide Failure.

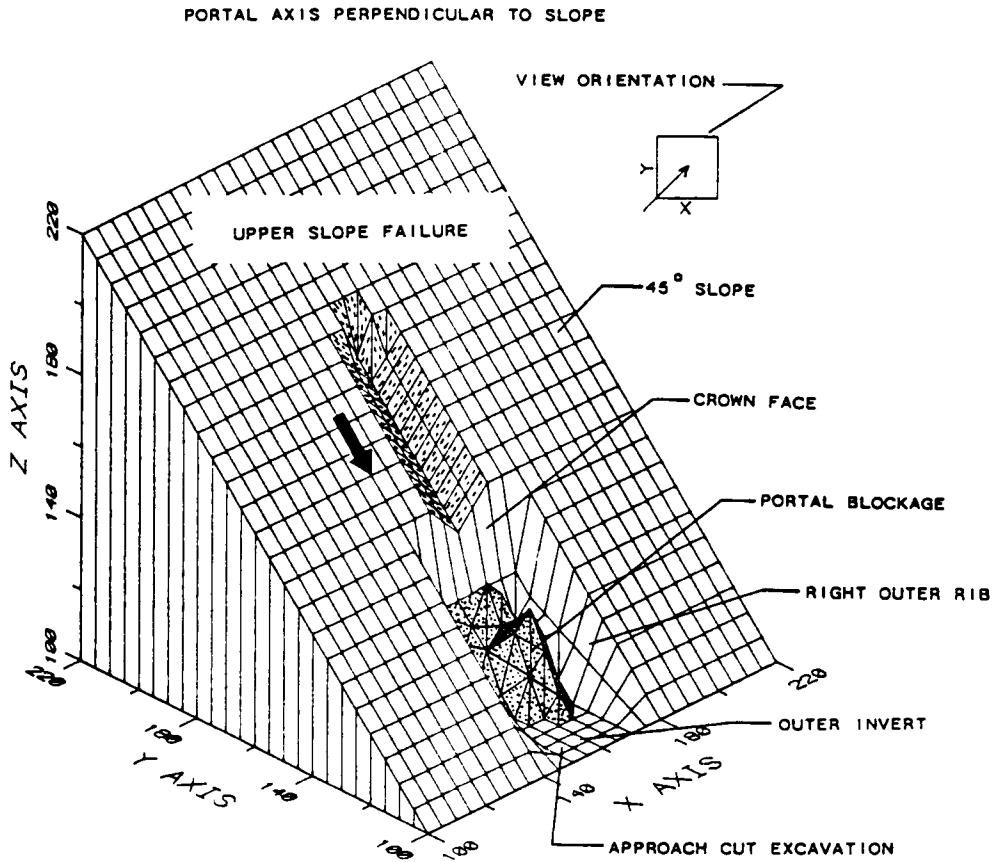

Figure 4-7. 3-D View of a Portal Upper Slope Slide in a 45° Slope.

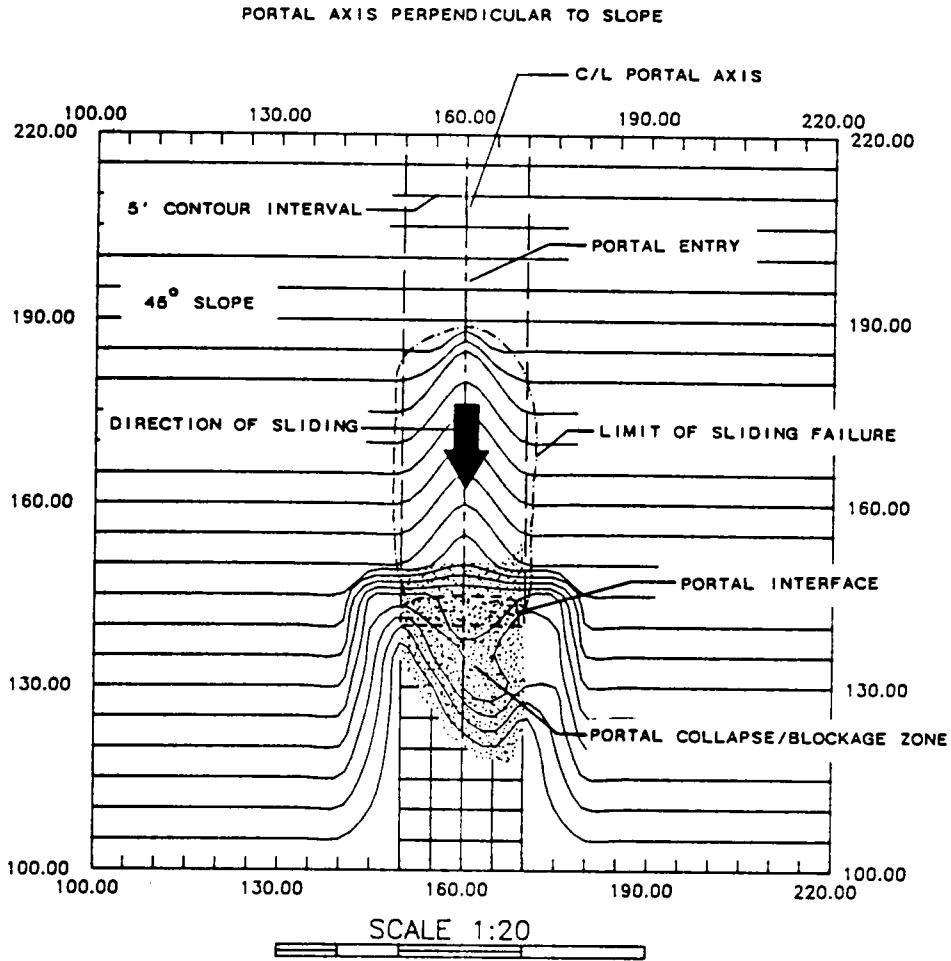

Figure 4-8. Plan View of a Portal Upper Slope Slide in a 45° Slope.

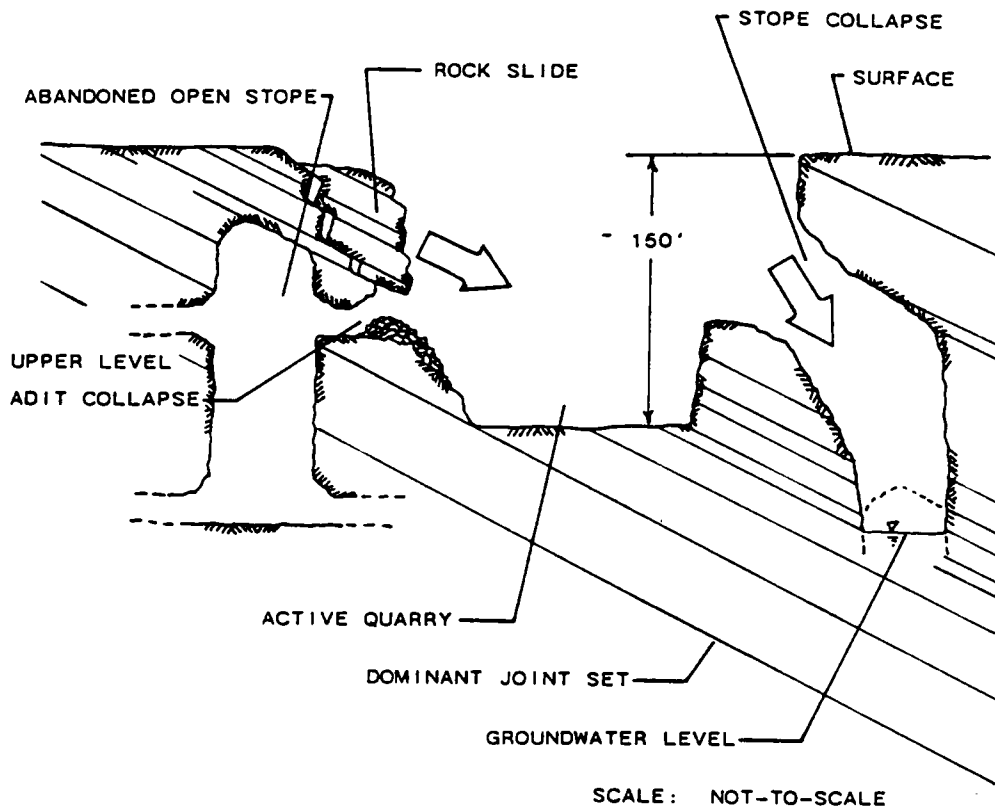

Figure 4-9. Cross Sectional View of a Portal Upper Slope Slide at a Dolomite Quarry Above Abandoned Underground Workings.

4.1.3 Outer Rib Slide.

Since the portal approach cut is comprised of the outer ribs, the width of slope is commonly much greater than that of the upper slope, thus allowing for larger and more diverse types of failure; however, this failure is usually not as serious as the other types. The 'Outer Rib Slide' failure is illustrated in Figures 4-10 to 4-12. All major types of rock slides may be represented, with wedge and plane failures being the most commonly encountered. An example of an 'Outer Rib' plane failure occurred during the construction of the Irono railroad tunnel, Virginia. Ravelling of the outer ribs, like the upper slope ravelling, normally constitutes a long term maintenance problem and is included within this classification.

This type of failure is generally mitigated in similar fashion to that of the 'Upper Slope Slide' failure. The key difference is that the outer ribs, due to their typically longer reach and greater surface area, require more support and drainage provisions.

CROSS SECTION

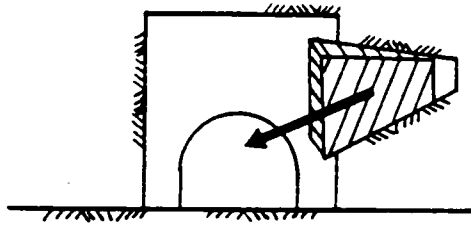

PLAN VIEW

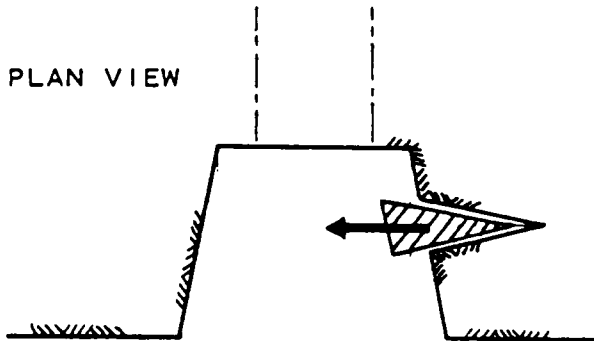

Figure 4-10. Cross Sectional (Perpendicular to Portal Centerline Axis) and Plan View of the Outer Rib Failure.

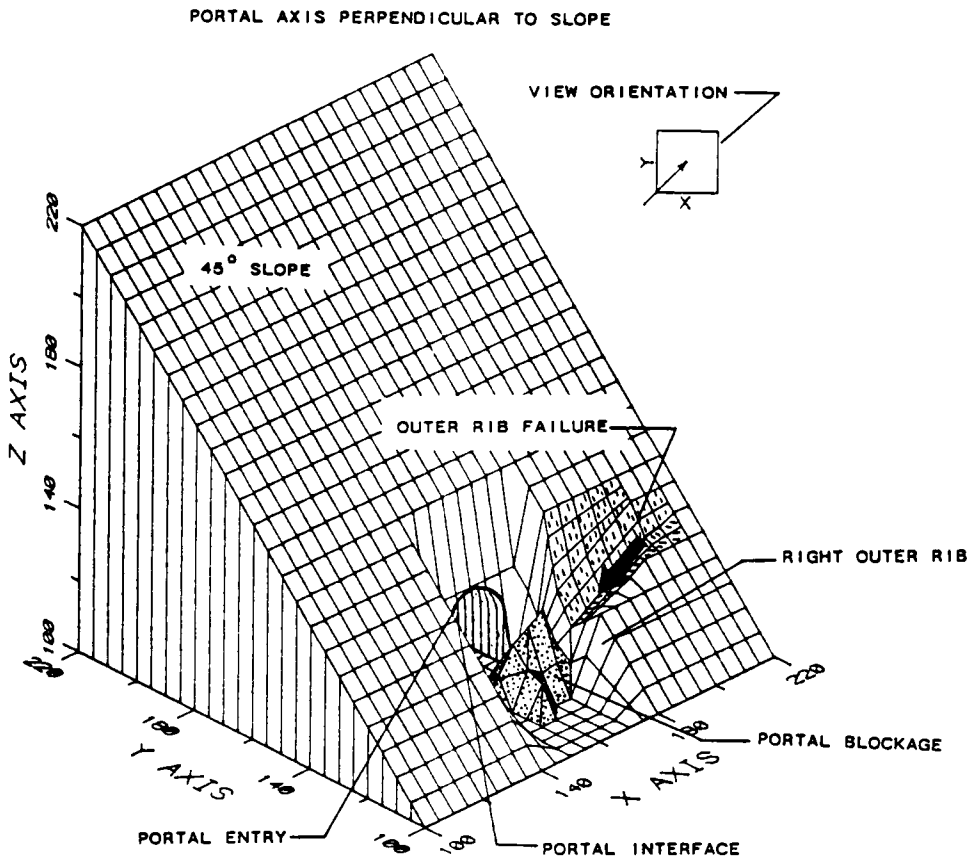

Figure 4-11. 3-D View of an Outer Rib Failure in the Right Outer Rib of a Portal Approach Cut in a 45° Slope.

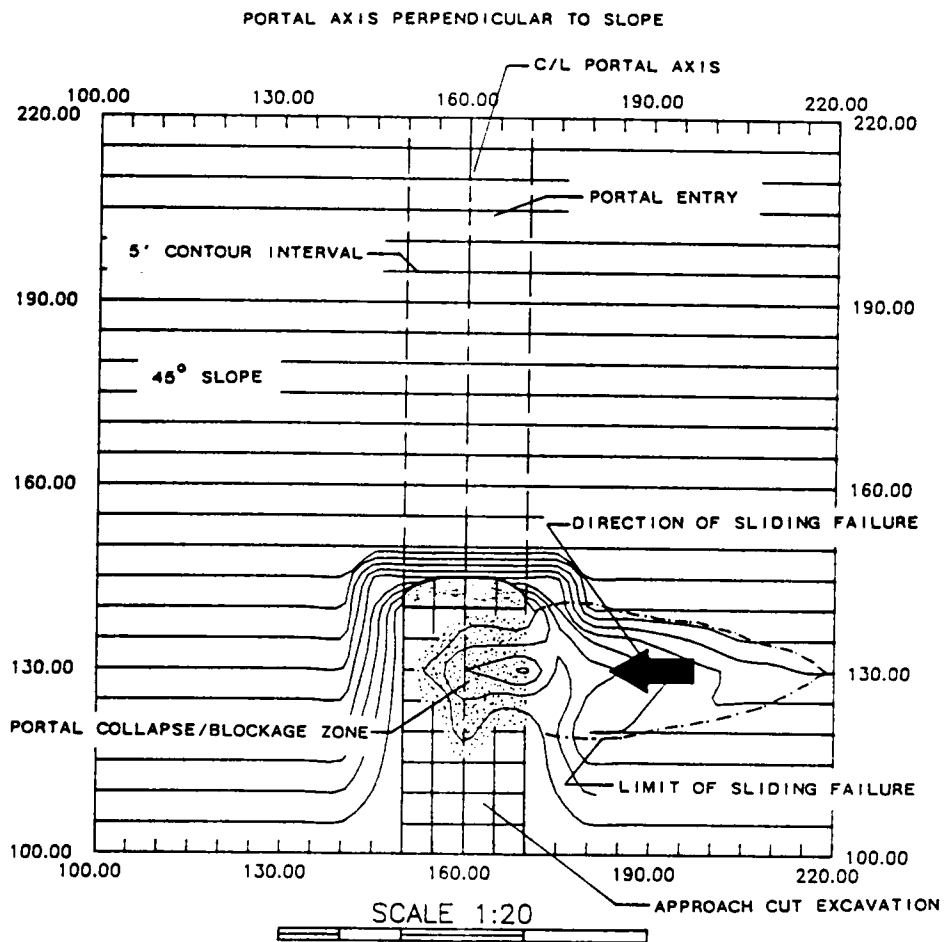

Figure 4-12. Plan View of an Outer Rib Failure in the Right Outer Rib of a Portal Approach Cut in a 45° Slope.

4.1.4 Upper Slope Subsidence/Collapse.

The 'Upper Slope Subsidence/Collapse' failure, illustrated in a myriad of guises in Figures 4-13 to 4-27, is more commonly encountered in older, abandoned portals. Failure may include sections of the outer ribs, and typically encompasses the crown and rib faces, extending to a point on the upper and lower slopes where the overburden inhibits further deformation.

Figures 4-14 to 4-22 illustrate the initial stages of a 'Subsidence/Collapse' failure, which is often preceded by 'Crown Face Overbreak' failure as in the case of several of the portals at the Low Moor limestone mine (similar to Figures 4-14 to 4-16), and portals at the Birch Coal Mine, West Virginia (similar to Figures 4-17 to 4-19). This type of failure has also been initiated via seismic shock of underground explosions (Dillon, 1976) and the breakthrough of tunnel boring machines (Santa Clara Tunnel, Field Investigation).

If the initial subsidence/collapse failure is allowed to progress, the long-term expression of this type of failure takes on smoother topographical characteristics as illustrated in Figures 4-23 to 4-27. For example, the abandoned coal mine portals at Ames, West Virginia (Seijo, 1988) had subsidence troughs similar to those shown in Figures 4-23 and 4-24. Figures 4-25 to 4-27 are similar to the surface expression of the Coal Bank Hollow case history

(e.g. inclined, abandoned drift).

Inadequate support and deteriorating rock mass conditions are the primary reasons for this type of failure. Older, abandoned coal mine portals are a good example (e.g. roof material sloughing from around bolts, timber/cribs failing, and pillars/ribs sloughing). Without complete backfill upon abandonment, these portals that are located in typical coal measures strata can be expected to fail, unless prevented by units in the overlying strata or some massive type of portal support such as a thick reinforced concrete portal lining or structure (Seijo, 1988).

Backfilling to form a seal is the preferred method for mitigating this type of failure for abandoned portals (Seijo, 1988; Skelly and Loy, 1973; U.S. Dept of the Interior/OSM, 1983). Sufficient turn-under depths and sufficient support will mitigate failure for new and existing portals.

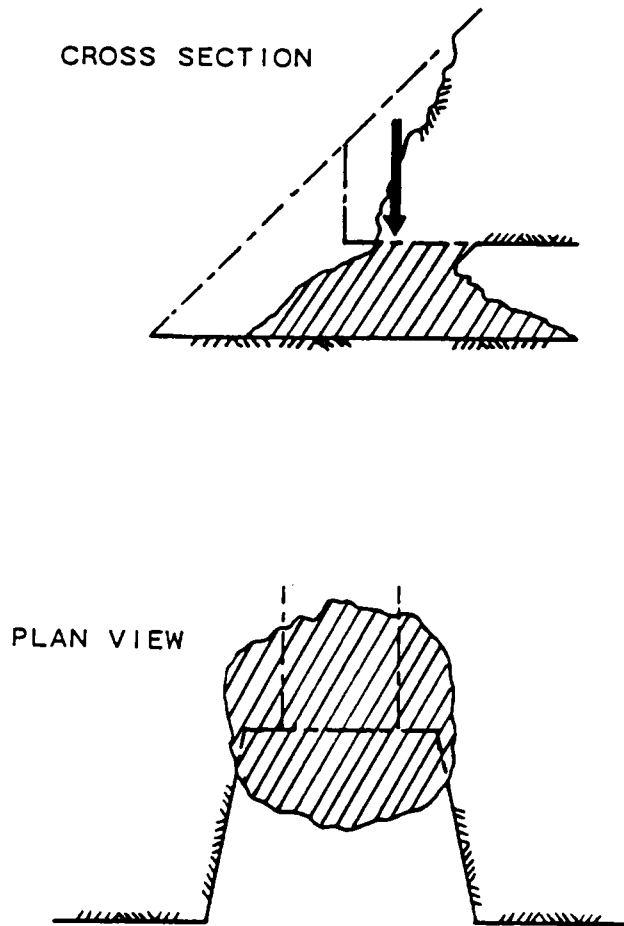

Figure 4-13. Cross Sectional (Portal Centerline Axis) and Plan View of the Upper Slope Subsidence/Collapse Failure.

PORTAL AXIS PARALLEL TO SLOPE

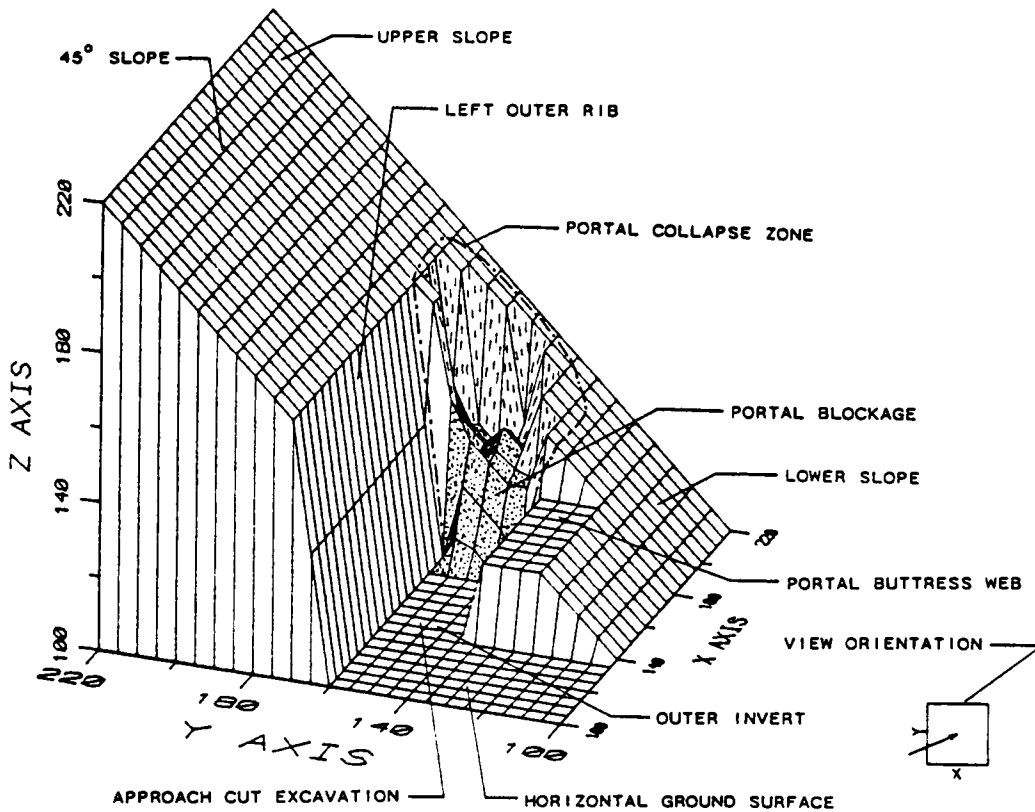

Figure 4-14. 3-D View of the Initial Subsidence/Collapse Failure of a Portal Driven Parallel to a 45° Slope.

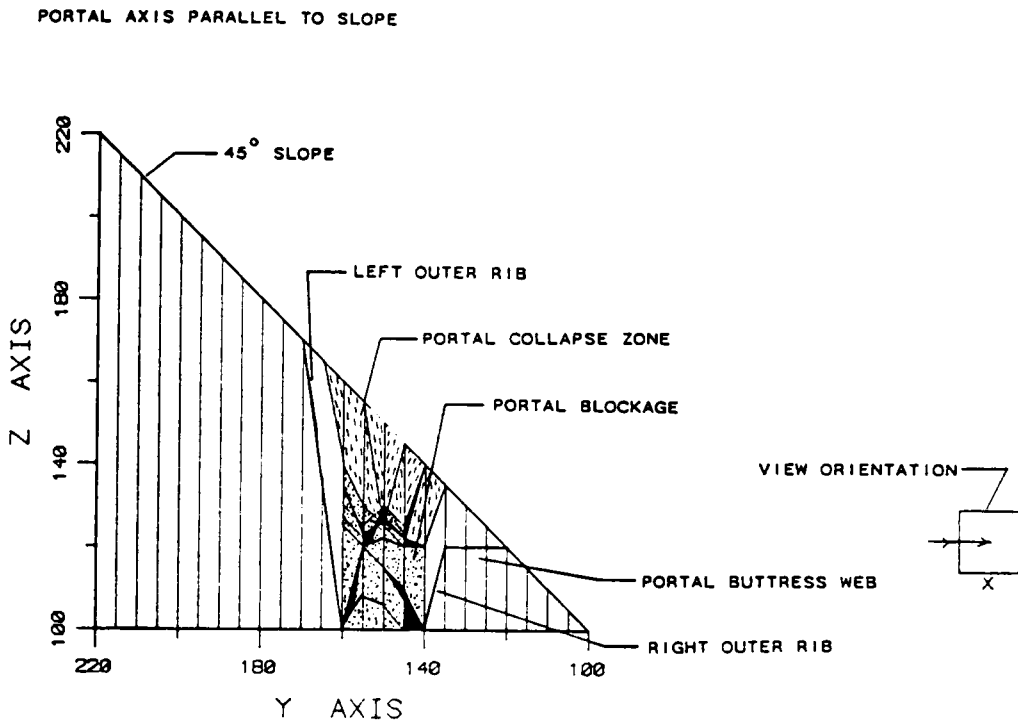

Figure 4-15. Cross Sectional (Perpendicular to Portal Centerline Axis) View of the Initial Subsidence/Collapse Failure of a Portal Driven Parallel to a 45° Slope.

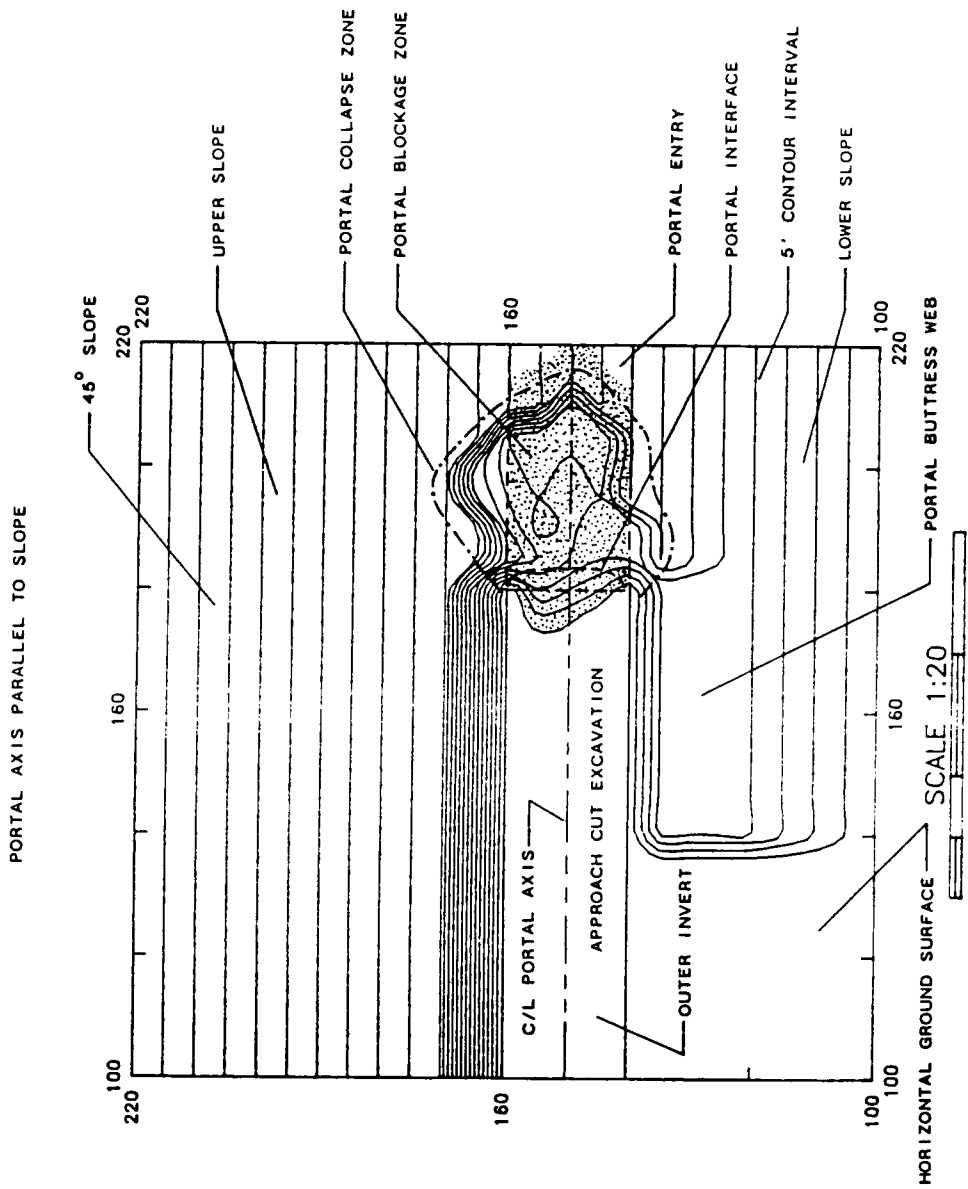

Figure 4-16. Plan View of the Initial Subsidence/Collapse Failure of a Portal Driven Parallel to a 45° Slope.

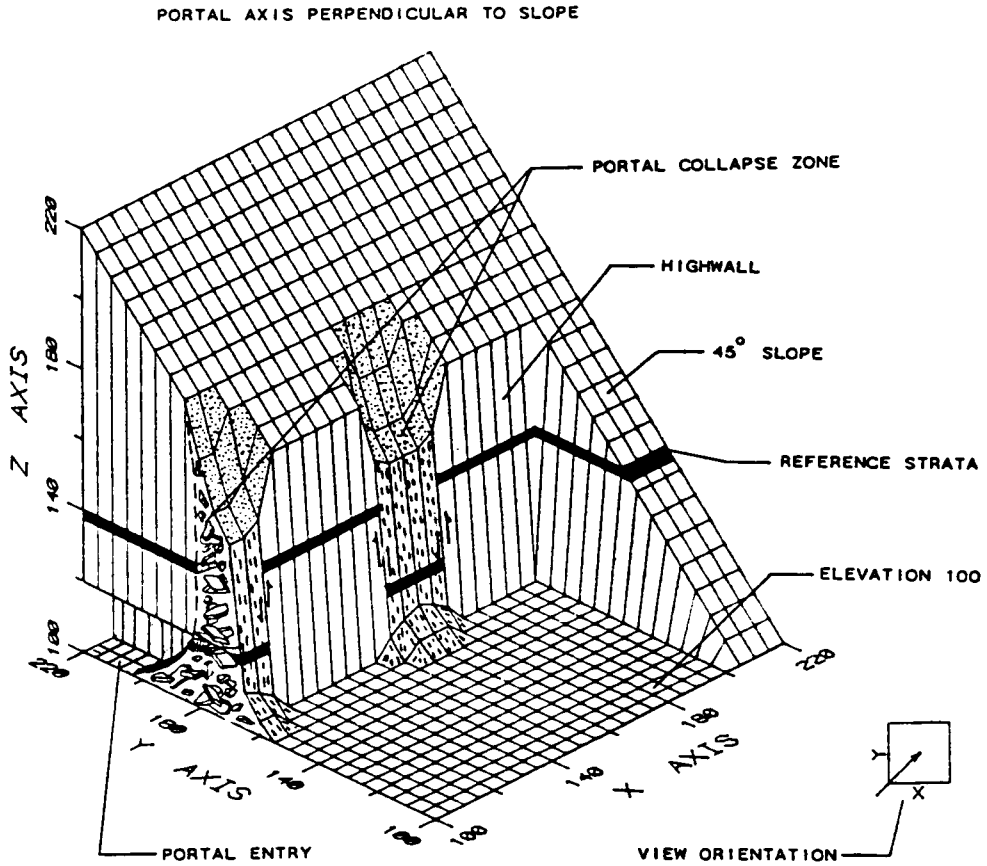

Figure 4-17. 3-D View of Subsidence/Collapse Failures of Portals Driven into a Highwall.

PORTAL AXIS PERPENDICULAR TO SLOPE

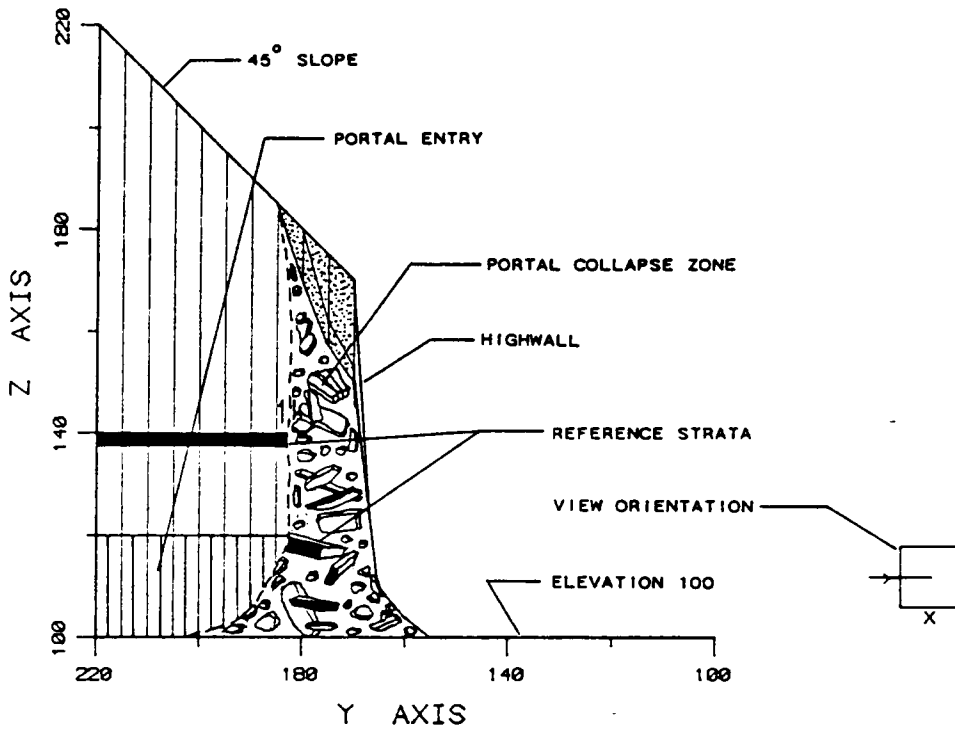

Figure 4-18. Cross Sectional (Portal Centerline Axis) View of Subsidence/Collapse Failures of Portals Driven into a Highwall.

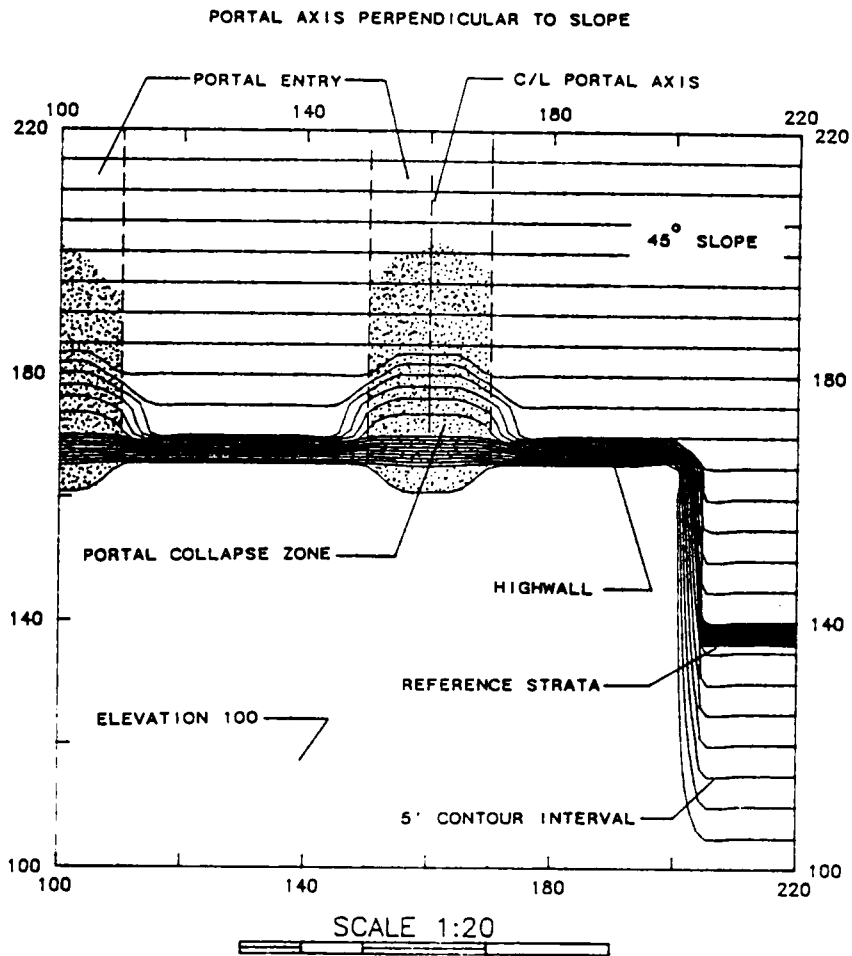

Figure 4-19. Plan View of Subsidence/Collapse Failures of Portals Driven into a Highwall.

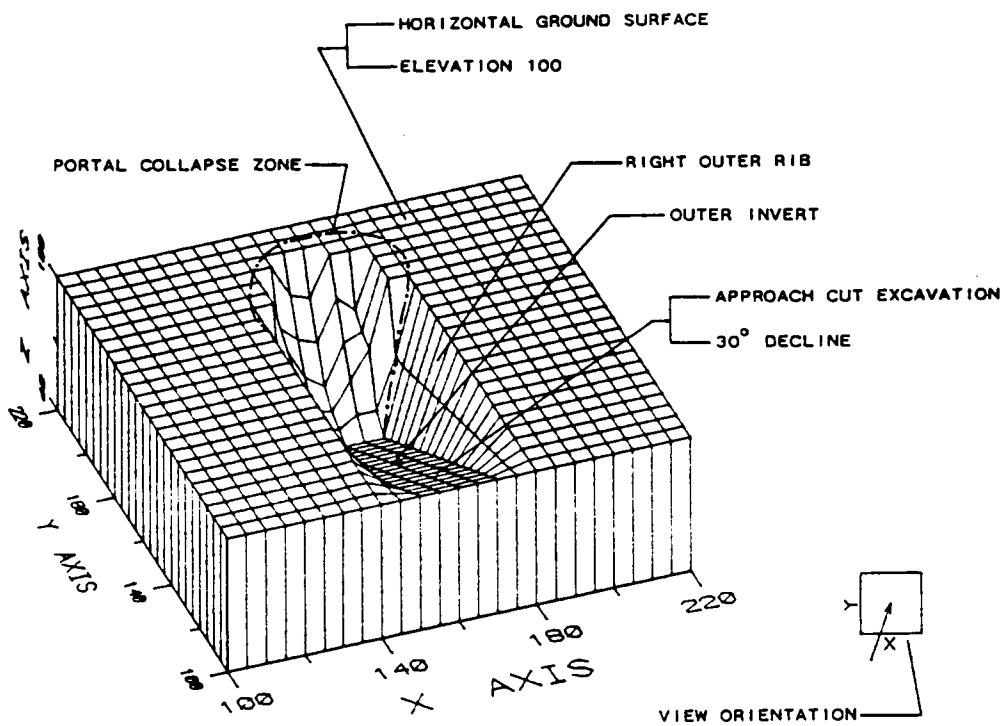

Figure 4-20. 3-D View of the Initial Subsidence/Collapse Failure of an Inclined Portal (-30°) Driven from a Horizontal Surface.

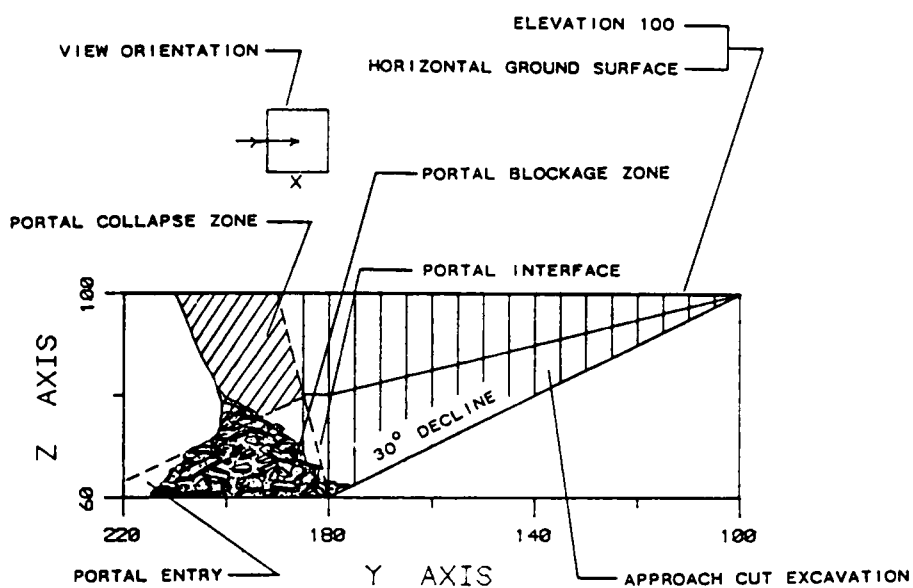

Figure 4-21. Cross Sectional (Portal Centerline Axis) View of the Initial Subsidence/Collapse Failure of an Inclined Portal (-30°) Driven from a Horizontal Surface.

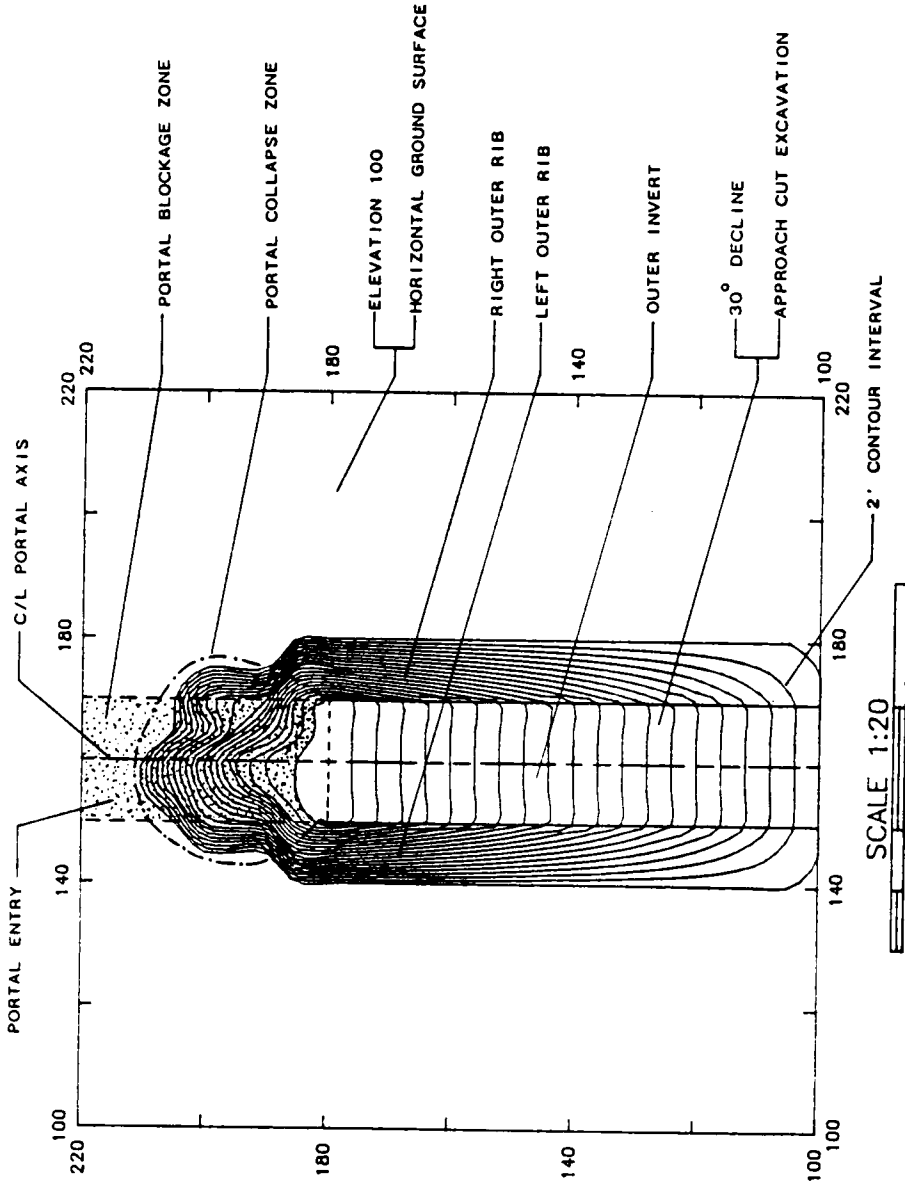

Figure 4-22. Plan View of the Initial Subsidence/Collapse Failure of an Inclined Portal (~30°) Driven from a Horizontal Surface.

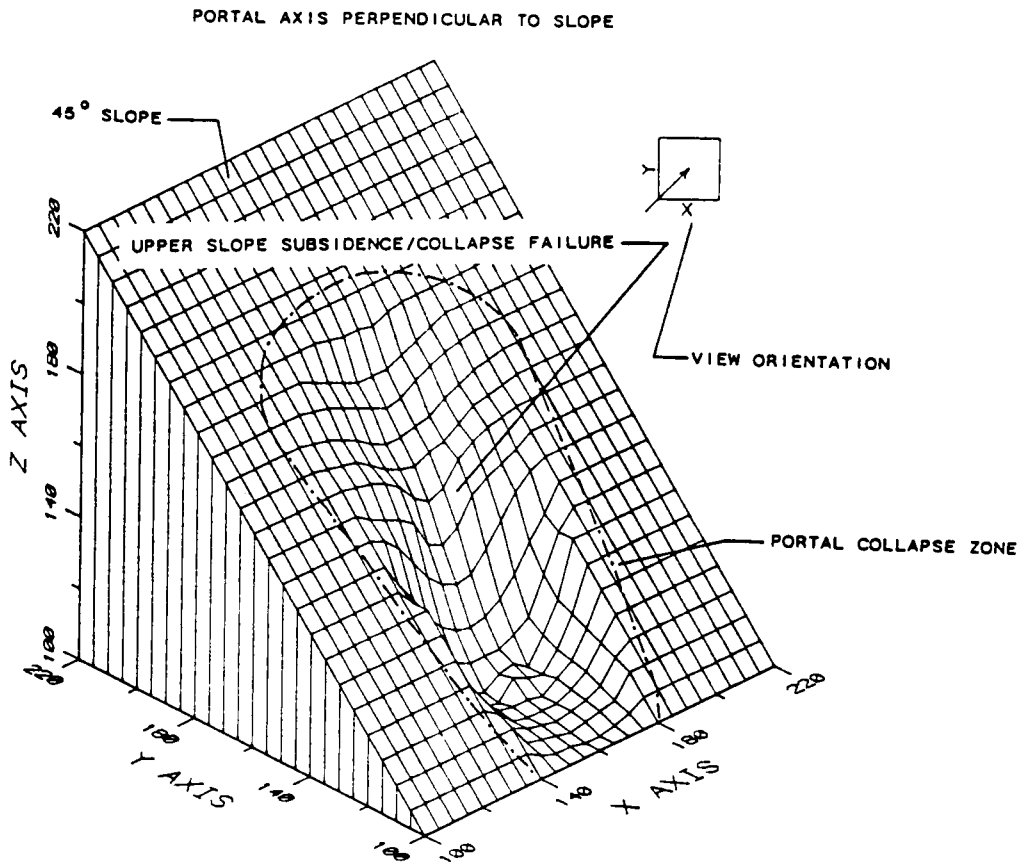

Figure 4-23. 3-D View of the Long-Term Subsidence/Collapse Failure of an Abandoned Portal in a 45° Slope Illustrating a Typical Portal Subsidence Trough.

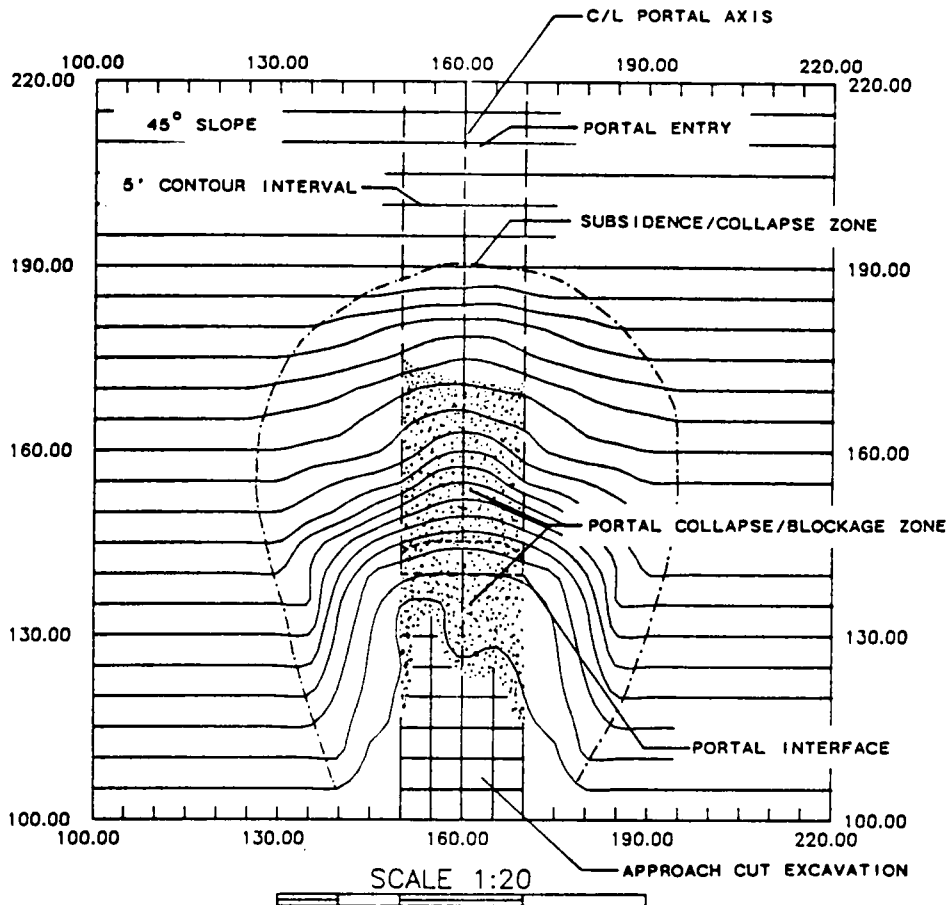

Figure 4-24. Plan View of the Long-Term Subsidence/Collapse Failure of an Abandoned Portal in a 45° Slope Illustrating a Typical Portal Subsidence Trough.

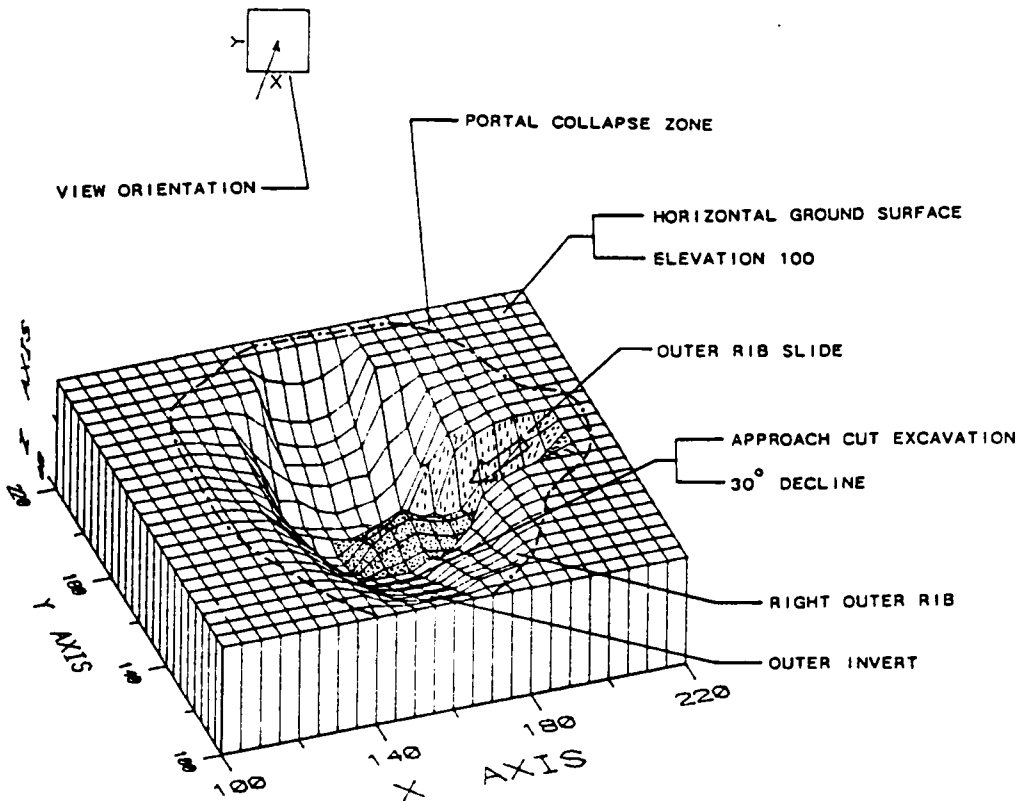

Figure 4-25. 3-D View of the Long-Term Subsidence/Collapse Failure of an Abandoned, Inclined Portal (-30°) Driven from a Horizontal Surface.

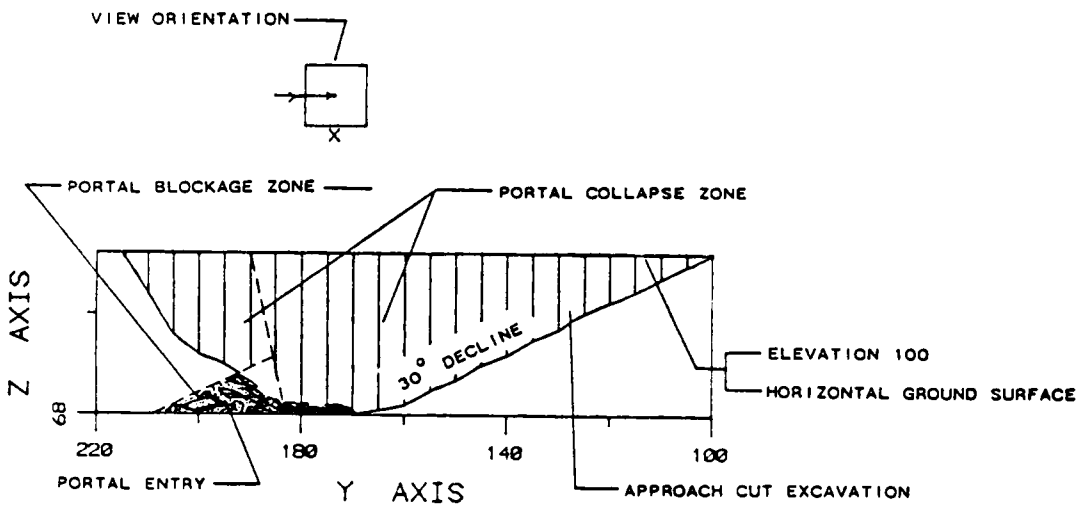

Figure 4-26. Cross Sectional (Portal Centerline Axis) View of the Long-Term, Subsidence/Collapse Failure an Abandoned, Inclined Portal (-30°) Driven from a Horizontal Surface.

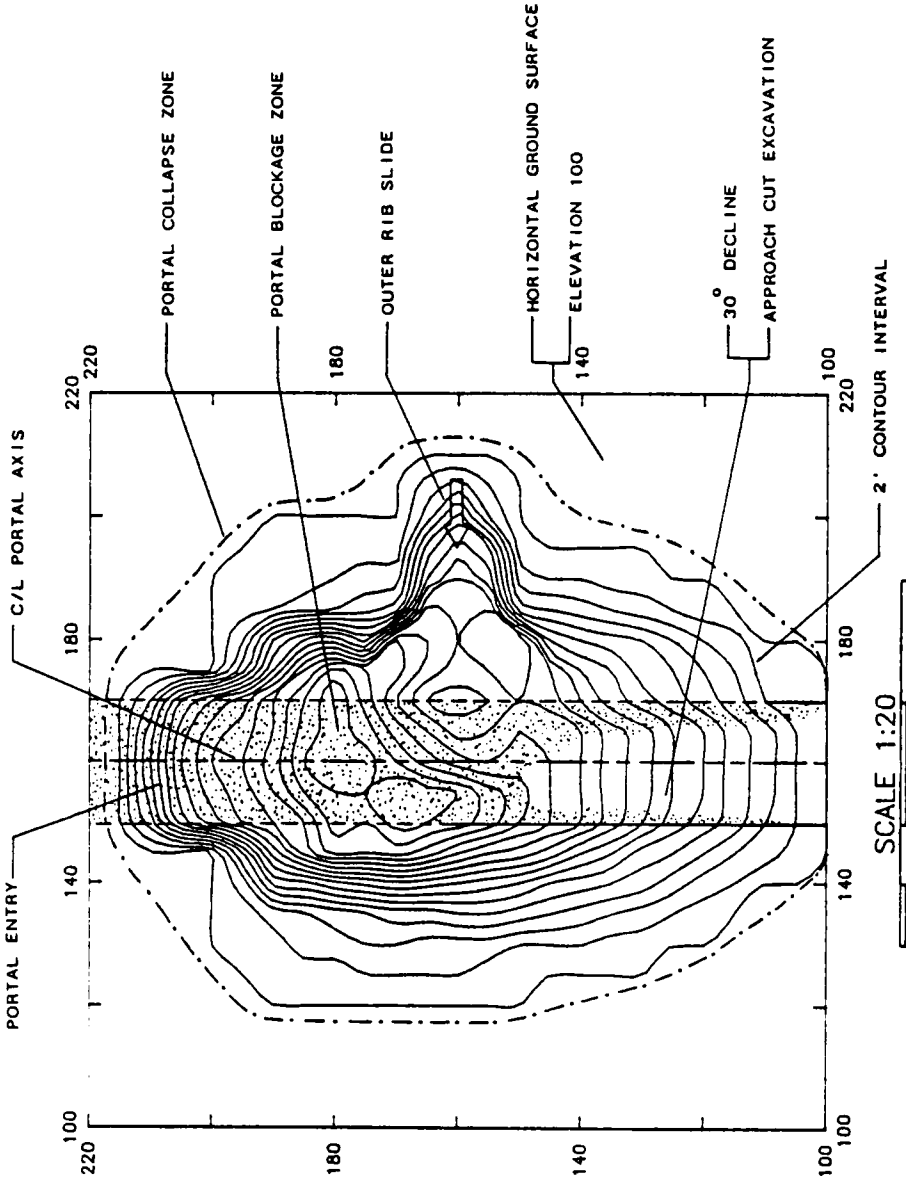

Figure 4-27. Plan View of the Long-Term Subsidence/Collapse Failure of an Abandoned, Inclined Portal (-30°) Driven from a Horizontal Surface.

4.2 Internal Failure Types

The internal types consist of the 'Crown Face Overbreak', 'Internal Collapse', 'Invert', and 'Seal Rupture' failure classifications.

4.2.1 Crown Face Overbreak.

'Crown Face Overbreak' is probably the most common and yet least reported type of portal failure. It may suddenly occur as one or two large intact blocks dropping from the crown after the first few rounds or excavation cuts into a prepared portal face, or it may occur very slowly, taking years for individual pieces to loosen and fall. The failure commonly proceeds upward from the crown of the excavation to some point on the crown face. Refer to Figure 4-28. As expected, the discontinuity characteristics of the rock mass strongly influence this type of failure. Comments from industry note that excessive overbreak in this area is quite common and can be very troublesome, but is rarely considered in support design.

Even in structures that have been completed, evidence of loading from this type of failure can be found. For example, field investigations of several road and rail tunnels with concrete linings have noted that the 'Crown Face Overbreak' zone commonly has more fractures/cracks

than areas further inby, thus possibly indicating an unusually stressed area. Also noteworthy, is that similar problems are frequently experienced in shaft station insets and intersections of tunnels in underground power stations. Early miners were also plagued by this failure, as it limited the extent of mining as illustrated in Figure 4-29 (Temple, 1972).

Another related and interesting type of damage, acknowledged in the literature, but no longer to be found due to modernization of rail locomotives in the early 1960's, is that of blast damage in the crown area of brick lined tunnels. An example of this was found in the famous 'Big Bend Tunnel' near Talcott, West Virginia, during an upgrade in 1932. This is the tunnel of the legendary 'John Henry' and the contest against a steam driven drill during construction in the 1870's. The tunnel was lined with brick between 1881 and 1893 due to several sizable roof falls in the shale and sandstone strata. At the time of the 1932 upgrade, the portal blast wear was the only noticeable damage to the tunnel (Railway Age, 1937). It is still possible to see the residual effects of this particular damage in some railroad tunnel portals, thus necessitating its mention and overall relevance to this study.

The cost resulting from 'Crown Face Overbreak' failure can range from a minimal time loss from re-support of the

crown face to a major project delay from life and/or equipment loss. An example of major equipment loss is that of a portal at De Gray Dam where two, three-deck drill jumbos were completely crushed by a massive 'Crown Face Overbreak' failure, necessitating a complete re-design of the initial excavation and support system (Craig and Brockman, 1971). Similar problems were observed at one of the portals of the Laurel Mountain Mine, where the excavation method and support system had to be modified after several collapses during the turning under process (Decker, 1988). It should be noted at this point that due to the limited and always crowded working area that most portals present, personnel fatalities or serious injuries are possible from all classes of portal failure. 'Crown Face Overbreak' failure is discussed in greater detail in Section 6.

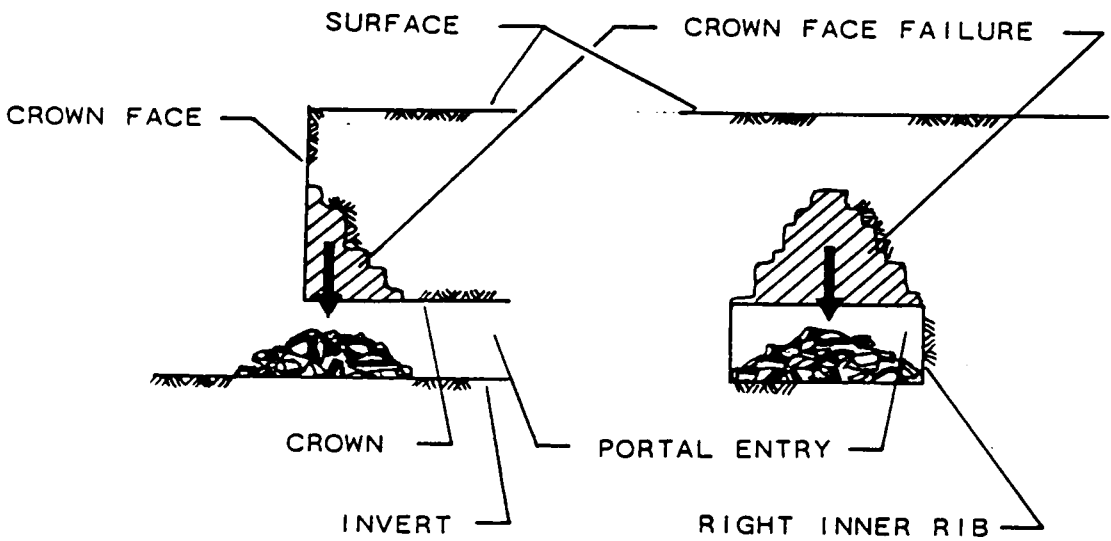
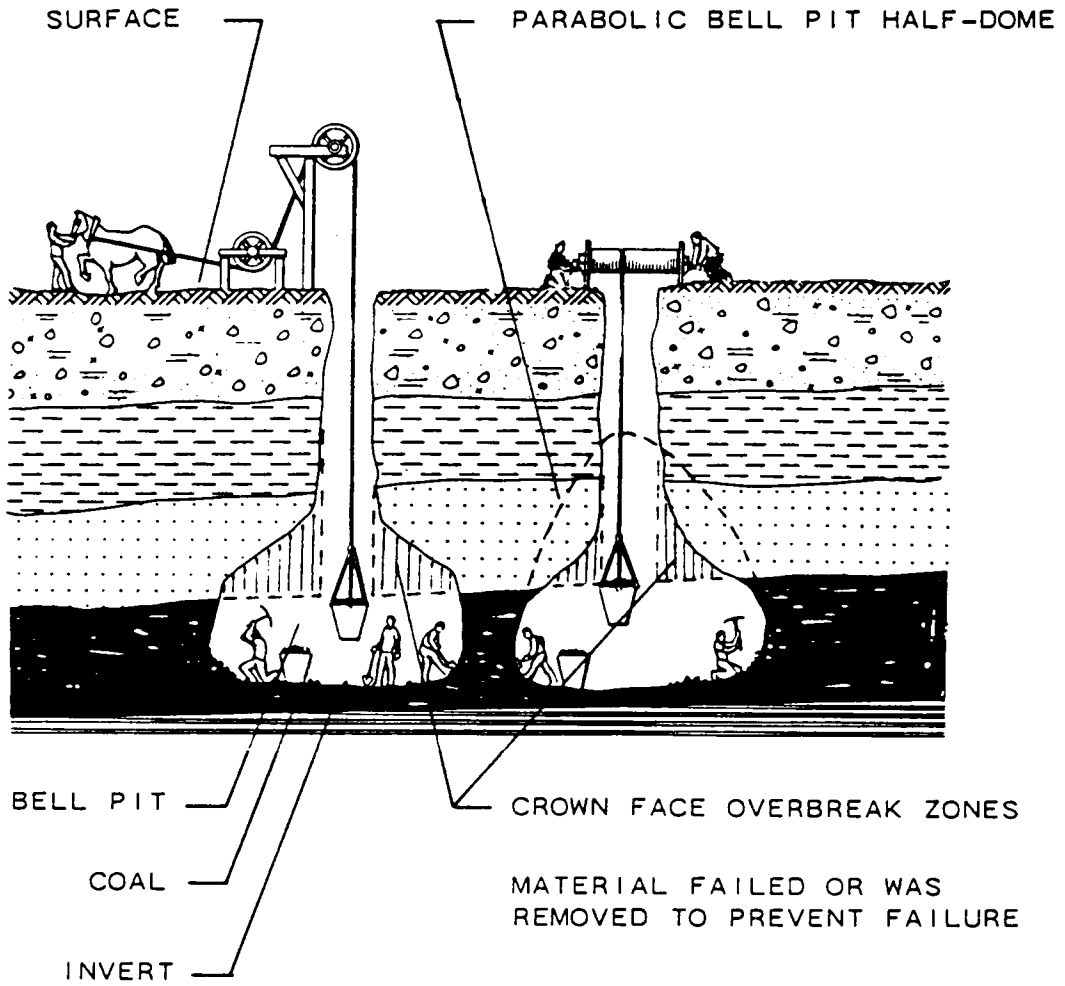

Figure 4-28 Cross Sectional (Parallel and Perpendicular to Portal Centerline Axis) Views of Portal Crown Face Overbreak Failure.



NOTE: MINING CEASED IN BELL PIT WHEN FAILURE CONTINUED TO PROPAGATE TO THIS AREA, THUS MAKING SAFE AND ECONOMICAL SUPPORT ALL BUT IMPOSSIBLE.

Figure 4-29. 'Crown Face Overbreak' As Observed in Bell Pit Mining (Temple, 1972).

4.2.2 Internal Collapse.

Falls and spalling of material from the crown or ribs, which do not extend to the upper slope or crown face surface, inby the portal interface are classed as 'Internal Collapse' failures. Refer to Figure 4-30. The most common location of this failure is one or two spans inby the portal interface where portal support typically ends. Examples of this failure were noted at abandoned coal mine portals at Ames, West Virginia (Seijo, 1988).

'Internal Collapse' failure may continue to propagate upward as illustrated in Figure 4-31 forming a chimney subsidence failure (Karfakis, 1987). Once this failure extends to the surface and forms a sinkhole, the classification changes to 'Upper Slope Subsidence/Collapse' failure. The surface expression of the sinkhole depends, of course, on the characteristics of the near-surface material. Figures 4-32 to 4-34 illustrate this occurrence, as observed at the portal of an abandoned railroad tunnel near Eggleston, Virginia. Here, a combination of shallow ground cover and highly weathered karstic joints, in conjunction with a heavy triggering period of precipitation, formed a surface sinkhole with near vertical sides approximately two diameters inby the interface.

Bearing capacity failure of internal rib or crown surfaces from tunnelling machine thrust pads are also considered to fall within this classification.

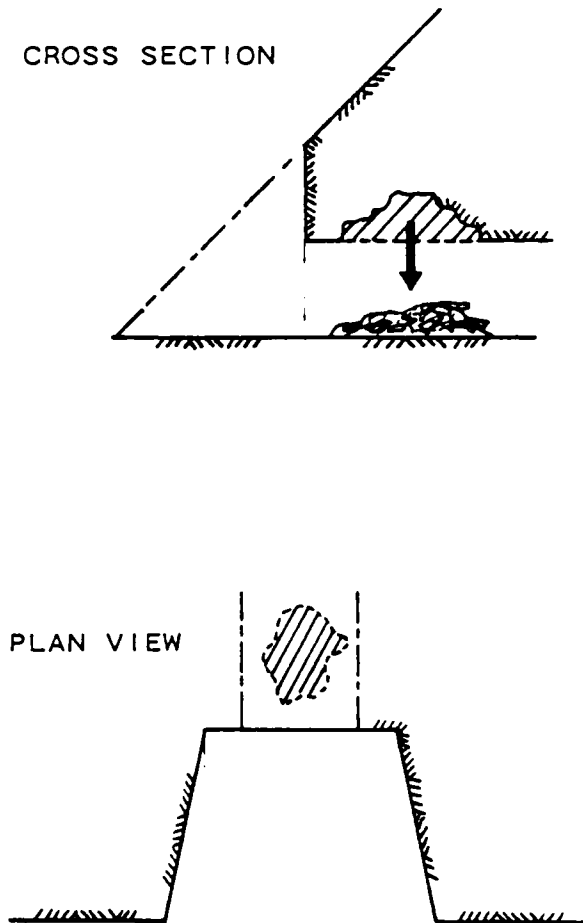

Figure 4-30. Cross Sectional (Portal Centerline Axis) and Plan View of Portal Internal Collapse Failure.

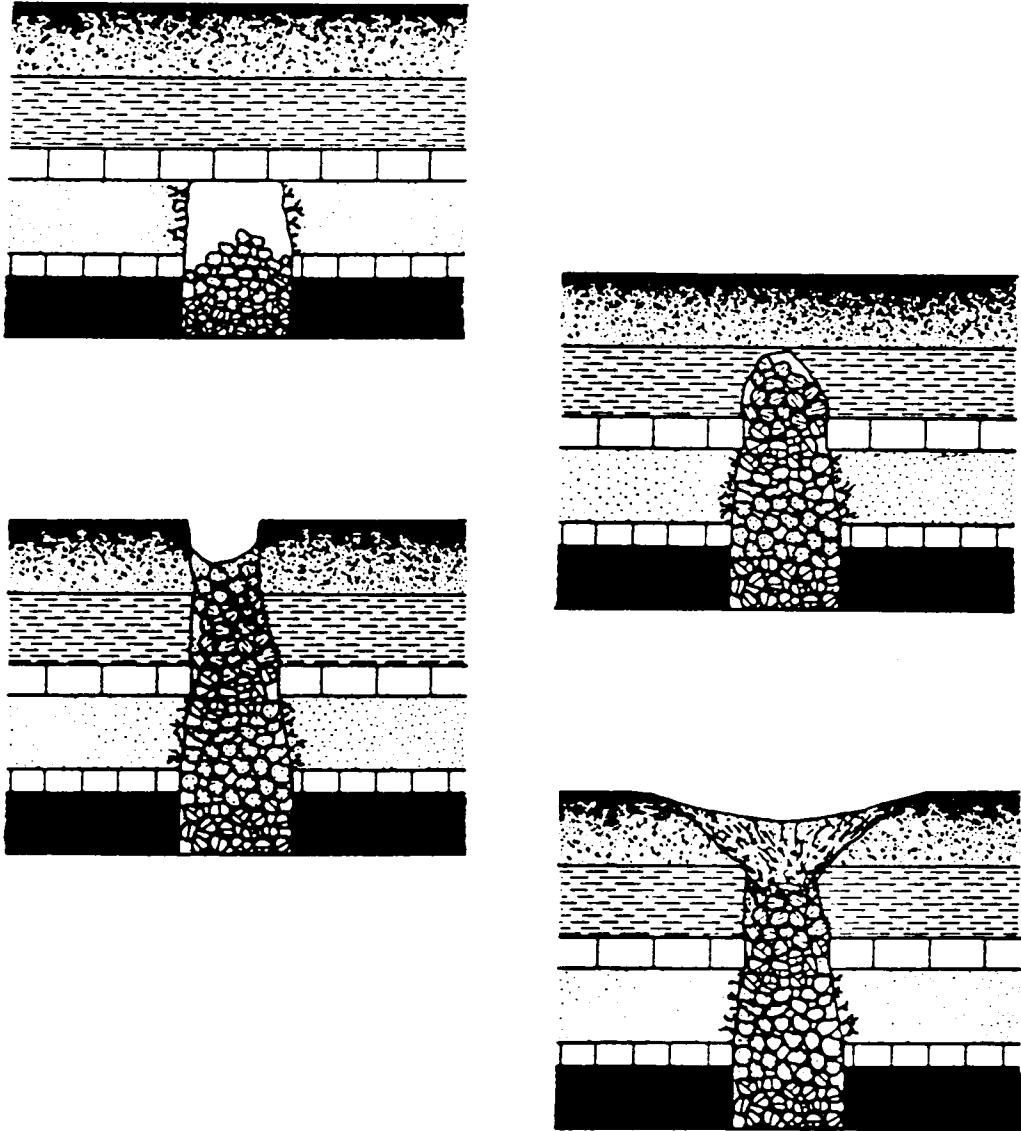

Figure 4-31. Typical Propagation of Internal Collapse Failure (after Karfakis, 1987).

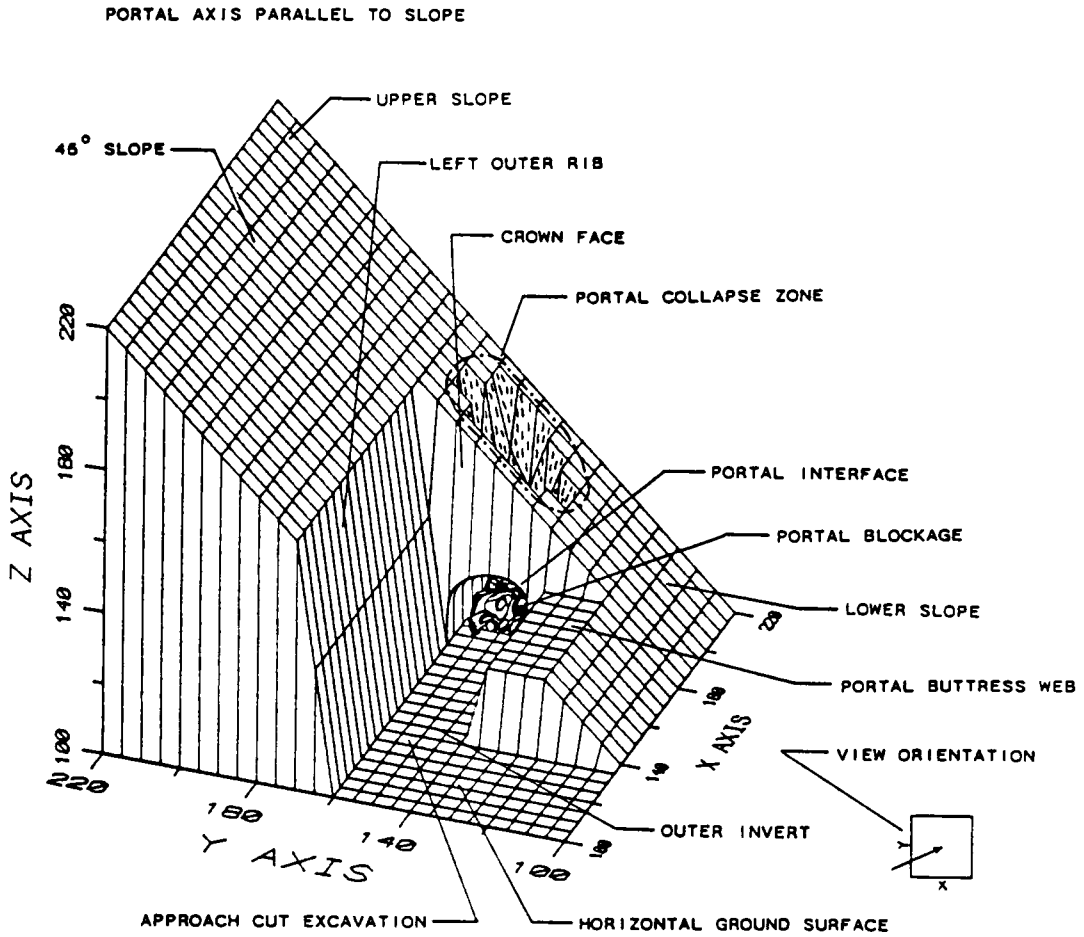

Figure 4-32. 3-D View of the Propagation of Internal Collapse to the Surface in a Portal Driven Parallel to a 45° Slope.

PORTAL AXIS PARALLEL TO SLOPE

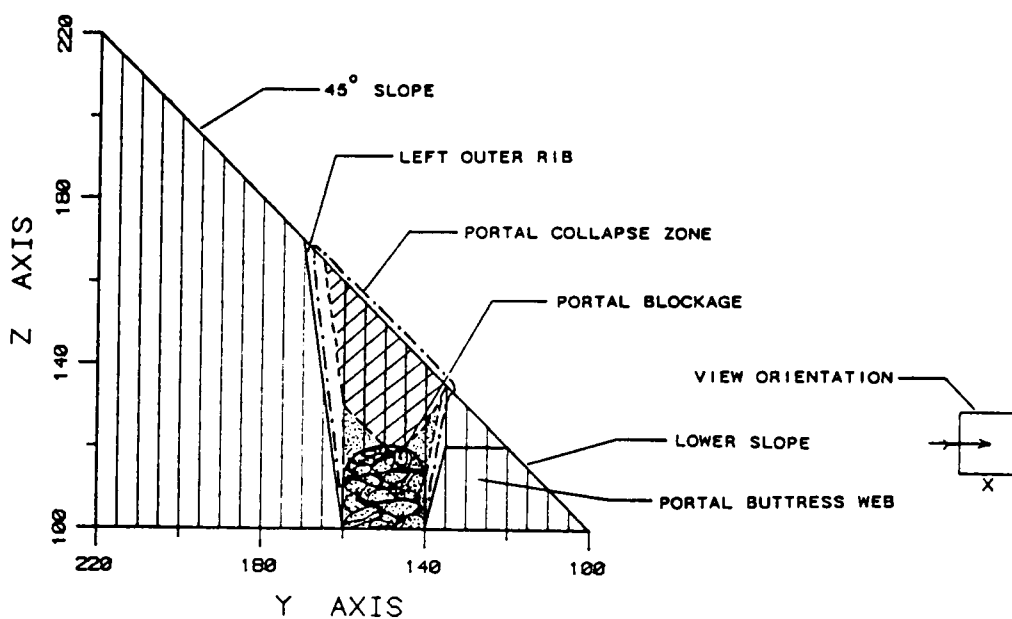

Figure 4-33. Cross Sectional (Perpendicular to Portal Centerline Axis) View of the Propagation of Internal Collapse to the Surface in a Portal Driven Parallel to a 45° Slope.

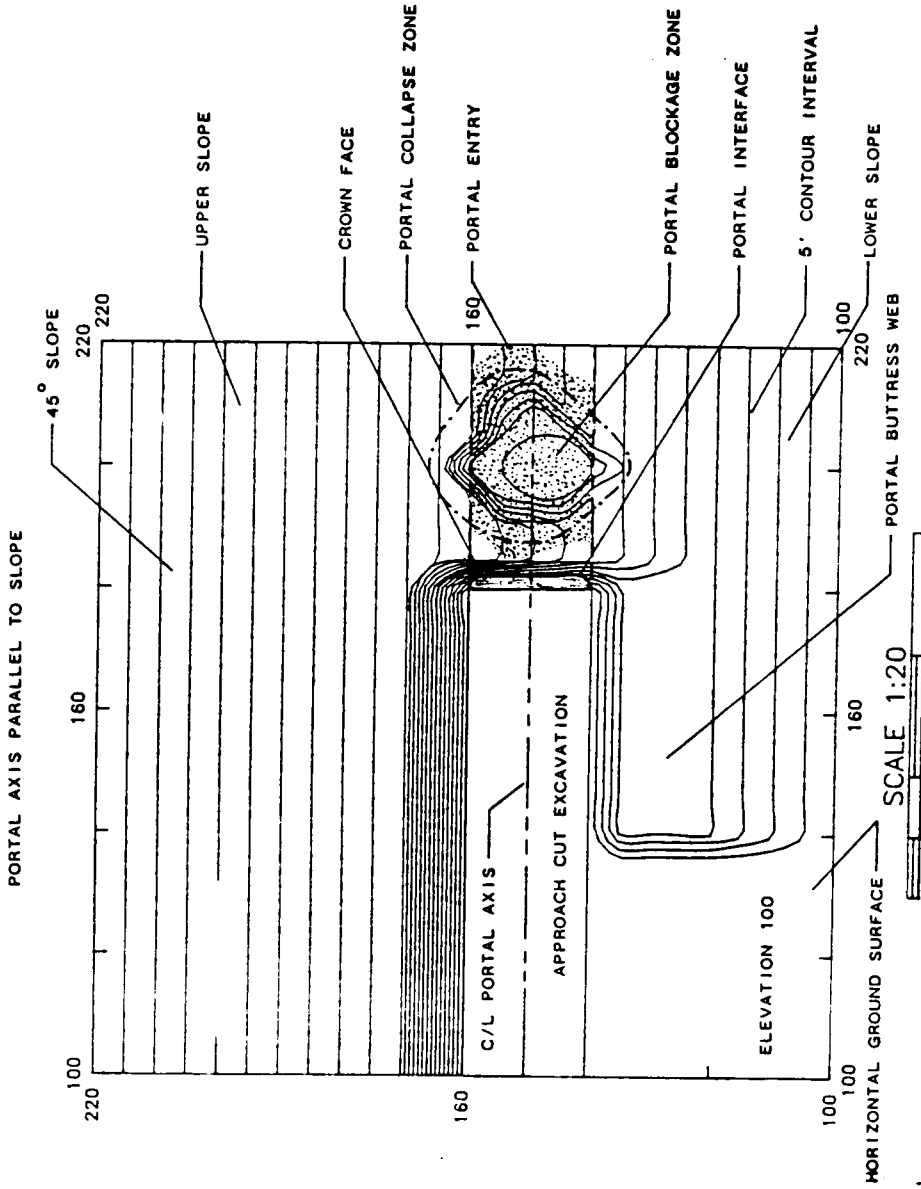

Figure 4-34. Plan View of the Propagation of Internal Collapse to the Surface in a Portal Driven Parallel to a 45° Slope.

4.3.3 Invert Failure.

'Invert Failure' may result from bearing capacity failure and/or weathering, and is typified by the punching of steel or wood sets as shown in Figure 4-35, heaving and buckling of the invert, or excessive invert deterioration accelerated by equipment loading. An example of the latter, severe invert deterioration, occurred at the Oceana Coal Mine portals. Improved drainage and a compacted, porous backfill corrected the problem.

Bearing capacity failure may be encountered with a soft and/or thin sequence of invert strata. The invert, while often overlooked, plays a crucial role in the initial construction and overall life of a portal. Invert problems may cause long and untimely delays along with long-term maintenance costs. For example, bearing capacity failures have led to steel set and concrete segment movement and deformation, as well as punching of tunnel boring machined foot pads (Snowdon, 1983). A common mitigation method involves the construction of a reinforced concrete invert slab, both inby and outby the interface.

Additionally, if a portal is driven parallel to a slope, the outer invert may form a bench. Failure of this invert-bench may occur via sliding and is therefore placed in this classification. Several of the Feather River Canyon railroad tunnel portals had the inverts outby the interface replaced with a mass concrete structures,

presumably due to earlier sliding failures. Please note, that if the slide were to engulf both areas outside and inside the portal interface line, the failure would be considered not an 'Invert Failure', but an 'Overall Mass Slide' type of failure.

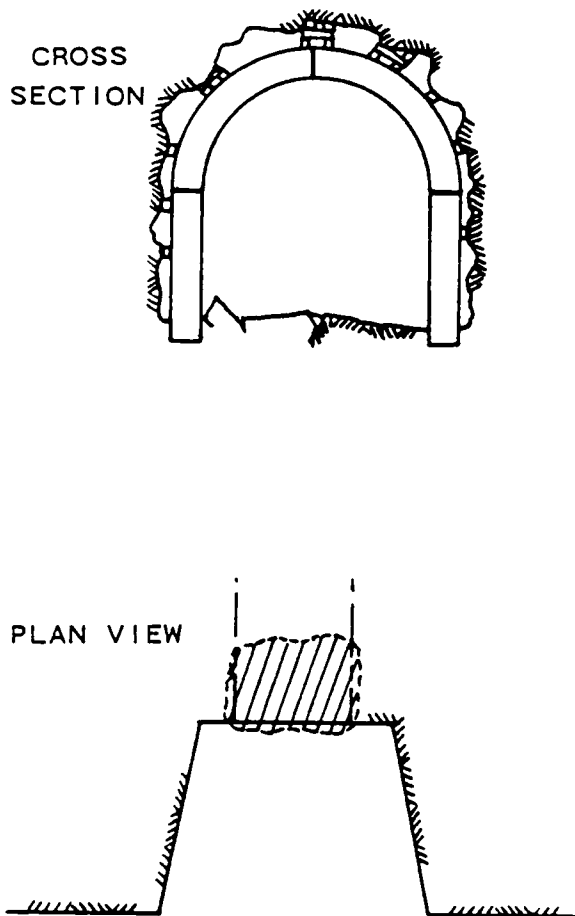

Figure 4-35. Cross Sectional (Portal Centerline Axis) and Plan View of Portal Invert Failure.

4.3.4 Seal Rupture.

The final failure classification involves that of 'Seal Rupture' and has been included in the classification system in order to stress the need for a complete design, from the very initiation of a portal project to its final closure. This type of failure is normally found in inactive or abandoned portals that have either been permanently sealed by man or have been sealed by a natural collapse. A tremendous number of abandoned portals across the country are scheduled for engineered closure and reclamation under federally funded abandoned mine lands legislation (U.S. Dept. Interior/OSM, 1983).

The most catastrophic version of this failure, called a "Blow Out", involves the release of large, destructive volumes of trapped and potentially contaminated water through a rupturing of the seal from hydrostatic water pressure or construction activity. Figure 4.36 illustrates the failure of a man-made portal seal. The force exerted by the water will depend upon the overall water head behind the seal. With combination drift and shaft mines in mountainous areas, tens of feet of water head can quite readily exist over a several square mile area behind a portal seal. During the 1970's, the era of ecological concern, extensive research was performed in the area of portal seal design for the primary purpose of pollution control (Skelly and Loy, 1973). Unfortunately, many of

these designs did not address stability concerns and must be considered inadequate for reservoir containment even when newly constructed, and much less so after a decade or two of deterioration (Seijo, 1988).

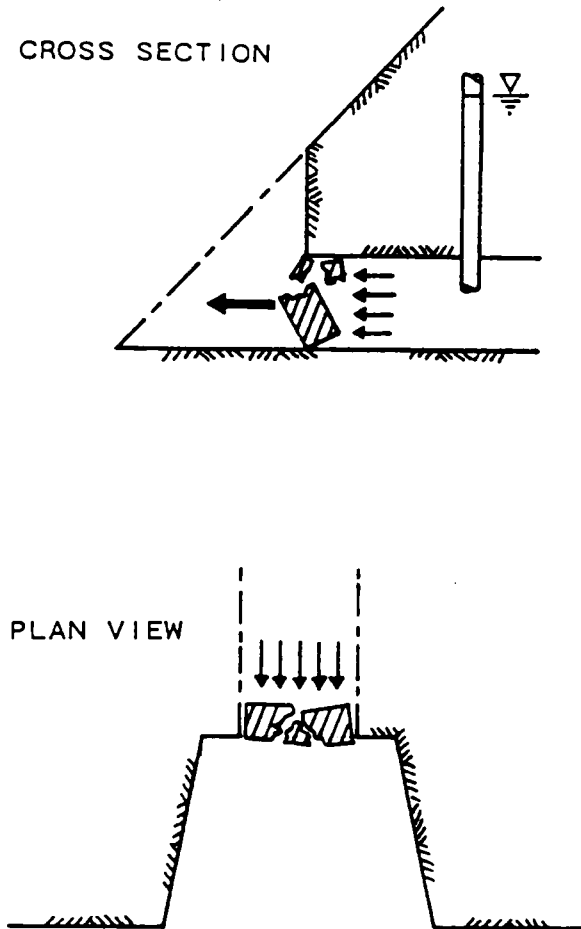

Figure 4-36. Cross Sectional (Portal Centerline Axis) and Plan View of Portal Seal (Man-made) Rupture Failure.

5.0 PORTAL DESIGN ANALYSIS

5.1 Analysis Options

Seven analysis options were considered for a portal stability analysis. These included numerical modelling, physical modelling, classic elastic theory, observational methods, three-dimensional limit equilibrium methods, two-dimensional limit equilibrium methods, and rock mass classification systems.

Numerical modelling was rejected due to the inability to accurately model the highly jointed, near-surface environment as well as deficiencies in provision of the input data (Bieniawski, 1984; Brady and Brown, 1985; U.S. Army Corps, 1978). Classic elastic theory was also rejected due to its inability to model near-surface discontinuous structure and weathering characteristics (Hoek and Brown, 1980).

Physical modelling was rejected because of the inability to realistically create accurate three-dimensional models of a portal that could be tested. This approach tends to be very site specific, and is not flexible in terms of varying rock mass conditions (Bieniawski, 1984).

Observational methods, such as the New Austrian

Tunnelling Method, NATM (NATM, 1985; Rabcewicz, 1964), base the design/support requirements on the support that is required to bring the rock mass surrounding the excavation into equilibrium at the time of excavation (Bieniawski, 1984). The major design flaw with this approach in regards to portals, is that the rock mass surrounding a portal may change with time (e.g. dilation due to freeze-thaw effects, weathering, joint filling, etc.). Hence, a support system based on conditions at the time of construction may suffer a decrease in stability (e.g. decreasing factor of safety) with time. Therefore, observational methods were rejected for design and analysis purposes.

Three-dimensional limit equilibrium methods as utilized for slope stability analyses (e.g. method of columns or cylinder/cone rotation) were rejected due to oversimplification of site conditions, whereas key-block theory was rejected due to site-specific restrictions along with the lack of proven and applicable codes (Cavers, 1988; Goodman and Shi, 1982). Three-dimensional stereographic techniques however, are quite applicable for use in both the surface and subsurface portions of the portal (Hoek and Brown, 1980; Hoek and Bray, 1981). Furthermore, with recently released software packages for the IBM-PC and Apple micro-computers, these methods are very efficient and cost-effective (Watts, 1987).

Two-dimensional limit equilibrium analyses as commonly

utilized for rock slope stability analyses (e.g. plane, wedge, non-vertical slices, toppling, etc.) were deemed acceptable for portal analysis. These design and characterization methods are proven and well documented with many variations and codes available (Brawner and Cavers, 1986; Canmet, 1977; Hoek and Bray, 1981; Miller, 1984; Morgenstern and Sangrey, 1978; Piteau and Peckover, 1978; Rib and Liang, 1978; Scoble and Leigh, 1982; Varnes, 1978). Also, past experience has shown that two-dimensional limit equilibrium analyses are conservative for portal slope design, typically due to the limited reach of the slope (U.S. Army Corps, 1978). This conservatism is valuable in terms of the many unknowns that commonly exist in portal zones. The limiting factor though, is that these analyses may only be utilized for the external portion of the portal zone, the portal approach cut slopes.

Rock mass classification systems were deemed acceptable for portal design and analysis assessment due to their relative ease and rapidity of use, applicability to discontinuous and/or weathered rock mass structure, as well as many years of proven success from hundreds of underground construction projects (Barton, et al, 1973; Bieniawski, 1973, 1974, 1984, 1987, 1988; Bieniawski and Maschek, 1975; Bieniawski and Orr, 1976; Deere, 1964; Kendorski, et al, 1983; Terzaghi, 1946; Wickham, et al, 1972).

Therefore, after consideration of the various analysis options, three-dimensional stereographic techniques, two-dimensional limit equilibrium methods, and rock mass classifications systems were selected for use in portal design and stability assessment. The specific selection and organized utilization of these methods is discussed in the following two sections.

5.2 Rock Mass Classification Systems

The use of a classification system constitutes an organized initial approach to the problem of ascertaining the engineering stability of a rock mass in a systematic manner with numerical evaluations that are directly comparable from site to site. Though it is generally recognized that most rock mass classification systems err on the conservative side, the degree of conservatism, if any, is unknown for portals, since rock mass methods have not been specifically applied to portal design. Hence, correlations with existing portals may enable these rock mass classification systems to be utilized, possibly without modification, in the design and construction stages of new portals, as well as the long-term performance monitoring of existing portals.

Over the last two decades several different types of

rock classification systems have been proposed; however, only five have found widespread usage for underground design in the United States. These five are: a) Terzaghi's Rock Load Concept, b) 'Q' System, c) Geomechanics Classification System (RMR), d) Rock Quality Designation (RQD), and e) Rock Structure Rating (RSR), (Terzaghi, 1946; Proctor and White, 1968ed; Barton, 1974; Bieniawski, 1973; Deere, et al, 1969; Wickham, et al, 1972).

5.2.1 Terzaghi's Rock Load Method.

A classic and often utilized method for tunnel support design and classification of rock into zones of similar characteristics is Terzaghi's Rock Load method (Terzaghi, 1946; Proctor and White, 1968ed). This method established ten general rock mass categories. Each rock mass category is assumed to generate a specified dead load that acts upon the tunnel support system. The load is assumed to gradually increase to a maximum constant level that is independent of the depth below the surface. The rock load is determined by multiplying the relevant rock load coefficient by the tunnel diameter. Hence, with the rock load, passive support system capacities may be determined.

A major concern with this method though, is that it is generally considered overly conservative in regards to its load prediction, thereby imparting inordinately high tunnelling costs. In partial response to this problem, a

revised set of design coefficients (Rose, 1982), which comprise the most liberal modification of the Terzaghi Classification System and the version utilized in this investigation, is presented in Table 5-2.

From this table it is readily apparent that Terzaghi's rock classification is overly simple due to the utilization of one rock index parameter, RQD, along with a very general description (e.g. massive, blocky-seamy, etc.). Hence, this method relies very heavily on past experience for the correct assigning of rock mass categories. Important parameters affecting the overall stability are not included (e.g. water conditions, joint and material characteristics, etc.).

Another problem with the Terzaghi system, is that there is a depth restriction above the crown of the underground excavation equal to approximately 3 portal spans. For example, Figure 5-1 illustrates a 20 foot diameter portal driven into a 45° rock slope. The first 40 feet of the excavation comprises the approach cut giving a minimum cover for turning under of 20 feet or 1 span (Note: This is a typical distance as used in practice for turning under.). However, with Terzaghi's minimum depth requirement, the classification is only valid for tunnels with a depth of cover above the crown greater than the

Table 5-1. Revised Terzaghi Rock Load Design Coefficients (Rose, 1982).

ROCK CONDITION		RQD	ROCK LOAD H_p (ft)
1.	Hard and intact	95-100	Zero
2.	Hard stratified or schistose	90-99	0 to 0.5 B
3.	Massive, moderately jointed	85-95	0 to 0.25 B
4.	Moderately blocky and seamy	75-85	0.25 B to 0.20 (B + H_t)
5.	Very blocky and seamy	30-75	(0.2 to 0.6) (B + H_t)
6.	Completely crushed but chemically intact	3-30	(0.6 to 1.1) (B + H_t)
7.	Sand and gravel	0-3	(1.1 to 1.4) (B + H_t)
8.	Squeezing rock, moderate depth	N/A	(1.1 to 2.1) (B + H_t)
9.	Squeezing rock, great depth	N/A	(2.1 to 4.5) (B + H_t)
10.	Swelling rock	N/A	\leq 250 feet

Note: The only modifications to Terzaghi's original system are in classes 4, 5, and 6 (e.g. Moderately Blocky and Seamy, Very blocky and Seamy, and Completely Crushed but Chemically Intact, respectively).

following equation:

$$\text{Minimum Support Depth} = 1.5(B + H_t) = 60 \text{ Feet.}$$

Where: B = Portal (Tunnel) Width = 20 Feet,
 H_t = Portal (Tunnel) Height = 20 Feet.

Note that tunnels of equal height and width will require 3 diameters cover.

Thus, a nebulous support zone extends from the point of one diameter cover at the portal interface to that of three diameters cover (e.g. 3 Diameters = 60 feet) forty feet in by the interface. Hence, this particular portal and many others whose support are based on the Terzaghi concept do not meet the turn-under restriction. For shallow tunnels and portals which do not meet this depth restriction, due to the very unpredictable behavior of near-surface discontinuous rock masses (e.g. conditions that prevent effective load transfer to the abutments), some designers utilize the full overburden load (Industry Comments, Section 3). However, due to the conservative nature of Terzaghi Concept, others ignore the depth restriction on the premise that the shallower cover will require less support.

To further explore this point, Figure 5-2 shows some of the classification categories for Terzaghi's System, in a

plot of rockload in PSF (e.g. support load) versus depth below the surface, for a 45° rock slope with a mass density of 170 PCF, as shown in Figure 5-1. Note how quickly this load diverges from the total overburden load. Thus, if a tunnel in 'Moderately Blocky and Seamy' rock had steel supports designed for a support load of 1360 PSF, this support load would typically be used in the nebulous support zone that extends from the three diameter cover to the one diameter cover. However, this design practice for portal zones has led to problems due to an underestimation of the actual load as shown in Figures 5-3 and 5-4. Figure 5-3 illustrates a portal driven into a 60 foot pre-split highwall, while Figure 5-4 shows the rock load prediction for this category. If the conditions from the previous example, Figures 5-1 and 5-2, are utilized (e.g. portal dimensions and overall rock mass density), the minimum required depth for utilizing Terzaghi's method would again be 60 feet. Thus, this portal meets the cover distance restriction and the design load of 1360 PSF (e.g. 8' of rock load) for Moderately Blocky and Seamy ground conditions that is often considered sufficient. Note however, that this portal has suffered the most common type of active portal failure, that of 'Crown Face Overbreak'. This particular failure is presented at the upper boundary of what has been observed in the field. Thus, this failure would initiate a load of 3740 PSF (e.g. 22' of rock load),

which is 2.75 times greater than the design load, at the portal interface, where the support was erroneously expected to be extremely light.

A final concern, contributing to the rejection of Terzaghi's concept, is that it was designed for passive supports (e.g. steel sets) and is not directly translatable for use with the current trend in underground support of immediately placed, active supports (e.g. tensioned rock bolts) and shotcrete.

5.2.2 'Q' System.

The 'Q' or CSIR System utilizes the following six rock mass parameters in its classification procedure (Barton, et al, 1974):

- 1) RQD - Rock Quality Designation,
- 2) J_n - Joint Set Number,
- 3) J_r - Joint Roughness Number,
- 4) J_a - Joint Alteration Number,
- 5) J_w - Joint Water Reduction Factor,
- 6) SRF - Stress Reduction Factor.

The numerical values of the six abovementioned parameters, which are based on the discontinuity(s) that will be most likely to allow failure to initiate, are

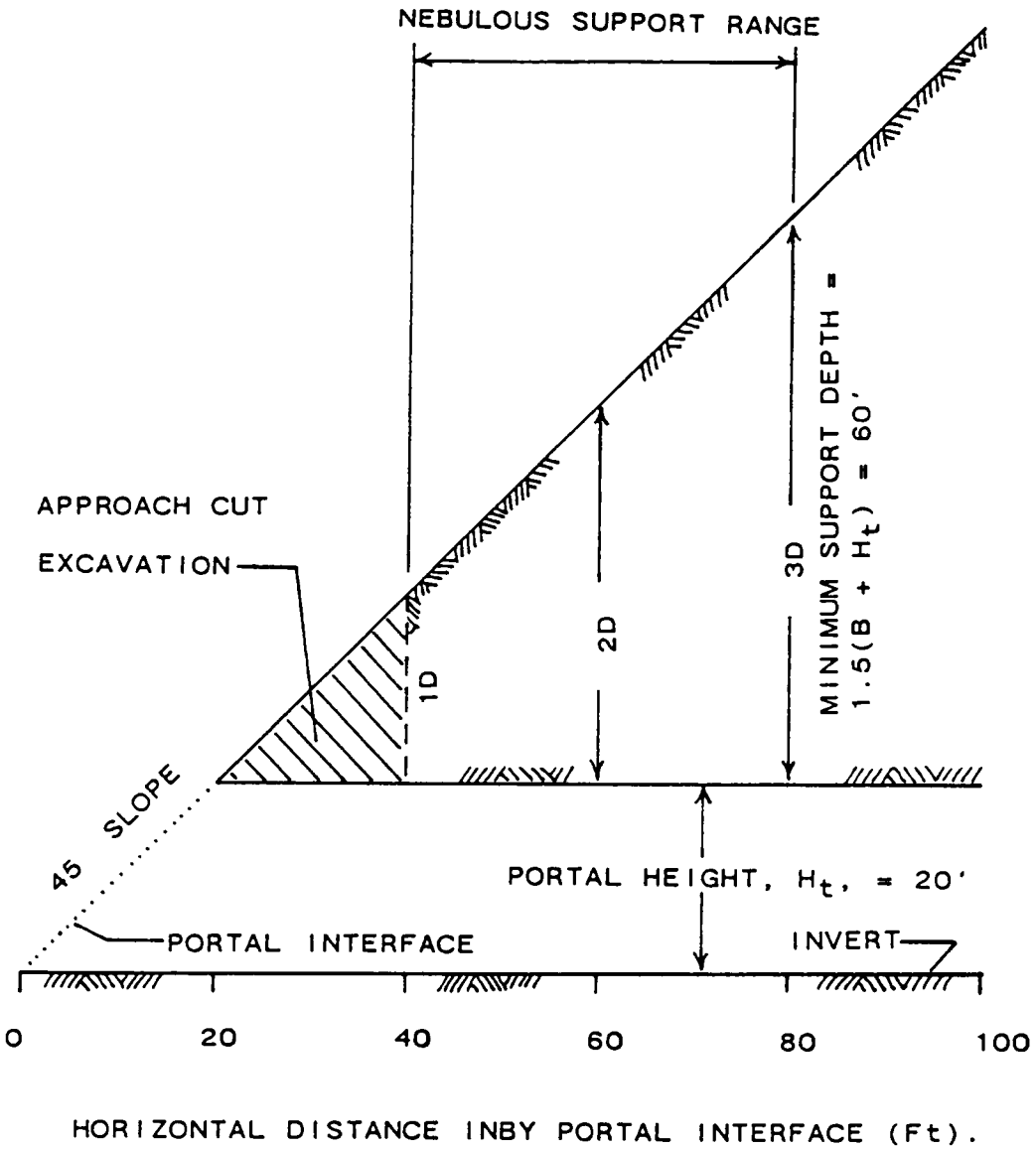

SCALE: $X = Y$

1 DIAMETER = 20'

PORTAL WIDTH, B , = 20'

Figure 5-1. Nebulous Support Range from Terzaghi's Rock Load Concept.

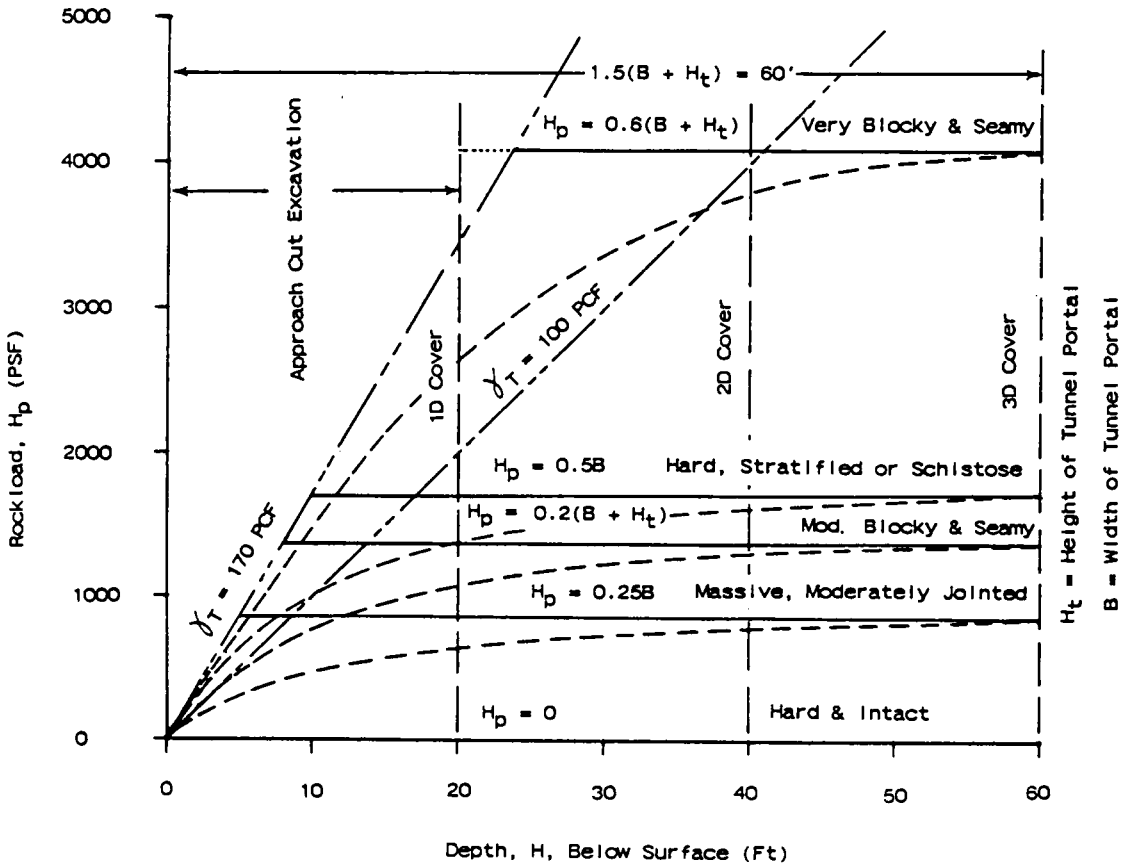
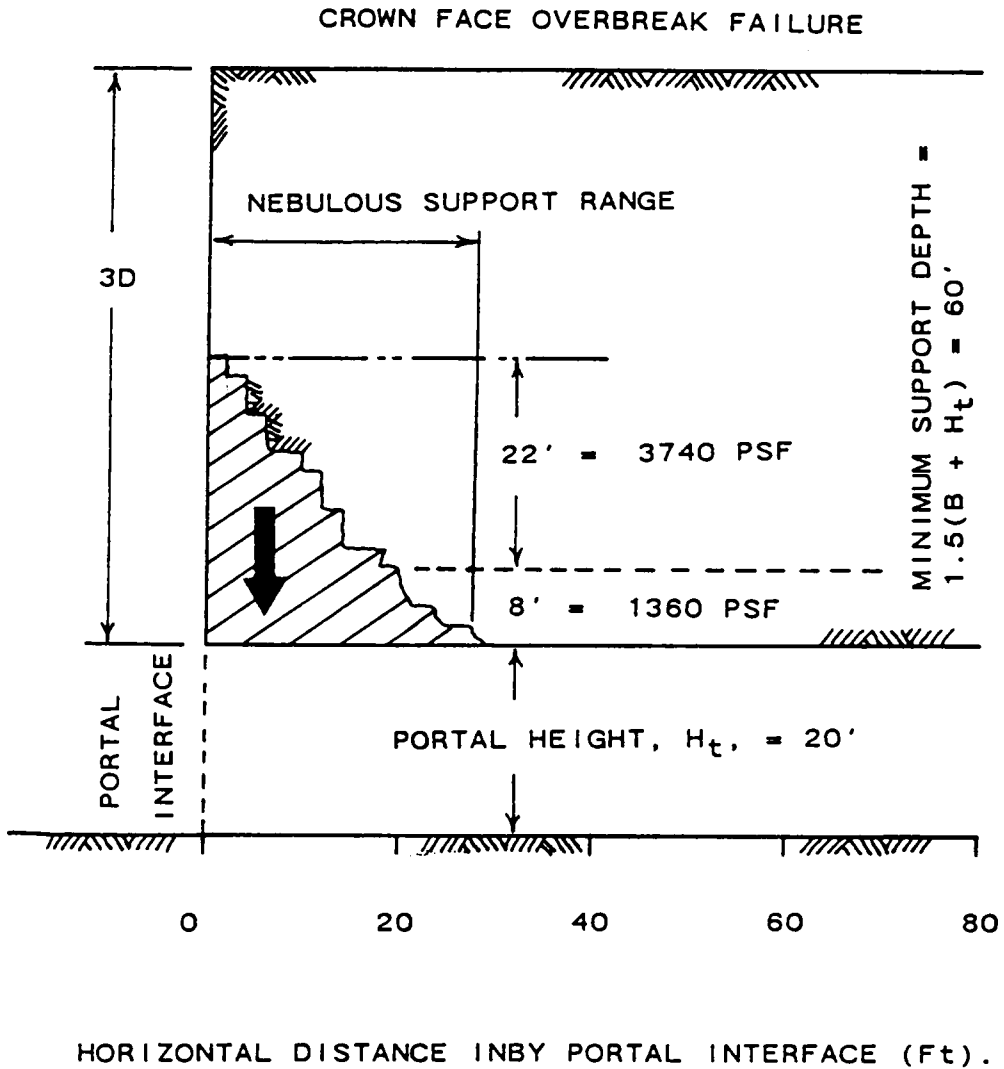

Figure 5-2. Modified Terzaghi Rock Load Categories for a Portal Driven into a 45° Rock Slope with a Mass Density of 170 PCF.



SCALE: X = Y

1 DIAMETER = 20'

PORTAL WIDTH, B, = 20'

Figure 5-3. Portal Driven into a 60' Pre-split Highwall.

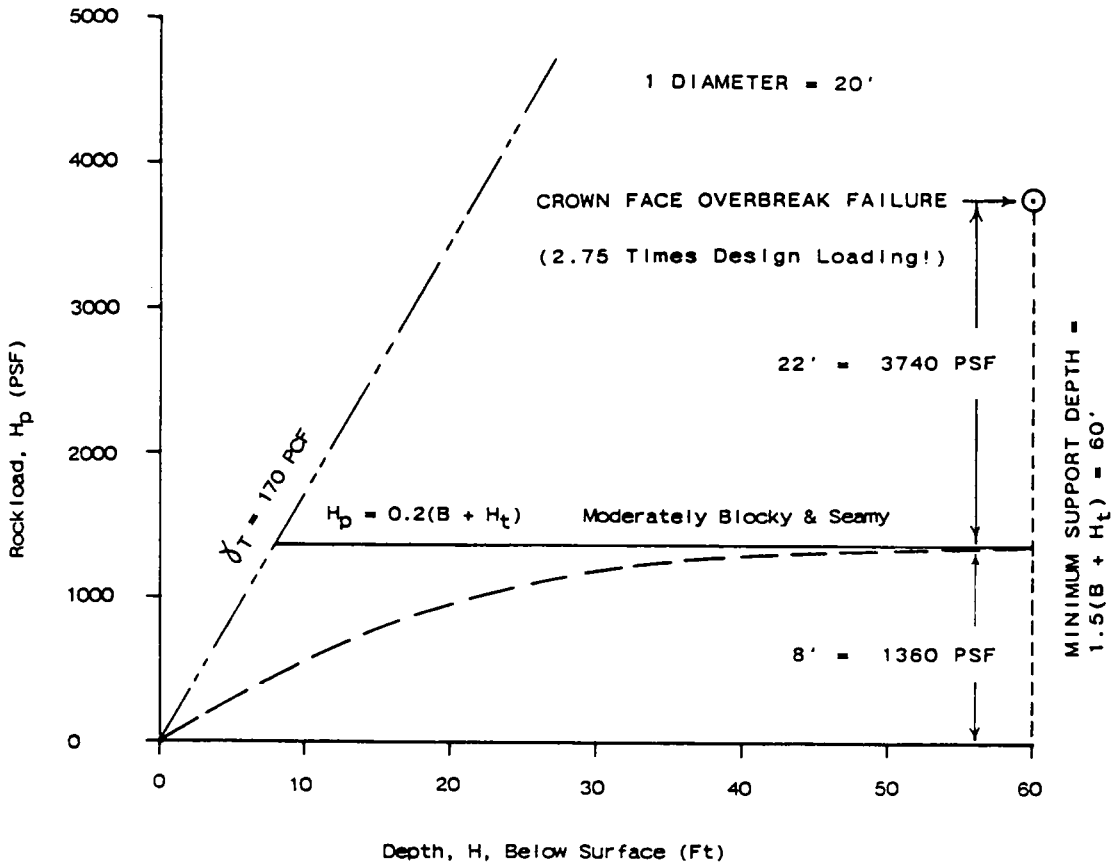

Figure 5-4. Modified Terzaghi Support Design Analysis for Portal Driven into a 60' Vertical Highwall.

combined in the following equation to obtain the 'Q' rating:

$$Q = (RQD/J_n) (J_r/J_a) (J_w/SRF)$$

or, $Q = (\text{Relative Block Size}) \times (\text{Inter-block Shear Strength}) \times (\text{Active Stress})$

As to the classification rating, the higher the Q value, the more stable the rock mass structure. Thus, noting the above equation, it is obvious that for a more stable portal, the values of RQD, J_r , and J_w should be as high as possible. This equates to a rock mass with relatively few, rough, and dry discontinuities. Additionally, the values of J_n , J_a , and SRF should be as low as possible. This constitutes a rock mass with few joint sets which have not been greatly altered and exist in an optimum stress environment, preferably moderate to low in range. However, from the detailed literature review and field investigations, a typical portal is characterized with a highly discontinuous, weathered, often wet, low-stress environment and does not lend itself to this description of a stable rock mass structure.

The 'Q' system is less commonly used than other rock mass classification systems in the U.S. except as a secondary check. It relies on good tunnel construction

practices and prompt support installation. Furthermore, it utilizes the premise that support pressure does not increase with increasing span. This concept, although potentially valid in situ, is questionable in terms of the three-dimensional portal scenario.

The 'Q' system is alone in that it has several internal adjustments for portals. For example, a joint multiplier of two is utilized for portals (e.g. $J^n \times 2$). Hence, the joint values are doubled for the portal zone. Furthermore, the stress reduction factor, SRF, for the low-stress, near surface portal region is moderately low for a competent rock mass (e.g. 2.5 on a scale of 0 - 10); however, there is a recommendation to double this value for cases in which the overburden thickness at the portal interface is less than the span width.

Thus, with the effects of somewhat naturally occurring low values (e.g. at portal sites) for the rock quality designation (RQD), joint roughness number (J_r), and joint water reduction factor (J_w), combined with naturally occurring high values for the joint set number (J_n) and joint alteration number (J_a); in conjunction with a forced increase in the number of joint sets and the stress reduction factor, the 'Q' system may predict extremely low 'Q' values, and hence, excessively high support pressures or rock loads for portals. This design flaw is further illustrated in Section 6.

5.2.3 Geomechanics (RMR) System.

The Geomechanics or Rock Mass Rating (RMR) System uses the following field measurable parameters (Bieniawski, 1973, 1984):

- 1) Uniaxial Compressive Strength,
- 2) Rock Quality Designation,
- 3) Discontinuity Spacing,
- 4) Discontinuity Condition,
- 5) Discontinuity Orientation,
- 6) Groundwater Conditions.

The numerical values gained from an interpretation of each parameter are summed to gain a basic rock mass rating (RMR) value. This value is then adjusted downward, if necessary, to take into account the pertinent discontinuity orientation in relation to the rock mass to obtain an adjusted RMR Value. This value may be adjusted further in terms of blasting, state of stress, and potential location near major fractures and faults (Kendorski, et al, 1983).

One of the major advantages of the Geomechanics System is that it, or modifications thereof, has been widely used in this country. Furthermore, it was initially developed for use in shallow tunnel design in jointed rock masses, thus more closely resembling portal conditions. It is generally considered less conservative than the Terzaghi

concept, yet more conservative than the 'Q' System for tunnel support prediction. Also, it has also been modified and appended for use in rock slope (Steffen, 1976) and foundation analyses (Bieniawski and Orr, 1976). Thus, the Geomechanics Classification is much more flexible in terms of application for the entire portal zone (e.g. invert and rock slopes). Finally, the deciding factor in the selection of this method resulted from initial studies which showed a close correlation between the height of 'Crown Face Overbreak' failure as observed in the field and the maximum predicted rock load.

5.2.4 Rock Quality Designation (RQD).

The Rock Quality Designation (Deere, et al, 1969), like the Terzaghi concept, relies on but one measurable rock mass parameter, that of RQD. Granted, it is quick and inexpensive, but it disregards important factors such as joint characteristics and orientation, and water conditions. Hence, it is rejected for basically the same reason as the Terzaghi concept, that of being too simple to adequately describe the rock mass.

5.2.5 Rock Structure Rating (RSR).

The Rock Structure Rating (Wickham, et al, 1972), though much more advanced than the RQD system, suffers from the same problem as Terzaghi concept, in that it was

primarily designed for passive (e.g. steel rib) support prediction, and insufficient data is available for a correlation with rock bolt or shotcrete support (Bieniawski, 1984). Hence, this classification method is rejected due to its archaic and inflexible nature toward modern support systems.

5.3 Stability Analysis Methodology

The previously mentioned portal analysis methods, chosen for their applicability to near-surface rock mass conditions, need to be applied in a systematic and organized manner. Hence, the stability analysis of a portal is accordingly broken down into the following four steps, each being necessary to complete before proceeding with the next step; a) Site Characterization, b) Overall Slope Stability Analysis, c) Approach Cut Excavation Design/Stability Analysis, and d) Subsurface Portal Design/Stability Analysis.

5.3.1 Site Characterization.

Since portal construction generally involves near-surface, discontinuous and stress-relieved rock masses, geological structure is of greater importance than the in

situ stress conditions because portal support loading conditions and failures are predominately structurally controlled. Thus, the first necessity is that of a geological characterization of the discontinuous rock mass in which the portal is to be located. This characterization may be obtained through the use of the Geomechanics Classification system. The rock mass classification system must be able to recognize and delineate the difference in loading conditions presented from a vast array of possible geologic conditions that may be encountered in the portal zone, some of which may cause extreme loading conditions (Judd, et al, 1957; Moebis and Bauer, 1989; Proctor and White, 1968; Sames, 1988).

To fully identify and quantify the site structure into zones of similar characteristics, the characterization, will of necessity, include information gathered from field exploration, specimen sampling and testing, and geological mapping. As to the site exploration, portal projects typically require multiple boreholes; horizontal, inclined, and/or vertical, to provide data along with the approach cut excavation which acts as one large exploration trench (Decker, 1988; Kane and Karmis, 1986; Lama, et al, 1986; Murphy, 1985).

Testing of the acquired rock samples is no different than for other underground projects and will not be pursued further other than to note that more emphasis should be

placed on the discontinuity characteristics instead of intact rock. The use of large-scale apparatuses for these tests (e.g. direct shear, as plate bearing, uniaxial, etc.), is highly recommended at critical sites for better simulation of rock mass conditions (Hoek and Brown, 1980; Nicholson, 1983). Small-scale tests, such as the direct shear, are better utilized with sawed an/or polished shear surfaces for determination of the residual angles of friction, as extremely erroneous results may occur from intact or rough joint tests (Goodman, et al, 1974).

Should the rock mass material be highly weathered, fractured, or contain joints with appreciable infilling material, field investigations at several portal sites (e.g. Eggleston, Featherfork, and Ironto) have shown that specialized sampling techniques (e.g. hand carved block samples), equipment (e.g. site-specific chisels and transportation containers), and tests (e.g. direct shear machines with low normal load and saturation capability), should be utilized for gathering information necessary for the stability analysis. Careful attention should be given to the extreme near-surface (e.g within 0.1 to 0.2 inches) of the discontinuities, as weathering may substantially reduce shear strength values (Hoek and Bray, 1981). The use of an index test to check for this condition in the field, such as the Schmidt hammer is discussed in Section 3.

Organization and analysis of the geological data may be aided from use of several geological software packages, such as Rockpack (Watts, 1987), which includes geological line mapping/data acquisition programs, three-dimensional stereographic plotting/analysis options (e.g. Marklands test for plane/wedge failure, etc.), and two-dimensional limit equilibrium methods (e.g. plane, wedge). Manual checks of computer solutions should always be performed.

5.3.2 Overall Slope Stability Analysis.

The overall slope should be analyzed for stability prior to stability analyses for the approach cut slopes or underground excavation. At this early stage in the design/planning process, it is typically much simpler to move the portal location than to try and stabilize the entire slope (Appendix 3). There have been several major failures, not to mention exceedingly generally difficult and expensive construction problems from portals being built into unstable rock slopes (Section 4).

To aid in the assessment of the external approach cut rock slope design, the Geomechanics Classification was appended with discontinuity orientation adjustments as discussed in Section 6. This allows the data which was collected during the site characterization to be utilized for selection of critical sections of slope for more detailed stability analyses with stereographic techniques

in combination with one or more of the basic types of two-dimensional limit equilibrium analyses (Hoek and Bray, 1981; Canmet, 1977; Piteau and Peckover, 1978). Selection of the proper slope analysis technique may be aided by reference to an illustrative type of slope classification system (Duncan and Goodman, 1968; St. John, 1972).

One of the applicable, but little known stability analysis methods that was investigated during the course of the research is the non-vertical method-of-slices (Sarma, 1979; Hoek, 1985). This two-dimensional limit equilibrium method allows for simulation of planar discontinuities with non-vertical slices. The code for this method, as provided by Hoek (e.g BASIC language), for the modified Method of Non-Vertical Slices, henceforth known as the SARMA/HOEK code or analysis, was de-bugged, modified slightly for improved efficiency, and then successfully used for a range of portal related stability problems. The code is listed in Appendix 4.

The SARMA/HOEK analysis is valuable in that a variety of complex profiles may be analyzed. The slice sides may be inclined at angles other than vertical, thus allowing the user to incorporate structural features such as bedding planes, joints, faults, and inclined tension cracks. Water forces are automatically included within the analysis and external forces may be applied at any angle to each slice. The option of external forces for each slice is very useful

since the resisting forces required to raise the factor of safety to some prescribed value through the use of various types of artificial support such as cable anchors, rockbolts, or face buttresses may be readily determined. Another calculation performed by the code is that of K_C determination. K_C is defined as the value of critical acceleration required to bring the slope to a condition of limiting equilibrium (e.g. Factor of Safety = Unity), thus providing useful data for pseudo-static seismic or blasting damage analysis. The code examines the positivity of effective normal stresses acting on the sides and bases and determines whether or not the solution is acceptable. If negative stresses are found, the slope geometry or phreatic surface location should be changed until an acceptable solution is achieved. Quite often, the inclusion of a tension crack behind the crest or the lowering of the phreatic surface by a few feet is all that is required. The code does not check for moment equilibrium due to the significant increase in computational effort required; however, this is seldom required for normal slope stability problems (Hoek, 1985).

An example of an analysis of a rock slope with realistic density and shear strength values utilizing the SARMA/HOEK code is presented in Figure 5-5 and Tables 5-2 and 5-3. Analyses were performed on four scenarios: a) dry conditions, b) saturated conditions, c) saturated

conditions with rock anchor artificial support, and d) saturated conditions with buttress support. The factor of safety, FS, and critical acceleration, K_C , is determined for each scenario. The stepped upper portion of the failure surface is commonly observed in the field in formations of this general type.

In dry conditions, the slope has an acceptable factor of safety of 1.57; however, this factor of safety drops to 1.23 with a critical acceleration of 0.14g in saturated conditions, necessitating artificial reinforcement for long-term design. Factors of safety of 1.5 have been achieved for both horizontal rock anchors and a portal buttress. Critical accelerations for both are approximately the same.

5.3.3 Approach Cut Slope Stability Analysis.

Typically, for optimum tunnel orientation in a discontinuous rock mass, less than favorable structural conditions will be encountered in one of the approach cut slopes. Hence, the individual approach cut slopes, consisting of the right and left outer ribs and crown face/upper slope, should be analyzed using the same techniques as described for the overall slope. Again, the Geomechanics Classification with the appended discontinuity orientation assessments (Section 6) may be utilized for the selection of the least stable sections of slope for

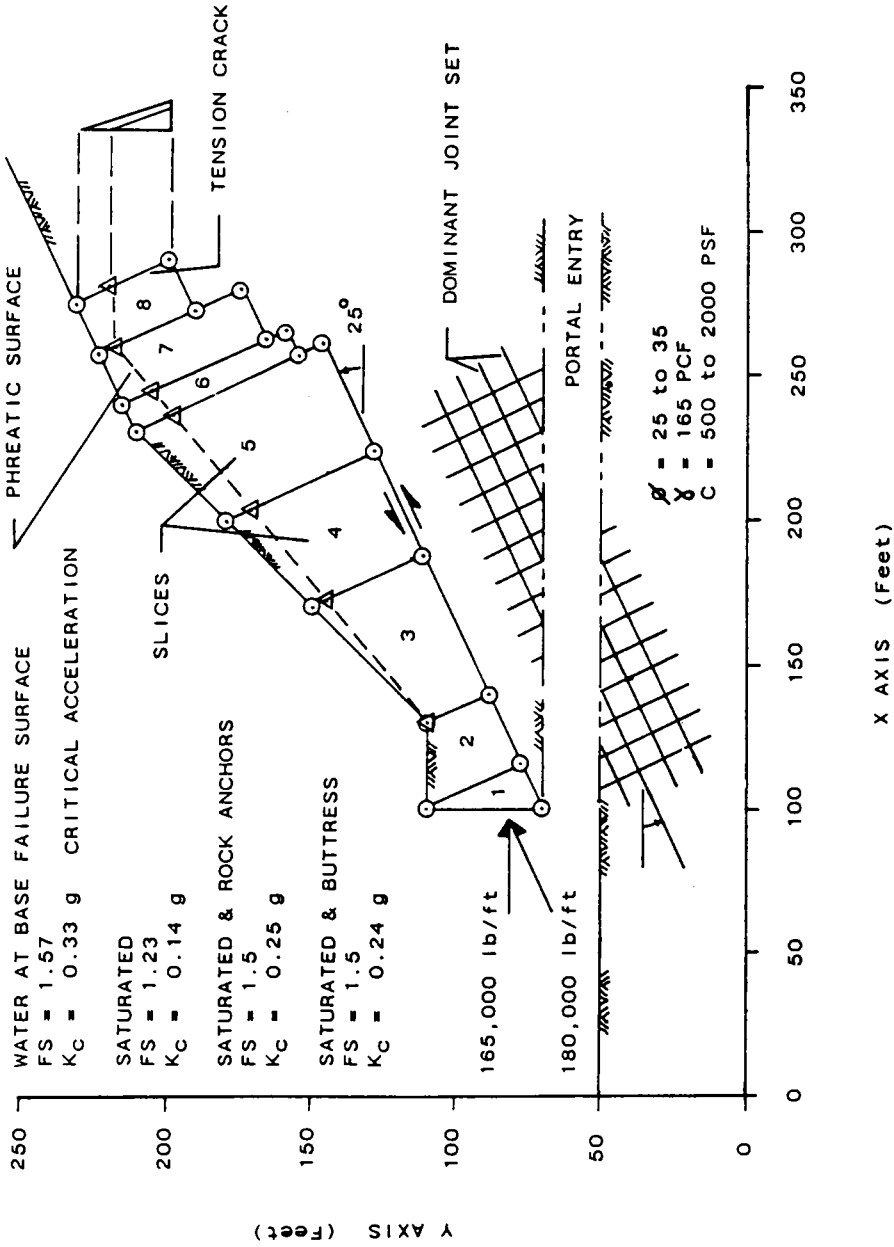

Figure 5-5. Stepped/Planar Portal Failure Model Used for SARMA/HOEK Analysis Example.

Table 5-2. Example of a Portal Failure Back Analysis Using the SARMA/HOEK Code.

Slope Dimensions	
Slope Height	210' to crest
Upper Slope Inclination	45°
Crown Face Height	110' to crown bench
Crown Face Inclination	90°
Crown Bench Width	30'
Portal Height	20'
Failure Surface Inclination	25+°, planar and stepped
Length, Portal Interface to Tension Crack	175'

Slope Composition

Interbedded sandstones and shales dip out of the slope at 25°, with the portal advancing drivage against dip. The strike of the formation is parallel to the crown face. No initial slope reinforcement is utilized. The slope will be analyzed for dry, saturated, and saturated-reinforced conditions. Cross bedding joints, as commonly found in sedimentary formations, dip 90° to the dip direction. The joint spacing is a uniform 10' and thus is large enough to validate this solution procedure.

A long-term design with a Factor of Safety of 1.5 or greater, with a critical acceleration greater than 2g is specified for an acceptable solution.

Table 5-3. Results of SARMA/HOEK Analyses.

Slope Conditions	Factor of Safety	Critical Acceleration
Dry Slope	1.57	0.33
Saturated Slope	1.23	0.14
Reinforced Slope (165,000 lbs)	1.5	0.25
Reinforced Slope (185,000 lbs)	1.5	0.24

Note: The Critical Acceleration is the acceleration which would be required to achieve a Factor of Safety of Unity.

detailed stability analysis.

The outer invert should also be analyzed at this stage for sliding stability and bearing capacity/weathering potential. Experience has shown that a two-dimensional slope stability analysis for a single portal is conservative (U.S. Army Corps, 1978).

Out of the many possible types of two-dimensional limit equilibrium analysis (e.g. plane, wedge, rotational, toppling, buckling, etc.), the undercut slope method was specifically investigated as a model for the crownface slope above the portal entry. Simple models utilizing this method clearly illustrated that very little undercutting could seriously affect the stability of a simple unconstrained block formed by vertical joints; however, field investigations proved that the controlling factor was that of vertical joint characteristics, thus necessitating a site specific characterization before accurate analysis. Nevertheless, the undercut slope method of analysis, though conservative, may sometimes prove to be useful for portal stability determinations.

5.3.4 Underground Stability Analysis.

Thus, with the external stability requirements of the overall and immediate approach cut slopes having been met, the stability of the underground excavation may be analyzed. For the design and estimation of support

requirements for an underground excavation, the following procedure may be utilized (Hoek and Brown, 1980):

- 1) Classify rock mass via the RMR or Q System and make a preliminary evaluation of the support prediction.
- 2) Estimate the in situ stress conditions from field measurements, nearby site data, or depth correlations.
- 3) Estimate the maximum boundary stresses surrounding the excavation via analytical methods. Mitigate tensile stress conditions on the excavation boundary via shape or support changes. Check if boundary stress exceeds the unconfined compressive strength of the rock.
- 4) Check the potential for structurally controlled instability via stereographic techniques or key-block theory (Goodman and Shi, 1982). Mitigate problems via geometry, shape, and/or support revision.
- 5) Correlate planned excavation sequence with support installation. In particular, check bolt lengths and patterns via empirical guidelines.
- 6) Create cross sectional drawings, to scale, of the proposed excavation that include the estimated maximum

excavation profile, structural features, estimated loosening/overbreak zone, and support system. Use these drawings to see if the proposed equipment is workable and that everything is within acceptable limits.

The portal, being part of an underground excavation, is taken through the preceding design procedure. Step 1 may be accomplished with the Geomechanics Classification which was selected for its applicability in Section 5.2.3. Since extreme loading conditions are routinely experienced at the portal interface (e.g. 'Crown Face Overbreak' failure), a half-dome model based on field observations was established. This model utilizes an appended Geomechanics Classification rock load prediction equation to yield the maximum height of the half-dome, as described in Section 6. To further aid in preliminary planning and support prediction, portal excavation and support guidelines were assembled from the database for the Geomechanics Classification, and are discussed in Section 6.

Steps 2 and 3 would probably be eliminated for most portals due to the immediate assumption of gravity induced stress conditions. Steps 4 and 5 are extremely important due to the structurally controlled stability problems commonly encountered at portals; however, the basic solution methodology is adequately described in various

references (Bennett, 1985; Brown, 1978; Craig, 1985; Bieniawski, 1984; Hodgson, 1986; Hoek and Brown, 1980; Lang, 1982; Peng, 1986; U.S. Army Corps, 1978, 1980; Wilbur, 1982; Whittaker and Kapusniak, 1984; Wood, 1979). Step 6 is self-explanatory and will utilize information concerning the type, size, and extent of conceivable failure and/or difficulty from the portal database.

One additional step may be added, because a closure design will probably be required when the useful life of the portal has been reached. This design will be based on potential hydrostatic pressures to be maintained in by the seal, various abandonment and environmental regulations, and future land-usage plans as discussed in Section 2.

Since there are no published design procedures that pertain to the portal entry, a general overview on the design philosophy as currently practiced by mining and/or tunnelling companies and consultants is provided in Appendix 3, Industry Comments. The overall thrust of this section is on a conservative design approach for the portal entry utilizing standard subsurface design methodology, and a heavy reliance on past experience, due to a historically high incidence of failure for this region. Since the portal entry normally only constitutes a small area as compared to the entire project, the cost of a conservative approach is normally not significant and deemed well worth the precautions taken to avoid delays or failure.

6.0 PORTAL DESIGN ADVANCES

6.1 RMR Modifications for Slope Stability Assessment

Before slope stability analyses can be considered, it is necessary to locate potentially critical sections of slope to be modelled. Since the Geomechanics Classification System is being utilized for both site characterization and the underground portal entry stability assessment, the system was applied to slope stability assessment. This is particularly advantageous for portal approach cuts, where one of the three rock slopes (e.g. left and right outer ribs, and crown/rib face) will potentially intersect strata in a disadvantageous manner.

Thus, the basic rock mass assessment remains the same; however, the necessary discontinuity orientation adjustments are only available for tunnels and foundations, even though rating adjustment values and descriptive terminology for slopes exist. Table 6-1 shows the abovementioned existing adjustment values, and Table 6-2 shows the effect of discontinuity strike and dip orientations in tunnelling. Though Table 6-1 has descriptive terms for the rating adjustments (e.g. Very Unfavorable, -60 points, etc.) it is obvious for a more uniform and accurate application, with a minimum of

personal or site bias, a system such as that used for tunnels, Table 6-2, is necessary.

Hence, the discontinuity orientation assessments for near-vertical rock slopes (e.g. portal approach cuts) in Table 6-3 are suggested. These orientation assessments, utilizing the existing descriptive terminology and adjustment values, are specified via a combination of the discontinuity dip values, strike direction, and approach cut orientation direction. The assumption of high angle approach cut slopes in which the majority of dipping discontinuities would "daylight" is assumed.

The derivation of dip value categories is shown in Figure 6-1. The lower category [0 to 15°], upper limit of 15°, is the approximate mean value of shear strengths (e.g. low range) of joint infilling material (Hoek and Bray, 1981). This lower limit is designated the limit of horizontal structure. In other words, failure would be unlikely below this limit unless joint infilling material controlled behavior. The next categories [15 to 30°] upper limit of 30° constitutes the approximate basic residual friction angle of all common rock types (Hoek and Bray, 1981). Within this category, failure is possible from joint infilling, water or seismic forces, and/or geometry revision. If the discontinuities have asperities or any great degree of waviness, failure within this category is unlikely. The next categories [30 to 60°], upper limit of

60°, constitutes a conservative expectation of Patton's joint roughness shear strength of equation, $\phi + i$ (Patton, 1966). Within this category, failure is likely for discontinuities exhibiting planar features or having significant amounts of joint infilling. Failure is possible for wavy or rough joints with external forces. The highest category [60 to 90°] represents definite failure for all discontinuities except those with extreme roughness and/or waviness, and near-vertical structure.

An example utilizing the proposed discontinuity orientation adjustments is shown in Figure 6-2 for a portal approach cut in a discontinuous, dipping rock mass. Note that the basic rock mass RMR value of 74, once adjusted for discontinuity orientation, becomes 62 for the tunnel, 69 for the right outer rib, and 24 for the left outer rib. Thus, the critical slope for the portal approach cut is the left outer rib, which would be further analyzed with limit equilibrium techniques.

For guidance toward failure potential, refer again to Figure 6-1. Note that the controlling discontinuity with a dip of 50° into and a strike parallel to the excavation (e.g. unfavorable adjustment rating, -50 points) is in the category of 30 to 60° where failure is likely for planar discontinuities, or discontinuities with appreciable infilling material.

Table 6-1. Rating Adjustment for Discontinuity Orientations, Geomechanics Classification System (Bieniawski, 1984).

ASSESSMENT	CURRENT RMR SLOPE RATING ADJUSTMENT
Very Favorable	0
Favorable	-5
Fair	-25
Unfavorable	-50
Very Unfavorable	-60

Table 6-2. Effect of Discontinuity Strike and Dip Orientations in Tunneling. (Bieniawski, 1984; after Wickham, et al, 1972)

Strike perpendicular to tunnel axis			
Drive with dip		Drive against dip	
Dip 45° - 90°	Dip 20° - 45°	Dip 45° - 90°	Dip 20° - 45°
Very favorable	Favorable	Fair	Unfavorable
Strike parallel to tunnel axis		Irrespective of strike	
Dip 20° - 45°	Dip 45° - 90°	Dip 0° - 20°	
Fair	Very unfavorable	Fair	

Table 6-3. Proposed Discontinuity Orientation Adjustments for Near-Vertical Rock Slopes.

DIP (Degrees)	ASSESSMENT		
	STRIKE II TO SLOPE		STRIKE I TO SLOPE
	DIP INTO EXCAVATION	DIP OUT OF EXCAVATION	
0 - 15	Favorable	Very Favorable	Very Favorable
15 - 30	Fair	Favorable	Very Favorable
30 - 60	Unfavorable	Favorable	Favorable
60 - 90	Very Unfavorable	Fair	Fair

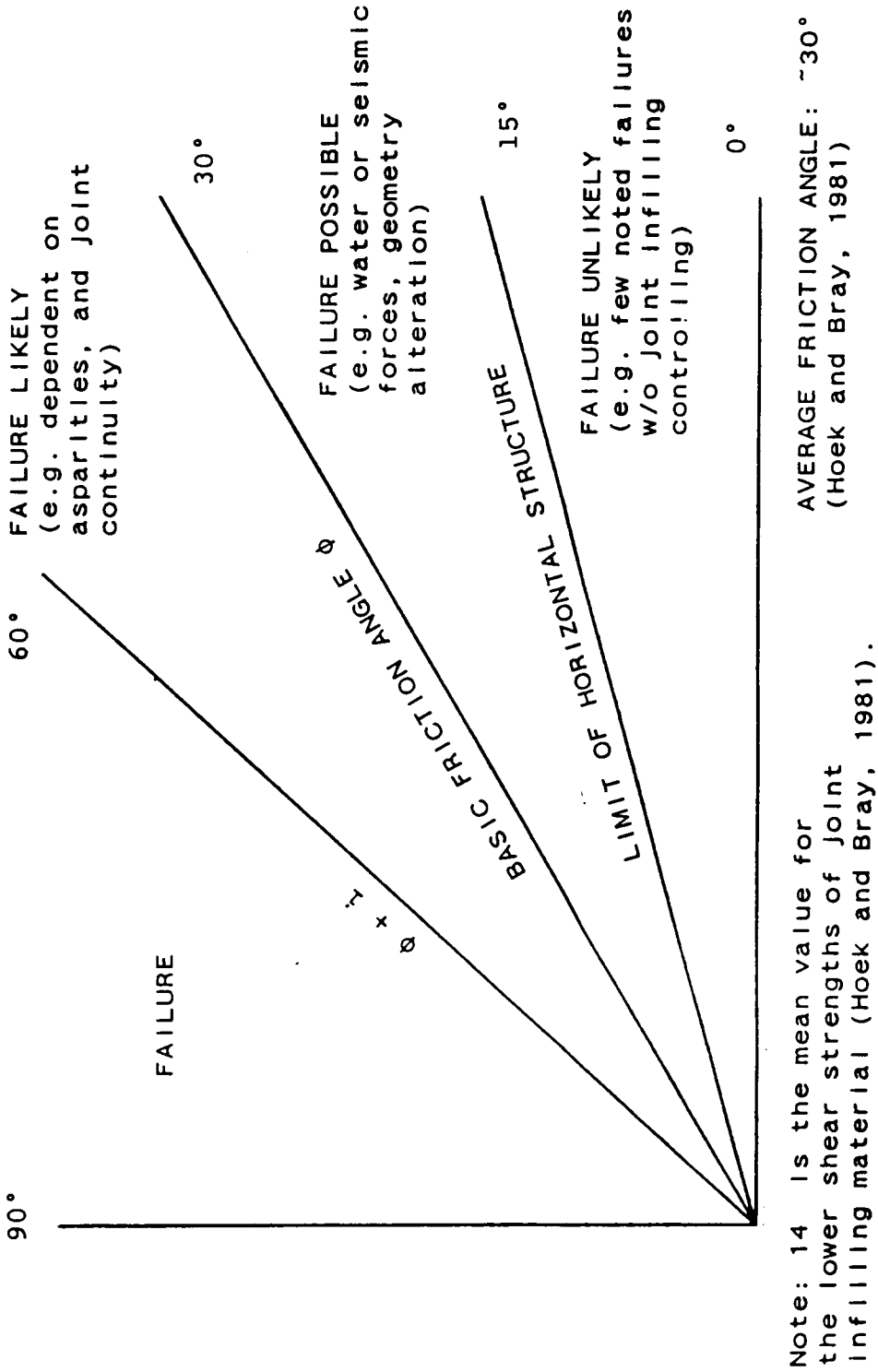

Figure 6-1. Derivation of Dip Categories for the Proposed Discontinuity Orientation Adjustments for Near-Vertical Rock Slopes.

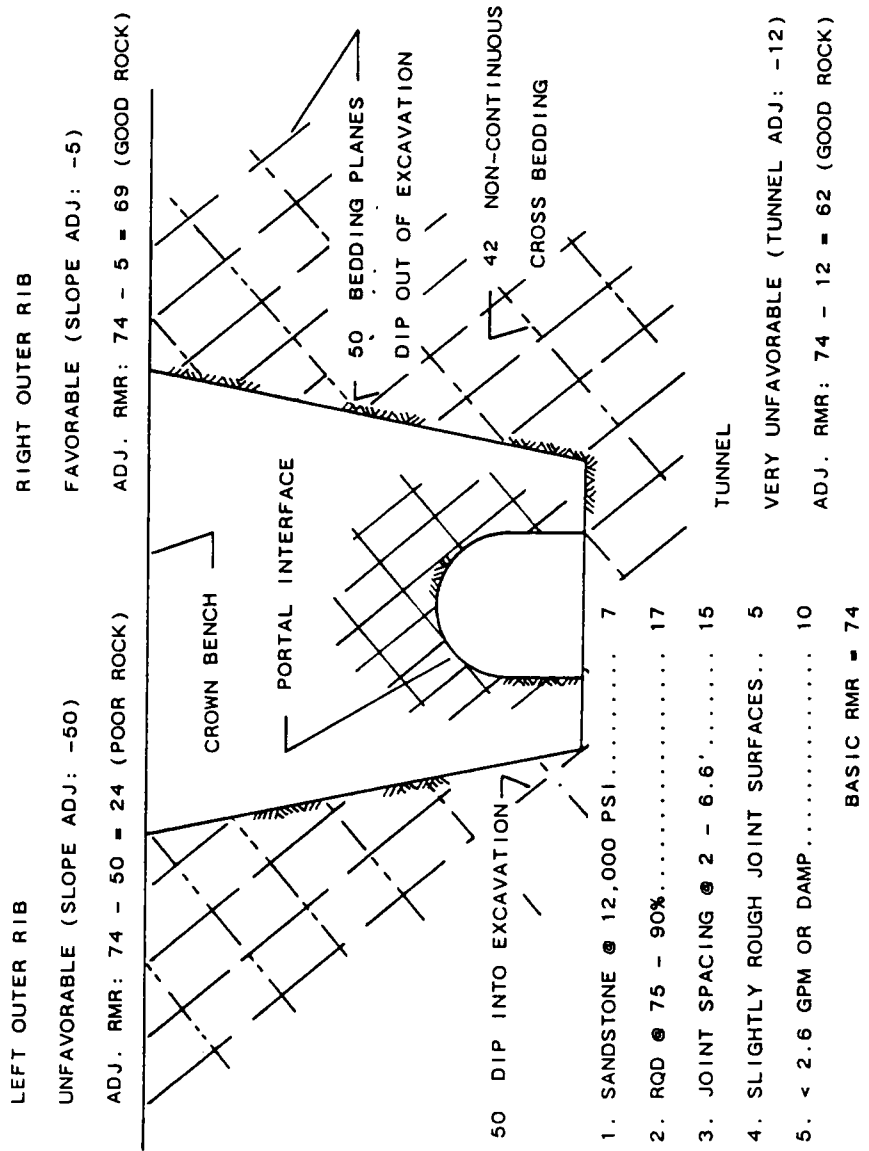

Figure 6-2. Example of Discontinuity Orientation Adjustment for a Portal Approach Cut in a Discontinuous Rock Mass.

6.2 Crown Face Overbreak Model

As previously described and illustrated in Section 4, the 'Crown Face Overbreak' type of failure above the portal interface, is the most common type of failure for active portals. Several approaches were considered for the overall analysis and modelling of 'Crown Face Overbreak' failure, including voussoir arch theory, plate fracture theory, dome theory, and empirical load prediction concepts.

Realistically, the 'Crown Face Overbreak' failure may be described as a three-dimensional voussoir type of failure. Several important insights toward the failure mechanisms that regulate 'Crown Face Overbreak' failure may be gathered from recent research in this area (Denkhaus, 1964; Sepehr and Stimpson, 1988); however, simple two-dimensional voussoir arch models with vertical jointing, even with semi-empirical modifications, do not accurately model the three-dimensional failure and complex structure encountered at the portal interface.

Another approach considered for modelling 'Crown Face Overbreak' failure involved the use of plate or beam theory (Daemen, 1983; Denkhaus, 1964; Sepehr and Stimpson, 1988; Sharp, et al, 1984). Like the voussoir arch model though, it is cumbersome, narrowly focused, and makes too many simplistic assumptions to be reasonably utilized, but

fracture patterns within plate theory do corroborate field observations as to the depth of failure in by the interface.

Dome theory has been applied by many researchers for modelling subsurface failure (Denkhaus, 1964); however, practical use of the theory relies on the basic assumption of a homogeneous, isotropic rock mass. The dome shape concept was pursued nonetheless, because of a similarity, as noted from field observations, with the 'Crown Face Overbreak' failure shape, as illustrated in Figure 6-3. One of the first to recognize the half-dome phenomenon was Terzaghi (Terzaghi, 1946). This transfer of loading concept at a portal from a three-dimensional half-dome to that of a two-dimensional arch is shown in Figures 6-4 and 6-5.

Thus, to model the failure, a half-dome with a parabolic shape was selected due to the similarity with failure shapes from field observations and database information. This parabolic half-dome is described by the following equation:

$$d = W/4 \tan \alpha \quad (\text{after Zhou, 1988}):$$

where: d = maximum height of half-dome,
 W = width of half-dome (e.g. portal diameter),
 α = pillar loading angle = angle of draw.

As to the potential failure dimensions, the width of the half-dome, W , is equal to the portal span. The extent of the half-dome failure, from field observations, averaged one-half of a span in by the portal interface. Thus, the base of the predicted half-dome forms one-half of a circle when illustrated via plan view. If the pillar loading angle, also known as the angle of draw, is known for the rock mass, the height of the half dome may be determined. However, since this value will be unknown for the majority of portal sites, a simpler approach is required.

Early correlations indicated that the height of the parabolic half-dome, d , at the portal interface, was approximately equal to the Geomechanics Classification (RMR) predicted rock load. The Geomechanics rock load is obtained via the following equation:

$$\text{Geomechanics Rock Load (ft)} = \frac{(100 - \text{RMR})}{100} B \quad (\text{Unal, 1983})$$

Where: B = tunnel width in feet,

RMR = Geomechanics rock mass rating.

To refine the abovementioned observation, 30 observed 'Crown Face Overbreak' failure heights were correlated to the rock load as predicted from the Geomechanics Classification. From this correlation, it was determined that the actual 'Crown Face Overbreak' height ranged from 0.6 to 1.5 times the RMR predicted rock load, with a mean of 1.1 times the RMR prediction. Figure 6-6 illustrates this correlation with RMR values plotted against three 'Crown Face Overbreak', CFO, heights: a) Maximum Predicted CFO Height (1.5 x RMR Load Height); b) Actual CFO Height; and c) RMR Predicted Load Height. A power curve regression analysis of the form, $y = ax^b$, was used for the RMR value versus actual CFO height. This regression depicted a gradual decrease in actual CFO height with an increasing RMR, or simply stated, as the quality of the rock mass increases, the height of 'Crown Face Overbreak' decreases. The flatness of the curve is due to a lack of data at the extremities (e.g. Mean CFO Height = 11.4', Standard Deviation = 6.7' and Mean RMR Value = 59, Standard Deviation = 18).

Additionally, thirty-eight portal (e.g. the abovementioned thirty portals plus an additional eight in which the RMR value was unobtainable) spans are also plotted against the actual CFO height. Note that as the span increases, the actual height of CFO increases in a somewhat linear fashion with a median portal span of 50

feet yielding approximately 17 feet of CFO.

Further examples of the predicted 'Crown Face Overbreak' heights are provided in Figures 6-7 to 6-9. These three case histories illustrate cross sectional views (e.g. portal centerline axis) of 'Crown Face Overbreak' failure in high (e.g. RMR = 77), medium (e.g. RMR = 62), and low (e.g. RMR = 19) Geomechanics Classification (RMR) rated rock masses. In each of the examples, the depth of failure in by the portal interface is based on one-half of the portal span (e.g. from field observations and plate fracture theory). In two cases out of three (Figures 6-7 and 6-8), the RMR predicted rock load was less than the actual rock load. In the third case (e.g. Figure 6-9), the RMR predicted rock load was one foot greater than the actual CFO load; however, if the initial portal cut had been extended further in by the interface, the actual CFO height would probably have exceeded the RMR predicted height.

Thus, for Geomechanics Classification use in portal design, the RMR predicted rock load is conservatively appended via the following equation which yields a 'Crown Face Overbreak' height of 1.5 times the RMR rock load:

$$\text{Maximum CFO Height} = \frac{(100 - \text{RMR})}{100} 1.5B$$

Where: B = portal span in feet,

RMR = Geomechanics rock mass rating.

1.5 = multiplier for maximum CFO height determined by field observations.

Also shown in each of the three figures, are the predicted rock load values for the Terzaghi concept and the 'Q' System. Note that the Terzaghi concept, which is generally considered excessively conservative, underpredicted the actual load, by 30 to 60 percent, at the interface for each of the examples. The 'Q' system, which is generally considered one of the more liberal rock mass classification systems, ranged from an underprediction of approximately 40 percent to an overprediction of approximately 250 percent of the actual load. Thus, neither of these two empirical methods are readily suitable, unless modified and/or appended, for portal design.

Additionally, for a back-analysis determination of the pillar loading angle (e.g. angle of draw) as described in the parabolic half-dome equation (Zhou, 1988), and based on

the maximum height of 'Crown Face Overbreak' for the portal half-dome model (e.g. 1.5 times RMR predicted rock load), the following equation may be used:

$$\alpha = \text{Tan}^{-1} [1/(6(100-\text{RMR})/100)]$$

Where: α = pillar loading angle = angle of draw.

RMR = Geomechanics rock mass rating.

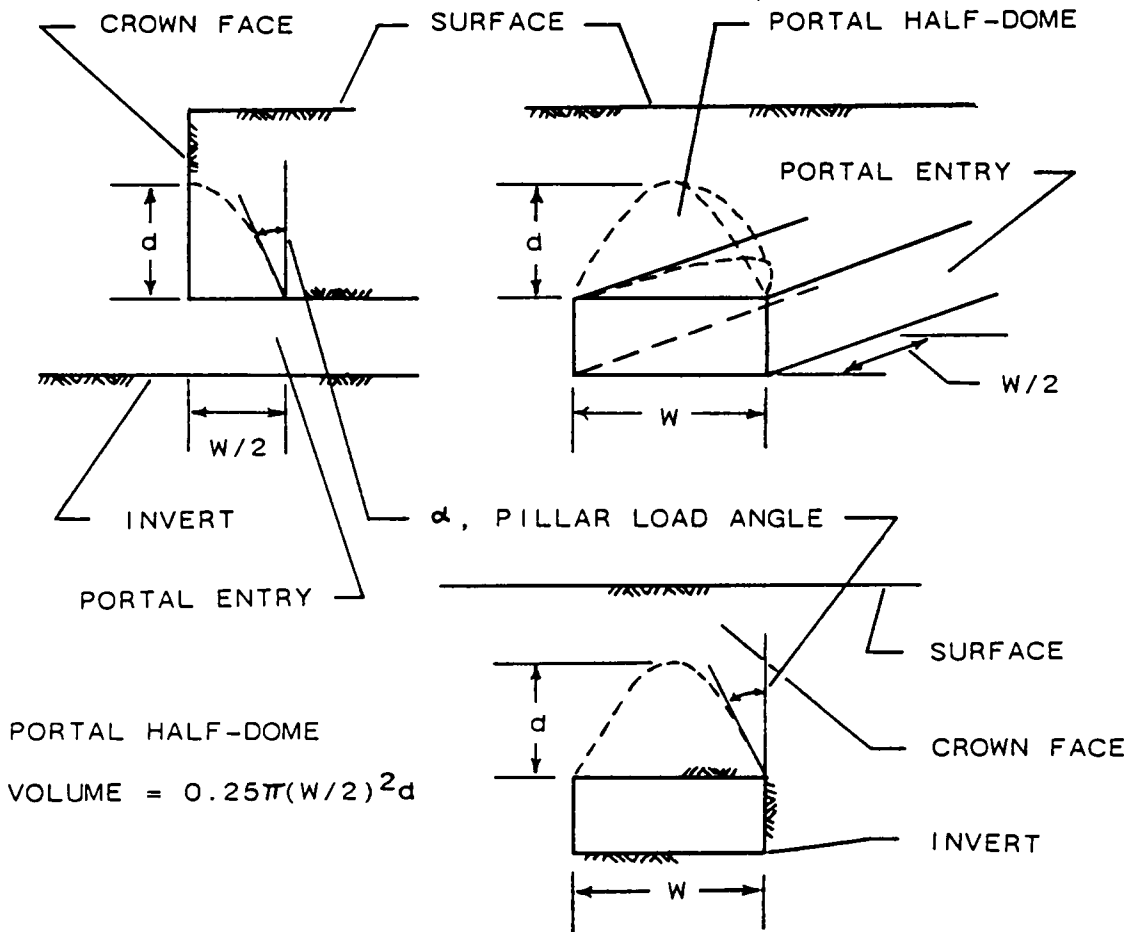

Figure 6-3. Portal Half-Dome, 3-D and Sectional Views.

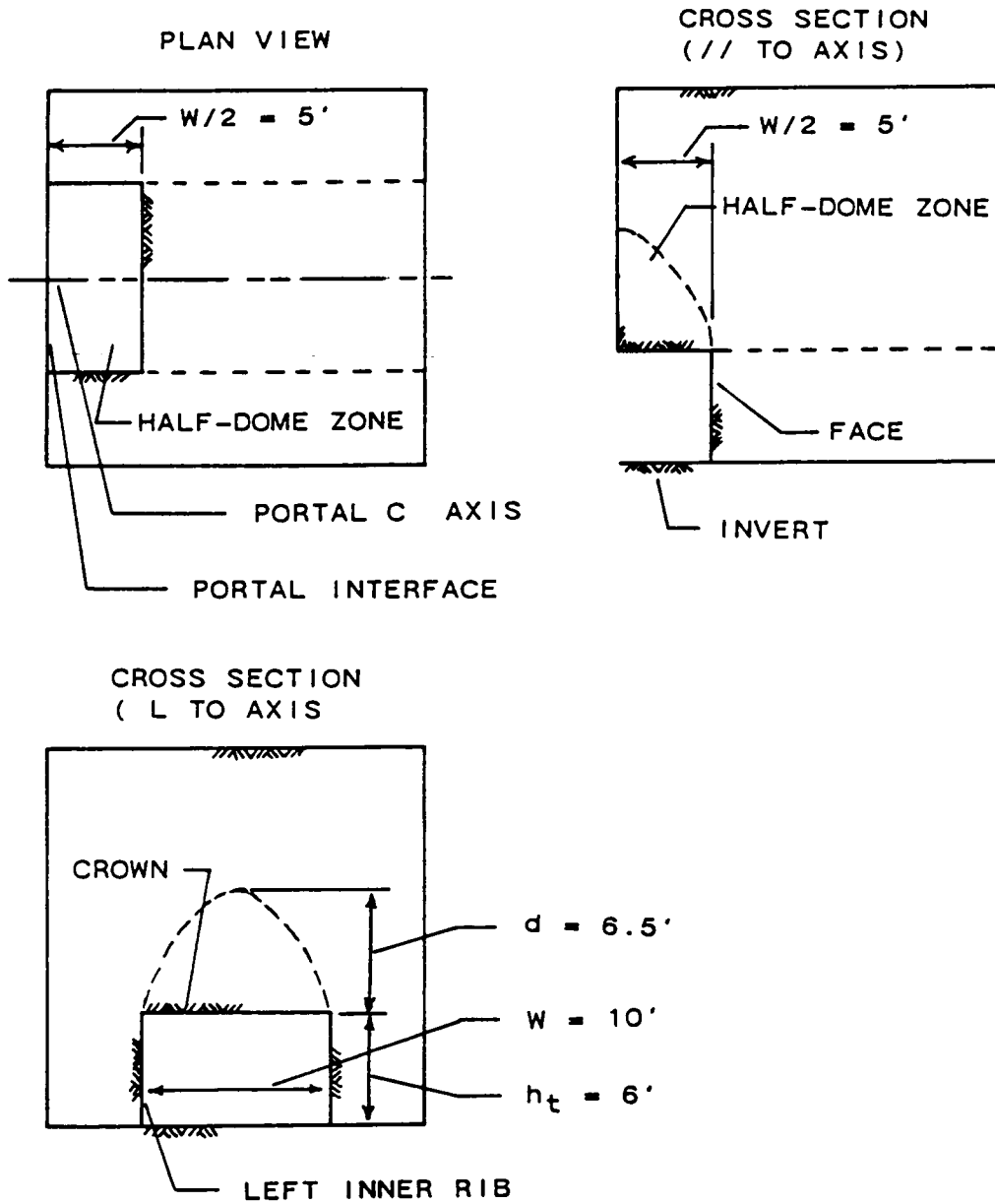

Figure 6-4. Half-Dome Over Initial Portal Excavation (e.g. after one 5' round)(after Terzaghi, 1946.

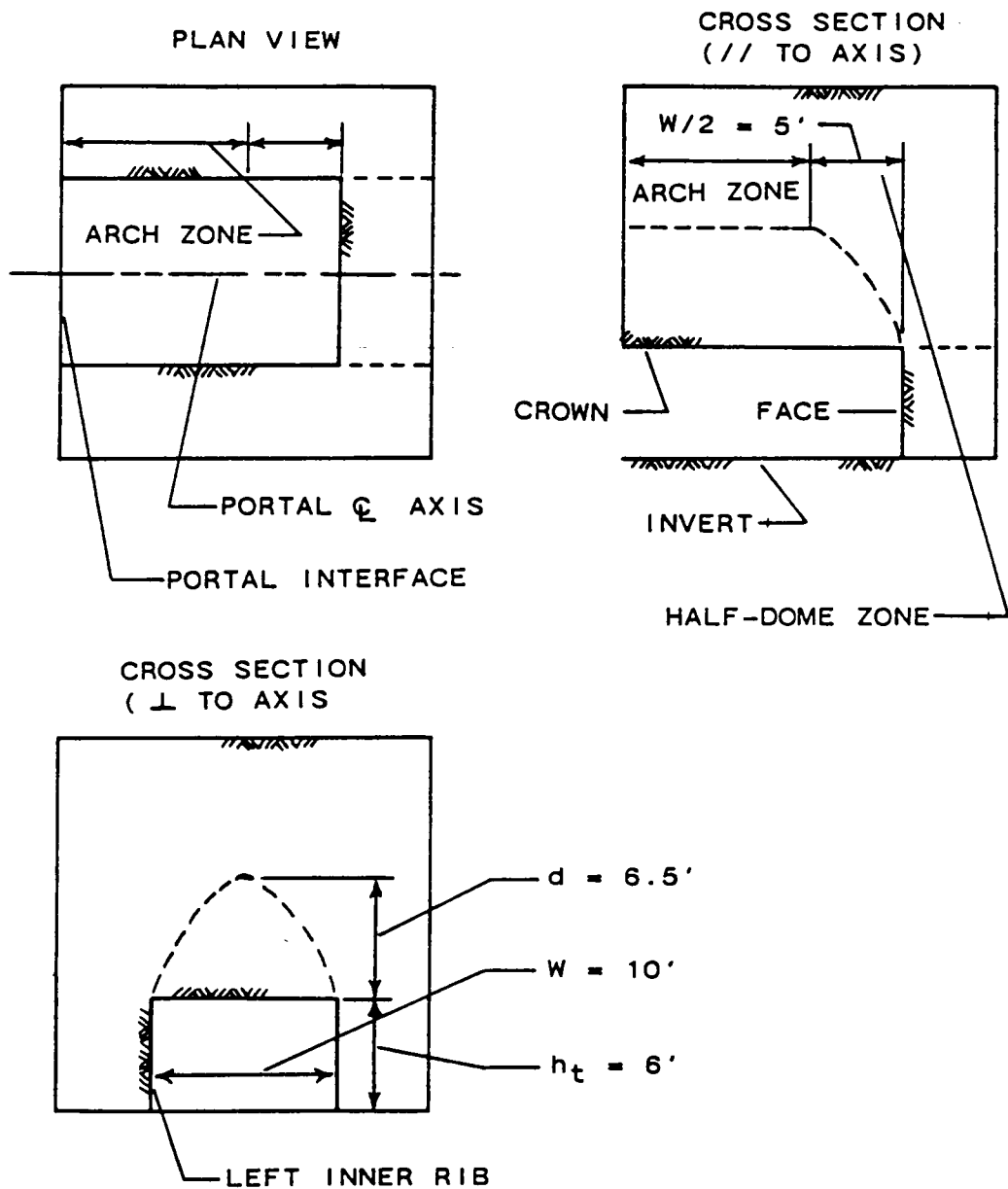

Figure 6-5. Half-Dome and Arch Zone Over Portal Excavation (e.g. after three 5' rounds)(after Terzaghi, 1946).

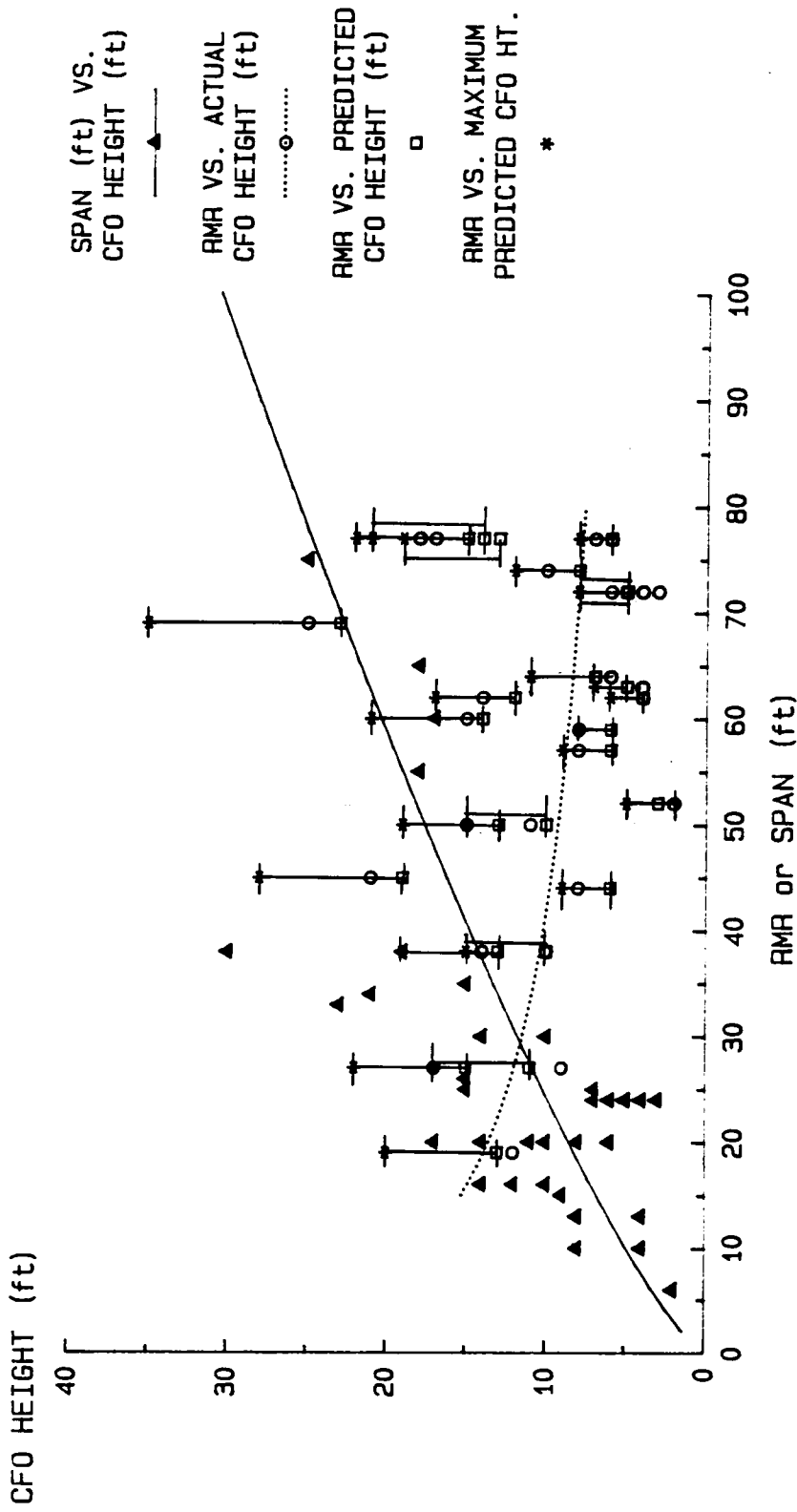

Figure 6-6. RMR and Span Versus 'Crown Face Overbreak' Heights.

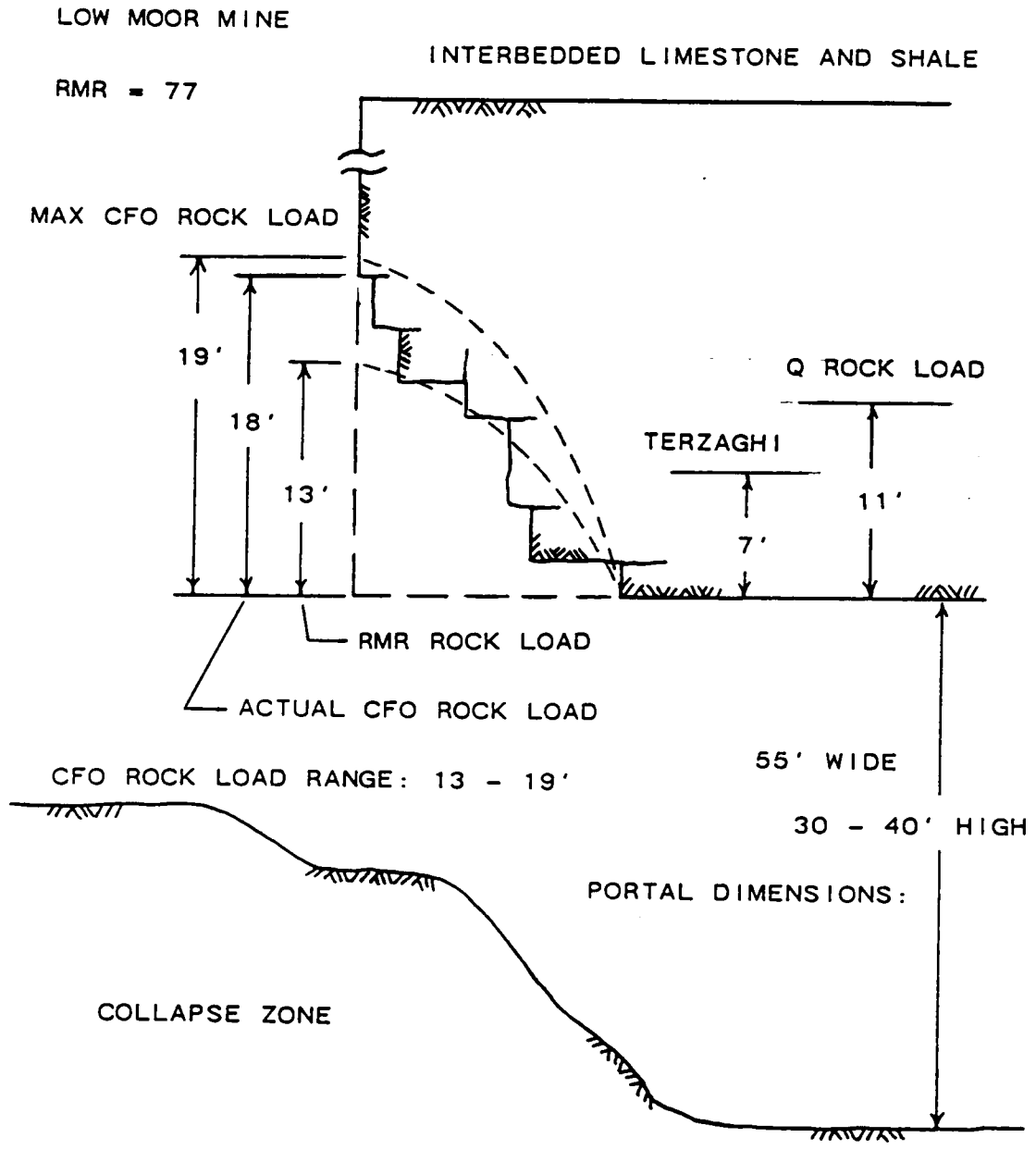

Figure 6-7. 'Crown Face Overbreak' Values - Low Moor Mine.

BAD CREEK PROJECT

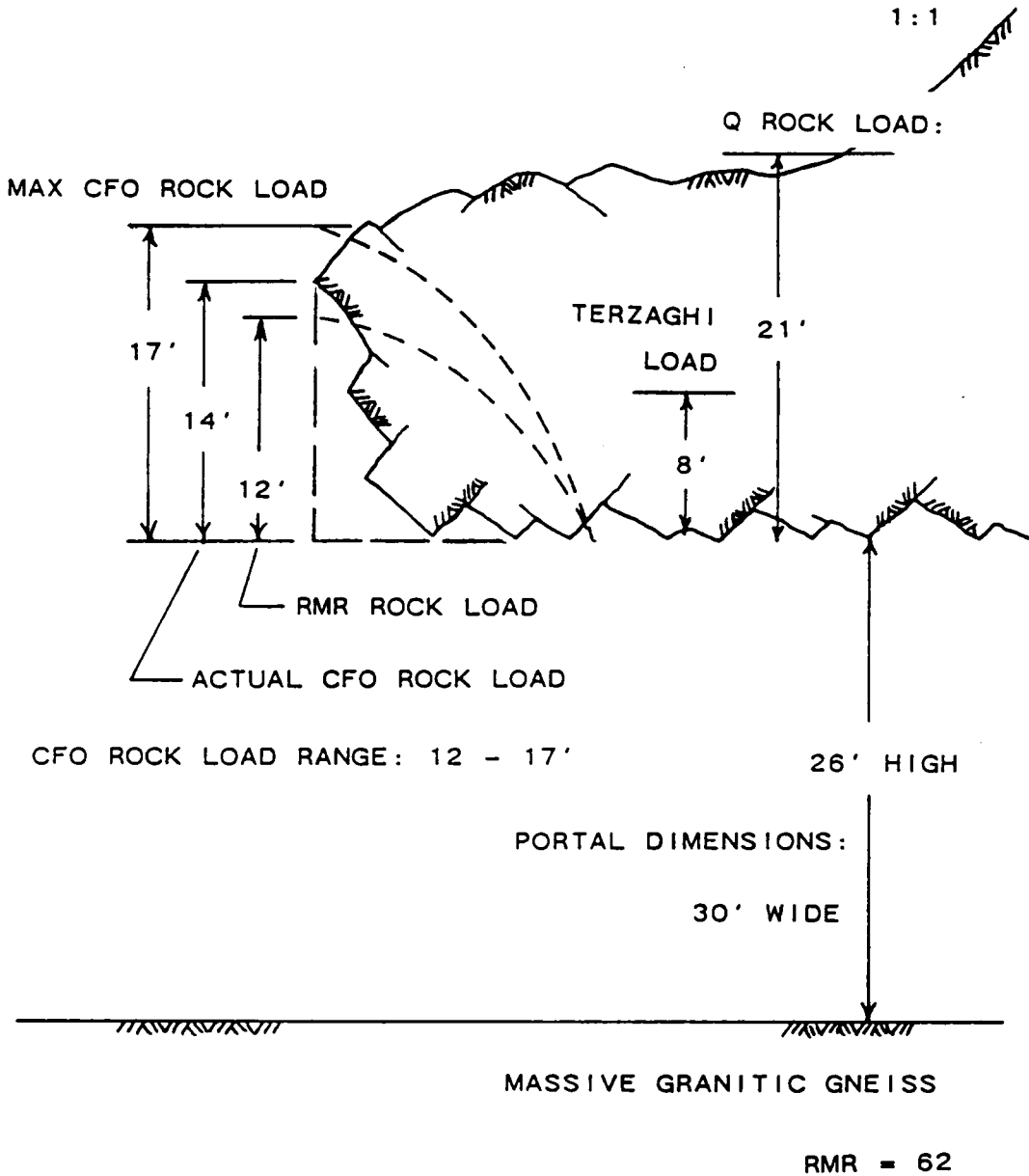
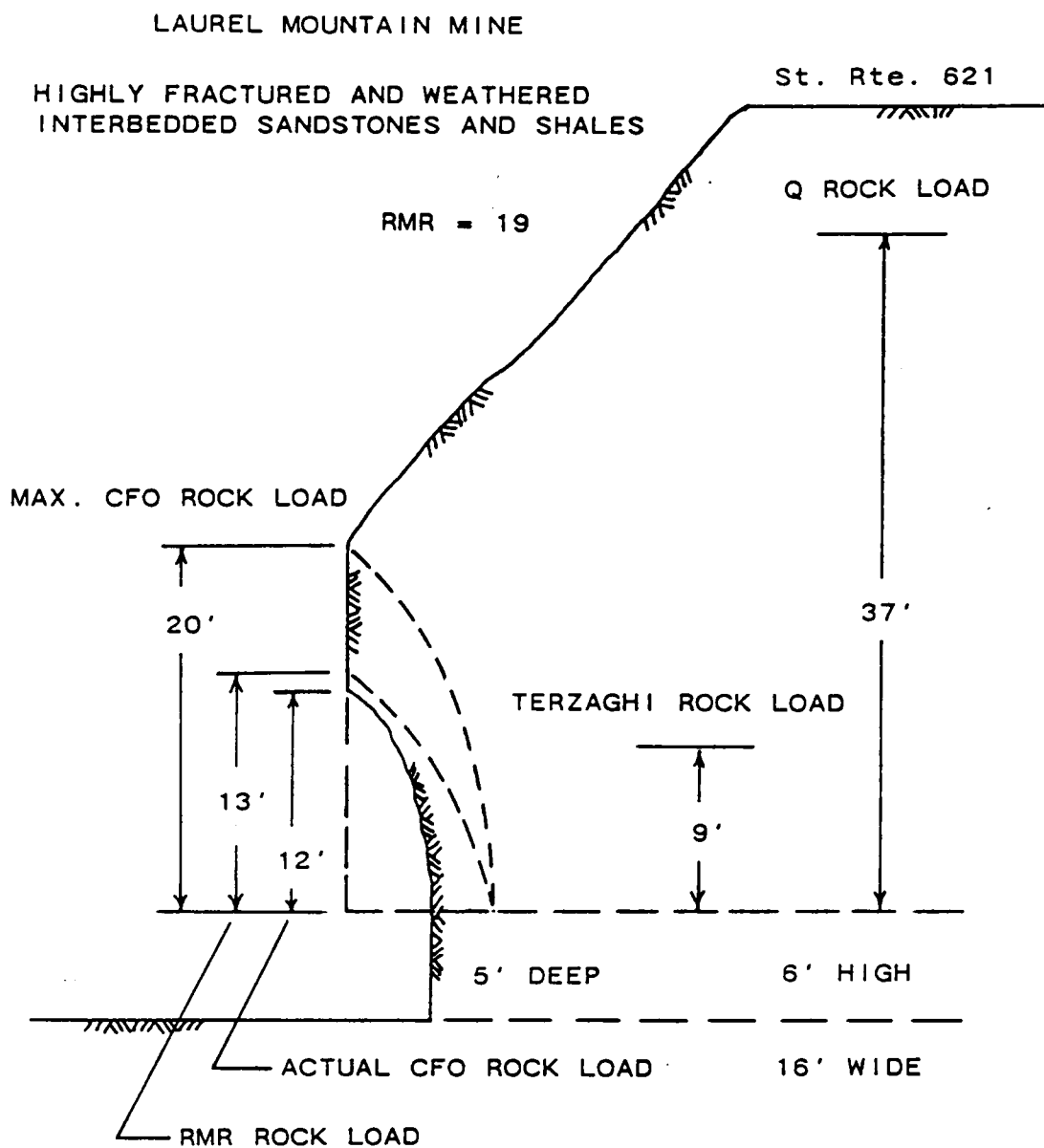

Figure 6-8. 'Crown Face Overbreak' Values - Bad Creek Project.



CFO ROCK LOAD RANGE: 13 - 20'

Figure 6-9. 'Crown Face Overbreak' Values - Laurel Mountain Mine.

6.3 Excavation/Support Guidelines

Though the particular requirements of portals in terms of excavation and support tend to vary greatly, depending upon the dimensions (e.g. span, height) and purpose (e.g. the required factor of safety and design life), and the rock mass characteristics, general guidelines for the Geomechanics Classification have been produced and are shown in Table 6-4. The table is divided into the following four categories; a) Excavation, b) Rock Reinforcement, c) Shotcrete, and d) Steel Sets/Portal Canopy. Guidelines for each of these general categories are provided for the five rock mass classes within the Geomechanics Classification. These guidelines, which are based on the correlation with the four general rock mass classifications within the database in conjunction with case histories possessing specific RMR values, represent typical excavation and support information from the case history database (Section 3) along with pertinent comments from industry personnel (Appendix 3) and various subsurface excavation design references.

6.3.1 Excavation.

The span limitation of 36 feet is based on an average portal span of 21 feet (e.g. 85% of the 500 portal database) plus one standard deviation of 15 feet. Hence,

excavation and support information from the database is assumed to be reasonably valid for portals with spans as great as 36 feet. There are of course portals within the database with much greater spans (Acme, Beavertail, Big Walker, Dutoitskloof, etc.); hence, the span limitation is included so that users will be aware of the built-in data bias.

Within the excavation category, turn-under depths ranged from approximately one half to one span or diameter in more 'Massive' rock (e.g. Cagles, Low Moor [RMR: 77], Kerckhoff 2 [RMR: 77], Vallavik), to two diameters in 'Blocky/Seamy' rock mass conditions (e.g. Alvin R. Bush, Ames, Crozet [RMR: 51]), to over three diameters in poorer quality rock masses (e.g. Alamo, Blue River, Crow [RMR: 22], Sophia [RMR: 38]). This generally follows recommendations from the U.S. Army Corps of Engineers in regards to portal turn-under depths (U.S. Army Corps, 1978). The average turn-under distance was approximately one to two diameters of cover (e.g. Bad Creek [RMR:62], Eggleston [RMR: 45], Racoon, Santa Clara [RMR: 63]).

The sidewall cover and berm width of 1.5 diameters in massive rock to 3 plus diameters in poor quality rock is based on Corps of Engineer recommendations (U.S. Army Corps, 1978). Closer berm widths require special support consideration (e.g. tailrace portals at Bad Creek Project). The berm width between mine portals is sometimes controlled

by legislation (e.g. Laurel Mountain [RMR: 19], Whitby) and typically consists of two to three or more diameters or spans.

As detailed in Section 3, the majority (62%) of the 500 portals investigated were excavated via full-face methods as opposed to 25 percent with top heading and bench methods. The choice of a top heading and bench over a full-face excavation method depends largely on the portal span and height rather than on the quality of the rock mass. The heading and bench technique has been used in 'Massive' rock masses for larger portals (e.g. Buford) and 'Highly Weathered and Fractured' rock masses for smaller portals (e.g. Millets [RMR: 10, 26]). Portals that are relatively tall in respect to the span, such as single bore rail tunnels, also tend to utilize this excavation method (e.g. Mt. Lebanon, Mt. McDonald).

Pilot tunnels were sometimes utilized in 'Blocky/Seamy' rock masses (e.g. Alvin R. Bush, Bad Creek [RMR: 62], Laurel, Saltash); however, their use was more prevalent for the initial evaluation, support, and drainage of larger portals in 'Highly Fractured and Weathered' conditions (Chauderon, Criblette, Kaimai). For extremely adverse conditions, portals were sometimes driven out, instead of in, via adjacent portal access (Laurel Mountain [RMR: 19], Dinorwic 7) or driven with small, multiple drifts (e.g. Aberdeen, Dutoitskloof, Kan-etsu, Rengerhausen).

Crown benches are normally installed for drainage, support installation, and protection against debris falling or raveling from the upper slope. They are more commonly utilized for larger rail, road, and hydro tunnels (e.g. Bad Creek [RMR: 62], Blue River, Fort Pitt, Fort Randall), whereas canopies and/or portal structures are more prevalent for mine portals (e.g. Laurel Mountain [RMR: 19], Oceana, Virginia Lime, Whitby).

Of the portals investigated, 83 percent utilized conventional excavation techniques (e.g. drill and blast methods) or conventional techniques in combination with other methods (e.g. machine, hand, etc.). These excavation methods were often modified to reduce blasting damage and the length of unsupported entry until several diameters in by the interface through the use of short rounds and pre-splitting (e.g. Dinorwic portals, La Grange, Racoon). Portal shields were also employed for initial support and protection in conjunction with conventional or machine excavation for the initial portion of the entry (e.g. Laurel Mountain [RMR: 19]). Other damage reducing measures such as line drilling or rock sawing the portal perimeter should be considered (e.g. Fort Randall, Grayson, Hope Valley, Wilson).

Portals driven in 'Highly Fractured and Weathered' rock masses with high angle approach cuts tended to have long-term slope stability problems in the form of slides and

extreme amounts of raveling (e.g. Ironto [RMR: 36], Sophia [RMR: 38]). Flattened approach cuts are suggested for these conditions.

For portal abandonment consideration and planning, mechanically and pneumatically placed earthen/gravel seals are routinely constructed from 1 to 3 or more diameters in by the portal interface (Cabin Creek, Seijo, 1988).

6.3.2 Rock Reinforcement.

In terms of support, 8 percent of the 500 portals investigated utilized no support, while ~92 percent incorporated some form of support or a portal structure. For 'Massive' rock masses, perimeter bolts or anchors were typically installed in the crown and possibly rib faces from 0.5 to 1 diameter in by the interface. This method of bolting is also known as the umbrella arch technique. Pattern bolts in the portal entry ranged from 0.3 to 1 diameter in length and were typically installed on 4 to 6 foot patterns with wire mesh occasionally placed on the crown, crown face, and ribs (Buford, Dinorwic 3, Kerkhoff II [RMR: 77], Vallavik). Bolting patterns greater than 6 feet were not commonly encountered due to the difficulty with mesh installation. Also, the use of tensioned rock bolts and tendons should be considered as a practical method to gain significant normal forces to prevent the commonly excessive displacements experienced in portal

zones. This maintains the natural asperities and thus ensures higher shear strengths than that which would be possible with lower residual shear strength values (U.S. Army Corps, 1980). Refer to Figure 6-10 for clarification of some of the portal rock reinforcement terminology.

For 'Blocky/Seamy' rock mass conditions, perimeter bolts or anchors were typically installed in the crown and rib faces from approximately 1 to 1.5 diameters in by the portal interface. When designing the perimeter bolting system, consideration should be given to the predicted maximum extent of the 'Crown Face Overbreak' failure as previously described. Pattern bolts in the portal entry ranged from 0.3 to 1 diameter in length and tended to be installed on 3 to 4 foot patterns with mesh commonly installed on the crown, crown face, and ribs (Alamo, Bad Creek [RMR: 62], Dinorwic 1, Flat Top, Grayson, Keyhole, Laurel, Mojave, Mt. Washington, Oceana, Pietratagliata, Pomme de Terre, Pontebba, Raccoon, Sodbury, Thistle, Virginia Lime, Whitby).

In 'Highly Fractured and Weathered' rock masses, perimeter bolts or anchors, often in conjunction with spiling, were installed in the crown and rib faces from approximately 1 to over 3 diameters in by the portal interface. Pattern bolts in the portal entry ranged from 0.3 to over 1 diameter in length and were typically installed on 2 to 3 foot patterns, often with headers

and/or straps. Mesh was commonly installed on the crown, crown face, immediate portions of the upper slope, and ribs. Invert bolting was sometimes utilized and additional slope anchors were sometimes necessary (Beavertail, Blue River, Clap Forat, Criblette, De Gray, Dinorwic 2, Gillham, Herdecke, Laurel Mountain [RMR: 19], Mt. McDonald, new Moelwyn, Oahe, Paillon, Rosti, Saltash, Serre la Voute, Sengg, Spallanzani, Tai Koo, Trans-Koolau).

6.3.3 Shotcrete.

For 'Massive' rock masses and machine bored portals in lower quality rock masses, a 2 inch layer of shotcrete was sometimes sprayed on the crown and crown face areas for support (Feather River [RMR: 79], Kerkhoff II [RMR: 77]. A second 2 inch application was typically necessary for wire mesh utilization. If water control or weathering mitigation concerns existed, a two inch application was sprayed onto the inner and outer ribs (e.g. Santa Clara [RMR: 63]).

For 'Block/Seamy' conditions, up to three applications of shotcrete yielding 4 to 6 inches in total thickness were utilized on the crown and inner ribs, along with 2 to 4 inches of shotcrete typically applied to the upper slope, crown face, crown bench, and outer ribs (e.g. Alesund, Bad Creek [RMR: 62], Junk Bay, Mt. Washington, Pembroke [RMR: 60], Sodbury, Virginia Lime).

In 'Highly Fractured and Weathered' rock masses, shotcrete thicknesses ranged from 4 to over 8 inches for the crown and inner ribs (e.g. Aberdeen, Dinorwic, Lawson, Mt. Lebanon, Mt. McDonald, New Jingpohu, New Moelwyn, Pietratagliata, Platbutsch, Rosti, Saltash, Sengg, Tai Koo, Trans-Koolau). Reinforced concrete slabs were sometimes placed for added stability and prevention of deterioration (e.g. Arco, Beavertail). Again, 2 to 4 inches of shotcrete were typically applied to the upper slope, crown face, crown bench, and outer ribs. Perforated arch-plate lining systems onto which the shotcrete was applied were often utilized for these rock mass conditions both inby and outby the interface (e.d. Dinorwic).

Recent advancements of thick-layer shotcreting may particularly have significant application to portal support design (Cavers, 1988). This new technology enables complete support of a portal with a several foot thick shotcrete application, instead of the traditional multiple thin applications. This would save considerable time and cost, as well as enhancing stability through early support.

Concrete linings for portals ranged from approximately one to over three feet in thickness, with a current trend of from 1 to 2 feet (e.g. Trans-Koolau), and were typically used for projects requiring either a high factor of safety or long design life.

6.3.4 Steel Sets/Portal Canopy.

Portals are often conservatively designed with steel sets for several diameters in by the interface. In 'Massive' rock masses or machine bored portals in lesser quality rock masses, steel sets tend to be light and set on fairly wide spacings of three to six feet with partial wooden lagging (e.g. Santa Clara [RMR: 64], Virginia Lime South). Up to a depth of cover of 2.5 diameters above the crown, full overburden loads are sometimes assumed for conservative designs (Szechy, 1973; Industry Comments, Appendix 3).

For 'Blocky/Seamy' conditions, steel sets tend to be of medium to heavy weight at somewhat closer spacings of two to four feet with partial to full wooden lagging (Bad Creek [RMR: 62], Quinamont [RMR: 64], Tenkiller).

In 'Highly Fractured and Weathered' rock masses, very heavy steel weight sets are commonly utilized in conjunction with backfilling operations, also known as cut-and-cover techniques (e.g. Birch [RMR: 38], German Creek, Kaimai, Laurel Mountain [RMR: 19], Paillon, Rosti). In these conditions, steel sets are typically set on close two foot spacings with full steel and/or concrete lagging (e.g. Virginia Lime North). To prevent invert deterioration, support punching, and to add to overall system rigidity, the invert is often closed with steel sets or a reinforced concrete pad (e.g. Beavertail, Jubilee, Trans-Koolau).

Steel sets, or wood in older portals, were sometimes initiated outby the interface (e.g. false sets) thereby forming a canopy (e.g. Blakely Mt., De Gray, TenKiller). Canopies and/or screens are usually required by regulatory agencies as protection to personnel and equipment from falling debris (e.g. Birch [RMR: 38], Oceana, Whitby). They are typically one or more diameters in length outby the interface. Canopies have also been utilized as prevention against icicle formation and avalanche protection (e.g. Feather River). As the quality of rock decreased, canopies tended to increase in size, length, and capacity. Road tunnels often combine the protective function of the canopy with light-reducing characteristics for transitional eye adjustment (e.g. Big Walker, East River). Warning devices may be incorporated into protective screens and are commonly seen at rail portals (e.g. Eggleston [RMR: 45], Pembroke [RMR: 60]).

6.3.5 Design Philosophy.

In designing portal support systems, it should be noted that portals typically exist in rock mass conditions where the formation of an effective ground arch is often inhibited, thus allowing more load to be contributed to the support system. In situations such as this, it is customary practice to utilize dual support systems, temporary and permanent, each being capable of carrying the

full predicted overburden load plus some conservative allowance for possible future loads (Lane, 1975). Hence, the support categories in Table 6-4 may be combined for a portal design. For example, it is quite common to utilize fully lagged steel sets for a canopy and several diameters of temporary support in by the interface, in conjunction with rock bolts and shotcrete. This may be followed by a permanent, cast concrete liner. An example of this is illustrated in Figure 6-11, which shows a combination of steel sets, mass concrete, rock bolts, shotcrete, rock anchors, and a tie-back retaining wall as utilized to support the main access tunnel portal for the Bad Creek Pump-Storage Project, South Carolina (Steffen, 1988).

Comparison of the suggested portal support guidelines with other empirical tunnel support guidelines (Bieniawski, 1984; Barton, 1974; U.S. Army Corps, 1978, 1980) acknowledges that the portal support guidelines are approximately comparable, if not slightly more conservative. This reinforces the support trend information (e.g. heavier, longer, and multiple support systems) from the portal database.

These suggested guidelines should not be utilized to the exclusion of other analytical, observational, and empirical methods. Instead, the portal excavation/support guidelines should be used for preliminary planning and design purposes, in conjunction with other methods for the

rational formulation of an efficient and safe overall design. Also, they should be checked against field observations and measurements, and adjusted to the site specific conditions.

Table 6-4. Portal ($\leq 36'$ Dia.) Excavation/Support Guidelines for the Geomechanics Classification System.

ROCK MASS CLASS	EXCAVATION ^{3, 4, 5}	ROCK REINFORCEMENT ⁸	SHOTCRETE ^{9, 10, 11, 12}	STEEL SETS/PORTAL CANOPY
1. Very Good Rock RMR: 100 - 81 'Massive'	Turn under w/min. 0.5 to 1+ D cover. Full face. Crown bench optional. Sidewall cover ⁶ & berm width ⁷ @ 1.5+ D. Full length rounds.	Perimeter bolts/anchors as required @ 0.5 - 1 D inby interface. Spot bolts @ 0.3+ D long as necessary.	2 - 4 in. on crown & crown face as required.	Canopy optional, no steel sets.
2. Good Rock RMR: 80 - 61 'Massive'	Turn under w/min. 1 - 2+ D cover. Full face or top heading and bench. Crown bench. Short rounds.	Perimeter bolts/anchors @ 1+ D inby interface. Pattern bolts @ 0.3+ D long, spaced @ 4 - 6 ft. w/occasional mesh on crown, crown face, and ribs.	2 - 4 in. on crown & inner ribs, 2 in. on crown face, crown bench, & outer ribs.	Light canopy, 1+ D in length. Light ribs @ 3 - 6 ft. centers w/partial lagging.
3. Fair Rock ² RMR: 60 - 41 'Blocky/Seamy'	Turn under w/min. 2+ D cover. Top heading and bench. Pilot tunnel optional. Crown bench. Short rounds.	Perimeter bolts/anchors @ 1 - 1.5+ D inby interface. Pattern bolts @ 0.3 - 1+ D long spaced @ 3 - 4 ft. w/mesh on crown, crown face, and inner/outer ribs.	4 - 6 in. on crown & inner ribs, 2 - 4+ in. on upper slope, crown face, crown bench, & outer ribs.	Medium to heavy canopy, 1+ D in length. Medium steel sets @ 2 - 4 ft. centers w/full lagging.
4. Poor Rock ² RMR: 40 - 21 'Highly Fractured'	Turn under w/min. 2+ D cover. Top heading and bench. Crown bench. Very short rounds. Pilot tunnel recommended.	Perimeter bolts/anchors & spiling @ 1 - 2+ D inby interface. Pattern bolts @ 0.3 - 1+ D long spaced @ 2 - 3 ft. w/mesh in crown, crown face, & upper slope, & inner/outer ribs. Additional slope anchors & invert bolting optional.	4 - 8+ in. on crown & inner ribs, 2 - 4+ in. on upper slope, crown face, crown bench, & outer ribs. 2+ in. on face. Reinforced invert. Concrete lining.	Heavy canopy, 1+ D in length. Steel sets @ 2 ft. centers w/full steel or pre-cast concrete lagging. Buttress supports optional. Close invert.

Table 6-4. (Continued).

5. Very Poor Rock RMR: < 20 'Highly Weathered or Shattered'	Turn under w/min. 2 - 3+ D cover. Top heading and bench or multiple drifts. Pilot tunnel recommended. Shield excavation optional. Flattened approach cut slopes. Sidewall cover ⁶ & beam width ⁷ @ 3+ D. Very short rounds.	Perimeter bolts/anchors & spiling @ 1 - 3+ D inby interface. Pattern bolts @ 0.3 - 1+ D long spaced at 2 - 3 ft. w/mesh in crown, crown face, upper slope, inner/outer ribs, & invert. Additional slope anchors as necessary.	4 - 8+ in. on crown & inner ribs, 2 - 4+ in. on upper slope, crown face, crown bench, & outer ribs. 2+ in. on face. Reinforced invert. Concrete lining.	Out-and-cover approach type canopy, 1 - 2+ D in length, and/or buttress supports. Heavy steel sets on 2 ft. centers w/full steel or pre-cast concrete lagging. Close invert.
---	--	---	--	--

- 1 Mean portal span (21') from database plus one standard deviation (15').
- 2 Majority of portal failures observed in these two classes.
- 3 Drill and blast techniques are the most commonly used portal excavation methods.
- 4 Methods used to reduce portal damage (e.g. line drilling, rock sawing, pre-splitting, smooth blasting, grouting, recessed anchor installation, etc.) should be considered.
- 5 For abandonment considerations, portal seals (e.g. plug, backfill) typically range from 1 to 3 D in length inby the interface (Seijo, 1988).
- 6 Distance between portal/tunnel and valley wall (U.S. Army Corps, 1978).
- 7 Distance between adjacent portals (U.S. Army Corps, 1978).
- 8 Active, resin/grout reinforcement systems should be considered to reduce rock mass dilation (U.S. Army Corps, 1980).
- 9 Up to a depth of cover of 2.5 D above the crown, full overburden loads are often assumed for conservative designs (Appendix 3, Szechy, 1973).
- 10 Steel fiber microsilica shotcrete may be used to reduce cost and thickness (Overlie & Rippentropp, 1987).
- 11 Seismic assessment/design (e.g. minor damage to portals a peak surface accelerations in the range of 0.2 to 0.5g; Pratt, et al, 1979) and surface/subsurface drainage provisions suggested for all portal classes.
- 12 Concrete linings for portals typically varied from approximately one to over three feet, with a current trend of one to two feet.

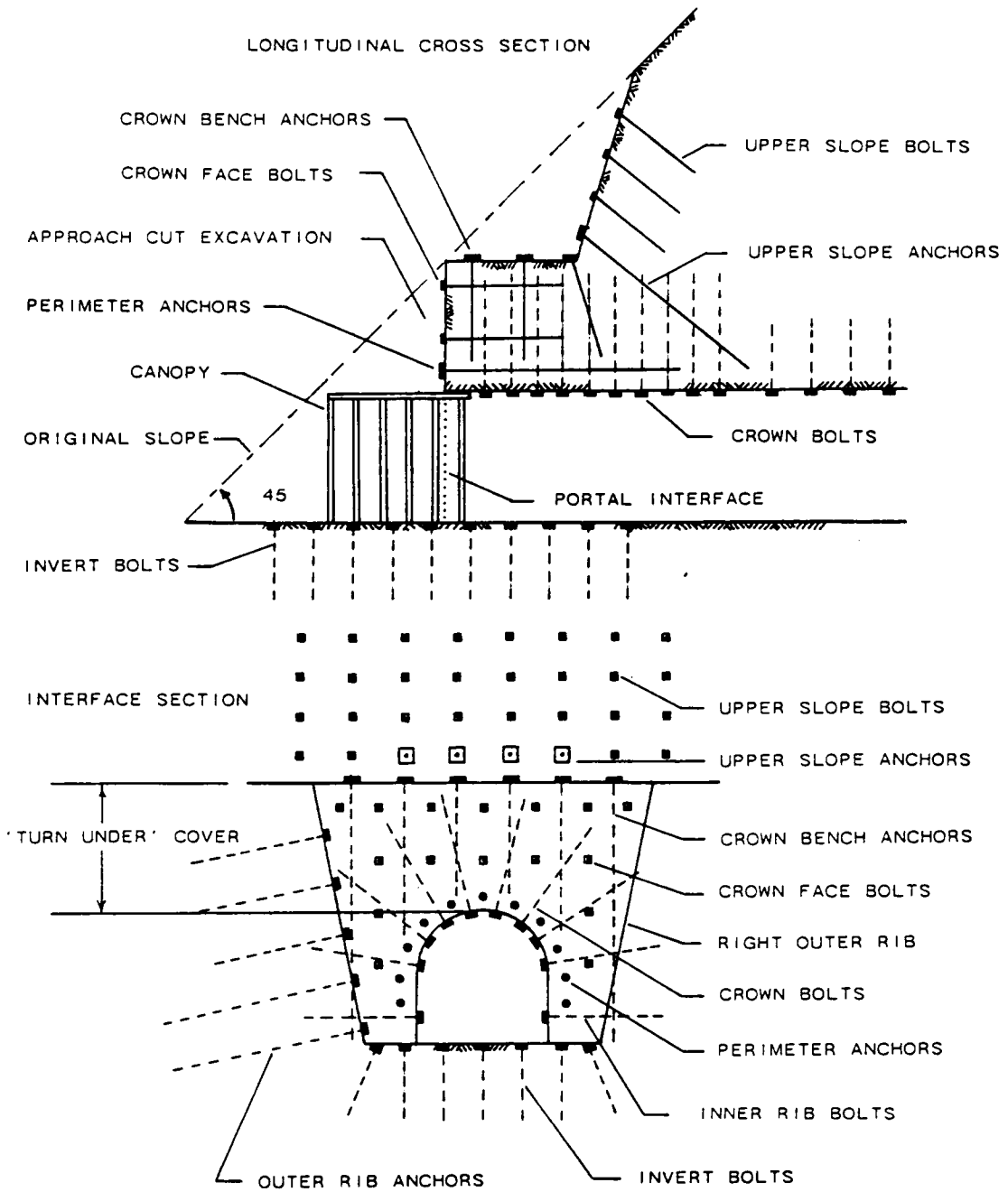

Figure 6-10. Example of Portal Rock Reinforcement.

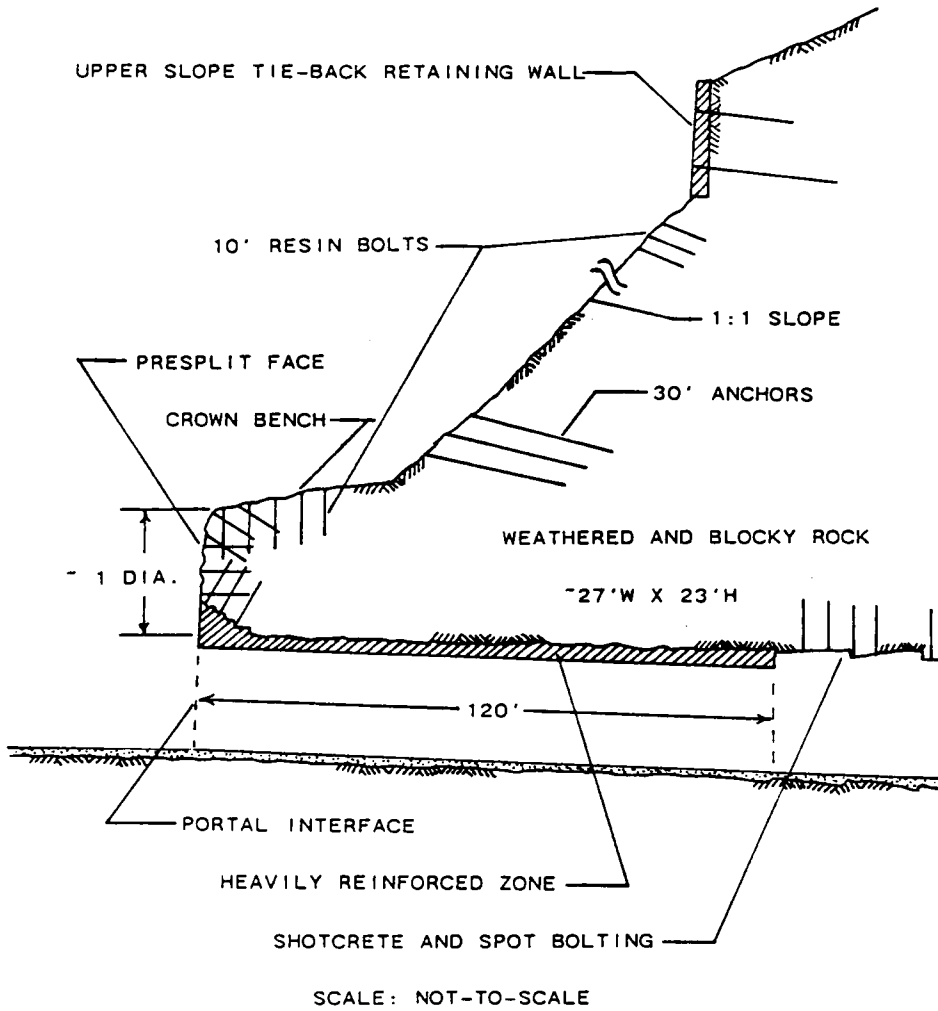

Figure 6-11. Multiple Support Systems Utilized at the Main Access Tunnel Portal - Bad Creek Project Case History.

7.0 SUMMARY, CONCLUSIONS, AND RECOMMENDATIONS

7.1 Summary

The portal is defined as a near-horizontal, surface zone of entry to an underground excavation whose primary purpose is to provide safe egress for men, materials, and equipment over a definable project life. The features of the portal have been defined and profusely illustrated.

The history, types, uses, and hazards of portals were discussed along with key factors that may affect stability or are relative to a stability assessment, such as the in situ state of stress, seismic effects, costs, regulatory legislation, and contractual concerns. A simple method based on bulking theory for determining the approximate surface extent of a portal subsidence trench for hazard planning was also examined, in addition to various commonly used damage alleviating and remedial measures.

A database with information on 500 portals was compiled from an extensive literature review and field investigation. The information gathered for each case history includes the name, location, type, date built, age, dimensions, rock mass description, type of difficulty, type of failure, length of difficulty, support and damage alleviating measures, excavation section and method, and

reference. Distribution charts were prepared for each of the abovementioned categories. Various significant correlations were made between rock mass classes, failure types, and lengths of difficulty. Additional information was gleaned from comments on portal difficulties, support techniques, and general design philosophies which were canvassed from experienced industry personnel.

For ease of reference, the database was abbreviated into a tabular format with one line of information per portal and is presented in Appendix 3. A more detailed synopsis version (e.g. 304 pp.), with one to three pages of information per case history, was prepared to aid in support and excavation planning by industry designers as well as future research by academic and government institutions. This separate document is available upon request from the Mining and Minerals Engineering Department, Virginia Tech.

Portal failures were classified into four external and four internal types. The external failure types are; a) Overall Mass Slide, b) Upper Slope Slide, c) Outer Rib Slide, and d) Subsidence/Collapse. The internal failure types are; a) Crown Face Overbreak, b) Internal Collapse, c) Invert Failure, d) Seal Rupture.

Various analysis approaches were examined for assessing portal stability, with three-dimensional stereographic, two-dimensional limit equilibrium, and empirical rock mass

classification systems being selected as most pertinent for preliminary portal stability assessments. A systematic approach methodology utilizing these methods was proposed.

A particularly useful two-dimensional, limit equilibrium slope stability analysis method, the Sarma/Hoek method of non-vertical slices, was examined, modified slightly, and is recommended due to the excellent simulation capabilities for discontinuous rock masses at portals.

The Geomechanics Classification was appended to aid in the determination of critical sections of rock slope for detailed analysis. Furthermore, the Geomechanics Classification rock load prediction was utilized in the modelling of the most common type of active portal failure. Excavation and support guidelines, based on the database information, were developed.

Appendices 1 through 4 are comprised of additional portal nomenclature illustrations, portal and industry references, the table version of the portal database, and a listing of the modified Sarma/Hoek method of non-vertical slices code.

Thus, in summary, portals require flexible, yet conservative design, contractual, support, and construction measures due to typically difficult ground conditions and other stability-affecting factors in near-surface, discontinuous, and weathered rock masses. The additional

cost for the conservative approach will normally be offset by their potentially high costs for major remedial action and/or project delays in case of failure.

7.2 Conclusions

- a) Based on analysis of the database and comments from industry personnel, the majority of the portals investigated;
1. were driven in poor ground conditions,
 2. had experienced one or more types of failure (the most common type for active portals was 'Crown Face Overbreak' and for abandoned portals, 'Subsidence/Collapse'),
 3. required more support than comparable in situ portions of the associated underground excavation.
- b) Correlations between the rock mass classes and failure types from the database indicate that:
1. The greatest percentage of failures occur in rock masses classified as 'Blocky/Seamy' (44%), while the second greatest percentage occur in 'Highly Fractured' (35%) rock masses.
 2. Within the individual rock mass classes, the failure types differ, with the 'Crown Face Overbreak'

failure type predominating in the 'Blocky/Seamy' and better quality rock classes, whereas the 'Subsidence/Collapse' failure type predominates in the 'Highly Fractured' and poorer quality rock classes. Hence, the trend for half-dome failure formation (e.g. 'Crown Face Overbreak') in less discontinuous rock masses versus that of total collapse and/or subsidence was ascertained.

3. As the quality of the rock mass decreases, the length of difficulty increases. For example, the length of difficulty for 'Subsidence/Collapse' failure in a 'Highly Fractured' rock mass was greater than in a 'Blocky/Seamy' rock mass.

- c) A combination of empirical rock mass classification, three-dimensional stereographic, and two-dimensional limit equilibrium methods techniques was deemed most suitable for preliminary portal stability assessment investigations. Of the five rock mass classification systems considered, the Geomechanics Classification (RMR) was deemed most applicable for portal assessment utilization.
- d) Utilizing the selected analysis techniques, the following systematic approach to portal stability analysis was recommended:

1. Site Characterization - The site characterization, which ascertains the overall geologic structure and other stability affecting factors, may be accomplished via use of the Geomechanics Classification (RMR) System.
 2. Overall Slope Stability Assessment and c) Approach Cut Slope Stability Assessment - Standard two and three-dimensional limit equilibrium techniques in combination with stereographic methods are recommended for the overall and approach cut slope stability analyses.
 3. Subsurface Portal Entry Stability Assessment - Standard design approaches including the Geomechanics Classification may be conservatively utilized for the subsurface design; however, the unusually high rock loads encountered at the portal interface due to 'Crown Face Overbreak' failure require special assessment.
- f) To locate critical sections of the typically high-angle approach cut slopes for analysis, the Geomechanics Classification was appended with rock slope discontinuity orientation adjustments, which are similar to existing adjustments for tunnels and foundations.
- g) A theoretical model for the 'Crown Face Overbreak'

failure type, based on the field-observed formation of a parabolic half-dome above the portal interface was developed. The height of the half-dome is defined by an appended Geomechanics Classification rock load height. Case histories were used to illustrate the failure predictions from this model as compared to Terzaghi's Rock Load Concept and the 'Q' System. The Terzaghi Concept tends to underpredict actual loading conditions, whereas the 'Q' System was typically over-conservative.

- i) Excavation and support guidelines for the Geomechanics Classification, based on both successful and unsuccessful turn-under attempts from the database, were developed and include notes pertaining to specific portal design concerns, such as damage causing seismic load limits, and minimum 'turn-under' depths.

7.3 Recommendations

Recommendations for further research include:

- a) Utilizing the database for formulation of an expert computer system for portal design.

- b) Applying the 'Crown Face Overbreak' failure model to shaft station insets and other underground intersections (e.g. tailrace tunnels intersecting a larger power house excavation) to help quantify difficulties in these areas.

- c) Refining and expanding both the discontinuity orientation adjustments for rock slopes and the excavation/support guidelines through further application and documentation.

- d) Investigating the seismic response of portals and other shallow surface excavations in rock.

- e) Modelling portal seal design as a short dam with a surcharge on the crest to investigate hydrostatic pressure limits, drainage measures, seismic response, and long term behavior.

REFERENCES

- Abersten, L. and Rebonato, A. 1985. "Vibration Control During Blasting Through the Italian Dolomites." Tunnels and Tunnelling. Volume 17, Number 11, November. Morgan-Grampian Ltd., London, UK. pp. 25-28.
- Abramson, L.W., Daly, W.F. 1986. "Analysis and Rehabilitation of Aging Rock Slopes." Unpublished Presentation to North Carolina Highway Geology Meeting. Parsons Brinckerhoff Quade & Douglas, Inc. New York. 18 pp.
- Ackenheil, A. 1987. "Ft. Pitt Tunnel North Portal Cut Slopes Revisited." HGS-87-5. Proceedings of the 38th Annual Highway Geology Symposium - Highway Construction in Unstable Topography. Pittsburg, Pennsylvania. May 11 - 13. Pennsylvania Department of Highways and Engineers' Society of Western Pennsylvania.
- Adams, J.W. 1978. "Lessons Learned at Eisenhower Memorial Tunnel." Tunnels and Tunnelling. Volume 10, Number 5, May. Morgan-Grampian Ltd., London, UK. pp. 20-23.
- Aerni, K. and Mettier, K. 1981. "Ground Freezing Aids Swiss Tunnel Construction." Tunnels and Tunnelling. Volume 13, Number 4, April. Morgan-Grampian Ltd., London, UK.
- Agricola, G. 1556. De Re Metallica. 1950 Reprint of 1912 Translation by H.C. and L.H. Hoover. Dover Publications, Inc. New York, New York.
- "Alpine Bores Blocked by Snow." 1981. Tunnels and Tunnelling. Volume 13, Number 1, January. Morgan-Grampian Ltd., London, UK. p. 7.
- Amadei, B., Savage, W.Z., Swolfs, H.S. 1987. "Gravitational Stresses in Anisotropic Rock Masses." International Journal of Rock Mechanics and Mining Sciences & Geomechanics Abstracts. Volume 24, Number 1. February. Pergamon Journals Ltd. pp. 5-14.
- Associated Press. 1988. "Earthquake Probable in East, Expert Says." Roanoke Times & World-News. Wednesday, October 5. p. A3.

- Atlas Powder Company. 1987. "Trim Blast Delay Pattern Eases Shaft Work. Atlas Blasting News. Volume 13, Number 3. Tyler Corporation Subsidiary. Dallas, TX. Fourth Quarter.
- Barisone, G., Pelizza, S., and Pigorini, B. 1983. "Italian Experiences with Tunnel Portals in Difficult Ground." Eurotunnel '83 Conference, Paper 21. Access Conferences Ltd. Marlow, UK. pp. 157-163.
- Barton, N., Lien, R. and Lunde, J. 1974. "Engineering Classification of Rock Masses for the Design of Tunnel Support." Rock Mechanics. Volume 6, Number 4. pp. 183-236.
- Barton, N. and Bandis, S. 1982. "Effects of Block Size on the Shear Behavior of Jointed Rock." Chapter 76. Issues in Rock Mechanics - Proceedings of the Twenty-Third Symposium on Rock Mechanics. SME-AIME. New York, New York. pp. 1091-1098.
- Beckley Post-Herald. 1968. "49 Men Trapped by a Rock Fall." Volume 69, Number 117, May 15, P. 1.
- Beer, G. and Meek, J.L. 1982. "Design Curves for Roofs and Hanging walls in Bedded Rock Based on Voussoir Beam and Plate Solutions." Transactions of the Institution of Mining and Metallurgy. Volume 91. pp. A18-22.
- Belesky, R.M. and Hardy, H. Jr. 1986. "Seismic and Microseismic Methods for Cavity Detection and Stability Monitoring of Near-Surface Voids." Chapter 38. Rock Mechanics: Key to Energy Production - Proceedings of the 27th U.S. Symposium on Rock Mechanics. SME-AIME. Littleton, Colorado. pp.248-258.
- Bendelius, A.G. 1982. "Drainage Systems." Chapter 24. Tunnel Engineering Handbook. Van Nostrand Reinhold Company, Inc. New York, New York. pp. 631-651.
- Bennett, R.D. 1981. Tunnel Cost Estimating Methods. GL-81-10. Geotechnical Laboratory. Department of the Army. Waterways Experiment Station. Corps of Engineers. Vicksburg, Mississippi. 238 pp.
- Bennett, R.D. 1985. State-Of-The-Art Construction Technology for Deep Tunnels and Shafts in Rock. Technical Report GL-85-1. Geotechnical Laboratory. Department of the Army. Waterways Experiment Station. Corps of Engineers. Vicksburg, Mississippi. 443 p.

- Benson, W.N. 1940. "Landslides and Applied Features in the Dunedin District in Relation to Geologic Structure, Topography, and Engineering." Royal Society of New Zealand Transactions. Volume 70. pp. 249-263.
- Betschen, G. 1973. "Tunnels at Belmont, Chauderon Criblette and Anchored Walls at Chauderon and Criblette." Tunnels and Tunnelling. Volume 5, Number 4, March. Morgan-Grampian Ltd., London, UK. pp. 58-64.
- Bevan, O. 1984. "Ground Problems at Hong Kong's Aberdeen Tunnel." Tunnels and Tunnelling. Volume 16, Number 5, May. Morgan-Grampian Ltd., London, UK. pp. 33-35.
- Bhattacharyya, K.K. 1973. A Study of stresses and Displacements in Gravity Loaded Slopes. Ph.D. Thesis. School of Engineering and Applied Science. Columbia University. 150 p.
- Bieniawski, Z.T. 1973. "Engineering Classification of Jointed Rock Masses." Transactions, South African Institution of Civil Engineers. Volume 15, Number 12. pp. 335-344.
- Bieniawski, Z.T. 1974. "Geomechanics Classification of Rock Masses and its Application To Tunneling." Proceedings, Third International Congress of Rock Mechanics. International Society for Rock Mechanics. Denver, CO. Volume IIA. pp. 27-32.
- Bieniawski, Z.T. 1984. Rock Mechanics Design in Mining and Tunneling. A.A. Balkema. Boston.
- Bieniawski, Z.T. 1986. "Principles of Engineering Design for Strata Control in Mining." Chapter 1. International Symposium on Application of Rock Characterization Techniques in Mine Design. Society of Mining Engineers of AIME. Littleton, Colorado. pp. 3-10.
- Bieniawski, Z.T. 1987. "Promises and Pitfalls: Taking Stock of Rock Mass Classifications as Design Aids in Tunnelling." Proceedings, Rapid Excavation and Tunneling Conference. Society of Mining Engineers. Littleton, Colorado.
- Bieniawski, Z.T. 1988. "Rock Mass Classification as a Design Aid in Tunnelling." Tunnels and Tunnelling. Volume 20, Number 7, July. Morgan-Grampian Ltd. London, UK. pp. 19-22.

- Bieniawski, Z.T. and Maschek, R.K. 1975. "The Behavior of Rock Tunnels During Construction." The Civil Engineer in South Africa. Volume 17, No. 10.
- Bieniawski, Z.T. and Orr, C.M. 1976. "Rapid Site Appraisal for Dam Foundations by the Geomechanics Classification." Proceedings of the 12th International Conference on Large Dams. ICOLD. Mexico City. pp. 483-501.
- Bobrick, B. 1981. Labyrinths of Iron - Subways in History, Myth, Art, Technology, and War. 1986 Revised Paperback Edition. William Morrow and Company, Inc. New York, New York, USA. pp. 352.
- Brady, B.H.G. and Brown, E.T. 1985. Rock Mechanics for Underground Mining. Allen & Unwin, Winchester, Massachusetts, USA.
- Brawner, C.O., and Cavers, D.S. 1986. "Recent Developments in Rock Characterization and Rock Mechanics for Surface Mining." Chapter 6. International Symposium on Application of Rock Characterization Techniques in Mine Design. Society of Mining Engineers of AIME. Littleton, Colorado. pp. 43-55.
- Brekke, T.L. 1968. "Blocky and Seamy Rock in Tunneling." Bulletin of the Association of Engineering Geologists. Volume V, Number 1. pp. 23-26.
- Brekke, T.L. 1982. Geological Engineering of Underground Openings. Department of Civil Engineering. University of California, Berkeley.
- Brekke, T. 1982. Personal Communication - Portal Stability. University of California, Berkeley, California.
- "Bridging the Gap with Foam Cavity Filling System." 1987. Tunnels and Tunnelling. Volume 19, Number 6, June. Morgan-Grampian Ltd., London, UK. p. 25.
- Brierley, G.S. 1988. Personal Communication - Portal Stability, President - Brierley & Lyman, Inc. October 18.
- Brown, E.T. 1978. "Ground Supports for Tunnels in Weak Rock - Report on Dr. Ward's Rankine Lecture." Tunnels and Tunnelling. Volume 10, Number 5, May. Morgan-Grampian Ltd., London, UK. pp. 35-36.

- Brown, E.T. 1979. "Impressions of Tunnelling '79." Tunnels and Tunnelling. Volume 11, Number 5, May. Morgan-Grampian Ltd., London, UK. pp. 32-33.
- Buntain, D. "Current Developments in British Haulage and Transport." Coal Mining and Processing. Volume 18, Number 5. May 1981.
- Butler, D.K. 1983. Cavity Detection and Delineation Research: Report 1. Microgravimetric and Magnetic Surveys: Medford Cave Site, Florida. Technical Report GL-83-1. CWIS Work Unit No. 31150. Geotechnical Laboratory. U.S. Army Waterways Experiment Station. Corps of Engineers. Vicksburg, Mississippi.
- Buttner, J.H. 1987. "Vacuum Dewatering Puts freezing Out in the Cold." Tunnels and Tunnelling. Volume 19, Number 7, July. Morgan-Grampian Ltd., London, UK. pp. 20-21.
- Byce, J. 1984. "Rapid Tunnelling Solves Utahs Landslide Crisis." Tunnels and Tunnelling. Volume 16, Number 9, September. Morgan-Grampian Ltd., London, UK. pp. 15-17.
- Calder, P.N. 1982. "Case Studies of Rock Slope Reinforcement." Chapter 90. Issues in Rock Mechanics - Proceedings of the Twenty-Third Symposium on Rock Mechanics. SME-AIME. New York, New York. pp. 899-911.
- California Mine Safety Orders. 1973. Subchapter 17. Department of Industrial Relations. Division of Industrial Safety. California Administrative Code, Title 8, Industrial Relations. San Francisco, California.
- California Tunnel Safety Orders. 1973. Subchapter 20. Department of Industrial Relations. Division of Industrial Safety. California Administrative Code, Title 8, Industrial Relations. San Francisco, California.
- CANMET. 1977. Pit Slope Manual: Buttresses and Retaining Walls. Report 77-4. Supplement 6-1. Mining Research Laboratories. Canada Center for Mineral and Energy Technology. Department of Energy, Mines and Resources Canada.

- Capra, U., Linari, C. 1960. "I Movimenti Della Massa Rocciosa Sulla Sponda Sinistra del Serbatoio di Pontesei." Geotecnica. Volume 7. pp. 118-124. Milano.
- "Care and Precision Feature Rebuilding of Tunnel Floor." 1937. Railway Age. January 9 Edition.
- Cavers, D. 1988. Personal Communication - Portal Stability and Thick Application Shotcrete, Geotechnical Engineer, Hardy BBT, Inc., Vancouver. October 25.
- Chen, C.X., Cheng, D.X., Min, Z., and Ling, H.Q. 1984. "Monitoring and Back Analysis of the Deformations in Two Tunnels in China." Paper 54. Design and Performance of Underground Excavations. ISRM Symposium, Cambridge, U.K. British Geotechnical Society, London. pp. 445-451.
- Cherniack, M. 1986. The Hawk's Nest Incident - America's Worst Industrial Disaster. Yale University Press, New Haven, Connecticut, USA. 194 pp.
- Clarke, O.M. Jr. 1986. "Stratigraphic and Structure Geology Controls of Subsidence Over Underground Mines." Chapter 13. Rock Mechanics: Key to Energy Production - Proceedings of the 27th U.S. Symposium on Rock Mechanics. SME-AIME. Littleton, Colorado. pp. 85-92.
- Cohen, S. 1984. King Coal - A Pictorial Heritage of West Virginia Coal Mining. Pictorial Histories Publishing Company. Charleston, West Virginia, USA. 146 pp.
- "Colorado Drift." 1982. Tunnels and Tunnelling. Volume 14, Number 9, September. Morgan-Grampian Ltd., London, UK. p. 9.
- "Colorado Tunnels Design Underway." 1981. Tunnels and Tunnelling. Volume 13, Number 5, May. Morgan-Grampian Ltd., London, UK. p. 18.
- Compton, J. 1989. Personal Communication - Laborer on East River and Big Walker Mountain Portals, Interstate 77, Virginia. January 17.
- "Computers Assist in Tunnel Portal Design." 1988. Tunnels and Tunnelling. Volume 20, Number 1, January. Morgan-Grampian Ltd., London, UK. p. 13.

- Cook, P. 1988. Personal Communication - Retired WV State Mine Inspector - June 6, Beckley, West Virginia.
- Cooper, S.F. 1983. Cavity Detection and Delineation Research: Report 3, Acoustic Resonance and Self-Potential Applications: Medford Cave and Manatee Springs Sites, Florida. Technical Report GL-83-1. CWIS Work Unit 31150. Geotechnical Laboratory. U.S. Army Engineer Waterways Experiment Station. Corps of Engineers. Vicksburg, Mississippi.
- Cording, E.J., Hendron, A.J.Jr., Deere, D.U. 1971 "Rock Engineering for Underground Caverns." Symposium on Underground Rock Chambers. Phoenix, Arizona. January 13-14. American Society of Civil Engineers, New York, New York, USA. pp. 567-600.
- Cordova, T. 1965. "Geology and Geotechniques of the Carlin Canyon Tunnels, Interstate Highway 80, Through Carlin Canyon, Elko County, Nevada." Proceedings of the Third Annual Engineering Geology and Soils Engineering Symposium. Boise, Idaho, USA. April 6-8. pp.199-215.
- Craig, C.L. and Brockman, L.R. 1971. "Survey of Tunnel Portal Construction at U.S. Army Corps of Engineers Projects." Symposium on Underground Rock Chambers. American Society of Civil Engineers. New York, New York. pp. 167-201.
- Craig, R. 1985. "CIRIA Report 101 - Rock Reinforcement." Tunnels and Tunnelling. Volume 17, Number 3, March. Morgan-Grampian Ltd., London, UK. pp. 78-80.
- "Crawler Excavator Gives a Lift to Tunnel Repairs at Todmorden." 1987. Tunnels and Tunnelling. Volume 19, Number 6, June. Morgan-Grampian Ltd., London, UK. pp. 59.
- Curro, J.R. Jr. 1983. Cavity Detection and Delineation Research: Report 2, Seismic Methodology: Medford Cave Site, Florida. Technical Report GL-83-1. CWIS Work Unit 31150. Geotechnical Laboratory. U.S. Army Engineer Waterways Experiment Station. Corps of Engineers. Vicksburg, Mississippi.

- Daemen, J.J.K., Jeffrey, R.G. Jr. 1983. "Analysis of Rockbolt Reinforcement of Layered Rock Using Beam Equations." International Symposium of Rock Bolting - Theory & Application in Mining & Underground Construction. Volume 2, Preprint. Abisko, Lapland, Sweden. August 28th - Sept. 2nd.
- Daly, W. and Abramson, L. 1986. "Mt. Lebanon Tunnel Uses the NATM American-Style." Tunnels and Tunnelling. Volume 18, Number 1, January. Morgan-Grampian Ltd., London, UK. pp. 35-38.
- Dante Alighieri. c. 1300. The Divine Comedy - Inferno. Canto III, Line 9. Translated by Henry Wadsworth Longfellow. Volume 1. Ticknor & Fields, Boston. 1867. p. 14.
- Dante Alighieri. c. 1300. The Divine Comedy - Inferno. Canto III, Line 9. Translated by Rev. H.F. Cary. John W. Lovel Co. New York. 1814.
- Dante Alighieri. c. 1300. The Divine Comedy - Inferno. Canto III, Line 9. Edited and Annotated by C.H. Grandgent. D.C. Heath & Co. New York. 1909. pp. vi-vii, 26-27.
- Davies, P.H. 1976. "Instrumentation in Tunnels to Assist in Economic Lining." Exploration for Rock Engineering. Volume One. Z.T. Bieniawski, Editor. Proceedings of the Symposium on Exploration for Rock Engineering, Johannesburg. A.A. Balkema, Rotterdam. pp. 243-252.
- Decker, D. 1988. Personal Communication - Laurel Mountain Mine Portals, near Cleveland Virginia, Clinchfield Division Mining Engineer, Pittston Coal Company.
- Deere, D.U., Peck, R.B., Monsees, J.E., and Schmidt, B., 1969. Design of Tunnel Liners and Support Systems. NTIS No. PB 183799. U.S. Department of Transportation, Washington, DC. 404 p.
- Denkhaus, H.G. 1964. "Critical Review of Strata Movement Theories and Their Application to Practical Problems." Journal of the South African Institute of Mining and Metallurgy. March. pp. 310-332.
- Dillon, L.A. 1976. They Died in the Darkness. McClain Printing Company. Parsons, West Virginia, USA. 280 pp.
- Dillon, L.A. 1985. They Died for King Coal. Apollo Books, Inc. Winona, MN, USA. 172 pp.

- Dillon, L.A. 1986. Personal Communication - Mine Disasters and Portals.
- Dowding, C.H. "Earthquake Stability of Rock Tunnels." Tunnels and Tunnelling. Volume 11, Number 6, June. Morgan-Grampian Ltd., London, UK. pp. 15-20.
- Doyle, J. 1986. "Construction of Fourteen Tunnels Spearheads Zululand Venture." Tunnels and Tunnelling. Volume 18, Number 11, November. Morgan-Grampian Ltd., London, UK. pp. 31-33.
- Duncan, J.M. and Goodman, R.E. 1968. Finite Element Analyses of Slopes in Jointed Rock. U.S. Army Corps of Engineers. Contract Report S-63-3.
- Dunrud, R.D. 1984. "Coal Mine Subsidence - Western United States." Reviews in Engineering Geology. Volume VI. pp. 151-194.
- Dutro, H.B. and Perry, D.J. 1987. "Measuring up for Tunnel Construction." Tunnels and Tunnelling. Volume 19, Number 6, June. Morgan-Grampian Ltd., London, UK. pp. 47-50.
- Elifrits, C.D., Vories, K.C., and Haston, F.F. 1988. "Steep Slope Stabilization for Reclaimed Terrain." Mining Engineering. Volume 40, Number 3, March. Society of Mining Engineers of AIME, Littleton, CO, USA. pp. 196-199.
- Evans, W.H. 1941. "The Strength of Undermined Strata." Transactions of the Institution of Mining and Metallurgy. Volume 50. pp. 475-532.
- Fawcett, D.H. and Kershaw, T. 1984. "Design of Entries for German Creek No. 1 Underground Coal Mine." Fifth Australian Tunnelling Conference - State of the Art in Underground Development and Construction. Sydney, 22-24 October. Australian Institution of Engineers, Barton, ACT, Australia. p. 11 - 33.
- Fayol, M. 1885. "Sur les Movements de Terrain Provoques Par L'exploitation des Mines." Bulletin Society l'Industrie Minerale. 2nd Series. Volume 14. p. 818.
- Flanagan, R.F. 1988. Personal Communication - Portal Stability and Design for the Cumberland Gap Highway Tunnels, Design Engineer, Parsons Brinckerhoff Quade and Douglas, Herndon, Virginia. November 16.

- Forrest, P. 1988. "Personal Communication - Balcombe Tunnel, UK." June 13th.
- Fumimoto, N. 1980. "Japan's Longest Highway Tunnel." Tunnels and Tunnelling. Volume 12, Number 11, November. Morgan-Grampian Ltd., London, UK. pp 20-21.
- Gilmer, F.M. 1988. Personal Communication - Portal Problems at East River and Big Walker Mountain Tunnel Portals. District Geologist, Staunton, VA.
- Gleick, J. 1988. "Next Big Quake May Be in East." Roanoke Times & World-News. Volume 24, Number 74. Monday, March 14. p. 1.
- Gnilsen, R. 1987. "Alternative Ground Control in Soil and Weak Rock." Chapter 17. Proceedings of the Rapid Excavation and Tunneling Conference. New Orleans, Louisiana, June 14-17. Society of Mining Engineers. Littleton, Colorado. pp. 247-264.
- Golser, J. 1979. "Another View of NATM." Tunnels and Tunnelling. Volume 11, Number 3, March. Morgan-Grampian Ltd., London, UK. p. 41.
- Gooch, E.O. 1954. Iron in Virginia. Mineral Resources Circular No. 1. Division of Geology, Department of Conservation and Development, Commonwealth of Virginia. Charlottesville, Virginia. 13 pp.
- Goodman, R.E., Heuze, F.E., Thorpe, R.K., and Chatoian, J.M. 1974. The Design of Highway Cuts in Intermediate Quality Rock. California Department of Transportation Report Number TE-75-1. Department of Civil Engineering. Geological Engineering. University of California, Berkeley. Berkeley, California.
- Goodman, R.E. and Gen-hua Shi. 1982. Block Theory and Its Application to Rock Engineering. Prentice-Hall, Englewood Cliffs, New Jersey.
- Gosselin, C. 1974. "A New Tale from Wookey Hole." Tunnels and Tunnelling. Volume 6, Number 7, July. Morgan-Grampian Ltd., London, UK. pp. 43-44.
- "Guatemalan Gremlins Wreck Havoc in Underground Hydro Scheme." 1985. Tunnels and Tunnelling. Volume 17, Number 1, January. Morgan-Grampian Ltd., London, UK. pp. 14-19.

- Haimson, B.C. 1984. "Pre-excavation In Situ Stress Measurements in the Design of Large Underground Openings." ISRM Symposium on the Design and Performance of Underground Excavations. Cambridge, U.K. British Geotechnical Society, London. pp. 183-190.
- Hansmire, W.H. 1988. Personal Communication concerning the Trans-Koolau Tunnels. Project Manager - Parsons Brinckerhoff Quade & Douglas, Inc. January 12.
- Harder, P. 1982. "TBM Drives Four Miles Through Granite Mountain." Tunnels and Tunnelling. Volume 14, Number 7, July. Morgan-Grampian Ltd., London, UK. pp 14-15.
- Harding, P.G. 1981. "Low Cover Challenge Met by German Tunnellers." Tunnels and Tunnelling. Volume 13, Number 1, January/February. Morgan-Grampian Ltd., London, UK. pp. 32-33.
- Henderson, T. 1989. Personal Communication - Pearpoint Mine Portals, Westmoreland Coal Company, Virginia. January 18.
- Hempel, J.C. 1975. Caves and Karst of Monroe County, WV. West Virginia Speleological Survey Press. Bulletin 4. Pittsburgh, Pennsylvania. 151 pp.
- Hodgson, J.L. 1986. "A Construction Planning Study for an Underground Hydroelectric Pumped Storage Facility in Weak Rock." Chapter 112. Rock Mechanics: Key to Energy Production - Proceedings of the 27th U.S. Symposium on Rock Mechanics. SME-AIME. Littleton, Colorado. pp. 795-799.
- Hoek, E., 1981. "Geotechnical Design of Large Openings at Depth." Proceedings of Rapid Excavation and Tunnelling Conference. AIME, New York, NY. Volume 1. pp. 1032-1044.
- Hoek, E. 1985. "General Two-Dimensional Slope Stability Analysis. Chapter 3. Analytical and Computational Methods in Engineering Rock Mechanics. E.T. Brown, editor. Allen and Unwin. Boston. pp. 95-128.
- Hoek, E. and Brown, E.T. 1980. Underground Excavations in Rock. The Institution of Mining and Metallurgy. London, England. 527 p.

- Hoek, E. and Bray, J.W. 1981. Rock Slope Engineering. Revised Third Edition. The Institution of Mining and Metallurgy, London.
- Holley, T.H. 1987. "Tunnel Excavation at the Bad Creek Project." Proceedings of the Rapid Excavation and Tunnelling Conference. Volume 2. Chapter 52. SME-AIME. New Orleans, Louisiana. June 14-17. pp. 839-849.
- Hotchkiss, J. 1880. "The Low Moor Iron Company of Virginia." The Virginias. A Mining, Industrial and Scientific Journal. Volume I, No. 10. Staunton, Virginia. October. pp 150-151.
- Howells, D.A. 1972. "Tunnels in Earthquake Areas." Tunnels and Tunnelling. Volume 4, Number 9, September. Morgan-Grampian Ltd., London, UK. p. 437.
- Hungerford, W.S. 1888. "Mining in Soft Ore Bodies at Low Moor, Virginia." Transactions of the American Institute of Mining Engineers. Volume 17. pp. 103-107.
- Isaac, I.D. and Bubb, C. 1981. "Geology at Dinorwic." Tunnels and Tunnelling. Volume 13, Number 4, April. Morgan-Grampian Ltd., London, UK. pp. 20-25.
- "Icycles Hazard in Rail Tunnels." 1985. Tunnels and Tunnelling. Volume 17, Number 5, May. Morgan-Grampian Ltd., London, UK. p. 35.
- Jacobs, J.D. 1975. "Some Tunnel Failures and What They Have Taught." Hazards in Tunnelling and on Falsework. Proceedings of the Third International Safety Conference. The Institution of Civil Engineers. London, UK. March 19-20.
- James, H.B. 1984. "Establishment of Portals for Two Road Tunnels." Fifth Australian Tunnelling Conference - State of the Art in Underground Development and Construction. Sydney, 22-24 October. Australian Institution of Engineers, Barton, ACT, Australia. p. 164 - 169.
- Jayarom, K.S. 1981. "Himalayan Hydroelectric Scheme Challenges Indian Tunnellers." Tunnels and Tunnelling. Volume 13, Number 1, January. Morgan-Grampian Ltd., London, UK. pp. 48-49.

- "Jet Grouting Goes to Ground." 1982. Tunnels and Tunnelling. Volume 14, Number 1, January. Morgan-Grampian Ltd., London, UK. p. 42.
- Jones, B. 1984. "Tunnelling in a Bee Line." Tunnels and Tunnelling. Volume 16, Number 12, December. Morgan-Grampian Ltd., London, UK. p. 41.
- Jones, M.B. 1982. "Ground Freezing Technology Advances with Speed." Tunnels and Tunnelling. Volume 14, Number 12, December. Morgan-Grampian Ltd., London, UK. pp. 31-35.
- Jones, M. 1985. "Checking Moves - Developments in Strata Instrumentation." Tunnels and Tunnelling. Volume 17, Number 9, September. Morgan-Grampian Ltd., London, UK. pp. 65-69.
- "Kaimai Rail Tunnel, NZ." 1972. Tunnels and Tunnelling. Volume 4, Number 11, November. Morgan-Grampian Ltd., London, UK. p. 569.
- "Kamai Tunnel Breakthrough." 1976. Tunnels and Tunnelling. Volume 8, Number 11, November. Morgan-Grampian Ltd., London, UK. p. 15.
- Kane, W.F. and Karmis, M. 1986. "Geologic and Geotechnical Controls on the Stability of Coal Mine Entries." Chapter 13. International Symposium on Application of Rock Characterization Techniques in Mine Design. Society of Mining Engineers of AIME. Littleton, Colorado. pp. 124-132.
- Karfakis, M.G. 1986. "Chimney Subsidence - A Case Study." Chapter 41. Rock Mechanics: Key to Energy Production - Proceedings of the 27th U.S. Symposium on Rock Mechanics. SME-AIME. Littleton, Colorado. pp. 275-282.
- Karmis, M. and Agioutantis, Z. 1985. "An Investigation Into the Mechanism of Roof Caving and Its Prediction Using Numerical and Geomechanics Techniques." Proceedings of the Third Annual Workshop - Generic Mineral Technology Center- Mine Systems Design and Ground Control. Lexington, Kentucky, November 25-26. pp. 53-74.

- Kendorski, F.S., Cummings, R.A., Bieniawski, Z.T., and Skinner, E.H. 1983. "Rock Mass Classification for Block Caving Mine Drift Support." Proceedings of the 15th International Congress of Rock Mechanics. ISRM. Melbourne. pp. b101-113.
- Kennedy, H. 1988. "Personal Communication and Visit - Virginia Lime Co. Portal Stability, Kimballton, Giles County, Virginia."
- Kidd, B.C. 1976. "Instrumentation of Underground Civil Structures." Exploration for Rock Engineering. Volume One. Z.T. Bieniawski, Editor. Proceedings of the Symposium on Exploration for Rock Engineering, Johannesburg. A.A. Balkema, Rotterdam. pp. 219-231.
- Kimmons, G.H. 1972. "Pumped Storage Plant at Raccoon Mountain in USA." Tunnels and Tunnelling. Volume 4, Number 3, March. Morgan-Grampian Ltd., London, UK. pp. 108-113.
- Kozak, F. Jr. 1978. Federal Mining Laws for the Underground and Surface. 1978 - 1979 Edition. Coal Mine Training Materials, Inc. Charleston, WV. 209 pp.
- Kuesel, T.R. 1987. "Both Bore and Blast Used to Excavate Canadian Rail Tunnel." Tunnels and Tunnelling. Volume 20, Number 1, January. Morgan-Grampian Ltd., London, UK. pp. 37-41.
- Kuesel, T.R. 1988. Personal Communication - Portal Stability. Chairman of the Board, Parsons Brinckerhoff Quade and Douglas, Inc., New York. October 13.
- Lama, R.D., Lamb, P., Griffiths, L., and Jaggar, F.E. 1986. "Effect of Geological Environments and Direction on Behavior of Roof." Chapter 12. International Symposium on Application of Rock Characterization Techniques in Mine Design. Society of Mining Engineers of AIME. Littleton, Colorado. pp. 114-123.
- "Landslip Problem at Chunnel Terminal." 1974. Tunnels and Tunnelling. Volume 6, Number 10, October. Morgan-Grampian Ltd., London, UK. p. 15.
- Lane, K.S. 1975. "Appendix A - Possibilities for Improving Tunnel Support (A Challenge for U.S. Engineering)." Field Test Sections Save Cost in Tunnel Support. Underground Construction Research Council. American Society of Civil Engineers. April. pp. 35-46.

- Lang, T.A. 1966. "Theory and Practice of Rock Reinforcement." Proceedings of the 45th Annual Meeting, Highway Research Board. Washington, DC.
- Lang, T.A. and Bischoff, J.A., 1982. "Stabilization of Rock Excavations Using Rock Reinforcement." Proceedings of the 23rd Symposium of Rock Mechanics. AIME, New York, NY. pp. 935-944.
- Legge, F. and Alocco, V. 1981. "Malawi - Driving a 9 m Power Conduit with Low Cover at Nkula Falls." Tunnels and Tunnelling. Volume 13, Number 7, July. Morgan-Grampian Ltd., London, UK. pp. 23-28.
- Legget, R.F. 1939. "Tunnels." Chapter 8. Geology and Engineering. First Edition. McGraw-Hill Book Company, Inc. New York, New York. pp. 139-181.
- Lewis, R. 1977. "Photo Sleuths' Put Serious Mining Hazards into Focus." Unknown MSHA publication. pp. 2-7, & 27.
- Lyons, A.C. and Harries, D.A. 1983. "The Design and Construction of the Ahmed Hamdi Tunnel, Suez." Eurotunnel '83 Conference, Paper 1. Access Conferences Ltd. Marlow, UK. pp. 13-27.
- Long, D.V., McClure, C.R. 1965. "Seismic Design Criteria for the San Francisco Bay Area Rapid Transit System." Proceedings of the Third Annual Engineering Geology and Soils Engineering Symposium. Boise, Idaho, USA. April 6-8. pp. 239-248.
- Marchant, R.L. 1977. "Construction of the New Moelwyn Tunnel." Tunnels and Tunnelling. Volume 9, Number 5, May. Morgan-Grampian Ltd., London, UK. pp. 39-40.
- Marszalowicz, M.A. 1982. "Tunnel Lighting." Chapter 20. Tunnel Engineering Handbook. Van Nostrand Reinhold Company, Inc. New York, New York. pp. 564-587.
- Martin, D. 1980. "Progress at Dinorwic." Tunnels and Tunnelling. Volume 12, Number 7, July. Morgan-Grampian Ltd., London, UK. pp. 44-45.
- Martin, D. 1981. "Drifts and Shafts at Selby." Tunnels and Tunnelling. Volume 13, Number 9, September. Morgan-Grampian Ltd., London, UK. pp. 42-48.

- Martin, D. 1981. "Norway Drives for Low Cost Road Tunnels." Tunnels and Tunnelling. Volume 13, Number 10, October. Morgan-Grampian Ltd., London, UK.
- Martin, D. 1983. "Three Long Drives for Norwegian Road Tunnels." Tunnels and Tunnelling. Volume 15, Number 1, January. Morgan-Grampian Ltd., London, UK. pp. 31-34.
- Martin, D. 1984. "High Frequency Drill Hammers Out Austrian Road Tunnel." Tunnels and Tunnelling. Volume 16, Number 1, January. Morgan-Grampian Ltd., London, UK. pp. 39-42.
- Martin, D. 1985. "North America's Longest Railway Tunnel Drives Hard Through Canadian Rockies." Tunnels and Tunnelling. Volume 17, Number 9, September. Morgan-Grampian Ltd., London, UK. pp. 24-29.
- Martin, D. 1987. "Undersea Road Links Alesund with Its Airport." Tunnels and Tunnelling. Volume 19, Number 3, March. Morgan-Grampian Ltd., London, UK. pp. 20-24.
- Martin, D. 1987. "Himalayas Hold Vast Potential for India's hydro Power Needs." Tunnels and Tunnelling. Volume 19, Number 11, November. Morgan-Grampian Ltd., London, UK. pp. 18-22.
- Martin, D. and Wallis, S. 1983. "Carsington Aqueduct - Man Against Nature." Tunnels and Tunnelling. Volume 15, Number 3, March. Morgan-Grampian Ltd., London, UK. pp. 27-30.
- Martin, R.E. 1987. "Beavertail Tunnels Interstate I-70." Proceedings of the Rapid Excavation and Tunneling Conference. June 14-17. Society of Mining Engineers of AIME, Inc. Littleton, Colorado. pp. 653-661.
- Matson, C.R. and Robinson, S.A. 1984. Planning, Investigation and Design of the Junk Bay Road Tunnel, Hong Kong." Fifth Australian Tunnelling Conference - State of the Art in Underground Development and Construction. Sydney, 22-24 October. Australian Institution of Engineers, Barton, ACT, Australia. p. 11 - 15.
- Mayo, R.S. 1982. "Early Tunnels in America." Tunnels and Tunnelling. Volume 14, Number 12, December. Morgan-Grampian Ltd., London, UK. pp. 14-16.

- McCormack, S. 1984. "Ground Treatment Aids Construction of Nice's Sunshine Motorway." Tunnels and Tunnelling. Volume 16, Number 5, May. Morgan-Grampian Ltd., London, UK. pp. 57-59.
- Milan, N. 1981. "Winter Quarters Disaster." Mine Safety and Health. Volume 6, Number 5. September/October. Mine Safety and Health Administration, U.S. Department of Labor. U.S. Government Printing Office. Washington, D.C., USA. pp. 14-19.
- Milan, N. 1984. "Wentz b: Firm Safety Policy, Strong Bonds of Miners Curb Serious Injuries." Mine Safety and Health. Winter-Spring Edition. Volume 9, Number 1. Mine Safety and Health Administration, U.S. Department of Labor. U.S. Government Printing Office. Washington, D.C., USA.
- Miller, S.M. 1984. Probabilistic Rock Slope Engineering. Miscellaneous Paper GL-84-8. CWIS Work Unit 31755. Geotechnical Laboratory. U.S. Army Engineer Waterways Experiment Station. U.S. Army Corps of Engineers. Vicksburg, Mississippi.
- Moebs, N.N., Bauer, E.R. 1989. "Appalachian Roof Instability." Coal. Volume 26, Number 3, March. Maclean Hunter, Chicago, Illinois. pp. 43-46.
- Moore, D.P. and Lewis, M.R. 1982. "Rock Slope Reinforcement with Passive Anchors." Chapter 94. Issues in Rock Mechanics - Proceedings of the Twenty-Third Symposium on Rock Mechanics. SME-AIME. New York, New York. pp. 945-952.
- Morgenstern, N.R. and Sangrey, D.A. 1978. "Methods of Stability Analysis." Chapter 7. Landslides: Analysis and Control. Special Report 176. Transportation Research Board. National Academy of Sciences. Washington, D.C. pp. 155-171.
- Muller, L. 1978. "Removing Misconceptions on the New Austrian Tunnelling Method." Tunnels and Tunnelling. Volume 10, Number 10, October. Morgan-Grampian Ltd., London, UK. pp. 29-32.
- Muller, S. 1987. "Austrian Road Tunnel Supported by Water Expanding Bolts." Tunnels and Tunnelling. Volume 19, Number 3, March. Morgan-Grampian Ltd., London, UK. pp. 35-36.

- Murphy, W.L. 1985. Geotechnical Descriptions of Rock and Rock Masses. Technical Report GL-85-3. CWIS Work Unit 31754. Geotechnical Laboratory. U.S. Army Engineer Waterways Experiment Station. Corps of Engineers. Vicksburg, Mississippi.
- Myslil, L. and Silar, J. 1953. "Proudovy Sesuv u Radotina." Vestnik UUG. Volume 28. pp. 83-90.
- "NATM and Its Downfalls in West Germany." 1985. Tunnels and Tunnelling. Volume 17, Number 10, October. Morgan-Grampian Ltd., London, UK. p. 9.
- Nicholson, G.A. 1983. In Situ and Laboratory Shear Devices for Rock: A Comparison. Technical Report GL-83-14. CWIS 31197. Geotechnical laboratory. U.S. Army Engineer Waterways Experiment Station. Corps of Engineers. Vicksburg, Mississippi.
- O'Connor, K., Zubelewicz, A., Dowding, C.H., Belytschko, T.B., and Plesha, M. 1986. "Cavern Response to Earthquake Shaking with and Without Dilation." Chapter 127. Rock Mechanics: Key to Energy Production - Proceedings of the 27th U.S. Symposium on Rock Mechanics. SME-AIME. Littleton, Colorado. pp. 891-895.
- Olmedo, M.E. 1987. Personal Communication. Vice President of Research and Development, James River Limestone Co., Inc. Buchanan, VA.
- Orr, J. 1982. Personal Communication - Feather Fork Gold Mine, Guiverson Incline Portal. La Porte, Plumas County, California.
- Overlie, F.E. and Rippentropp, G. 1987. "Steel Fiber Microsilica Shotcrete with Remote Controlled Equipment." Proceedings of the Rapid Excavation and Tunnelling Conference. SME-AIME. New Orleans, Louisiana. June 14-17. pp. 351-371.
- Owen, G.N., Scholl, R.E., and Brekke, T.L. 1979. "Earthquake Engineering of Tunnels." Chapter 41. Proceedings of the Rapid Excavation and Tunnelling Conference. SME-AIME. New York, New York. pp. 709-721.

- Parsons Brinckerhoff-Hirota Associates. 1988. Trans-Koolau Exploratory Tunnel Geotechnical Design Summary Report. FAIP No. I-H3-1(37). Prepared for State of Hawaii, Dept. of Transportation, Highways Division. 59+ pp.
- Paterson, T. and Arthur, L.J., 1979. "Tunnel Portals at Dinorwic, North Wales." Tunnelling '79. Proceedings of the 2nd International Symposium. Institution of Mining and Metallurgy, London, UK. pp. 3-14.
- Patton, F.D. 1966. "Multiple Modes of Shear Failure in Rock." Proceedings of the First International Congress of Rock Mechanics. Lisbon. Volume 1, pp. 509-513.
- Peng, S.S. 1986. "State-of-the-Art Review on Coal Mine Ground Control." Chapter 11. International Symposium on Application of Rock Characterization Techniques in Mine Design. Society of Mining Engineers of AIME. Littleton, Colorado. pp. 101-113.
- "Penmanshiel Tunnel Outlook is Black." 1979. Tunnels and Tunnelling. Volume 11, Number 5, May. Morgan-Grampian Ltd, London, UK. p. 8.
- Petrofsky, A.M. 1988. Personal Communication - Portal Stability, Professional Engineer, Jacobs Associates, San Francisco, California. October 18.
- Pettman, E.R. 1984. "Tunnel Plugs in Recent H.E.C. Practice." Fifth Australian Tunnelling Conference - State of the Art in Underground Development and Construction. Sydney, 22-24 October. Australian Institution of Engineers, Barton, ACT, Australia. pp. 206-212.
- Piteau, D.R. and Peckover, F.L. 1978. "Engineering of Rock Slopes." Chapter 9. Landslides: Analysis and Control. Special Report 176. Transportation Research Board. National Academy of Sciences. Washington, D.C. pp. 192-228.
- Pollard, D.C. 1977. "Chipping Sodbury Quarry Access." Tunnels and Tunnelling. Volume 9, Number 9, September. Morgan-Grampian Ltd., London, UK. pp. 78-79.
- Pratt, H.R., Stephenson, D.E., Zandt, G., Bouchon, M., and Hustrulid, W.A. 1979. "Earthquake Damage to Underground Facilities." Chapter 2. Proceedings, Rapid Excavation and Tunnelling Conference. SME-AIME. New York, New York. pp. 19-51.

- Proctor, R.V. and White, T.L. 1968 Revision. Rock Tunneling with Steel Supports. Commercial Shearing, Inc. Youngstown, Ohio. 1977 Reprinting. 296 pp.
- Provost, A.G. 1976. "Driving the Cunningham Tunnel." Tunnels and Tunnelling. Volume 8, Number 5, May. Morgan-Grampian Ltd., London, UK. pp. 41-43.2
- Rabcewicz, L. 1964. "The New Austrian Tunnelling Method." Water Power. November, pp. 453-457. December, pp. 511-515. January, 1965, pp. 19-24.
- "REAM - Excavation of Tunnels by the Use of Smooth-Bore Cannons to Fire Solid 10lb Concrete Projectiles into the Rock." Tunnels and Tunnelling. Volume 5, Number 3, March. Morgan-Grampian Ltd., London, UK. pp. 177-180.
- Rib, H.T., and Liang, T. 1978. "Recognition and Identification." Chapter 3. Landslides: Analysis and Control. Special Report 176. Transportation Research Board. National Academy of Sciences. Washington, D.C. pp. 34-80.
- Robinson, R.H. 1988. Personal Communication - Portal Stability, Manager of Mining Engineering, Pincock, Allen & Holt, Inc., Lakewood, Colorado. October 14.
- Rogers, G.K. 1980. "Acme Limestone Company Underground Limestone Mine, Fort Spring, West Virginia, USA." "Whitby and Oceana Surface Mine/Underground Coal Mine Operations." Unpublished Notes from Presentation at West Virginia Tech, Montgomery, West Virginia.
- Rogers, R.J., Rogers, J.W. 1980. "Personal Communication - Crow railway tunnel portals, Fort Spring Limestone Mine, C&O Railroad Tunnel Portals, Raleigh and Beaver Coal Mines, Beckley Exhibition Coal Mine, Low Moor Abandoned Limestone Mine.
- Rogers, G.K. 1982. "Kerckhoff 2 Underground Power Plant and Santa Clara Water Tunnel Visit." Unpublished Notes, Fresno, California, USA.
- Rogers, G.K. 1982. Considerations in the Design and Construction of Coal Mine Slopes. Unpublished Report, University of California, Berkeley. 89 pp.
- Rogers, G.K. 1982. The Lawson Adit. Unpublished Report on an Experimental Adit Driven Into the Hayward Fault, University of California, Berkeley. 21 pp.

- Rogers, G.K. 1983. Ground Control and Mine Projections for the Feather Fork Gold Mine. Geological Engineering Master's Thesis, University of California, Berkeley. Department of Civil Engineering. Berkeley, California.
- Rogers, G.K. 1986. "Onion Valley and Pilots Peak Gold Mines." Unpublished Notes, La Porte, California, USA.
- Rogers, G.K., Abernathy, D., Dickenson, S., Forrest, P., Willis, J. 1987. Investigation of the Rock Slope Failure at the James River Limestone Plant/Quarry No. 1, Buchanan, Botetourt County, Virginia. Unpublished Report. 147 pp.
- Rogers, G.K. 1987. Report of Prices Fork/Milletts Tunnel Slide. Unpublished Slope/Portal Failure Investigation. Virginia Polytechnic and State University. Mining Department. 24 pp.
- Rogers, G.K., et al. 1988. Tunnelling Operations at the Bad Creek Pumped-Storage Project - Duke Power Company, South Carolina. Unpublished Report and Notes. April 14-16. 80 pp.
- Rogers, G.K. and Haycocks, C. 1988. "Portal Stability in Rock." 7th International Conference on Ground Control in Mining. West Virginia University. August 3-5. Morgantown, WV. 8 pp.
- Rogers, G.K. and Haycocks, C. 1989. "The Stability of Rock Slopes with In Situ Cavities." 1989 Multinational Conference on Mine Planning and Design. May 22-26. Lexington, Kentucky. 6 pp.
- Rogers, G.K. and Haycocks, C. 1989. "Rock Classification for Portal Design." 30th U.S. Symposium on Rock Mechanics. International Society of Rock Mechanics and U.S. National Committee for Rock Mechanics. West Virginia University, Morgantown, WV. June 19-22. 8 pp.
- Rogers, G.K. and Haycocks, C. 1989. Portal Stability in Rock: Portal Database - Synopsis Format. Unpublished Report. Department of Mining and Minerals Engineering, Virginia Polytechnic and State University, Blacksburg, Virginia. Prepared for the Mining and Mineral Resources Research Institute - U.S. Bureau of Mines. March. 304pp.

- Rose, D. 1982. "Revising Terzaghi's Tunnel Rock Load Coefficients." Chapter 95. Issues in Rock Mechanics - Proceedings of the Twenty-Third Symposium on Rock Mechanics. SME-AIME. New York, New York. pp.953-960.
- Russell, O., Stanczuk, D., Everett, J., and Coon, R. 1976. Evaluation of Aerial Remote Sensing Techniques for Defining Critical Geologic Features Pertinent to Tunnel Location and Design. FHWA-RD-76-72. Federal Highway Administration. Washington, D.C.
- Sames, G. 1988. "Outcrop Barrier Design and Roof Instability in Southern Appalachian Drift Mines - Abstract." U.S. Bureau of Mines Technology Transfer Conference. Beckley, West Virginia. 3 pp.
- Sarma, S.K. 1979. "Stability Analysis of Embankments and Slopes." Journal of the Geotechnical Engineering Division of ASCE. Volume 105 (GT12). pp. 1511-1524.
- Schmid, W. 1986. "Swollen Rockbolts Secure Alpine Road Tunnel." Tunnels and Tunnelling. Volume 18, Number 7, July. Morgan-Grampian Ltd., London, UK. pp. 32-34.
- Schneller, P.G. 1983. "Saas-Fee's Alpine Metro: Tunnel Construction for a Tourist Railway." Eurotunnel '83 Conference, Paper 20. Access Conferences Ltd. Marlow, UK. pp. 149-155.
- Schrewe, F. 1983. "Tunnels in Recently-Constructed Sections of the German Federal Railway." Eurotunnel '83 Conference, Paper 13. Access Conferences Ltd. Marlow, UK. pp. 103-109.
- Scoble, M.J. and Leigh, W.J.P. 1982. "Factors Governing the Stability of Rock Slopes in British Surface Coal Mines." Chapter 106. Issues in Rock Mechanics - Proceedings of the Twenty-Third Symposium on Rock Mechanics. SME-AIME. New York, New York. pp. 1091-1098.
- Seedsman, R. 1987. "Back-analysis of Roof Conditions in the Great Northern Seam, Newcastle Coal Measures, Australia, Using Voussoir Beam Theory." International Journal of Mining and Geological Engineering. Volume 5, Number 1, March. Chapman and Hall Ltd. London, UK. pp. 15-27.

- Seijo, M. 1988. Personal Communication. Abandoned Mine Lands Program - West Virginia Department of Natural Resources. Mine Closure Projects: Ames, Cabin Creek, Oceana, Sissonville. December 4, Interview.
- Sepehr, K., Stimpson, B. "Roof Deflections and Sag in Jointed, Horizontally Bedded Strata - A Numerical Study." Rock Mechanics and Rock Engineering. Volume 21, Number 3, July.. Springer-Verlag. pp. 207-218.
- Shady Spring District Woman's Club. 1979. The Development of the Shady Spring District of Raleigh County, West Virginia. Beckley, West Virginia. 457 pp.
- Shannon and Wilson. 1985. "Underground Engineering and Construction Services." Tunnels and Tunnelling. Volume 17, Number 9, September. Morgan-Grampian Ltd., London, UK.
- Sharp, J.C., Endersbee, L.A., Mellors, T.W. 1984. "Design and Observed Performance of Permanent Cavern Excavations in Weak, Bedded Strata." ISRM Symposium on Design and Performance of Underground Excavations. Cambridge, UK, September 3-6. British Geotechnical Society, London, UK.
- Sherman, W.F. 1963. "Engineering Geology of Cody Highway Tunnels, Park County, Wyoming." pp. 27 - 32. Engineering Geology Case Histories - Number 4. Division of Engineering Geology, Geological Society of America.
- Shi-Zhong, L. 1982. "Rock Support Techniques in China." Tunnels and Tunnelling. Volume 14, Number 3, March. Morgan-Grampian Ltd., London, UK. pp. 63-66.
- "Shotcrete Stabilization in the Philippines." 1985. Tunnels and Tunnelling. Volume 17, Number 1, January. Morgan-Grampian Ltd., London, UK. p. 10.
- Siddle, H.J. and James, C.D. 1987. "Construction and Performance of Drainage Tunnels in South Wales." Tunnels and Tunnelling. Volume 19, Number 3, March. Morgan-Grampian Ltd., London, UK. pp. 44-45.
- Singh, J.G., Upadhyay, P.C., Saluja, S.S. 1980. "Technical Note - The Bending of Rock Plates." International Journal of Rock Mechanics and Mining Sciences & Geomechanics Abstracts. Volume 17, Number 6, December. Pergamon Press Ltd. pp. 377-381.

- Skelly and Loy. 1973. Processes, Procedures, and Methods to Control Pollution from Mining Activities. Contract Report No. 68-01-1830, Office of Air and Water Programs, Water Quality and Non-Point Source Control Division. U.S. Environmental Protection Agency. EPA-430/9-73-011. U.S. Government Printing Office. Washington, D.C.
- "Slopes Study in New Zealand." Tunnels and Tunnelling. Volume 11, Number 6, June. Morgan-Grampian Ltd., London, England. p. 69.
- Smith, D. 1987. "Earthquake Threat Increases In East." Roanoke Times & World-News. Sunday, November 8. p. F1.
- Smith, M. 1988. Personal Communication - Portal Construction. Vice President, Vecellio and Grogan, Inc. Beckley, West Virginia.
- Snowdon, R.A., Glossop, N.H., and Farmer, I.W. 1983. Eurotunnel '83 Conference, Paper 17. Access Conferences Ltd. Marlow, UK. pp. 129-135.
- Sowers, G.F. and Royster, D.L. 1978. "Field Investigation." Chapter 4. Landslides: Analysis and Control. Special Report 176. Transportation Research Board. National Academy of Sciences. Washington, D.C. pp. 81-111.
- Sprouls, M.W. 1988. "Longwall Census '88" Tunnels and Tunnelling. Volume 25, Number 2, February. Morgan-Grampian Ltd., London, UK. pp. 63-80.
- Stafford, S. 1978. "America's Worst Mine Disaster." Mine Safety and Health. Volume 3, No. 1. February/March. Mine Safety and Health Administration. U.S. Department of Labor. U.S. Government Printing Office. Washington, D.C., USA. pp. 12-18.
- Steffen, O.K.H. 1976. "Research and Development Needs in Data Collection for Rock Engineering." Exploration for Rock Engineering. Volume 2. A.A. Balkema, Rotterdam. pp. 93-104.
- Steffens, R.E. 1984. "The Bad Creek Underground Exploratory Program." Proceedings of Tunnelling in Rock and Soil Conference. ASCE. Atlanta. May. pp. 156-181.

- Steffens, R.E. 1988. Personal Communication/Tour - Bad Creek Pump Storage Project. April.
- Steinheuser, G. and Maidl, B. 1983. "Construction of the Westtangente Motorway Tunnel in Bochum Under Extremely Difficult Environmental Conditions." Eurotunnel '83 Conference, Paper 3. Access Conferences Ltd. Marlow, K. pp. 29-33.
- Sterling, R.L. 1980. "The Ultimate Load Behavior of Laterally Constrained Rock Beams." The State of the Art in Rock Mechanics, Proceedings of the 21st U.S. Symposium of Rock Mechanics. D.A. Summers, Editor. University of Missouri, Rolla. pp. 533-542.
- Stewart, R.E., Stewart, M.F. 1962. Adolph Sutro, A Biography. Howel-North Books, Inc. Berkeley, California, USA.
- Szechy, K., 1973. The Art of Tunnelling. 2nd English Edition. Akademiai Kiada, Budapest, Hungary.
- Tedd, P. and Masterton, G.G.T. 1983. "Behavior of the Concrete Lining in the Kielder Water Tunnels." Eurotunnel '83 Conference, Paper 6. Access Conferences Ltd. Marlow, UK. pp. 47-56.
- Terex. 1970. Production and Cost Estimating of Material Movement with Earthmoving Equipment. General Motors Corporation. pp. 67-68.
- Terzaghi, K., 1946. "Rock Defects and Loads on Tunnel Supports." Rock Tunneling with Steel Supports. 1968 Revision. Proctor and White, Editors. Commercial Shearing, Youngstown, OH. pp. 17-99.
- Thoms, I.M., Coates, R., and Turner, V.D. 1986. Tunnels and Tunnelling. Volume 18, Number 11, November. Morgan-Grampian Ltd., London, UK. pp. 39-46.
- Trench, R. and Hillman, E. 1984. London Under London - A Subterranean Guide. John Murray Ltd. London, England, UK. 224 pp.
- Tyrrell, A.P. 1976. "Ground Instrumentation for the Channel Tunnel Project." Exploration for Rock Engineering. Volume One. Z.T. Bieniawski, Editor. Proceedings of the Symposium on Exploration for Rock Engineering, Johannesburg. A.A. Balkema, Rotterdam. pp. 233-241.

- Unal, E. 1983. Design Guidelines and Roof Control Standards for Coal Mine Roofs. Ph.D. Thesis. The Pennsylvania State University. 355 pp.
- U.S. Army Corps of Engineers. 1973. Chemical Grouting. EM 1110-2-3504. Engineering and Design. Department of the Army. Office of the Chief of Engineers. Washington, D.C.
- U.S. Army Corps of Engineers. 1977. Symposium on Detection of Subsurface Cavities. Office, Chief of Engineers and U.S. Army Engineer Waterways Experiment Station. Soil and Pavements Laboratory. Vicksburg, Mississippi.
- U.S. Army Corps of Engineers. 1978. Tunnels and Shafts in Rock. EM 1110-2-2901. Engineering and Design. 1982 Revised Edition. Department of the Army. Office of the Chief of Engineers. Washington, D.C.
- U.S. Army Corps of Engineers. 1980. Rock Reinforcement. EM 1110-1-2907. Engineering and Design. 15 February. Department of the Army. Office of the Chief of Engineers. Washington, D.C.
- U.S. Army Corps of Engineers. 1983. Rock Mass Classification Data Requirements for Rippability. Engineer Technical Letter No. 1110-2-282. Department of the Army. Washington, D.C. 20314-1000.
- U.S. Army Corps of Engineers. 1983. Tilt Measuring Instruments. Engineer Technical Letter No. 1110-2-285. Department of the Army. Washington, D.C. 20314-1000.
- U.S. Army Corps of Engineers. 1984. Grouting Technology. EM 1110-2-3506. Engineering and Design. Department of the Army. Office of the Chief of Engineers. Washington, D.C.
- U.S. Army Corps of Engineers. 1987. Automated Data Acquisition, Geotechnical Instrumentation. Engineer Technical Letter No. 1110-2-306. Department of the Army. Washington, D.C. 20314-1000.
- U.S. Department of Labor. 1986. "Fatalgram." Mine Safety and Health Administration. Metal and Non-metal Mines. April 17, 1986.

- U.S. Department of the Interior. 1983. Approval of State and Indian Reclamation Program Grants Under Title IV of the Surface Mining Control and Reclamation Act of 1977 - Final Environmental Impact Statement. OSM-EIS-11. Office of Surface Mining Reclamation and Enforcement. November. 320 pp.
- "US Hydro Benefits from TBM Tunnelling." Tunnels and Tunnelling. Volume 15, Number 9, September. Morgan-Grampian Ltd., London, UK. p. 7.
- Varnes, D.J. 1978. "Slope Movement Types and Processes." Chapter 2. Landslides: Analysis and Control. Special Report 176. Transportation Research Board. National Academy of Sciences. Washington, D.C. pp. 11-33.
- Varty, A. 1984. "Driving of Inclined Power Tunnels for Lower Pieman Power Station." Fifth Australian Tunnelling Conference - State of the Art in Underground Development and Construction. Sydney, 22-24 October. Australian Institution of Engineers, Barton, ACT, Australia.
- Vecellio, L.A. Sr. 1989. Personal Communication - Kings Mountain Tunnel By-Pass and Quinimont Railway Tunnel. President, Vecellio and Grogan, Inc. Beckley, West Virginia.
- Voytko, E.P., Scovazzo, V.A., and Cope, N.K. 1987. "Rock Slope Modifications Above the North Portal of the Mt. Washington Tunnel." HGS-87-23. Proceedings of the 38th Annual Highway Geology Symposium - Highway Construction in Unstable Topography. Pittsburg, Pennsylvania. May 11 - 13. Pennsylvania Department of Highways and Engineers' Society of Western Pennsylvania.
- Wagner, C.J. 1884. Die Beziehungen der Geologie zu den Ingenieurwissenschaften. Spielhagen and Schurich. Wien. 88 p.
- Wallis, S. 1983. "A Modified TBM Cuts Through the Rough and the Smooth." Tunnels and Tunnelling. Volume 15, Number 6, June. Morgan-Grampian Ltd., London, England, UK. pp. 56-58.
- Wallis, S. 1987. "European Methods Show Their Mettle at Bad Creek." Tunnels and Tunnelling. Volume 19, Number 4, April. Morgan-Grampian Ltd., London, UK. pp. 19-21.

- Wallis, S. 1987. "Caution the Key to Cornish Road Tunnel." Tunnels and Tunnelling. Volume 19, Number 7, July. Morgan-Grampian Ltd., London, UK. pp. 33-34.
- Wallis, S. 1987. "Counting the Cost of NATM Downfalls." Tunnels and Tunnelling. Volume 19, Number 10, October. Morgan-Grampian Ltd., London, UK. pp. 16-20.
- Walters, R.C.S. 1962. Dam Geology. Butterworth. London, England. 334 p.
- "Waterbearing Strata Conquered in Mine Drift." 1988. Tunnels and Tunnelling. Volume 20, Number 1, January. Morgan-Grampian Ltd., London, UK. pp. 41.
- Watson, T.L. 1907. Mineral Resources of Virginia. The Virginia Jamestown Exposition Commission. J.P. Bell Co., Lynchburg, Virginia. p. 440.
- Watts, C.F. and Frizzell, E.M. 1987. "Back Analysis of Rock Slope Stability and Design of Artificial Support Systems Utilizing Microcomputers." 38th Annual Highway Geology Symposium. Pittsburg, Pa, USA. May 11-13.
- Watts, C. 1988. Personal Communication - Crozet/Afton Mountain Tunnel. Radford, Virginia.
- Webster's Seventh New Collegiate Dictionary. 1971. G. & C. Merriam Company. Springfield, Massachusetts. p. 661.
- West Virginia Department of Energy. 1987. Cabin Creek Drainage Project - Abandoned Mine Lands Program. Bidding Information and Construction Specifications. 98 pp.
- White, J. 1988. Personal Communication - Portals Driven from Surface Mine Highwalls and Portal Ruptures. May. Blacksburg, VA.
- Whittaker, B.N. and Kapusniak, S.S. 1984. "Stability Aspects of Major Coal Mining Tunnel Projects." Paper 56. Design and Performance of Underground Excavations. ISRM Symposium, Cambridge, U.K. British Geotechnical Society, London. pp. 461-470.
- Wilbur, Lyman D. 1982. "Rock Tunnels." Chapter 7. Tunnel Engineering Handbook. Van Nostrand Reinhold Company. New York, New York. pp. 123-207.

- Willet, D.C. 1979. "The Development of Tunnelling and the Use of Underground Space Through the Ages." Tunnels and Tunnelling. Volume 11, Number 9, September. Morgan-Grampian House, London, UK. pp. 81-85.
- Wilson, S.D. and Mikkelsen, P.E. 1978. "Field Instrumentation." Chapter 5. Landslides: Analysis and Control. Special Report 176. Transportation Research Board. National Academy of Sciences. Washington, D.C. pp. 112-138.
- "Winter Weather Adds to Hazards of Underground Coal Mining." 1984. Mine Safety and Health. Fall-Winter Edition. Volume 9, Number 3. Mine Safety and Health Administration, U.S. Department of Labor. U.S. Government Printing Office, Washington, D.C., USA. pp. 10-15.
- Wong, R.C.K., Kaiser, P.K. 1985. "Effect of Support Pressure Distribution on Settlement Above Tunnels." Tunnels and Tunnelling. Volume 19, Number 5, May. Morgan-Grampian Ltd., London, UK. pp. 27-30.
- Wood, A.M. 1979. "Ground Behavior and Support for Mining and Tunnelling, Part 1." Tunnels and Tunnelling. Volume 11, Number 5, Morgan-Grampian Ltd., London, UK. pp. 43-48.
- Wood, A.M. 1979. "Ground Behavior and Support for Mining and Tunnelling, Part 2." Tunnels and Tunnelling. Volume 11, Number 6, June. Morgan-Grampian Ltd., London, UK. pp. 47-51.
- Wu, T.H. and Sangrey, D.A. 1978. "Strength Properties and Their Measurement." Chapter 6. Landslides: Analysis and Control. Special Report 176. Transportation Research Board. National Academy of Sciences. Washington, D.C. pp. 139-154.
- Young, R.P. 1978. "Assessing Rock Discontinuities." Tunnels and Tunnelling. Volume 10, Number 6, June. Morgan-Grampian Ltd., London, UK. pp. 45-48.
- Zaruba, Q. and Mencl, V. 1969. Landslides and Their Control. American Elsevier Publishing Company, Inc. New York, New York. 205 p.

- Zhou, Y. 1988. Designing for Upper Seam Stability in Multi-Seam Mining. Ph.D. Dissertation, Department of mining and Minerals Engineering - Virginia Polytechnic Institute and State University, Blacksburg, Virginia. May. 202 pp.
- Zhou, Y., Haycocks, C., and Wu, W. 1987. "An Analysis of Interaction Effects on Overlying Seams by Mining an Underlying Seam." Proceedings of the Fifth Annual Workshop - Generic Mineral Technology Center - Mine Systems Design and Ground Control. Tuscaloosa, Alabama. pp. 99-109.
- Ziegler, T.W. 1972. In Situ Tests for the Determination of Rock Mass Shear Strength. Technical Report S-72-12. Engineering Study 553; Office, Chief of Engineers. Soil and Pavements Laboratory. U.S. Army Engineer Waterways Experiment Station. Vicksburg, Mississippi.

APPENDIX 1. PORTAL NOMENCLATURE AND DEFINITIONS

A1.1 Nomenclature

Figures A1-1 through A1-9 illustrate various portal geometries and associated nomenclature.

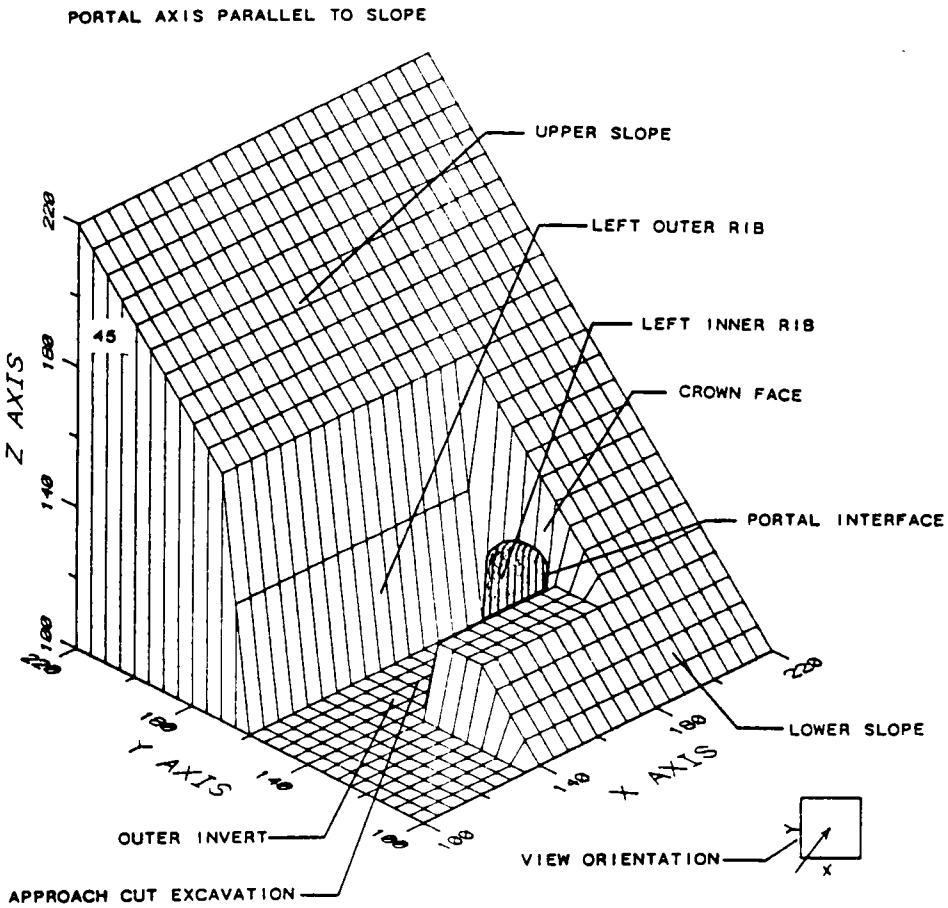

Figure A1-1. 3-D View of a Portal in a 45° Slope (portal axis parallel to slope).

PORTAL AXIS PARALLEL TO SLOPE

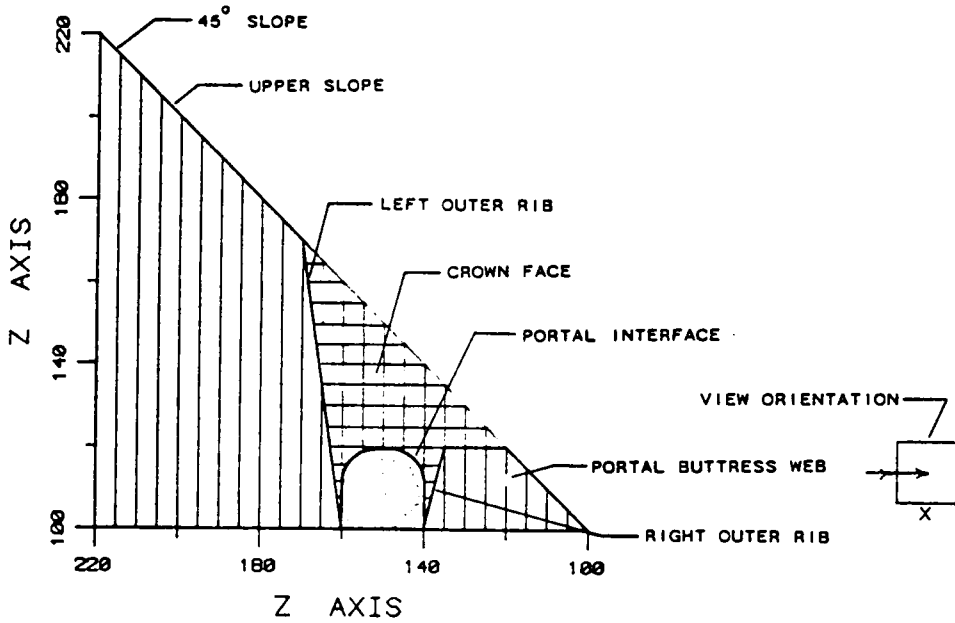

Figure A1-2. Cross Sectional (Portal Centerline Axis) View of a Portal in a 45° Slope (portal axis parallel to slope).

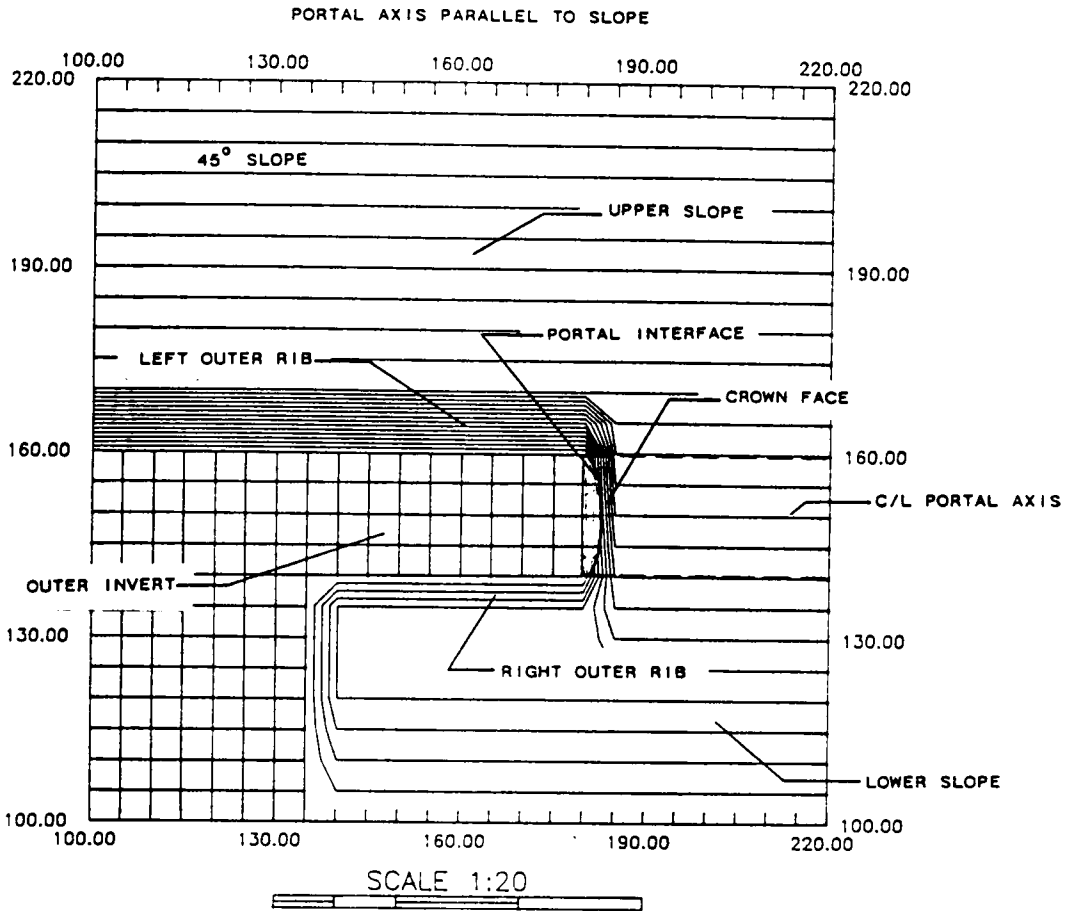

Figure A1-3. Plan View of a Portal in a 45° Slope (portal axis parallel to slope).

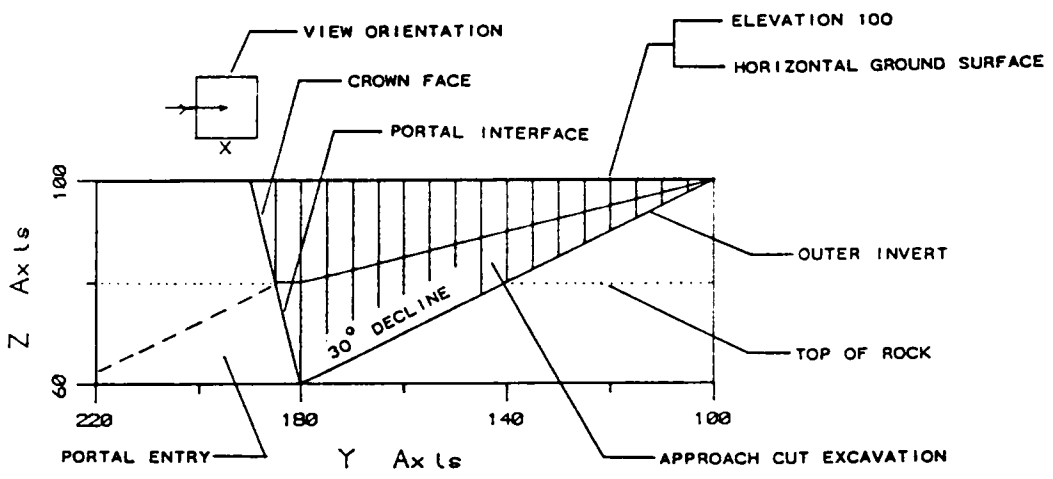
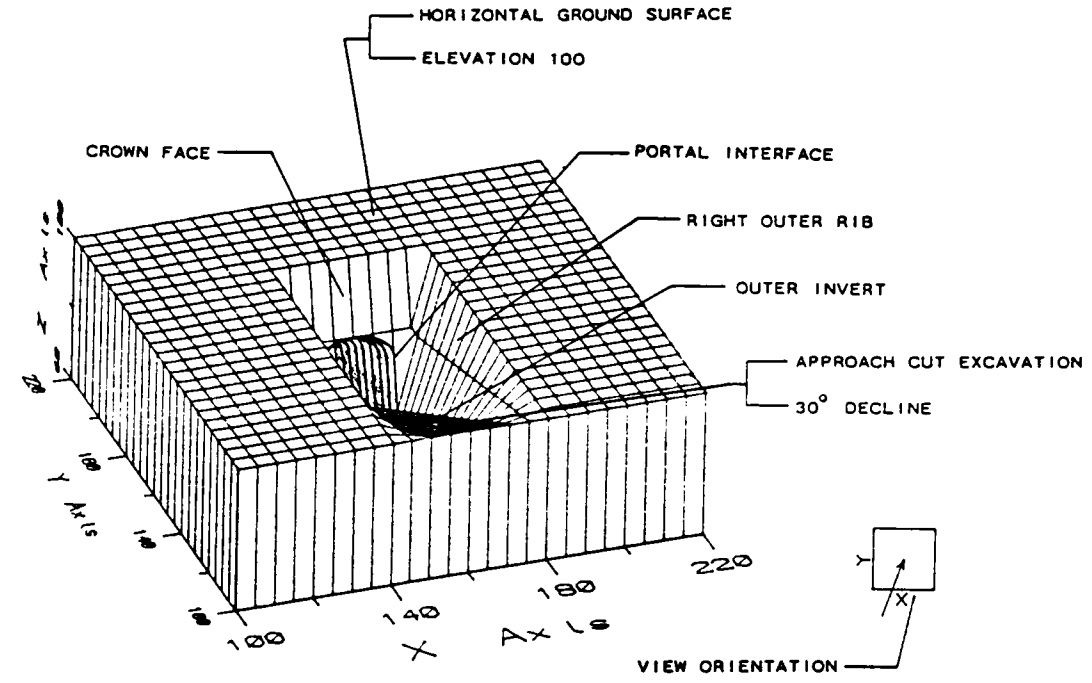

Figure A1-4. 3-D and Cross Sectional (Portal Centerline Axis) View of a Inclined Portal (-30°), Driven from a Horizontal Surface.

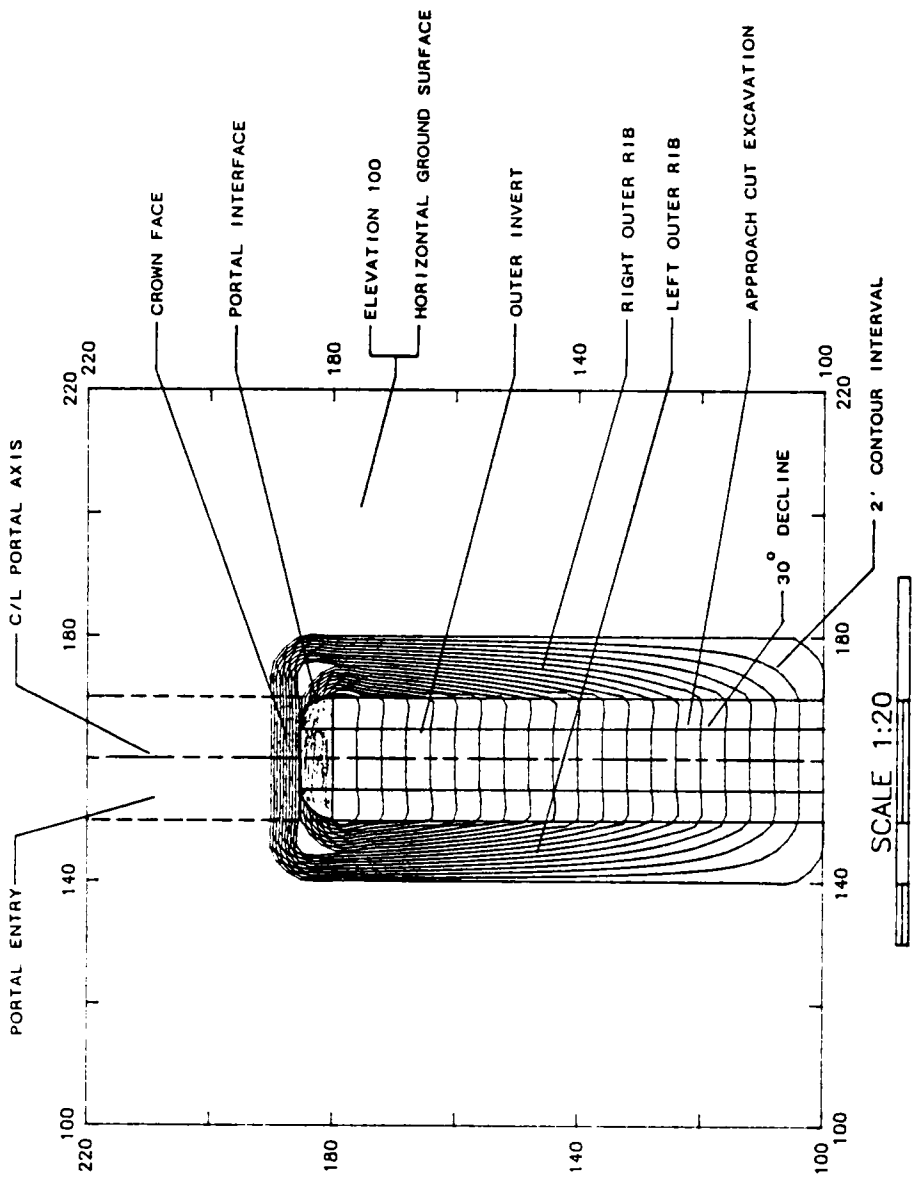

Figure A1-5. Plan View of a Inclined Portal (-30°), Driven from a Horizontal Surface.

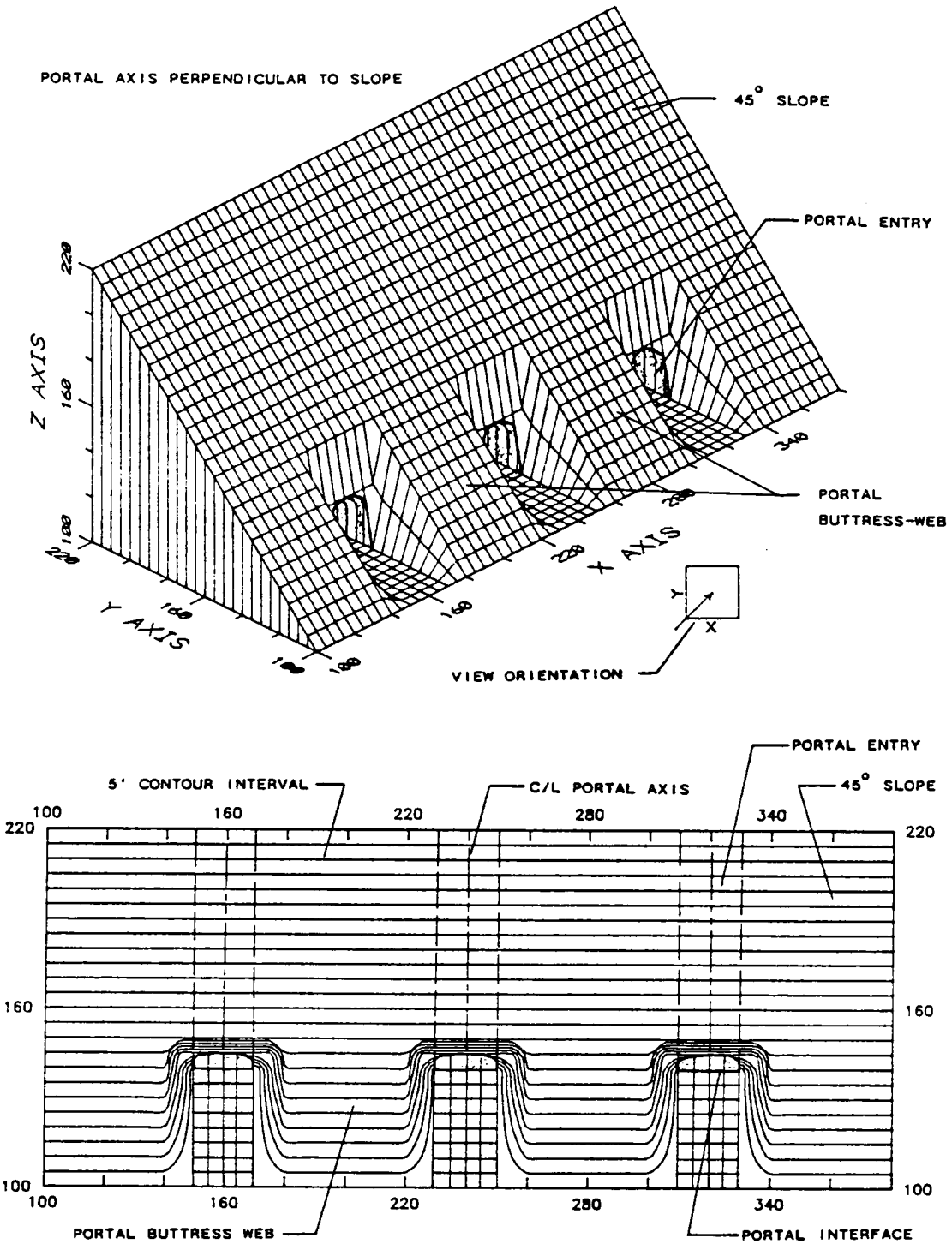

Figure A1-6. 3-D and Plan View of Multiple Portals in a 45° Slope (portals perpendicular to slope).

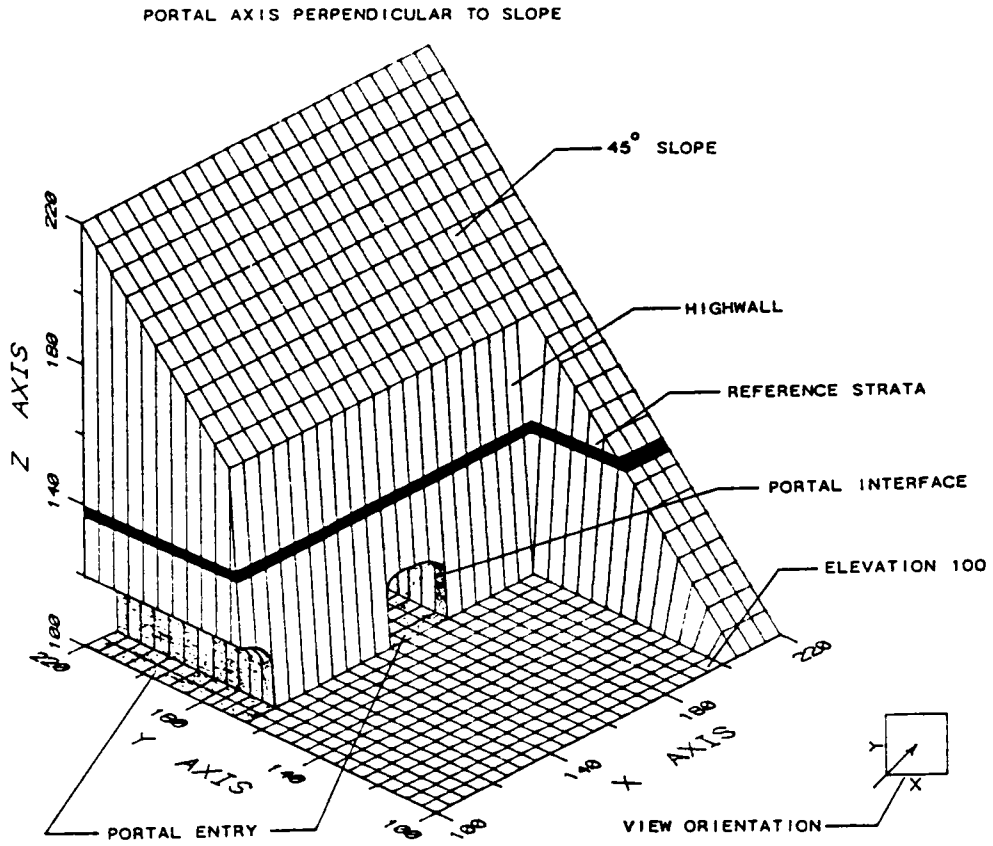

Figure A1-7. 3-D View of Portals Driven Into a Highwall (portals perpendicular to slope).

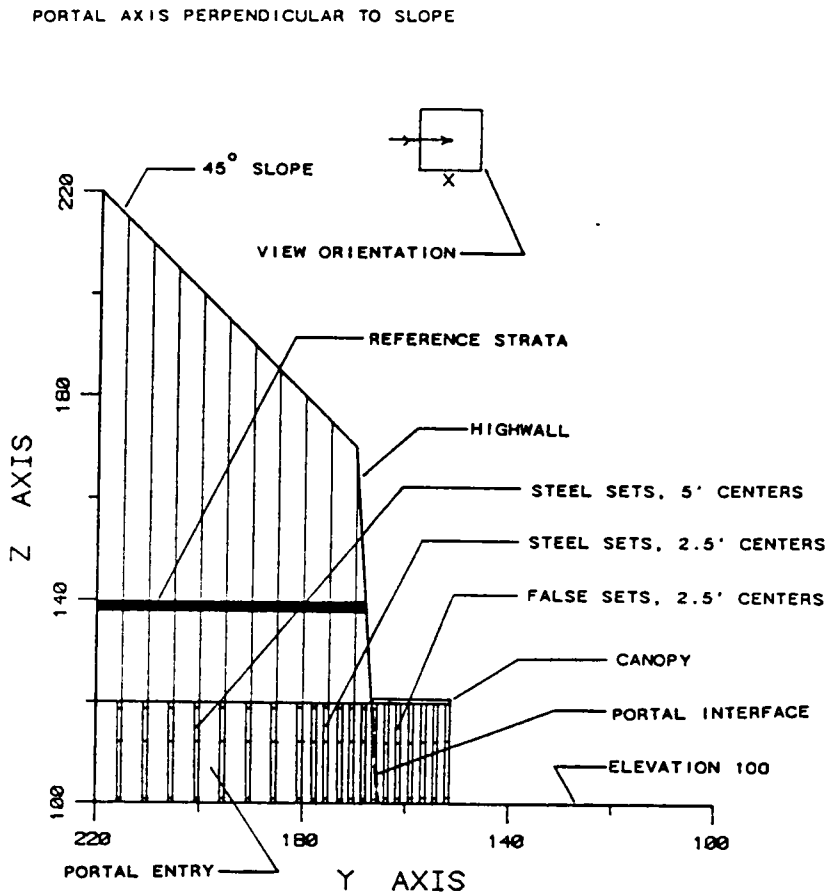

Figure A1-8. Cross Sectional (Portal Centerline Axis) View of Portals Driven Into a Highwall (portals perpendicular to slope).

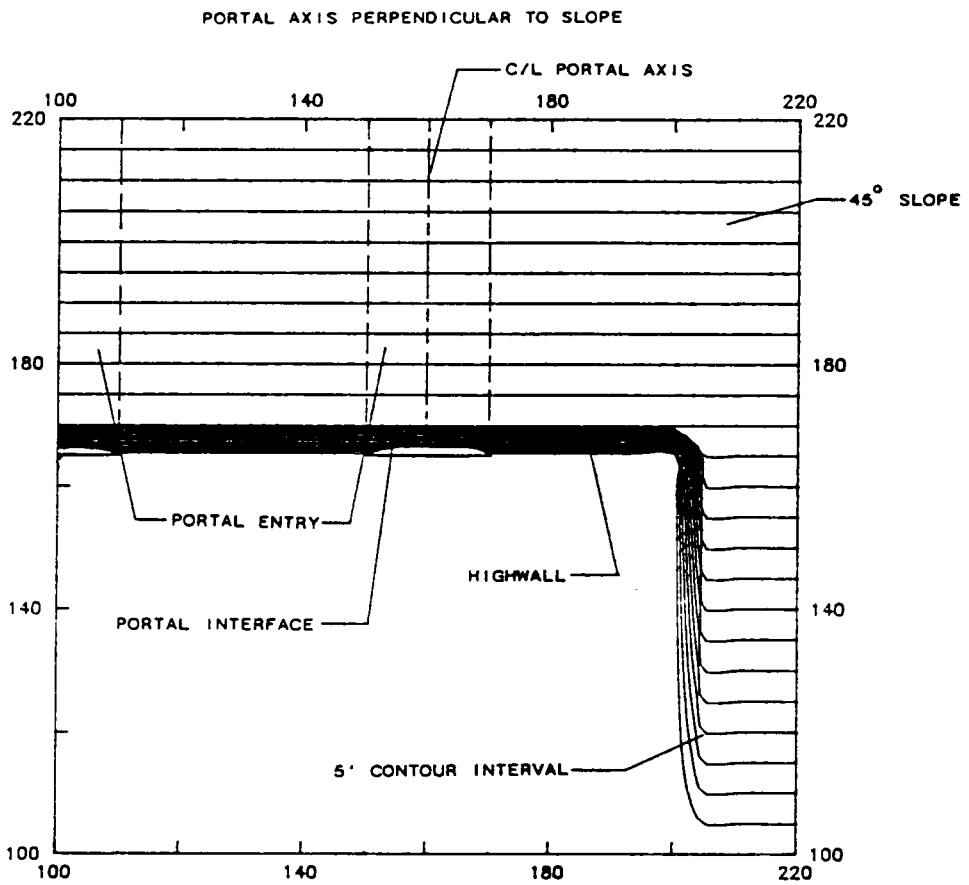

Figure A1-9. Plan View of Portals Driven Into a Highwall (portals perpendicular to slope).

A1.2 Definitions

The following definitions, listed in alphabetical order, include existing subsurface definitions as well as new definitions created specifically during the course of the investigation:

approach cut - The surface excavation typically leading into a hillside in which the portal entry is driven. The approach cut is bounded by the crown and rib faces, outer ribs, and outer invert. Approach cuts are typically inclined at the same angle as the portal entry.

berm - Intact rock left between portals, outby the portal interface, to act as a buttress against the crown face and upper slope.

canopy - Overhead and rib protection outby the portal interface from material raveling off the crown face, upper slope, and outer ribs. False sets, liner plate, and/or cribs & caps commonly utilized.

centerline axis - Center line of tunnel or portal.

cover - Term synonymous with overburden. The material above the crown of the portal entry. For example, turn-under cover would be the amount of material above the crown at the portal interface.

crown - The ceiling or roof of the portal entry.

crown face - The face approximately perpendicular to the portal centerline axis, above the springline and portal interface, and typically bounded by the portal entry, outer ribs, and upper slope.

false sets - Steel sets, typically fully lagged, placed outby the portal interface to act as a protective canopy, insure working compliance, and provide axial restraint for the first sets inby the portal interface.

inby or inner - Into the portal/tunnel from the portal interface (e.g. inner rib or inby invert, etc.).

invert - The floor of the portal entry and approach cut, bounded by the face and ribs.

lower slope - The slope adjacent to the portal, that lies below the top edge of the crown face and is bounded by the outer ribs. Extreme bounds are dictated by surface topography and rock mass discontinuities.

outby or outer - Out of the portal/tunnel from the portal interface and thus into the portal approach cut (e.g. outer rib or outby invert, etc.).

portal - [From the Latin porta, meaning gate]

The approach or entrance to a bridge or tunnel (Webster's, 1977). For the purpose of this research, a portal is defined as the approximately horizontal entrance (e.g. $\pm 35^\circ$ from horizontal) to an underground excavation, and typically consists of an approach cut and a section of underground

entry. Based on research herein presented, the minimum length of the portal zone is considered to be approximately two diameters (e.g. spans), one diameter outby the portal interface, and one diameter inby the portal interface.

portal entry - The underground portion of the portal beginning at the portal interface and extending inby a minimum of 1 portal diameter (e.g. span).

portal-in - Mining and tunnelling term describing the initial excavation into a prepared portal face. Synonymous terms are 'heading-in,' 'heading under,' and 'turning under.' Considered to be the most difficult aspect of portal construction.

portal interface - An imaginary plane, not necessarily vertical, at the interface between the surface (e.g. portal approach cut) and the subsurface (e.g. portal entry). Similar to the plane bounded by a common door frame, and used as a point of reference (e.g. 1 diameter inby the portal interface).

rib - The sides or walls of the portal entry and approach cut (e.g. right inner rib or right outer rib, etc.), from the invert to the crown or springline. The right side of a portal is the right side looking into or inby the portal from the approach cut.

rib face - The face below the springline, approximately perpendicular to the portal centerline

axis, and commonly in the same plane as the crown face. If this face is parallel to the tunnel centerline axis, it is considered an outer rib.

upper slope - The slope above the portal interface, bounded at its lower extreme by the crown face. The extreme upper and lateral bounds depend upon surface topography and rock mass discontinuities.

web - The material between a portal rib or crown and the external slope (e.g. portal being driven parallel to a slope) or the material between two adjacent portals, normally considered to be inby the portal interface. Thus, outby the portal interface, this material is considered to be berm.

APPENDIX 2. PORTAL AND INDUSTRY REFERENCES

A2.1 Portal References

The references below relate specifically to portals in terms of excavation, support, and overall design practices:

- Abramson, L.W., Daly, W.F. 1986. "Analysis and Rehabilitation of Aging Rock Slopes." Unpublished Presentation to North Carolina Highway Geology Meeting. Parsons Brinckerhoff Quade & Douglas, Inc. New York. 18 pp.
- Ackenheil, A. 1987. "Ft. Pitt Tunnel North Portal Cut Slopes Revisited." HGS-87-5. Proceedings of the 38th Annual Highway Geology Symposium - Highway Construction in Unstable Topography. Pittsburg, Pennsylvania. May 11 - 13. Pennsylvania Department of Highways and Engineers' Society of Western Pennsylvania.
- Barisone, G., Pelizza, S., and Pigorini, B. 1983. "Italian Experiences with Tunnel Portals in Difficult Ground." Eurotunnel '83 Conference, Paper 21. Access Conferences Ltd. Marlow, UK. pp. 157-163.
- Beckley Post-Herald. 1968. "49 Men Trapped by a Rock Fall." Volume 69, Number 117, May 15, P. 1.
- Cordova, T. 1965. "Geology and Geotechniques of the Carlin Canyon Tunnels, Interstate Highway 80, Through Carlin Canyon, Elko County, Nevada." Proceedings of the Third Annual Engineering Geology and Soils Engineering Symposium. Boise, Idaho, USA. April 6-8. pp.199-215.
- Craig, C.L. and Brockman, L.R. 1971. "Survey of Tunnel Portal Construction at U.S. Army Corps of Engineers Projects." Symposium on Underground Rock Chambers. American Society of Civil Engineers. New York, New York. pp. 167-201.

- Fawcett, D.H. and Kershaw, T. 1984. "Design of Entries for German Creek No. 1 Underground Coal Mine." Fifth Australian Tunnelling Conference - State of the Art in Underground Development and Construction. Sydney, 22-24 October. Australian Institution of Engineers, Barton, ACT, Australia. p. 11 - 33.
- James, H.B. 1984. "Establishment of Portals for Two Road Tunnels." Fifth Australian Tunnelling Conference - State of the Art in Underground Development and Construction. Sydney, 22-24 October. Australian Institution of Engineers, Barton, ACT, Australia. p. 164 - 169.
- Martin, R.E. 1987. "Beavertail Tunnels Interstate I-70." Proceedings of the Rapid Excavation and Tunneling Conference. June 14-17. Society of Mining Engineers of AIME, Inc. Littleton, Colorado. pp. 653-661.
- Parsons Brinckerhoff-Hirota Associates. 1988. Trans-Koolau Exploratory Tunnel Geotechnical Design Summary Report. FAIP No. I-H3-1(37). Prepared for State of Hawaii, Dept. of Transportation, Highways Division. 59+ pp.
- Paterson, T. and Arthur, L.J. 1979. "Tunnel Portals at Dinorwic, North Wales." Proceedings of the 2nd International Symposium. Tunnelling '79. Institution of Mining and Metallurgy. London, UK. pp.3-14
- Rogers, G.K. 1987. Report of Prices Fork/Milletts Tunnel Slide. Unpublished Slope/Portal Failure Investigation. Virginia Polytechnic and State University. Mining Department. 24 pp.
- Rogers, G.K. 1987. Low Moor Abandoned Underground Limestone Mine. Unpublished Report of Field Investigations, Low Moor, Virginia, USA. 22 pp.
- Rogers, G.K., et al. 1988. Tunnelling Operations at the Bad Creek Pumped-Storage Project - Duke Power Company, South Carolina. Unpublished Report and Notes. April 14-16. 80 pp.
- Rogers, G.K. and Haycocks, C. 1988. "Portal Stability in Rock." 7th International Conference on Ground Control in Mining. West Virginia University. August 3-5. Morgantown, WV. 8 pp.

- Rogers, G.K. and Haycocks, C. 1989. "The Stability of Rock Slopes with In Situ Cavities." 1989 Multinational Conference on Mine Planning and Design. May 22-26. Lexington, Kentucky. 6 pp.
- Rogers, G.K. and Haycocks, C. 1989. "Rock Classification for Portal Design." 30th U.S. Symposium on Rock Mechanics. International Society of Rock Mechanics and U.S. National Committee for Rock Mechanics. West Virginia University, Morgantown, WV. June 19-22. 8 pp.
- U.S. Department of Labor. 1986. "Fatalgram." Mine Safety and Health Administration. Metal and Non-metal Mines. April 17, 1986.
- Voytko, E.P., Scovazzo, V.A., and Cope, N.K. 1987. "Rock Slope Modifications Above the North Portal of the Mt. Washington Tunnel." HGS-87-23. Proceedings of the 38th Annual Highway Geology Symposium - Highway Construction in Unstable Topography. Pittsburg, Pennsylvania. May 11 - 13. Pennsylvania Department of Highways and Engineers' Society of Western Pennsylvania.

A2.2 Industry References

Due to several requests for anonymity and/or specific connection to particular design methods/philosophies, the references from knowledgeable industry personnel which were not included in Section 3, are listed both in the Reference section and this appendix as follows:

- Brekke, T. 1982. Personal Communication - Portal Stability. University of California, Berkeley, California.
- Brierley, G.S. 1988. Personal Communication - Portal Stability, President - Brierley & Lyman, Inc. October 18.

- Cavers, D. 1988. Personal Communication - Portal Stability and Thick Application Shotcrete, Geotechnical Engineer, Hardy BBT, Inc., Vancouver. October 25.
- Compton, J. 1989. Personal Communication - Laborer on East River and Big Walker Mountain Portals, Interstate 77, Virginia. January 17.
- Cook, P. 1988. Personal Communication - Retired WV State Mine Inspector - June 6, Beckley, West Virginia.
- Decker, D. 1988. Personal Communication - Laurel Mountain Mine Portals, near Cleveland Virginia, Clinchfield Division Mining Engineer, Pittston Coal Company.
- Dillon, L.A. 1986. Personal Communication - Mine Disasters and Portals (Author of two books on mine disasters, West Virginia).
- Flanagan, R.F. 1988. Personal Communication - Portal Stability and Design for the Cumberland Gap Highway Tunnels, Design Engineer, Parsons Brinckerhoff Quade and Douglas, Herndon, Virginia. November 16.
- Forrest, P. 1988. Personal Communication - Balcombe Tunnel, UK." June 13th.
- Gilmer, F.M. 1988. Personal Communication - Portal Problems at East River and Big Walker Mountain Tunnel Portals. District Geologist, Staunton, VA.
- Hansmire, W.H. 1988. Personal Communication concerning the Trans-Koolau Tunnels. Project Manager - Parsons Brinckerhoff Quade & Douglas, Inc. January 12.
- Henderson, T. 1989. Personal Communication - Pearpoint Mine Portals, Westmoreland Coal Company, Virginia. January 18.
- Kennedy, H. 1988. "Personal Communication and Visit - Virginia Lime Co. Portal Stability, Kimballton, Giles County, Virginia."
- Kuesel, T.R. 1988. Personal Communication - Portal Stability. Chairman of the Board, Parsons Brinckerhoff Quade and Douglas, Inc., New York. October 13.
- Olmedo, M.E. 1987. Personal Communication. Vice President of Research and Development, James River Limestone Co., Inc. Buchanan, VA.

- Orr, J. 1982. Personal Communication - Feather Fork Gold Mine, Guiverson Incline Portal. La Porte, Plumas County, California.
- Pearce, S. 1988. Personal Communication/Tour - Bad Creek Pump Storage Project, Project Engineer, Gilbert Corporation of Delaware, Inc. April.
- Petrofsky, A.M. 1988. Personal Communication - Portal Stability, Professional Engineer, Jacobs Associates, San Francisco, California. October 18.
- Robinson, R.H. 1988. Personal Communication - Portal Stability, Manager of Mining Engineering, Pincock, Allen & Holt, Inc., Lakewood, Colorado. October 14.
- Rogers, R.J., Rogers, J.W. 1980. "Personal Communication - Crow railway tunnel portals, Fort Spring Limestone Mine, C&O Railroad Tunnel Portals, Raleigh and Beaver Coal Mines, Beckley Exhibition Coal Mine, Low Moor Abandoned Limestone Mine.
- Seijo, M. 1988. Personal Communication. Abandoned Mine Lands Program - West Virginia Department of Natural Resources. Mine Closure Projects: Ames, Cabin Creek, Oceana, Sissonville. December 4, Interview.
- Smith, M. 1988. Personal Communication - Portal Construction. Vice President, Vecellio and Grogan, Inc. Beckley, West Virginia.
- Steffens, R.E. 1988. Personal Communication/Tour - Bad Creek Pump Storage Project, Design Engineer II, Design Engineering, Duke Power. April.
- Vecellio, L.A. Sr. 1989. Personal Communication - Kings Mountain Tunnel By-Pass and Quinimont Railway Tunnel. President, Vecellio and Grogan, Inc. Beckley, West Virginia.
- Watts, C. 1988. Personal Communication - Crozet/Afton Mountain Tunnel. Blacksburg, Virginia.
- White, J. 1988. Personal Communication - Portals Driven from Surface Mine Highwalls and Portal Ruptures. May. Blacksburg, VA.

APPENDIX 3: INDUSTRY COMMENTS

A3.1 Conservative Design

Portals should be designed conservatively as they are a "necessary evil", since problems and delays are commonly encountered due to poor quality rock masses that tend to weather and deteriorate quickly. Every portal requires a different design; however, in general they have almost no impact on project cost or schedule. Most portal designs are based on previous experience in similar conditions, rather than numerical analysis. The most difficult portals involve mixed-face, weathered, or soft ground conditions as specialized design and construction methods are often required.

A3.2 Information Available

A definite lack of information regarding portal design in literature was acknowledged. The Corps of Engineers, Engineering and Design Manual - Tunnels and Shafts in Rock (EM 1110-2-2901), was referred to several times as the most valuable empirical guide to portal design (U.S. Army Corps of Engineers, 1978).

A3.3 Depth to Turn-Under

Two contributors mentioned the recommendations as made in a Corps of Engineer design manual, for a depth of turn-

under of at least one diameter in good, massive rock to a depth three or more diameters in poor, highly fractured or weathered rock masses (U.S. Corps of Engineers, 1978). The remainder specified an initial turn-under depth of 1 to 2 diameters above the crown or at the point where surface excavation costs equal subsurface excavation costs. Hence, as much of the portal as possible should be excavated by less expensive surface methods, forming approach cut slopes of 60° or greater. One of the most common tunnel change orders is for a revision of portal approach cut slopes. Turn-under problems were also noted at shaft insets and at tunnel-powerhouse interfaces.

A3.4 Proprietary Information

If no specific portal designs are provided within a contract, the choice of portal support and excavation sequence is often left to the contractor. Thus, portal design and drivage methods are often considered proprietary information and would not be released. Several contributors noted that detailed and specific information could not be released due to potential liability reasons.

A3.5 Location

Portals should be established in the most competent rock of the site. Bad locations should definitely be avoided if possible. Even though difficult portal

locations are typically associated with slope stability problems, detailed rock slope stability analyses are not typically performed. There is normally much less concern for subsurface seismic stability of the portal entry as compared to the external rock slopes surrounding the portal. When driving in a location involving bedded formations, it is advisable to place weaker strata in invert, if possible.

A3.6 Support

Portals typically require special support techniques that are implemented as quickly as possible after excavation. The conservative use of multiple support systems is definitely recommended to avoid potential problems. There is an increasing trend to rely on immediate support in the form of thick shotcrete applications, with rock reinforcement, instead of massive cast concrete portal structures and wingwalls. False sets and canopies are an inexpensive safety feature; however, one must be careful with their loading conditions. Water infiltration in portal areas, even with elaborate drainage provisions, tends to be a problem. Icing is still a major problem for portals in colder climates resulting in portal blockage and raveling damage.

A3.7 Failure

Portal failures were acknowledged as common and were generally discussed in terms of large overall instabilities in which an entire slope surrounding the portal drivage fails, or in terms of local instabilities where smaller, isolated blocks and wedges fail. Overbreak failures of the latter type are quite common in and around portals, especially at the portal interface.

A3.8 Practical Methodology

Several of the various design engineers contacted elaborated on the need for "practical" methods and techniques pertaining to concerned portals. Methods that are simple to use with an applicability to a wide range of rock mass conditions were definitely preferred, while overly complex and condition-specific methods, especially computer-based systems that cannot be readily checked via manual means (e.g. key block theory, finite element analyses), were considered of little value for portals and were generally avoided if possible. The concept of an easily accessible portal database, as well as a design model for the most common mode of failure along with general excavation/support guidelines was thought to be of great benefit to the industry, with the majority of design personnel contacted requesting further information when available.

APPENDIX 4: PORTAL DATABASE - TABLE FORMAT

Table A4-1. Portal Case History Database.

#	NAME, LOCATION	TYPE #	AGE	SHP	DIA	WID	HT	CS	ROCK	DIF	LTH	FAIL	SUPPORT	DRI/SEC	REFERENCE
1	Abbadia, Italy	H 1	4	H	-	31	25	-	S/M	S	-	-	-	C/FF	(Abersten, et al., 1985)
2		H 2	4	H	-	31	25	-	S/M	S	-	-	-	C/FF	
3	Aberdeen, Hong Kong	H 1	11	H	-	-	-	-	I/W	P,F	164	USS	C,RR,PS	H/M	(James, 1984; Bevan, 1984)
4		H 2	11	H	-	-	-	-	I/W	P	164	-	C,RR,PS	H/M	
5		H 3	11	H	-	-	-	-	I/W	P,F	164	IC	RR	H/FF	
6		H 4	11	H	-	-	-	-	I/W	P	-	-	C,RR,PS	C/HB	
7		H 5	11	H	-	-	-	-	I/W	P	-	-	C,RR,PS	C/HB	
8		H 6	11	H	-	-	-	-	I/W	P	-	-	RR	C/FF	
9	Acme, WV, USA *	M 1	30	R	-	40	25	-	S/M	F,O	40	CFO	N	C/FF	(Rogers, 1980) (Field Investigation)
10		M 2	30	R	-	40	25	-	S/M	F,O	40	CFO	N	C/FF	
11	Ahmed Hamdi, Egypt	H 1	9	C	34	34	34	913	S/W	O	34	-	RR,PS	M/FF	(Lyons, et al., 1983)
12		H 2	9	C	34	34	34	913	S/W	O	34	-	RR,PS	M/FF	
13	Alamo, AZ, USA	W 1	23	H	-	20	18	-	M/BS	F	20	CFO	RR	C/FF	(Craig and Brockman, 1971)
14		W 2	23	H	-	20	18	-	M/BS	-	20	-	RR	C/FF	
15	Alesund, Norway	H 1	3	D	-	-	-	732	M/BS	F,A	-	-	C,RR	C/HB	(Martin, 1987)
16		H 2	3	D	-	-	-	732	M/BS	-	-	-	C,RR	C/HB	
17	Alvin R. Bush, PA	W 1	29	H	-	15	20	-	S/BS	F	20	CFO	RR	C/HB	(Craig and Brockman, 1971)
18	Ames, WV, USA *	M 1	48	R	-	18	8	144	S/BS	F,A	36	CFO, IC	RR,PS	C,H/FF	(Seijo, 1988; Field Investigation)
19		M 2	48	R	-	18	8	144	S/BS	F,A	36	CFO, IC	RR,PS	C,H/FF	
20		M 3	48	R	-	18	8	144	S/BS	F,A	36	CFO, IC	RR,PS	C,H/FF	

NAME, LOCATION TYPE # AGE SHP DIA WID HT CS ROCK DIF LTH FAIL SUPPORT DRI/SEC REFERENCE

Table A4-1. Portal Case History Database (continued).

#	NAME, LOCATION	TYPE	#	AGE	SHP	DIA	WID	HT	CS	ROCK	DIF	LTH	FAIL	SUPPORT	DR1/SEC	REFERENCE
21	Ames, WV, USA *	M	4	48	R	-	18	8	144	S/BS	F,A	36	CFO	RR,PS	C,H/FF	(Seijo, 1988; Field Investigation)
22		M	5	48	R	-	18	8	144	S/BS	F,A	36	SC	RR	C,H/FF	
23		M	6	48	R	-	18	8	144	S/BS	F,A	36	SC	RR	C,H/FF	
24		M	7	48	R	-	18	8	144	S/BS	F,A	36	SC	RR	C,H/FF	
25		M	8	48	R	-	18	8	144	S/BS	F,A	36	SC	RR	C,H/FF	
26		M	9	48	R	-	18	8	144	S/BS	F,A	36	SC	RR	C,H/FF	
27	Anderson, WV, USA*	M	1	58	R	-	8	2	16	S/BS	F,A	24	SC, IF	C,RR	H/FF	(Rogers, 1980; Field In.)
28	Aqua Blanca,	W	1	11	C	-	-	-	-	S/HE	P,F	-	SC	RR,OC	C/-	("Guatemalan...", 1985)
29	Guatemala	W	2	11	C	-	-	-	-	S/HE	-	-	-	RR,OC	C/-	
30	Arco, CO, USA	M	1	6	D	-	16	11	-	S/HE	P	-	-	RR	C/FF	(Colorado ..., 1982)
31		M	2	6	D	-	16	11	-	S/HE	P	-	-	RR	C/FF	
32		M	3	6	D	-	16	11	-	S/HE	P	-	-	RR	C/FF	
33		M	4	6	D	-	26	11	-	S/HE	P	-	-	RR	C/FF	
34		M	5	6	D	-	26	11	-	S/HE	P	-	-	RR	C/FF	
35	Austinville, VA,	M	1	49	H	-	20	15	-	S/BS	FAO	40	SC	N	C/FF	(Olmedo, 1987;
36	USA *	M	2	49	D	-	40	40	-	S/M	A,O	-	-	N	C/HB	Field Investigation)
37		M	3	49	D	-	30	60	-	S/M	A,O	-	-	N	C/HB	
38	A4061, UK	W	1	1	D	-	-	-	-	S/HE	P,F	59	SC	RR	C,H/FF	(Siddle, et al., 1987)
39		W	2	1	D	-	-	-	-	S/HE	P	-	-	RR	C,H/FF	
40	Bad Creek, SC, USA*	W	1	3	H	-	30	27	756	M/BS	P,F	120	CFO, USS	RR,PS	C/HB	(Rogers, et al, 1988;
#	NAME, LOCATION	TYPE	#	AGE	SHP	DIA	WID	HT	CS	ROCK	DIF	LTH	FAIL	SUPPORT	DR1/SEC	REFERENCE

Table A4-1. Portal Case History Database (continued).

#	NAME, LOCATION	TYPE	#	AGE	SHP	DIA	WID	HT	CS	ROCK	DIF	LTH	FAIL	SUPPORT	DRI/SEC	REFERENCE
41	Bad Creek, SC,	W	2	13	H	-	10	9	83	M/BS	P, F	10	CFO, USS	RR	C/FF	(Holley, 1987; Overlie,
42	USA *	W	3	-	C	30	30	30	707	M/BS	P	120	-	RR, PS	C/HB	et al., 1987; Steffens,
43		W	4	-	C	30	30	30	707	M/BS	P	120	-	RR, PS	C/HB	1984; Wallis, 1987)
44	Balcombe, UK	R	1	75	H	-	-	-	-	S/BS	O	25	-	RR	C/FF	("Icycles...", 1985; Forrest, 1988)
45	Beaver, WV, USA *	M	1	58	R	-	6	2	12	S/BS	F, A	24	IF, USS, IC	RR	H/FF	(Rogers, 1980)
46	Beavertail, CO,	H	1	3	H	-	48	37	-	S/W	P, F	100	USS, USS	RR, OC, PS	M, C/HB	(Martin, 1987)
47	USA	H	2	3	H	-	48	37	-	S/W	P	-	-	RR, OC, PS	M, C/HB	
48		H	3	3	H	-	48	37	-	S/W	P	-	-	RR, OC, PS	M, C/HB	
49		H	4	3	H	-	48	37	-	S/W	P	-	-	RR, OC, PS	M, C/HB	
50	Beckley, WV, USA *	M	1	93	R	-	10	3	30	S/HF	P, F	40	SC, IC	RR	C, H/FF	(Field Investigation)
51		M	2	25	R	-	10	7	70	S/HF	P, F	40	SC	RR, PS	C, M/FF	
52		M	3	25	R	-	10	7	70	S/HF	P, F	40	SC, IC	RR, PS	C, M/FF	
53	Big Walker, VA,	H	1	20	H	-	42	38	-	S/BS	P, F	80	USS	RR, PS	C/HB	(Compton, 1989; Gilmer,
54	USA *	H	2	20	H	-	42	38	-	S/BS	P	-	-	RR, PS	C/HB	1988; Proctor & White,
55		H	3	20	H	-	42	38	-	S/BS	P	-	-	RR, PS	C/HB	1968; Field
56		H	4	20	H	-	42	38	-	S/BS	P	-	-	RR, PS	C/HB	Investigation)
57	Birch, WV, USA *	M	1	25	R	-	16	7	112	S/BS	P, F	32	CFO, SC	RR, C	C, M/FF	(Field Investigation)
58		M	2	25	R	-	16	7	112	S/BS	P, F	32	CFO, SC	RR	C, M/FF	

NAME, LOCATION TYPE # AGE SHP DIA WID HT CS ROCK DIF LTH FAIL SUPPORT DRI/SEC REFERENCE

Table A4-1. Portal Case History Database (continued).

#	NAME, LOCATION	TYPE	#	AGE	SHP	DIA	WID	HT	CS	ROCK	DIF	LTH	FAIL	SUPPORT	DRI/SEC	REFERENCE	
59	Birch, WY, USA *	M	3	25	R	-	16	7	112	S/BS	P,F	32	CFO, SC	RR	C,M/FF	(Field Investigation)	
60		M	4	25	R	-	16	7	112	S/BS	P,F	16	CFO	RR,C	C,M/FF		
61		M	5	25	R	-	16	7	112	S/BS	P,F	16	USS	RR,C	C,M/FF		
62		M	6	25	R	-	16	7	112	S/BS	P,F	16	USS	RR,C	C,M/FF		
63		M	7	25	R	-	16	7	112	S/BS	P,F	16	USS	RR,C	C,M/FF		
64	Blakely Mt., AR, USA	W	1	40	H	-	25	25	-	S/HF	N	-	-	RR	C/FF	(Craig & Brockman, 1971; Bennett, 1985)	
65		W	2	40	H	-	25	25	-	S/HF	P,F	200	CFO	RR	C/FF		
66		W	3	40	H	-	25	25	-	S/HF	N	-	-	RR	C/FF		
67		W	4	40	H	-	25	25	25	-	S/HF	P	200	-	RR	C/FF	
68		W	5	40	H	-	36	36	36	-	S/HF	P,F	36	CFO	RR	C/FF	
69		W	6	40	H	-	36	36	36	-	S/HF	P	200	-	RR	C/FF	
70		W	7	40	H	-	36	36	36	-	S/HF	P,F	36	CFO	RR	C/FF	
71		W	8	40	H	-	36	36	36	-	S/HF	P	200	-	RR	C/FF	
72	Blaubeuren, Germany	H	1	9	H	-	-	-	1033	S/BS	P,F	33	IC	RR	C,M/FF	(Harding, 1981)	
73		H	2	9	H	-	-	-	1033	S/BS	P,S	99	-	RR	C,M/FF		
74	Blue River, OR, USA	W	1	21	H	-	25	25	-	I/W	P,F	25	CFO	RR	C/FF	(Craig & Brockman, 1971; Bennett, 1985)	
75		W	2	21	H	-	25	25	-	I/BS	N	-	-	RR	C/FF		
76	Bohdalec, Czechoslovakia	R	1	35	H	-	-	-	-	S/HF	P,F	-	ORS	-	-/-	(Zaruba, et al., 1969)	
77	Brides Veil, Norway	H	1	7	D	-	31	-	-	M/HF	P,F	197	IC	RR	C/FF	(Martin, 1983)	

NAME, LOCATION TYPE # AGE SHP DIA WID HT CS ROCK DIF LTH FAIL SUPPORT DRI/SEC REFERENCE

Table A4-1. Portal Case History Database (continued).

#	NAME, LOCATION	TYPE	#	AGE	SHP	DIA	WID	HT	CS	ROCK	DIF	LTH	FAIL	SUPPORT	DRJ/SEC	REFERENCE
78	Buford, GA, USA	W	1	30	H	13	13	13	-	M/M	N	-	-	RR	C/FF	(Craig & Brockman, 1971; Bennett, 1985)
79		W	2	30	H	13	13	13	-	M/M	N	-	-	RR	C/FF	
80		W	3	30	H	25	25	25	-	M/M	F	25	CFO	RR	C/HB	
81		W	4	30	H	25	25	25	-	M/M	N	-	-	RR	C/HB	
82		W	5	30	H	25	25	25	-	M/M	F	25	CFO	RR	C/HB	
83		W	6	30	H	25	25	25	-	M/M	N	-	-	RR	C/HB	
84		W	7	30	H	16	16	16	-	M/M	N	-	-	RR	C/FF	
85		W	8	30	H	16	16	16	-	M/M	N	-	-	RR	C/FF	
86	Cabin Creek, WV, USA	M	19	38	R	-	6	4	24	S/BS	F,A	18	SC(19)	RR	C,H/FF	(Seijo, 1988; WV DOE, 1987)
105		M	20	38	R	-	6	4	24	S/BS	F,A	12	CFO(20)	RR	C,H/FF	
125	Cagles Mill, IN, USA	W	1	40	H	-	15	15	-	S/M	F	15	CFO	RR	C/FF	(Craig & Brockman, 1971; Bennett, 1985)
126		W	2	40	H	-	15	15	-	S/M	N	-	-	RR	C/FF	
127	Carsington, England, UK	W	1	7	D	13	13	13	-	S/BS	P	99	-	RR	M/FF	(Martin, et al., 1983)
128		W	2	7	D	9	9	9	-	S/HF	P,A	-	-	RR	C/FF	
129		W	3	7	D	10	10	10	-	S/HF	P	66	-	RR	C/FF	
130		W	4	7	D	10	10	10	-	S/BS	P	66	-	RR	C/FF	
131	Cernobbio, Italy	H	1	8	H	-	38	26	840	S/M	S	131	-	-	C,M/FF	(Barisone, et al., 1983)
132	Chamera, India	W	1	1	H	-	-	-	-	M/HF	P,F, A	181	IC	-	C/-	(Martin, 1987)
#	NAME, LOCATION	TYPE	#	AGE	SHP	DIA	WID	HT	CS	ROCK	DIF	LTH	FAIL	SUPPORT	DRJ/SEC	REFERENCE

Table A4-1. Portal Case History Database (continued).

#	NAME, LOCATION	TYPE	#	AGE	SHP	DIA	WID	HT	CS	ROCK	DIF	LTH	FAIL	SUPPORT	DRI/SEC	REFERENCE
133	Chauderon, France	H	1	15	H	-	-	-	861	S/HF	P,S, F	-	ORS	RR	C/HB	(Betschen, 1973)
134		H	2	15	H	-	-	-	861	S/HF	P,S	-	-	RR	C/HB	
135		H	3	15	H	-	-	-	861	S/HF	P,S	-	-	RR	C/HB	
136		H	4	15	H	-	-	-	861	S/HF	P,S	-	-	RR	C/HB	
137	Chunnel, UK	R	1	14	C	-	-	-	-	S/M	O	-	-	RR	M/FF	(Landslip ..., 1974)
138	Clap Forat, Italy	H	1	5	-	-	-	-	840	S/HF	P,F	66	USS	RR	-/HB	(Barisone, et al., 1983)
139		H	2	5	-	-	-	-	840	S/HF	P	-	-	RR	-/HB	
140		H	3	5	-	-	-	-	840	S/HF	P	-	-	RR	-/HB	
141		H	4	5	-	-	-	-	840	S/HF	P	-	-	RR	-/HB	
142	Cofton, UK	R	1	147	H	-	-	-	-	S/BS	F	-	ORS	RR	C,H/FF	(Legget, 1939)
143	Coal Bank Hollow,	M	1	63	R	-	12	4	48	S/HF	FFA	36	SC	RR	C,H/FF	(Field Investigation)
144	VA, USA *	M	2	63	R	-	12	4	48	S/HF	FFA	36	SC	RR	C,H/FF	
145	Colorado, USA	H	1	-	-	-	48	38	-	-	O	48	-	RR	C/HB	("Colorado...", 1981)
146		H	2	-	-	-	48	38	-	-	O	48	-	RR	C/HB	
147	Criblette, France	H	1	15	H	-	-	-	861	S/W	P,S, F	-	ORS	RR	C/HB	(Betschen, 1973)
148		H	2	15	H	-	-	-	861	S/W	P,S	-	-	RR	C/HB	
149		H	3	15	H	-	-	-	861	S/W	P,S	-	-	RR	C/HB	
150		H	4	15	H	-	-	-	861	S/W	P,S	-	-	RR	C/HB	
#	NAME, LOCATION	TYPE	#	AGE	SHP	DIA	WID	HT	CS	ROCK	DIF	LTH	FAIL	SUPPORT	DRI/SEC	REFERENCE

Table A4-1. Portal Case History Database (continued).

#	NAME, LOCATION	TYPE	#	AGE	SHP	DIA	WID	HT	CS	ROCK	DIF	LTH	FAIL	SUPPORT	DRI/SEC	REFERENCE
151	Crow, WV, USA *	R	1	88	H	-	10	15	-	S/BS	F,A	40	SC,CFO	RR	C,H/FF	(Sbady Spring, 1979;
152		R	2	88	H	-	10	15	-	S/BS	F,A	40	SC	RR	C,H/FF	Rogers, 1980; Field I.)
153	Crozet, VA, USA *	R	1	138	H	-	16	20	-	M/BS	F,A	48	IC	N	C,H/FF	(Watts, 1988; Brinton, 1975)
154	Cunningham, CO, USA	W	1	14	H	10	10	10	-	I/HF	P	33	-	RR,ES	C/FF	(Provost, 1976)
155		W	2	14	H	10	10	10	-	I/HF	P	33	-	RR,ES	C/FF	
156	De Gray, AR, USA	W	1	24	H	-	34	38	-	S/HF	F	60	CFO	RR	C/FF	(Craig & Brockman, 1971;
157		W	2	24	H	-	34	38	-	S/HF	-	-	-	RR	C/FF	Bennett, 1985)
158	Devils Den, WV, USA	O	1	-	O	-	8	8	-	S/BS	N	-	-	N	N/N	(Rogers, 1980)
159	Dinorwic 1, UK	W	1	10	D	-	20	25	-	M/BS	F,A	238	SC	RR,PS	C/HB	(Paterson, et al., 1979)
160	Dinorwic 2, UK	W	1	10	D	-	32	27	-	S/HF	P,A	99	-	RR,PS	C/HB	(Paterson, et al., 1979)
161	Dinorwic 3, UK	W	1	10	H	-	23	25	-	S/M	N	109	-	C/RR	C/HB	(Paterson, et al., 1979)
162	Dinorwic 4, UK	W	1	10	D	-	16	18	-	S/W	N	27	-	C/RR	C/FF	(Paterson, et al., 1979)
163	Dinorwic 5, UK	W	1	10	H	-	23	24	-	M/BS	N	79	-	C/RR	C/FF	(Paterson, et al., 1979)
164	Dinorwic 6, UK	W	1	10	O	-	38	37	-	M/HF	P	157	-	RR/PS	C/HB	(Paterson, et al., 1979)
165	Dinorwic 7, UK	W	1	10	O	-	38	37	-	M/HF	P	141	-	RR/PS	C/HB	(Paterson, et al., 1979)

NAME, LOCATION TYPE # AGE SHP DIA WID HT CS ROCK DIF LTH FAIL SUPPORT DRI/SEC REFERENCE

Table A4-1. Portal Case History Database (continued).

#	NAME, LOCATION	TYPE	#	AGE	SHP	DIA	WID	HT	CS	ROCK	DIF	LTH	FAIL	SUPPORT	DRI/SEC	REFERENCE
166	Dinorwic 8, UK	W	1	10	R	-	32	35	-	M/HF	P	141	-	RR/PS	C/HB	(Paterson, et al., 1979)
167	Dinorwic 9, UK	W	1	10	D	-	17	22	-	M/HF	P	101	-	C/RR	C/FF	(Paterson, et al., 1979)
168	Dinorwic 10, UK	W	1	10	D	-	17	22	-	M/W	P	53	-	C/RR	C/FF	(Paterson, et al., 1979)
169	Dinorwic 11, UK	W	1	10	R	-	33	40	-	M/BS	N	85	-	RR	C/HB	(Paterson, et al., 1979)
170	Dinorwic 12, UK	W	1	10	D	-	17	19	-	M/W	P	83	-	C/RR	C/FF	(Paterson, et al., 1979)
171	Dinorwic 13, UK	W	1	10	D	-	11	14	-	M/W	P	13	-	RR	C/FF	(Paterson, et al., 1979)
172	Dinorwic 14, UK	W	1	10	D	-	15	16	-	M/W	P	30	-	C/RR	C/FF	(Paterson, et al., 1979)
173	Dinorwic 15, UK	W	1	10	D	-	8	10	-	M/W	P	23	-	RR/PS	C/FF	(Paterson, et al., 1979)
174	Dutoitskloof,	H	1	13	H	-	42	39	968	I/W	P	551	-	RR	M/MD	(Jones, 1982;
175	South Africa	H	2	13	H	-	42	39	968	-	N	-	-	RR	M/MD	Buttner, 1987)
176		H	3	13	H	-	42	39	968	I/W	P	551	-	RR	M/MD	
177		H	4	13	H	-	42	39	968	-	N	-	-	RR	M/MD	
178		H	5	13	H	-	-	-	86	I/W	P,F	551	IC	RR	M/FF	
179		H	6	13	H	-	-	-	86	-	N	-	-	RR	M/FF	
180	East River, VA,	H	1	20	H	-	42	38	-	S/BS	N	-	-	C/RR/PS	C/HB	(Gilmer, 1988;
181	USA *	H	2	20	H	-	42	38	-	S/BS	P,F	-	USS	C/RR/PS	C/HB	Russel, 1976;
182		H	3	20	H	-	42	38	-	S/BS	N	-	-	C/RR/PS	C/HB	Compton, 1989)
183		H	4	20	H	-	42	38	-	S/BS	P	-	-	C/RR/PS	C/HB	

NAME, LOCATION TYPE # AGE SHP DIA WID HT CS ROCK DIF LTH FAIL SUPPORT DRI/SEC REFERENCE

Table A4-1. Portal Case History Database (continued).

#	NAME, LOCATION	TYPE	#	AGE	SHP	DIA	WID	HT	CS	ROCK	DIF	LTH	FAIL	SUPPORT	DRI/SEC	REFERENCE
184	Eggleston, VA USA *	R	1	84	H	-	35	26	-	S/BS	P, F	70	CFO, USS	RR, PS	C/HB	(Field Investigation)
185		R	2	84	H	-	35	26	-	S/BS	P, F	70	CFO	RR, PS	C/HB	
186		R	3	108	R	-	16	18	288	S/BS	PA	16	-	N	C, H/FF	
187		R	4	108	R	-	16	18	288	S/BS	PFA	16	IC	N	C, H/FF	
188		R	5	84	H	-	35	26	-	S/BS	P, F	35	CFO, USS	RR, PS	C/HB	
189		R	6	84	H	-	35	26	-	S/BS	P, F	35	CFO, ORS	RR, PS	C/HB	
190		R	7	108	R	-	16	18	288	S/BS	PFA	16	CFO, USS	N	C, H/FF	
191		R	8	108	R	-	16	18	288	S/BS	PFA	160	IC, ORS USS	C	C, H/FF	
192	Eisenhower, CO, USA	H	1	23	H	-	11	12	-	I/BS	N	-	-	RR	C/FF	(Adams, 1978)
193		H	2	23	H	-	11	12	-	I/HF	P	-	-	RR	C/FF	
194		H	3	20	H	-	48	44	-	I/BS	N	-	-	RR, PS	C/HB	
195		H	4	20	H	-	48	44	-	I/HF	P	-	-	RR, PS	C/HB	
196		H	5	13	H	-	48	44	-	I/BS	N	-	-	RR, PS	C/HB	
197		H	6	13	H	-	48	44	-	I/HF	P	-	-	RR, PS	C/HB	
198	Feather Fork, CA, USA *	M	1	63	R	-	9	12	108	I/W	P, F	48	SC, QMS	RR	C/FF	(Rogers, 1983)
199		R	1	93	H	-	20	24	-	I/M	F	20	CFO, USS	RR	C, H/FF	
200		R	2	93	H	-	20	24	-	I/M	F	20	CFO, IF	RR	C, H/FF	
201		R	3	93	H	-	20	24	-	I/M	F	20	CFO, IF	RR	C, H/FF	
202		R	4	93	H	-	20	24	-	I/M	F	20	CFO	RR	C, H/FF	
203		R	5	93	H	-	20	24	-	I/M	F	20	CFO	N	C, H/FF	
204		R	6	93	H	-	20	24	-	I/M	F	20	CFO	N	C, H/FF	
205	R	7	93	H	-	20	24	-	I/M	F	20	CFO	PS	C, H/FF		

NAME, LOCATION TYPE # AGE SHP DIA WID HT CS ROCK DIF LTH FAIL SUPPORT DRI/SEC REFERENCE

Table A4-1. Portal Case History Database (continued).

#	NAME, LOCATION	TYPE	#	AGE	SHP	DIA	WID	HT	CS	ROCK	DIF	LTH	FAIL	SUPPORT	IRI/SEC	REFERENCE
206	Feather River, CA, USA *	R	8	93	H	-	20	24	-	I/M	F	20	CFO	PS	C,H/FF	(Weaver, 1989;
207		R	9	93	H	-	20	24	-	I/M	F	20	CFO	PS	C,H/FF	Field Investigation)
208		R	10	93	H	-	20	24	-	I/M	F	20	CFO	PS	C,H/FF	
209		H	11	58	D	-	24	20	-	I/M	F	24	CFO,USS	C	C/FF	
210		H	12	58	D	-	24	20	-	I/M	F	24	CFO	C	C/FF	
211		H	13	58	D	-	24	20	-	I/M	F	24	CFO	C	C/FF	
212		H	14	58	D	-	24	20	-	I/M	F	24	CFO	C	C/FF	
213	Fishtrap, KY, USA	W	1	24	H	20	20	20	-	S/BS	P,F	-	CFO,ORS	RR	C/FF	(Craig & Brockman, 1971)
214	Flat Top, WV, USA *	M	1	23	R	-	12	4	48	S/BS	F	24	IC	RR	M/FF	(Vest, 1988)
215		M	2	23	R	-	12	4	48	S/BS	N	-	-	RR	M/FF	
216		M	3	23	R	-	12	4	48	S/BS	N	-	-	RR	M/FF	
217	Folkestone Warren, UK	R	1	60	C	12	12	12	-	S/M	F	-	USS,USS	N	M/FF	(Jones, 1984)
218	Fort Pitt, PA, USA	H	1	30	H	-	29	35	-	S/BS	F	-	USS,USS	RR	C/HB	(Ackenbeil, et al., 1987)
219		H	2	30	H	-	29	35	-	S/BS	N	-	-	RR	C/HB	
220	Fort Randall, SD, USA	W	1	38	C	26	26	26	531	S/M	N	-	-	RR	M,C/FF	(Craig & Brockman, 1971;
221		W	2	38	C	26	26	26	531	S/M	N	-	-	RR	M,C/FF	Bennett, 1985; U.S.
222		W	3	38	C	26	26	26	531	S/M	N	-	-	RR	M,C/FF	Army Corps, 1978)
223		W	4	38	C	26	26	26	531	S/M	N	-	-	RR	M,C/FF	
224		W	5	38	C	33	33	33	855	S/M	N	-	-	RR	M,C/FF	
225		W	6	38	C	33	33	33	855	S/M	N	-	-	RR	M,C/FF	
226		W	7	38	C	33	33	33	855	S/M	N	-	-	RR	M,C/FF	
#	NAME, LOCATION	TYPE	#	AGE	SHP	DIA	WID	HT	CS	ROCK	DIF	LTH	FAIL	SUPPORT	IRI/SEC	REFERENCE

Table A4-1. Portal Case History Database (continued).

#	NAME, LOCATION	TYPE	#	AGE	SHP	DIA	WID	HT	CS	ROCK	DIF	LTH	FAIL	SUPPORT	DRI/SEC	REFERENCE
227	Fort Randall, SD,	W	8	38	C	33	33	33	855	S/M	N	-	-	RR	M, C/FF	(Craig & Brockman, 1871;
228	USA	W	9	38	C	33	33	33	855	S/M	N	-	-	RR	M, C/FF	Bennett, 1985; U.S.
229		W	10	38	C	33	33	33	855	S/M	N	-	-	RR	M, C/FF	Army Corps, 1978)
230		W	11	38	C	33	33	33	855	S/M	N	-	-	RR	M, C/FF	
231		W	12	38	C	33	33	33	855	S/M	N	-	-	RR	M, C/FF	
232	Frejus, Italy	H	1	8	C	-	-	-	1022	M/W	P	-	-	RR, ES	-/PFF	(Barisone, et al., 1983)
233	Gascoigne Wood, UK	M	1	7	O	17	17	17	-	S/W	P	-	-	RR, OC	M/FF	(Martin, 1981)
234		M	2	7	O	17	17	17	-	S/W	P	-	-	RR, OC	M/FF	
235	German Creek,	M	1	6	D	-	16	14	-	S/W	P	-	-	RR, OC	M/FF	(Fawcett. et al., 1984)
236	Australia	M	2	6	D	-	16	14	-	S/W	P	-	-	RR, OC	M/FF	
237	Gillham, AK, USA	W	1	22	H	-	25	15	-	S/HF	F	25	CFO	C, RR	C/HHB	(Craig & Brockman, 1971;
238		W	1	24	H	-	18	18	-	S/BS	N	-	-	RR	C/FF	U.S. Army Corps, 1978)
239	Grayson, KY, USA	W	2	24	H	-	18	18	-	S/BS	N	-	-	RR	C/FF	(Craig & Brockman, 1971;
240	Greenville, WV,	O	1	-	O	-	75	4	150	S/M	F	20	CFO	N	N/N	(Hempel, 1975;
241	USA *	O	2	-	O	-	25	25	625	S/M	N	-	-	N	N/N	Field Investigation)
242		O	3	-	O	-	20	5	100	S/M	F	15	CFO	N	N/N	
243		O	4	-	O	-	30	10	150	S/M	F	15	CFO	N	N/N	
244	Hannover/Wurzburg, Germany	R	1	3	H	-	-	-	1560	S/BS	P, F	-	IC, IC	RR, OC	C/HB	(NATM..., 1985)
#	NAME, LOCATION	TYPE	#	AGE	SHP	DIA	WID	HT	CS	ROCK	DIF	LTH	FAIL	SUPPORT	DRI/SEC	REFERENCE

Table A4-1. Portal Case History Database (continued).

#	NAME, LOCATION	TYPE	#	AGE	SFP	DIA	WID	HT	CS	ROCK	DIF	LTH	FAIL	SUPPORT	DRI/SEC	REFERENCE
245	Herdecke, Germany	W	1	2	C	-	-	-	-	S/HF	P	-	-	RR	C,M/-	(Jones, 1986)
246	Holme, England, UK	R	1	50	H	-	20	18	-	S/BS	F	-	OMS	RR	C/HB	(Crawler ..., 1987)
247	Hope Valley, CA, USA	O	1	16	C	13	13	13	-	I/BS	N	20	-	N	M/FF	(Rean ..., 1973)
248	Ipoh, Malaysia	H	1	5	-	-	35	-	-	I/W	P	24	-	RR	C/HB	(James, 1984)
249		H	2	5	-	-	35	-	-	I/W	P	-	-	RR	C/HB	
250	Ironto, VA, USA *	R	1	76	H	-	24	25	-	S/HF	P,F	120	ORS,CFO	RR,PS	C/FF	(Field Investigation)
251		R	2	76	H	-	24	25	-	S/HF	P,F	120	ORS,CFO	RR,PS	C/FF	
252	Isangoyana, South Africa	R	1	3	D	-	36	33	-	S/BS	P	-	-	RR	C/FF	(Doyle, 1986)
253		R	2	3	D	-	36	33	-	S/HF	P	-	-	RR	C/HB	
254	James River, VA, USA	O	1	-	O	-	10	10	-	S/HF	P,F	20	SC,IC	N	N/N	(Rogers, et al., 1987; Olmedo, 1987)
255		O	2	-	O	-	30	30	-	S/HF	P,F	60	SC,IC	N	N/N	
256	Jubilee, UK	M	1	11	D	-	17	12	-	S/HF	P	-	-	RR,OC	C/M/FF	(Northard, et al, 1979)
257	Junk Bay, Hong Kong	H	1	3	H	-	37	37	1184	I/BS	P	-	-	RR,OC	C/HB	(Matson, et al., 1984)
258		H	2	3	H	-	37	37	1184	I/BS	P	-	-	RR	C/HB	
259		H	3	3	H	-	37	37	968	I/BS	P	-	-	RR,OC	C/HB	
260		H	4	3	H	-	37	37	968	I/BS	P	-	-	RR	C/HB	
261	Kaimai, New Zealand	R	1	18	H	-	-	-	-	I/W	P,F	100	IC	RR,OC	C/HB	(Kaimai, 1972; Kaimai, 1976)
#	NAME, LOCATION	TYPE	#	AGE	SFP	DIA	WID	HT	CS	ROCK	DIF	LTH	FAIL	SUPPORT	DRI/SEC	REFERENCE

Table A4-1. Portal Case History Database (continued).

#	NAME, LOCATION	TYPE	#	AGE	SHP	DIA	WID	HT	CS	ROCK	DIF	LTH	FAIL	SUPPORT	DRI/SEC	REFERENCE
262	Kairuan, China	M	1	6	R	-	-	-	-	S/BS	O, F	-	IC	RR	M, H/FF	(Shi-Zhong, 1982)
263	Kan-etsu, Japan	H	1	8	H	-	-	-	-	M/W	P	197	-	RR	C/M	(Fumimoto, 1980)
264		H	2	8	H	-	-	-	-	M/W	P	197	-	RR	C/M	
265	Kentucky, USA	M	1	4	R	-	10	3	-	S/BS	F	30	CFO	RR	C, M/FF	(Mine Safety, 1984)
266	Kerckhoff 2, CA, USA *	W	1	8	D	-	24	22	-	I/BS	F	24	CFO	C, RR	C/ HB	(Harder, 1982; Rogers, 1982; U.S. Hydro, 1983)
267		W	2	8	D	-	24	22	-	I/BS	F	24	CFO	C, RR	C/ HB	
268	Keyhole, WV, USA	W	1	38	H	-	-	-	-	S/BS	P, F	-	CFO	RR	C/ HB	(U.S. Army Corps, 1980)
269	Khodai, India	W	1	22	H	-	-	-	-	-	P, F	-	USS	RR	C/-	(Jayaram, 1981)
270	Kopperston #1, WV, USA *	M	1	25	R	-	12	5	60	S/BS	P, F	24	CFO	RR	C, M/FF	(Sprouls, 1988; Rogers, 1981)
271	La Grange, CA, USA	W	1	1	H	-	18	18	-	M/W	P	-	-	C, CC, RR	C/ FF	(Atlas Powder Co., 1987)
272	Laurel, KY, USA	W	1	22	H	-	21	21	-	S/BS	N	-	-	RR	C/ PFF	(Craig & Brockman, 1971; Bennett, 1985)
273		W	2	22	H	-	26	26	-	S/BS	N	-	-	RR	C/ PFF	
274	Laurel Creek, WV, USA *	O	1	-	O	-	110	30	1650	S/M	N	-	-	N	N/N	(Hempel, 1975; Field Investigation)
275	Laurel Mt., VA, USA *	M	1	1	R	-	16	8	128	S/ HF	P, F	120	CFO	CC, RR	M/ FF	(Decker, 1988; Field Investigation)
276		M	2	1	R	-	22	8	176	S/ HF	P, F	150	CFO	CC, RR	M/ FF	

NAME, LOCATION TYPE # AGE SHP DIA WID HT CS ROCK DIF LTH FAIL SUPPORT DRI/SEC REFERENCE

Table A4-1. Portal Case History Database (continued).

#	NAME, LOCATION	TYPE	#	AGE	SHP	DIA	WID	HT	CS	ROCK	DIF	LTH	FAIL	SUPPORT	DRI/SEC	REFERENCE
277	Laurel Mt., VA, USA *	M	3	1	R	-	20	5	100	S/HF	FFA	40	CFO	RR	C,H/FF	(Decker, 1988;
278		M	4	1	R	-	15	5	75	S/HF	FFA	30	CFO	RR	C,H/FF	Field Investigation)
279	Lawson Adit, CA, USA *	O	1	72	O	-	6	7	-	M/HF	P,F	24	IC, IF	RR, ES	C,H/FF	(Rogers, 1982)
280	Lightfoot #1, WV, USA *	M	1	7	R	-	12	6	72	S/BS	N	-	-	RR, PS	C,M/FF	(Sprouls, 1988; Rogers, 1981)
281	Loch Treig/Limbe, Scotland, UK	W	1	49	H	15	-	-	-	M/W	P,F	-	IC	RR	C,H/FF	(Legget, 1939)
282	Lompoc, CA, USA *	M	1	38	O	-	13	7	-	S/BS	F	13	CFO	N	C/FF	(Field Investigation)
283	Low Moor, VA, USA	M	1	118	R	-	13	12	156	S/BS	F,A	13	CFO	N	C/FF	(McCoy, 1987; Watson,
284	USA *	M	2	28	R	-	55	30	1650	S/M	F,A	55	CFO, SC	N	C/HB	1907; Hungerford, 1888;
285		M	3	28	R	-	65	40	2600	S/M	F,A	65	CFO, SC	N	C/HB	Gooch, 1954; Field
286		M	4	28	R	-	50	40	2000	S/M	F,A	50	CFO, SC	N	C/HB	Investigation; Rogers,
287		M	5	28	R	-	120	40	4800	S/M	F,A	-	SC, SC	N	C/HB	1980)
288		M	6	28	R	-	60	50	3000	S/M	F,A	60	CFO, SC	N	C/HB	
289		M	7	28	R	-	60	50	3000	S/M	F,A	60	CFO, SC	N	C/HB	
290		M	8	28	R	-	60	50	3000	S/M	F,A	60	CFO, SC	N	C/HB	
291		M	9	28	R	-	60	50	3000	S/M	F,A	60	CFO, SC	N	C/HB	
292		M	10	118	R	-	20	25	500	S/BS	F,A	20	CFO	N	C/HB	
293		M	11	118	R	-	20	25	500	S/BS	F,A	20	CFO	N	C/HB	
294		M	12	28	R	-	30	30	900	S/M	F,A	30	CFO, SC	N	C/HB	

NAME, LOCATION TYPE # AGE SHP DIA WID HT CS ROCK DIF LTH FAIL SUPPORT DRI/SEC REFERENCE

Table A4-1. Portal Case History Database (continued).

#	NAME, LOCATION	TYPE	#	AGE	SHP	DIA	WID	HT	CS	ROCK	DIF	LTH	FAIL	SUPPORT	DRI/SEC	REFERENCE
295	Lower Pieman,	W	1	6	H	25	25	25	-	M/W	P	30	-	RR	C/HB	(Varty, 1984)
296	Tasmania,	W	2	6	H	25	25	25	-	M/W	P	30	-	RR	C/HB	
297	Australia	W	3	6	H	25	25	25	-	M/W	P	30	-	RR	C/HB	
298		W	4	6	H	25	25	25	-	M/W	P	30	-	RR	C/HB	
299	Milletts, VA,	R	1	79	H	-	22	26	-	S/HF	P,F	330	ORS,ORS	RR,PS	C/HB	(Rogers, 1987)
300	USA *	R	2	76	H	-	22	26	-	S/HF	P,F	155	SC ORS,SC	RR,PS	C/HB	
301	Mojave Forks, CA,	W	1	20	H	-	-	-	-	I/BS	-	-	-	RR	C/-	(Craig & Brockman, 1971)
302	USA	W	2	20	H	-	-	-	-	I/BS	-	-	-	RR	C/-	
303	Monongah, WV, USA	M	1	88	R	-	13	9	117	S/BS	N	-	-	RR	C,H/FF	(Dillon, 1976)
304		M	2	88	R	-	13	9	117	S/W	P,F	39	SC	RR	C,H/FF	
305		M	3	88	R	-	13	9	117	S/W	P,F	39	SC	RR	C,H/FF	
306		M	4	88	R	-	13	9	117	S/W	P,F	39	SC	RR	C,H/FF	
307	Montgomery, WV, USA*	M	1	68	R	-	-	-	-	S/BS	F,A	-	SR	RR	C,H/FF	(Rogers, 1980)
308	Mt. Lebaron, PA,	R	1	4	H	-	18	19	-	S/W	P,F	98	IF	RR	C/HB	(Daly, et al., 1986)
309	USA	R	2	4	H	-	18	19	-	S/W	P,F	98	IF	RR	C/HB	
310		R	3	4	H	-	18	19	-	S/W	P,F	-	IF	RR	C/HB	
311		R	4	4	H	-	18	19	-	S/W	P,F	-	IF	RR	C/HB	
312	Mt. McDonald, BC,	R	1	6	H	-	19	29	-	M/HF	P	-	-	RR,OC	C/HB	(Daly, et al., 1986;
313	Canada	R	2	6	H	-	19	29	-	M/HF	P	-	-	RR,OC	C/HB	Martin, 1985)
#	NAME, LOCATION	TYPE	#	AGE	SHP	DIA	WID	HT	CS	ROCK	DIF	LTH	FAIL	SUPPORT	DRI/SEC	REFERENCE

Table A4-1. Portal Case History Database (continued).

#	NAME, LOCATION	TYPE	#	AGE	SHP	DIA	WID	HT	CS	ROCK	DIF	LTH	FAIL	SUPPORT	DRI/SEC	REFERENCE
314	Mt. Shaughnessy,	R	1	3	H	-	17	26	-	M/HF	P,S	-	-	C,RR	C/HB	(Work Begins, 1985)
315	BC, Canada	R	2	3	H	-	17	26	-	M/HF	P	-	-	C,RR	C/HB	
316	Mt. Washington, PA, USA	R	1	80	H	-	-	-	-	S/BS	P,F	100	USS	RR,ES	C/-	(Voytko, et al., 1987)
317	New Jingpolu, China	W	1	14	H	26	26	26	-	S/W	P	131	-	RR	C/HB	(Shi-Zhong, 1982)
318	New Moelwyn, UK	R	1	13	H	-	12	13	-	I/HF	P,F	49	CFO	RR	C/PFF	(Marchant, 1977)
319		R	2	13	H	-	12	13	-	I/HF	P,F	33	CFO	RR	C/PFF	
320	New Zealand, New Zealand	R	1	110	H	-	-	-	-	S/HF	P,F	246	ONS	RR	C/HB	(Zaruba, et al., 1969)
321	Nkula Falls, Malawi	W	1	8	H	-	-	-	-	M/M	N	-	-	N	C/FF	(Legge, et al., 1981)
322	Oabe, SD, USA	W	14	34	C	29	-	-	-	S/HF	N	-	-	RR,OC	C,M/FF	(Craig & Brockman, 1971;
336		W	5	34	C	9	-	-	-	S/HF	N	-	-	RR,OC	C,M/FF	U.S. 1978)
341	Oceana, WV, USA *	M	1	9	R	-	16	4	64	S/BS	F	20	IF	RR,C	C/FF	(Rogers, 1980)
342		M	2	9	R	-	16	4	64	S/BS	F	20	IF	RR,C	C/FF	
343		M	3	9	R	-	16	4	64	S/BS	F	20	IF	RR,C	C/FF	
344	Oceana B, WV, USA	M	1	-	R	-	16	6	96	S/BS	F,A	32	SC,SR	RR	C,H/FF	(Seijo, 1988)
345		M	2	-	R	-	16	6	96	S/BS	F,A	32	SC	RR	C,H/FF	
346		M	3	-	R	-	16	6	96	S/BS	F,A	32	SC	RR	C,H/FF	
#	NAME, LOCATION	TYPE	#	AGE	SHP	DIA	WID	HT	CS	ROCK	DIF	LTH	FAIL	SUPPORT	DRI/SEC	REFERENCE

Table A4-1. Portal Case History Database (continued).

#	NAME, LOCATION	TYPE	#	AGE	SHP	DIA	WID	HT	CS	ROCK	DIF	LTH	FAIL	SUPPORT	DRI/SEC	REFERENCE
347	Old Big Bend, WV, USA	R	1	113	H	-	15	22	-	S/BS	F	15	IC, CFO	RR	C/FF	(Railway Age, 1937)
348		R	2	113	H	-	15	22	-	S/BS	F	15	CFO	RR	C/FF	
349	Old Hongarvik, Norway	H	1	63	H	-	-	-	-	M/M	F	-	OMS	N	C/FF	(Martin, 1983)
350		H	2	63	H	-	-	-	-	M/M	F	-	OMS	N	C/FF	
351	Onion Valley, CA, USA *	M	1	68	O	-	6	7	-	M/HF	F,A	75	SC	RR	C/FF	(Field Investigation)
352	Oswaldiberg, Austria	H	1	1	H	-	-	-	753	-/W	P	-	-	RR	C/HB	(Muller, 1987)
353		H	2	1	H	-	-	-	753	-/W	P	-	-	RR	C/HB	
354	Paillon, France	H	1	6	D	47	-	-	-	S/HF	P	82	-	RR	C,M/HB	(McCormack, 1984)
355		H	2	6	D	47	-	-	-	S/BS	N	-	-	RR	C,M/HB	
356	Pembroke, VA, USA *	R	1	82	H	-	35	24	-	S/BS	F	105	USS, IC	RR,PS	C/HB	(Field Investigation)
357		R	2	82	H	-	35	24	-	S/BS	F	35	CFO, ORS	RR,PS	C/HB	
358	Phillipbes, Phillipbes	W	1	4	-	-	-	-	-	-/-	P	-	-	RR	-/-	("Shotcrete...", 1985)
359		W	2	4	-	-	-	-	-	-/-	P	-	-	RR	-/-	
360	Pietratagliata, Italy	H	1	5	-	-	37	-	839	S/BS	P	105	-	RR	C/HB	(Barisone, et al., 1983)
361		H	2	5	-	-	37	-	839	S/BS	P	105	-	RR	C/HB	
362	Pilots Peak, CA, USA *	M	1	68	R	-	6	4	24	M/HF	PFA	12	SC, CFO	N	C,H/FF	(Field Investigation)

NAME, LOCATION TYPE # AGE SHP DIA WID HT CS ROCK DIF LTH FAIL SUPPORT DRI/SEC REFERENCE

Table A4-1. Portal Case History Database (continued).

#	NAME, LOCATION	TYPE	#	AGE	SHP	DIA	WID	HT	CS	ROCK	DIF	LTH	FAIL	SUPPORT	DRI/SEC	REFERENCE
363	Plabutsch, Austria	H	1	4	D	-	36	36	1076	-/HF	P	-	-	RR	C,M/HB	(Martin, 1984)
364	Point of Ayr, Wales, UK	M	1	4	C	16	-	-	-	S/HF	P	56	-	RR	M,H/FF	(Wallis, 1988)
365	Pomme de Terre,	W	1	29	C	16	16	16	-	S/BS	-	-	-	RR	C/FFF	(Craig & Brockman, 1971;
366	USA	W	2	29	R	-	30	24	720	S/BS	-	-	-	RR	C/FF	U.S. Army Corps, 1978)
367	Pontebba, Italy	H	1	5	-	-	-	-	839	S/BS	P	-	-	RR	-/FF	(Barisone, et al., 1983)
368		H	2	5	-	-	-	-	839	S/BS	P	-	-	RR	-/FF	
369	Pontesei, Italy	H	1	28	-	-	-	20	-	S/BS	P,F	328	OMS	RR	-/-	(Zaruba, et al., 1969)
370	Poro-o-tarao, New Zealand	R	1	9	H	-	-	-	-	-/-	P	-	-	-	-/-	(Slopes ..., 1979)
371	Poverty Creek,	M	1	78	R	-	10	3	30	S/BS	F,A	15	SC, CFO	RR	C,H/FF	(Field Investigation)
372	Virginia, USA *	M	2	78	R	-	10	3	30	S/BS	F,A	15	SC, CFO	RR	C,H/FF	
373		M	3	78	R	-	10	3	30	S/BS	F,A	15	SC	RR	C,H/FF	
374		M	4	78	R	-	10	3	30	S/BS	F,A	15	SC	RR	C,H/FF	
375	Quinamont, WV, USA	R	1	46	H	-	20	25	-	S/BS	P,F	20	CFO	RR	C,H/HB	(Vecellio, 1989)
376		R	2	46	H	-	20	25	-	S/BS	P	20	-	RR	C,H/HB	
377	Raccoon, TN, USA	W	1	18	H	-	30	24	-	S/BS	N	-	-	RR	C/HB	(Kimmons, 1972)
378		W	2	18	H	-	15	21	-	S/BS	N	-	-	RR	C/HB	

NAME, LOCATION TYPE # AGE SHP DIA WID HT CS ROCK DIF LTH FAIL SUPPORT DRI/SEC REFERENCE

Table A4-1. Portal Case History Database (continued).

#	NAME, LOCATION	TYPE	#	AGE	SHP	DIA	WID	HT	CS	ROCK	DIF	LTH	FAIL	SUPPORT	DRI/SEC	REFERENCE
379	Raccoon, TN, USA	W	3	18	C	18	18	18	255	S/BS	F	35	CFO	RR	C/HB	(Kimmons, 1972)
380		W	4	18	C	18	18	18	255	S/BS	N	-	-	RR	C/HB	
381	Rengerhausen,	R	1	2	H	-	-	-	1571	S/HF	P,F	213	SC	RR,OC	C,M/M	(Wallis, 1987)
382	Germany	R	2	2	H	-	-	-	1571	S/HF	P	-	-	RR	C/HB	
383	Rich Patch,	M	1	118	R	-	10	8	-	S/HF	PFA	100	SC	RR	C,H/FF	(McCoy, 1987; Watson,
384	Virginia,	M	2	118	R	-	10	8	-	S/HF	PFA	100	SC	RR	C,H/FF	1907; Hotchkiss, 1880;
385	USA *	M	3	118	R	-	10	8	-	S/HF	PFA	100	SC	RR	C,H/FF	Hungerford, 1888;
386		M	4	118	R	-	10	8	-	S/HF	PFA	100	SC	RR	C,H/FF	Gooch, 1954; Field
387		M	5	118	R	-	10	8	-	S/HF	PFA	100	SC	RR	C,H/FF	Investigation)
388		M	6	118	R	-	10	8	-	S/HF	PFA	100	SC	RR	C,H/FF	
389		M	7	118	R	-	10	8	-	S/HF	PFA	100	SC	RR	C,H/FF	
390		M	8	118	R	-	10	8	-	S/HF	PFA	100	SC	RR	C,H/FF	
391		M	9	118	R	-	10	8	-	S/HF	PFA	100	SC	RR	C,H/FF	
392		M	10	118	R	-	10	8	-	S/HF	PFA	100	SC	RR	C,H/FF	
393		M	11	118	R	-	10	8	-	S/HF	PFA	100	SC	RR	C,H/FF	
394	Roichthoftunnel,	R	1	2	H	-	-	-	-	-/-	P	-	-	RR	C,M/-	(Jones, 1986)
	Germany															
395	Rosti, France	H	1	6	D	46	46	46	1662	S/HF	FFS	46	IC	RR,OC	M/HB	(McCormack, 1984)
396		H	2	6	D	46	46	46	1662	S/HF	FFS	164	USS	RR	M/HB	
397	Saltash, England,	H	1	2	H	-	45	31	1291	S/W	P	-	-	RR	M/HB	(Wallis, 1987)
398	UK	H	2	2	H	-	45	31	1291	S/W	P,F	82	IC	RR	M/HB	

NAME, LOCATION TYPE # AGE SHP DIA WID HT CS ROCK DIF LTH FAIL SUPPORT DRI/SEC REFERENCE

Table A4-1. Portal Case History Database (continued).

#	NAME, LOCATION	TYPE	#	AGE	SHP	DIA	WID	HT	CS	ROCK	DIF	LTH	FAIL	SUPPORT	DRI/SEC	REFERENCE
399	Santa Clara, CA,	W	1	7	C	13	13	13	138	S/HF	P,F	13	CFO	RR	M/FF	(Wallis, 1983;
400	USA *	W	2	7	C	13	13	13	138	S/HF	P,F	52	SC	RR	M/FF	Field Investigation)
401	Scotland, Scotland	R	1	6	H	-	-	-	-	-/-	F	-	IF	RR	-/-	(Jet Grouting, 1982)
402	Serre la Voute 1,	H	1	6	-	-	40	-	840	M/HF	P,S	525	-	RR	-/HB	(Barisone, et al., 1983)
403	Italy	H	2	6	-	-	40	-	840	M/HF	P,S	525	-	RR	-/HB	
404	Serre la Voute 2	R	1	5	H	-	-	-	484	M/HF	P	131	-	CC/RR	-/HB	(Barisone, et al., 1983)
405	Sengs,	H	1	4	D	-	-	-	742	S/HF	P,F	-	IC	RR	C/FF	(Schmid, 1986)
406	Switzerland	H	2	4	D	-	-	-	742	S/HF	P	-	-	RR	C/FF	
407	Sissonville, WV,	M	48	63	R	-	5	4	20	S/HF	P,F, A	24	CFO(7) SC(41)	RR	C,H/FF	(Seijo, 1988)
454	USA															
455	Sodbury, England,	M	1	12	H	-	24	28	-	S/BS	S	-	-	RR	C/HHB	(Pollard, 1977)
456	UK	M	2	12	H	-	24	28	-	S/HF	P,S	-	-	RR	C/HHB	
457	Sophia, WV, USA *	R	1	48	H	-	20	24	-	S/HF	P,F	60	CFO, CFS	RR	C,H/HB	(Rogers, 1980; Field
458		R	2	48	H	-	20	24	-	S/HF	P,F	60	CFO, CFS	RR	C,H/HB	Investigation)
459	Spallanzani, Italy	H	1	5	-	-	33	-	646	S/W	P,F	59	SC, SC	RR	C/HB	(Barisone, et al., 1983)
460	Tai Koo, Hong Kong	R	1	13	H	-	-	-	-	I/W	P,S	-	-	RR	C/HB	(Thoms, et al., 1986)
#	NAME, LOCATION	TYPE	#	AGE	SHP	DIA	WID	HT	CS	ROCK	DIF	LTH	FAIL	SUPPORT	DRI/SEC	REFERENCE

Table A4-1. Portal Case History Database (continued).

#	NAME, LOCATION	TYPE	#	AGE	SHP	DIA	WID	HT	CS	ROCK	DIF	LTH	FAIL	SUPPORT	DRI/SEC	REFERENCE
461	Tapland, WV, USA	M	1	15	R	-	16	5	80	S/BS	F, O	32	SC	RR	M/FF	(Cook, 1988)
462	Tenkiller Ferry,	W	1	38	H	-	38	32	-	S/BS	P, F	38	CFO	RR	C/HB	(Craig & Brockman, 1971)
463	OK, USA	W	2	38	H	-	38	32	-	S/BS	P, F	38	CFO	RR	C/HB	
464	Thistle, UT, USA	W	1	4	H	-	21	21	-	S/BS	F	21	USS	RR	C/FF	(Byce, 1984; Shannon & Wilson, 1985)
465	Trans-Koolau, HA,	H	1	-	H	-	13	13	-	I/HF	P	-	-	RR	C/FF	(Parsons Brinckerhoff-
466	USA	H	2	-	H	-	13	13	-	I/HF	P	-	-	RR	C/FF	Hirota, 1988; Hansmire,
467		H	3	-	H	-	48	38	-	I/HF	P	-	-	RR, PS	C/PHB	1988)
468		H	4	-	H	-	48	38	-	I/HF	P	-	-	RR, PS	C/PHB	
469		H	5	-	H	-	48	38	-	I/HF	P	-	-	RR, PS	C/PHB	
470		H	6	-	H	-	48	38	-	I/HF	P	-	-	RR, PS	C/PHB	
471	Unterstein,	R	1	113	H	-	-	-	-	M/BS	F, A	-	OMS	RR	C, H/HB	(Zaruba, et al., 1969)
472	Austria	R	2	113	H	-	-	-	-	M/BS	F, A	-	OMS	RR	C, H/HB	
473	Vallavik, Norway	H	1	8	D	-	30	-	968	M/M	O	49	-	RR, PS	C/FF	(Martin, 1983)
474		H	2	8	D	-	30	-	968	M/M	O	49	-	RR, PS	C/FF	
475	Virginia Lime,	M	1	38	H	-	18	18	-	S/BS	P, F	500	IC (4)	RR	C/FF	(Kennedy, 1988;
476	VA, USA	M	2	48	H	-	15	15	-	S/BS	P, F	-	IC	RR	C/FF	Field Investigation)
477		M	3	22	H	-	30	22	-	S/M	F	-	IC	RR, PS	C/HB	
478	Wookey Hole, UK	O	1	14	H	-	-	-	-	S/BS	O	20	-	RR	N/N	(Gosselin, 1974)
#	NAME, LOCATION	TYPE	#	AGE	SHP	DIA	WID	HT	CS	ROCK	DIF	LTH	FAIL	SUPPORT	DRI/SEC	REFERENCE

Table A4-1. Portal Case History Database (continued).

#	NAME, LOCATION	TYPE	#	AGE	SHP	DIA	WID	HT	CS	ROCK	DIF	LTH	FAIL	SUPPORT	DRJ/SEC	REFERENCE
479	Wentz B, VA, USA	M	1	4	R	-	15	8	120	S/BS	N	-	-	C,RR	M/FF	(Milan, 1984)
480	Westtangente, West Germany	H	1	5	C	-	-	-	-	S/HF	PFS	30	IC (3)	RR	M/FF	(Steinheuser, 1983)
481		H	2	5	H	-	40	31	1076	S/HF	P,S	-	-	RR	C/HB	
482	Whitby, WV, USA *	M	1	13	R	-	22	3	66	S/BS	N	-	-	RR	M/FF	(Rogers, 1980;
483		M	2	13	R	-	22	3	66	S/BS	N	-	-	RR	M/FF	Vest, 1988)
484		M	3	13	R	-	22	3	66	S/BS	N	-	-	RR	M/FF	
485		M	4	13	R	-	22	3	66	S/BS	N	-	-	RR	M/FF	
486		M	5	13	R	-	22	11	242	S/BS	F	22	CFO	C,RR	M,C/FF	
487		M	6	13	R	-	22	11	242	S/BS	F	22	CFO	RR,PS	M,C/FF	
488		M	7	13	R	-	16	3	48	S/HF	F	16	CFO	C,RR	M/FF	
489		M	8	13	R	-	16	3	48	S/HF	F	-	USS	RR,PS	M/FF	
490		M	9	13	R	-	16	3	48	S/HF	F	16	CFO	C,RR	M/FF	
491		M	10	13	R	-	16	3	48	S/HF	N	-	-	C,RR	M/FF	
492	Wilson, KS, USA	W	1	26	C	16	16	16	201	S/W	P	-	-	RR,PS	C/FF	(Craig & Brockman, 1971; U.S. Army Corps, 1978)
493	Wyoming, WV, USA	M	1	-	R	-	-	-	-	S/BS	F,A	-	SR	RR	-/-	(White, 1988)
494	Wyoming, WV, USA	H	1	28	D	-	8	8	-	M/BS	N	-	-	RR	C/FF	(Sherman, 1963)
495		H	2	28	D	-	8	8	-	M/BS	N	-	-	RR	C/FF	
496		H	3	28	D	-	32	22	-	M/BS	P	16	-	RR,PS	C/HB	
497		H	4	28	D	-	32	22	-	M/BS	P	16	-	RR,PS	C/HB	
498		H	5	28	D	-	32	22	-	M/HF	P	16	-	RR,PS	C/HB	
#	NAME, LOCATION	TYPE	#	AGE	SHP	DIA	WID	HT	CS	ROCK	DIF	LTH	FAIL	SUPPORT	DRJ/SEC	REFERENCE

Table A4-1. Portal Case History Database (continued).

#	NAME, LOCATION	TYPE	#	AGE	SHP	DIA	WID	HT	CS	ROCK	DIF	LTH	FAIL	SUPPORT	DRI/SEC	REFERENCE
499	Yellow Sulfur, VA,	R	1	76	H	-	23	26		S/HF	P, F	46	CFO, QRS	RR, PS	C, H/HB	(Field Investigation)
500	USA *	R	2	76	H	-	23	26		S/BS	N	-	-	RR, PS	C, H/HB	
#	NAME, LOCATION	TYPE	#	AGE	SHP	DIA	WID	HT	CS	ROCK	DIF	LTH	FAIL	SUPPORT	DRI/SEC	REFERENCE

APPENDIX 4: SARMA/HOEK CODE LISTING

```

10 ' SARMA - NON-VERTICAL SLICE METHOD OF SLOPE STABILITY
ANALYSIS
20 ' Version 2.0: Written by Dr. E. Hoek, Golder Associates, April 1986
30 ' Reference: Sarma, S.K. (1979), Stability Analysis of Embankments
40 '           and Slopes, J. Geotech. Engg. Div., ASCE., Vol. 105,
50 '           No. GT12, pages 1511-1524.
60 ' [3/88 - G.K. Rogers - MINING DEPT., VIRGINIA TECH, BLACKSBURG,
VA]
70 ' Dimensioning of variables
80 '
90 CLEAR:STATUS="i":RAD=3.141593/180:F=1:M=1:D$="b:"
100 DIM A(39,50),WW(50),ACC(10),ACL(100),PB(50),PS(50),PHALP(50)
110 DIM ZW(50),FL(100),THETA(50),TV(50),TH(50),ZWT(50),SLOPE(50)
120 '
130 ' DEFINITION OF FUNCTION KEYS
140 '
150 KEY OFF:FOR I = 1 TO 8:KEY I,"":NEXT I:KEY 1,"a":KEY 2,"b"
160 KEY 3,"c":KEY 4,"d":KEY 5,"e":KEY 6,"f":KEY 7,"g":KEY 8,"h"
170 '
180 ' DISPLAY OF FIRST PAGE
190 '
200 SCREEN 0,0:WIDTH 80:CLS:LOCATE 5,17:COLOR 0,7:
210 PRINT "SARMA NON-VERTICAL SLICE STABILITY ANALYSIS"
220 COLOR 7,0:LOCATE 7,12
230 PRINT "COPYRIGHT - EVERT HOEK, 1985. This program is one of"
240 LOCATE 8,12
250 PRINT "a series of geotechnical programs developed as working"
260 LOCATE 9,12
270 PRINT "tools and for educational purposes. Use of the program"
280 LOCATE 10,12
290 PRINT "is not restricted, but the user is responsible for the"
300 LOCATE 11,12
310 PRINT "application of the results obtained from this program."
320 LOCATE 14,16:PRINT "Note: In order to operate this program, a data"
330 LOCATE 15,16:PRINT "disk with at least one file with an extension"
340 LOCATE 16,16:PRINT ".SAR is required. When starting a new disk,"
350 LOCATE 17,16:PRINT "ensure that such a file is stored on the disk"
360 LOCATE 18,16:PRINT "before it is used."
365 LOCATE 19,16:PRINT "G.K. ROGERS, 3/88, VIRGINIA TECH MINING
DEPT."
370 LOCATE 21,12
380 PRINT "Specify drive to be used for the data disk (default B:) "
390 LOCATE 21,65:INPUT " ",D$:IF LEN(D$)=0 THEN D$="b:"
400 IF RIGHT$(D$,1)="-:" THEN D$=D$ ELSE D$=D$+":"
410 '
420 ' DISPLAY OF SECOND PAGE
430 '
440 CLS:LOCATE 25,12:PRINT "to terminate input enter [q]";
450 LOCATE 25,41:PRINT "in response to any question":LOCATE 10,12
460 INPUT "Do you wish to read data from a disk file (y/n) ? : ",DISK$
470 IF LEFT$(DISK$,1)="q" OR LEFT$(DISK$,1)="Q" THEN 6990
480 IF LEN(DISK$)=0 THEN 450
490 IF LEFT$(DISK$,1)="Y" OR LEFT$(DISK$,1)="y" THEN 680
500 LOCATE 11,12

```

```

510 INPUT "Number of slices to be included in analysis :      ",NUM$
520 IF LEFT$(NUM$,1)="q" OR LEFT$(NUM$,1)="Q" THEN 6990
530 IF LEN(NUM$)=0 THEN 500 ELSE NUM=VAL(NUM$)
540 FLAG2=0:LOCATE 12,12
550 INPUT "Unit weight of water =                                ",WATER$
560 IF LEFT$(WATER$,1)="q" OR LEFT$(WATER$,1)="Q" THEN 6990
570 IF LEN(WATER$)= 0 THEN 540 ELSE WATER =VAL(WATER$)
580 IF WATER = 0 THEN FLAG2=1
590 FLAG3=0:LOCATE 13,12
600 INPUT "Are shear strengths uniform throughout the slope (y/n) ?
",STRENGTH$
610 IF LEFT$(STRENGTH$,1)="q" OR LEFT$(STRENGTH$,1)="Q" THEN 6990
620 IF LEN(STRENGTH$)=0 THEN 590
630 IF LEFT$(STRENGTH$,1)="Y" OR LEFT$(STRENGTH$,1)="y" THEN FLAG3=1
640 N=NUM+1:FLAG6=0:GOTO 1860
650 '
660 ' DATA ENTRY FROM A DISK FILE
670 '
680 CLS:LOCATE 3,1
690 PRINT STRING$(80,45):PRINT:PRINT "Sarma files on data disk :";
700 PRINT:FILES D$+"*.SAR":PRINT:PRINT STRING$(80,45):PRINT
710 INPUT "Enter filename (without extension): ",FILES$
720 OPEN D$+FILES$+".SAR" FOR INPUT AS #1
730 LINE INPUT#1, TITLES$:INPUT#1,N
740 INPUT#1,WATER:RAD=3.141593/180:F=1:M=1:NUM=N-1
750 INPUT#1,FLAG2:INPUT#1,FLAG3:INPUT#1,FLAG4
760 FOR K = 1 TO N:FOR J=1 TO 39:INPUT#1,A(J,K):NEXT J:NEXT K
770 CLOSE #1:FLAG6=1:STATUS="e":FLAG50=1:CLS:GOTO 1860
780 '
790 'DISPLAY OF DATA ARRAY
800 '
810 CLS:LOCATE 1,1:PRINT "Analysis no. ";TITLES$
820 LOCATE 3,1:COLOR 15,0:PRINT "Side number":COLOR 7,0
830 LOCATE 4,1:PRINT "coordinate xt":LOCATE 5,1:PRINT "coordinate yt"
840 LOCATE 6,1:PRINT "coordinate xw":LOCATE 7,1:PRINT "coordinate yw"
850 LOCATE 8,1:PRINT "coordinate xb":LOCATE 9,1:PRINT "coordinate yb"
860 LOCATE 10,1:PRINT "friction angle":LOCATE 11,1:PRINT "cohesion"
870 LOCATE 12,1:PRINT "unit weight of water = ":LOCATE 12,23:PRINT WATER
880 LOCATE 13,1:COLOR 15,0:PRINT "Slice number":COLOR 7,0
890 LOCATE 14,1:PRINT "rock unit weight":LOCATE 15,1:PRINT "friction angle"
900 LOCATE 16,1:PRINT "cohesion":LOCATE 17,1:PRINT "force T"
910 LOCATE 18,1:PRINT "angle theta":GOSUB 960
920 IF STATUS="i" THEN GOSUB 1060:RETURN ELSE RETURN
930 '
940 ' SUBROUTINE FOR SLICE NUMBER DISPLAY
950 '
960 COLOR 15,0:LOCATE 3,22:PRINT M:LOCATE 13,27:PRINT M
970 LOCATE 3,32:PRINT M+1:COLOR 7,0:IF N=M+1 THEN RETURN
980 COLOR 15,0:LOCATE 13,37:PRINT M+1:LOCATE 3,42
990 PRINT M+2:COLOR 7,0:IF N=M+2 THEN RETURN
1000 COLOR 15,0:LOCATE 13,47:PRINT M+2:LOCATE 3,52
1010 PRINT M+3:COLOR 7,0:IF N=M+3 THEN RETURN
1020 COLOR 15,0:LOCATE 13,57:PRINT M+3:LOCATE 3,62
1030 PRINT M+4:COLOR 7,0:IF N=M+4 THEN RETURN

```

```

1040 COLOR 15,0:LOCATE 13,67:PRINT M+4:LOCATE 3,72
1050 PRINT M+5:COLOR 7,0:RETURN
1060 LOCATE 20,13
1070 PRINT "Note: coordinates must increase from slope toe to crest"
1080 LOCATE 22,13
1090 PRINT "To edit title or data array, use direction keys to move"
1100 LOCATE 23,13
1110 PRINT "highlighted window. Factor of safety calculation will"
1120 LOCATE 24,13
1130 PRINT "commence automatically when all data has been entered.";
1140 RETURN
1150 '
1160 ' ENTRY AND DISPLAY OF TITLE
1170 '
1180 IF FLAG6=1 OR STATUS="e" THEN 1220
1190 LOCATE 1,1:COLOR 0,7:PRINT "Analysis no.":COLOR 7,0
1200 LOCATE 1,14:LINE INPUT "",TITLES
1210 IF LEN(TITLES)=0 THEN TITLES=PREVT$
1220 LOCATE 1,1:PRINT "Analysis no. "
1230 IF STATUS="r" THEN LOCATE 1,14:PRINT STRING$(66," ")
1240 LOCATE 1,14:PRINT TITLES:PREVT$=TITLES:RETURN
1250 '
1260 ' SUBROUTINE FOR ENTRY OF DATA INTO ARRAY a(j,k)
1270 '
1280 IF STATUS="i" THEN FLAG6=0
1290 IF FLAG20=1 THEN FLAG6=1:FLAG20=0
1300 IF FLAG21=1 THEN K=M:J=PREVJ-1:FLAG21=0
1310 IF FLAG23=1 THEN K=M+4:J=PREVJ-1:FLAG23=0
1320 IF FLAG2=0 THEN 1350
1330 IF J=3 AND FLAG2=1 THEN J=5
1340 IF FLAG2=1 THEN A(3,K)=A(5,K):A(4,K)=A(6,K)
1350 IF J=7 AND K=1 THEN J=10:GOTO 1410
1360 IF FLAG3=0 THEN 1410
1370 IF J=7 THEN A(7,K)=A(11,1):FLAG6=1
1380 IF J=8 THEN A(8,K)=A(12,1):FLAG6=1
1390 IF J=9 AND FLAG12=0 THEN J=10
1400 IF J=10 THEN A(10,K)=A(10,1):FLAG6=1
1410 IF J=9 AND FLAG12=0 THEN J=10
1420 IF K=1 OR FLAG3=0 THEN 1450
1430 IF J=11 THEN A(11,K)=A(11,1):FLAG6=1
1440 IF J=12 THEN A(12,K)=A(12,1):FLAG6=1
1450 IF J=13 THEN J=15
1460 IF J=16 AND A(15,K)=0 THEN J=0:K=K+1:RETURN
1470 IF J=17 THEN J=0:K=K+1:RETURN
1480 IF J<=8 THEN X=18+(10*(K-M)):Y=J+3
1490 IF J>=10 AND J<=12 THEN X=23+(10*(K-M)):Y=J+4
1500 IF J>=15 AND J<=16 THEN X=23+(10*(K-M)):Y=J+2
1510 IF FLAG6=1 THEN GOSUB 1790 ELSE GOSUB 1560
1520 RETURN
1530 '
1540 ' SUBROUTINE FOR CURSOR MOVEMENT AND DISPLAY OF ARRAY
a(j,k)
1550 '
1560 FLAG10=0:FLAG11=0:FLAG12=0:FLAG13=0:FLAG14=0

```

```

1570 IF FLAG50=1 THEN FLAG50=0:F=1:GOTO 2960
1580 GOSUB 1810:Q$=INKEY$:IF Q$=" " THEN 1580
1590 IF LEN(Q$)=2 THEN Q$=RIGHT$(Q$,1)
1600 IF Q$="K" THEN GOSUB 1780:FLAG10=1:RETURN
1610 IF Q$="M" THEN GOSUB 1780:FLAG11=1:RETURN
1620 IF Q$="H" THEN GOSUB 1780:FLAG12=1:RETURN
1630 IF Q$="P" THEN GOSUB 1780:FLAG13=1:RETURN
1640 IF Q$="a" THEN GOSUB 1780:FLAG14=1:RETURN
1650 IF Q$="b" THEN GOSUB 1780:FLAG15=1:RETURN
1660 IF Q$="c" THEN GOSUB 1780:FLAG16=1:RETURN
1670 IF Q$="d" THEN GOSUB 1780:FLAG25=1:RETURN
1680 IF Q$="e" THEN GOSUB 1780:FLAG17=1:RETURN
1690 IF Q$="f" THEN FLAG26=1:RETURN
1700 IF Q$="g" OR Q$="q" THEN FLAG18=1:RETURN
1710 IF Q$="h" THEN FLAG27=1:RETURN
1720 IF Q$="O" THEN 1800
1730 IF Q$="-" THEN 1800
1740 IF Q$="." THEN 1800
1750 IF VAL(Q$)<1 OR VAL(Q$)>9 THEN 1580
1760 LOCATE Y,X:PRINT VAL(Q$)
1770 LOCATE Y,X+2:INPUT "",INS:A(J,K)=VAL(Q$+INS)
1780 LOCATE Y,X:PRINT " "
1790 LOCATE Y,X:PRINT USING "#####.##";A(J,K):RETURN
1800 LOCATE Y,X:PRINT " ";:PRINT Q$:GOTO 1770
1810 LOCATE Y,X:COLOR 0,7
1820 PRINT " " " ":COLOR 7,0:RETURN
1830 '
1840 ' DATA ENTRY AND DISPLAY OF ARRAY a(j,k)
1850 '
1860 F=1:M=1:GOSUB 810:GOSUB 1180
1870 FOR K=1 TO 6:FOR J=1 TO 17
1880 IF FLAG1=1 THEN 2050
1890 IF FLAG23=1 THEN FLAG6=0:GOTO 1910
1900 IF FLAG22=1 THEN FLAG6=1:GOTO 2050
1910 IF FLAG10=1 THEN GOSUB 2420
1920 IF FLAG11=1 THEN GOSUB 2530
1930 IF FLAG12=1 THEN GOSUB 2640
1940 IF FLAG13=1 THEN GOSUB 2760
1950 IF FLAG14=1 THEN GOSUB 5580
1960 IF FLAG15=1 THEN F=1:GOTO 2960
1970 IF FLAG16=1 THEN 5050
1980 IF FLAG17=1 THEN 6160
1990 IF FLAG18=1 THEN 6990
2000 IF FLAG19=1 THEN 2100
2010 IF FLAG25=1 THEN FLAG25=0:GOSUB 2860
2020 IF FLAG26=1 THEN 2030 ELSE 2040
2030 FLAG26=0:STATUS$="i":TITLE$="":GOTO 440
2040 IF FLAG27=1 THEN 6280
2050 IF K<N THEN 2070
2060 IF J=7 THEN 2950
2070 IF K=6 AND J=9 THEN 2090
2080 GOSUB 1280:NEXT J:NEXT K
2090 FLAG1=0:IF STATUS$="e" THEN 4160
2100 M=M+5:GOSUB 810

```

```

2110 FOR K=M TO M+5: FOR J=1 TO 17
2120 IF STATUS$="e" THEN 2140
2130 IF K=M AND J<=8 THEN FLAG20=1:GOTO 2380
2140 IF FLAG19=1 THEN FLAG6=1:GOTO 2340
2150 IF FLAG21=1 THEN FLAG6=0:GOTO 2380
2160 IF FLAG22=1 THEN FLAG6=1:GOTO 2340
2170 IF FLAG23=1 THEN FLAG6=0:GOTO 2380
2180 IF FLAG10=1 THEN GOSUB 2420
2190 IF FLAG11=1 THEN GOSUB 2530
2200 IF FLAG12=1 THEN GOSUB 2640
2210 IF FLAG13=1 THEN GOSUB 2760
2220 IF FLAG14=1 THEN GOSUB 5580
2230 IF FLAG15=1 THEN F=1:GOTO 2960
2240 IF FLAG16=1 THEN 5050
2250 IF FLAG17=1 THEN 6160
2260 IF FLAG18=1 THEN 6990
2270 IF FLAG25=1 THEN FLAG25=0:GOSUB 2860
2280 IF FLAG26=1 THEN 2290 ELSE 2300
2290 FLAG26=0:STATUS$="1":TITLE$="":GOTO 440
2300 IF FLAG27=1 THEN 6280
2310 IF FLAG19=1 THEN K=M:J=1:GOTO 2100
2320 IF FLAG22=1 AND M=6 THEN M=1:GOTO 1860
2330 IF FLAG22=1 AND M>=11 THEN K=M:J=1:M=M-10:GOTO 2100
2340 IF K<N THEN 2360
2350 IF J=7 THEN 2950
2360 IF K=M+5 AND J=9 THEN 2370 ELSE 2380
2370 IF STATUS$="i" THEN 2100 ELSE 2950
2380 GOSUB 1280:NEXT J:NEXT K
2390 '
2400 ' SUBROUTINE TO MOVE CURSER LEFT
2410 '
2420 IF K=2 AND J=8 THEN K=K:GOTO 2480
2430 IF K=2 AND J=9 THEN K=K:GOTO 2480
2440 IF K=1 THEN K=1:GOTO 2480
2450 IF M>=6 AND K=M THEN 2490
2460 IF K>M THEN K=K-1
2470 IF J=17 AND A(16,K)=0 THEN K=K+1:GOTO 2480
2480 J=J-1:FLAG10=0:RETURN
2490 FLAG22=1:PREVJ=J:FLAG10=0:RETURN
2500 '
2510 ' SUBROUTINE TO MOVE CURSER RIGHT
2520 '
2530 IF K=M+5 AND J<=9 THEN 2600
2540 IF K=M+4 AND J>9 THEN 2600
2550 IF K<N THEN K=K+1
2560 IF J=17 AND A(16,K)=0 THEN K=K-1:GOTO 2590
2570 IF J<=7 AND K=N THEN K=N
2580 IF J>7 AND K=N THEN K=NUM
2590 J=J-1:FLAG11=0:RETURN
2600 FLAG19=1:PREVJ=J:FLAG11=0:RETURN
2610 '
2620 ' SUBROUTINE TO MOVE CURSER UP
2630 '
2640 IF J=2 AND K=1 THEN 2650 ELSE 2660

```



```

2650 STATUS="r":GOSUB 1190:STATUS="e":J=1:K=1:GOTO 2720
2660 IF J=2 THEN J=1:GOTO 2720
2670 IF J=6 AND FLAG2=1 THEN J=2:GOTO 2720
2680 IF K=1 AND J=11 THEN J=6:GOTO 2720
2690 IF J=11 THEN J=8:GOTO 2720
2700 IF J=16 THEN J=12:GOTO 2720
2710 IF J>=3 AND J<=17 THEN J=J-2:FLAG12=0:GOTO 2720
2720 FLAG12=0:RETURN
2730 '
2740 ' SUBROUTINE TO MOVER CURSER DOWN
2750 '
2760 IF K=N AND J=7 THEN J=6:GOTO 2820
2770 IF FLAG2=1 AND J=3 THEN J=5:GOTO 2820
2780 IF J=9 THEN J=10:GOTO 2820
2790 IF J=13 THEN J=15:GOTO 2820
2800 IF J=16 AND A(J,K)=0 THEN J=15:GOTO 2820
2810 IF J=17 THEN J=16:GOTO 2820
2820 FLAG13=0:RETURN
2830 '
2840 ' DRAIN BY CHANGING UNIT WEIGHT OF WATER
2850 '
2860 LOCATE 12,1:PRINT STRING$(30," "):COLOR 0,7
2870 LOCATE 12,1:PRINT "unit weight of water"
2880 COLOR 7,0:LOCATE 12,23:INPUT "= ",WATER
2890 LOCATE 12,1:PRINT STRING$(30," "):LOCATE 12,1
2900 PRINT "unit weight of water = ";WATER
2910 J=J-1:F=1:GOTO 2960
2920 '
2930 ' CALCULATION OF SLICE PARAMETERS
2940 '
2950 IF STATUS="e" THEN 4160
2960 GOSUB 3220:FOR K=1 TO N:GOSUB 3330:NEXT K
2970 FOR K=1 TO NUM:GOSUB 3390:NEXT K
2980 WAT=.5*WATER:GOSUB 3480
2990 FOR K=1 TO N:A(24,K)=A(12,K)/F:A(26,K)=A(8,K)/F
3000 PB(K)=A(11,K)*RAD:PS(K)=A(7,K)*RAD
3010 A(25,K)=TAN(PB(K))/F
3020 A(27,K)=TAN(PS(K))/F
3030 PB(K)=ATN(A(25,K)):PS(K)=ATN(A(27,K))
3040 PHALP(K)=PB(K)-A(20,K):THETA(K)=A(16,K)*RAD
3050 TV(K)=A(15,K)*SIN(THETA(K))+WW(K)
3060 IF A(16,K)=90 THEN TH(K)=0:GOTO 3090
3070 IF A(16,K)=270 THEN TH(K)=0:GOTO 3090
3080 TH(K)=A(15,K)*COS(THETA(K))
3090 TH(K)=TH(K)+WH(K):NEXT K
3100 TV(N-1)=TV(N-1)-A(23,N)*SIN(A(18,N))
3110 TH(N-1)=TH(N-1)-A(23,N)*COS(A(18,N))
3120 TV(1)=TV(1)+A(23,1)*SIN(A(18,1))
3130 TH(1)=TH(1)+A(23,1)*COS(A(18,1))
3140 '
3150 ' CALCULATION OF Kc
3160 '
3170 FOR K=2 TO N:GOSUB 3780:NEXT K
3180 FOR K=1 TO NUM:GOSUB 3790:NEXT K:GOTO 3950

```

```

3190 '
3200 ' SUBROUTINE FOR DISPLAY OF "calculating"
3210 '
3220 IF FLAG15=0 THEN LOCATE 20,7:PRINT STRING$(70," ")
3230 LOCATE 22,7:PRINT STRING$(70," ")
3240 LOCATE 23,7:PRINT STRING$(70," ")
3250 LOCATE 24,7:PRINT STRING$(70," ");
3260 LOCATE 22,28:COLOR 0,7
3270 PRINT " CALCULATING ":COLOR 7,0
3280 FOR K=1 TO N:TV(K)=0:TH(K)=0:WW(K)=0:WH(K)=0
3290 ZW(K)=0:ZWT(K)=0:NEXT K:RETURN
3300 '
3310 ' SUBROUTINES FOR CALCULATION OF SLICE GEOMETRY
3320 '
3330 IF A(4,K)<A(6,K) THEN A(4,K)=A(6,K):A(3,K)=A(5,K)
3340 DSQ=(A(1,K)-A(5,K))^2+(A(2,K)-A(6,K))^2
3350 IF DSQ=0 THEN A(17,K)=0 ELSE A(17,K)=SQR(DSQ)
3360 IF A(2,K)-A(6,K)=0 THEN A(18,K)=0:RETURN
3370 A(18,K)=ATN((A(1,K)-A(5,K))/(A(2,K)-A(6,K)))
3380 RETURN
3390 A(19,K)=A(5,K+1)-A(5,K)
3400 IF A(19,K)=0 THEN A(20,K)=0:GOTO 3420
3410 A(20,K)=ATN((A(6,K+1)-A(6,K))/A(19,K))
3420 A(21,K)=(A(6,K)-A(2,K+1))*(A(1,K)-A(5,K+1))
3430 A(21,K)=A(21,K)+(A(2,K)-A(6,K+1))*(A(1,K+1)-A(5,K))
3440 A(21,K)=.5*A(10,K)*A(21,K):RETURN
3450 '
3460 ' SUBROUTINE FOR CALCULATION OF WATER FORCES
3470 '
3480 FOR K=1 TO NUM:ZW(K)=A(4,K)-A(6,K)
3490 ZW(K+1)=A(4,K+1)-A(6,K+1)
3500 A(22,K)=WAT*(ZW(K)+ZW(K+1))*A(19,K)
3510 A(22,K)=ABS(A(22,K)/COS(A(20,K))):NEXT K
3520 FOR K=1 TO N:ZWT(K)=A(4,K)-A(2,K)
3530 IF ZWT(K)>0 THEN 3550
3540 A(23,K)=WAT*ABS(ZW(K)^2/COS(A(18,K))):GOTO 3570
3550 A(23,K)=WAT*(ZWT(K)+ZW(K))
3560 A(23,K)=A(23,K)*ABS((A(2,K)-A(6,K))/COS(A(18,K)))
3570 NEXT K
3580 FOR K=1 TO NUM
3590 IF ZWT(K)>0 AND ZWT(K+1)>0 THEN 3600 ELSE 3640
3600 WW(K)=WAT*(ZWT(K)+ZWT(K+1))
3610 WW(K)=WW(K)*ABS((A(1,K+1)-A(1,K)))
3620 WH(K)=WAT*(A(2,K+1)-A(2,K))*(ZWT(K)+ZWT(K+1))
3630 IF A(2,K+1)<A(2,K) THEN WH(K)=-WH(K):GOTO 3740
3640 IF ZWT(K)>=0 AND ZWT(K+1)<=0 THEN 3650 ELSE 3690
3650 WW(K)=WAT*ZWT(K)^2*(A(1,K+1)-A(1,K))
3660 IF A(2,K+1)-A(2,K)=0 THEN WW(K)=0:GOTO 3680
3670 WW(K)=ABS(WW(K)/(A(2,K+1)-A(2,K)))
3680 WH(K)=WAT*ZWT(K)^2:GOTO 3740
3690 IF ZWT(K)<=0 AND ZWT(K+1)>=0 THEN 3700 ELSE 3740
3700 WW(K)=WAT*ZWT(K+1)^2*(A(1,K+1)-A(1,K))
3710 IF A(2,K+1)-A(2,K)=0 THEN WW(K)=0:GOTO 3730
3720 WW(K)=ABS(WW(K)/(A(2,K+1)-A(2,K)))

```

```

3730 WH(K)=-WAT*(ZWT(K+1))^2
3740 NEXT K:RETURN
3750 '
3760 ' SUBROUTINE FOR CALCULATION OF S,R,Q,e,P, AND a
3770 '
3780 A(29,K)=A(26,K)*A(17,K)-A(23,K)*A(27,K):RETURN
3790 A(28,K)=A(24,K)*A(19,K)
3800 A(28,K)=A(28,K)/COS(A(20,K))-A(22,K)*A(25,K)
3810 A(30,K)=COS(PB(K)-A(20,K)+PS(K+1)-A(18,K+1))
3820 A(30,K)=COS(PS(K+1))/A(30,K)
3830 A(31,K)=A(30,K)*COS(PB(K)-A(20,K)+PS(K)-A(18,K))
3840 A(31,K)=A(31,K)/COS(PS(K))
3850 A(32,K)=A(30,K)*A(21,K)*COS(PB(K)-A(20,K))
3860 A(33,K)=(A(21,K)+TV(K))*SIN(PHALP(K))
3870 A(33,K)=A(33,K)+TH(K)*COS(PHALP(K))
3880 A(33,K)=A(33,K)+A(28,K)*COS(PB(K))
3890 A(33,K)=A(33,K)+A(29,K+1)*SIN(PHALP(K)-A(18,K+1))
3900 A(33,K)=A(33,K)-A(29,K)*SIN(PHALP(K)-A(18,K))
3910 A(33,K)=A(33,K)*A(30,K):RETURN
3920 '
3930 ' CALCULATION OF Kc AND FOS
3940 '
3950 GOSUB 4470
3960 IF FLAG7=1 OR FLAG8=1 OR FLAG77=1 THEN 3990
3970 IF F<>1 THEN 4080
3980 IF (Z2+A(32,NUM))=0 THEN ACC=0:GOTO 4110
3990 ACC(1)=(Z3+A(33,NUM))/(Z2+A(32,NUM))
4000 IF F=1 THEN ACC=ACC(1)
4010 IF FLAG8=1 THEN 4110
4020 IF FLAG7=1 THEN 5210
4030 IF FLAG77=1 THEN 6890
4040 F=1+3.33*ACC(1)
4050 IF F<=0 THEN F=.1
4060 IF F>5 THEN F=5
4070 GOTO 2990
4080 ACC(2)=(Z3+A(33,NUM))/(Z2+A(32,NUM))
4090 Y=1/F:FS=1-ACC(1)*(1-Y)/(ACC(1)-ACC(2)):FOS=1/FS
4100 F=FOS:FLAG8=1:GOTO 2990
4110 FLAG8=0:FLAG4=0:FOR K=1 TO NUM:GOSUB 4740:NEXT K
4120 FOR K=1 TO NUM:GOSUB 4770:NEXT K
4130 IF M>=6 THEN 4140 ELSE 4150
4140 F=1:M=1:STATUS="e":FLAG6=1:FLAG15=0:GOTO 1860
4150 LOCATE 22,28:PRINT "
4160 IF FLAG50=1 THEN 1570
4170 GOSUB 4950:LOCATE 22,7:COLOR 15,0
4180 LOCATE 22,7:COLOR 15,0
4190 PRINT "Acceleration Kc = ";
4200 LOCATE 22,27:PRINT USING "##.####";ACC;
4210 LOCATE 22,47:PRINT "Factor of safety = ";
4220 LOCATE 22,66:PRINT USING "##.##";FOS;:COLOR 7,0
4230 IF FLAG4=0 AND ABS(ACC(2))>.1 THEN 4240 ELSE 4270
4240 LOCATE 23,7:COLOR 15
4250 PRINT "Large extrapolation - plot of fos vs K suggested";
4260 LOCATE 23,59:PRINT "to check fos";:COLOR 7,0

```

```

4270 IF FLAG4=0 THEN 4340 ELSE LOCATE 23,7:COLOR 15,0
4280 PRINT "Negative effective normal stresses - "
4290 LOCATE 23,50:PRINT "solution unacceptable"
4300 COLOR 7,0
4310 '
4320 ' Control of screen displays
4330 '
4340 STATUS="e":FLAG15=0:GOSUB 4540
4350 IF STATUS="e" THEN 4370
4360 FLAG6=1:STATUS="e":GOTO 1860
4370 IF FLAG19=1 THEN 4380 ELSE 4390
4380 FLAG21=1:FLAG3=0:FLAG19=0:GOTO 2110
4390 IF FLAG22=1 AND K=7 THEN 4400 ELSE 4410
4400 FLAG23=1:FLAG3=0:FLAG22=0:GOTO 1870
4410 IF FLAG22=1 AND K>=11 THEN 4420 ELSE 4430
4420 FLAG23=1:FLAG3=0:FLAG22=0:GOTO 2110
4430 FLAG6=0:FLAG3=0:J=1:K=1:M=1:GOTO 1870
4440 '
4450 ' SUBROUTINE FOR CALCULATION OF K
4460 '
4470 Z1=1:Z2=0:Z3=0
4480 FOR K=NUM TO 2 STEP-1
4490 Z1=Z1*A(31,K):Z2=Z2+A(32,K-1)*Z1
4500 Z3=Z3+A(33,K-1)*Z1:NEXT K:RETURN
4510 '
4520 ' DISPLAY OF FUNCTION KEY
4530 '
4540 LOCATE 24,1:PRINT "1";
4550 LOCATE 24,3:COLOR 0,7:PRINT "print";
4560 COLOR 7,0:LOCATE 24,10:PRINT "2";
4570 LOCATE 24,12:COLOR 0,7:PRINT "calculate";
4580 COLOR 7,0:LOCATE 24,23:PRINT "3";
4590 LOCATE 24,25:COLOR 0,7:PRINT "fos vs K";
4600 COLOR 7,0:LOCATE 24,35:PRINT "4";
4610 LOCATE 24,37:COLOR 0,7:PRINT "drain";
4620 COLOR 7,0:LOCATE 24,44:PRINT "5";
4630 LOCATE 24,46:COLOR 0,7:PRINT "file";
4640 COLOR 7,0:LOCATE 24,52:PRINT "6";
4650 LOCATE 24,54:COLOR 0,7:PRINT "restart";
4660 COLOR 7,0:LOCATE 24,63:PRINT "7";
4670 LOCATE 24,65:COLOR 0,7:PRINT "quit";
4680 COLOR 7,0:LOCATE 24,70:PRINT "8";
4690 LOCATE 24,72:COLOR 0,7:PRINT "view";
4700 COLOR 7,0:RETURN
4710 '
4720 ' SUBROUTINE FOR CALCULATION OF EFFECTIVE NORMAL STRESSES
4730 '
4740 A(34,K+1)=A(33,K)+A(34,K)*A(31,K)-ACC(1)*A(32,K)
4750 A(35,K)=(A(34,K)-A(23,K))*A(27,K)+A(26,K)*A(17,K)
4760 RETURN
4770 A(36,K)=A(21,K)+TV(K)+A(35,K+1)*COS(A(18,K+1))
4780 A(36,K)=A(36,K)-A(35,K)*COS(A(18,K))
4790 A(36,K)=A(36,K)-A(34,K+1)*SIN(A(18,K+1))
4800 A(36,K)=A(36,K)+A(34,K)*SIN(A(18,K))

```

```

4810 A(36,K)=A(36,K)+A(22,K)*A(25,K)*SIN(A(20,K))
4820 A(36,K)=A(36,K)-A(24,K)*A(19,K)*TAN(A(20,K))
4830 A(36,K)=A(36,K)*COS(PB(K))/COS(PHALP(K))
4840 A(37,K)=(A(36,K)-A(22,K))*A(25,K)
4850 A(37,K)=A(37,K)+A(24,K)*A(19,K)/COS(A(20,K))
4860 A(38,K)=(A(36,K)-A(22,K))*COS(A(20,K))/A(19,K)
4870 IF A(17,K)=0 THEN A(39,K)=0:GOTO 4900
4880 IF K=1 THEN A(39,K)=0:GOTO 4900
4890 A(39,K)=(A(34,K)-A(23,K))/A(17,K)
4900 IF A(38,K)<0 OR A(39,K)<0 THEN FLAG4=1
4910 RETURN
4920 '
4930 ' SUBROUTINE FOR DISPLAY OF NORMAL STRESSES
4940 '
4950 LOCATE 19,1:PRINT "base stresses"
4960 LOCATE 20,1:PRINT "side stresses"
4970 MEND=M+5:IF MEND<N THEN 4980 ELSE MEND=N
4980 J=38:FOR K=M TO MEND-1:X=23+(10*(K-M)):Y=19
4990 LOCATE Y,X:PRINT USING "#####.##";A(J,K):NEXT K
5000 J=39:FOR K=M TO MEND:X=18+(10*(K-M)):Y=20
5010 LOCATE Y,X:PRINT USING "#####.##";A(J,K):NEXT K:RETURN
5020 '
5030 ' CALCULATION OF ACCELERATION K FOR DIFFERENT SAFETY
FACTORS
5040 '
5050 CLS:SCREEN 2:GOSUB 6730
5060 LOCATE 3,57:PRINT "factor of safety"
5070 LOCATE 4,53:PRINT " versus acceleration K"
5080 LOCATE 8,54:PRINT " PLEASE WAIT FOR PLOT":GOSUB 6870
5090 LOCATE 8,54:PRINT STRING$(21," ")
5100 LOCATE 25,2:PRINT "to terminate calculation press ";
5110 PRINT "[ENTER]";
5120 PRINT " in response to prompt for a new value";
5130 LOCATE 6,54:PRINT "Enter f.o.s. = ";
5140 LOCATE 8,57:PRINT "f.o.s.";:LOCATE 8,68:PRINT "acc. K";
5150 Y=6:X=69:LOCATE Y,X:INPUT " ",F$
5160 IF LEN(F$)=0 THEN 5260
5170 IF F$="0" THEN F$=".01"
5180 F=VAL(F$):FL(L)=F:Y=10:X=56
5190 LOCATE Y,X:PRINT USING "###.####";FL(L)
5200 FLAG7 = 1:GOTO 2990
5210 ACL(L)=ACC(1):L=L+1
5220 IF FLAG30=1 THEN 5410
5230 LOCATE Y,67:PRINT USING "###.####";ACC(1)
5240 LOCATE 6,69:PRINT " ";
5250 FLAG7 = 0:GOTO 5150
5260 FIN=L:LOCATE 25,1:PRINT STRING$(78," ");
5270 LOCATE 25,1:PRINT "[F1]";:LOCATE 25,6
5280 PRINT "print fos vs K";
5290 LOCATE 25,23:PRINT "[F2]";:LOCATE 25,28
5300 PRINT "return to slice data array";
5310 LOCATE 25,57:PRINT "[F3]";:LOCATE 25,62
5320 PRINT "restart";
5330 LOCATE 25,71:PRINT "[F4]";:LOCATE 25,76

```

```

5340 PRINT "quit";:FLAG16=0
5350 Q$=INKEY$:IF Q$=" " THEN 5350
5360 IF Q$ = "a" THEN GOSUB 5450:GOTO 5350
5370 IF Q$ = "b" THEN SCREEN 0,0,0:CHECK=1:GOTO 5400
5380 IF Q$ = "c" THEN SCREEN 0,0,0:GOTO 440
5390 IF Q$ = "d" THEN SCREEN 0,0,0:GOTO 6990 ELSE GOTO 5350
5400 F=1:FLAG30=1:GOTO 5200
5410 FLAG30=0:FLAG7=0:STATUS="e":FLAG6=1:F=1:M=1:GOTO 1860
5420 '
5430 ' SUBROUTINE FOR PRINTING FOS VS K
5440 '
5450 LPRINT:LPRINT:LPRINT:LPRINT
5460 LPRINT TAB(13) "Analysis no. ";:LPRINT TITLES
5470 LPRINT TAB(13) "Plot of factor of safety";
5480 LPRINT TAB(38) "versus acceleration K"
5490 LPRINT:LPRINT TAB(19) "f.o.s.";
5500 LPRINT TAB(32) "acc. K";:LPRINT TAB(44) "1/fos":PRINT
5510 FOR L=1 TO FIN-1:LPRINT TAB(18) USING "##.####";FL(L);
5520 LPRINT TAB(31) USING "##.####";ACL(L);
5530 LPRINT TAB(43) USING "##.####";1/FL(L):NEXT L
5540 LPRINT:LPRINT:LPRINT:LPRINT:RETURN
5550 '
5560 ' SUBROUTINE FOR PRINTING ARRAY AND RESULTS
5570 '
5580 PREVJ=J:PREVK=K:PREVM=M:FLAG14=0
5590 LPRINT:LPRINT:LPRINT:LPRINT:LPRINT:LPRINT
5600 LPRINT TAB(23) "SARMA NON-VERTICAL SLICE ANALYSIS":LPRINT
5610 LPRINT "Analysis no. ";:LPRINT TAB(14) TITLES
5620 LPRINT:LPRINT "Unit weight of water =";
5630 LPRINT TAB(23) WATER:X1=1:X2=N
5640 IF X2>6 THEN X2=X1+5
5650 T1=20:LPRINT:LPRINT "Side number";
5660 FOR X=X1 TO X2:LPRINT TAB(T1);:LPRINT USING "##";X;
5670 T1=T1+10:NEXT X:X3=X2:IF X2=N THEN LPRINT
5680 T1=16:LPRINT "Coordinate xt";:J=1:GOSUB 6070
5690 T1=16:LPRINT "Coordinate yt";:J=2:GOSUB 6070
5700 T1=16:LPRINT "Coordinate xw";:J=3:GOSUB 6070
5710 T1=16:LPRINT "Coordinate yw";:J=4:GOSUB 6070
5720 T1=16:LPRINT "Coordinate xb";:J=5:GOSUB 6070
5730 T1=16:LPRINT "Coordinate yb";:J=6:GOSUB 6070
5740 T1=16:LPRINT "Friction angle";:J=7:GOSUB 6070
5750 T1=16:LPRINT "Cohesion";:J=8:GOSUB 6070
5760 T1=25:LPRINT:LPRINT "Slice number";
5770 IF X2=N THEN X3=N-1 ELSE X3=X2
5780 FOR X=X1 TO X3:LPRINT TAB(T1);:LPRINT USING "##";X;
5790 T1=T1+10:NEXT X:IF X2=N THEN LPRINT
5800 T1=21:LPRINT "Rock unit weight";:J=10:GOSUB 6070
5810 T1=21:LPRINT "Friction angle";:J=11:GOSUB 6070
5820 T1=21:LPRINT "Cohesion";:J=12:GOSUB 6070
5830 T1=21:LPRINT "Force T";:J=15:GOSUB 6070
5840 T1=21:LPRINT "Angle theta";:J=16:GOSUB 6070:LPRINT
5850 LPRINT "Effective normal stresses "
5860 T1=21:LPRINT "Base";:J=38:GOSUB 6070
5870 T1=16:LPRINT "Side";:J=39:GOSUB 6070:LPRINT:LPRINT

```

```

5880 IF X2=N THEN 5950
5890 IF X2<N THEN X1=X1+6:X2=N
5900 IF X2<X1+5 THEN 5910 ELSE X2=X1+5
5910 IF X1=13 OR X1=27 THEN 5930
5920 LPRINT:LPRINT:GOTO 5650
5930 LPRINT:LPRINT:LPRINT:LPRINT:LPRINT
5940 LPRINT:LPRINT:LPRINT:LPRINT:GOTO 5650
5950 LPRINT TAB(7) "Acceleration Kc = ";
5960 LPRINT TAB(27);:LPRINT USING "##.###";ACC;
5970 LPRINT TAB(47) "Factor of Safety = ";
5980 LPRINT TAB(66);:LPRINT USING "##.##";FOS
5990 IF FLAG4=0 THEN 6020
6000 LPRINT TAB(7) "Negative effective normal stresses";
6010 LPRINT TAB(45) "- solution unacceptable":GOTO 6050
6020 IF FLAG4=0 AND ABS(ACC(2))<.1 THEN 6050
6030 LPRINT TAB(7) "Large extrapolation - plot of fos";
6040 LPRINT TAB(44) "vs K suggested to check fos"
6050 J=PREVJ-1:K=PREVK:M=PREVM
6060 LPRINT:LPRINT:LPRINT:RETURN
6070 FOR K=X1 TO X3:LPRINT TAB(T1);:GOSUB 6090
6080 T1=T1+10:NEXT K:LPRINT:RETURN
6090 IF A(J,K)=0 THEN 6110
6100 IF ABS(A(J,K))>999999! OR ABS(A(J,K))<8.9999999E-03 THEN 6120
6110 LPRINT USING "#####.##";A(J,K);:RETURN
6120 LPRINT USING "##.##^####";A(J,K);:RETURN
6130 '
6140 ' STORAGE OF DATA ON DISK FILE
6150 '
6160 CLS:LOCATE 4,1:PRINT STRING$(80,45)
6170 PRINT:PRINT "Sarma files on data disk ";
6180 PRINT:FILES D$+"*.SAR":PRINT:PRINT STRING$(80,45):PRINT
6190 INPUT "Enter filename (without extension): ",FILES
6200 OPEN D$+FILES+".SAR" FOR OUTPUT AS #2
6210 PRINT#2,TITLE$:PRINT#2,N:WRITE#2,WATER
6220 WRITE#2,FLAG2:WRITE#2,FLAG3:WRITE#2,FLAG4
6230 FOR K=1 TO N:FOR J=1 TO 39:WRITE#2,A(J,K):NEXT J:NEXT K
6240 CLOSE#2:FLAG6=1:STATUS="e":F=1:M=1:FLAG17=0:GOTO 1860
6250 '
6260 ' GRAPHICAL DISPLAY OF GEOMETRY
6270 '
6280 SCREEN 2:XA=0:XB=0:YA=0:YB=0:JMIN=1:JMAX=5:DJ=2
6290 KMIN=1:KMAX=N:DK=N-1:GOSUB 6630:XMIN=MIN
6300 JMIN=1:JMAX=5:DJ=2:KMIN=1:KMAX=N
6310 DK=N-1:GOSUB 6690:XMAX=MAX
6320 JMIN=2:JMAX=6:DJ=2:KMIN=1:KMAX=N
6330 DK=1:GOSUB 6630:YMIN=MIN
6340 JMIN=2:JMAX=6:DJ=2:KMIN=1:KMAX=N
6350 DK=1:GOSUB 6690:YMAX=MAX
6360 XSC=270/(XMAX-XMIN):YSC=160/(YMAX-YMIN)
6370 IF XSC<YSC THEN SC=XSC ELSE SC=YSC
6380 LNY=199:XADJ=(319/SC-(XMAX-XMIN))/2
6390 YADJ=(199/SC-(YMAX-YMIN))/2
6400 XMIN=XMIN-XADJ:YMIN=YMIN-YADJ:FOR K=1 TO N-1
6410 XA=2*(A(1,K)-XMIN)*SC:YA=LNY-(A(2,K)-YMIN)*SC

```

```

6420 XB=2*(A(1,K+1)-XMIN)*SC:YB=LNY-(A(2,K+1)-YMIN)*SC
6430 LINE (XA,YA)-(XB,YB),3
6440 XA=2*(A(5,K)-XMIN)*SC:YA=LNY-(A(6,K)-YMIN)*SC
6450 XB=2*(A(5,K+1)-XMIN)*SC:YB=LNY-(A(6,K+1)-YMIN)*SC
6460 LINE (XA,YA)-(XB,YB),3
6470 XA=2*(A(1,K)-XMIN)*SC:YA=LNY-(A(2,K)-YMIN)*SC
6480 XB=2*(A(5,K)-XMIN)*SC:YB=LNY-(A(6,K)-YMIN)*SC
6490 LINE (XA,YA)-(XB,YB),3
6500 XA=2*(A(3,K)-XMIN)*SC:YA=LNY-(A(4,K)-YMIN)*SC
6510 XB=2*(A(3,K+1)-XMIN)*SC:YB=LNY-(A(4,K+1)-YMIN)*SC
6520 LINE (XA,YA)-(XB,YB),1:NEXT K
6530 XA=2*(A(1,N)-XMIN)*SC:YA=LNY-(A(2,N)-YMIN)*SC
6540 XB=2*(A(5,N)-XMIN)*SC:YB=LNY-(A(6,N)-YMIN)*SC
6550 LINE (XA,YA)-(XB,YB),3
6560 LOCATE 25,29:PRINT "press any key to return";
6570 IF LEN(INKEY$)=0 THEN 6570
6580 FLAG27=0:SCREEN 0,0,0:WIDTH 80
6590 STATUS="e":FLAG6=1:F=1:M=1:GOTO 1860
6600 '
6610 ' SUBROUTINE TO FIND MIN IN RANGE
6620 '
6630 MIN=A(JMIN,KMIN):FOR J=JMIN TO JMAX STEP DJ
6640 FOR K=KMIN TO KMAX STEP DK:IF MIN>A(J,K) THEN MIN=A(J,K)
6650 NEXT K:NEXT J:RETURN
6660 '
6670 ' SUBROUTINE TO FIND MAX IN RANGE
6680 '
6690 MAX=A(JMIN,KMIN):FOR J=JMIN TO JMAX STEP DJ
6700 FOR K=KMIN TO KMAX STEP DK:IF MAX<A(J,K) THEN MAX=A(J,K)
6710 NEXT K:NEXT J:RETURN
6720 '
6730 ' SUBROUTINE TO PLOT FOS VS K
6740 '
6750 LINE (5,5)-(635,185),,B:LINE (395,8)-(630,90),,B
6760 LINE (200,5)-(200,185):LINE (5,125)-(635,125)
6770 LINE (66,125)-(66,130):LOCATE 17,7:PRINT "-0.5"
6780 LINE (333,125)-(333,130):LOCATE 17,41:PRINT "0.5"
6790 LINE (466,125)-(466,130):LOCATE 17,58:PRINT "1.0"
6800 LINE (600,125)-(600,130):LOCATE 17,75:PRINT "1.5"
6810 LINE (200,13)-(205,13):LOCATE 2,28:PRINT "2.5"
6820 LINE (200,50)-(205,50):LOCATE 7,28:PRINT "2.0"
6830 LINE (200,87)-(205,87):LOCATE 12,28:PRINT "1.5"
6840 LINE (200,166)-(205,166):LOCATE 22,28:PRINT "0.5"
6850 LOCATE 3,24:PRINT "f":LOCATE 4,24:PRINT "o":LOCATE 5,24
6860 PRINT "s":LOCATE 15,60:PRINT "acceleration K":FLAG77=0:RETURN
6870 F=2.5:L=1
6880 FL(L)=F:ACL(L)=ACC(1):FLAG77=1:GOTO 2990
6890 KSX=(ACC(1)*400/1.5)+200:FSY=200-(75*F):IF F>2.2 THEN 6920
6900 SLOPE(L)=(10+ACC(1))-(10+ACL(L))
6910 IF SLOPE(L)<0 THEN FLAG77=0:RETURN
6920 IF KSX<5 THEN KSX=6
6930 IF KSX>635 THEN FLAG77=0:RETURN
6940 IF FSY<5 THEN FSY=6
6950 IF FSY>185 THEN FSY=184

6960 IF F=2.5 THEN CIRCLE (KSX,FSY),2,1:GOTO 6980
6970 LINE -(KSX,FSY):CIRCLE (KSX,FSY),2,1
6980 IF L<23 THEN F=F-.1:L=L+1:GOTO 6880 ELSE FLAG77=0:RETURN
6990 CLS:END

```

**The two page vita has been
removed from the scanned
document. Page 1 of 2**

**The two page vita has been
removed from the scanned
document. Page 2 of 2**