

Dylan Mark Rowley

Thesis submitted to the faculty of the
Virginia Polytechnic Institute and State University
in partial fulfillment of the requirements for the degree of

Master of Science

In

Mining and Minerals Engineering

Gerald H. Luttrell, Chair
Gregory T. Adel
Jaisen N. Kohmuench

June 6, 2014
Blacksburg, VA



Dylan Rowley <drowley0160@gmail.com>

DE/GMPR/P1626

East, Deborah <Deborah.East@tandf.co.uk>
To: Dylan Rowley <drowley0160@gmail.com>

Tue, Jul 15, 2014 at 5:00 AM

Our Ref: DE/GMPR/P1626

Date: 15th July 2014

Dear Dylan Rowley,

Thank you for your correspondence requesting permission to reproduce the following material from our Journal in your printed thesis at **Virginia Tech** entitled "**Investigation of Flash Flotation Technology Utilizing Centrifugal Forces and Novel Sparging Methods**" and to be posted in your university's repository.

Material Requested: 1 x figure – The Effect of Bubble Size on Fine Particle Flotation – Mineral Processing and Extractive Metallurgy Review: An International Journal – Volume 5 Issue 1-4 PP 101-122 – Authors – R. H. Yoon & G. H. Luttrell

We will be pleased to grant entirely free permission on the condition that you acknowledge the original source of publication and insert a reference to the Journal's web site:
www.tandfonline.com

Please note that this licence does not allow you to post our content on any third party websites or repositories.

Thank you for your interest in our Journal.

Yours sincerely

Debbie East.

Debbie East- Permissions & Licence Administrator - Journals.

Routledge, Taylor & Francis Group.

3 Park Square, Milton Park, Abingdon, Oxon, OX14 4RN, UK.

Tel : +44(0)20 7017 6960

Fax: +44 (0)20 7017 6336

Web: www.tandfonline.com

E-mail: deborah.east@tandf.co.uk _

Taylor & Francis is a trading name of Informa UK Limited,
registered in England under no. 1072954



Visit <http://www.tandf.co.uk/eupdates> to receive email updates about journals, books and other news within your areas of interest.



Please don't print this e-mail unless you really need to.

From: Dylan Rowley [<mailto:drowley0160@gmail.com>]

Sent: 14 July 2014 15:02

To: Academic UK Non Rightslink

Subject: gmpr20: The Effect of Bubble Size on Fine Particle Flotation

Permissions Request

Contact name: Dylan Rowley

Street address: 1781 old buckhead rd

Town: madison

Postcode/ZIP code: 30650

Country: United States

Contact telephone number: 7068181587

Contact email address: drowley0160@gmail.com

Article title: The Effect of Bubble Size on Fine Particle Flotation

Article DOI: 10.1080/08827508908952646

Author name: R. H. YOON, G. H. LUTTRELL

Journal title: Mineral Processing and Extractive Metallurgy Review

Volume number: 5

Issue number: 1-4

Year of publication: 1989

Page number(s): 101-122

Are you the sole author/editor of the new publication?: Yes

Are you requesting the full article?: No

If no, please supply extract and include number of word:

If no, please supply details of figure/table: Analysis of Adhesion Probability in Flotation at Varying Induction Times

Name of publisher of new publication: Virginia Tech

Title of new publication: Investigation of Flash Flotation Technology Utilizing Centrifugal Forces and Novel Sparging Methods

Course pack: No

Number of Students:

Is print:

Electronic:

E-reserve: No

Period of use:

Short loan library?: No

Thesis: Yes

To be reprinted in a new publication?: Yes

In print format: Yes

In ebook format?: No

ISBN:

Languages:

Distribution quantity:

Retail price:

Additional comments:



Dylan Rowley <drowley0160@gmail.com>

AIME Permission for Picture Use in Your Thesis

9 messages

Michele Lawrie-Munro <lawriemunro@aimehq.org>
To: "drowley0160@gmail.com" <drowley0160@gmail.com>

Fri, Jul 11, 2014 at 4:22 AM

Many thanks for your call today, Dillon, re: the above. I have looked in our digital library for the reference below that you gave me and cannot find it among the 60 references of articles by Gaudin. I wanted to ensure I took down all of the details properly? Also, if would be helpful if you could provide a figure or page number in your reply as well. Let me know if anything isn't correct.

"Effect of particle size on flotation" by Gaudin, Volume 414 from 1931.

Michele

L. Michele Lawrie-Munro, CAE
Executive Director
American Institute of Mining, Metallurgical, and Petroleum Engineers, Inc. (AIME)
12999 East Acam Aircraft Circle
Englewood, CO 80112
Email: lawriemunro@aimehq.org
Phone: 1-303-325-5185
Fax: 1-888-702-0049
Website: www.aimehq.org

Dylan Rowley <drowley0160@gmail.com>
To: Michele Lawrie-Munro <lawriemunro@aimehq.org>

Fri, Jul 11, 2014 at 7:54 AM

Good Morning Michele,

Here is my citation that I have for that publication. Also is the figure I am using. I hope it helps.

Gaudin, A., Grob, J., & Henderson, H. (1931). Effect of Particle Size in Flotation. AIME Volume: No. 414.

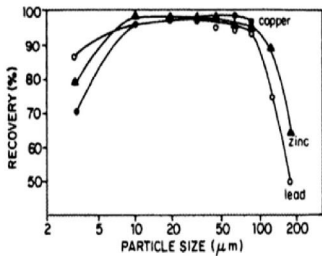

Dylan
[Quoted text hidden]
Dylan Rowley
Virginia Tech
Mining and Minerals Engineering

Michele Lawrie-Munro <lawriemunro@aimehq.org>
To: "kral@smenet.org" <kral@smenet.org>, "drowley0160@gmail.com" <drowley0160@gmail.com>

Fri, Jul 11, 2014 at 8:12 AM

Thanks for the figure, etc. below, Dylan. I did have the title slightly wrong, but, unfortunately, I am still not finding the paper in either AIME's or SME's digital library. So, I am copying the Managing Editor of SME's publications group, Steve Kral, to see if they can hunt it down there at the building and grant you the permission you need (AIME transferred all copyrights to SME when it became a separate entity in 1985). If they can't find it, I'm happy to provide permission so that you can move forward.

All the best with your studies,
Michele

L. Michele Lawrie-Munro, CAE
 Executive Director
 American Institute of Mining, Metallurgical, and Petroleum Engineers, Inc. (AIME)
 12999 East Adam Aircraft Circle
 Englewood, CO 80112
 Email: lawriemunro@aimehq.org
 Phone: 1-303-325-5185
 Fax: 1-888-702-0049
 Website: www.aimehq.org

From: Dylan Rowley [mailto:drowley0160@gmail.com]
Sent: Friday, July 11, 2014 5:55 AM
To: Michele Lawrie-Munro
Subject: Re: AIME Permission for Picture Use in Your Thesis

[Quoted text hidden]

Dylan Rowley <drowley0160@gmail.com>
 To: Michele Lawrie-Munro <lawriemunro@aimehq.org>

Fri, Jul 11, 2014 at 8:15 AM

Okay, sounds good. Thank you Michele. Just let me know what happens.

Dylan
 [Quoted text hidden]

Steve Kral <kral@smenet.org>
 To: Michele Lawrie-Munro <lawriemunro@aimehq.org>, "Dylan Rowley" <drowley0160@gmail.com>

Fri, Jul 11, 2014 at 9:32 AM

Dylan,

Our library is being redone so I could not find the paper. However, you have our permission to use the figure with proper attribution to SME-AIME.

Steve

Steve Kral, Editor
 Mining Engineering Magazine
 Tunneling & Underground Construction Magazine
 Society for Mining, Metallurgy and Exploration, Inc.
 12999 E. Adam Aircraft Circle
 Englewood, CO 80112-4167
 Phone 303-948-4245
 Fax 303-973-3845
 E-mail kral@smenet.org
 Web site www.smenet.org

On 7/11/14 6:12 AM, "Michele Lawrie-Munro" <lawriemunro@aimehq.org> wrote:

Thanks for the figure, etc. below, Dylan. I did have the title slightly wrong, but, unfortunately, I am still not finding the paper in either AIME's or SME's digital library. So, I am copying the Managing Editor of SME's publications group, Steve Kral, to see if they can hunt it down there at the building and grant you the permission you need (AIME transferred all copyrights to SME when it became a separate entity in 1985). If they can't find it, I'm happy to provide permission so that you can move forward.

All the best with your studies,
 Michele

L. Michele Lawrie-Munro, CAE
 Executive Director
 American Institute of Mining, Metallurgical, and Petroleum Engineers, Inc. (AIME)
 12999 East Adam Aircraft Circle
 Englewood, CO 80112
 Email: lawriemunro@aimehq.org
 Phone: 1-303-325-5185
 Fax: 1-888-702-0049
 Website: www.aimehq.org <<http://www.aimehq.org/>>

From: Dylan Rowley [mailto:drowley0160@gmail.com]
Sent: Friday, July 11, 2014 5:55 AM
To: Michele Lawrie-Munro
Subject: Re: AIME Permission for Picture Use in Your Thesis

Good Morning Michele,

Here is my citation that I have for that publication. Also is the figure I am using. I hope it helps.

Gaudin, A., Grob, J., & Henderson, H. (1931). Effect of Particle Size in Flotation. AIME Volume: No. 414.

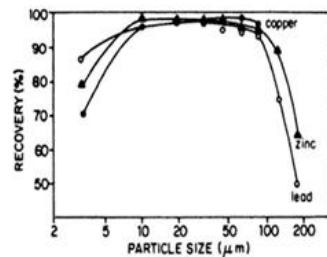

Dylan

On Fri, Jul 11, 2014 at 4:22 AM, Michele Lawrie-Munro <lawriemunro@aimehq.org> wrote:

Many thanks for your call today, Dylan, re: the above. I have looked in our digital library for the reference below that you gave me and cannot find it among the 60 references of articles by Gaudin. I wanted to ensure I took down all of the details properly? Also, it would be helpful if you could provide a figure or page number in your reply as well. Let me know if anything isn't correct.

"Effect of particle size on flotation" by Gaudin, Volume 414 from 1931.

Michele

L. Michele Lawrie-Munro, CAE
 Executive Director
 American Institute of Mining, Metallurgical, and Petroleum Engineers, Inc. (AIME)
 12999 East Adam Aircraft Circle
 Englewood, CO 80112
 Email: lawriemunro@aimehq.org
 Phone: 1-303-325-5185 <tel:1-303-325-5185>
 Fax: 1-888-702-0049 <tel:1-888-702-0049>
 Website: www.aimehq.org <http://www.aimehq.org/>

Dylan Rowley <drowley0160@gmail.com>
 To: Steve Kral <kral@smeret.org>

Fri, Jul 11, 2014 at 11:49 AM

Thank you Steve. I just found two additional sources I've used that are tables. The citations are below along with the table. Can you provide permission for me to use these in my thesis as well?

Miller, J., & Van Camp, M. (1982). Fine Coal Flotation in Centrifugal Field With an Air Sparged Hydrocyclone. SME Mining Engineering, 1575-1580

Table 2.2. Ash Removal Comparisons between Separation Technologies (Miller & Van Camp, 1982).

Mesh Size	WOC	Ash Removal (Percent)			
		Single Stage Flotation	Air Sparged Hydrocyclone Unit		
			Illinois 6	Beaver Creek	Lower Kittinging
28x100	60-65	50-60	77-86	84.2	70.4
100x200	40-45	40-45	59-68	70.2	39.6
200x325	15-18	40-45	44-62	77	42.5
-325	0-5	50-55	57-67	81	54

Miller, J., Misra, M., & Gopalakrishnan, S. (1985). Fine Gold Flotation From Colorado River Sand with the Air Sparged Hydrocyclone. SME-AIME. Albuquerque: Society of Mining Engineers of AIME.

ASH Parameters		
Design Variables		
Cyclone Diameter	5	cm
Cyclone Length	52.5	cm
Pore Size	1	micron
Pedestal Diameter	4.25	cm
Operating Parameters		
Promoter	0.05	g/kg
Collector	0.08	g/kg
Frother	0.1	g/kg
Air Flow Rate	100	slpm
Solids Feed Rate	1	tph
Percent Solids	16	%

Comparison of Flotation Methods on Gold Ore						
	Air Sparged Hydrocyclone			Conventional Batch Flotation		
	Stream	Weight %	Grade	Recovery	Weight %	Grade
Concentrate	0.39	2.17	80.98	0.7	1.075	55.81
Tail	99.61	0.002	19.02	99.3	0.006	44.19
Feed	100	0.01	100	100	0.014	100

Thank you,

Dylan
[Quoted text hidden]

Dylan Rowley
Virginia Tech
Mining and Minerals Engineering

Steve Kral <kral@smenet.org>
To: Dylan Rowley <drowley0160@gmail.com>

Fri, Jul 11, 2014 at 12:00 PM

Yes, you have our permission.

On 7/11/14 9:49 AM, "Dylan Rowley" <drowley0160@gmail.com> wrote:

Thank you Steve. I just found two additional sources I've used that are tables. The citations are below along with the table. Can you provide permission for me to use these in my thesis as well?

Miller, J., & Van Camp, M. (1982). Fine Coal Flotation in Centrifugal Field With an Air Sparged Hydrocyclone. SME Mining Engineering, 1575-1580
Table 2.2. Ash Removal Comparisons between Separation Technologies (Miller & Van Camp, 1982).

Ash Removal (Percent)					
Mesh Size	WOC	Single Stage Flotation	Air Sparged Hydrocyclone Unit		
			Illinois 6	Beaver Creek	Lower Kittanning
28x100	60-65	50-60	77-86	84.2	70.4
100x200	40-45	40-45	59-68	70.2	39.6
200x325	15-18	40-45	44-62	77	42.5
-325	0-5	50-55	57-67	81	54

Miller, J., Misra, M., & Gopalakrishnan, S. (1985). Fine Gold Flotation From Colorado River Sand with the Air Sparged Hydrocyclone. SME-AIME. Albuquerque: Society of Mining Engineers of AIME.

ASH Parameters

Design Variables

Cyclone Diameter	5	cm
Cyclone Length	52.5	cm
Pore Size	1	micron
Pedestal Diameter	4.25	cm
Operating Parameters		
Promoter	0.05	g/kg
Collector	0.08	g/kg
Frother	0.1	g/kg
Air Flow Rate	100	slpm
Solids Feed Rate	1	tph
Percent Solids	16	%

Comparison of Flotation Methods on Gold Ore

Stream	Air Sparged Hydrocyclone			Conventional Batch Flotation		
	Weight %	Grade	Recovery	Weight %	Grade	Recovery
Concentrate	0.39	2.17	80.98	0.7	1.075	55.81
Tail	99.61	0.002	19.02	99.3	0.006	44.19
Feed	100	0.01	100	100	0.014	100

Thank you,

Dylan

On Fri, Jul 11, 2014 at 9:32 AM, Steve Kral <kral@smenet.org> wrote:

Dylan,

Our library is being redone so I could not find the paper. However, you have our permission to use the figure with proper attribution to SME-AIME.

Steve

Steve Kral, Editor
 Mining Engineering Magazine
 Tunneling & Underground Construction Magazine
 Society for Mining, Metallurgy and Exploration, Inc.
 12999 E. Adam Aircraft Circle
 Englewood, CO 80112-4167
 Phone 303-948-4245 <tel:303-948-4245>
 Fax 303-973-3845 <tel:303-973-3845>
 E-mail kral@smenet.org <http://kral@smenet.org>
 Web site www.smenet.org <http://www.smenet.org>

On 7/11/14 6:12 AM, "Michele Lawrie-Munro" <lawriemunro@aimehq.org <http://lawriemunro@aimehq.org>> wrcte:

Thanks for the figure, etc. below, Dylan. I did have the title slightly wrong, but, unfortunately, I am still not finding the paper in either AIME's or SME's digital library. So, I am copying the Managing Editor of SME's publications group, Steve Kral, to see if they can hunt it down there at the building and grant you the permission you need (AIME transferred all copyrights to SME when it became a separate entity in 1985). If they can't find it, I'm happy to provide permission so that you can move forward.

All the best with your studies,
 Michele

L Michele Lawrie-Munro, CAE
 Executive Director
 American Institute of Mining, Metallurgical, and Petroleum Engineers, Inc. (AIME)
 12999 East Adam Aircraft Circle
 Englewood, CO 80112
 Email: lawriemunro@aimehq.org <http://lawriemunro@aimehq.org>
 Phone: 1-303-325-5185 <tel:1-303-325-5185>

Fax: 1-888-702-0049 <tel:1-888-702-0049>
 Website: www.aimehq.org <http://www.aimehq.org> <http://www.aimehq.org/>

From: Dylan Rowley [mailto:drowley0160@gmail.com]
Sent: Friday, July 11, 2014 5:55 AM
To: Michele Lawrie-Munro
Subject: Re: AIME Permission for Picture Use in Your Thesis

Good Morning Michele,

Here is my citation that I have for that publication. Also is the figure I am using. I hope it helps.

Gaudin, A., Grob, J., & Henderson, H. (1931). Effect of Particle Size in Flotation. AIME Volume: No. 414.

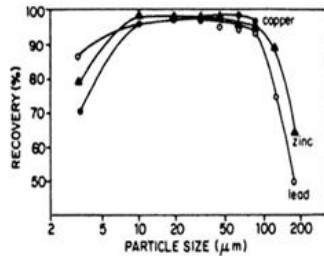

Dylan

On Fri, Jul 11, 2014 at 4:22 AM, Michele Lawrie-Munro <lawriemunro@aimehq.org <http://lawriemunro@aimehq.org>> wrote:

Many thanks for your call today, Dillon, re: the above. I have looked in our digital library for the reference below that you gave me and cannot find it among the 60 references of articles by Gaudin. I wanted to ensure I took down all of the details properly? Also, if would be helpful if you could provide a figure or page number in your reply as well. Let me know if anything isn't correct.

"Effect of particle size on flotation" by Gaudin, Volume 414 from 1931.

Michele

L. Michele Lawrie-Munro, CAE
 Executive Director
 American Institute of Mining, Metallurgical, and Petroleum Engineers, Inc. (AIME)
 12999 East Adam Aircraft Circle
 Englewood, CO 80112
 Email: lawriemunro@aimehq.org <http://lawriemunro@aimehq.org>
 Phone: 1-303-325-5185 <tel:1-303-325-5185> <tel:1-303-325-5185 <tel:1-303-325-5185>>
 Fax: 1-888-702-0049 <tel:1-888-702-0049> <tel:1-888-702-0049 <tel:1-888-702-0049>>
 Website: www.aimehq.org <http://www.aimehq.org> <http://www.aimehq.org/>

Dylan Rowley <drowley0160@gmail.com>
 To: Steve Kral <kral@smeret.org>

Mon, Jul 14, 2014 at 10:05 AM

Good Morning Steve,

I am sorry to bother you again about permissions. I have one more work I need approve for copyright permission. The citation and figure is listed below. Thank you.

Luttrell, G., Kohmuench, J., Stanley, F., & Davis, V. (1999). Technical and Economic Considerations in the Design of Column Flotation Circuits for the Coal Industry. SME Annual Meeting. Denver: Society for Mining, Metallurgy, and Exploration

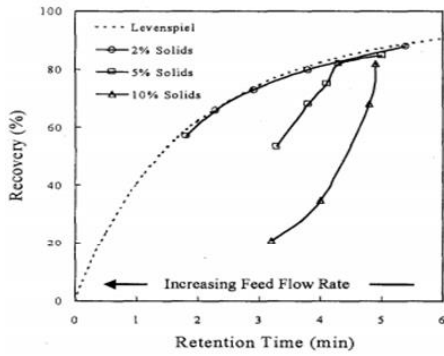

Very Respectfully,

Dylan Rowley

[Quoted text hidden]

Dylan Rowley
Virginia Tech
Mining and Minerals Engineering

Steve Kral <kral@smenet.org>
To: Dylan Rowley <drowley0160@gmail.com>

Mon, Jul 14, 2014 at 10:16 AM

You have our permission, Dylan.

On 7/14/14 8:05 AM, "Dylan Rowley" <drowley0160@gmail.com> wrote:

Good Morning Steve,

I am sorry to bother you again about permissions. I have one more work I need approve for copyright permission. The citation and figure is listed below. Thank you.

Luttrell, G., Kohmuench, J., Stanley, F., & Davis, V. (1999). Technical and Economic Considerations in the Design of Column Flotation Circuits for the Coal Industry. SME Annual Meeting. Denver: Society for Mining, Metallurgy, and Exploration

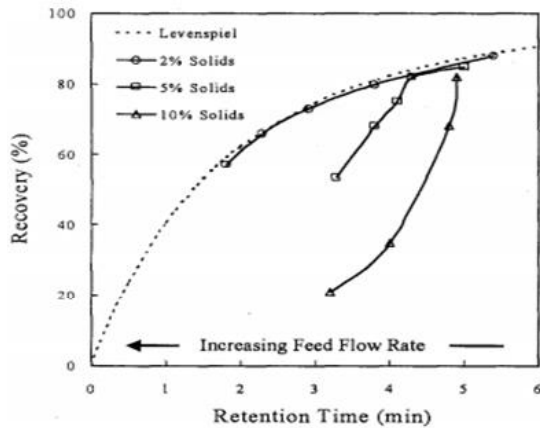

Very Respectfully,

Dylan Rowley

On Fri, Jul 11, 2014 at 12:00 PM, Steve Kral <kral@smenet.org> wrote:

Yes, you have our permission.

On 7/11/14 9:49 AM, "Dylan Rowley" <drowley0160@gmail.com <<http://drowley0160@gmail.com>> > wrote:

Thank you Steve. I just found two additional sources I've used that are tables. The citations are below along with the table. Can you provide permission for me to use these in my thesis as well?

Miller, J., & Van Camp, M. (1982). Fine Coal Flotation in Centrifugal Field With an Air Sparged Hydrocyclone. SME Mining Engineering, 1575-1580

Table 2.2. Ash Removal Comparisons between Separation Technologies (Miller & Van Camp, 1982).

Mesh Size	WOC	Single Stage Flotation	Ash Removal (Percent)		
			Air Sparged Hydrocyclone Unit		
			Illinois 6	Beaver Creek	Lower Kittanning
28x100	60-65	50-60	77-86	84.2	70.4
100x200	40-45	40-45	59-68	70.2	39.6
200x325	15-18	40-45	44-62	77	42.5
-325	0-5	50-55	57-67	81	54

Miller, J., Misra, M., & Gopalakrishnan, S. (1985). Fine Gold Flotation From Colorado River Sand with the Air Sparged Hydrocyclone. SME-AIME. Albuquerque: Society of Mining Engineers of AIME.

ASH Parameters		
Design Variables		
Cyclone Diameter	5	cm
Cyclone Length	52.5	cm
Pore Size	1	micron
Pedestal Diameter	4.25	cm
Operating Parameters		
Promoter	0.05	g/kg
Collector	0.08	g/kg
Frother	0.1	g/kg
Air Flow Rate	100	slpm
Solids Feed Rate	1	tph
Percent Solids	16	%

Comparison of Flotation Methods on Gold Ore						
Stream	Air Sparged Hydrocyclone			Conventional Batch Flotation		
	Weight %	Grade	Recovery	Weight %	Grade	Recovery
Concentrate	0.39	2.17	80.98	0.7	1.075	55.81
Tail	99.61	0.002	19.02	99.3	0.006	44.19
Feed	100	0.01	100	100	0.014	100

Thank you,

Dylan

On Fri, Jul 11, 2014 at 9:32 AM, Steve Kral <kral@smenet.org <<http://kral@smenet.org>>> wrote:

Dylan,

Our library is being redone so I could not find the paper. However, you have our permission to use the figure with proper attribution to SME-AIME.

Steve

Steve Kral, Editor
 Mining Engineering Magazine
 Tunneling & Underground Construction Magazine
 Society for Mining, Metallurgy and Exploration, Inc.
 12999 E. Adam Aircraft Circle
 Englewood, CO 80112-4167
 Phone 303-948-4245 <tel:303-948-4245> <tel:303-948-4245 <tel:303-948-4245> >
 Fax 303-973-3845 <tel:303-973-3845> <tel:303-973-3845 <tel:303-973-3845> >
 E-mail kral@smenet.org <<http://kral@smenet.org>> <<http://kral@smenet.org>>
 Web site www.smenet.org <<http://www.smenet.org>> <<http://www.smenet.org>>

On 7/11/14 6:12 AM, "Michele Lawrie-Munro" <lawriemunro@aimehq.org> <<http://lawriemunro@aimehq.org>> wrote:

Thanks for the figure, etc. below, Dylan. I did have the title slightly wrong, but, unfortunately, I am still not finding the paper in either AIME's or SME's digital library. So, I am copying the Managing Editor of SME's publications group, Steve Kral, to see if they can hunt it down there at the building and grant you the permission you need (AIME transferred all copyrights to SME when it became a separate entity in 1985). If they can't find it, I'm happy to provide permission so that you can move forward.

All the best with your studies,
 Michele

L. Michele Lawrie-Munro, CAE
 Executive Director
 American Institute of Mining, Metallurgical, and Petroleum Engineers, Inc. (AIME)
 12999 East Adam Aircraft Circle
 Englewood, CO 80112
 Email: lawriemunro@aimehq.org <<http://lawriemunro@aimehq.org>> <<http://lawriemunro@aimehq.org>>
 Phone: 1-303-325-5185 <tel:1-303-325-5185> <tel:1-303-325-5185 <tel:1-303-325-5185>>
 Fax: 1-888-702-0049 <tel:1-888-702-0049> <tel:1-888-702-0049 <tel:1-888-702-0049> >
 Website: www.aimehq.org <<http://www.aimehq.org>> <<http://www.aimehq.org>> <<http://www.aimehq.org>>

From: Dylan Rowley [mailto:drowley0160@gmail.com]
Sent: Friday, July 11, 2014 5:55 AM
To: Michele Lawrie-Munro
Subject: Re: AIME Permission for Picture Use in Your Thesis

Good Morning Michele,

Here is my citation that I have for that publication. Also is the figure I am using. I hope it helps.

Gaudin, A., Grob, J., & Henderson, H. (1931). Effect of Particle Size in Flotation. AIME Volume: No. 414.

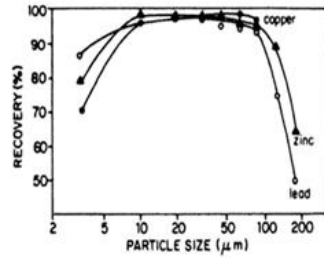

Dylan

On Fri, Jul 11, 2014 at 4:22 AM, Michele Lawrie-Munro <lawriemunro@aimehq.org>
<<http://lawriemunro@aimehq.org>> <<http://lawriemunro@aimehq.org>> wrote:

Many thanks for your call today, Dillon, re: the above. I have looked in our digital library for the reference below that you gave me and cannot find it among the 60 references of articles by Gaudin. I wanted to ensure I took down all of the details properly? Also, if would be helpful if you could provide a figure or page number in your reply as well. Let me know if anything isn't correct.

"Effect of particle size on flotation" by Gaudin, Volume 414 from 1931.

Michele

L. Michele Lawrie-Munro, CAE
Executive Director
American Institute of Mining, Metallurgical, and Petroleum Engineers, Inc. (AIME)
12999 East Adam Aircraft Circle
Englewood, CO 80112
Email: lawriemunro@aimehq.org <<http://lawriemunro@aimehq.org>> <<http://lawriemunro@aimehq.org>>
Phone: 1-303-325-5185 <tel:1-303-325-5185> <tel:1-303-325-5185 <tel:1-303-325-5185>> <tel:1-303-325-5185 <tel:1-303-325-5185>> <tel:1-303-325-5185 <tel:1-303-325-5185>>>
Fax: 1-888-702-0049 <tel:1-888-702-0049> <tel:1-888-702-0049 <tel:1-888-702-0049>> <tel:1-888-702-0049 <tel:1-888-702-0049>>>
Website: www.aimehq.org <<http://www.aimehq.org>> <<http://www.aimehq.org>>
<<http://www.aimehq.org>>



Dylan Rowley <drowley0160@gmail.com>

DE/GCOP/P1611

1 message

East, Deborah <Deborah.East@tandf.co.uk>
To: Dylan Rowley <drowley0160@gmail.com>

Mon, Jul 14, 2014 at 4:52 AM

Our Ref: DE/GCOP/P1611

Date: 11th July 2014

Dear Dylan Rowley,

Thank you for your correspondence requesting permission to reproduce the following material from our Journal in your printed thesis at **Virginia Tech** entitled "**Investigation of Flash Flotation Technology Utilizing Centrifugal Forces and Novel Sparging Methods**" and to be posted in your university's repository.

Material Requested: 2 x Figures from - Assessment of the Controlling Factors in Turbo Flotation by Statistical Analysis – Coal Preparation – Volume 21 Issue 4 PP 355-382 – Authors – P. K. Ofori, B. A. Firth & T. Howes

We will be pleased to grant entirely free permission on the condition that you acknowledge the original source of publication and insert a reference to the Journal's web site:
www.tandfonline.com

Please note that this licence does not allow you to post our content on any third party websites or repositories.

Thank you for your interest in our Journal.

Yours sincerely

Debbie East.

Debbie East- Permissions & Licence Administrator - Journals.

Routledge, Taylor & Francis Group.

3 Park Square, Milton Park, Abingdon, Oxon, OX14 4RN, UK.

Tel : +44(0)20 7017 6960

Fax: +44 (0)20 7017 6336

Web: www.tandfonline.com

E-mail: deborah.east@tandf.co.uk _

Taylor & Francis is a trading name of Informa UK Limited,
registered in England under no. 1072954



Visit <http://www.tandf.co.uk/eupdates> to receive email updates about journals, books and other news within your areas of interest.

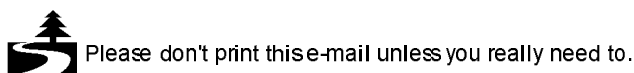

Please don't print this e-mail unless you really need to.

From: Dylan Rowley [<mailto:drowley0160@gmail.com>]

Sent: 11 July 2014 15:28

To: East, Deborah

Subject: Re: gcop19:Assessment of the Controlling Factors in Turbo Flotation by Statistical Analysis

I attend Virginia Tech and the title of my thesis is "Investigation of Flash Flotation Technology Utilizing

Centrifugal Forces and Novel Sparging Methods". Do you need any other sort of proof that I attend? Please let me know. Thank you.

Dylan

On Fri, Jul 11, 2014 at 10:25 AM, East, Deborah <Deborah.East@tandf.co.uk> wrote:

Dear Dylan, Please can I ask you to confirm if this is for your thesis ? if so can you please confirm your University that you attend and also confirm your Thesis title.

Thank you and kindest regards

Debbie East.

Debbie East– Permissions & Licence Administrator - Journals.

Routledge, Taylor & Francis Group.

3 Park Square, Milton Park, Abingdon, Oxon, OX14 4RN, UK.

Tel :+44(0)20 7017 6960

Fax: +44 (0)20 7017 6336

Web: www.tandfonline.com

E-mail: deborah.east@tandf.co.uk

Taylor & Francis is a trading name of Informa UK Limited,
registered in England under no. 1072954



Visit <http://www.tandf.co.uk/eupdates> to receive email updates about journals, books and other news

within your areas of interest.



Please don't print this e-mail unless you really need to.

From: Dylan Rowley [mailto:drowley0160@gmail.com]
Sent: 11 July 2014 13:35
To: Academic UK Non Rightslink
Subject: gcop19:Assessment of the Controlling Factors in Turbo Flotation by Statistical Analysis

Permissions Request

Contact name: Dylan Rowley

Street address: 1781 old buckhead rd

Town: Madison

Postcode/ZIP code: 30650

Country: United States

Contact telephone number: 7068181587

Contact email address: drowley0160@gmail.com

Article title: Assessment of the Controlling Factors in Turbo Flotation by Statistical Analysis

Article DOI: 10.1080/07349340008945626

Author name: P. K. OFORI, B. A. FIRTH, T. HOWES

Journal title: Coal Preparation

Volume number: 21

Issue number: 4

Year of publication: 2000

Page number(s): 355-382

Are you the sole author/editor of the new publication?: No

Are you requesting the full article?: No

If no, please supply extract and include number of word:

If no, please supply details of figure/table: I am requesting use of two figures. The first figure is a diagram of the Turbo Flotation System. The second is a the Yield vs. Ash graph where Ofori compares the Turbo Flotation results to traditional flotation techniques.

Name of publisher of new publication: Virginia Tech

Title of new publication: Investigation of Flash Flotation Technology Utilizing Centrifugal Forces and Novel Sparging Methods

Course pack: No

Number of Students:

Is print:

Electronic: Yes

E-reserve: No

Period of use:

Short loan library?: No

Thesis: Yes

To be reprinted in a new publication?: No

In print format:

In eBook format?:

ISBN:

Languages:

Distribution quantity:

Retail price:

Additional comments:

--
Dylan Rowley
Virginia Tech
Mining and Minerals Engineering



Dylan Rowley <drowley0160@gmail.com>

FLSmidth Image Permission

7 messages

Andrew Cuthbert <Andrew.Cuthbert@flsmidth.com>
To: "drowley0160@gmail.com" <drowley0160@gmail.com>
Cc: Andrew Cuthbert <Andrew.Cuthbert@flsmidth.com>

Thu, Jul 10, 2014 at 1:09 PM

Thank you for your interest in our company and the request for use of FLSmidth images for your thesis statement.

Because images, photos and illustrations are part of FLSmidth's intellectual property and branded image, would you please first fill out the attached permission form and then scan and send back to my attention. If you do not have a scanner, you can take a clear photo on your mobile device and email it. If you are not sure of all the things to fill in, you can leave that to me. The main part is your name, title, company/educational institution and signature.

Once we have received the signed FLSmidth Copyright Use Permission Agreement, we can send better versions of the images your way for use in your upcoming papers and presentations.

Thank you and regards,

Andrew Cuthbert
Director - Global Marketing, Minerals

Direct +1 801 871 7105
andrew.cuthbert@flsmidth.com

FLSmidth

FLSmidth USA Inc. · Salt Lake City Operations

7158 S. FLSmidth Drive · Midvale, UT 84047-5559 · USA
Tel +1 801 871 7000 · Fax +1 801 871 7001

www.flsmidth.com

Ref: Thiele Kaolin +1 478 552 3951

 **FLSmidthImagePermission2014.pdf**
41K

Dylan Rowley <drowley0160@gmail.com>
To: Andrew Cuthbert <Andrew.Cuthbert@flsmidth.com>

Thu, Jul 10, 2014 at 1:27 PM

Hi Andrew,

Thank you for the form. I just found another FL Smidth picture I used for the same purpose. It is a picture of a Krebs Hydrocyclone and it is cut in half to show what happens inside the hydrocyclone. I do not have a source for it as I found it through the internet but could not find it on your website. Would I need to fill out two separate forms or just complete one form and return it to you.

Thank you for your help.

Dylan

[Quoted text hidden]

--

Dylan Rowley
Virginia Tech
Mining and Minerals Engineering

Andrew Cuthbert <Andrew.Cuthbert@flsmidth.com>
To: Dylan Rowley <drowley0160@gmail.com>

Thu, Jul 10, 2014 at 1:38 PM

One form is fine. Thanks,

Andrew Cuthbert
Director - Global Marketing, Minerals

Direct +1 801 871 7105 · Mobile +1 801 647 4772
andrew.cuthbert@flsmidth.com

FLSmidth
FLSmidth USA Inc. · Salt Lake City Operations

7158 S. FLSmidth Drive · Midvale, UT 84047-5559 · USA

Tel +1 801 871 7000 · Fax +1 801 871 7001

www.flsmidth.com

From: Dylan Rowley [mailto:drowley0160@gmail.com]
Sent: Thursday, July 10, 2014 11:27 AM
To: Andrew Cuthbert
Subject: Re: FLSmidth Image Permission

[Quoted text hidden]

Dylan Rowley <drowley0160@gmail.com>
To: Andrew Cuthbert <Andrew.Cuthbert@flsmidth.com>

Thu, Jul 10, 2014 at 2:36 PM

Andrew,

Attached is the form filled out and signed. Let me know if I need to include or redo anything.

Thank you,

Dylan

On Thu, Jul 10, 2014 at 1:09 PM, Andrew Cuthbert <Andrew.Cuthbert@flsmidth.com> wrote:
[Quoted text hidden]

--
Dylan Rowley
Virginia Tech
Mining and Minerals Engineering

 **Rowley, Dylan Copyright Use.pdf**
294K

Andrew Cuthbert <Andrew.Cuthbert@flsmidth.com>
To: Dylan Rowley <drowley0160@gmail.com>

Thu, Jul 10, 2014 at 2:38 PM

Perfect. Thanks. Good luck with your thesis.

Andrew Cuthbert
Director - Global Marketing, Minerals

Direct +1 801 871 7105
andrew.cuthbert@flsmidth.com

FLSmidth

FLSmidth USA Inc. · Salt Lake City Operations

7158 S. FLSmidth Drive · Midvale, UT 84047-5559 · USA
Tel +1 801 871 7000 · Fax +1 801 871 7001www.flsmidth.com

From: Dylan Rowley [mailto:drowley0160@gmail.com]
Sent: Thursday, July 10, 2014 12:36 PM
To: Andrew Cuthbert
Subject: Re: FLSmidth Image Permission

Andrew,

[Quoted text hidden]

[Quoted text hidden]

Dylan Rowley <drowley0160@gmail.com>
To: Andrew Cuthbert <Andrew.Cuthbert@flsmidth.com>

Thu, Jul 10, 2014 at 2:51 PM

Thank you Andrew! Greatly appreciate your help. When can I expect back the signed form?

Dylan

[Quoted text hidden]

Andrew Cuthbert <Andrew.Cuthbert@flsmidth.com>
To: Dylan Rowley <drowley0160@gmail.com>

Thu, Jul 10, 2014 at 4:12 PM

Here you go.

Andrew Cuthbert

Director - Global Marketing, Minerals

Direct +1 801 871 7105
andrew.cuthbert@flsmidth.com

FLSmidth

FLSmidth USA Inc. · Salt Lake City Operations

7158 S. FLSmidth Drive · Midvale, UT 84047-5559 · USA

Tel +1 801 871 7000 · Fax +1 801 871 7001

www.flsmidth.com

From: Dylan Rowley [mailto:drowley0160@gmail.com]

Sent: Thursday, July 10, 2014 12:52 PM

[Quoted text hidden]

[Quoted text hidden]

 **FLSmidthCopyrightPermissionDRowley.pdf**
139K



FLSmidth – Copyright Use Permission Agreement

This Copyright Use Permission Agreement ("*Agreement*") permits the *Grantee* to use the *Materials* for the *Purpose*. In consideration for the rights granted herein, the *Grantee* agrees to the following terms and conditions:

1. *Grantee* agrees that FLSmidth USA Inc. or its parent company FLSmidth A/S (hereinafter "FLSmidth"), as the case may be, is the owner of all intellectual property related to the *Materials*, including without limitation, copyrights, tradenames, trademarks and other such rights.
2. FLSmidth shall supply the *Materials* in the requested format, which shall be used by the *Grantee* for the *Purpose* only. Any subsequent use in any medium outside of the *Purpose* constitutes an unpermitted use.
3. *Grantee* may not grant other parties permission to create or distribute reproductions of the *Materials*. Unless expressly approved in advance by FLSmidth, the *Materials* must be unaltered and used in their entirety.
4. FLSmidth may revoke all permissions granted herein and may terminate this *Agreement* in the event the *Materials* are being used, in FLSmidth's sole discretion, outside of the *Purpose* and *Grantee* shall immediately cease all use of the *Materials* upon such notice of termination from FLSmidth.
5. *Grantee* agrees that the permissions granted by FLSmidth herein are non-exclusive in nature and FLSmidth retains all rights, title and interest in and to the *Materials*.
6. A credit line to acknowledge use of the *Material* is required, and shall read as one of the following examples: "Reprinted with permission of FLSmidth A/S", "Image courtesy of FLSmidth", "Photo used with permission of FLSmidth", "Shown image is the property of FLSmidth", "Copyright FLSmidth A/S" and so forth.
7. Prior to use of the *Materials*, *Grantee* shall submit to FLSmidth a draft containing the *Materials* for FLSmidth's approval, which shall not be unreasonably withheld.
8. The *Materials* are provided 'as is' with no explicit or implied warranties, including, but not limited to, correctness and fitness for purpose. In no event shall FLSmidth have any liability associated with *Grantee's* use of the *Materials*.
9. This *Agreement* shall be governed by the laws of the state of Utah, not including its conflicts of law principles. Any disputes related to this agreement shall be decided by the courts of the state of Utah and *Grantee* agrees to submit to the jurisdiction thereof.

"*Materials*" shall mean: WEMCO H+I Flotation Machine Figure, Krebs Hydrocycle Cutaway Figure

"*Purpose*" shall mean: Flotation & Hydrocyclone separation explanations for Virginia Tech Thesis

IN WITNESS WHEREOF, the parties have executed this *Agreement* on (Date) 7/10/2014

FLSMIDTH USA INC.

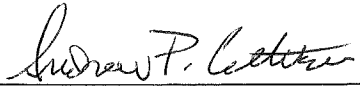
Authorized Signature 

Name ANDREW CUTHBERT

Title DIRECTOR - GLOBAL MARKETING

GRANTEE

Authorized Signature 

Name Dylan Rowley

Title Graduate Research Assistant

Company Virginia Tech - Mining and Minerals Dept.

Country United States



Dylan Rowley <drowley0160@gmail.com>

Dylan Rowley: Copyright Permission SME Handbook

7 messages

Dylan Rowley <drowley0160@gmail.com>

Thu, Jul 10, 2014 at 12:28 PM

To: olivier@smenet.org

Hi Jane,

We just spoke on the phone about the copyright for the SME Handbook. I used the images of a flotation cell in the "Fundamental Principles of Froth Flotation" by Kawatra, S.K. The pages I have listed for the section are 1517-1531. Thank you for your help.

Very Respectfully,

--

Dylan Rowley
Virginia Tech
Mining and Minerals Engineering

Jane Olivier <glacierpublishing@gmail.com>

Thu, Jul 10, 2014 at 2:31 PM

To: Dylan Rowley <drowley0160@gmail.com>

Hello Dylan,

Thank you for contacting SME about permission to repurpose the copyrighted figures from the SME Mining Engineering Handbook.

You are hereby authorized to do so providing you include a complete source line for each figure, citing the Handbook and including SME's web address: smenet.org

Regards,
Jane Olivier
Manager of Book Publishing
SME

[Quoted text hidden]

Dylan Rowley <drowley0160@gmail.com>

Thu, Jul 10, 2014 at 2:41 PM

To: Jane Olivier <glacierpublishing@gmail.com>

Hi Jane,

Thank you very much! I came across to other figures I am using in my thesis that are part of SME publications. I am including the citations below with their associated figure. I am requesting copyright permission on those as well.

Battersby, M., Brown, J., & Imhof, R. (2003). The Imhoflot G-Cell - An Advanced Pneumatic Flotation Technology for the Recovery of Coal Slurry From Impoundments. Cincinnati: Society for Mining, Metallurgy, and Exploration.

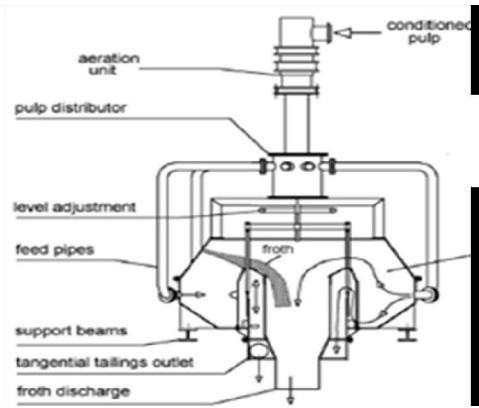

Fuerstenau, D. (1980). Fine Particle Flotation. In P. Somasundara, Fine Particles Processing (p. 671). SME-AIME.

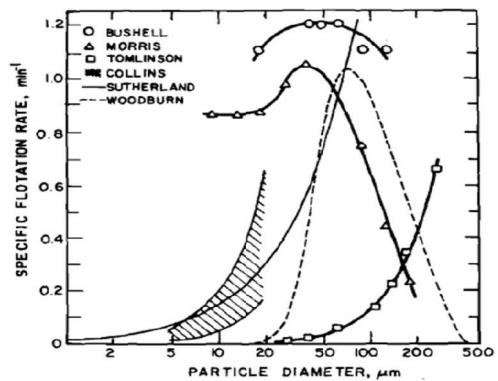

Let me know if I can use these images or if we have to go about it a different way.

Thank you very much

Dylan Rowley

[Quoted text hidden]

Jane Olivier <glacierpublishing@gmail.com>
To: Dylan Rowley <drowley0160@gmail.com>

Thu, Jul 10, 2014 at 2:52 PM

On behalf of SME, I hereby authorize the reuse of the additional two figures. Again, please include a complete citation.

Best,
Jane

On Jul 10, 2014, at 12:41 PM, Dylan Rowley <drowley0160@gmail.com> wrote:

Hi Jane,

Thank you very much! I came across to other figures I am using in my thesis that are part of SME publications. I am including the citations below with their associated figure. I am requesting copyright permission on those as well.

Battersby, M., Brown, J., & Imhof, R. (2003). The Imhoflot G-Cell - An Advanced Pneumatic Flotation Technology for the Recovery of Coal Slurry From Impoundments. Cincinnati: Society for

Mining, Metallurgy, and Exploration.

<image.png>

Fuerstenau, D. (1980). Fine Particle Flotation. In P. Somasundara, Fine Particles Processing (p. 671). SME-AIME.

<image.png>

Let me know if I can use these images or if we have to go about it a different way.

Thank you very much

Dylan Rowley

On Thu, Jul 10, 2014 at 2:31 PM, Jane Olivier <glacierpublishing@gmail.com> wrote:

Hello Dylan,

Thank you for contacting SME about permission to repurpose the copyrighted figures from the SME Mining Engineering Handbook.

You are hereby authorized to do so providing you include a complete source line for each figure, citing the Handbook and including SME's web address: smenet.org

Regards,
Jane Olivier
Manager of Book Publishing
SME

On Jul 10, 2014, at 10:28 AM, Dylan Rowley <drowley0160@gmail.com> wrote:

> Hi Jane,
>

> We just spoke on the phone about the copyright for the SME Handbook. I used the images of a flotation cell in the "Fundamental Principles of Froth Flotation" by Kawatra, S.K. The pages I have listed for the section are 1517-1531. Thank you for your help.

>
> Very Respectfully,
>
> --
> Dylan Rowley
> Virginia Tech
> Mining and Minerals Engineering

--

Dylan Rowley
Virginia Tech
Mining and Minerals Engineering

Dylan Rowley <drowley0160@gmail.com>
To: Jane Olivier <glacierpublishing@gmail.com>

Thu, Jul 10, 2014 at 2:53 PM

Awesome! Thank you Jane. I greatly appreciate your help!

[Quoted text hidden]

Dylan Rowley <drowley0160@gmail.com>
To: Jane Olivier <glacierpublishing@gmail.com>

Thu, Jul 10, 2014 at 3:46 PM

I apologize Jane for overrunning you with emails about copyright permission. I should have collected them all at once. I do have two more figures. The citation and pictures are shown below.

Ye, Y., Gopalakrishnan, S., Pacquet, E., & Miller, J. (1988). Development of the Air Sparged Hydrocyclone - A Swirl-Flow Flotation Column. Column Flotation '88 - Proceedings of an International Symposium (p. 9). Denver: SME.

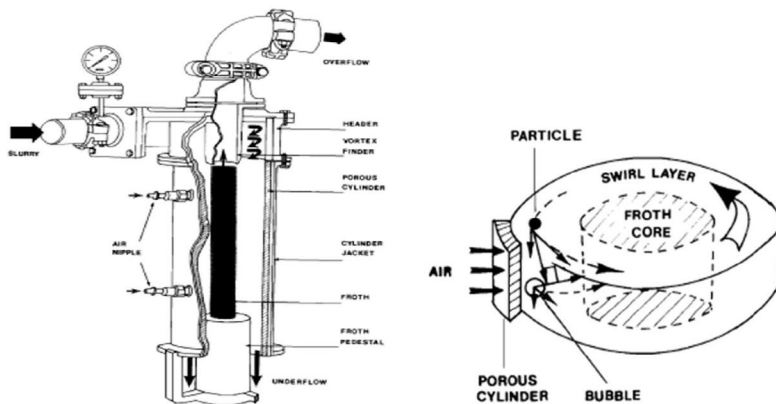

I apologize again. Thank you.

Dylan
[Quoted text hidden]

Jane Olivier <glacierpublishing@gmail.com>
To: Dylan Rowley <drowley0160@gmail.com>

Thu, Jul 10, 2014 at 3:48 PM

These too are authorized.

I must tell you though that you have reached the limit on the number of figures we allow to be repurposed, especially at no cost.

Hopefully there are no more.

On Jul 10, 2014, at 1:46 PM, Dylan Rowley <drowley0160@gmail.com> wrote:

I apologize Jane for overrunning you with emails about copyright permission. I should have collected them all at once. I do have two more figures. The citation and pictures are shown below.

Ye, Y., Gopalakrishnan, S., Pacquet, E., & Miller, J. (1988). Development of the Air Sparged Hydrocyclone - A Swirl-Flow Flotation Column. Column Flotation '88 - Proceedings of an

International Symposium (p. 9). Denver: SME.

<image.png> <image.png>

[Quoted text hidden]

[Quoted text hidden]



Dylan Rowley <drowley0160@gmail.com>

Dylan Rowley: Cavitation Tube Figure Permission

2 messages

Dylan Rowley <drowley0160@gmail.com>

Thu, Jul 10, 2014 at 1:07 PM

To: jkohmuench@eriez.com

Good Afternoon Jaisen,

I am requesting your copyright permission to use a figure of the cavitation tube in my thesis. The picture is shown below. Thank you.



--

Dylan Rowley
Virginia Tech
Mining and Minerals Engineering

Kohmuench, Jaisen <jkohmuench@eriez.com>

Thu, Jul 10, 2014 at 1:14 PM

To: Dylan Rowley <drowley0160@gmail.com>

Granted.

-Jaisen

Jaisen Kohmuench

Deputy Managing Director

Eriez Flotation Division|USA

2200 Asbury Road

Erie, PA 16506

Office: (814) 520-8428

Cell: (814) 746-5559



*****PLEASE NOTE MY NEW OFFICE PHONE NUMBER*****

From: Dylan Rowley [mailto:drowley0160@gmail.com]
Sent: Thursday, July 10, 2014 1:07 PM
To: Kohmuench, Jaisen
Subject: Dylan Rowley: Cavitation Tube Figure Permission

[Quoted text hidden]



Dylan Rowley <drowley0160@gmail.com>

Re: Dylan Rowley: Copyright Permission

2 messages

Aaron Noble <aaron.noble@mail.wvu.edu>
To: DYLAN <drowley0160@hotmail.com>

Thu, Jul 10, 2014 at 12:05 PM

Dylan,

I have no problem with you using my graph in your thesis as long as it is properly cited. I am glad that it helps.

Take care,

Dr. Aaron Noble
Assistant Professor
Mining Engineering || West Virginia University
(304) 293-9959 || canoble@mail.wvu.edu
353A Mineral Resources Building

On Wed, Jul 9, 2014 at 2:33 PM, DYLAN <drowley0160@hotmail.com> wrote:

Good Afternoon Aaron,

In my final thesis, I used your graph showing the increase in cell volume size over the years. I am requesting your permission to officially use it when I submit my thesis. Thank you.

Very Respectfully,

Dylan Rowley

Dylan Rowley <drowley0160@gmail.com>
To: Aaron Noble <aaron.noble@mail.wvu.edu>

Thu, Jul 10, 2014 at 12:06 PM

Thank you Aaron!

[Quoted text hidden]

-

Dylan Rowley
Virginia Tech
Mining and Minerals Engineering



Dylan Rowley <drowley0160@gmail.com>

Dylan Rowley: Permission to Use CAD Drawing

2 messages

Dylan Rowley <drowley0160@gmail.com>

Mon, Jul 7, 2014 at 3:12 PM

To: "Yan, Eric" <eyan@eriez.com>

Good Afternoon Eric,

I hope everything is going well. I am in the final stages of finishing my thesis and I am using the drawing of the first flotation cyclone you designed. I am requesting your permission to use said drawing in my thesis. The picture is included for your reference. Let me know if I can use it. Thank you.



Very Respectfully,

Dylan Rowley

Yan, Eric <eyan@eriez.com>

Mon, Jul 7, 2014 at 3:37 PM

To: Dylan Rowley <drowley0160@gmail.com>

Dylan,

Please do and let me know if you need any other documentation. I wish you the BEST luck!!

-eric

From: Dylan Rowley [mailto:drowley0160@gmail.com]**Sent:** Monday, July 07, 2014 3:12 PM**To:** Yan, Eric**Subject:** Dylan Rowley: Permission to Use CAD Drawing

[Quoted text hidden]

Draft 09/01/2009

(Questions? Concerns? Contact Gail McMillan, Director of the Digital Library and Archives at Virginia Tech's University Libraries: gailmac@vt.edu)

(Please ensure that Javascript is enabled on your browser before using this tool.)

Virginia Tech ETD Fair Use Analysis Results

This is not a replacement for professional legal advice but an effort to assist you in making a sound decision.

Name: Dylan Rowley

Description of item under review for fair use: Figure 1.2 Thermodynamic Description of Particle Bubble Attachment Yoon, R. (2011). Froth Flotation: Thermodynamics of Flotation. Blacksburg, Virginia.

Report generated on: 07-20-2014 at : 16:46:43

Based on the information you provided:

Factor 1

Your consideration of the purpose and character of your use of the copyright work weighs: *in favor of fair use*

Factor 2

Your consideration of the nature of the copyrighted work you used weighs: *against fair use*

Factor 3

Your consideration of the amount and substantiality of your use of the copyrighted work weighs: *in favor of fair use*

Factor 4

Your consideration of the effect or potential effect on the market after your use of the copyrighted work weighs: *in favor of fair use*

Based on the information you provided, your use of the copyrighted work weighs: *in favor of fair use*

