

TRANS
A STUDY OF MOTION AND GEOMETRY

ALIREZA BORHANI HAGHIGHI

Thesis submitted to the faculty of the Virginia Polytechnic Institute and State University in partial fulfillment of the requirements for the degree of
Master of Architecture in Architecture

Robert J. Dunay, Chair

Steve R. Thompson

William U. Galloway

Robert P. Schubert

April 30, 2012

Blacksburg, VA

Keywords: Geometry, Motion, Kinetic

Copyright Alireza Borhani Haghighi

TRANS
A STUDY OF MOTION AND GEOMETRY

ALIREZA BORHANI HAGHIGHI

ABSTRACT

A building can be conceptualized in terms of its geometry and force. Between the two concepts of Motion and Rest, architecture mostly tends towards the idea of Rest. However, mechanical form is based on the idea of Motion. Mechanics is often referred to as the geometry of motion and describes the motion of objects with consideration of force and geometry; common domains between architecture and mechanics. The way that mechanical engineers integrate motion into geometry and force can encourage architects to incorporate geometry in an unconventional method.

In architecture and mechanics, most movements have a practical purpose, but movements become poetic when they go beyond the purely practical. The poetry of a movement is not automatically a by-product of its functional or economic optimization. This book is concerned with such moving parts.

TABLE OF CONTENTS

Abstract	
Introduction	01
Design Relationship Diagram	02
A Journey from Static Geometry to Dynamic Geometry	03
ANGULUS	04
UMBRA I	05
UMBRA II	06
UMBRA III	07
UMBRA IV	09
AURA I	10
AURA II	11
AURA III	12
AURA IV	14
AURA V	15
SOL I	16
SOL II	18
OCULUS I	20
OCULUS II	22
OCULUS III	23
OCULUS IV	24
OCULUS V	25
TEXTA II	26
TEXTA III	28

IMAGE CREDITS: All images are by the author

INTRODUCTION

Geometry is beautiful for its own sake, and it is sometimes complex. When it moves, geometry is more beautiful and more elaborate. Geometry lies at the beginnings of architecture. I have spent a great part of my life in Iran, where the visible and invisible integration of geometry into arts, crafts, and architecture is very much the norm. In Persian literature, the root of the word “engineer” (in Persian: “مهندس-Mohandes”), is “geometry” (in Persian: “هندسه-Hendese”)[1]. “Mohandes” (engineer) means “one who measures and knows geometry” and is “one who designs and creates spaces based on geometry and measurement”. Although in Iranian architecture, geometry does not involve physical movement, complex geometric designs and repeating patterns create the impression of motion in static spaces and demonstrate the dynamic and vivid qualities of space. Architecture is the creation of space for people to move in, but movement has not been the main concern of buildings. Traditionally, there are quite a few elements in architecture that move, such as doors and windows. In fact, the architect’s task is to erect a building on apparently stable ground that is durable and permanent.

This book is concerned with motion and geometry. In this study, design is the research tool to integrate geometry, force and movement. Through hand sketches, computer modeling and prototyping, I examined geometric elements that are movable in terms of their purpose, composition, form and meaning. The goal is to examine movements that, on the one hand, help make our buildings more useful and, on the other hand, contribute toward richer experiences. Assume a horizontal or vertical surface (around 6’X6’) is located in front of a light source. The surface consists of a primary structure that holds some non-structural modular elements. These elements can change their positions relative to each other or in relation to the main structure. Intentionally, this surface does not have a name or particular function yet.[2] These designs are part of a brainstorming investigation, where the aim is to study the different mechanisms and geometric compositions. These designs are organized in a design relationship diagram (page 2) that demonstrates the relation between different models.

A study of motion and geometry can be organized in two categories:

The first category consists of designs where movable elements can perform individually and their movements are not related to each other. This means they can independently be in closed, open or in-between states. Therefore, this category performs a maximum variety of geometrical compositions. In the design, production, and maintenance process of this category, each element is considered as an individual piece that can perform or be replaced separately without causing disorder in the whole system. In combination, they are not conceived as geometric pattern.

The second category consists of designs that are derived directly from geometry, not only in their elements, but also in the whole system. Unlike the first category, there is an apparent geometrical pattern as a fundamental formation. In this category, each element is not an independent piece but a part of an integrated system. This interdependency of the whole system decreases the variety of potential geometric compositions but increases the sense of unity. The fact that each element is not able to move autonomously, there are different challenges related to the performance and aesthetic aspects will arise.

This study is an overture to profound research on “geometry and motion in architecture” that would be eagerly pursued by the author. This research is an opening to the topic of how geometry and movement would add value to design.

1. The word "hendesah" has derived from Persian "andazeh (andakhtan)" which has a similar meaning to "metre", principally "to put" and subsequently "to measure". “Mohandes” is a subject-name for the infinitive "hendesah".
2. In future, this study may be used in design of facades, sun shading devices or interior partitions.

DESIGN RELATIONSHIP DIAGRAM

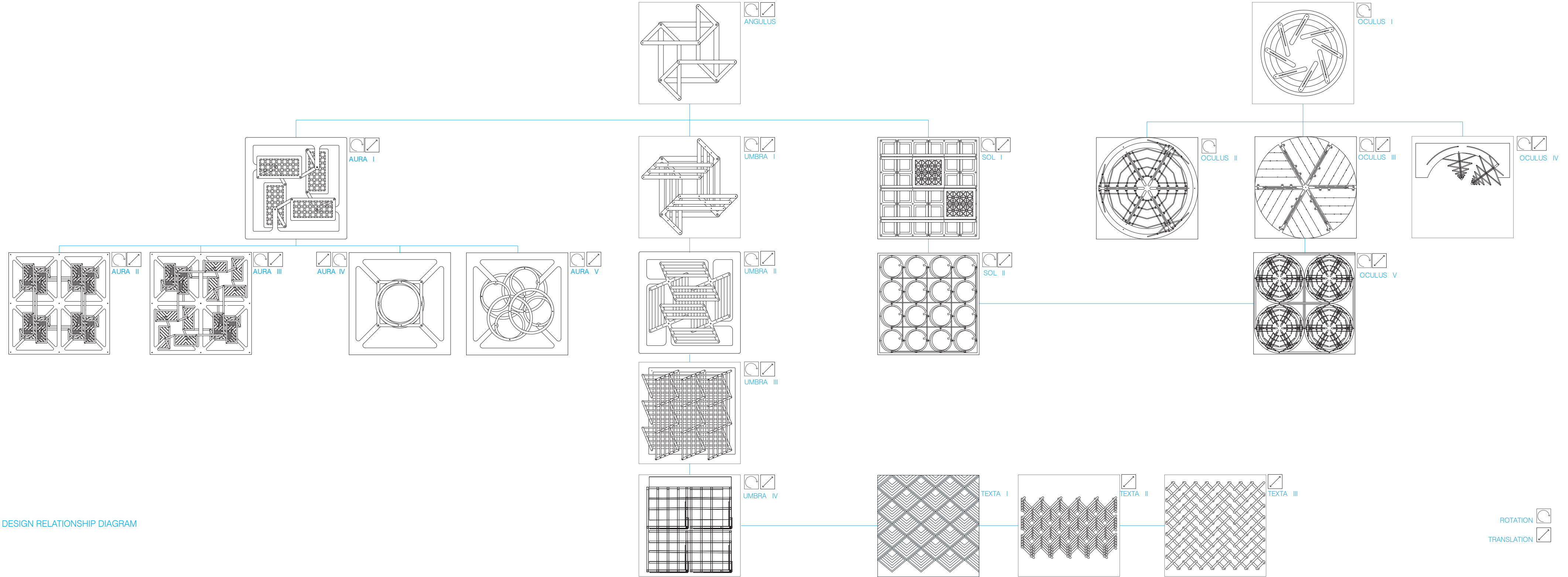

A JOURNEY FROM STATIC GEOMETRY TO DYNAMIC GEOMETRY

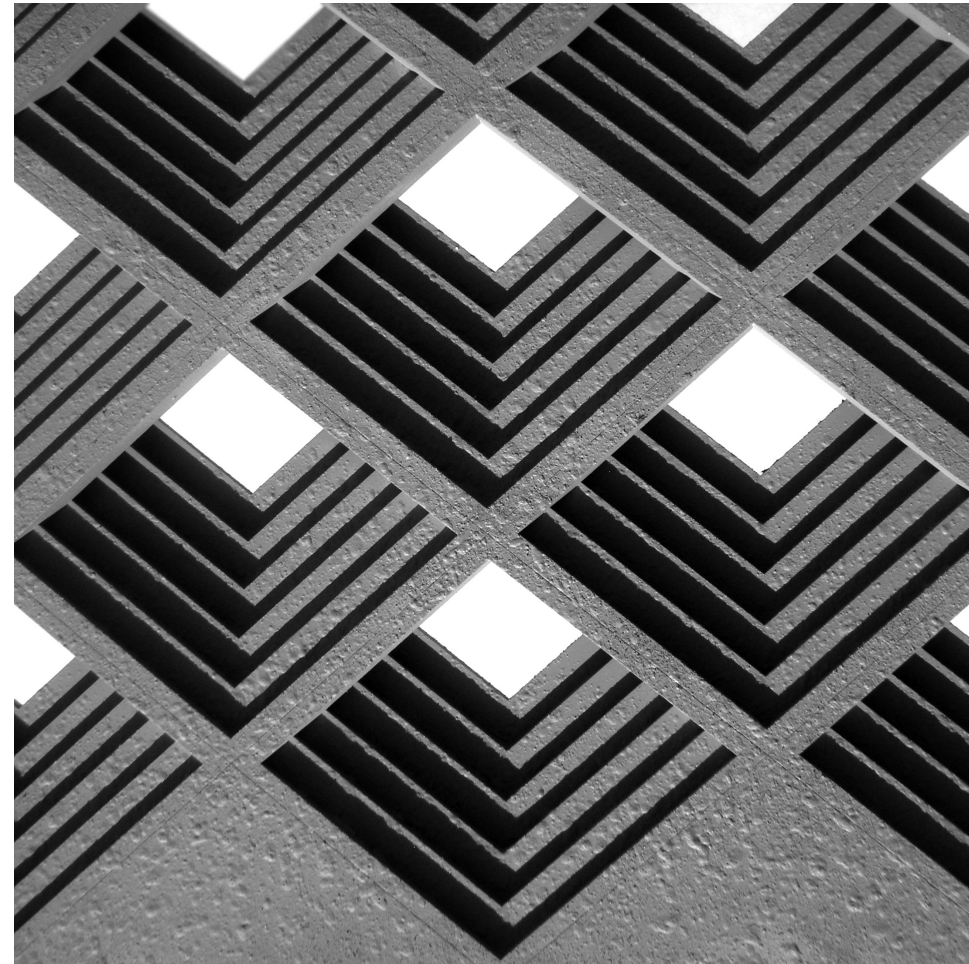

MODEL NAME : TEXTA I
DIMENSION: 20" x 20"
TYPOLOGY OF MOVEMENT : -

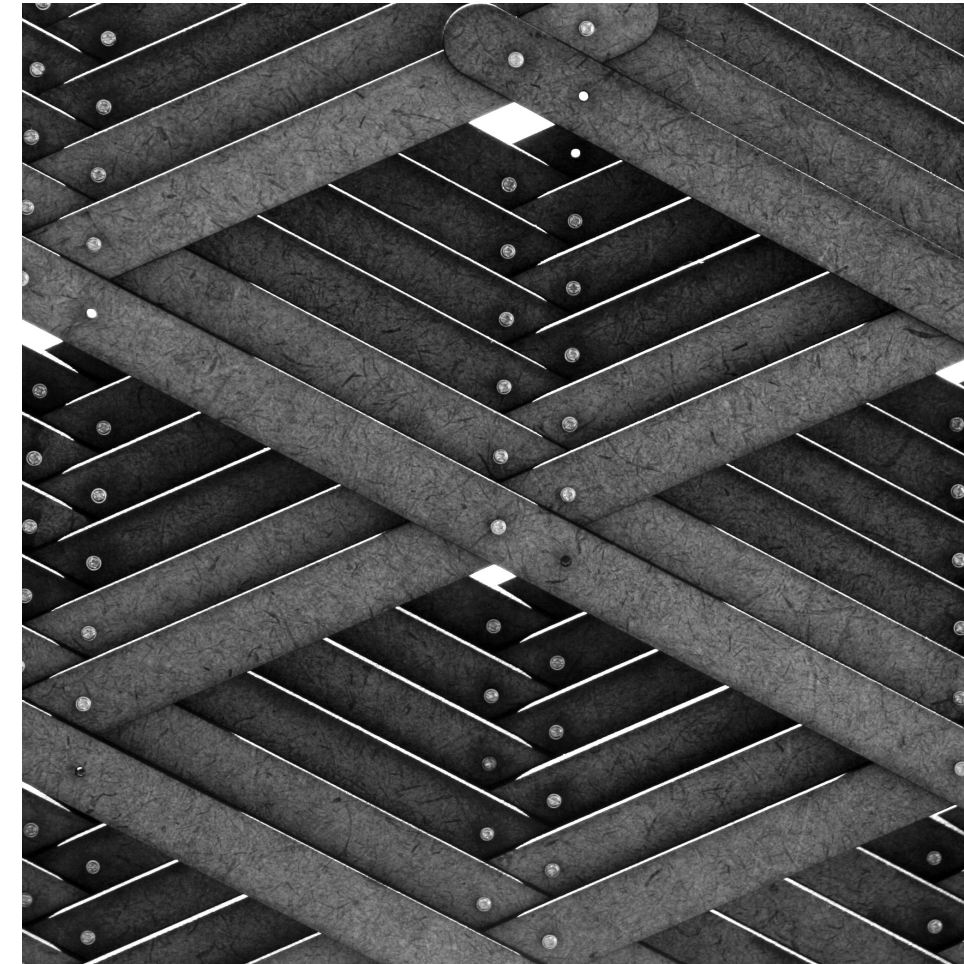

MODEL NAME : TEXTA II
DIMENSION: 20" x 20"
TYPOLOGY OF MOVEMENT : TRANSLATION

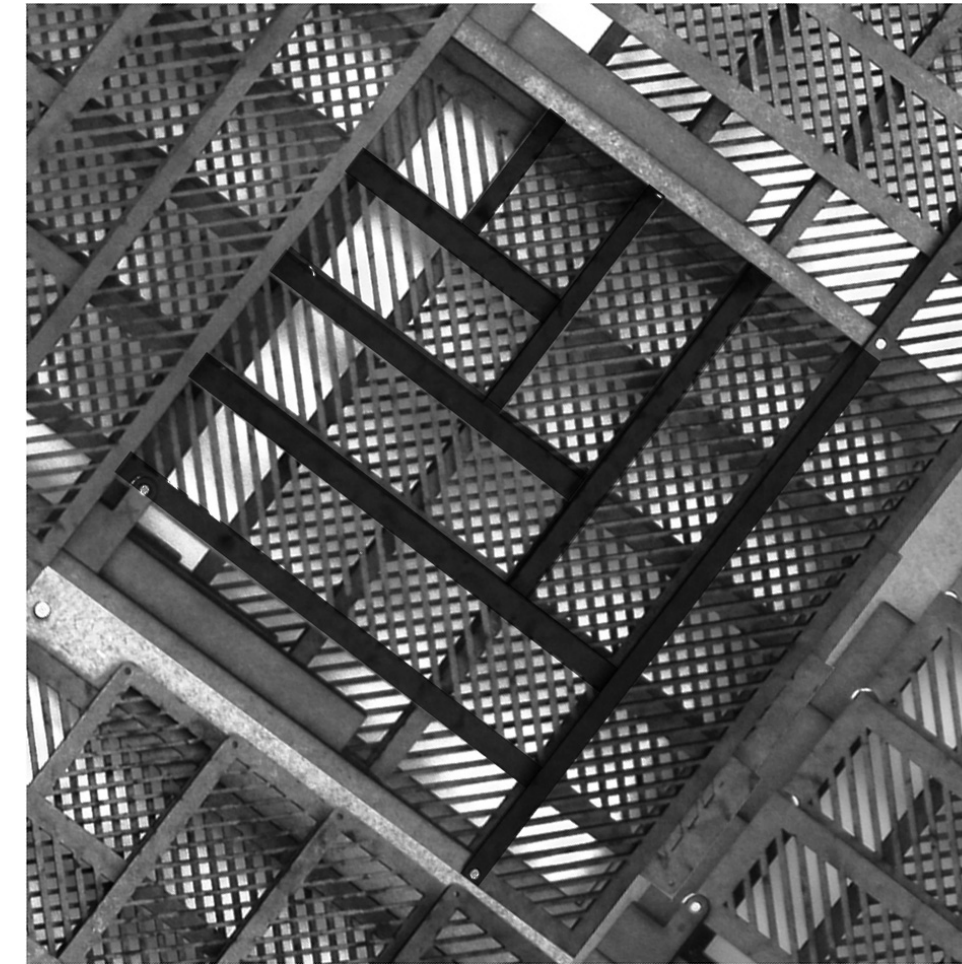

MODEL NAME : UMBRA IV
DIMENSION: 12.5" x 12.5"
TYPOLOGY OF MOVEMENT : ROTATION AND TRANSLATION

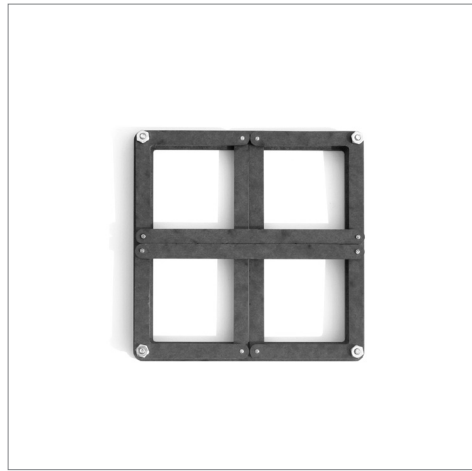
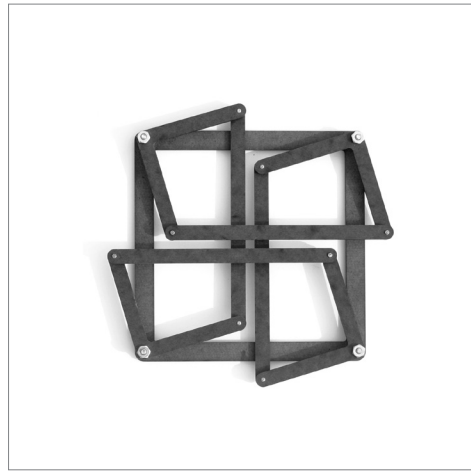
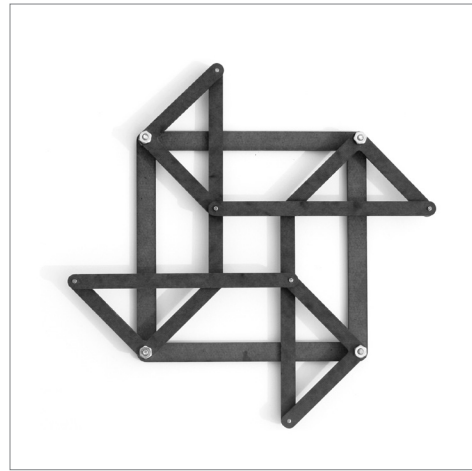
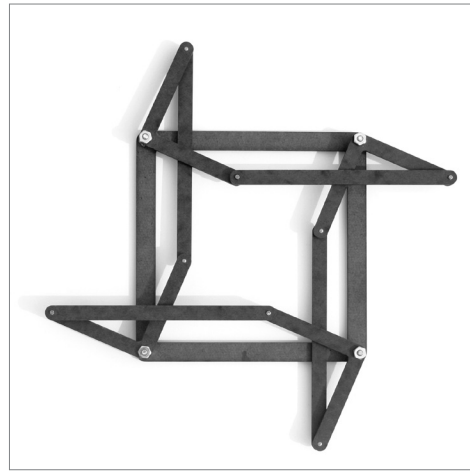
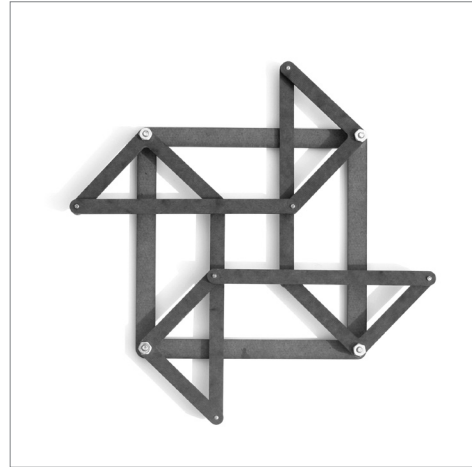
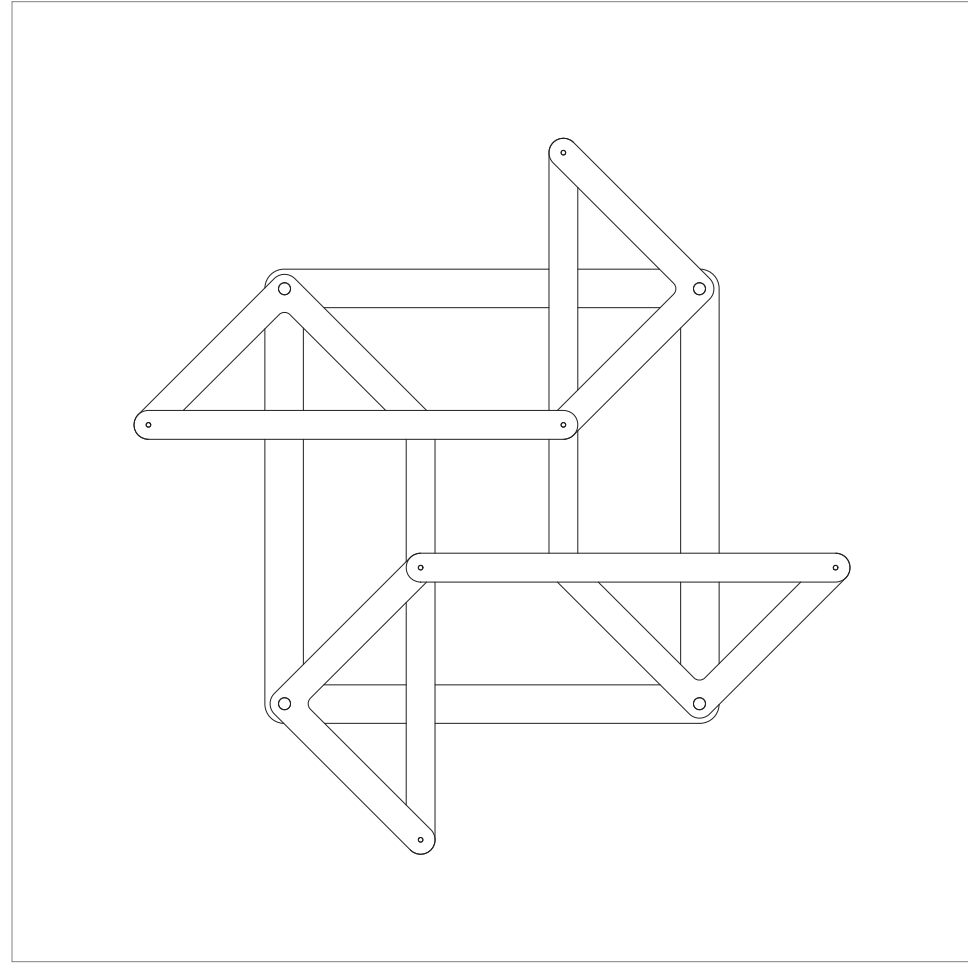

MODEL NAME : ANGULUS
DIMENSION : 6" x 6"
TYPOLOGY OF MOVEMENT : ROTATION AND TRANSLATION

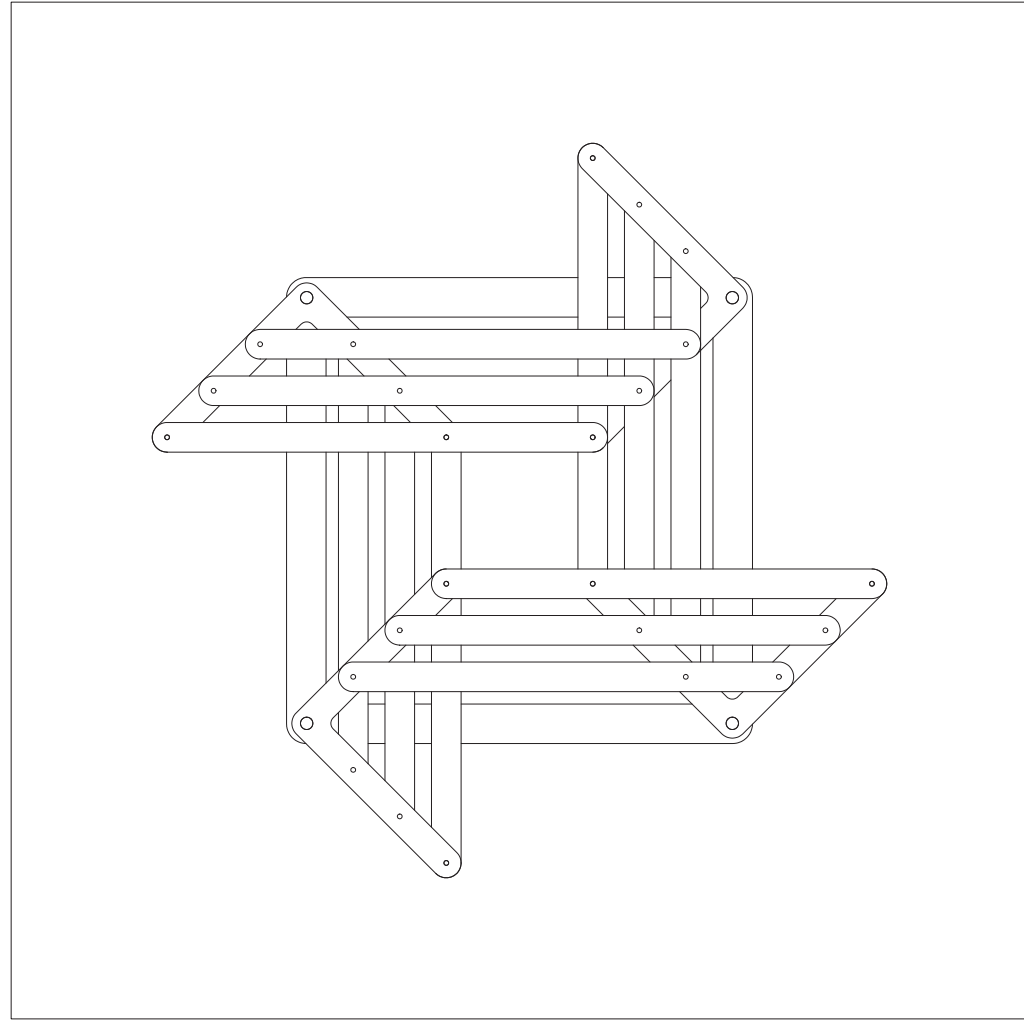

MODEL NAME : UMBRA I
DIMENSION: 6" x 6"
TYPOLOGY OF MOVEMENT : ROTATION AND TRANSLATION

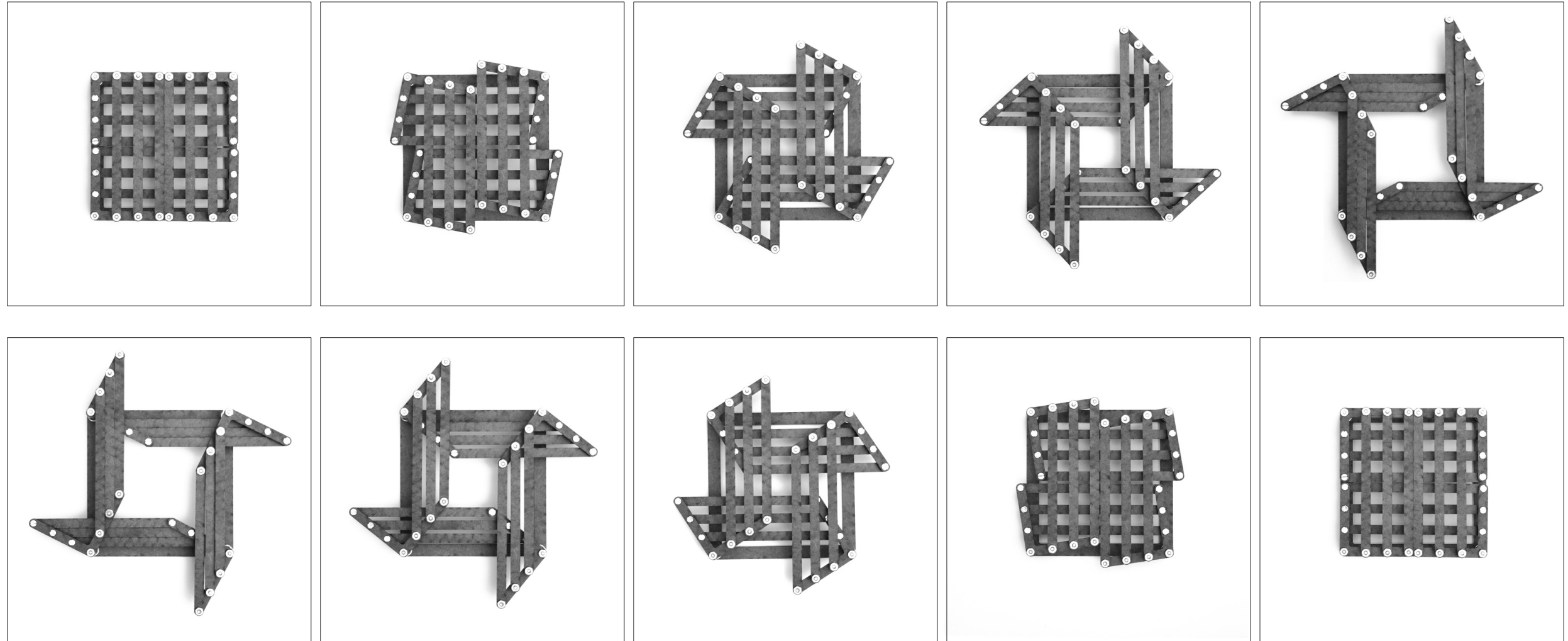

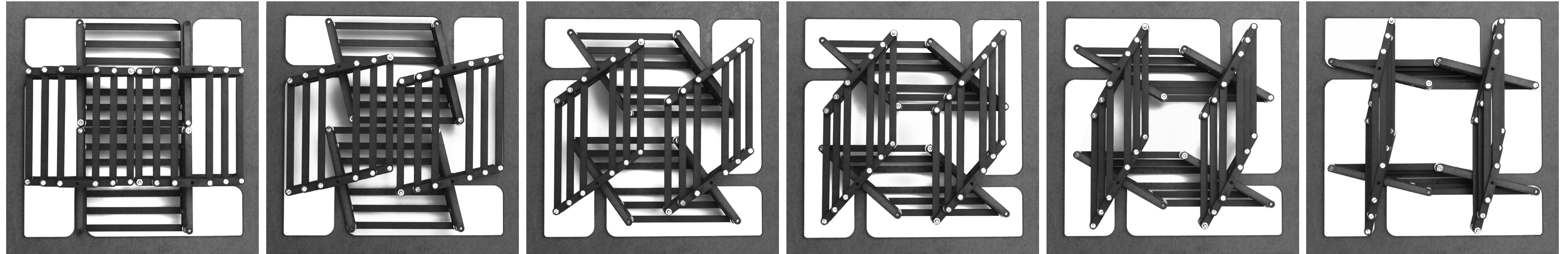
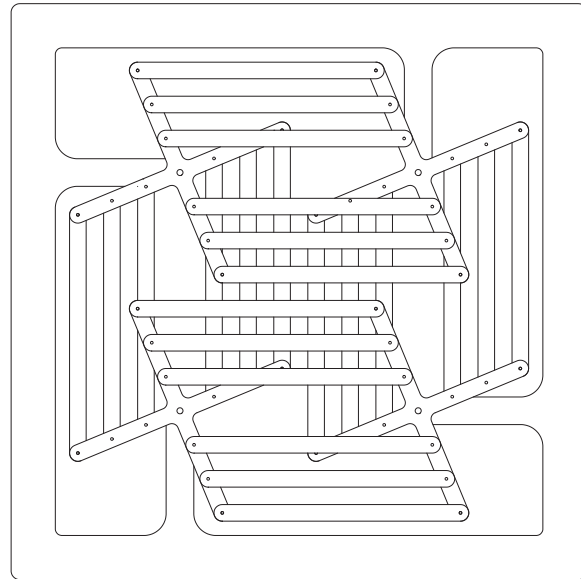

MODEL NAME : UMBRA II
DIMENSION: 13" x 13"
TYPOLOGY OF MOVEMENT : ROTATION AND TRANSLATION

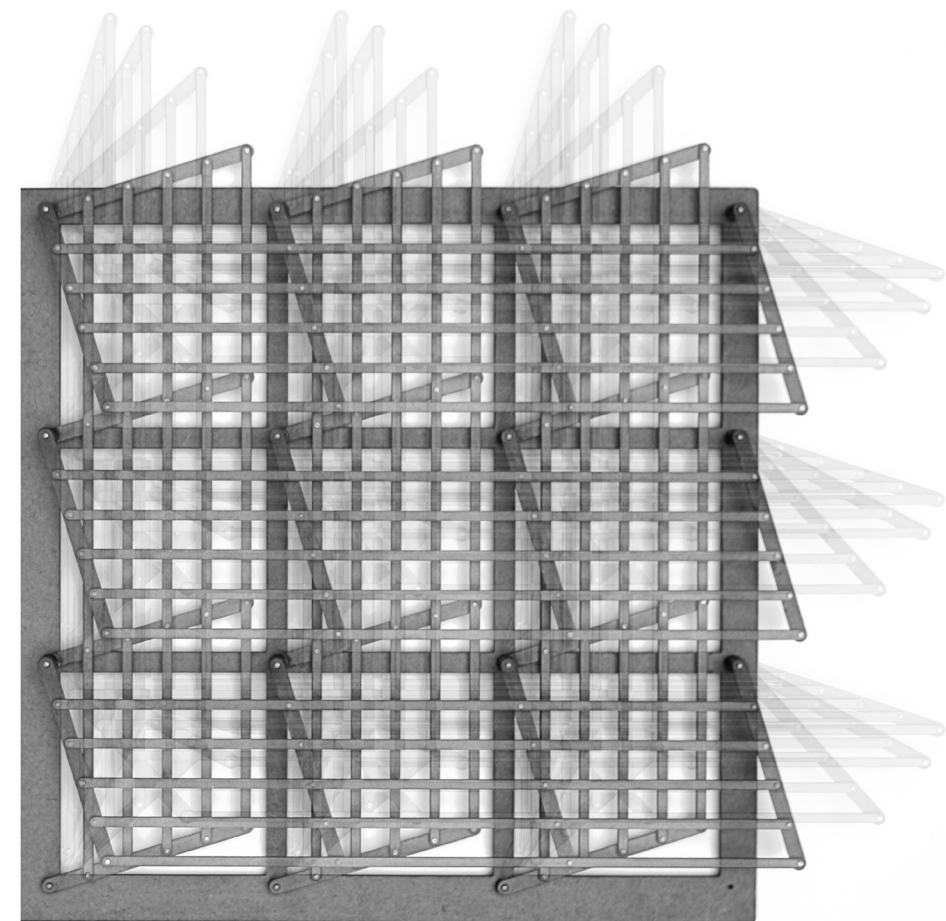
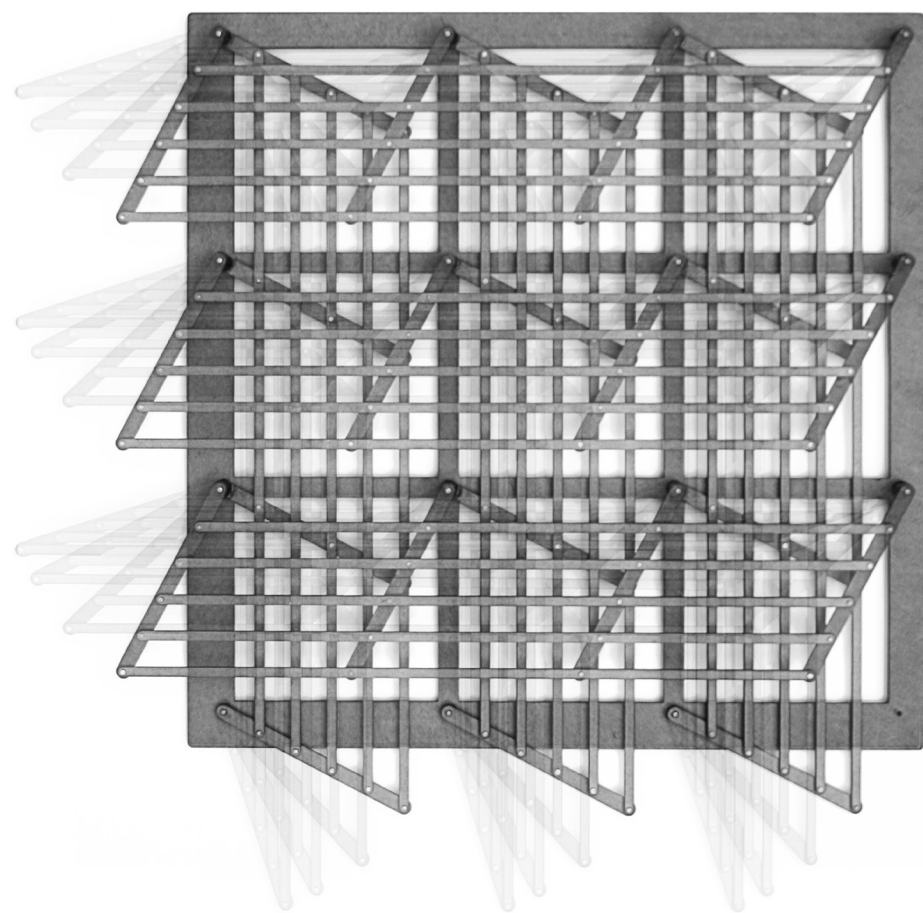

MODEL NAME : UMBRA III
DIMENSION: 17.5" x 17.5"
TYPOLOGY OF MOVEMENT : ROTATION AND TRANSLATION

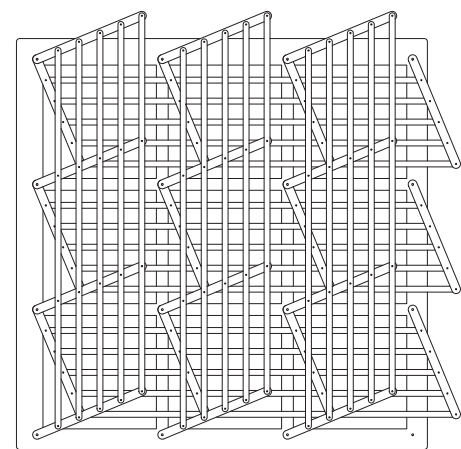

MODEL NAME : UMBRA III
DIMENSION: 17.5" x 17.5"
TYPOLOGY OF MOVEMENT : ROTATION AND TRANSLATION

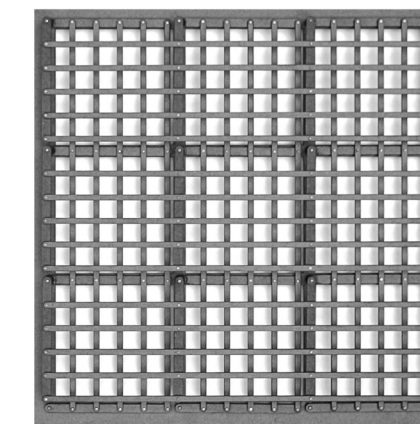
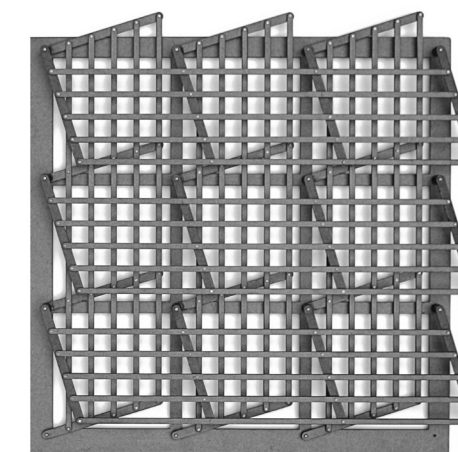
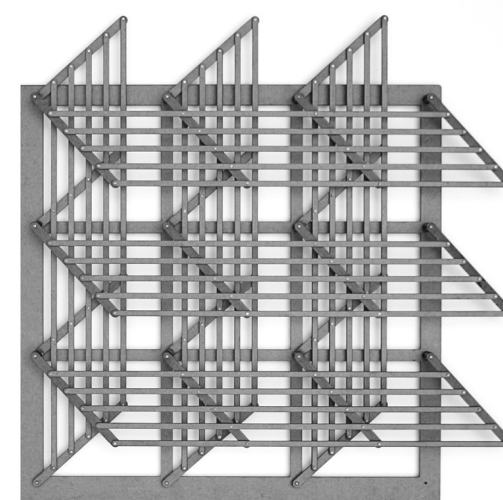
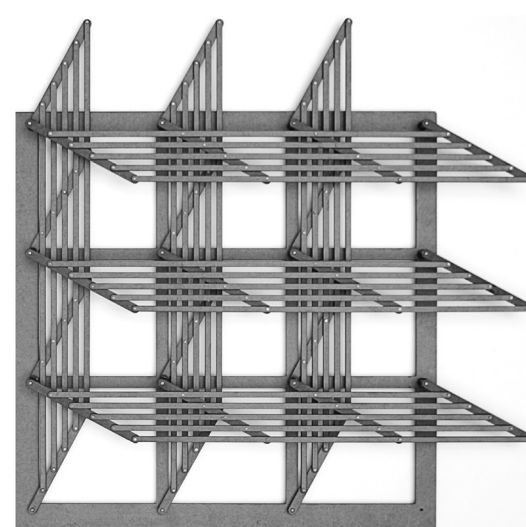
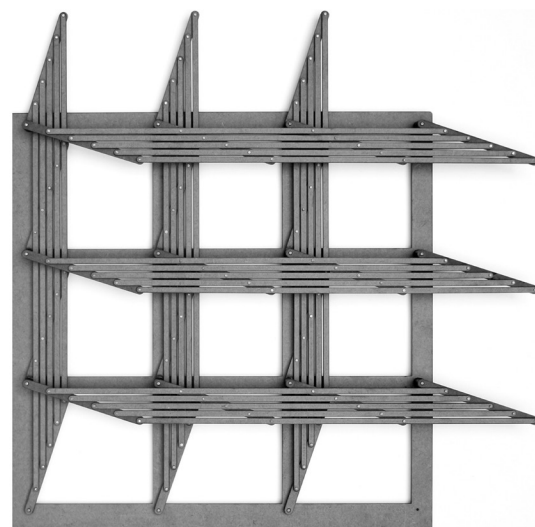
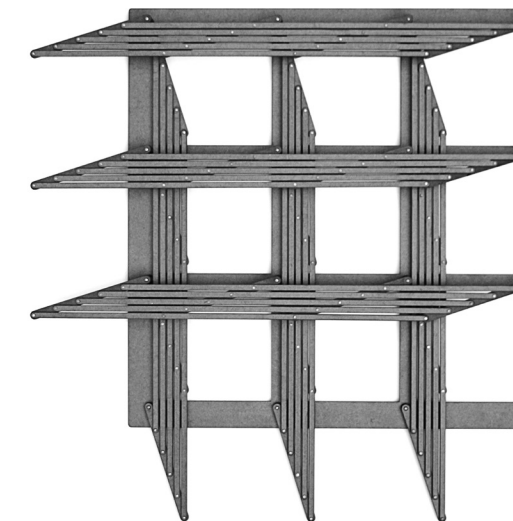
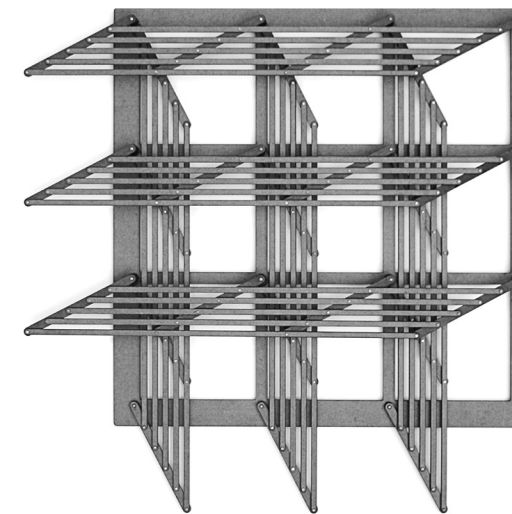
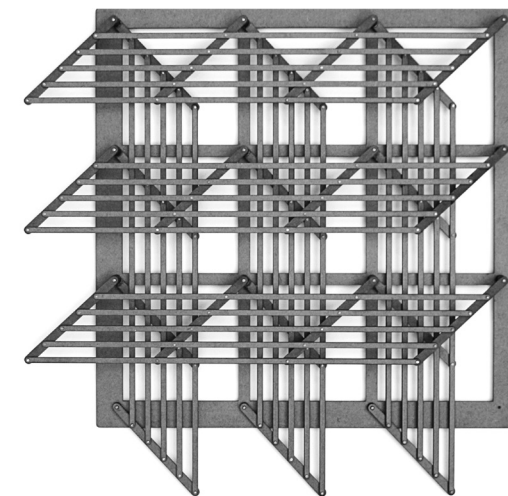
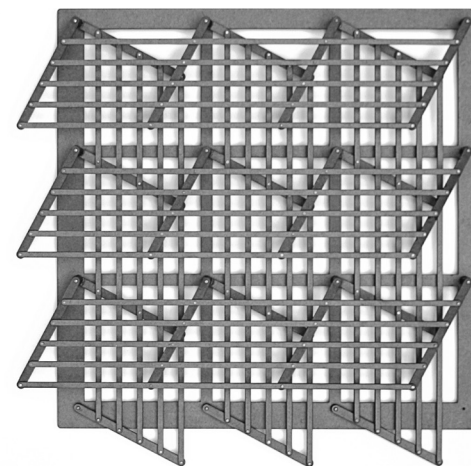
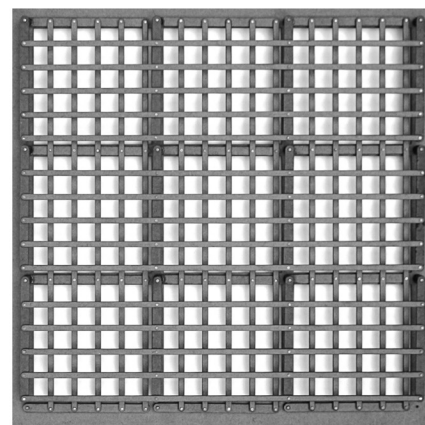

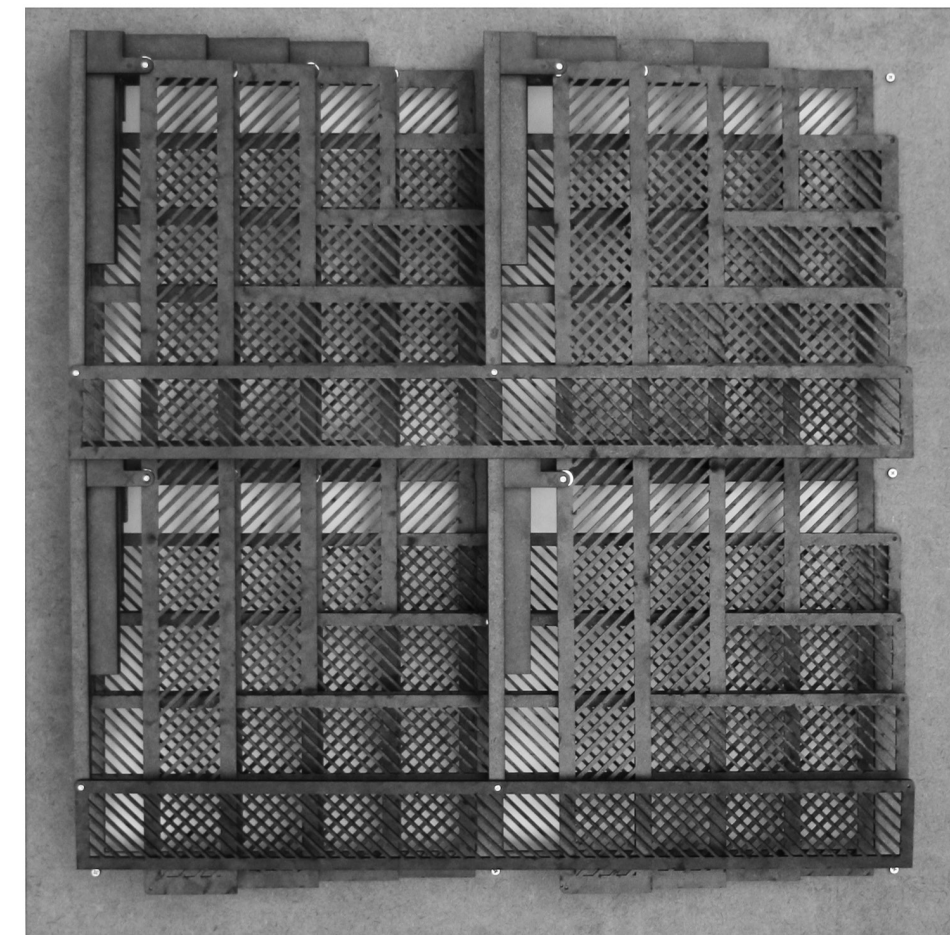
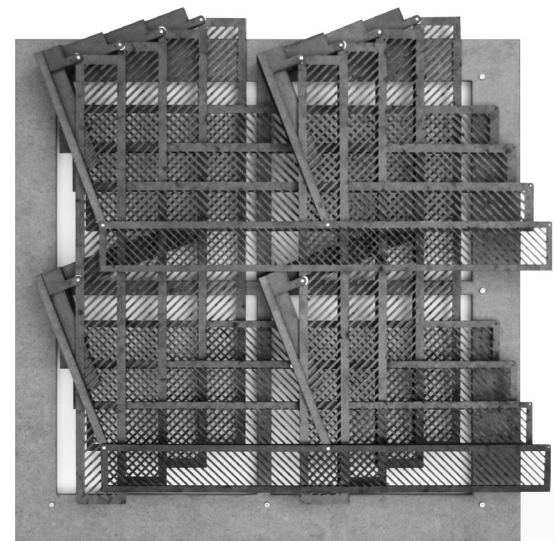
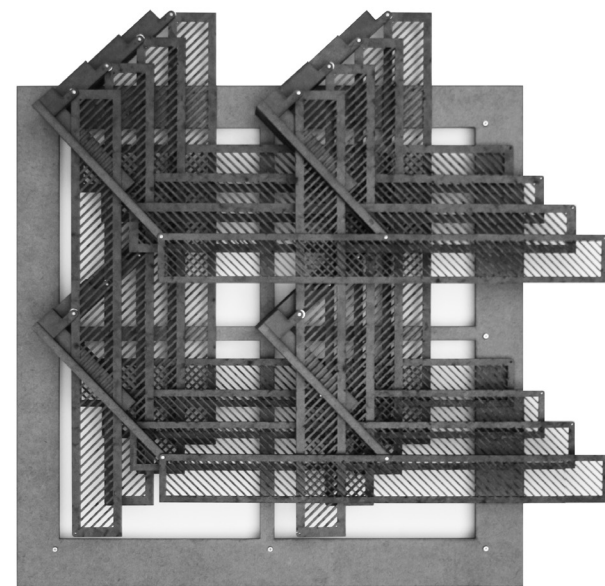
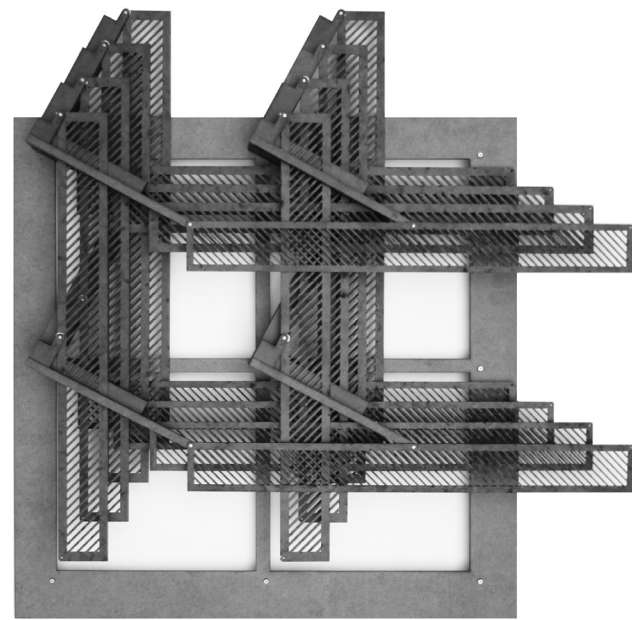
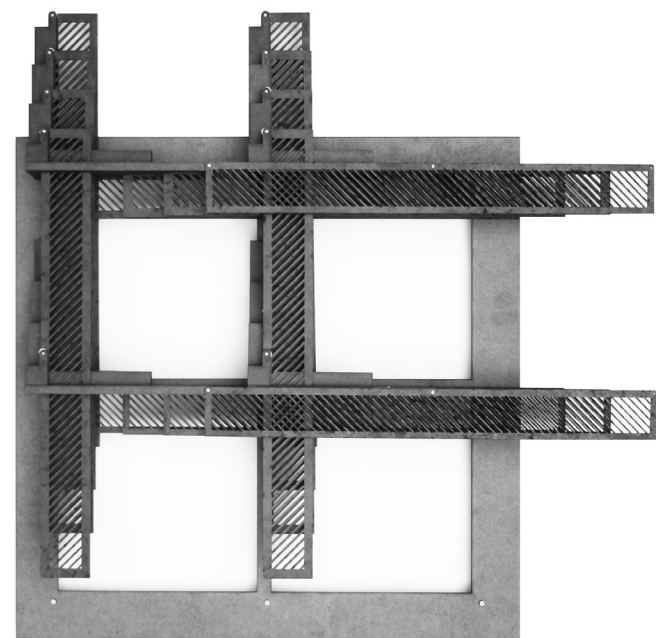

MODEL NAME : UMBRA IV
DIMENSION: 12.5" x 12.5"
TYPOLOGY OF MOVEMENT : ROTATION AND TRANSLATION

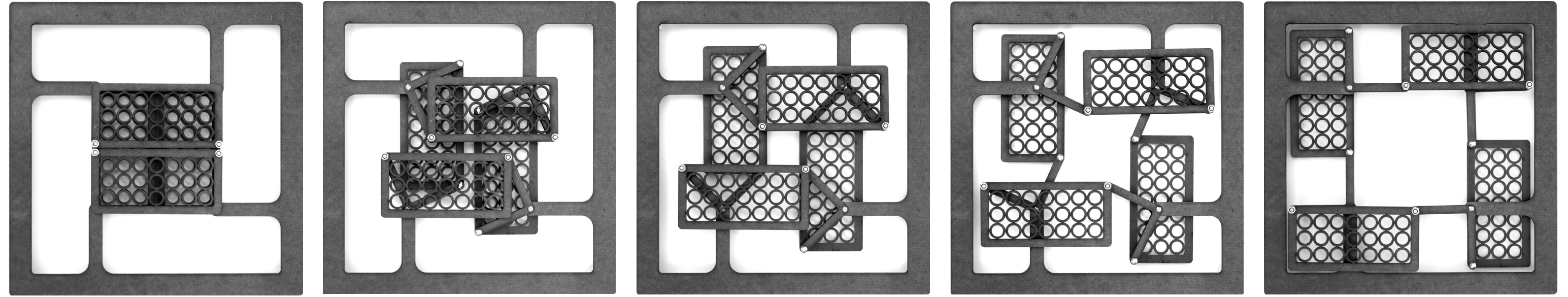
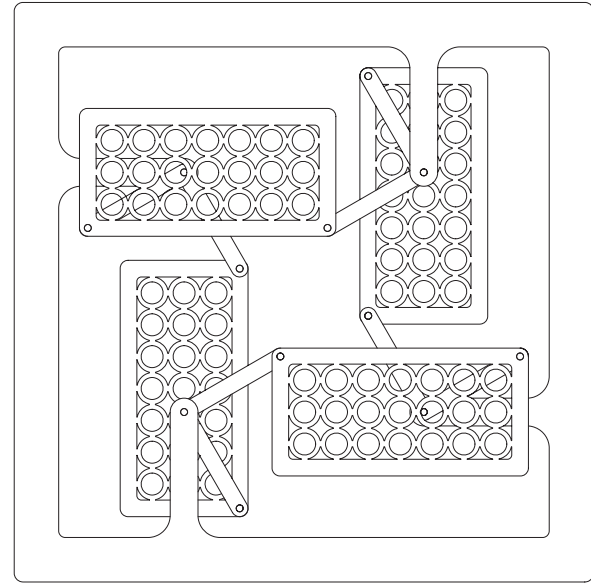

MODEL NAME : AURA I
DIMENSION: 13" x 13"
TYPOLOGY OF MOVEMENT : ROTATION AND TRANSLATION

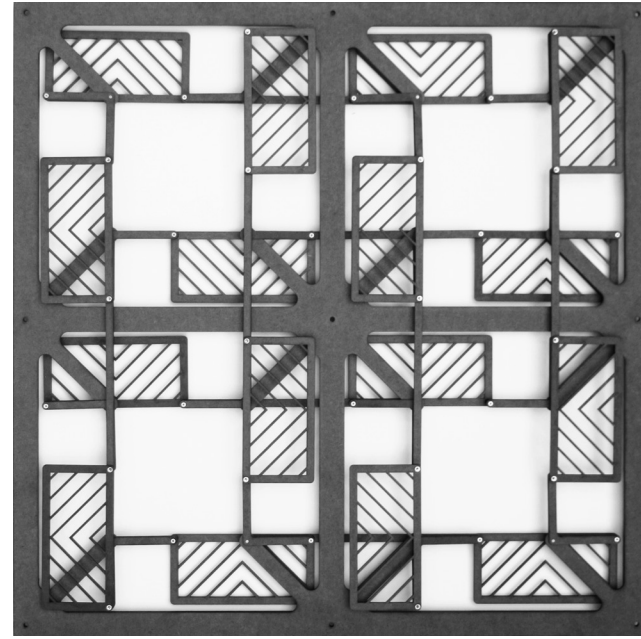
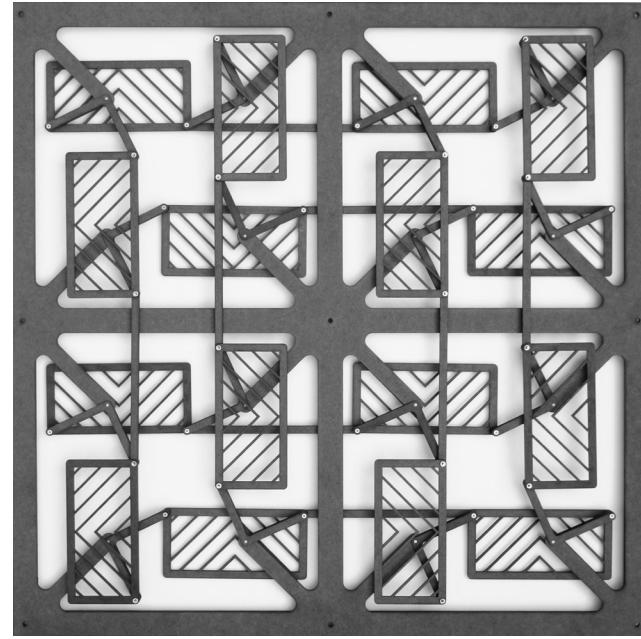
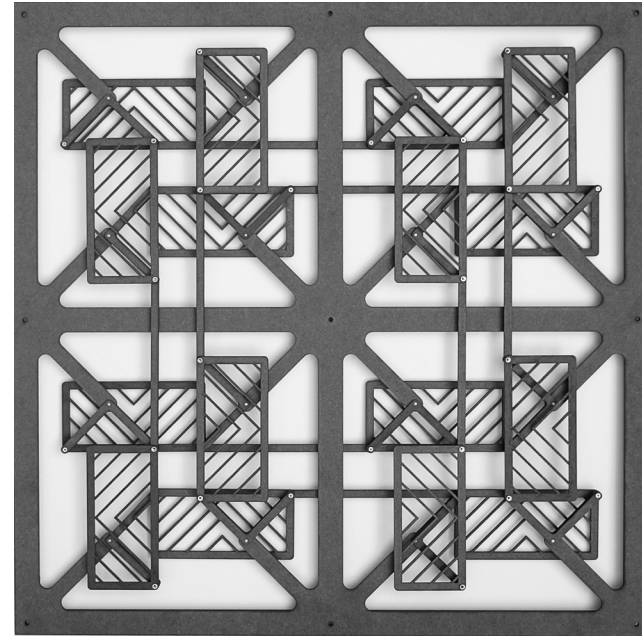
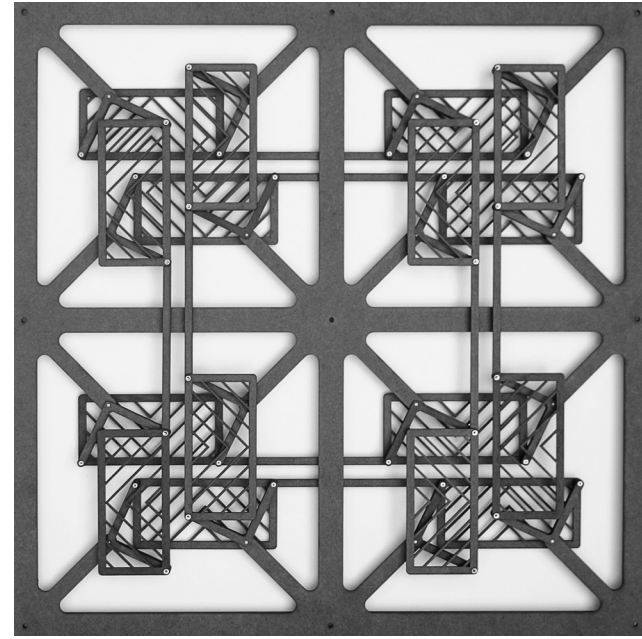
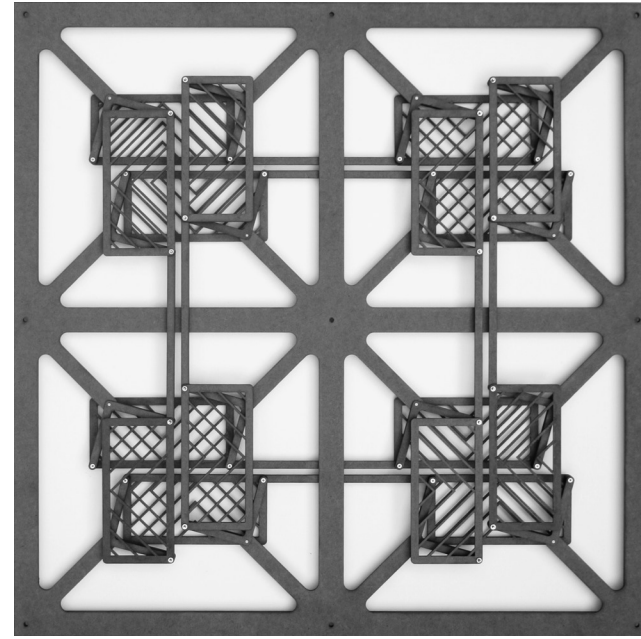
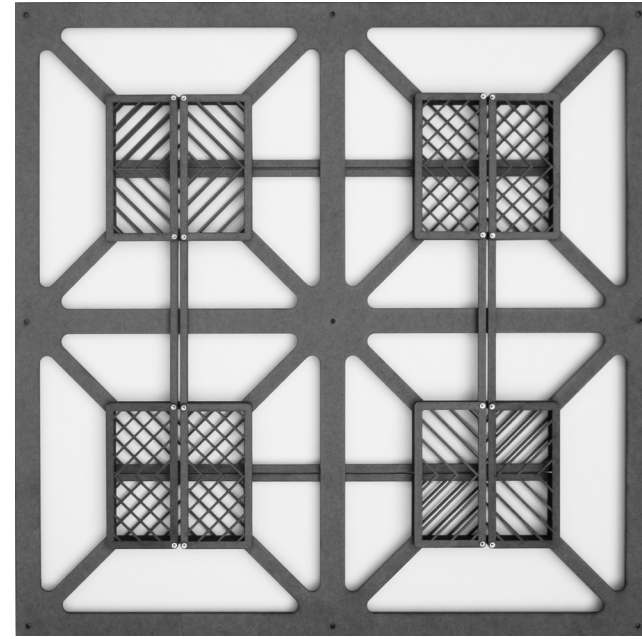

MODEL NAME : AURA II
DIMENSION: 23" x 23"
TYPOLOGY OF MOVEMENT : ROTATION AND TRANSLATION

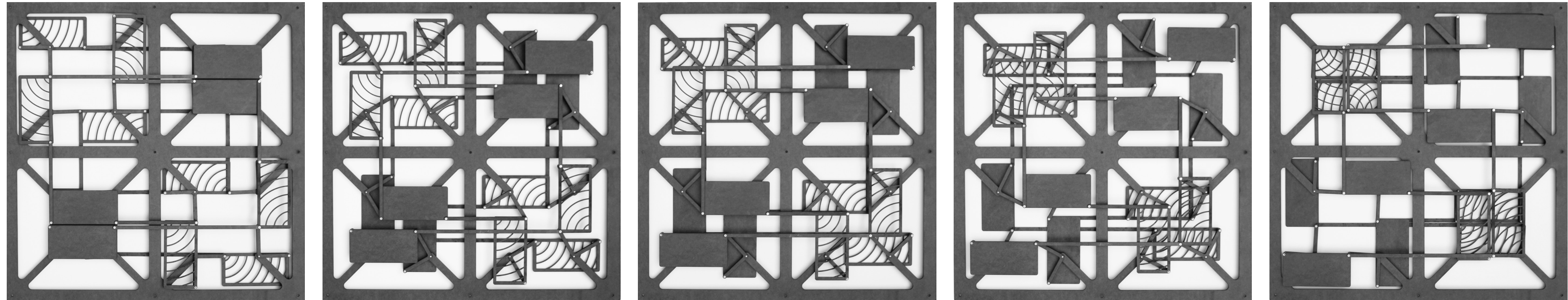

MODEL NAME : : AURA III
DIMENSION: 23" x 23"
TYPOLOGY OF MOVEMENT : ROTATION AND TRANSLATION

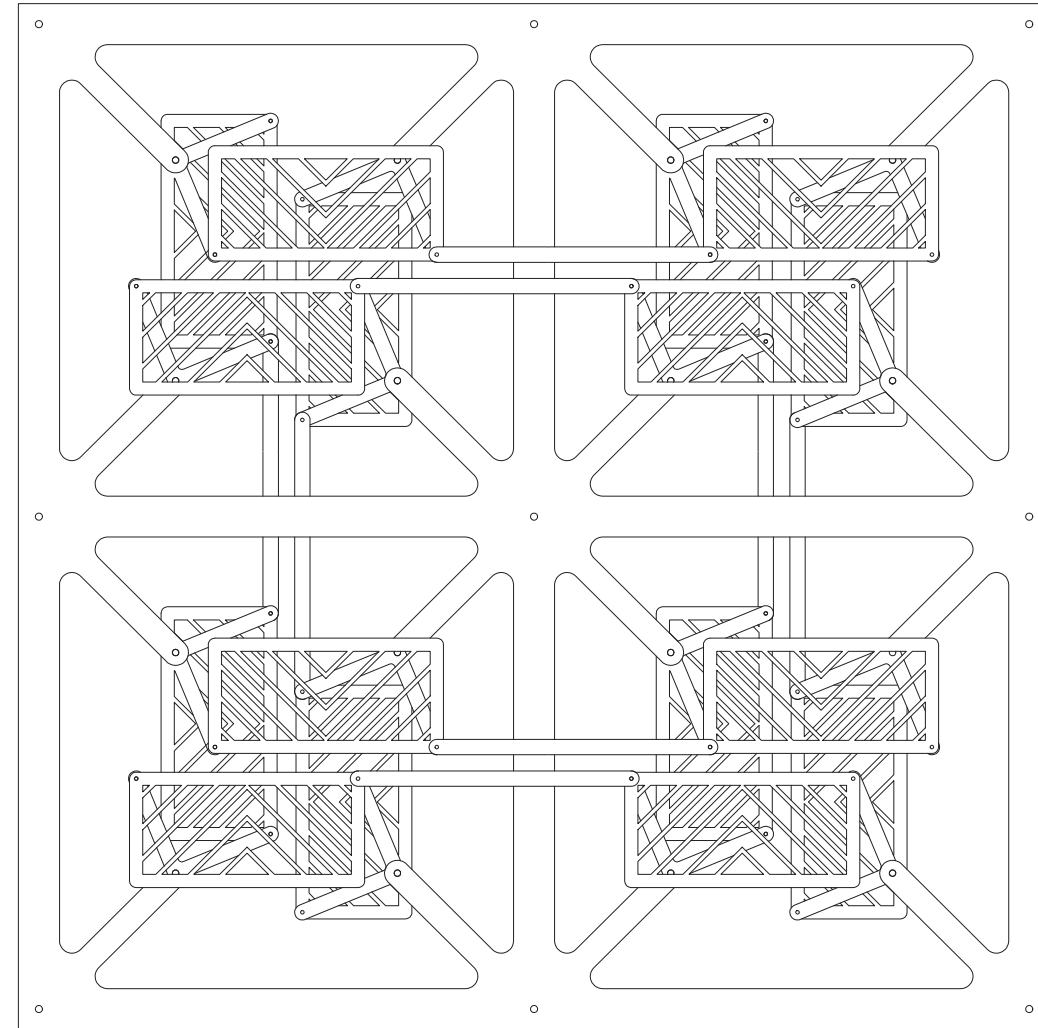

MODEL NAME : AURA II
DIMENSION: 23" x 23"
TYPOLOGY OF MOVEMENT : ROTATION AND TRANSLATION

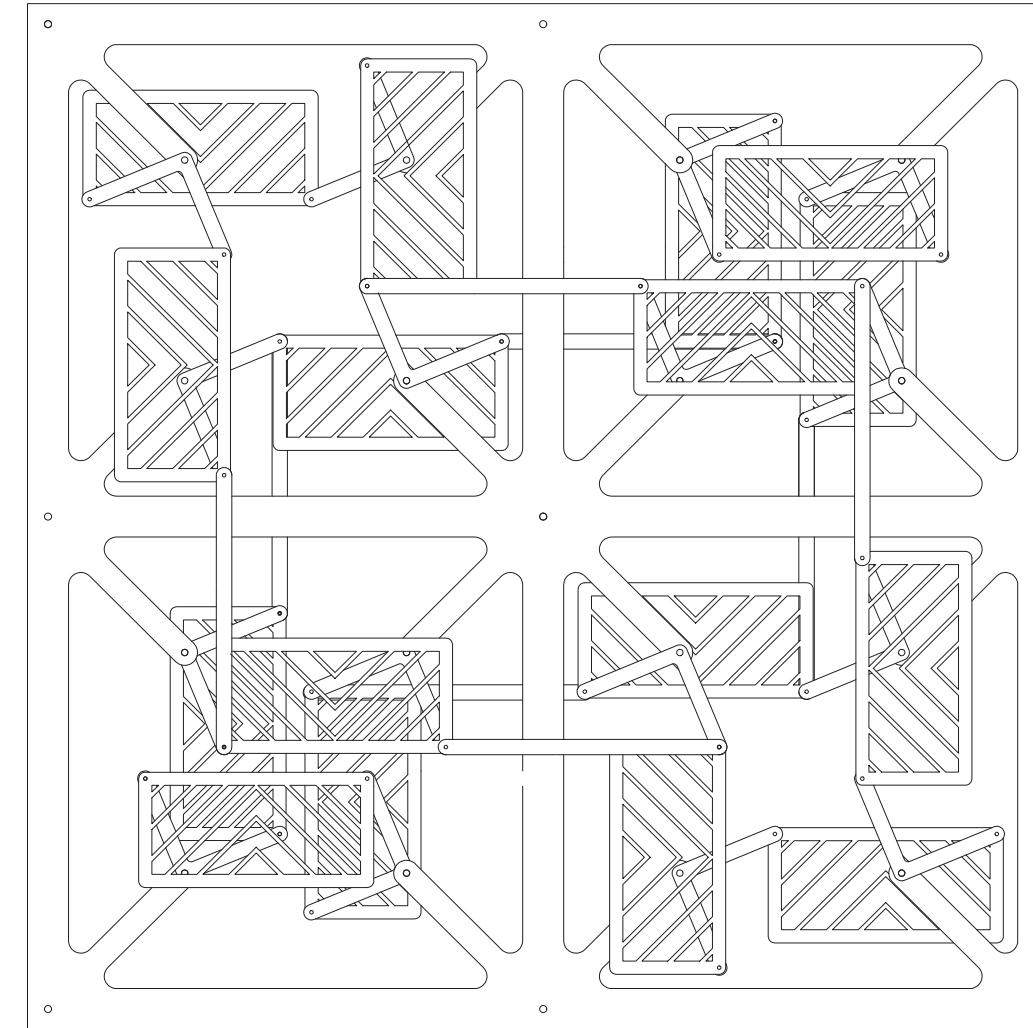

MODEL NAME : : AURA III
DIMENSION: 23" x 23"
TYPOLOGY OF MOVEMENT : ROTATION AND TRANSLATION

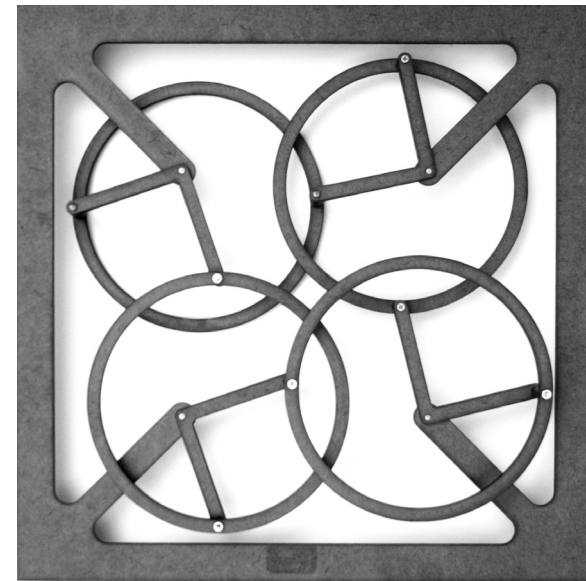
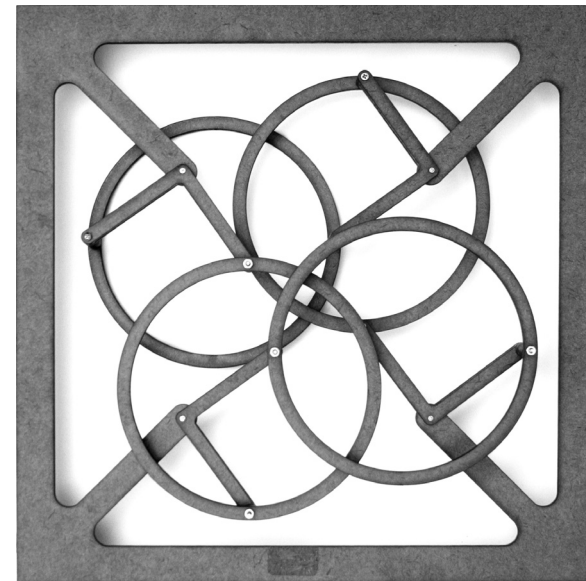
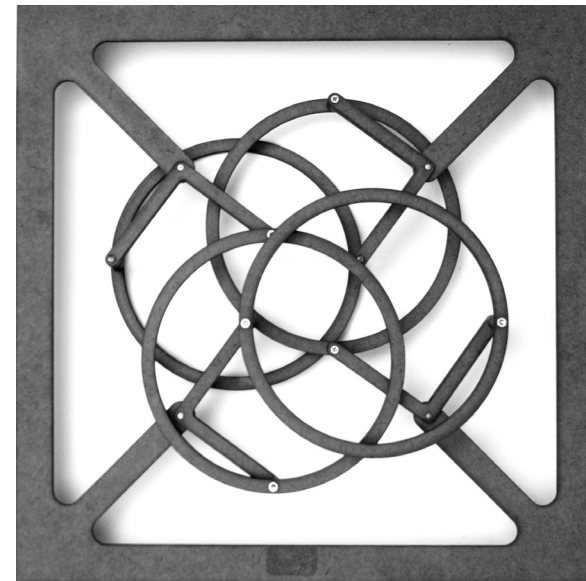
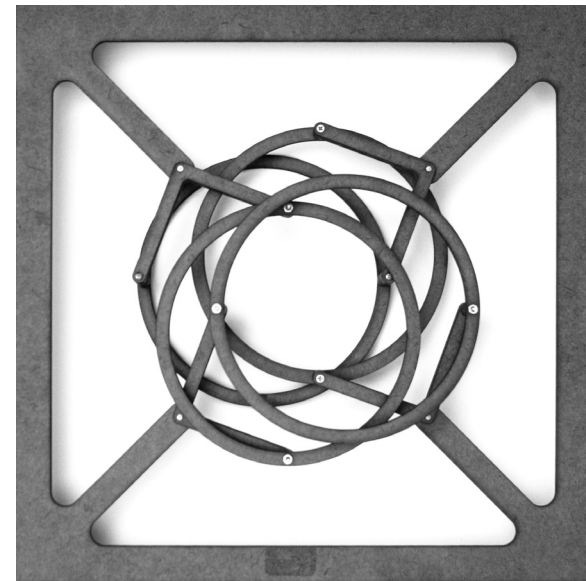
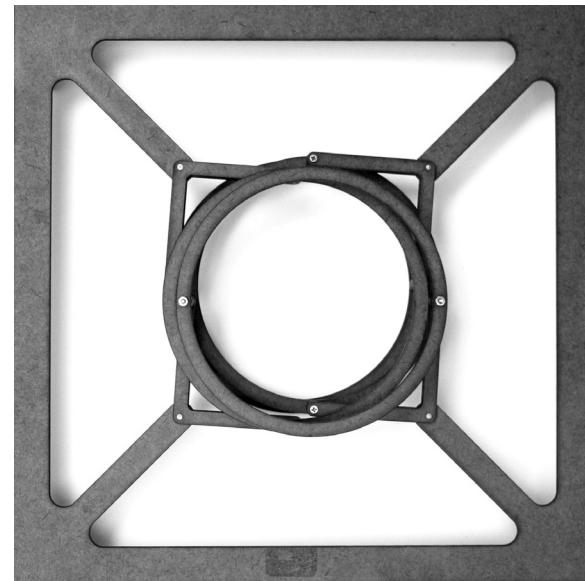
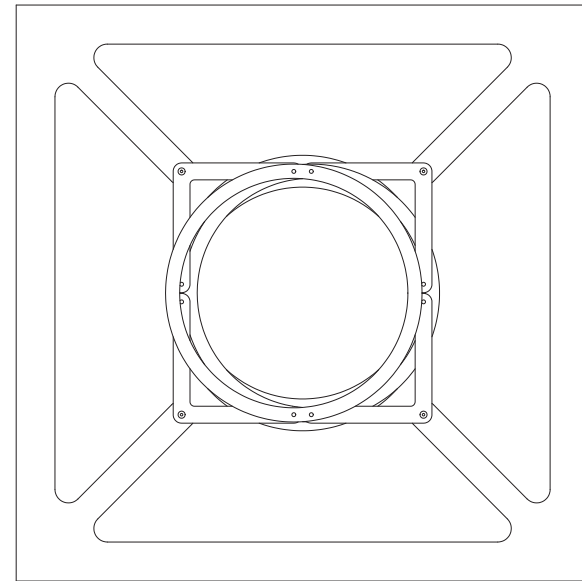

MODEL NAME : AURA IV
DIMENSION: 11.5" x 11.5"
TYPOLOGY OF MOVEMENT : ROTATION AND TRANSLATION

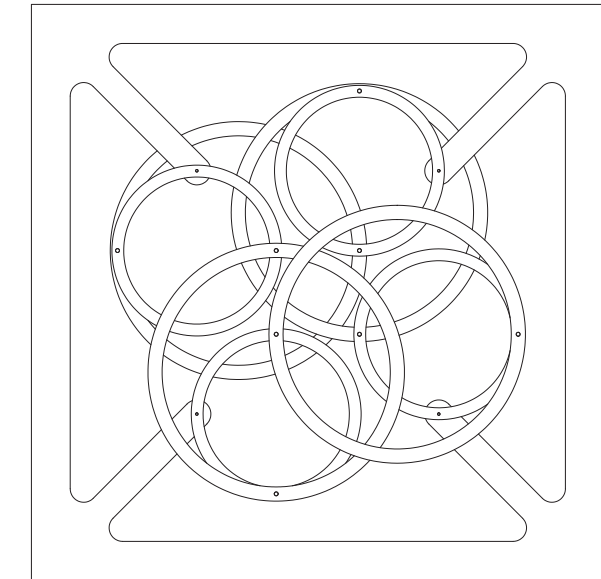
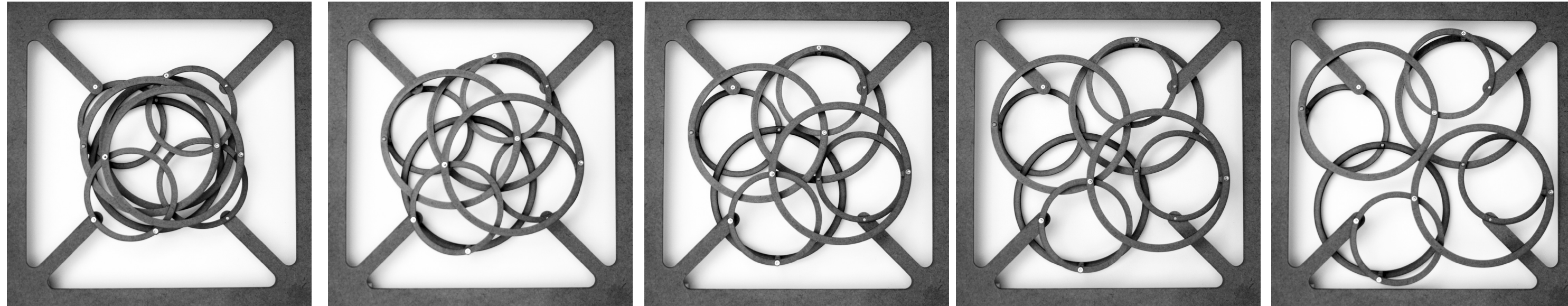

MODEL NAME : : AURA V
DIMENSION: 11.5" x 11.5"
TYPOLOGY OF MOVEMENT : ROTATION AND TRANSLATION

MODEL NAME : SOL 1
DIMENSION: 12.5" x 12.5"
TYPOLOGY OF MOVEMENT : ROTATION AND TRANSLATION

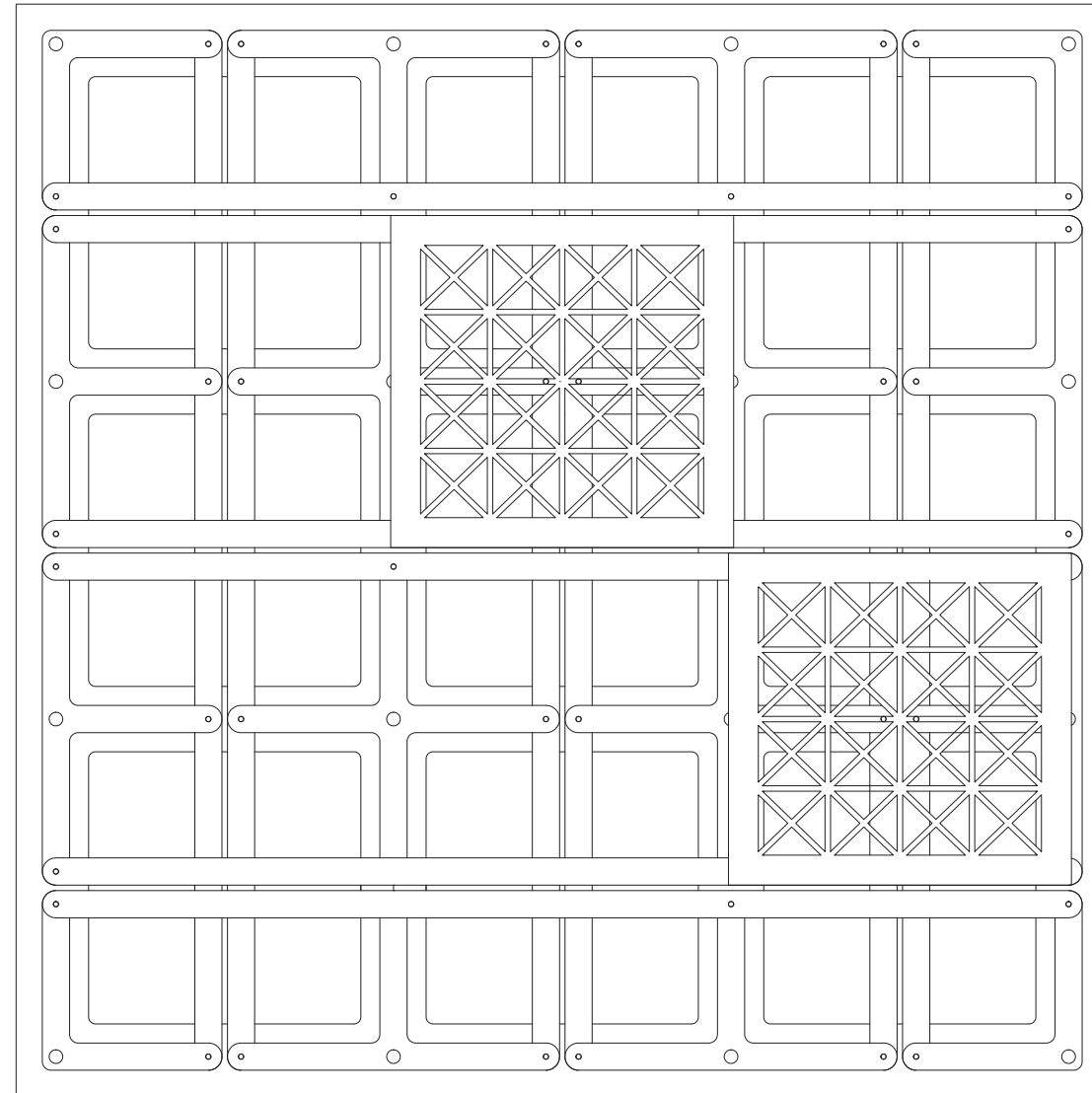

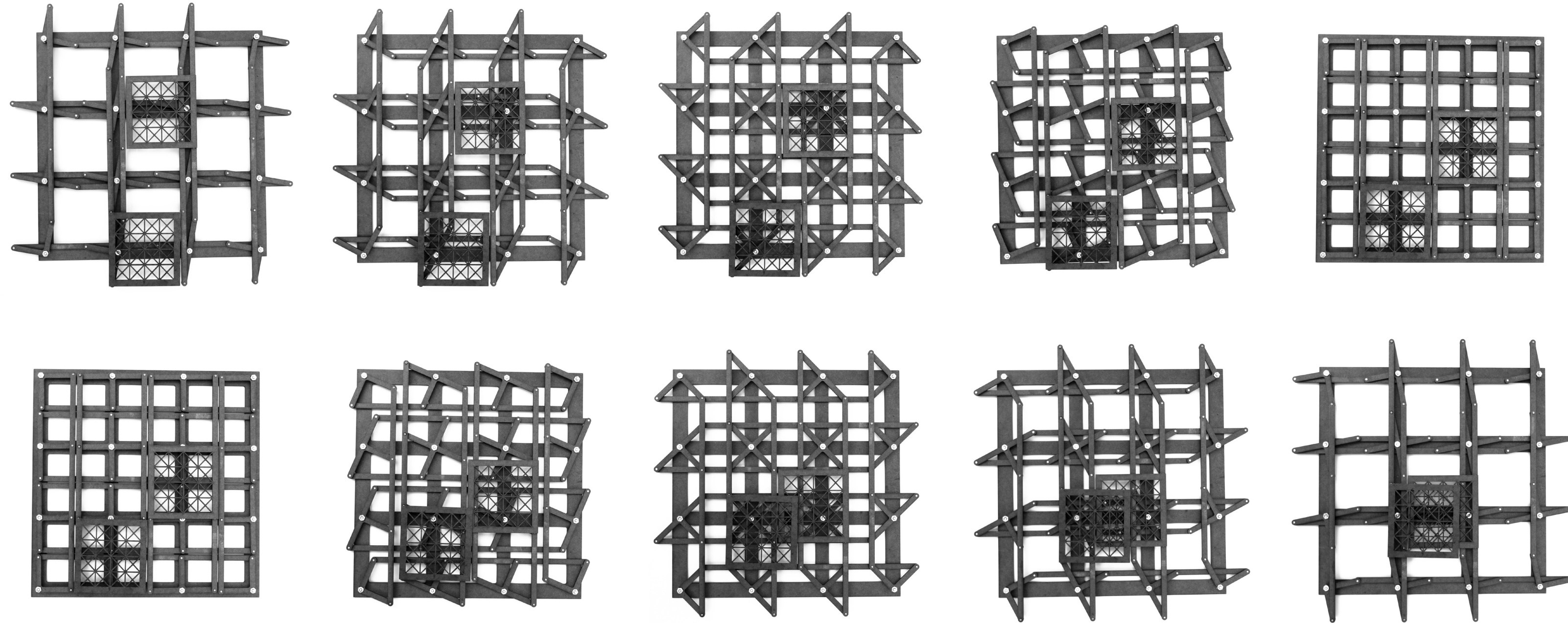

MODEL NAME : SOL 1
DIMENSION: 12.5" x 12.5"
TYPOLOGY OF MOVEMENT : ROTATION AND TRANSLATION

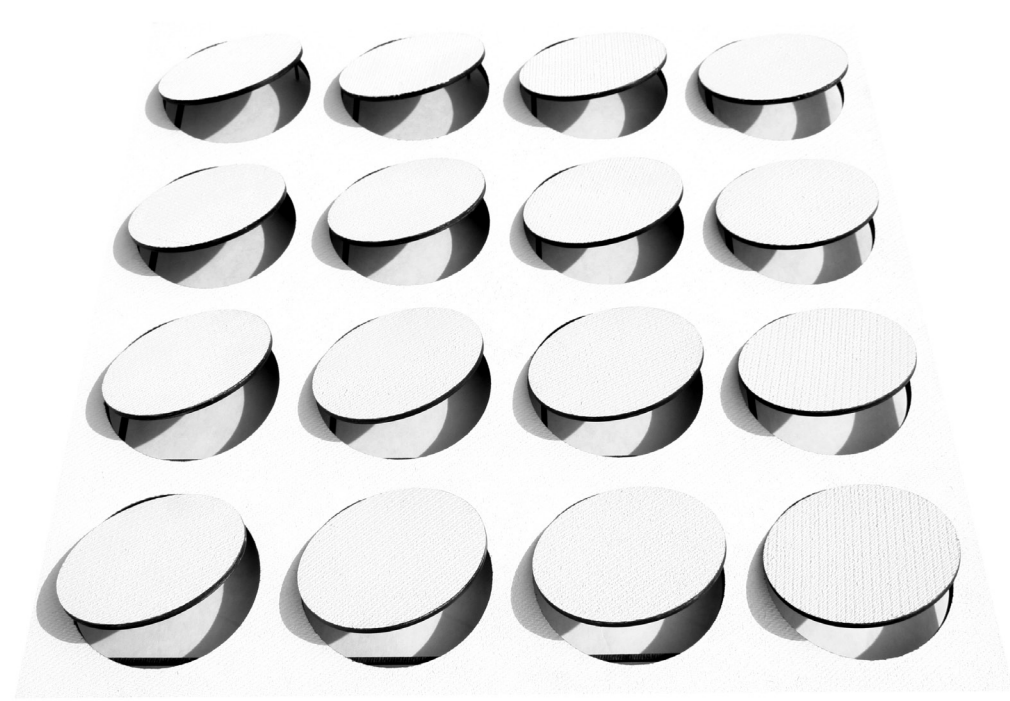

MODEL NAME : SOL II
DIMENSION: 19" x 19"
TYPOLOGY OF MOVEMENT : ROTATION AND TRANSLATION

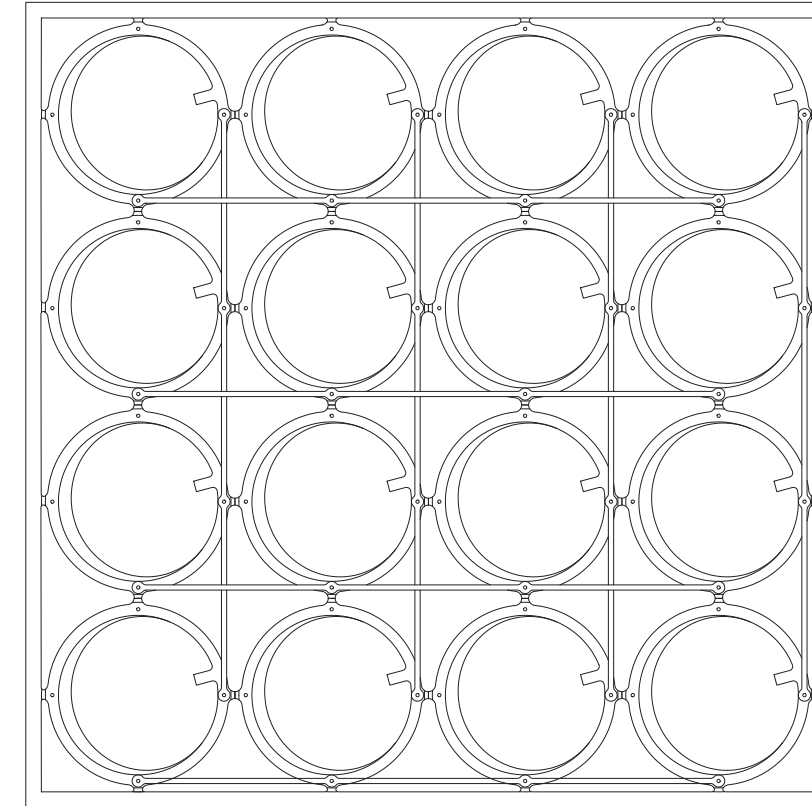

MODEL NAME : SOL II
DIMENSION: 19" x 19"
TYPOLOGY OF MOVEMENT : ROTATION AND TRANSLATION

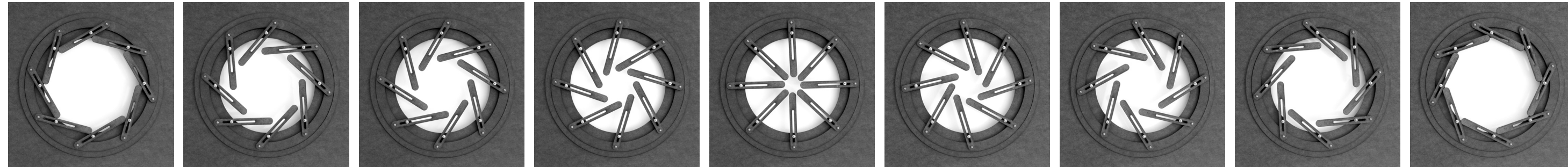

MODEL NAME : OCULUS I
DIMENSION: 9" x 9"
TYPOLOGY OF MOVEMENT : ROTATION

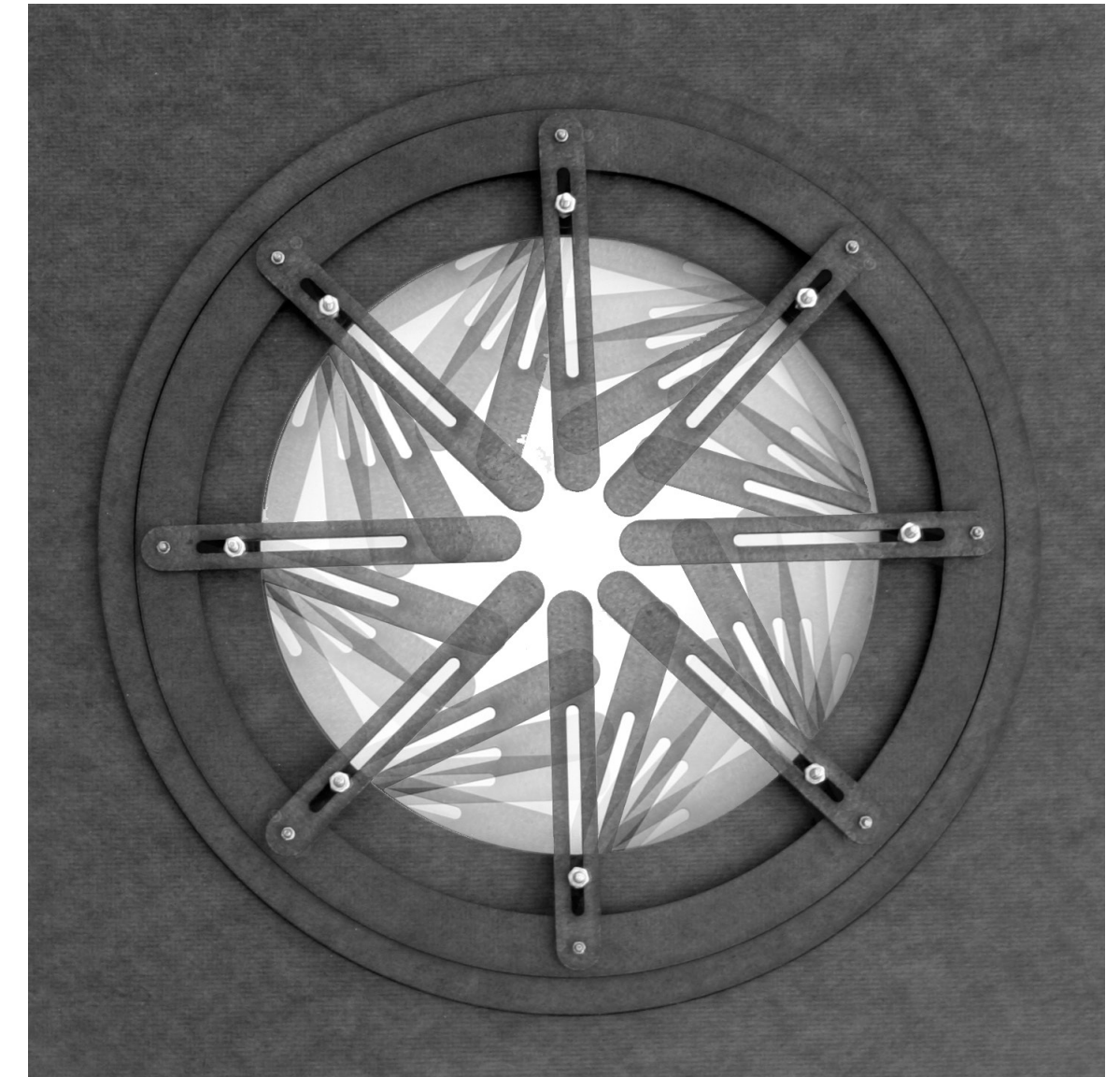
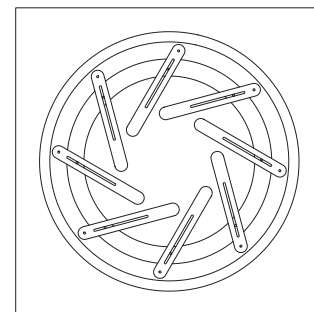

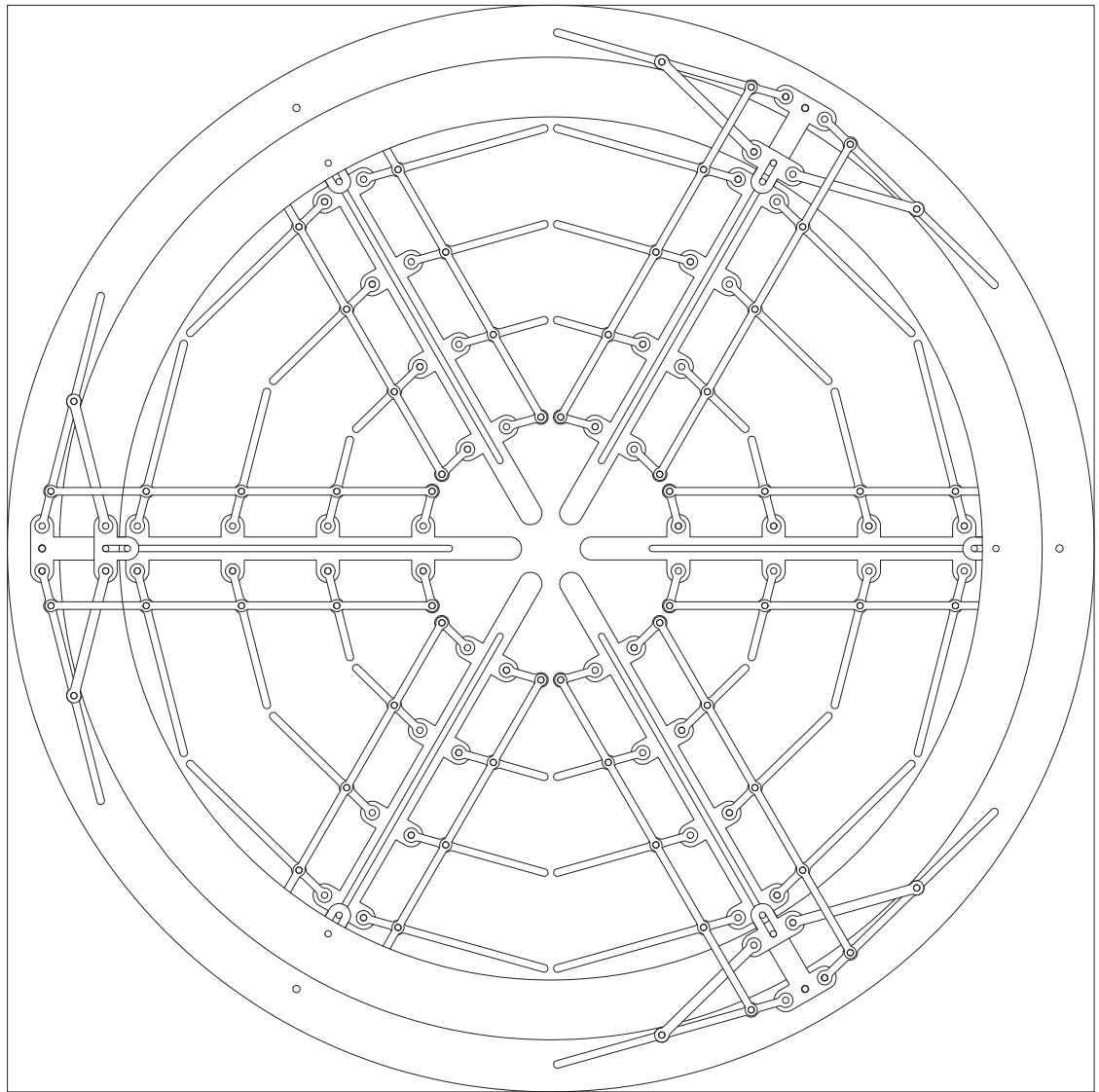

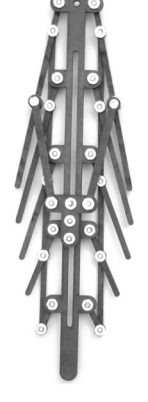
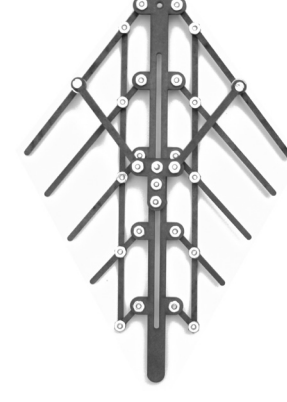
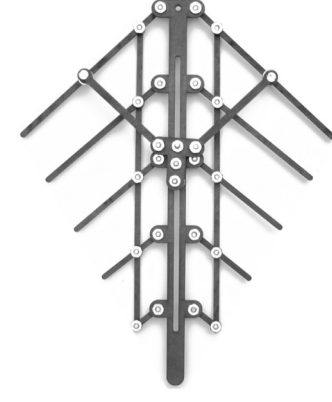
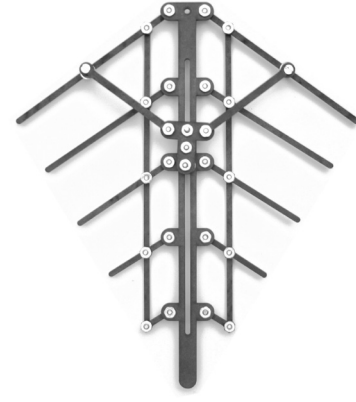
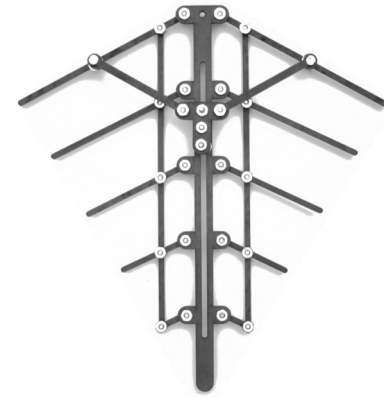
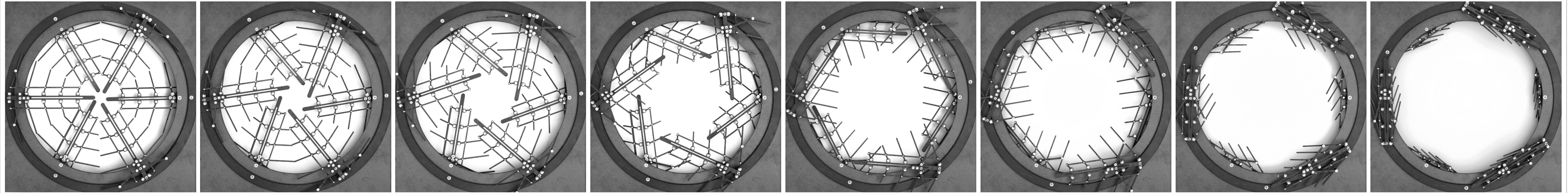

MODEL NAME : OCULUS II
DIMENSION: 23.5" x 23.5"
TYPOLOGY OF MOVEMENT : ROTATION

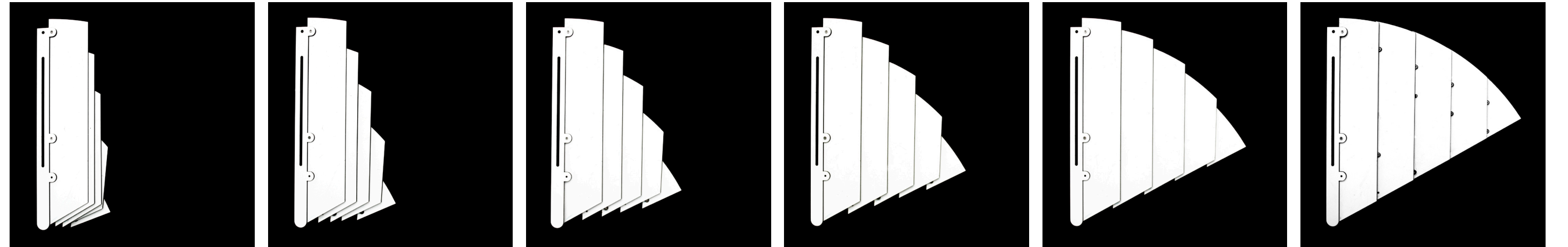
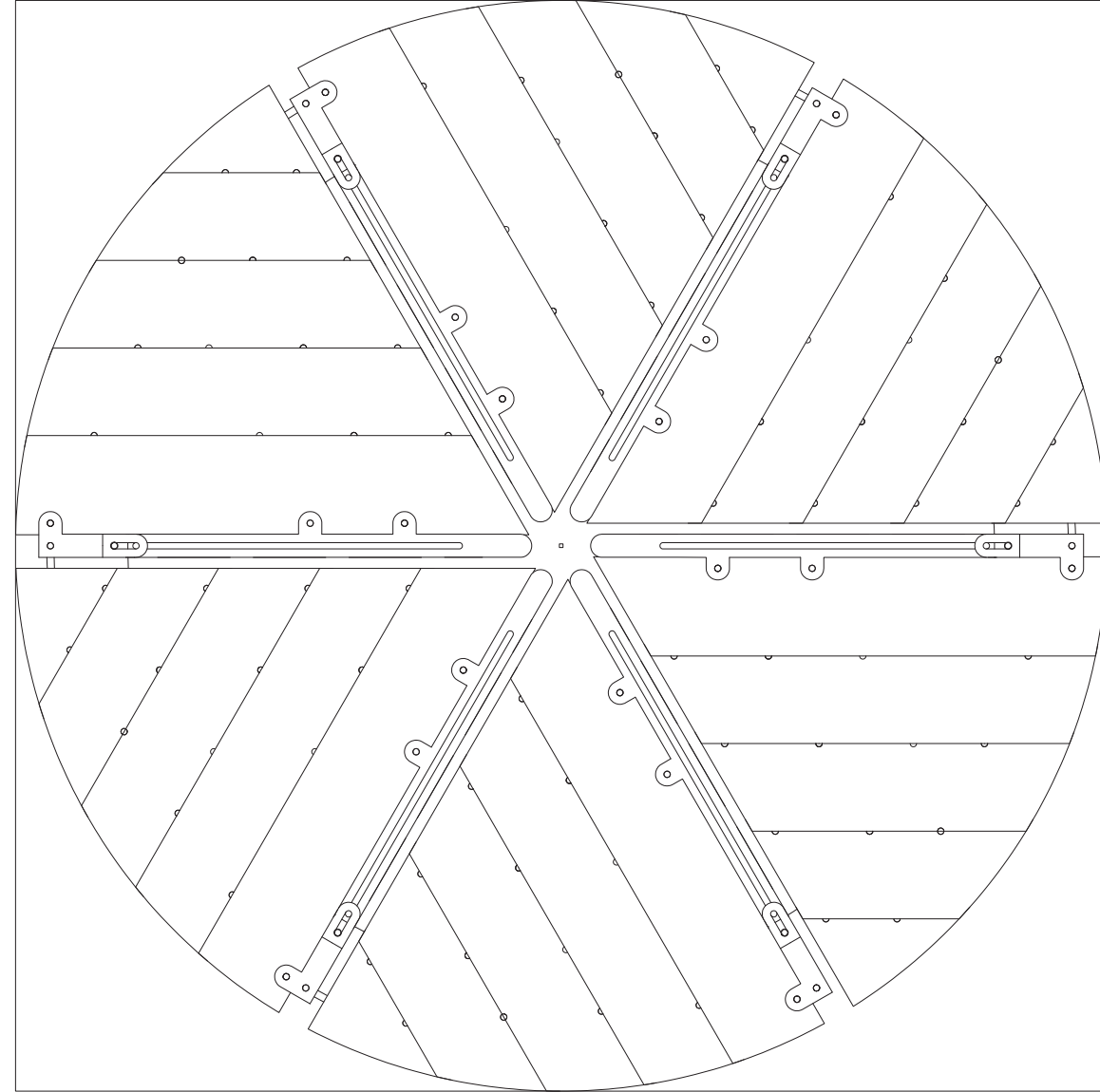

MODEL NAME : OCULUS III
DIMENSION : 23.5" x 23.5"
TYPOLOGY OF MOVEMENT : ROTATION AND TRANSLATION

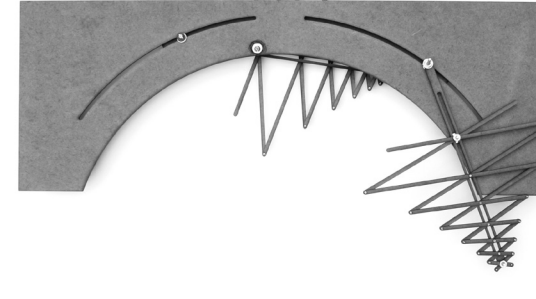
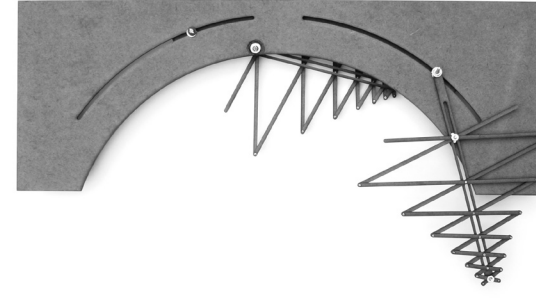
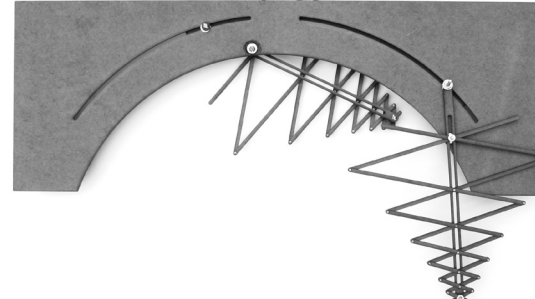
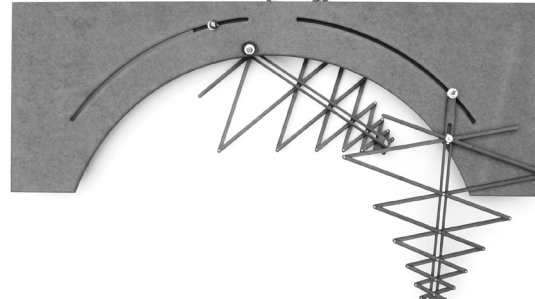
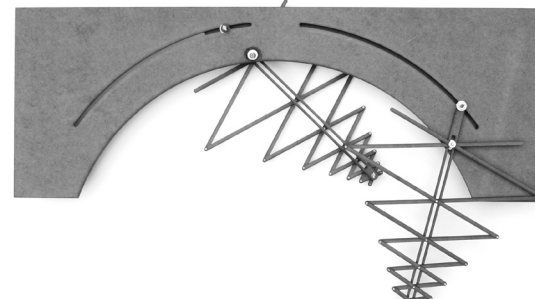
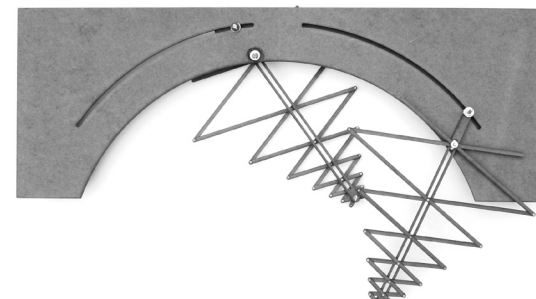
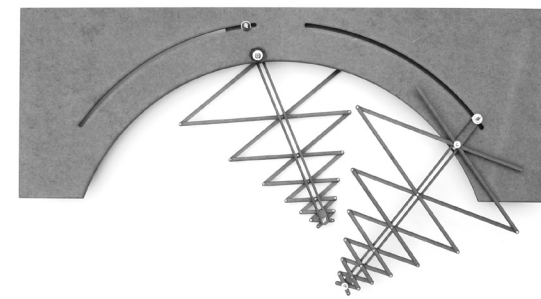
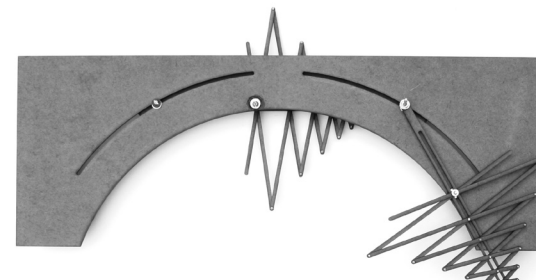
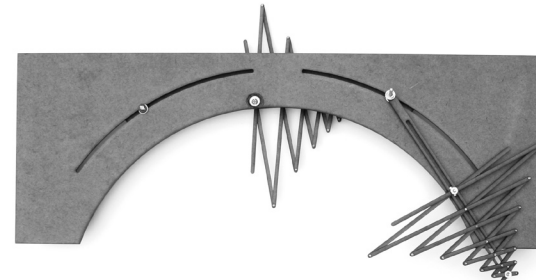
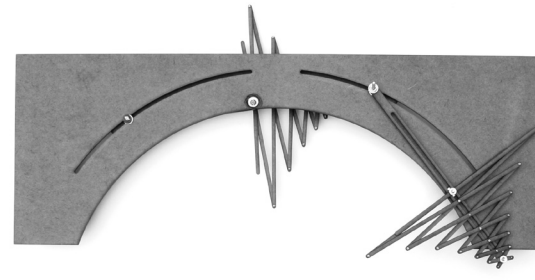
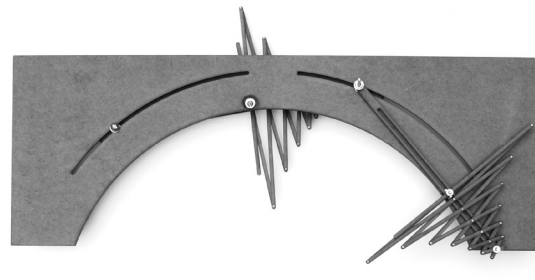
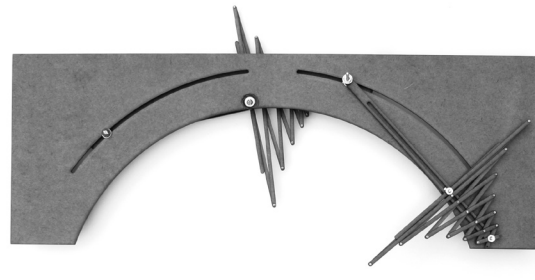
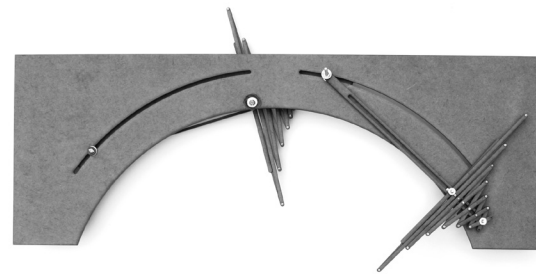
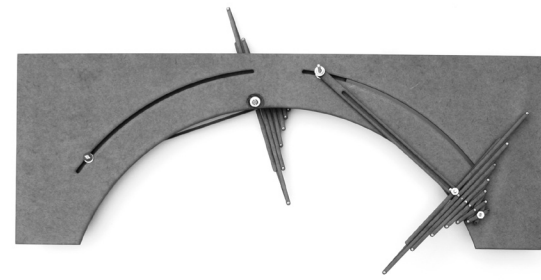

MODEL NAME : OCULUS IV
DIMENSION: 9" x 23.5"
TYPOLOGY OF MOVEMENT : ROTATION AND TRANSLATION

MODEL NAME : OCULUS V
DIMENSION: 23.5" x 23.5"
TYPOLOGY OF MOVEMENT : ROTATION

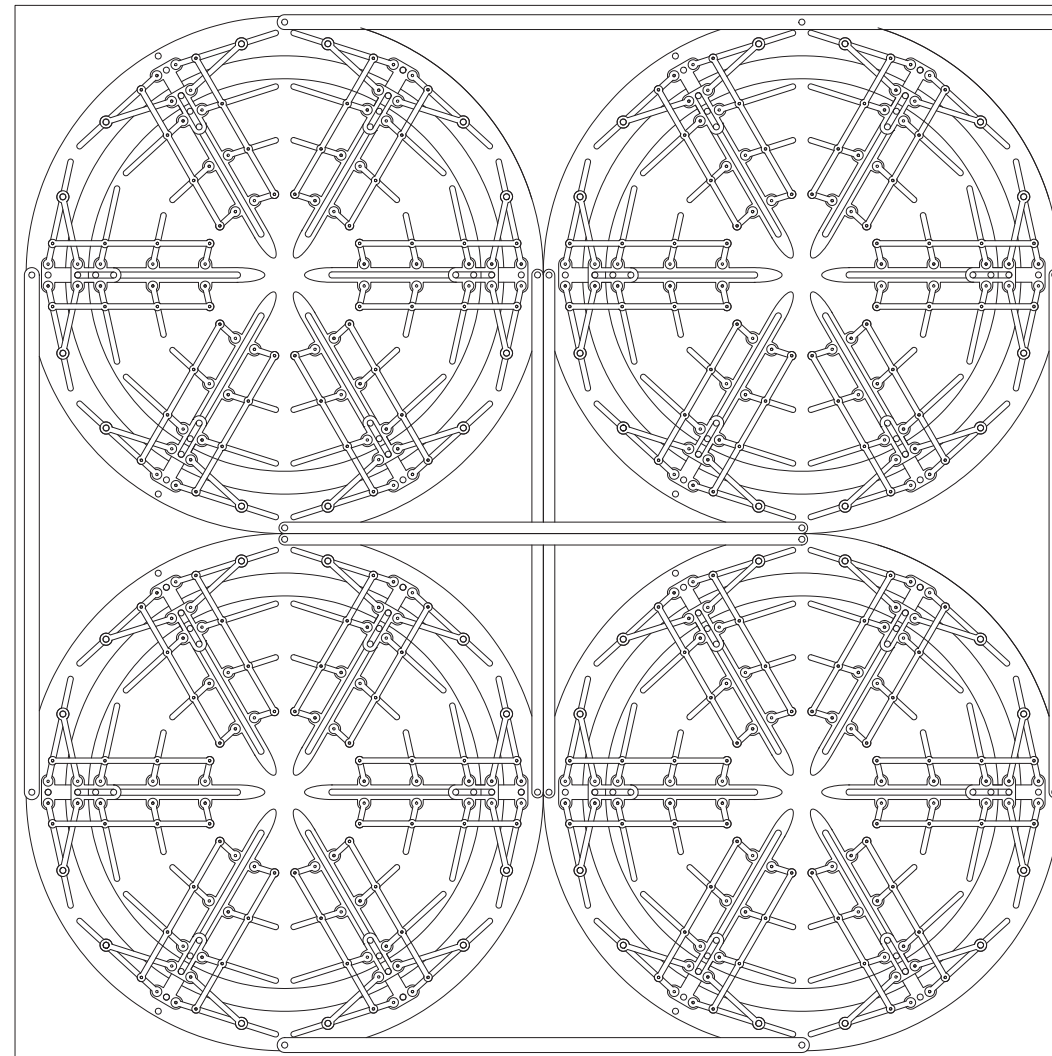

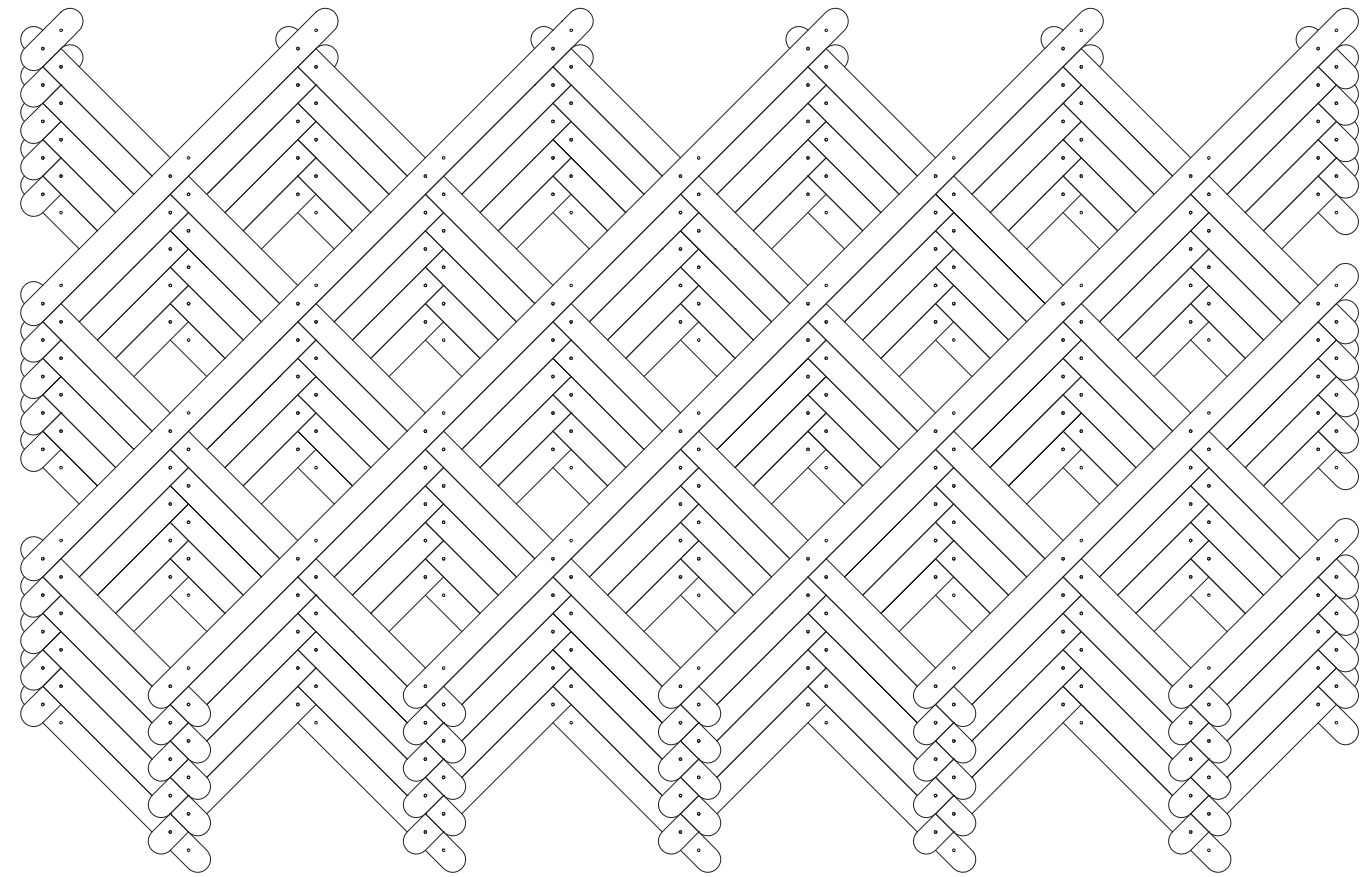

MODEL NAME : TEXTA II
DIMENSION: 25.5" x 17.5"
TYPOLOGY OF MOVEMENT : TRANSLATION

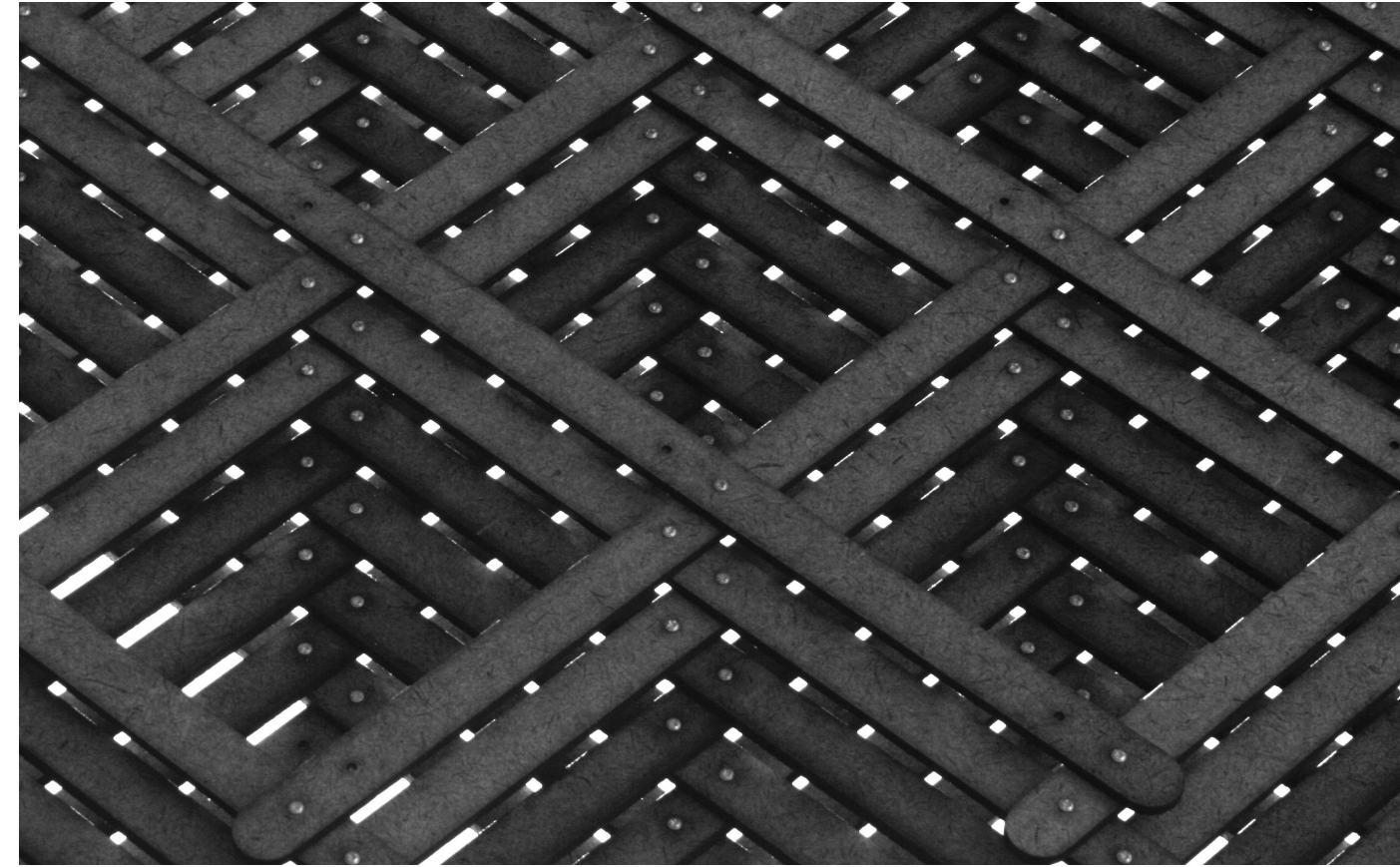

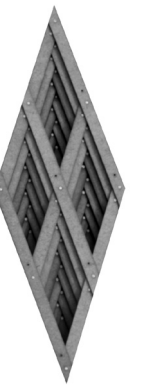
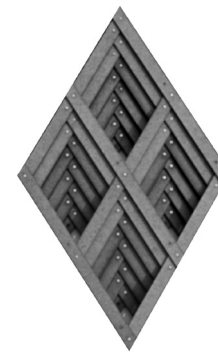
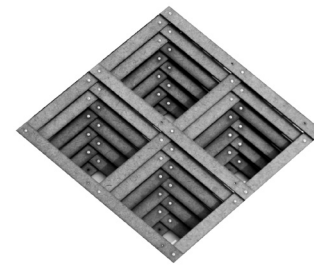
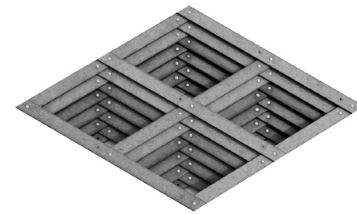
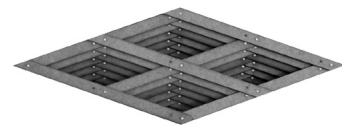
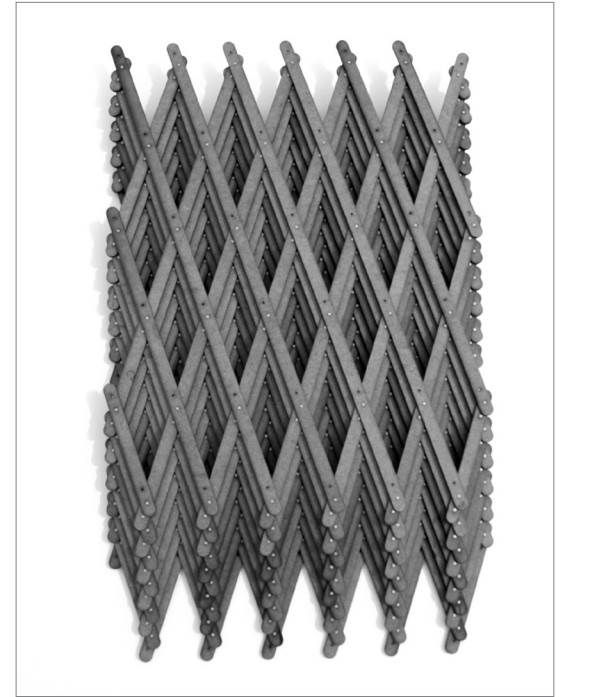
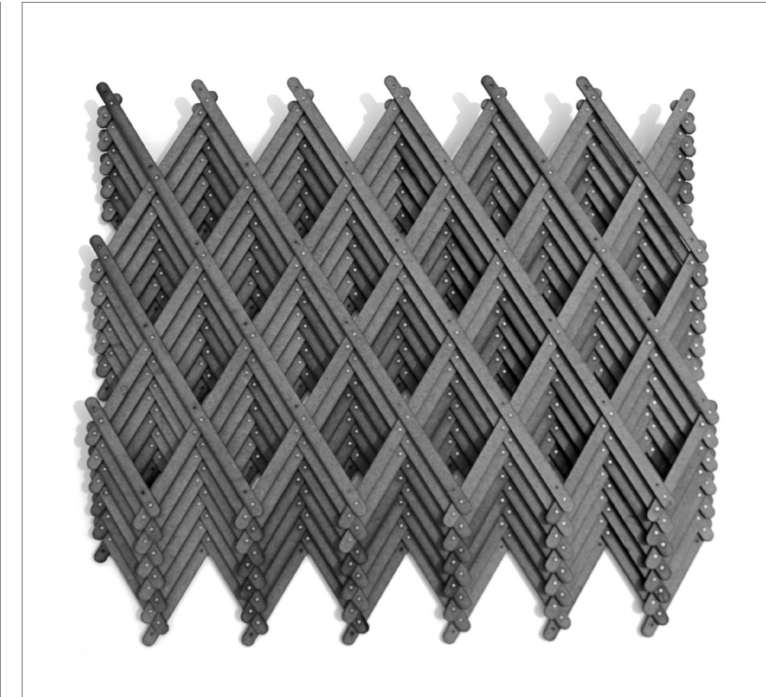
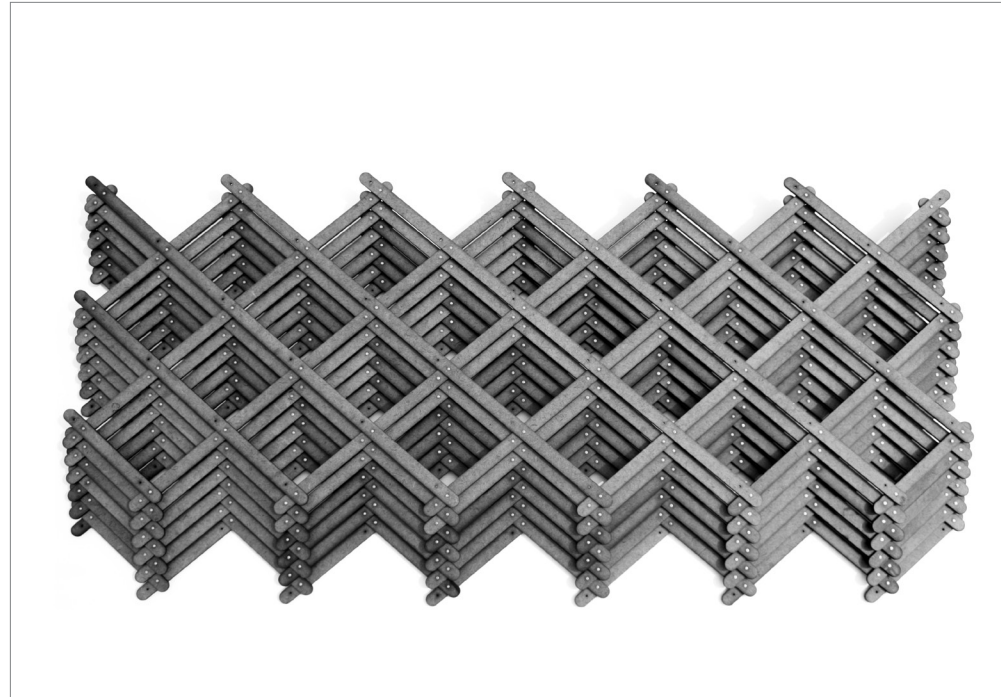
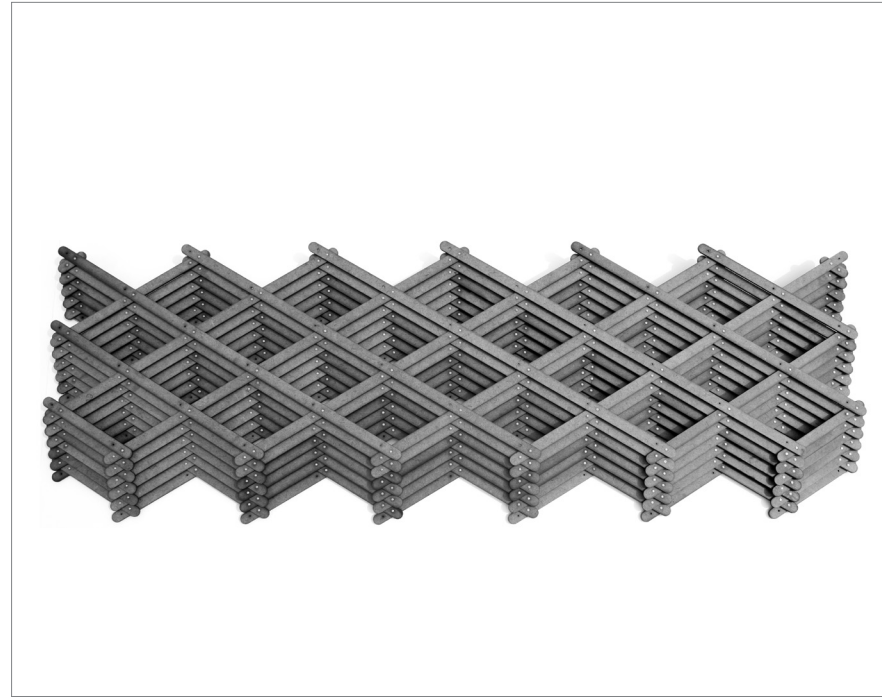
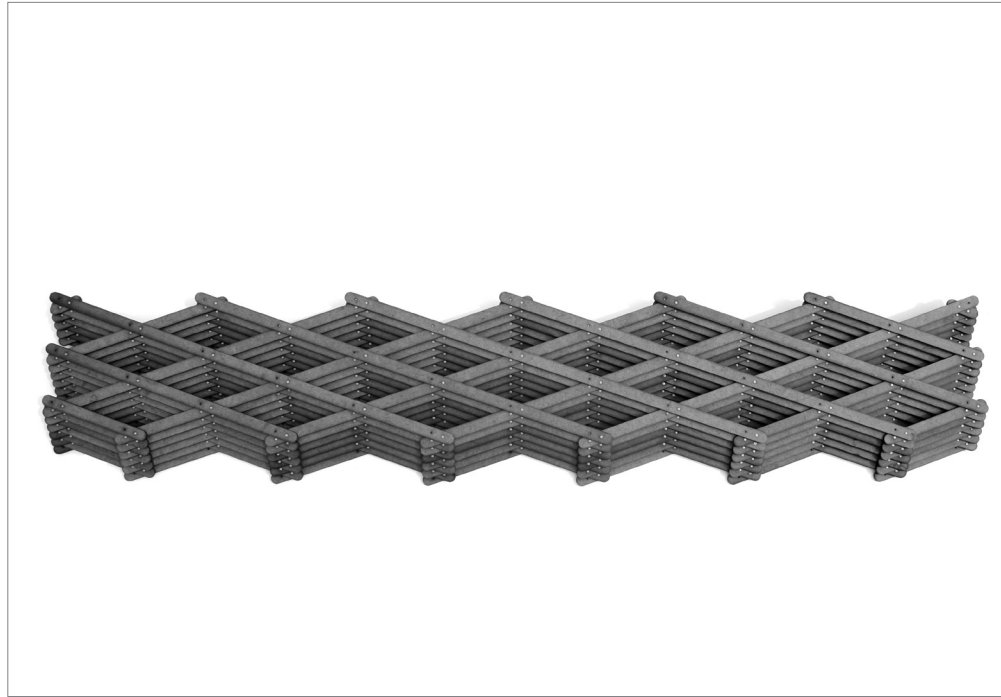

MODEL NAME : TEXTA II
DIMENSION: 25.5" x 17.5"
TYPOLOGY OF MOVEMENT : TRANSLATION

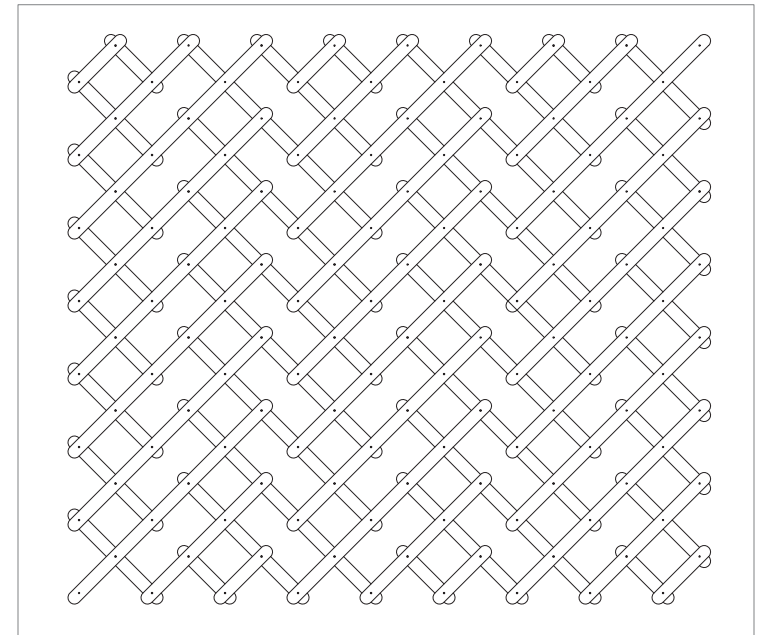
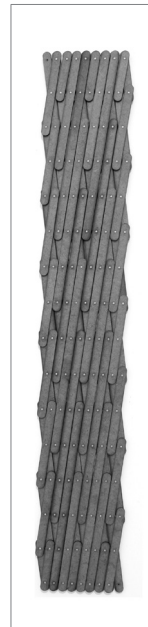
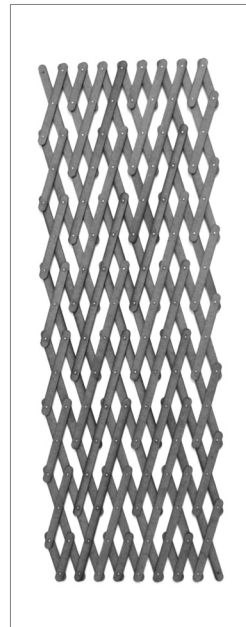
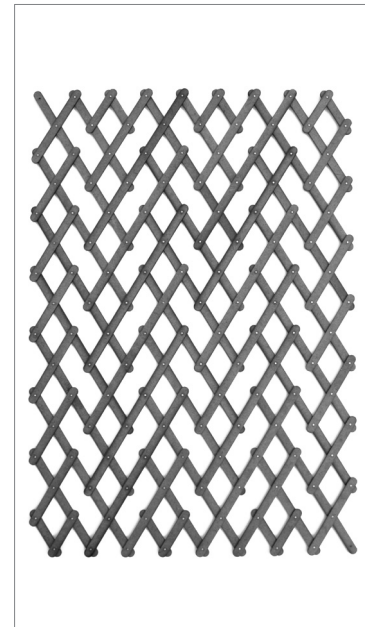
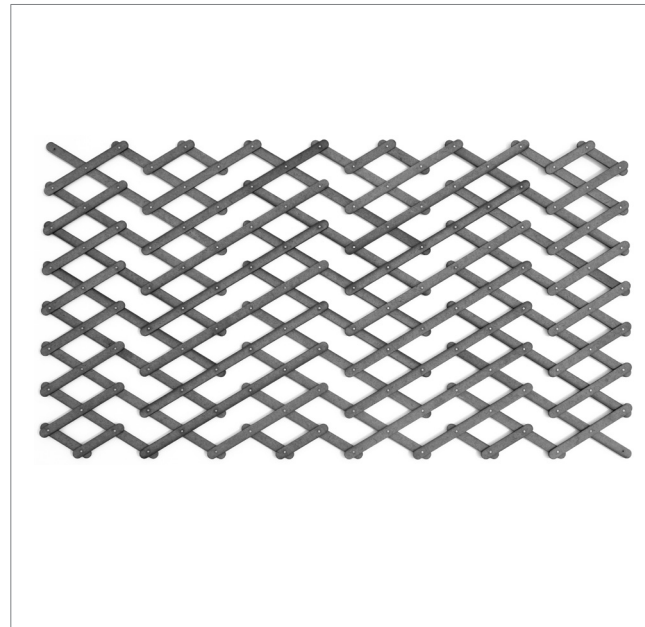
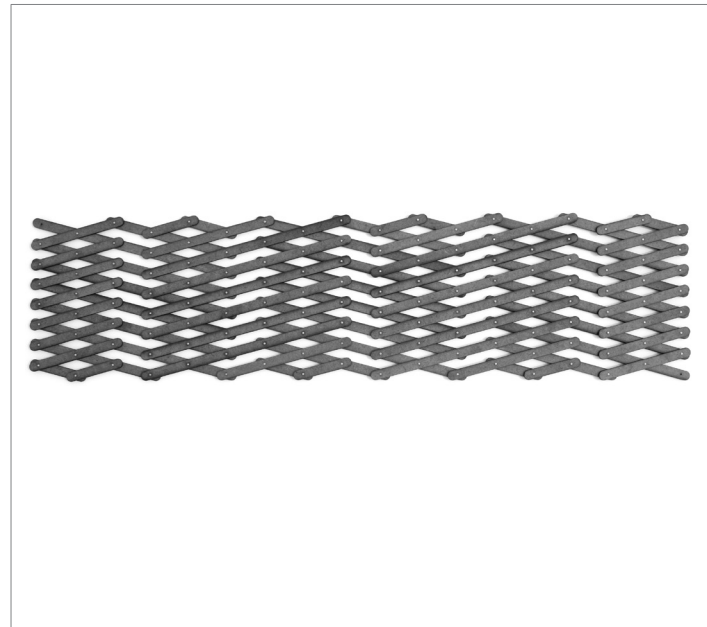
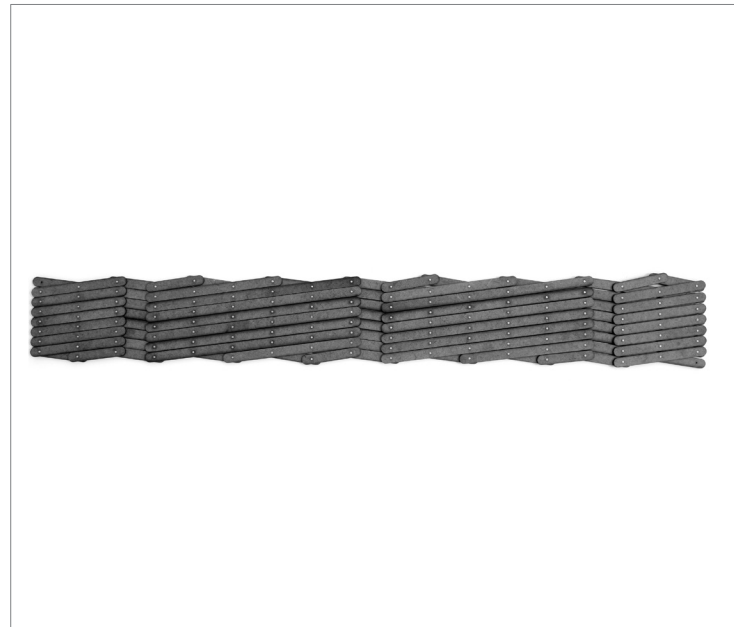

MODEL NAME : TEXTA III
DIMENSION: 25" x 25"
TYPOLOGY OF MOVEMENT : TRANSLATION