



Integrated Design and Manufacturing [IDM] Framework for the Modular Construction Industry

Bandar Alkahlan

Dissertation submitted to the faculty
of Virginia Polytechnic Institute and State University
in partial fulfillment of the requirements for the degree of

**Doctor of Philosophy in
Architecture and Design Research**

James R. Jones | Committee Chair
Elizabeth Grant
Robert Schubert
Jaime Camelio
Tom Hardiman

May 19, 2016
Blacksburg, Virginia, United States

Keywords: Modular Housing, Digital Fabrication, Mass Production,
Mass Customization, Off-Site Fabrication, Assembly.

IRB # 14-781
Copyright 2016, Bandar Alkahlan

Integrated Design and Manufacturing [IDM] Framework for the Modular Construction Industry

Bandar Alkahlan

ABSTRACT

If we look at the construction industry, particularly the modular single-family construction industry, we often see that the design stage is distinctly separate from the construction and fabrication stages. This separation has been occurring for some time now, however, there is often a noticeable lack of understanding of the constraints in linking architectural design to modular construction for single-family housing. In addition, no framework exists which seeks to support overcoming these constraints for the architectural design process while simultaneously bringing knowledge of fabrication, materials selection, and modular construction to the early stage of design. Also, there is a lack of knowledge of fabrication and modular construction constraints by many architects.

This research intended to focus upon mapping the design and manufacturing processes for a specific scale of projects: residential single-family units. The research also aimed to understand the relationships among design, the role of emerging technologies, and manufacturing within the modular home construction industry in order to develop a design process that is based upon mass customization, rather than mass production. Thus, qualitative research methods based upon a grounded theory approach were used for evaluating, capturing, and structuring knowledge. To achieve the greatest possible amount of useful information, case studies of on-site visits to manufactured housing production facilities and structured, in-depth, open-ended interviews of architects, engineers, production managers, business managers, and other knowledge-holders within the manufactured modular housing industry were performed.

The aim of this research was to map the design and modular homes manufacturing processes in an effort to better understand the relationships between these two domains. The Integration Definition (IDEFo) for Function Modeling was used as a graphical presentation technique. The goal of using such a graphical technique was, first, to understand and analyze the functions of the existing “As-is” design-manufacture communication process; and second, to enhance and improve the communication and productivity performances among people working in the design, manufacturing, and production sectors. Using this graphical modeling method assisted with mapping the design and modular manufacturing processes, including organizations, teams, decisions, actions, and activities. Through this mapping process, strategies to improve the emergent relationships were proposed as a new “To-be” design and manufacturing framework for modular single-family housing projects.

Dedication

This dissertation is dedicated to my parents, Sulaiman Alkahlan and Shikhah Alghanim for their prayers, encouragement, endless love and support throughout my life. Thank you both for giving me the strength to chase and reach my dreams. I am extremely grateful for everything that you have provided me with in the past and continue to provide me today to shape my life. It would not be possible to become the best person I can without your guidance, example, and awe-inspiring wisdom.

I also dedicate my work to my mother-in-law Professor Haya Alrawaf and father-in-law architect Faris Alfaris for their unconditional support. Thank you both for taking the burden on and raising and educating such a great daughter throughout my entire academic adventures. I would never be able to pay back the selfless love, care, pain, and sacrifice you both did to make everything I have achieved possible.

To those whom I miss the most and have been there for the start of the journey but were not able to see it through. To the memory of my beloved grandmother Norah Alrukban for her extreme strength, courage and love, and to my dear uncle Professor Mohammed Alrasheed for his constant words of encouragement throughout my graduate career.

Most importantly, to the equal part in this accomplishment my wife Dr. Nasreen Alfaris who has encouraged and supported me the most during my pursuit of the Ph.D degree making the completion of the dissertation possible. I owe my academic success to my best friend, the love of my life, and companion in this journey my loving wife Nasreen whose unwavering support, patience, and trust in me are beyond anything I have ever experienced.

Last, but foremost, I dedicate this dissertation to the person that has given the greatest sacrifice for this work to be completed, my daughter Ghazal. I would like to specifically thank her for giving me up throughout her childhood over 11 years of her life to provide me the chance to pursue my dreams. The years that we have lost being apart have reaped their fruits and I am very excited to starting my new journey with you and finally being your dad.

Acknowledgements

First and foremost, I would like to express my deep appreciation and gratitude to my advisor, Professor James Jones, for the exceptional experience, patient guidance and mentorship he provided me, since our first meeting and throughout the completion of this degree. He has exceeded every positive expectation I had for my advisor and I believe that his unique qualities have made him the perfect fit for my interests and aspirations. On a personal level, Professor Jones's support, understanding, and compassion over the duration of my studies have rendered him a close friend and confidant. His support has not only benefitted me but has touched my entire family and for this we will be eternally grateful.

I would also like to thank my dissertation committee members, Professors Robert Schubert and Jaime Camelio, Dr. Elizabeth Grant, and Mr. Tom Hardiman for all their guidance, suggestions, and valuable comments and feedback which they generously offered over the Ph.D. years.

I would also like to express my deepest and sincere gratitude to my uncle Dr. Abdullah Alrasheed for his unrelenting support and encouragement throughout my academic career.

I must acknowledge my dear friend for twenty years, Dr. Anas Alfaris for being such a great source of motivation and inspiration. Thank you Anas for being available always especially during those moments when you were needed the most.

To my siblings, Bashar, Abeer, Reem, and Maram thank you all for being encouraging, supportive and showing belief in me and my work.

I am grateful to many friends who shared their memories and experiences during my journey. I cannot list all the names here, but you are always on my mind.

Finally, I would like to thank my sponsor, King Abdulaziz City for Science and Technology (KACST), for funding and supporting this research project and for giving me the chance to pursue my Ph.D. degree in an area that I am passionate about. I look forward to my return and contributing to research at KACST.

1. Introduction

1.1 Background	1
1.1.1 Motivation	1
1.1.2 Architect Involvement	2
1.1.3 Issues of Modular Housing	2
1.1.4 Barriers between Design, Fabrication, and Construction	6
1.1.5 The Role of Technology In Support of a Paradigm Shift	7
1.1.6 New Tools for Design, Fabrication and Construction	11
1.1.7 Proscriptive and Prescriptive Theory	12
1.2 Research Approach	15
1.2.1 Goals and Objectives of the Research	15
1.2.2 Problem Statements	16
1.2.3 Research Limitations	17
1.2.4 Research Contributions	18
1.2.5 Overview of Research Methods	19
1.2.6 Thesis Structure	21

2. Literature Review

2.1 Introduction	22
2.2 Current Design Methods	22
2.2.1 Digital Design and Analysis Processes	26
2.2.2 Modeling Using CAD	36
2.2.3 CAD Systems in Architecture	39
2.2.4 The Design Process	42
2.2.5 Information exchange between CAD/CAM	53
2.2.6 Building Information Modeling for Collaborative Design	54
2.2.7 Sequential vs. Concurrent Design Processes	57
2.2.8 Learning from Other Industries	59
2.3 Current Prefabrication, Pre-Assembly and Off-Site Fabrication	61
2.3.1 Digital Fabrication	65
2.3.2 From Mass Production to Mass Customization	65
2.3.3 Fabrication Techniques	65
2.3.4 Design for Manufacturing	69
2.3.5 Design for Assembly	73

Table of Contents

2.3.6 Types of Off-Site Fabrication	77
2.3.6.1 Non-Volumetric Off-Site Fabrication	77
2.3.6.2 Volumetric Off-Site Fabrication	78
2.3.6.3 Modular Building	79
2.3.7 Sources and Causes of Construction Waste	80
2.3.8 Materials Selection	83
2.3.9 Material properties	83
2.3.10 The CES Material and Process Selection Software	83
2.4 Transportation	86
2.4.1 Truck	87
2.4.2 Trailers	89
2.4.3 Modular Transport	90
2.4.4 Rail Transportation	90
2.5 Assembly	91
2.6 Summary	92
2.7 Suggested Strategies	93
3. Methodology	
3.1 Introduction	96
3.2 Immersive Study - Grounded Theory Approach	98
3.3 Literature Review	100
3.4 The Case Study as a Research Tactic	101
3.5 Interviews as a Research Tactic	103
3.5.1 The Pilot Test	104
3.5.2 Avoiding Bias	106
3.5.3 Questionnaire Structure	107
3.6 Triangulation and Information Validity	108
3.7 Modeling Methodology – IDEF	108
3.8 Framework Development	110
3.9 Summary	112
4. Immersive Study Interpretation	
4.1 Introduction	113
4.1.1 Data Collection Process	113
4.1.2 Analysis Steps of Interview Data	114
4.1.3 Profile of the Interviewees	117

Table of Contents

4.2 Findings from the Interviews (Qualitative Data)	120
4.2.1 The Benefits of the Modular Construction Method	121
4.2.2 The Key Stakeholders Typically Involved in a Modular Home Project	125
4.2.3 Design Process	128
4.2.4 The Decision Makers Involved in the Design Phase for Modular Homes	129
4.2.5 Modular vs. On-Site Construction in Terms of the Client’s Involvement	130
4.2.6 Advanced Technologies Utilization	132
4.2.7 The Common Project Delivery Methods in Modular Home Industry	135
4.2.8 The Information Flow from Design to the Manufacturing Phase	140
4.2.9 Bottlenecks in the Information and Production Flow that could Cause Delay	144
4.2.10 Common Design Problems and Issues for the Modular Construction Method	147
4.2.11 Guidelines for Designing for Modular Homes	150
4.2.12 Modular Production Process	151
4.2.13 Transportation Process	152
4.2.14 On-Site Assembly Process	153
4.2.15 Summery and Recommendations	153
5 .The IDM Framework	
5.1 Introduction	156
5.2 The Framework Development Process	156
5.3 Integration Definition for Function Modeling (IDEFo)	157
5.3.1 Types of IDEFo Diagrams	159
5.3.1.1 Top-Level Diagram	159
5.3.1.2 Parent Diagram	160
5.3.1.3 Child Diagram	160
5.4 Mapping the “As-is” Framework	162
5.4.1 The Overall Modular Construction Process	165
5.4.2 The Conceptual Design Process	167
5.4.3 The Design Development Process	168
5.4.4 The Production Process	169
5.5 The “As-is” Framework Related Issues	174
5.5.1 Lack of Architect Involvement	174
5.5.2 Direct Communication Challenges	179
5.5.3 Building Systems	182
5.6 Enclosure System as a Sub-Model	186
5.6.1 Scenario 01 (Sectioning-A)	189
5.6.2 Scenario 02 (Sectioning-B)	190
5.6.3 Scenario 03 (Tessellating)	191

Table of Contents

5.7 Building Enclosure Specialists—Case Studies	192
5.8 Closed systems	194
5.9 Open systems	194
5.10 Mapping the “To-be” Framework	195
5.10.1 The “To-be” Overall Modular Construction Process	196
5.10.2 The “To-be” Conceptual Design Process	197
5.10.3 The “To-be” Design Development Process	198
5.10.4 The “To-be” Production Process	199
5.11 Interviewees Feedback and Comments	206
5.11.1 The Architect’s Involvement	206
5.11.2 The New Communication Process	208
5.11.3 The Implementation of the Enclosure Systems	209
5.11.4 The Proposed “To-be” IDEFo Framework	210
5.12 Summary	211
6. Summary and Conclusion	
6.1 Introduction	212
6.2 Research Summary and Findings	214
6.3 Contributions to the Body of Knowledge	220
6.4 Future Research	221
7. References	224

1. Introduction

1.1 Background

1.1.1 Motivation

In this new era of architecture, modular buildings have become an important sub-market. A goal of the modular building industry is to reduce construction time and cost, as well as increase quality and energy efficiency. However, modular buildings are generally being used for hospitals, schools, offices and other commercial projects and much less in the residential sector. Although there are potential benefits to single family housing from modular construction, these remain a small percentage of total home construction. Some major drawbacks contributing to this small percentage are: 1) the lack of an impact from architects on the single family housing sector, 2) limited design variation, and 3) multiple stakeholders. Hence, there is a need to expand the role of modular buildings to fulfill current needs and develop the housing industry based upon mass customization, not mass production. This would assist in the delivery of manufactured homes as a final product and support variety in the modular housing industry.

In recent years, the Architecture, Engineering, and Construction (AEC) industry has been influenced by several technological advances such as digital design processes, new materials, and digital manufacturing practices. Digital geometrical modeling and analysis processes based on Computer-Aided Design (CAD) have resulted in building projects with complex and irregular geometries that serve variable functions. In addition, materials are playing a major role when making decisions about the performance of buildings. Building elements are typically composed of a combination of different materials based upon the project goals, with architects and engineers pushing for higher performance and efficiency, making the evaluation and selection of materials more critical. Computer-Aided Manufacturing (CAM), digital fabrication and mass-customization have become important aspects for designers, assisting them in building the complex designs they had explored and developed. These designs would often not have been possible to construct or assemble without the ability to exchange digital information between CAD/CAM technologies.

In the past two decades, these advances have resulted in significant changes to the building design process, the construction industry, and the ways in which architects and engineers perform their work. However, the relationships among the digital design processes, materials, and digital manufacturing practices, based on the information flow remain unclear and further exploration is needed. The new AEC and fabrication technologies offer opportunities to bridge the gap between architecture, fabrication and modular construction to provide a positive impact on the single family residential construction sector.

The goal of this research is to map the design and manufacturing processes with the goal to support variety in the modular house industry.

1.1.2 Architect Involvement

Freedom to Build, by John Turner and Richard Fichter, was published in the early 1970s. In their volume of planning essays, Turner and Fichter claimed that approximately one-third of the world's population built their own homes. Every year, they said, more than 160,000 families in the United States avoided the cost of hiring a builder and instead, chose to build their homes by themselves (Deamer and Bernstein, 2010).

A principal cause for the phenomenon described by Turner and Fichter was the cost of architects. In the 1970s, architects often failed to understand and incorporate the needs and wants of the end user into their housing plans. Cost reductions, for example, could easily have been achieved if architects had been willing to develop new systems to build economic homes based upon the availability of materials and construction technologies.

As a result of the disconnect between architects and home owners, the home builders took the lead in building residential projects, which increased the gap between the architects and home owners. Forty years later, 90 to 95 percent of residential building projects in the United States were not designed by architects. Architects were instead limited to specific kinds of projects, such as luxury housing, landmark projects and high rise buildings, which were typically designed by very well-known architects (Deamer and Bernstein, 2010).

The growing number of merchant builders has affected the aesthetic outcome and quality of residential projects, since their goal was to maximize their profits by building as many of these projects as quickly as possible. This is not surprising, however, when we understand that the main reason for this transformation in the architectural field is the separation from construction and fabrication processes. The architecture profession needs to rethink the focus of the Bauhaus school and integrate fabrication and production methods as part of their design ideas. This is one way to limit outsiders from entering the architectural profession.

1.1.3 Issues of Modular Housing

Modular construction might be considered the future of the home building industry; however, a recent study concerning U.S. housing production trends by Mullens (2011) reaches different conclusions, finding no increase in production for the modular housing sector for the last decade. In his book, *Factory Design for Modular Homebuilding*, Mullens presented a comparison

among the three major housing production trends based on market share: housing starts, manufactured (mobile) homes that built in conformity with federal codes governed by the U.S. Department of Housing and Urban Development (HUD), and modular homes. The housing starts term refers to on-site construction, including single-family housing, two to four-unit housing (townhouses or small condos), and apartment buildings with five or more units. Although manufactured homes and modular homes are manufactured in a factory, they are different. Manufactured homes, besides being based on HUD Code, are constructed on permanent steel chassis, where modular homes are built in a similar fashion to on-site construction based on the state and local building codes. Each region has its own regulations, which are typically stricter than federal codes. In addition, modular homes can be built without restrictions in most housing neighborhoods, where manufactured homes are limited to specific zones based upon the state building codes and local zoning regulations (Gianino, 2005). Figure 1.1 shows a statistical comparison of the market share between the U.S. housing production trends (Mullens, 2011).

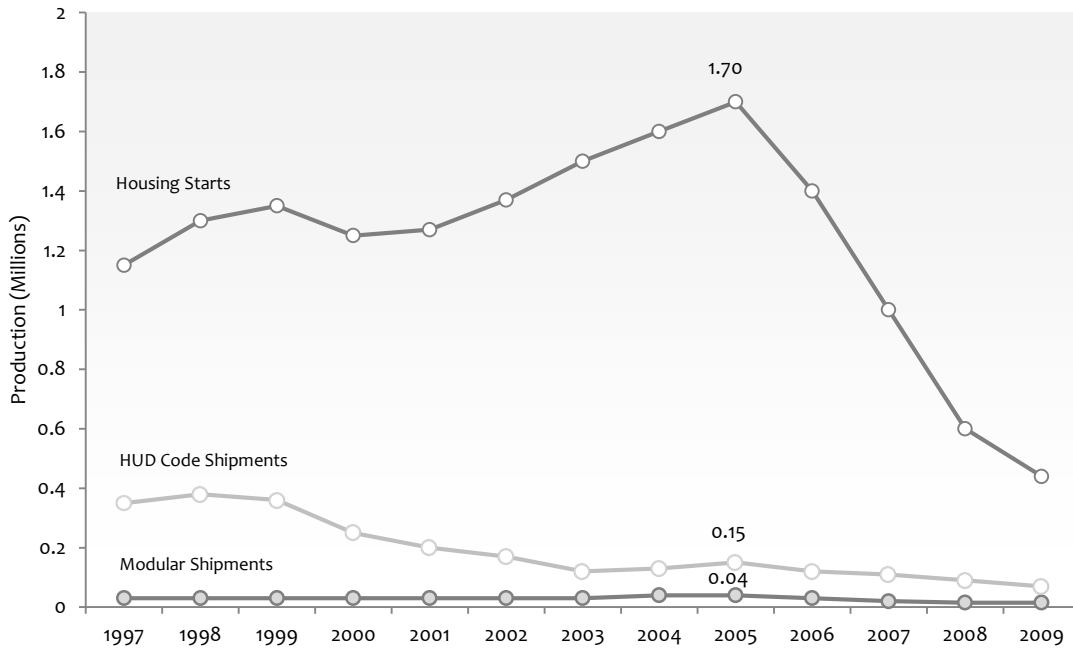

Figure 1.1: The market share between the U.S. housing production trends, adopted from Mullens (2011)

Mullens' comparative study (2011) found that modular homes production has maintained two to three percent of the market share throughout the rise and fall of the housing market, whereas the market share for manufactured homes production (HUD Code) significantly decreased through the same time period. According to Mullens, as a result of this loss, three of the largest manufactured homes companies converted to the modular homes business and are still considered the largest modular producers.

In another study, Mullens (2011) analyzed the data from different sources from 2002 through 2006 in order to develop an estimate of market share based on different home construction technology. Table 1.1 presents a profile of different home construction technology based on the market share in the U.S. (Mullens, 2011).

Table 1.1: Profile of home construction technologies

Technology	Market Share
Stick-built	55%
Concrete masonry	14%
Panelized	13%
HUD Code	9%
Insulated Concrete Forms	4%
Modular	2-3%
Steel Frame	2%
Structural Insulated Panels	<1%
Other	<1%

Gianino (2005) identifies many potential benefits from modular construction. In his book, *The Modular Home*, Gianino states that:

Modular construction has become the construction method of choice for the quality-and cost-conscious house buyer. The best-built modular homes are better built than the vast majority of stick-built homes. Modular homes offer better materials, state-of-the-art construction technology, superior finished quality, and time and money savings. And you gain all of these benefits without sacrificing either design or amenities (p. 24).

Although Gianino points out some important benefits that modular construction may provide, the market share result by Mullens (2011) showed that so far, this construction method has only been applied to a small percentage ranging from two to three percent of overall single-family home production (Figure 1.1). This means that modular construction still did not reflect a suitable level of importance as a superior technology.

Mullens lists design issues, architects/designers and modular producers as the major causes of the low economic growth of the modular construction industry. Limited design variation has been cited as an issue for modular producers. Most home buyers consider a non-standard design floor plan a very important factor for their future new home design. Architects/designers need to understand the factory production advantages and limitations in order to develop new design processes, features and various different options that might not be viable in comparison with the traditional method of construction. In addition, most modular producers are still based on



low technology mechanized hand tools. According to Mullens, critics have called that “stick build under a roof.” Therefore, there is a need for rapid transition to take advantage of modern technologies in manufacturing, since it is faster and can produce better quality and adaptation to the modular construction industry (Mullens, 2011).

Today, computer-aided design (CAD) and computer-aided manufacturing (CAM) create better opportunities to link the role of architects with the production and fabrication processes. CAD/CAM function as technological tools; they can be used to explore new forms and complex shapes or for developing innovative designs and ideas derived from industrialized production.

We know that emerging technologies will likely redefine design processes. In order to achieve this, Paolo Tombesi believed that new graduate architects should take technical positions with building-trade subcontractors to increase their knowledge of manufacturing and fabrication processes. The chief motivation for linking young architects with building-trade subcontractors is to combine industrial experiences such as managing cost, quality, schedules and fabrication processes with their design credentials (Deamer and Bernstein, 2010).

In the modern digital age, the field of architecture has become more complex with the integration of the CAD/CAM tools. A reason behind this complexity is the increasing amount of information that an architectural firm needs to produce a design and document the project. Therefore, there is the need for a system of data management and information exchange among different disciplines, one, which will reduce costs and time, while increasing quality and profits. Achieving this requires better communication skills and an understanding of digital fabrication techniques.

The transformative power of digital technologies is very promising for architects, which can revisit their role as the master-builder. Through this transformation, architects will be responsible for exploring and generating the design, as well as for generating the construction documents and fabricating the final products. In addition, the new digital paradigms will need component management tools to increase the level of collaboration among architects, engineers, contractors, subcontractors, fabricators, and others.

Design and fabrication technologies can focus on improving the quality of production processes. However, these technologies might not necessarily solve existing issues concerning stakeholders within the building industry, suggesting the need to rethink the relationships among these stakeholders. Redefining these relationships can help to reduce risks in production and in the variance for expected results among the client, architect, engineer, general

contractor, subcontractor and fabricator. Digital technologies have the potential to overcome the barriers among design, fabrication and construction.

1.1.4 Barriers between Design, Fabrication and Construction

Branko Kolarevic, in his text *Between Conception and Production*, began by quoting a statement made by Renzo Piano:

An architect must be a craftsman. Of course any tools will do; these days, the tools might include a computer, an experimental model, and mathematics. However, it is still craftsmanship-the work of someone who does not separate the work of the mind from the work of the hand. It involves a circular process that takes you from the idea to a drawing, from a drawing to a construction, and from a construction back to idea (Deamer and Bernstein, 2010, p.67).

Kolarevic argued that as a result of merging digital technologies into the design and production processes, the role of craft and ‘making’ should no longer be apart from the design process. Kolarevic believed that the advanced technologies of digital fabrication would assist the designers in exploring different outcomes, searching for innovative ideas and systems from the earliest stage of design.

Kolarevic claimed that within the availability of different Computer Numerical Control (CNC) processes such as shaping and reshaping based upon cutting, subtractive, additive, and formative fabrication, designers needed to understand and be more directly involved with the machine capabilities of each of these fabrication techniques. This, in turn, would guide designers to design specifically for the limitations of those machines. Designers should take into consideration not only the conception phase of design, but the production process as well. Further discussion of this process will be included in the next chapter.

Imagining Risk, a text by Scott Marble, discussed the meaning of craft “as a skill developed over time and in direct relationship to making and to working with materials, however he argues that architects have long been disconnected from this skill, relying instead on builders and fabricators to actually carry out their designs” (p.39) (Deamer and Bernstein, 2010). Marble argues that if the architects do not take their work from the abstract processes of representation to production, this may result in inappropriate processes of production. Without expanding the designers’ knowledge of production and techniques, the most creative designs will not be built the way they envisioned.

1.1.5 The Role of Technology In Support of a Paradigm Shift

There is an unambiguous relationship between technology and the speed of development. Paul Virilio is one of the most significant French cultural contemporary theorists and is the originator of concepts such as 'Dromology' (the 'science' of speed). The importance of Virilio's theoretical work stems from his central claim that the modern city is being disorganized by technologies. Virilio believes that technologies interrupt the reality of the world and he coined the phenomenon of "derealization". So, what are the effects of the "derealization" toward architecture, as Virilio described it?

Virilio is concerned that the new communication and telecommunication technologies are leading to the feeling that the reality of the world has been changed or lost (Hays, 1998). He writes: "The way one gains access to the city is no longer through a gate, an arch of triumph, but rather through an electronic audiencing system whose users are not as much inhabitants or privileged residents as they are interlocutors in permanent transit" (p.543) . In this statement, Virilio says that the old city disappears since the new technologies appear to be very important. In other words, he points out how the old "real" boundaries of the city have been changed and transformed, particularly by information technologies. These have replaced the old city walls and one can no longer access the city through its gates. Nowadays, the airport is the gate of the city.

In addition, Virilio says that because of these communication and telecommunication technologies, the form of the building became less the result of an individual architect's personality than of the necessary precautions taken for public safety. Virilio looks at the architecture as a style, an extraordinary thing and kind of practice which underwent many changes by telecommunication.

Moreover, Virilio sees architecture as space and place as permanent volume. He mentioned how the "construction materials are virtually being eliminated. With the emergence of portative structure, curtain walls made of light and transparent materials (glass, plastic) are replacing the stone facade at the same time that the tracing paper, acetate and Plexiglass used in project studies are replacing the opacity of paper" (p.543) .

Virilio went on to describe how these new technologies made a huge impact on architecture. He notes that the speed at which something happens may change its essential nature. This brings us to the question, as Virilio puts it, of whether it is "architecture or post architecture?" Architecture as a field and style has changed by the emergence of new technologies, which put architecture under the new name of post architecture.

We are blessed for having these new communication and telecommunication technologies. However, everything in this world has positive and negative points and it is we who use them either positively or negatively. So, the reality of the world doesn't change. This is about the time, period and era in which we live. As long as we are still studying, researching and discovering new science, the world is going to develop our reality, because reality is an evolution.

In the same way, architecture as a field is going to progress with the developments occurring in the world. Besides this, the main concept and meaning of architecture is the same in any time and era. What changes is the way we deal with it.

These communication and telecommunication technologies may make architects more creative, because these technologies may add to the development of an idea. For example, the Guggenheim Museum Bilbao (Figure 1.2), which was designed by architect Frank Gehry, is one of the most important projects for many architects. It extends the boundaries of architecture. The building itself is an extraordinary combination of interconnecting shapes and curved, twisted forms. The mathematical complexity of the design was not possible to complete without the aid of computer software. From this example, we can see how these technologies actually help architects to test and develop new ideas. In addition, telecommunication has made the world into a small society and this aided architects to break out from their local social constraints to be inspired by other cultures.

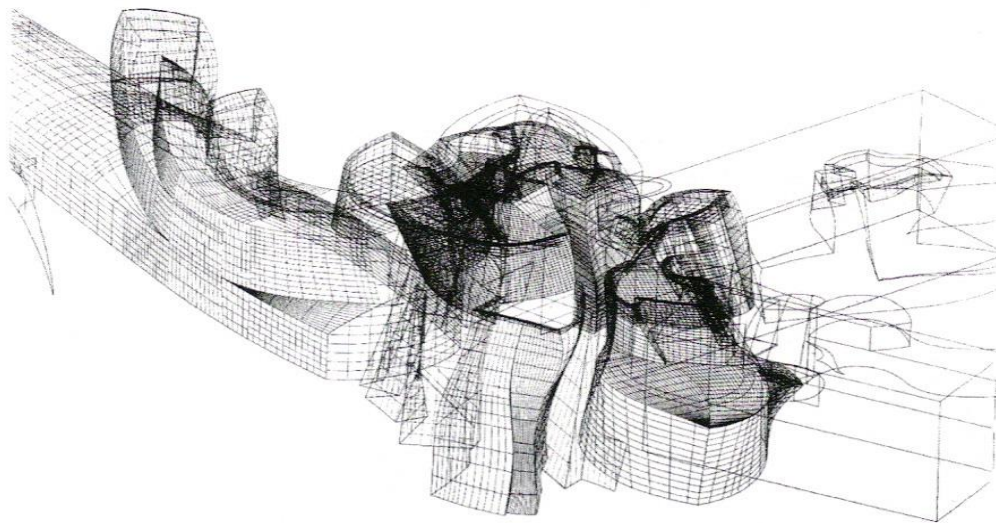



Figure 1.2: Guggenheim Museum Bilbao, 1991-1997, Spain (Kolarevic, 2003)

Technologies extend the resources available to architects. However, these rapid changes are having a serious effect on architecture. Charles Jencks is the first to theorize the post-



modernism movement from the perspective of architecture. He begins from the position that architecture should be looked at as a form of communication. He calls for an iconic building which shares certain aspects both with an iconic object and the philosophical definition of an icon. To become iconic, Jencks believes that a building must provide a new and condensed image, a unique shape that stands out from the city. He believes that in architecture, we have to use our imagination. He says “in architecture, to name a metaphor is often to kill it” (Jencks, 1977).

Jencks believes that being almost unlike anything before is important. In his book *The Language of Post-Modern Architecture*, he described and explained many examples to show why good buildings are inherently different, demonstrating different meanings and creativity.

For Jencks, architecture is a style, language and communication. It is not about space, cost, material or a program. He believes that we should use science in architecture. In other words, the new sciences of complexity-fractals, nonlinear dynamics, the new cosmology and self-organizing systems - have brought about the change in perspective. Jencks linked architecture with the new sciences, so that when our view of science changes, then architecture changes with it.

Jencks argues that in modern architecture, all buildings are the same. They are too simple. This simplicity led the buildings to become pure volume, like “shoe-boxes” or “filing cabinets” to the public. These boxes have nothing to do with communication. Moreover, Jencks argued that modern architects deny the most potent metaphorical level of meaning - the diversity of people’s imaginations. Jencks says that modern architects are instead focusing on cost and function. In other words, they are designing buildings not to be beautiful but to function well. In spite of Jencks’ opinion, focusing on cost and function as priorities remain of primary importance to architects today. In addition, we could combine both modern and post-modern architecture. In this manner, the result would be a strong concept, style, function and an efficient cost.

Jencks’ argument relies too heavily on qualitative analysis of the design. However, there is a need to adopt a design process and method that can not only transfer knowledge from previous design experiences, but also integrate the science of crafting as part of the knowledge-capturing evolution within and across the design process. Furthermore, architects and architectural schools should develop their use of technologies from the representational paradigm to combine with the crafting paradigm. It is especially important to combine the ability

to exchange information digitally between computer-aided design and computer-aided manufacturing technologies.

While a variety of definitions for the term “paradigm shift” have been suggested, among the first was proposed by the epistemologist and historian of science, Thomas Kuhn, who in 1962, published a book titled *The Structure of Scientific Revolutions*, in which he described that new and progressive science generally is not always a result of linear development and build-up of previous knowledge, but through a fundamental change in resolving problems and methods of research. In his book, Kuhn (1962) identified three different stages of scientific progress, which are, prescience or pre-paradigm, normal science, and revolutionary science. In the prescience stage, the research community does not articulate on a particular theory or research method for a specific paradigm. Accordingly, when the scientists have agreed to a specific application, terminology, methods, techniques, and experimental forms that may contribute to understanding and exploration, the second stage begins. In normal science, scientists focus on the established paradigm and then attempt to solve the remaining scientific puzzles.

Typically, scientists often attempt to solve problems based upon their knowledge and what is available within their own domain. “The man who is striving to solve a problem defined by existing knowledge and technique is not just looking around. He knows what he wants to achieve, and he designs his instruments and directs his thoughts accordingly” (p.96). However, there are limits to how far the stage of normal science can be taken. Progress in normal science may reveal anomalies that are difficult to clarify in the framework of the existing “paradigm”. While they can usually be resolved, these anomalies in some cases may accumulate to such a degree to become critical (Kuhn, 1962).

Once the crisis reaches the point where it cannot be revised within current normal science, the third stage originates, which is the revolutionary science, as termed by Kuhn. This transition is a result of part or whole shifts from one paradigm to a new one that may direct innovative results. In some cases, scientists within a specific field cannot reach the third stage since they do not have the required research methods or instruments. Therefore, when more advanced instruments are developed, a future generation may shift from the current to a new paradigm. If the researchers and scientists agreed upon the planned transition, a “paradigm shift” occurs as can be seen from Figure 1.3. Further discussion regarding the new paradigm in architecture will be illustrated next.

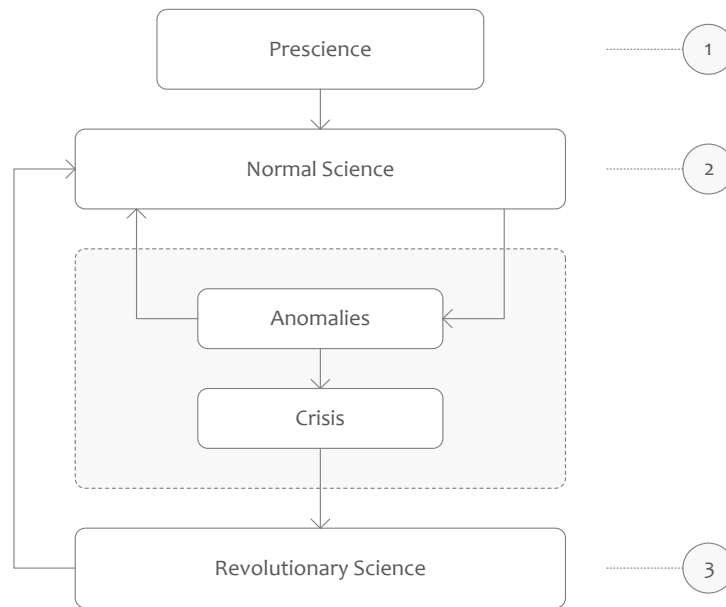

Figure 1.3: The scientific progress cycle based on Thomas Kuhn

1.1.6 New Tools for Design, Fabrication and Construction

As described by Marble, digital processes in architecture have generally followed one of three directions. First, the exploration of new shapes and complex forms as a result of direct exploration with 3D computer software scripts or codes. Second, to organize and manage the enormous volume of information that has been produced for a specific building project. Third, the concept of “from file to factory,” where the development of digital fabrication assisted in linking the architect’s designs directly to the production tools (Deamer and Bernstein, 2010). The integration of these three directions will help achieve the best result in an architectural production system.

Today, the emergence of new tools such as Computer Numerical Control (CNC) systems extend the domain of ‘craft’ in architecture and may support a new process of design. In this case, the architect’s ideas are integral with production processes through a common language: digital information. Knowing the different CNC techniques and limitations may alter how ‘ideas’ are generated.

Coren D. Sharples, in his text *Technology and Labor*, discussed the importance of organizing information flowing from the design to the construction phase. Architects can improve their knowledge of construction by determining the project delivery method at a much earlier stage, which will influence the direction and the development of the intended project (Deamer and Bernstein, 2010).

It is very important to determine the collaborative relationships among architects and other disciplines early in the process. In order for an architectural firm to establish a good collaborative relationship with other industries, the client should clearly define the architect's role prior to the concept stage. This will assist in initiating organized platforms of communication such as Building Information Modeling (BIM). BIM has advanced information sharing and collaborative design. This enhanced collaboration can help move housing projects to the next level of integration by connecting architects, engineers, contractors, fabricators and manufacturers.

1.1.7 Proscriptive and Prescriptive Theory

Historically, architects have been inspired and motivated by the experiences and lessons learned from the past. Styles were developed in response to human needs during specific periods of development and in certain climatic and geographic regions. The development of a style was based upon the availability and variation of materials and construction techniques. For instance, the style of ancient Egyptian architecture remained essentially the same for a thousands of years. This type of architecture was rich with symbolism (Neal, 2001).

Presently, technology has morphed the implication of style as a response to regional characteristics to a reflection of technology itself, reducing the length of time that a given style endures (Neal, 2001). The advent of modern technology has allowed the diversity of past architectural styles to merge. While new technologies do not allow us to predict the future, they are allowing architects to generate new solutions that create better lives for people.

Many theorists have argued that technologies have influenced and changed some disciplines. In 1935/1936, Walter Benjamin wrote his essay "The Work of Art in the Age of Mechanical Reproduction," influencing the fields of cultural studies and media theory. Benjamin wrote that a theory of art would be "useful for the formulation of revolutionary demands in the politics of art." In Benjamin's opinion in the absence of any traditional, ritualistic value, art in the age of reproduction would inherently be based upon the practice of politics (Benjamin et al., 1968).

Benjamin was concerned with how new technologies influenced the development and use of media that in turn affected art. He theorized that in principle, a work of art has always been reproducible, but even the most perfect reproduction of a work of art is lacking in one element: its presence in time and space. He also explained how the presence of the original is the prerequisite to the concept of authenticity which is the quality of being real or true.

Moreover, Benjamin used the word "aura" to refer to the sense of awe and reverence one presumably experiences in the presence of unique works of art. According to Benjamin, the aura

of the latter is defined as the unique phenomenon of distance, however close it may be. Benjamin states that “If, while resting on a summer afternoon, you follow with your eyes a mountain range on the horizon or a branch which casts its shadow over you, you experience the aura of those mountains, of that branch” (p.222). This imagery makes it easy to comprehend the social bases of the contemporary decay of the aura. Benjamin seeks to explain how the original works could lose their aura by being duplicated. At first, originals of famous paintings could only be viewed in a museum. However, with new reproduction technology, we may now have unlimited copies of this artwork and the quality of some of these copies can reach a superb level. In spite of our great strides in technology, we are still going to lose the quality of the original color, the original random proportions, and the original texture. Secondly, the quality of the work should be what matters, not quantity.

As can be seen from Figure 1.4, for example, the loss of aura is clear and visible. When a piece of art (image 01), leaves its original owner and is duplicated numerous times (image 02, 03, 05, and 06), it loses its authenticity, color, proportion, and sometimes even the copy’s direct relation to the original (image 04).

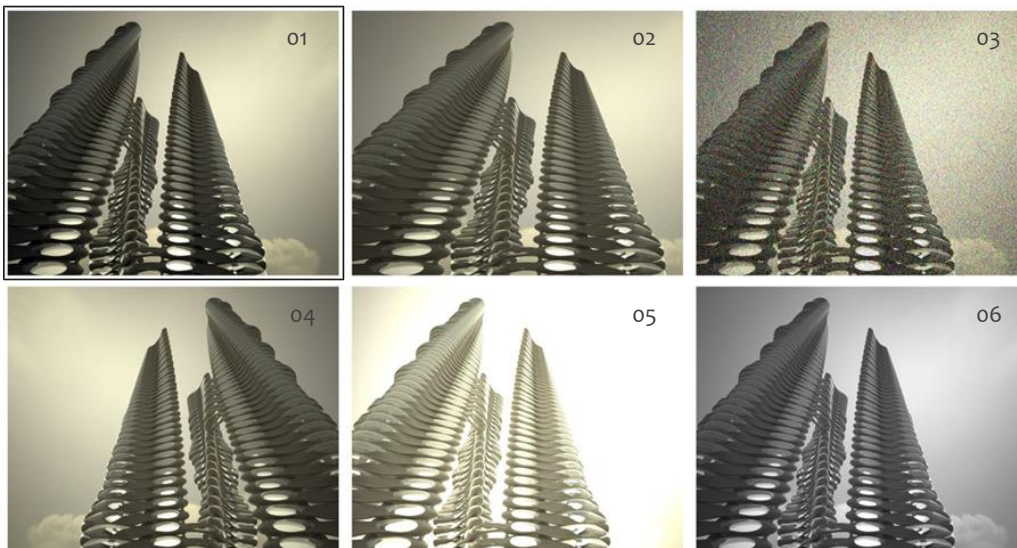



Figure 1.4: The loss of aura

For Benjamin, photography was a result of lithography, where lithography enabled graphic art to illustrate everyday life, subsequently keeping pace with printing. Nevertheless, only a few decades after its invention, lithography was surpassed by photography. For example, in photography, process reproduction can bring out those aspects of the original that cannot be detected by the naked eye yet is accessible to the lens, which is adjustable. Photographic



reproduction, with the aid of certain processes such as enlargement or slow motion, can also capture images which are beyond our natural vision. In addition, Benjamin explained that technical reproduction could put the copy of the original into situations which would be out of reach for the original itself.

Benjamin proposed, for example, that from a single photographic negative, one might create any number of prints; to ask for the "authentic" print makes no sense at all. The instant the criterion of authenticity ceases to be applicable to artistic production; the total function of art is reversed. Instead of being based on ritual, it begins to be based upon another practice-politics.

Benjamin chose to illustrate what he called "aura" not with a physically unique work of art in a traditional artistic medium, but with the early portrait photograph that is the new generation of portrait painting. He said that today, photography and the film are the most serviceable exemplifications of this new function (Benjamin et al., 1968).

With the arrival of different methods of technical reproduction of a work of art, we lost the aura that Benjamin discussed. The feeling of the piece of art, which used to be seen only in a museum as an original piece, was now lost.

Benjamin also indicated that with the advent of new film technology, we have lost the aura of theatrical art, because the film actor does not act in front of a live audience as he would in a theater. Instead, actors perform for a camera, which ultimately makes the actors lose the authenticity of that place and that time, in essence its "aura".

Benjamin goes on to make a very motivating comparison between architecture and film. Benjamin sees architecture as a prototype of art, but he believes that like film, architecture undergoes mass experience by distraction and not by contemplation.

When one considers the "aura" in architecture, it is on its way to being lost if it is not already. Today, when anyone contemplates building a house, the trend is to go to a company which shows a catalogue of a number of designs and the right design is chosen based on the number of bedrooms and bathrooms! These are practical homes that lack both creativity and uniqueness. This example clearly shows the loss of "aura" in architecture for architecture is art. Every building is a unique sculpture showing the personality and creativity of the architect. Every building, like art, has its own "aura" and should be contemplated and admired from every angle. However, if one produces even an angle of a previous building, let alone reproducing the entire building, one loses the "aura", if not losing the "art" in architecture!

1.2 Research Approach

1.2.1 Goals and Objectives of the Research

The aim of this research is to increase understanding of how information technologies and design connections can assist the professional realms of architecture, engineering, and construction, by increasing performance and production, and decreasing construction time and cost for intended projects.

After reviewing the literature, we see that there is clear evidence that information technology has opened up a whole new world of design and fabrication techniques. This new world also comes with new and complex challenges that an architect must consider. Challenges such as the function and the art of the form should complement each other. The new technologies should be utilized to do that exact function, leading the way to the development of new architecture that meets and fulfills the different requirements that are not attainable by current available systems.

Building information modeling broke new ground in regards to the possibilities created in the transfer of digital information between the different AEC disciplines. But we find that with the new technological advances such as digital design, new materials, and digital manufacturing practices, the gap between the design and the construction industries grows wider. Hence, additional research of alternative building systems is of paramount importance in order to achieve the correct selections for successful integration. This is not just proper for detailing, but will also help meet the intended performance of the building. The integration between new AEC procedures and fabrication technologies should help in bridging the gap and enhance the communications between the different disciplines during an earlier stage of the design process. Therefore the goals and the objectives of the research may be summarized as follows:

Goals:

1. To increase the application of modular construction techniques in the residential building sector.
2. To be a catalyst for a paradigm shift for the residential sector by redefining the boundary between architectural design and modular construction.
3. To demonstrate this new design process through development of a prototypical knowledge-sharing tool.

Objectives:

1. To improve the understanding of the barriers and constraints between architectural design and modular construction for the residential building sector.
2. To redefine the architectural design process by bringing in issues of fabrication and modular construction earlier.
3. To develop a new process for sharing information and knowledge related to fabrication and modular construction earlier in the design process.

1.2.2 Problem Statements

If we look at the construction industry, particularly the modular construction industry, we often see that the design stage is distinctly separate from the construction and fabrication stages. So, the approach to the construction stage is typically site-built and very rudimentary. The question is, can we change the relationship between the design and construction stages by breaking the construction segment into two parts? The first would be the fabrication portion, where the fabrication occurs offsite in a controlled environment and the second, the assembly stage, which occurs on-site. With the modular building industry this separation has been occurring for some time now, however, there is a lack of an understanding of the constraints in linking architectural design to modular construction for single-family housing. In addition, there is not a framework that seeks to support overcoming these constraints through a paradigm shift for the architecture design process while bringing knowledge of fabrication, materials selection and modular construction to the early stage of design. Also, there is a lack of knowledge of fabrication and modular construction constraints by many architects.

As mentioned in the limitation boundaries, this research is intended to focus on mapping the design and manufacturing processes for a specific scale of projects: residential single-family units. How do we do this? The first stage is to develop a design process that is based upon mass customization, not mass production. This research will address the following questions:

- Can we build a design that can move and change?
- Can we build a methodology for designing multiple variations?
- Can we build a factory that can actually fabricate all of these different components that are coming from the design and try to develop an assembly technique?
- Finally, can we move the project to the assembly stage on site and put all of the components together in the shortest possible time?



If we look at a typical house, we would have to understand all of the different systems involved in the house and design the building in a way that can manage both manufacturing and assembly processes. We would have to consider the linkage among all of the components, time and cost would quickly become issues, as would understanding how transportation limitations and constraints might adversely affect the outcome.

If we did that, how could we affect the design in a manner consistent with the limitations of the fabrication processes? This research aims to understand the relationship between design and manufacturing within the modular construction industry, to understand how we can begin with a process and a system that progresses from the design stage, moving to fabrication then transportation, and finally ending with the assembly of the project.

1.2.3 Research Limitations

The nature of architecture is that it is a mixture of two different fields: art and science. Buildings are a result of blended elements that architects utilize, such as programs, space, form, volume, texture, structure, light, shadow, and materials. Some elements are based on science, such as the structure, which is the major factor in establishing the permanence of buildings. On the other hand, form, texture, and materials reflect the artistic style inherent in architecture.

It is very clear that buildings are different from one project to another, based on the intended functions of a specific project. For example, residential units are different from office buildings, department stores, or high-rise buildings. The specific building system chosen for a project is based upon the intended function and financial criteria. Some buildings need to change their exterior surface every 20 years or so in order to gain the advantages of new technologies and to reflect a new age for future investments. In addition, during the past two decades, increasing energy costs have led to the development of new enclosures that are more energy efficient during different seasons (Brand, 1994). Therefore, this research is intended to focus upon mapping the design and manufacturing processes for a specific scale of projects - residential units based on the single-family unit.

Today, cost and energy efficiency are major factors when making decisions about the use of specific materials and fabrication processes for projects. Typically, a building is a combination of different materials and components based upon the project's functions, which define the outer and inner surfaces, as well as the opening elements (windows and doors). However, the aim of this research is to map the design and manufacturing processes with the goal to develop a

“design language”¹ to support variety in the modular house industry. Minimizing cost and energy use in this research will not be addressed in detail, but through a number of approaches to strategies that will emerge from the outcome and findings of the investigation.

1.2.4 Research Contributions

Over the past few decades, the architectural field went through several major transformations and shifts. Architectural schools trained the previous generation of architects to produce the documentation necessary for production by creating manual hand-drafted drawings. The drawings were based upon plans, sections and elevations, all important steps to begin the process of drawing 3D representations. Digital technologies have transformed and shifted the required production documentation from manual to digital drawings by using 2D computer software as a drafting tool.

Today, the current generation of architects is highly trained with very sophisticated 3D computer graphics and analysis software, such as parametric technology, building information modeling, and building performance analysis. This transformation has improved the communication among the architecture, engineering and construction industries. Digital modeling made the development and progress of a design faster and more efficient. However, knowing how to use advanced 3D software without developing skills in building design and construction will not help architects choose the right tool for the right task.

To increase the design and manufacturing knowledge base, it is important to take into consideration the need to train two different groups of architects. The first group of architects possesses skills in technology; however, they usually do not have enough practical design experience or manufacturing and construction knowledge. The second group is the design staff. They have practical experience in design and construction detailing of projects, but they typically do not possess the latest software skills. Mastering both the design and technology experience may assist in developing new relationships between designers and manufacturers (Deamer and Bernstein, 2010).

More recently, digital fabrication, design-to-fabricate, and manufacturing analysis have emerged. These offer the ability to shift toward a new paradigm in the architectural, engineering, manufacturing and construction (AEMC) industries with seamless collaboration

¹ The term design or pattern language was first used by architect Christopher Alexander to refer to a specific design approach that can provide different solutions.



between different domains. The findings from this research hopefully will make several contributions to current architectural education and the AEMC industries. For architectural education, the anticipated outcome of this research may assist the student's understanding of the intense paradigm shift that has occurred in the design for building systems based on production processes. Also, it may help them to better understand and increase their knowledge about ways of building and the role of advanced computational technologies, as well as how to analyze and improve their design problem solving ability for manufacturing. The aim of this research is to explore, and then propose, a unified process covering all the previously stated elements within the modular house industry from design, manufacturing and transportation, and ending with the installation of the project.

The main goal in this research is to propose a framework for developing the connections among digital design, analysis for constructability, digital manufacturing processes, transportation limitations, and assembly and installation techniques. In addition, within this framework, strategies will be formed to assist the design team to deliver cost effective planning and built environment services. The impact of this research on the practice of AEMC industries is to enhance the design methodologies and processes from how we think to how we craft architecture through an efficient system in the age of digital information.

1.2.5 Overview of Research Methods

Technological advances have an enormous influence on the discipline of architecture and the architects' quality of work. During the past two decades, these advances have resulted in significant changes to building design, the construction industry, and the ways in which architects and engineers perform their work. However, the relationships among digital design processes, new materials, and digital manufacturing practices still remain unclear and need to be explored further.

The main goal of this research is to understand the triangulated relationship among these three areas through mapping the design and manufacturing processes. Capturing and structuring knowledge as a process will support the anticipated results from this research. Thus, qualitative research methods based upon a grounded theory approach will be used for evaluating, capturing and structuring knowledge. In this evaluation, the literature review will be conducted as a two-tiered approach. First, general background information will be explored as an introduction to identify the state of knowledge related to these topic areas and to identify issues and problems. Second, an interpretive literature review will be commenced, one which will

assist in categorizing and extracting related information directly to the knowledge capturing process.

In addition, case studies of recently designed modular buildings will be reviewed to illustrate the development of the design processes and fabrication performance over time. This could be achieved by applying multiple analytical tools to evaluate the building’s modular systems and prototypes that range from building elements to assemblies. Furthermore, part of the knowledge capturing process will be learning lessons from other industries, those which have been utilizing advanced computational and fabrication processes over the last two decades, such as the automotive, shipbuilding, and aircraft industries. Interview questions with knowledge stakeholders will also be formed to collect data directly from the real world industry. A framework will be developed to demonstrate and then gain consensus for the viability of the proposed framework (Figure 1.5). A detailed description about the characteristics and parameters of this research methodology will be presented in Chapter 3.

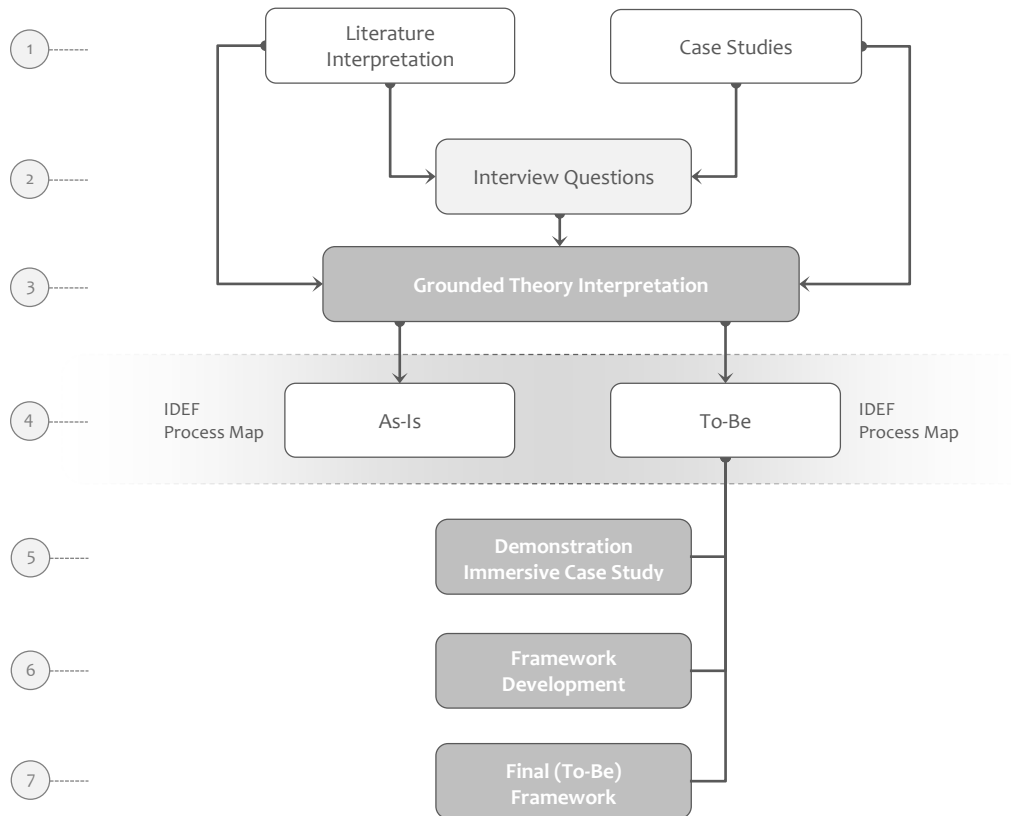

Figure 1.5: Qualitative research method based upon a grounded theory approach

1.2.6 Thesis Structure

This research is organized into six chapters:

Chapter 1. Introduction: This will provide an overview of the research, its goals and objectives.

Chapter 2. Literature Review: General background information will be explored as an introduction to identify the state of knowledge related to topic areas such as design, prefabrication, transportation, assembly, and information technologies to identify issues and problems.

Chapter 3. Methodology: This section will present multiple analytical tools and approaches to evaluate and generate the intended framework as well as different knowledge-capturing techniques.

Chapter 4. Immersive Study Interpretation: This chapter will present, categorize and extract the related information from the knowledge capturing process including the following:

- Data Collection/Case Studies: Here a set of case studies and interviews from manufacturing-construction industries and other relevant industries will be presented to compare and analyze sources of evidence that may benefit the development of the framework.
- The Designing Phase: This represents the first step in the prefabrication process. This is comprised of the design process, building definition and production process
- Factory/Materials and Manufacturing Models: This section will present methods used for factory design and layouts, storage and retrieval systems, material transport systems, manufacturing models, and quality control in manufacturing systems.
- Parts, Subassembly, Assembly and Installation: This section describes three sequential levels of manufacturing in construction, that link the manufacturing and fabrication processes from materials to the final product.
- Packaging and Transportation: Packaging types and development considerations are introduced as well as transportation options and limitations.

Chapter 5. The IDM Framework: This chapter will present the existing framework and an interpretation of the proposed framework.

Chapter 6. Summary and Conclusion.

2. Literature Review

2.1 Introduction

The intention for this chapter is to establish the current state of knowledge relative to the field of study. The chapter is divided into four main sections (domains of knowledge), which are design, manufacture/fabrication, transportation, and assembly. Each of which will present, compare, and evaluate the existing systems. In addition, it will explore the importance of Information technology (IT) systems such as computer-aided design (CAD), computer-aided manufacturing (CAM), computer-numerical control (CNC), and building information modeling (BIM) to the modular home industry, and the benefits of using them. The benefits and efficiency of earlier collaboration between different teams from different disciplines, through the design, manufacturing and construction processes will be discussed. Learning from previous problems and limitations of other Industries will also be presented.

2.2 Current Design Methods

Kent Larson, in his text *Open-Source Living*, noted that “homes-of-the-future” and “factory-built dwellings” are important topics these days. As architects, it is our responsibility to become aware of the problems associated with housing. Larson argues that most of the issues relating to housing in the United States stem from the lack of an architect’s involvement. 90 to 95 percent of housing projects are the result of homebuilders without the involvement of architects. The need to reconnect architects with housing projects could help to achieve better and high-quality housing projects (Deamer and Bernstein, 2010).

Adapting new technologies based upon digital design and fabrication will assist architects in exploring and producing promising results for the future. With advanced fabrication processes, many manufacturers of building products have shifted from producing a single product to more integrated building systems. Prefabrication can greatly help in reducing manufacturing time and cost, and increase the quality and efficiency of production processes. These advantages can help architects to choose and integrate advanced building products within their new designs.

Larson pointed out that if building product manufacturers are able to shift from mass-production to mass-customization processes, architects can develop new building systems and be better connected to the building industry. This shift will cause architects to adapt their process of design thinking, through an explicit link between new ideas of production to



fabrication. Experienced architects might question the impact on the building appearance, which could be adversely affected by the constraints of the fabrication process. Larson claims that new generations of architects are being trained with different skills and design thinking methods that can overcome these production limitations (Deamer and Bernstein, 2010). Strict production requirements may lead to creative and innovative ideas that would not be possible in a more traditional way of design thinking.

If the building industry could agree how different components within different building systems fit and are connected, Larson argues that building components could be mass-customized and then assembled. This would help the building industries produce a series of different building elements that architects might incorporate within their designs. Such an agreement among the building industries would minimize building erection time and improve quality. One example Larson cited was an agreement reached in the computer industry approving the use of a USB port as a standard outlet (Deamer and Bernstein, 2010). This, in turn, allowed different companies to focus on designing high quality and smart devices without being concerned about how they were going to be connected with other systems. In addition, the USB standard outlet agreement assisted many companies in introducing innovative devices with cost effective plans, thus increasing their profits. Architects working in concert with the building industry can develop different standards for building components. Therefore, proper design and consideration for standardized connections for specific building systems is crucial.

Building information modeling (BIM) is an example of how different software companies implanted their software with standard file extensions, making the exchange of information between different programs possible. Larson proposed that the building industry grasp the opportunities associated with BIM and start what he called a “web-accessible library of components”. This central resource would allow architects to search directly through the web-library for innovative products and production possibilities. As time passes, manufacturers could add and update their products and fabrication specifications directly in the central library.

By restructuring the relationship between the design and fabrication processes, architects and others in different fields may help to improve the quality of residential building projects. This will assist the architecture, engineering and construction industries in reinventing the housing market, not only to accommodate the users’ needs and requirements, but also to make each housing project faster, easier, healthier, smarter and more cost effective.

Architects and engineers are well aware of how digital technologies have opened up new design and fabrication approaches. Several studies have linked the ability to design and construct



complex geometries to the capability of sharing and transferring data between different software platforms. Branko Kolarevic, in “Designing and Manufacturing Architecture in the Digital Age,” illustrates how architecture in recent years has been influenced by several technological advances such as digital design processes, new materials, and digital manufacturing practices. The capability to transfer data between different software programs and computational environments enriches the design process by linking the different team members. Kolarevic addresses two main components in his research. First, digital geometrical modeling and analysis processes based on CAD, and second, CAM digital fabrication and mass-customization. These advances have been significant in the discipline of architecture and are changing the ways in which architects and engineers perform their work (Kolarevic, 2003).

Greg Lynn is one of the first architects to achieve distinction for his use of CAD/CAM to generate irregular shapes and complex geometries. Kolarevic then introduces and explains the use and advantages for some of the digital approaches used in design including; topological space, isomorphic surfaces, motion kinematics and dynamics, keyshape animation, parametric design, and genetic algorithms. Kolarevic also discusses the possibility of developing new computational approaches beyond those listed above.

In addition to the advantages mentioned above, evidence suggests that technological advances are not without shortcomings.

Kolarevic states that “Digital architectures are profoundly changing the processes of design and construction. By integrating design, analysis, manufacture and assembly of buildings around digital technologies, architects, engineers, and builders have the opportunity to reinvent the role of a master-builder, and reintegrate the currently separate disciplines of architecture, engineering and construction into a relatively seamless digital collaborative enterprise.” Kolarevic may very well be right that digital architecture has resulted in significant changes to building design and the construction industry. However, the approach to forming collaborative teams still remains unclear and needs to be further explored.

In order to translate the progression from the computer screen to physical constructs, designers need to enhance their understanding of materials and manufacturing processes. A paper titled “Synthesis of design production with integrated digital fabrication” presented by Lawrence Sass from the Department of Architecture at MIT (Sass, 2007), shows how the ability to exchange information between digital design and digital fabrication through one three dimensional model tremendously reduced production time. The purpose of this study was to show the advantages and disadvantages of direct translation from visual to physical model. An



“Instant Shelter” as a small building design, was chosen to demonstrate the interaction between design and fabrication processes. Although the scale of the project is small, the concept behind it is extremely helpful in terms of the importance of analyzing geometry to reach the intended result. The entire project was built from interlocking components. The project was designed in CAD software, then a rapid prototype was developed using a laser cutter machine. After observing and analyzing the physical model, a final modification was made to the original model before running the CNC machine to produce the 1:1 scale model. The author shows a problem with excessive material waste in this experiment, and how the designer could avoid this by considering all the required components during the design process (Sass, 2007).

Other than Lawrence Sass’ study, Buswell et al. (2007) investigated the ability of using mega-scale rapid manufacturing for construction. In their paper, “Freeform Construction: Mega-scale Rapid Manufacturing for Construction”, Buswell et al. found that using this type of technology does not support quicker installation or shorter assembly times when compared to traditional construction methods. Buswell et al. showed that it is not how quickly you are able to produce geometry from a visual to physical condition, but it is of utmost importance as to how you develop the geometry for better structural and infrastructure performance (Buswell et al., 2007).

Li et al. (2008) demonstrated the benefits of involving virtual design prototyping to better help the contractor during the construction process. In their paper, “Integrating design and construction through virtual prototyping,” Li et al. indicated a problem is that we need to better define the scale and the type of the project, as there are vast differences between a geometrically simple and a complex architectural project. The question raised is, would a knowledge-based decision-support software based on BIM technology be useful to designers when fabrication processes are important?

2.2.1 Digital Design and Analysis Processes

Computer-Aided Design (CAD) has had an enormous influence on the disciplines of architecture and engineering. The advantages of utilizing different CAD software as design tools, along with analysis, have led architects and engineers to search for innovative new materials and installation techniques.

A strong relationship between the development of models of products and using CAD has been reported in the literature. The amount of information generated through the design of models and development processes from CAD, assisted vastly by design analysis, will support the need for understanding and planning of manufacturing activities. In order to achieve this level of information exchange, a detailed design has to be modeled, including form, dimension, tolerance, structure, and material specifications (McMahon and Browne, 1998, Stevenson, 1999).

It is very important for a designer to be familiar with CAD representation techniques, such as drawings, diagrams and three-dimensional computer models. When the designer creates the preliminary model in the computer, he/she can then modify and develop the design through different approaches, some of which are rotate and split tools. With rotate, the designer can explore the constructed computer model from different angles for further improvement. The split option can provide the designer with different sections of the computer model, which will assist in the inside examination of the model (Stevenson, 1999).

Stevenson (1999) claims that CAD is an important component in the design process and plays a key role in increasing productivity by as much as three to ten times. CAD plays another key role by providing the ability to extract needed information for manufacturing production of the final product. Additionally, several CAD software systems can support the design of a detailed product with different analysis tools, such as weight, volume, cost, stress analysis, and so forth. Architects and engineers typically produce a number of alternate designs for the same product for comparison and evaluation.

Utilizing analysis tools to explore design options may assist in identifying the best course of action. In order to reach this level of information processing, the design team needs to be aware of the design and analysis tools in more sophisticated CAD applications, which require an extensive amount of work (Stevenson, 1999).

The process of developing a design differs between architects. Given the availability of new technologies, many architects prefer to start testing and designing their projects directly using

3D software. On the other hand, some architects follow a more traditional way of working. They sketch their ideas first, produce physical models, and finally use a digital model to enhance their main concept. An example of this approach is architect Frank Gehry's work (Waters, 2003).

Many recently constructed buildings are not limited to flat planar elements and include a series of complex geometries. Many designers are exploring pioneering design and construction techniques that have resulted in new shapes with complex geometries, an example would be the Walt Disney Concert Hall building in downtown Los Angeles, California, designed by architect Frank Gehry (Figure 2.1).

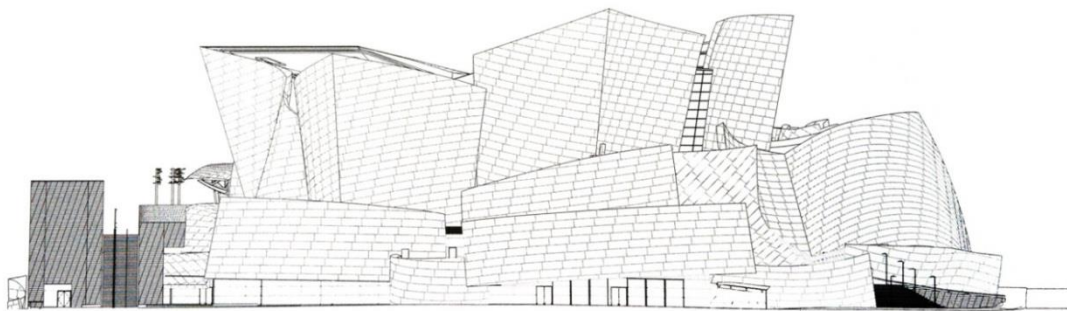

Figure 2.1: Walt Disney Concert Hall building in downtown Los Angeles (Jodidio, 2004).

For these complex buildings, it is important to properly develop the building enclosure with its complex geometries that are related to a specific digital fabrication technique. Modes of development such as tessellation and surface rationalization techniques, entail transforming geometries into developable surfaces while unfolding techniques can help generate construction information directly from design information (Figure 2.2, 2.3, 2.4) (Pottmann and Bentley, 2007). New digital technologies have altered the design process, but in order to translate representations from the computer screen to actual physical constructs, designers need to enhance their understanding of materials and manufacturing processes.

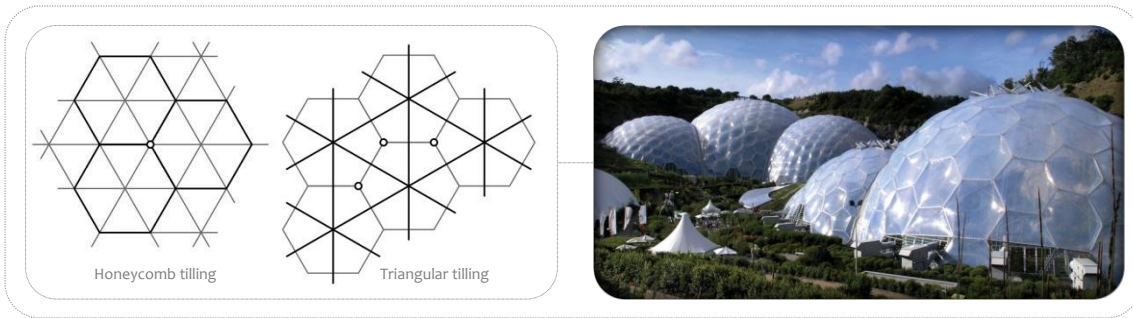

Figure 2.2: Tiling (The Eden Project by Nicholas Grimshaw) (Pottmann and Bentley, 2007)

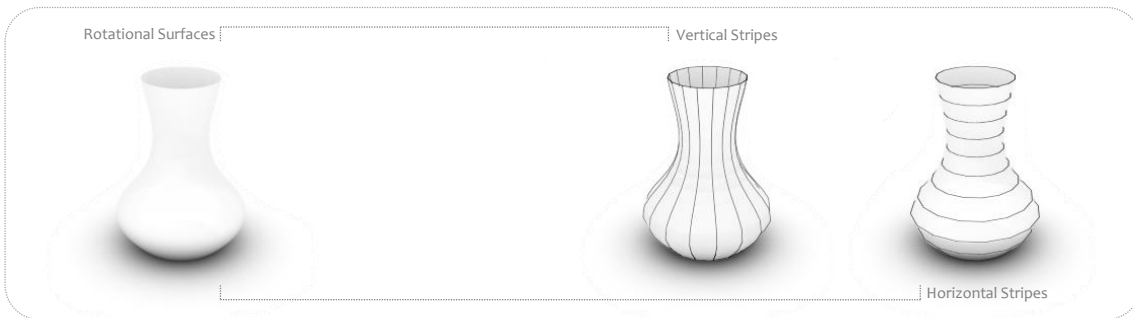

Figure 2.3: Unfolding, adopted from Pottmann and Bentley, 2007.

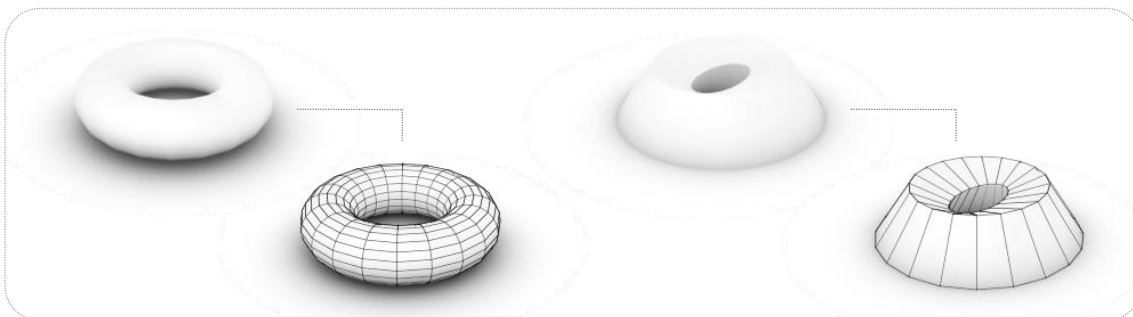



Figure 2.4: Curvature lines of a surface represent fundamental shape characteristics, adopted from Pottmann and Bentley, 2007.

There are many techniques to generate and describe drawings; however, there are limits to how far those drawings can be taken to describe the actual object of construction. In their text, *Engineering Graphic Modeling* (Tjalve et al., 1979), Tjalve and his colleagues identified three characteristics for a drawing to be perceived as a model. First, when a drawing demonstrates specific properties of an object, such as form, surface, structure, dimension, material and so forth. Second, when drawings are directed to receivers that can read the information. Third, when a drawing is coded to represent a set of symbols, and the receivers can read and interpret them into information. Taken together, these characteristics should assist receivers by reducing the length of time necessary to communicate information.



As has been noted earlier, there is more than one method to interconnect drawings and models. Some individuals or teams prefer to prepare models after drawings have been completed, whereas others produced drawings following a modeling process. Many designers and engineers rely on both drawing and modeling. These designers develop drawings and search for solutions based on the modeling results, while at the same time, they can better understand how different components within a model are connected by examining the drawings (Peng, 2001).

In architecture, the most important building properties are form and appearance. In contrast, civil engineers usually concentrate on a building's structural performance. Other engineers may focus on the assembly process and the installation of different elements, with complete models showing the assembly for the entire project. According to McMahon and Browne (1998), the latter approach is often called a systems engineering approach. This approach can be used to develop a communication technique among architects, engineers and manufacturing specialists. The need for a generic formulation modeling language is of paramount importance, specifically within the modular building industry. This will help avoid any miscommunication among disciplines and the various parties involved in the design and manufacturing processes.

Analysis is an important sub-process within the design process, and plays a key role in computer-based modeling. Through the development of the design, more information such as material properties, dimension and structure will be added to the model. This information will assist in the evaluation of the design, by generating information to be used for performance simulation and analysis. There is an unambiguous relationship between successful evaluation and the availability of adequate modeling information. The modeling information includes, but is not limited to, structural, energy usage, thermal performance, load and load distribution. To date, various building analysis software tools and techniques have been developed and introduced to measure, analyze and evaluate several parameters. Further data collection is required to determine exactly what, when and how to use a specific analysis method. Many computer modeling programs support only one analysis tool, which is the readability of the initial structural concept through the constructed model geometry characteristics. As shown in Figure 2.11, and 2.12, data for initial structural analysis may be extracted directly from the model geometry (McMahon and Browne, 1998, Schodek, 2004).

Computer programs differ based upon their function. The integration of analytical tools depends upon the nature of the software. Typically, computer-aided design (CAD) programs support the gathering and interpretation of information and the translation of sketches into dimensional drawings and models. CAD is designed to assist in the creation, modification, and communications through documents of design, but is not designed to generate analysis results.

However, Computer-Aided Engineering (CAE) programs are designed to import and use a geometry definition from a CAD program before applying one or more engineering analysis functions. Accordingly, a number of software development companies are developing third-party plug-ins and add-ons for analysis tools, which can be used to evaluate and enhance the performance of the building. In turn, this leads to minimizing any missing information that may result from exchanges between different CAD and CAE environments. This increases productivity through rapid data flow among different teams and disciplines (Schodek, 2004).

In general, most architectural projects are based on the integration of four major systems: 1) structural, 2) enclosure, 3) services, and 4) finish. Despite the scale of the building, each system is a combination of different elements and materials based upon the project goals. A major concern for designers and engineers for such integration would be the tolerance standards, mainly for manufacturing and assembly processes. The most commonly used CAD programs are implemented with tolerance standards, such as the ANSI Y14.5 (Geometric and True Position Tolerancing Guidelines in the United States) (Schodek, 2004).

Another possibility is that with digital models being constructed within a CAD environment, information such as the area of a selected surface, volume of a space or of materials, and weights of parts can be extracted directly from the digital model. This can be applied to cost control, where the inventory process and quantity of materials are calculated directly from the model information. This, in turn, can have a direct impact on manufacturing and construction costs. One of the greatest benefits of this is that when the design model is modified or developed, all of the information will be updated accordingly.

The Finite Element Method (FEM) is one of the most important structural analysis approaches that most advanced CAD/CAM programs employ. With FEM a complicated structural design or element-shape can be divided into small components, and then, each component can be structurally analyzed in relation to the whole system. Therefore, FEM is mostly used with complex geometrical shapes. In architecture, using analytic or mechanical techniques is preferred to FEM; however, finite-element analysis is being applied more often. Using the finite-element analysis techniques, a continuous mesh covers the whole component surface. Whether a thin-shell structure or solid structure, the finite-element analysis is started after the design concept has been modeled within a computer-aided design environment. The design model then is replaced by triangles or tetrahedrons to better approximate the behavior of the object.

As mentioned earlier, since the whole structure is divided into small components, the distributed loadings are then converted into nodal loadings. This will assist in reading the

outputs based on the material properties and boundary conditions such as internal forces, stresses, and displacements. Thereupon, solutions developed over the area may be needed or in some cases, a redesign may be required (Schodek, 2004).

Finite-element analysis methods have helped with generating and understanding structural performance of specific components as well as the structural system as a whole. So far, however, this method of analysis has a number of limitations, such as the results are only approximations. According to Schodek (2004), it is not an easy task to read the information results produced from finite-element analysis tools. Therefore, inexperienced individuals often have difficulty interpreting the results. Furthermore, Schodek has argued that in many cases, inexperienced users consider generating multicolored graphic diagrams as an analysis result and they have “done an analysis” without being able to define it in a logical and scientific manner. Knowing obvious structural behavior does not mean that the graphic diagrams were interpreted based on technical knowledge.

Finite-element analysis is often utilized in manufacturing industries, and can be used to select a particular manufacturing method. FEA can be used to study molding and casting processes that are used for the production of plastic and metal parts. During the molding or casting process, the material goes through different phases starting from liquid and ending with a solid. Hence, product properties during stages such as filling, packing, and cooling can be easily predicted by using finite-element analysis. This can provide information about the requirements and constraints to be addressed during the design process. Furthermore, finite-element analysis is used to calculate the stress and strains during the forming process of a sheet metal. The result then would assist in identifying the feasibility for manufacture. A solution is adapted based on the resulting information and whether the design needs to be changed or there is the need to combine more than one manufacturing process (Schodek, 2004).

Another useful analysis is Computational Fluid Dynamics (CFD). CFD is typically used to simulate the interaction between liquids or gases with defined surfaces in a specific condition. According to Schodek (2004), in architecture CFD is used to evaluate thermal behavior and air flow in and around the building, as well as to predict a building’s performance under high wind-loads. CFD analysis can be applied during the concept-phase all the way through design development. CFD analysis can also be used to solve problems for built projects. As mentioned earlier, only experienced individuals normally understand the analysis results and effectively interpret them for further design development.

Is architecture an art or a science? As discussed earlier the nature of architecture is that it is a mixture of two different fields: art and science (Neal, 2001). Buildings are typically a result of blended elements that architects utilize, such as program, space, form, texture, structure, light, shadow, and materials. Some elements are based upon science, such as the structure, which is

the major factor in establishing the permanence of buildings. On the other hand, form, texture, and materials reflect the artistic style inherent in architecture.

Based upon the previous dissection and to answer the question, there are different factors that we need to take into consideration to achieve both the desired appearance and performance of a building, which are the design process and the process of work or development. This brings us to the question, is it a linear or simultaneous process? Most successful projects these days, which were typically designed by architects, were based upon earlier collaborations among architects, design engineering teams and contractors. In general, the technical analysis of building performance would be performed by specialists such as engineers. However, such a collaboration would enhance the conceptual design stage with instant feedback regarding all the technical aspects surrounding the initial analysis of building performance. Architects/designers then can revise and develop the concept during the design phase and consider all of the technical aspects without limiting creativity and innovation. This is important, particularly for those less experienced architects/designers who lack the skills and knowledge required for such building performance analysis.

Taken together, art and science are the fundamental characteristics in architecture that reflect both the appearance and performance of a building. By viewing architecture in this manner, it helps us to understand that an analysis of building performance is a mixture of technical information and creative ideas. In his writings, Renzo Piano portrayed architecture as (Kühl et al., 2008):

An architect's profession is an adventurous enterprise: a profession between art and design between invention and memory between audacity of modernity and true respect of tradition. The architect lives dangerously, out of necessity he works with all sorts of materials by which I mean not only concrete, wood and metal but also history and geography, mathematics and science, anthropology and ecology, aesthetics and technology, climate and society. Every day he must pit himself against all these things (p. 131).

Richard Buckminster Fuller and Nicholas Grimshaw are well known for their outstanding and innovative projects. Their work is characterized by the integration between aesthetics and performance.

The Dymaxion House (House of the future) designed by Richard Buckminster Fuller is one of his notable projects and inventions. The word “*Dymaxion*” was first introduced by Fuller and mainly was an integration of three different words which are dynamic (DY), maximum (MAX), and tension (ION) (Sieden, 1989). In 1928, Fuller patented and presented the first futuristic

prototype of the Dymaxion House; the design of the project was based upon a hexagonal form with a cable structural system suspended from a central mast (Figure 2.5). One of the main goals of the project was to keep the weight of the house less than 3 tons; therefore, aluminum was chosen for not only its lightweight and high performance value, but also for its strength and ease of fabrication and assembly. At that time, the high price of the aluminum material was a major cause of not manufacturing the model (Knaack, 2012).

In 1936, Fuller designed a prefabricated bathroom unit (pod) for the Dymaxion House (Figure 2.6) (Davies, 2005). He was able to take into account during the design the users' needs, both children and adults. The Dymaxion prefabricated bathroom was divided into four sections to minimize the weight, so it can be easily carried and assembled by two workers. In addition, all the appliances, plumbing, and electrical systems were installed and pretested in the factory, which helped in shortening the on-site construction time (Buckminster Fuller Institute, 2010).



Figure 2.5: The first Dymaxion House prototype (Knaack, 2012).

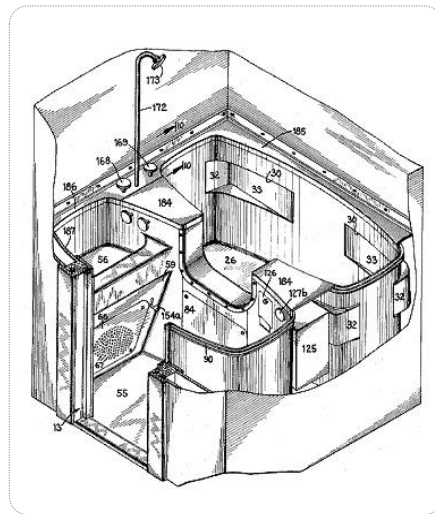

Figure 2.6: The prefabricated bathroom unit (Davies, 2005).

Four years later, in 1940, Fuller developed another version of the Dymaxion concept to accommodate the US army requirements such as low-cost, portability and usability. It was 6 meters wide and called the Dymaxion Deployment Unit (DDU). As can be seen from Figure 2.7 B, the design was based upon a circular plan with a roughly conical roof (Davies, 2005, Knaack, 2012). Such a form increased the performance and energy efficiency of the unit, where the overall concept worked to smooth the movement of high wind and at the same time the external envelope assisted with natural air ventilation as shown in Figure 2.7 A.

In 1945, when World War II ended, many aircraft factories were expected to go out of business. Fuller was able to transform an aircraft factory to manufacture his latest version of the

Dymaxion project called the Wichita House. The design was based upon the integration of the previous three Dymaxion designs. It was 11 meters wide and developed with several teams from existing factory employees such as aircraft designers, engineers, and craftsmen. The plan was designed so that all the services such as mechanical, electrical, plumbing and two Dymaxion bathrooms were grouped at the center of the house, where the rest of the living spaces such as the entrance hall, living area, two bedrooms and kitchen were divided around the central services area. As a result, all the living spaces were well-lit during the day. The weight of the project was still less than 3 tons (6000 lb.) in comparison to a typical on-site construction house that usually weighed 150 tons. All the components of the Dymaxion house could be shipped in one truck and could be assembled on-site in one day. The outcome was a combination of environmental and structural solutions. Figure 2.8 shows an image of the Wichita House (Davies, 2005, Knaack, 2012, Smith, 2010).

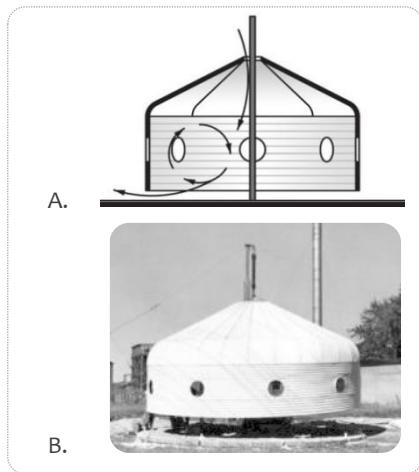

Figure 2.8: A. Diagram of the natural ventilating system. B. Dymaxion Deployment Unit (Knaack, 2012).



Figure 2.7: The Wichita House, Kansas (Knaack, 2012).

Another example of an architectural work demonstrating the integration of design with performance is The Spine House in Cologne, Germany (1996). This project was designed by architect Nicholas Grimshaw with Bryden Wood Associates. The project was the first private residential building designed by Grimshaw. He was asked by the owners of the project to design their house when he had finished building a factory for them (MacDonald, 2005).

The project was divided into two main sections and an entrance/reception area in the middle linked to the main and only spine (corridor) of the house. Also, all the public, semiprivate and private living spaces for both ground and first floors are connected directly through the main spine (Figure 2.9). The geometrical form was the result of merging two forms which are the rectilinear form divided equally by the curvilinear form of the spine. As can be seen from Figure 2.9, the building typology is a U-shape facing south that surrounds the interior spine that

enhances the interior space both visually and climatically. All the living spaces were designed based upon a graded concept that allowed them to directly overlook the garden.

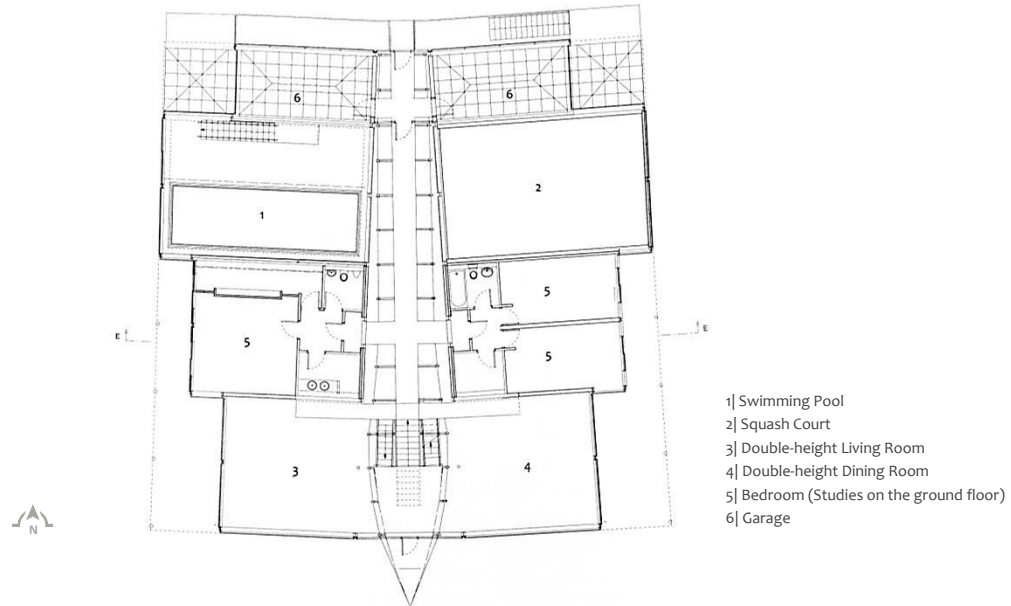

Figure 2.9: The Spine House floor plan (MacDonald, 2005).

The open-plan living and dining spaces were further enhanced by a double-height ceiling with a glass facade viewing the landscaped area. In addition, the opening on the first floor, the sculptural spine and the staircase made an interesting contribution to the overall space (Figure 2.10). While the rectilinear form sections of the building were constructed from industrial materials such as steel frame, glass cladding and aluminum louvers, the curvilinear form part (spine) was based upon eight separated sections that were handcrafted offsite from American ash timbers and were assembled on-site (MacDonald, 2005).

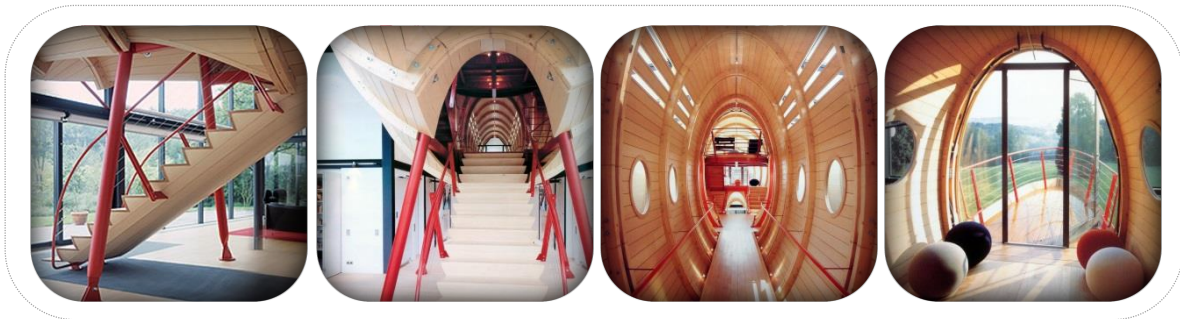

Figure 2.10: Different images showing the main spine design (MacDonald, 2005).

2.2.2 Modeling Using CAD

What is a model? In 1994, Mogens Myrup Andreasen published a paper called Modeling-The Language of The Designer, in which he described the meaning of a model as:

An artefact, which reproduces the properties of an object. The designer creates a long sequence of models of the product, or at least his/her interpretation of the product, by way of graphical, mathematical, hardware-based or computer-based models. In this way, the designer obtains answers to queries during the design process: Is it strong enough? Does it function? How is the performance? What will it look like?

Andreasen (1994) discussed the need to distinguish the relationship between the model and the object. The model typically is the interpretation of the properties of the object. The designer may envision the object through different representation techniques, but without understanding the object's properties such as its shape, size, and material, it would not be possible to construct it in real world systems (Andreasen, 1994).

A CAD model is typically established as part of a design process, starting from a clear description of the planned product. A design team then develops a series of drawings and diagrams to be reviewed and validated by the design analyst team and the manufacturing specialists. Approval of this phase is essential before preparing the manufacturing sequence of instruction documents. In most cases, the design analyst team and manufacturing specialists will return the drawings to the design team for further improvement and modification. The design team will then reproduce the drawings to meet the analytical and manufacturing comments (McMahon and Browne, 1998). One major drawback of this approach is that the design team may receive comments for design modifications several times, which means increasing design time and cost. McMahon and Browne (1998) reference an example of one large aerospace manufacturer, whose design revision phase and changes for each drawing may take up to 4.5 times before gaining final approval.

The key problem with this approach is that at the beginning, the design team does not study their design drawings with the limitations of existing manufacturing methods, preferring to lean toward receiving feedback from the design analyst team and the manufacturing specialists. Another problem with this approach is that it fails to take into account the benefit of having CAD as a digital information tool. CAD can be a useful and powerful connection instrument in real world systems and processes.



McMahon and Browne (1998) define the previous approach (the traditional design process) as an ‘over the wall’ approach, sometimes called the sequential approach. The reason behind this metaphoric expression was the barriers in communication among the design team, the design analyst team and the manufacturing specialists throughout product development. Each team routinely tends to focus upon its expertise within the design and development processes. After completing their work, they pass it (over the wall) to the next team. Accordingly, a slower and more costly development phase may result.

There is a large volume of published studies describing the role of concurrent engineering as a process of solving the sequential approach problem. According to Sohlenius (1992) , the term concurrent engineering was first used in the US in 1989. It aims to increase productivity and efficiency of earlier collaborations between diverse design teams from different disciplines, through the design and manufacturing processes. One major benefit of concurrent engineering would be providing the design teams with instant feedback during the conceptual design stage, assisting the team with design development. By implementing this approach, the development proceeds faster and more efficiently.

Although concurrent engineering has assisted in bridging the gap between different design teams and disciplines by working in parallel and not in sequence, there are some cases where this approach is not suitable. One of these is when the intended product concept remains undeveloped to the level of understanding the product’s properties, as described earlier by Andreasen (1994). The absence of this information delays the practical involvement of the manufacturing specialists. It is very important to reach a certain level of design development in order to exchange information between the different design teams and disciplines. Otherwise, it is advised to start with a sequential process, with a smooth transition to concurrent engineering (AitSahlia et al., 1995, McMahon and Browne, 1998).

Figure 2.11 provides a comparison between the sequential and concurrent approaches by McMahon and Browne (1998) based on Prasad (1995) , and Sohlenius (1992).

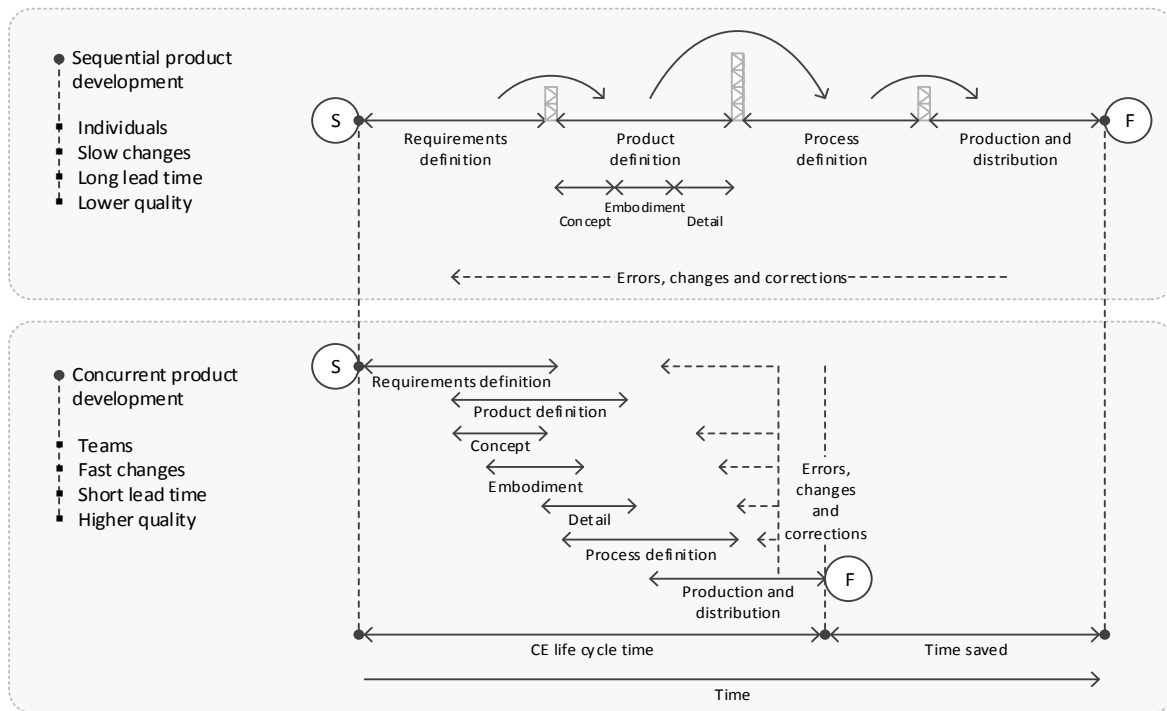

Figure 2.11: Sequential versus concurrent product development from start to finish.
Adapted from McMahan and Browne (1998)

The comparison from the previous figure of the two results reveals the significant time savings reported by the concurrent product development group versus the sequential product development group. This also agrees with our earlier observations, which showed that having the design team, the design analyst team and the manufacturing specialists working together in parallel with product development, will allow for faster modification and progress, as well as higher quality.

It is necessary to clarify the exact contribution and involvement of each team within the concurrent approach. Modeling using CAD assisted the design development teams with extracting specific information directly from these models. Each team develops new models based on their expertise, and then forms the required information for manufacturing the final product.

Figure 2.12 shows the intercorrelations among the different disciplines during the various stages in the design process. Besides the detailed design module, including form, dimension, tolerance, structure, and material specifications, there are some other factors that must be taken into consideration for development, such as customer requirements, materials availability and

manufacturing process constraints, structural loads, and performance evaluations (McMahon and Browne, 1998).

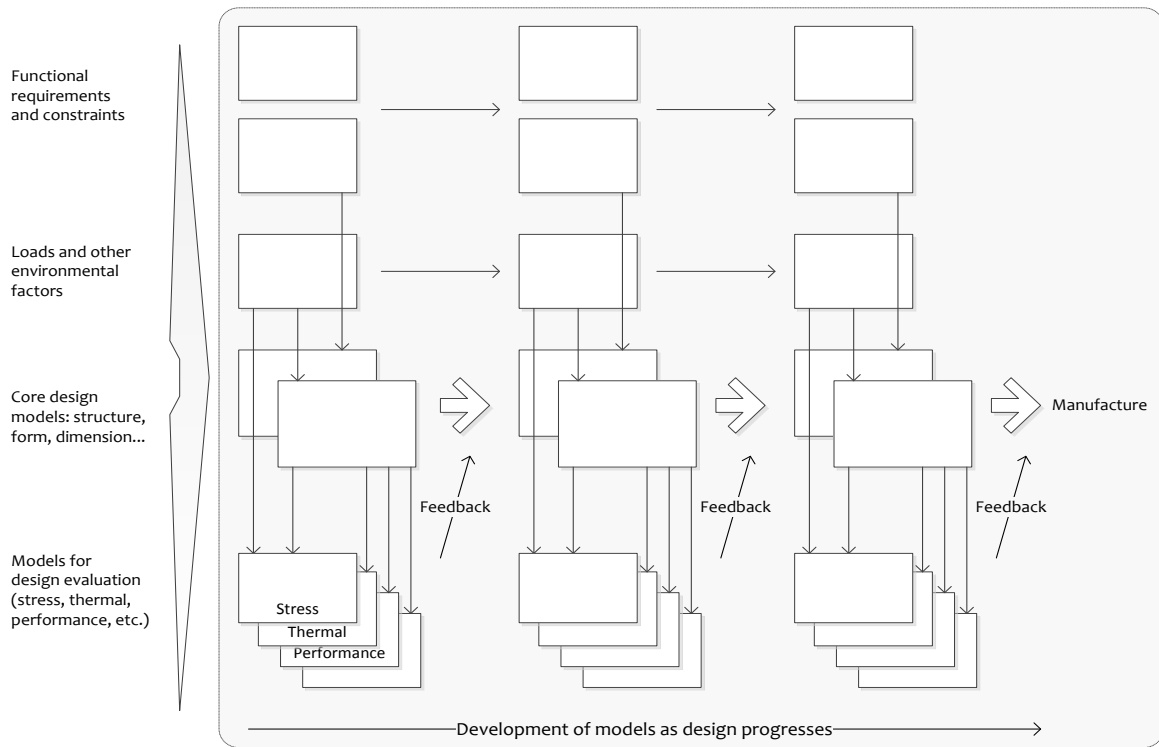

Figure 2.12: The use of models in design, adapted from McMahon and Browne (1998)

In practice, CAD could be efficient not only for modeling, but for communication throughout the design progress. McMahon and Browne (1998) categorized the use of CAD into two different approaches - basic and advanced level. At the basic level, the intent is to use CAD to develop and produce the needed drawings and diagrams for a specific project or product. At the advanced level, the designer tends to use new tools and techniques in order to evaluate and enhance the model during the design process. In today's practice, the basic and advanced level approaches are commonly integrated and used together, but this practice poses the question of whether the existing CAD systems can assist with providing detailed information for manufacturing process limitations, or whether the designed artifact can be constructed. Further research on this question will be addressed in the next topic.

2.2.3 CAD Systems in Architecture

The past decade has seen the rapid development of CAD systems in many fields and CAD computer software is becoming a powerful tool for many competitive industries. In architecture, what makes the difference between one CAD software and another? Architects

typically prefer to work with faster functions, better techniques for representation and vast embedded archived libraries. Architects use CAD programs to translate their ideas and produce the design information in the form of digital 2D and 3D models, which may be passed on to others for further development.

There are four main components that need to be integrated for any successful CAD system: 1) hardware, 2) software, 3) the data, and 4) human knowledge (McMahon and Browne, 1998). As shown in Figure 2.13, the first three are the core systems needed for any specialized industry. In the design phase, the system is ready to collect the design information, verify the information received, and produce digital and hard copies of that information. Implementing such an advanced core system would not be useful without human knowledge. Therefore, it is very important to understand how to utilize the current technologies by training the users how to use these tools.

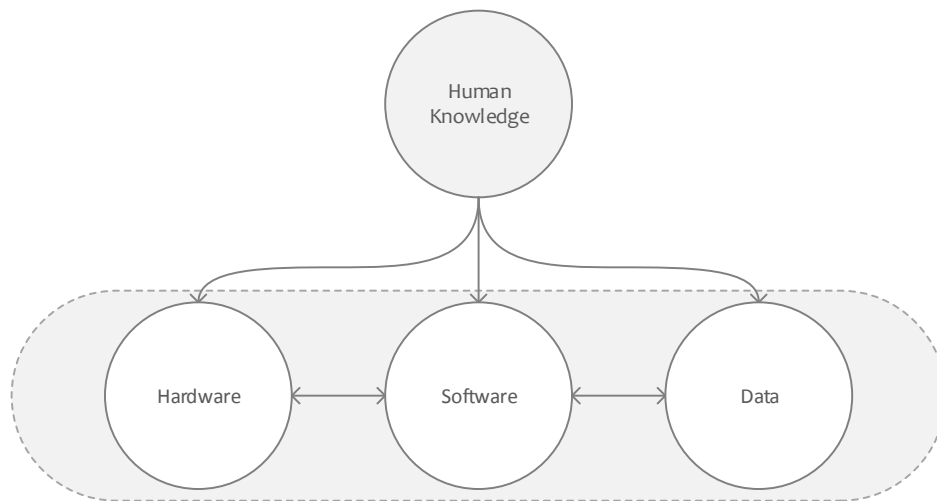

Figure 2.13: The architecture of computer-aided design system

Another important practical implication is to identify the direction of current and future architectural trends. This will assist the software developer companies to enhance their products with advanced tools which are usually upgraded annually. McMahon and Browne (1998) list a number of different functions that can be used to process the stored data in the software database. Each function is based upon different features that designers usually use to control their processed data as a model. As shown in Figure 2.14, the user can retrieve the data translated throughout different functions as part of his or her design development process (McMahon and Browne, 1998).

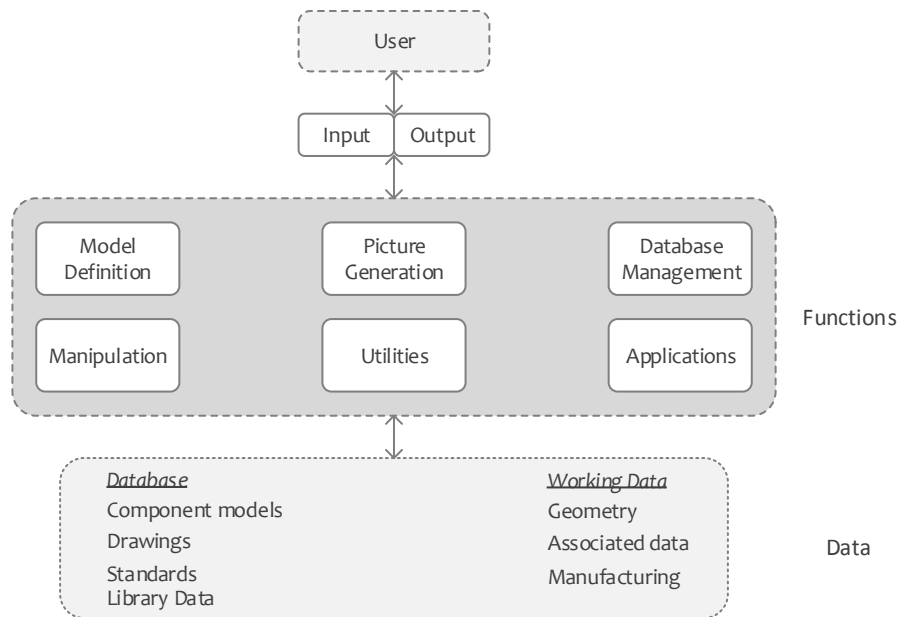

Figure 2.14: Main Functions of CAD Systems, adapted from McMahon and Browne (1998)

Table 2.1 below illustrates some of the characteristics of the main functions of CAD systems based on McMahon and Browne (1998).

Table 2.1: Description for the main functions of CAD systems (McMahon & Browne, 1998).

Function	Description
Model Definition	For example, to add geometric elements to a model of the form of a component.
Model Manipulation	To move, copy, delete, edit or otherwise modify elements in the design model.
Picture Generation	To generate images of the design model on a computer screen or on some hard-copy device.
User Interaction	To handle commands input by the user and to present output to the user about the operation of the system.
Database Management	For the management of the files that make up the database.
Applications	These elements of the software do not modify the design model, but use it to generate information for evaluation, analysis or manufacture.
Utilities	A "catch-all" term for parts of the software that do not directly affect the design model, but modify the operation of the system in some way (for example, to select the color to be used for display, or the units to be used for construction of a drawing).

2.2.4 The Design Process

In recent years, there has been an increasing amount of literature describing the importance for understanding design as a decision-making process. For Stevenson (1999), a design process generally starts with the motivation for the design itself. The term “motivation” is used by Stevenson in two overlapping senses. First, for a new business, the motivation would be to achieve the goals of the organization. Secondly, for an existing business, in addition to their goals, they are continuously adapting to accommodate ongoing influences, such as government regulations, competitive pressures, customer needs, and the appearance of new technologies. Although the previous influences are important, there appears to be some agreement that customer satisfaction is the most important factor for motivation to continue. Failing to do so could result in disgruntled customers and a subsequent loss of market share.

Typically, the design process occurs as a result of transforming a business’ ideas or improved products. There are several methods that an organization may use to form new ideas for better consumer products, such as surveys, focus groups, personal Interviews, and observation. According to Stevenson, some organizations encompass research and development departments to develop new ideas for better products and services.

In addition, researching a competitor’s successful products is another important approach for idea generation. An organization may study not only the competitor’s products, but they might also study before and after sale services, such as pricing policies, maintenance and warranties. Stevenson points out the term reverse engineering, which is the process that some companies utilize by buying a competitor’s newly designed product, and then understanding the strengths and weaknesses of the design by dismantling and inspecting the product. As a result of the competitor’s product examination, a company may adapt and develop some of the advanced features in their own future product production.

There are many companies that incorporate the reverse engineering approach. One of these is the Ford Motor Company, which considered reviewing some of the competitors’ automobiles best-in-class products to advance their own Taurus model. It should be noted that using reverse engineering may aid some companies to manufacture their new model with enhanced capabilities and improvements beyond the competitor’s product. Having designers and engineers analyze, and import products from other companies, can be beneficial in terms of cost and time effectiveness. Furthermore, the main beneficiary of this process is the consumers, who receives superior products and services (Stevenson, 1999).

Opportunities and capabilities are important driving factors of production. Opportunities can be defined as the potential for increasing the value by improving performance and the features of a product. Capabilities can be defined as the ability to do something well and efficiently,

consisting of different elements or components which are part of a systematic process, such as software and hardware equipment, manufacturing machines, employee skills, materials availability, schedules and technologies. The aim of designers in general and of the design outputs in particular, is to achieve the desired level of understanding of the capabilities of production. This will assist designers and engineers in linking their design opportunities with the production capabilities. Sometimes process opportunities and capabilities can be conflicting, however, in some circumstances, company management can restructure the procedures to facilitate the new process of design and manufacturing. This is possible by altering or adding new capabilities, which will assist in accommodating the desired opportunities (Stevenson, 1999).

Forecasts are sometimes considered very useful methods to predict future demands. As previously mentioned, some companies have research and development departments, and part of their mission is to collect information, which in turn can determine their future direction in terms of the quantity and quality of future products. Besides its function, product cost and the target market should be kept in mind when designing a new product. The manufacturing method is also one of the keys to success for any product in terms of manufacturing and assembly steps, which will positively affect the price of the product, the cost and speed of production, and quality (Stevenson, 1999).

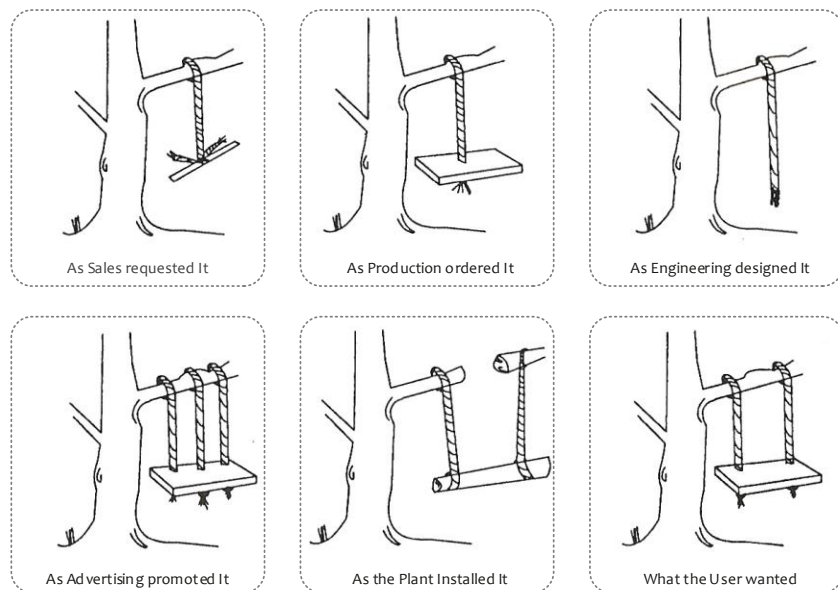



Figure 2.15: Miscommunication in design, adapted from Rouse (1991)

The process of information gathering and analysis is one of the most important steps before design begins. Figure 2.15 illustrates design alternatives from different departments during the



design process. The point here lies in the importance of providing information that will contribute effectively in translating user needs and requirements to facilitate the process of communication among all parties involved, from design and manufacturing to marketing of the product (Rouse, 1991).

In any event, design, manufacturing, operation and marketing must be connected through the exchange of information, especially with all of the customer's needs and updated requests. In addition to this, government regulations may also affect the overall design of the product in terms of functionality and use of materials.

Despite the architectural challenges mentioned above, architects and engineers need to take into account aspects that may conflict during the initial design phase. According to Lewis (2001), architects and engineers must develop strategic plans to organize the construction process. This stage is an important step in terms of the development of initial design ideas, and therefore, to increase familiarity with the basic, general and detailed requirements for the product. In addition, knowing the probability of design requirements conflicting with other determinants in an earlier design stage will help accelerate the design process, and then the manufacturing or construction processes.

In his book, *Architect? A Candid Guide to the Profession* published in 2001, Lewis discussed the challenges and limitations that may conflict, such as the requirements of the program, the status of the construction site, construction budget constraints, government regulations, weather conditions, and aesthetics of design from the architect's (architectural) point of view, as well as the desires of the owner. In addition, Lewis mentioned the function of the project and the consequent issuance of the necessary permits for construction. These permits are often directly related to the location, whether in big cities or small towns, and there are many approvals that must be obtained throughout the project design and documentation stages.

These obstacles can be overcome or their impact minimized by forming a team that is aware of the building codes, standards and regulation requirements. The team usually contains the architects, the owner or the owner's representative, consulting engineers, such as structural, mechanical, electrical and transportation engineers, economic analysts and environmental scientists (Lewis, 2001). Since the aim of this research team is to evaluate and validate the design and manufacturing processes in the modular housing industry, there is a need to expand the team to include a design analyst and manufacturing specialists.

Today, design teams come under pressure to develop products that perform better with longer life, and at lower costs, which often means reduced energy use, lower price and faster



production. To achieve these goals, designers and engineers tend to employ machines with computer interfaces as tools to assist in development and manufacturing production. Using computers as a platform with other related technologies assist teams by increasing efficiency and productivity. Whether a new or experienced team, there is a need to learn how to use computers for information processing, which will support linking their product design with manufacturing systems (McMahon and Browne, 1998).

To determine the effects of computers within design and manufacturing processes, McMahon and Browne described the stages of the design process, linking any product development to market need. The process typically begins with gathering information as a design brief about the product, which will be a key base for product development. Then, the product designers develop and convert this information into detailed drawings and instructions for manufacture. During this step, support is provided by the design analysts using analytical and simulation programs to test the proposed design. After that, the design will be verified by development engineers who test the design through prototypes, which can improve the design proposal. In many cases, research engineers join the team to bridge the gaps in understanding the relationship between materials and manufacturing methods.

Upon completion of all phases of design development, a process planner will identify the required manufacturing processes and operating systems, production line and installation to activate the manufacture of the product. Then, the production planner and controller is responsible for the operating details and scheduling the manufacturing processes for all of the different parts of the product. The size of the team varies from one project to another and depends upon the complexity of the project or product (McMahon and Browne, 1998).

Although there have been many attempts to map the design process, no one description is accepted. The most likely causes of this are different individual designers, diverse terminologies and representations among many industries, and the diverse functions and sizes of different products (Ohsuga, 1989). In architecture, the design process typically is based upon two characteristics: 1) intangible, and 2) tangible. The intangible more likely represents design ideas and we will never be able to map this completely (particularly the intangible). We can only hope to map the tangible aspects.

According to McMahon and Browne, there is agreement on the way design progresses in a step-by-step yet interactive manner. These steps start with gathering information, analyzing the problem, searching for solutions, and development of the proposed solution for manufacturing. McMahon and Browne use the term “models of the design process” to explain the design stages or steps.

In order to understand the design process more clearly, McMahon and Browne considered two models. First, is the design process model as proposed by Pahl and Beitz (1984) . Table 2.2 illustrates some of the key characteristics of the main phases.

Table 2.2: Description for the main phases of the design process (McMahon & Browne, 1998).

Phase	Description
Clarification of The Task	<i>Which involves collecting information about the design requirements and the constraints on the design, and describing these in a specification</i>
Conceptual Design	<i>Which involves establishment of the functions to be included in the design, and identification and development of suitable solutions</i>
Embodiment Design	<i>In which the conceptual solution is developed in more detail, problems are resolved and weak aspects eliminated</i>
Detail Design	<i>In which the dimensions, tolerances, materials and form of individual components of the design are specified in detail for subsequent manufacture</i>

In their model, the design process is a flow of successive steps. As shown in Figure 2.16, Pahl and Beitz identify four main phases:

- 1) Clarification of the task
- 2) Conceptual design
- 3) Embodiment design
- 4) Detail design

In each step, there is a decision that must be made in order to move on to the next step. If there is a comment concerning the previous step, feedback and re-design may be implemented.

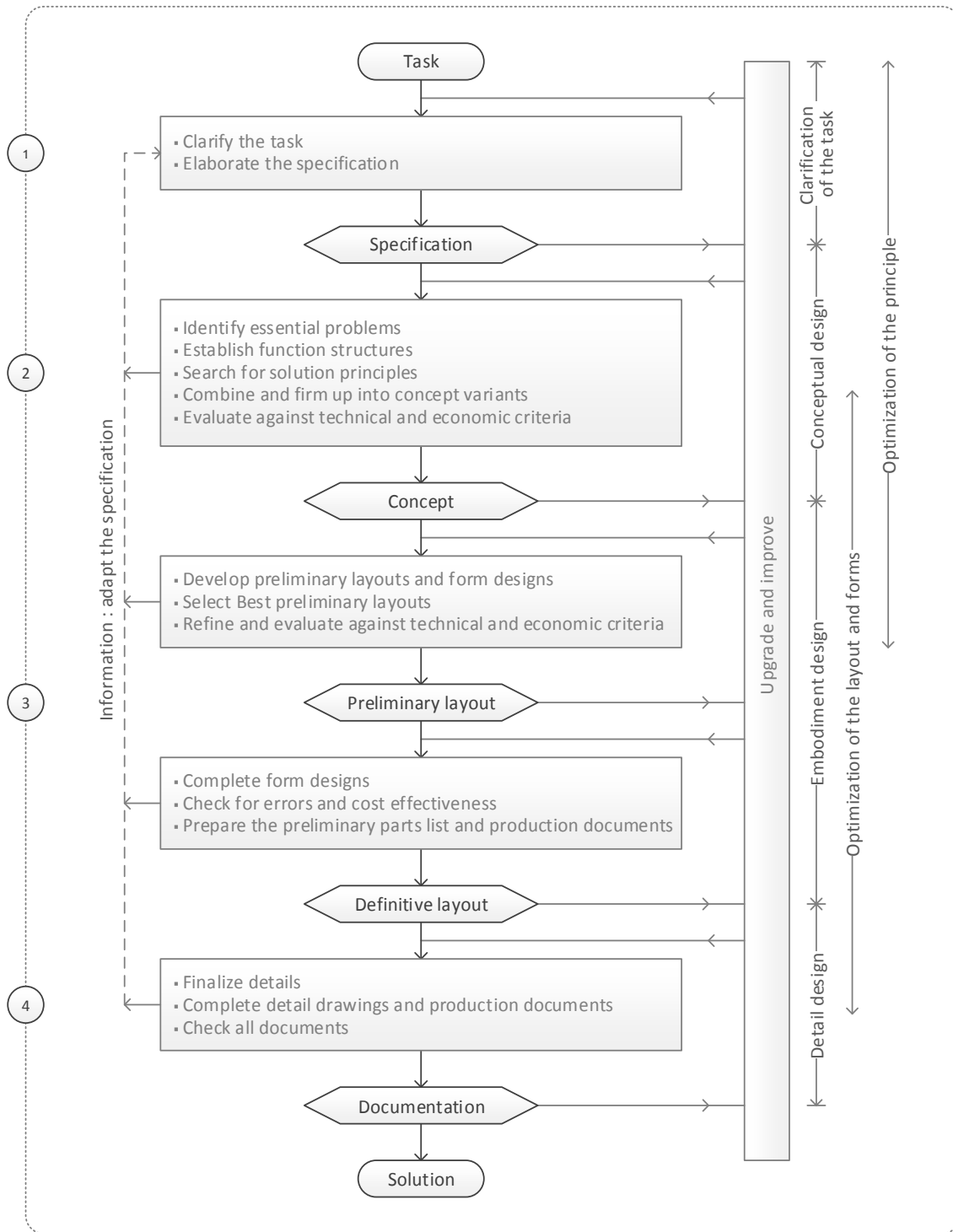

Figure 2.16: Steps of the design process, adapted from Pahl and Beitz (1984).

Second, the typical design process model as proposed by Ohsuga (1989) focuses on the workflow of the design process in general, which is divided into several stages, as shown in Figure 2.17. In his model, Ohsuga identifies three main design stages: 1) conceptual design, 2) preliminary design, and 3) detail design. At each stage, there are different steps for analyzing and evaluating the proposed models. In doing this, any conflicting requirements of the proposal are captured, thus assisting the development teams in modifying and refining the design. Accordingly, it is not necessary during the early stages of the design to address all requirements.

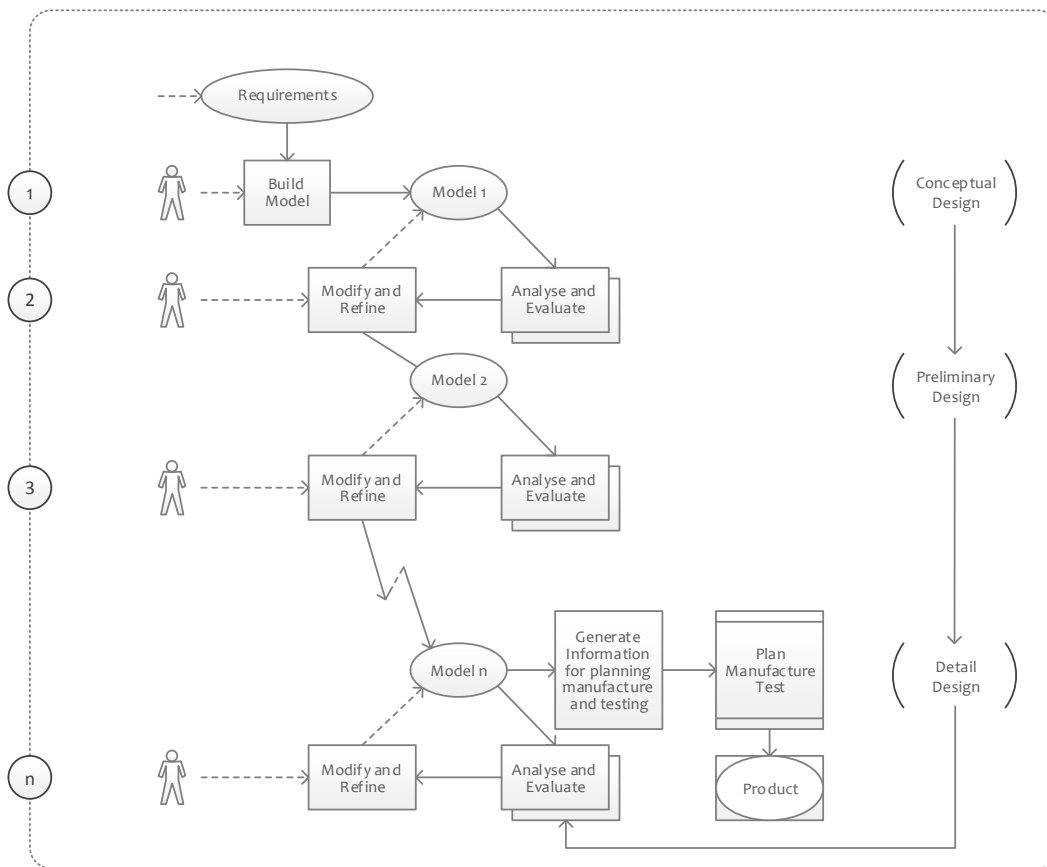



Figure 2.17: Typical design process. Adapted from Ohsuga (1989)

During the conceptual design stage, analysis, evaluations and modifications will continue until the design reaches a more refined phase, as it passes to the preliminary design stage. As a result of this progress, re-evaluation and analysis is repeated to further improve and refine the proposal before starting the next stage. Once the desired results are reached, work begins in the detail design stage. At this point, the design of the object model becomes more accurate and in conformity with the requirements and specifications from design to manufacturing/ construction (Ohsuga, 1989).



One question that needs to be asked, however, is whether the previous two design-process models are suitable for adaptation to the modular building industry. Both models would have been much more useful if the authors had considered bridging the gaps between the various design sub-teams and disciplines by proposing their work in parallel and not in sequence. These models are useful, however, for describing functional requirements during the conceptual design, preliminary design, detail design, implementation, and documentation stages.

This research is intended to focus upon mapping the design and manufacturing processes for a specific scale of projects - residential units based on the single-family unit and specifically detached units.

In the United States, projects that were designed by architects actually represent a very small percentage in comparison to the number of projects built by developers (Deamer and Bernstein, 2010). This assessment reflects the reason behind the low number of good design projects available in the market.

The on-site construction process typically can be performed by one or different entities. Additionally, there are a number of different factors that may contribute to an architect's involvement within the construction of a single-family unit, such as a general contractor, large and small developers. For example, a general contractor can hire an architect for designing a project. In this case, the architect's involvement in the construction phase might be increased due to the fact that the contractor is the client (Lewis, 2001). In contrast, the typical client can hire an architect to provide him with the basic architectural services based upon The American Institute of Architects' (AIA) standard agreement (AIA Document B141). In this case, the architect's involvement in the construction phase will be limited due to the client's responsibility for hiring a contractor (American Institute of, 2002). In some housing projects, large developer companies may act as the client, designer, and contractor, since they have all the departments under one roof. Some small developer companies work through the concept of networking process; they basically have a list of consultants, materials suppliers, contractors, and subcontractors.

According to Lewis (2001), architects may play different roles as well by investing in their own design. There are two different approaches. In the first, an architect may handle the entire design and construction processes from buying a property and constructing his/her design then selling or leasing it for a profit. In the second, an architect may act as a designer and at the same time as a general contractor for their clients.

At this point, it is necessary to clarify the basic architectural services based upon the AIA standard agreement. There are five phases under this contract: 1) schematic design, 2) design development, 3) construction documents, 4) bidding or negotiation, and 5) construction contract administration. Table 2.3 describes the work product needed for each phase according to Lewis (2001).

Table 2.3: The work product needed for each phase (Lewis, 2001)

Phase	Work Product
<ul style="list-style-type: none"> • Schematic design-analysis of the owner's program, site, and budget; preliminary design studies in sketch form and preliminary estimate of probable construction cost. 	<ul style="list-style-type: none"> • Program diagrams • Function diagrams • Site plans, floor plans, sections, elevations, perspectives, models, in sketch form
<ul style="list-style-type: none"> • Design development-further development of the schematic design; definition of basic project systems and materials; decision on project size, dimensions, architectural character; update estimate. 	<ul style="list-style-type: none"> • More precise plans, sections, elevations, site plan drawings; more realistic perspectives and study models constructed either manually or by computer
<ul style="list-style-type: none"> • Construction documents-detailed design of the project, including all engineering design, selection of materials, establishment of dimensions, construction assembly details, appropriate construction notes (required to obtain construction bids and building permits). 	<ul style="list-style-type: none"> • Working drawings • Specifications • Bidding information
<ul style="list-style-type: none"> • Bidding or negotiation-during or after completion of the construction documents, assisting the client in finding, screening, selecting qualified general contractors from whom bids may be obtained or with whom a contract may be negotiated; assisting the client in reviewing bids and awarding contracts. 	<ul style="list-style-type: none"> • Contractor's bids • Construction contracts • Modified design documents to meet budget limits
<ul style="list-style-type: none"> • Construction administration-representing or assisting the client in administering the construction contract, including making design changes, site visits, reviewing the contractor's work, requests for payment, selecting colors and previously unspecified items, checking shop drawings prepared by fabricators, mediating disputes between contractor and owner. 	<ul style="list-style-type: none"> • Design clarification documents • Change orders • Field reports of site visits • Certifications for payment and completion

Beside the previous five phases, the AIA contract has the possibility for adding additional services based upon the agreement between the client and the architect. Services such as detailed cost estimates, economic feasibility studies, and interior design can be added, as well as surveying and measuring existing structures, and engineering consultation considered additional services (Lewis, 2001).

Unlike on-site construction, modular construction is considered more complicated business due to the involvement of multiple stakeholders. To buy a modular home, a client normally needs to find a professional dealer who can provide several services. Gianino (2005) discusses the challenges for finding a dealer that cannot only sell and deliver a modular home, but most importantly a dealer who can take over responsibility for coordination among all the participants in the work. These services typically cover the main four phases beside obtaining all the required permits, which are design, manufacturing, transportation, and ending with the assembly of the project on site. Table 2.4 below shows the responsibilities of each participant in building a modular home according to Gianino.

Table 2.4: The responsibilities of each participant in building a modular home (Gianino, 2005)

-
- **The dealer's staff:** to design a floor plan, select building specifications, and price the package
 - **The manufacturer's sales and engineering departments:** to ensure that the dealer's order is understood and executed correctly
 - **The realtor:** to find a building site
 - **The building inspector:** to issue the permits and approvals
 - **The lender:** to provide financing
 - **The installation crew and crane:** to set the home on the foundation
 - **The general contractor:** to oversee the construction
 - **The manufacturer's service crew:** to complete the warranty work
 - **The dealer's service crew:** to assist with the warranty work
-

Gianino (2005) points out that most of the modular home manufacturers will not agree to work directly with a client and require the presence of the dealer. So, all of the communications and responsibilities for any error may result from any stage after manufacturing are under the accountability of the dealer. This will save their rights from any legal prosecution by the owner in the event of any errors or damages as a result of the transportation or the installation of the project. The previous discussion regarding the modular construction industry shows that typically there is no involvement from architects in the construction of modular homes.

To enhance the involvement of architects in the modular construction industry, architects first need to understand methodologies such as design for manufacturing (DFM) and design for assembly (DFA). Also, there is a need to understand the factory production advantages and limitations in order to develop new design processes, features and various different options that might not be viable in comparison with the traditional method of construction. Second, it is important to improve the relationship between design and construction, specifically the modular construction industry, by shifting from the traditional design-bid-build (DBB) contract approach to more of an integrated approach such as design-build (DB) and integrated project delivery (IPD).

On the traditional DBB approach, the owner needs to have two different contracts for a project, one for the design and the other for the construction. DBB is based upon three sequential phases, which are design, bidding, and construction. The design and bidding phases are part of the basic architectural services contract as discussed earlier. Potential problems such as an increase in the project's cost and time may occur as a result of the separation between the design and construction phases.

On the other hand, with DB both the design and construction will be performed and then delivered to the owner as part of one contract. In this case, the design and construction teams are working together in the same firm. This means design and construction concerns might be avoided earlier in the design process and through the development of the final project documents. For example, the construction team might alert the design team about how implementing a specific structural system could reduce the cost and time of finishing the project (Ling et al., 2004, El Wardani et al., 2006).

The IPD approach is considered the newest project delivery method in construction. In general, the IPD is based upon collaborative efforts of different stakeholders that agree to work as one team and also share the risk of failure and success. The main team members are the owner, architect, and contractor (Bongiorni and Cohort, 2011). According to Smith (2010), one major benefit of the IPD approach, besides the simultaneous design development process, is the ability to share and exchange the digital information directly with other specialist teams under this contract, where in the traditional contracts is not permitted. Figure 2.18 presents the relationship among different stakeholders based upon the project delivery method.

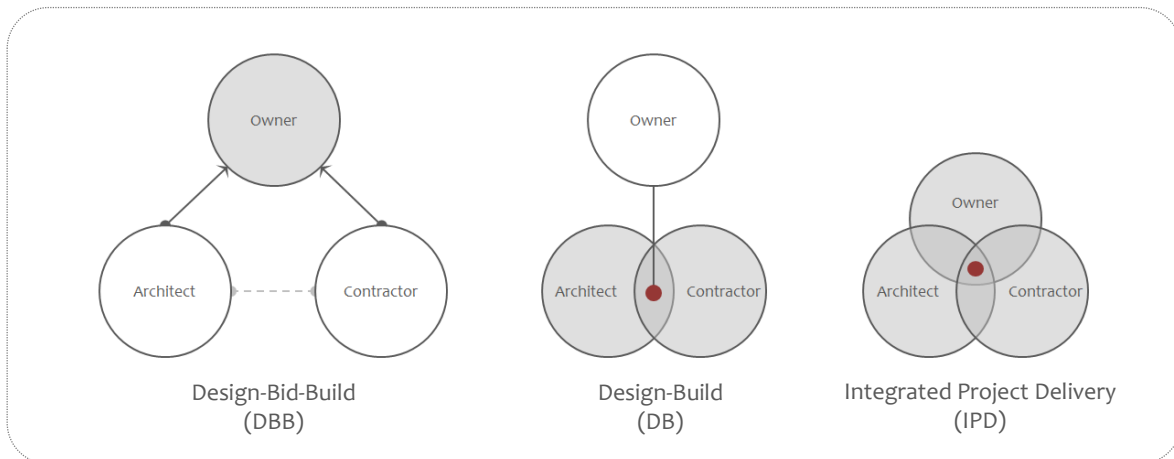

Figure 2.18: Project delivery methods. Adapted from Smith (2010)

2.2.5 Information Exchange between Design and Manufacturing

For nearly three decades, Computer Aided Design (CAD), based on two-dimensional representation, has opened up new possibilities to Architecture, Engineering, and Construction professions (AEC). The information revolution has shifted the documentation production process from manual (hand) drafting, to digital drawings through the use of computers as drafting tools. As a result of this transformation, the communication between AEC stakeholders has improved. Although the architectural drawings are now often digitally produced, the design of buildings remains essentially the same, based on plans, sections and elevations. After the introduction of three-dimensional modeling software, architects and engineers began to explore new geometries and construction techniques.

In time, the number of architectural and engineering software packages has increased, with multiple applications for each field, with many different file formats (Table 2.5) (Eastman, 2008).

Table 2.5: Common exchange formats in AEC applications (Eastman, 2008)

Image formats	
JPG, GIF, TIF, BMP, PIC, PNG, RAW, TGA, RLE	Raster formats vary in terms of compactness, number of possible colors per pixel, some compress with some data loss
2D Vector formats	
DXF, DWG, AI, CGM, EMF, IGS, WMF, DGN	Vector formats vary regarding compactness, line widths and pattern control, color, layering and types of curves supported
3D Surface and Shape formats	
3DS, WRL, STL, IGS, SAT, DXF, DWG, OBJ, DGN, PDF(3D), XGL, DWF, U3D, IPT, PTS	3D surface and shape formats vary according to the types of surfaces and edges represented, whether they represent surfaces and/or solids, any material properties of the shape (color, image bitmap, texture map) or viewpoint information.
3D Object Exchange formats	
STP, EXP, CIS/2	Product data model formats represent geometry according to the 2D or 3D types represented. They also carry object properties and relations between objects
Game formats	
RWQ X, GOF, FACT	Game file formats vary according to the types of surfaces, whether they carry hierarchical structure, types of material properties, texture and bump map parameters, animation and skinning
GIS formats	
SHP, SHX, DBF, DEM, NED	Geographical information system formats
XML formats	
AecXML, Obix, AEX, bcXML, AGCxml	XML schemas developed for the exchange of building data They vary according to the information exchanged and the workflows supported

As a result of the variety of formats, the information flow between AEC stakeholders has become more complex, with unintended effects such as the need to redraw the drawing from one platform to another, since they are not compatible (Figure 2.19).

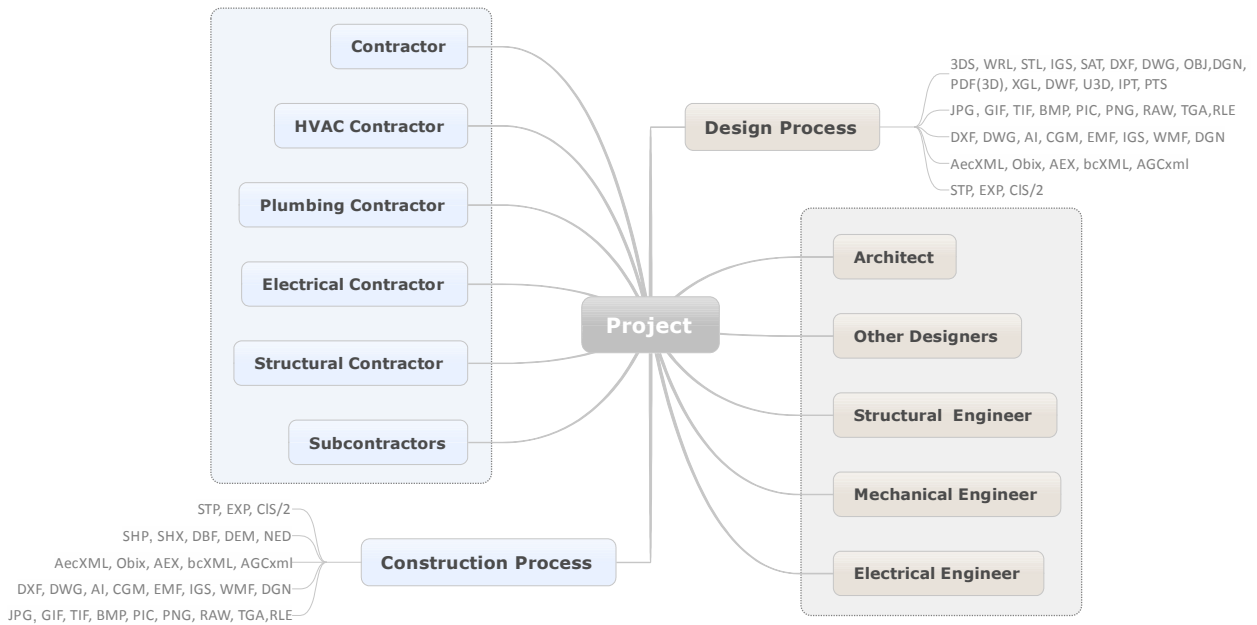

Figure 2.19: The variety of file formats between the AEC stakeholders.

2.2.6 Building Information Modeling for Collaborative Design

With the development of digital building modeling tools, there are new requirements for software interoperability. A new fully interoperable software environment could support a higher level of collaboration during the design and the construction processes. Building information modeling (BIM) has opened new possibilities for the transfer of digital information between the different disciplines.

BIM as a technology deals with building models as objects which can support the transfer of information concerning the relations and attributes of those objects (Eastman, 2008). BIM as a design tool supports automatic updating each time a change has been made by any of the design team members.

BIM technology has also helped in reducing the time and costs of reproducing drawings associated with any new developments affecting the work of another design team. Since an automatic updating of information is sent to all the design teams, this allows the affected design

team to take immediate action and to look into new alternatives (Figure 2.20). However, when an attempt is made to implement BIM, difficulties arise.

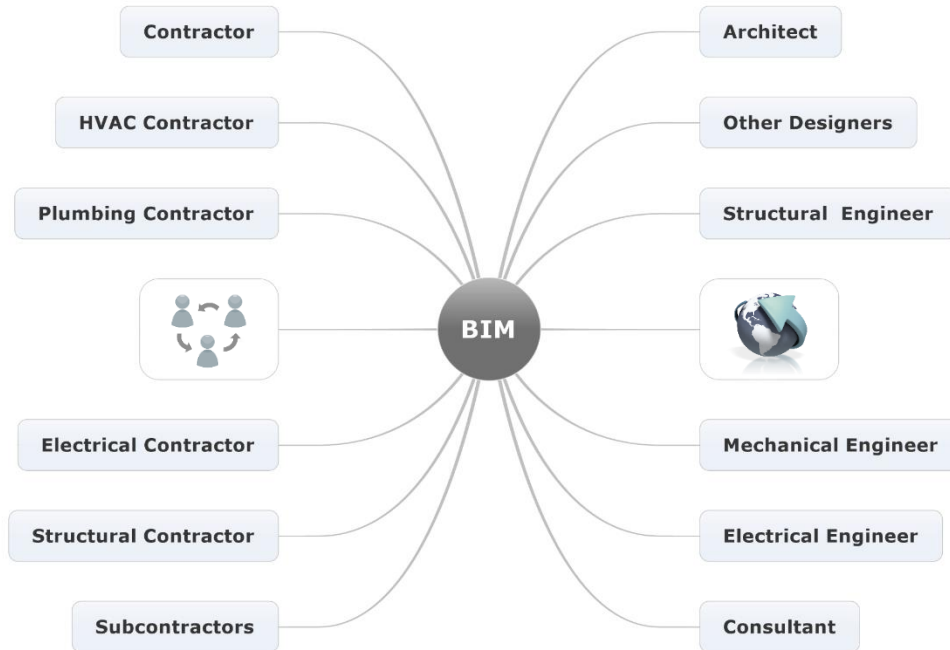

Figure 2.20: The possibilities of transferring the building models between the different disciplines through BIM.

According to Eastman (2008), the obstacles to adopting BIM can be categorized into four main problems: 1) *Challenges with collaboration and teaming*, 2) *Legal changes to documentation ownership and production*, 3) *Changes in practice and use of information*, and 4) *Implementation issues*. Among *challenges with collaboration and teaming* problems are, for example, how to form and lead different teams and fields for effective performance, how many software applications will be used during each phase of the project to produce 3D and 2D construction drawings (concept, design development, construction, fabrication, detailed schedules, and lists of the items and quantities), as well as how to share and permit access to the BIM model among different teams of the project.

BIM is the process of using a single 3D model; however, the number of architectural and engineering software packages has increased, with multiple applications for each field featuring many different file formats. Today, the Industry Foundation Classes (IFC) data model can be used as a standard extension to exchange data among different software platforms. Additionally, having one central model server to all teams involved in the project may assist in increasing benefits offered by different BIM applications and IFC standards.

Legal changes to documentation ownership and production problems are mainly related to copyright (“Who will own the model?”), cost (“Who pays for them?”), and precision (“Who is responsible for their accuracy?”) (Eastman, 2008, Kiviniemi, 2011). According to Eastman, these are questions raised by practitioners using BIM on their projects. Typically, before the use of BIM technology, the American Institute of Architects (AIA) stated on their forms of contract that the original documents were under the ownership of the architect. Owners can have copies of the project documents as long as the contract is valid. Otherwise, the owner needs to return all of the project copies to the architect and he is not permitted to develop, modify or start a new project based upon the terminated contract (Deamer and Bernstein, 2010). BIM is more than just traditional drawings and there is a need to develop new contract guidelines to overcome issues with BIM implementation. Eastman points out that the AIA and the Associated General Contractors of America (AGC) are working to develop a contractual guidance to rule out any existing issues.

Changes in practice and use of information problems are related to restructuring the relationships among the architecture, engineering, and construction (AEC) industry, and how the information flows among the project teams. Architects, engineers and contractors must develop a new framework for sharing information and organize the design progress and construction processes. This stage is an important step, since most of the AEC firms need to work on one shared building model starting from the development of initial design ideas through general and detailed requirements for the project (Kiviniemi and Fischer, 2009). In order to achieve a higher level of integration among the AEC network when implementing BIM technology, there is a need to improve and integrate the knowledge of construction and fabrication by determining the project delivery method at a much earlier stage. This will influence the direction and the development of the intended project. Additionally, the implementation of BIM tools require technology upgrades (higher performing computer hardware), as well as additional time for transformation and constant training (Eastman, 2008).

Implementation issues might be avoided by developing general and detailed plans to change from only CAD software to a BIM environment. In this stage, it is important to have a team leader to guide the staff and manage the sequential transformation phases including software, upgrading hardware, and training. These changes may differ from one firm to another based upon their expertise. However, Eastman (2008) points out some general steps that need to be considered throughout the implementation phases, such as evaluating the impact of the transformation to BIM technology in terms of cost, time and performance not only internally within the firm, but also externally with other firms and clients.

Eastman suggested starting by using and testing the BIM system through small scale projects in parallel with existing technology, which may assist with comparing and evaluating the results between the new and existing systems. It will also enhance the staff experience by learning

from previous problems and limitations. The next step is to work on a new project with other firms under a BIM environment in an earlier design stage which will help accelerate the design process, sharing of knowledge and then the manufacturing or construction processes.

There are several BIM tools for architectural design including: Archicad, Revit, Bentley Systems, Digital Project, Autocad-based Applications, Tekla Structures, and DProfiler, each having their own strengths and weaknesses (Eastman, 2008). These programs are continually being updated.

2.2.7 Sequential vs. Concurrent Design Processes

This brings us to the earlier question, “*Would a software based BIM technology be useful to support design for fabrication processes?*” Today, BIM does not directly support the fabrication processes. BIM can help overcome this problem, providing design teams with instant feedback and analysis of the building systems during the conceptual design stage.

Although BIM technology can support bringing different design teams together working on one model, unfortunately there is still a noticeable gap between the design and the construction team. Technological advances for the software, new materials, and digital manufacturing practices have increased the communication gaps between different disciplines.

Presently, with the ability to exchange information between CAD/CAM technologies, the need for bridging the gap is vital in order to increase performance and production, and decrease construction times and cost for projects. Previously, we were dealing with projects through a sequential design process, but now we have more complex geometry, higher-performance structures, and automated and advanced manufacturing processes. With these changes, the design process needs to evolve. Perhaps the most serious disadvantage of the sequential design process is that problems occur as a result of the poor communication between the design and the construction teams. Problems such as the site conditions, construction budget constraints, environmental regulations, and building and safety codes might be avoided if the design team considers the construction requirements earlier during the design process.

Another problem with poor communication would be failing to take the quality aspect into account. Quality should be managed not only during the construction phase, but also throughout the design and specification phases of the project. Managing quality through the construction phase may help to solve problems such as mechanical and electrical issues that might appear during early implementation, but the goal should also be to avoid these problems over the life-cycle of the building (Cornick, 1991).

According to Evbuomwan and Anumba (1998), to achieve a successful project life-cycle, there is a need to rethink the traditional design and construction framework. Typically, a project is

established and developed through different professionals and disciplines based upon the project's size and function, such as architects, engineers (structural, mechanical, electrical, plumbing), and contractors. However, the main weakness of such a traditional framework lies in the individual action of each discipline resulting in decisions that may affect the other stages during the project development. Below is a list of the problems and disadvantages of the traditional design and construction framework model as pointed out by Evbuomwan and Anumba (Table 2.6):

Table 2.6: Problems and disadvantages of existing framework (Evbuomwan and Anumba, 1998)

- *inadequate capture, structuring, prioritization and implementation of client needs;*
- *the fragmentation of the different participants in most construction projects;*
- *the fragmentation of design, fabrication and construction data; data generated at one stage are not readily re-used downstream;*
- *development of pseudo-optimal design solutions;*
- *the lack of integration, co-ordination and collaboration between the various functional disciplines involved in the life-cycle-issues of the project;*
- *the lack of true life-cycle analysis of projects (including costing, maintenance, etc.);*
- *and the lack of communication of design intent and rationale which leads to unwarranted design changes, unnecessary liability claims, increase in design time and cost, and inadequate pre- and post-design specifications.*

Evbuomwan and Anumba address the unique needs of benefitting from the experience of the manufacturing sector where they shift from the traditional (sequential) process to a concurrent (simultaneous) process. By doing so, they aim to increase the productivity and efficiency of earlier collaborations with instant feedback among diverse design teams from different disciplines, through the design and manufacturing processes. Previously, the manufacturing industry's approach for product development was similar to the construction industry, progressing through different teams based upon their expertise, where every team passes their work (over the wall) to the next team. Figure 2.21 shows the barriers in communication among the design and construction teams.

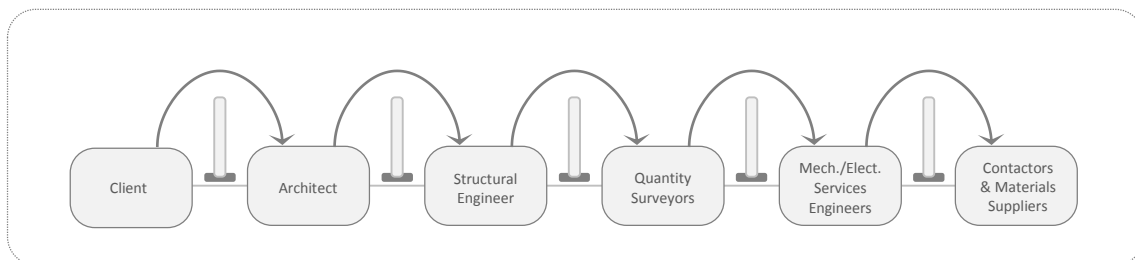

Figure 2.21: The over the wall approach, adapted from Evbuomwan and Anumba (1998)

The term simultaneous or concurrent process has been defined by Broughton (1990) as “an attempt to optimize the design of the product and manufacturing process to achieve reduced lead times and improved quality and cost by the integration of design and manufacturing

activities and by maximizing parallelism in working practices”. Evbuomwan and Anumba modified the previous definition to the context of the construction industry as:

Concurrent engineering attempts to optimize the design of the project and its construction process to achieve reduced lead times, and improved quality and cost by the integration of design, fabrication, construction and erection activities and by maximizing concurrency and collaboration in working practices.

Today, one of the most significant current discussions in the construction industry is how to bridge the gap between design and construction safety (Gambatese and Hinze, 1999, Gangoellis et al., 2010, Zhou et al., 2012). The key problem with this gap is not only the lack of knowledge among most architects and design engineers of construction safety, but also their unfamiliarity with construction processes. Implementing the concurrent approach within the construction industry would assist architects and design engineers to take into consideration construction and worker safety earlier while still in the design phase, through all of the design development phases as well.

2.2.8 Learning from Other Industries

Advanced fabrication processes might be new for the architectural and construction fields, but it has been utilized by the automotive, shipbuilding, and aircraft industries over the last two decades. This raises the question of how have these industries dealt with technological advances. In their book, *Refabricating Architecture*, architects Stephen Kieran and James Timberlake address how technological advances have been utilized in the automotive, shipbuilding and aircraft industries. *Refabricating Architecture* focuses on mass customization and how information technology should avoid isolation among architects, engineers, and constructors during the design process. Kieran and Timberlake call for “integration, not segregation” by redesigning the relationships between disciplines, where information technology plays a major role in immediate interaction (Kieran and Timberlake, 2004).

One example illustrated in *Refabricating Architecture* is the manufacture of cars. The authors state that, “In the manufacture of automobiles, the linear addition of parts along the main assembly line that once produced the model T has, in recent years, been replaced by the production of integrated modules, each composed of hundreds of parts and provided by a number of different suppliers.” Kieran and Timberlake use the Daimler/Chrysler Corporation as an example, where the process engineer is responsible for dividing the car (as a product) into different chunks (parts), and then different teams are formed from several organizations to complete the project. Product engineers and materials scientists from different suppliers work together with designers, the production line, human-factors engineers and supervisors to



produce and develop each module or segment of the vehicle. Each supplier is assigned a specific component, and then delegated to a particular team based upon his expertise. Quality control and assurance are also increased, since they are part of the evaluation of a specific portion of the vehicle. All information and communications among team members is performed electronically through an internal network. Each module or segment of the vehicle is then preassembled, since every module is based upon many parts. This portion of the vehicle is now ready to join the main assembly line as a part of the final product.

Information technology is an important aspect in the above example. With organization based upon three-dimensional visualisation processes, technicians on the assembly line can visualize and understand the installation procedures faster. As a result of this methodology, we can observe how the workflow is optimized. Additionally, quality and production performance are increased, and time and cost reductions are achieved.

In the automotive industry, there is a constant search for new strategies to increase not only the productivity of their R&D, but also other sources for innovations (Ili et al., 2010). Design is considered one of the important innovative factors for successful automotive companies and is protected through Intellectual Property (IP) rights (Sani, 1994).

Unlike the building construction industry, design in the automotive industry is divided into two main stages; one for the design or styling, and the other for engineering. During the styling stage, the design team starts with sketches to develop a new concept design for a car. When they reach a certain level of detail, such as overall shape (body) development, the design team passes the design to the marketing, body, chassis, and manufacturing departments for feedback. Next, the design will be developed to adapt the requirements received from other departments. This process of development might be repeated for further evaluation.

The final decision regarding selecting one of the proposed prototype designs will be made by management. The selected design then will be handed over to the engineering design team. They are accountable for dividing the car (as a product) into different segments, and then different teams are formed from several organizations to develop and complete the project (Sörensen, 2006, Tovey, 1992, Tovey et al., 2003). As can be seen from the previous design development process in the auto industry, the involvement of the designers is limited to the final prototype phase selection. A further discussion will be needed on how to utilize and implement the experience of building a car as a product, to building a building.

2.3 Current Prefabrication, Pre-Assembly and Off-Site Fabrication

Prefabrication has led to new developments in the architecture and construction fields. In the past two decades, prefabrication as a new construction method has resulted in significant changes in the building design process, the construction industry, and the ways in which architects and engineers perform their work. Using prefabrication as a construction method may be very beneficial, by increasing performance and production. Prefabrication may be applied to decrease project construction time and cost.

What Is Prefabrication?

Prefabrication is a technique to produce and manufacture different primary elements of a building at a factory, which are then assembled at the building site. While a variety of definitions of the term prefabrication have been suggested, this research will use the definition proposed in a foundational report for the Construction Industry Institute (CII) in the USA. In their text, *Constructability Improvement Using Prefabrication, Preassembly, and Modularization* (Tatum et al., 1986), Tatum and his colleagues described prefabrication as:

Prefabrication is a manufacturing process, generally taking place at a specialized facility, in which various materials are joined to form a component part of the final installation.

Pre-assembly is one of the construction methods and an important segment that may improve on-site erection time by connecting different sections of primary elements within different systems, so that they can be easily transported and then assembled on site. The term “pre-assembly” has been defined by Tatum, Vanegas, & Williams (1986) as:

Pre-assembly is a process by which various materials, prefabricated components, and/or equipment are joined together at a remote location for subsequent installation as a sub-unit. It is generally focused on a system.

According to a definition provided by The Construction Industry Research and Information Association (CIRIA, 1997), pre-assembly is:

Pre-assembly: For a given piece of work, the organization and completion of a substantial proportion of its final assembly work before installation in its final position. It includes many forms of sub-assembly. It can take place on or off-site, and often involves standardization.

Off-site fabrication may be defined as a systematic process that involves the combination of prefabrication and pre-assembly processes (Figure 2.22). It describes the creation and integration between components of a single building system or between different building systems into an integrated whole product. In his book *Off-Site Fabrication: Prefabrication, Pre-Assembly and Modularization* (1999), Alistair G. F. Gibb defines off-site fabrication based on the CII and CIRIA reports as:

Off-site fabrication is a process which incorporates prefabrication and pre-assembly. The process involves the design and manufacture of units or modules, usually remote from the work site, and their installation to form the permanent works at the work site. In its fullest sense, off-site fabrication requires a project strategy that will change the orientation of the project process from construction to manufacture and installation.

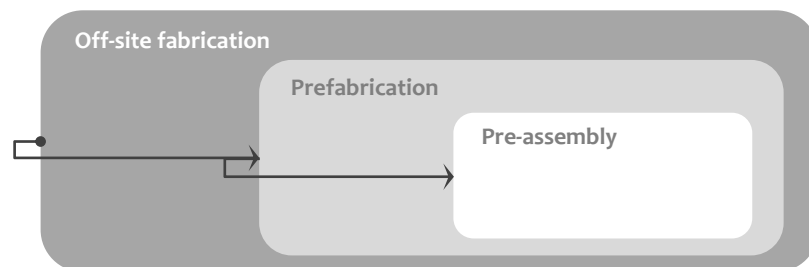

Figure 2.22: Off-site fabrication incorporates prefabrication and pre-assembly processes.

In these previously presented definitions, the importance of designers and engineers being familiar with the techniques of fabrication equipment are implied. This allows many undesired result that the project team might have regarding the final product to be resolved early in the process. In order to avoid this conflict, the project team needs help linking their design to fabrication and construction. This link can be achieved in the conceptual design phase by providing the design team with sufficient knowledge concerning fabrication and construction to make their initial decisions. This process avoids unexpected results that a design team could face during the later stages of the project.

If we look at a typical modular house, we would have to understand all of the different systems involved in the house and design the building in a way that can manage both manufacturing and assembly processes. We would have to consider the linkage among all of the components. Time and cost would quickly become issues, as would understanding how transportation limitations and constraints might adversely affect the outcome.

To determine the different levels of modularity, it is important to decompose the modular house system into four factors, which are functionality, manufacturability, transportability, and assemblability. Each one of these has its own characteristics based upon abilities and limitations. Figure 2.23 presents a simplified view of the modular house factors. The aim of this research is to understand the relationship among these four factors through mapping the order sequence from needs to solutions.

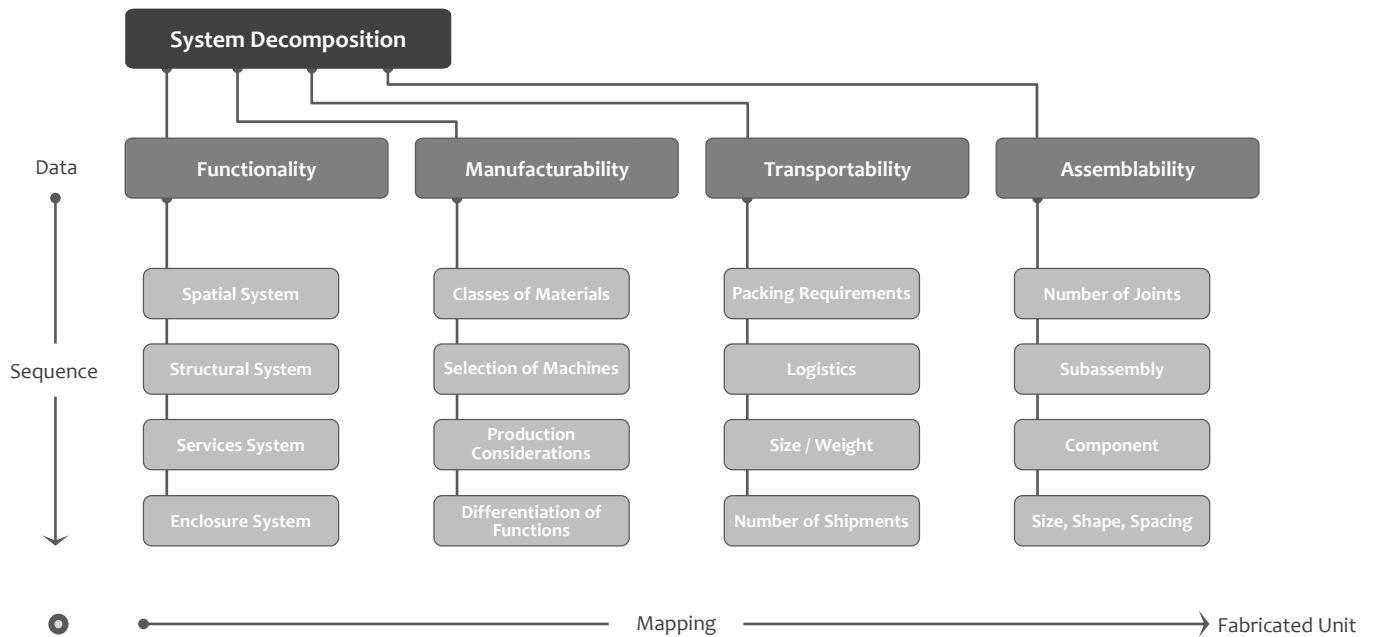

Figure 2.23: Modular house system Decomposition.

Additionally, each factor from Figure 2.23 can be expanded for more details about each system and its subset components. Figure 2.24 shows a simplified framework for the functionality factor, which is also considered the first level of modularity. As can be seen below, the second level of modularity is based upon four main systems under functionality: 1) spatial, 2) structural, 3) services, and 4) enclosure. Each of these contains a number of functional components reflecting the third level of modularity.

What is needed in this research, therefore, is an overall approach first to expand and then to link the other three main factors to the functionality factor. Such an approach could also develop in more specific details the different levels of modularity by addressing barriers and constraints among digital design methods, analysis for constructability, digital manufacturing processes, transportation limitations, and assembly and installation techniques.

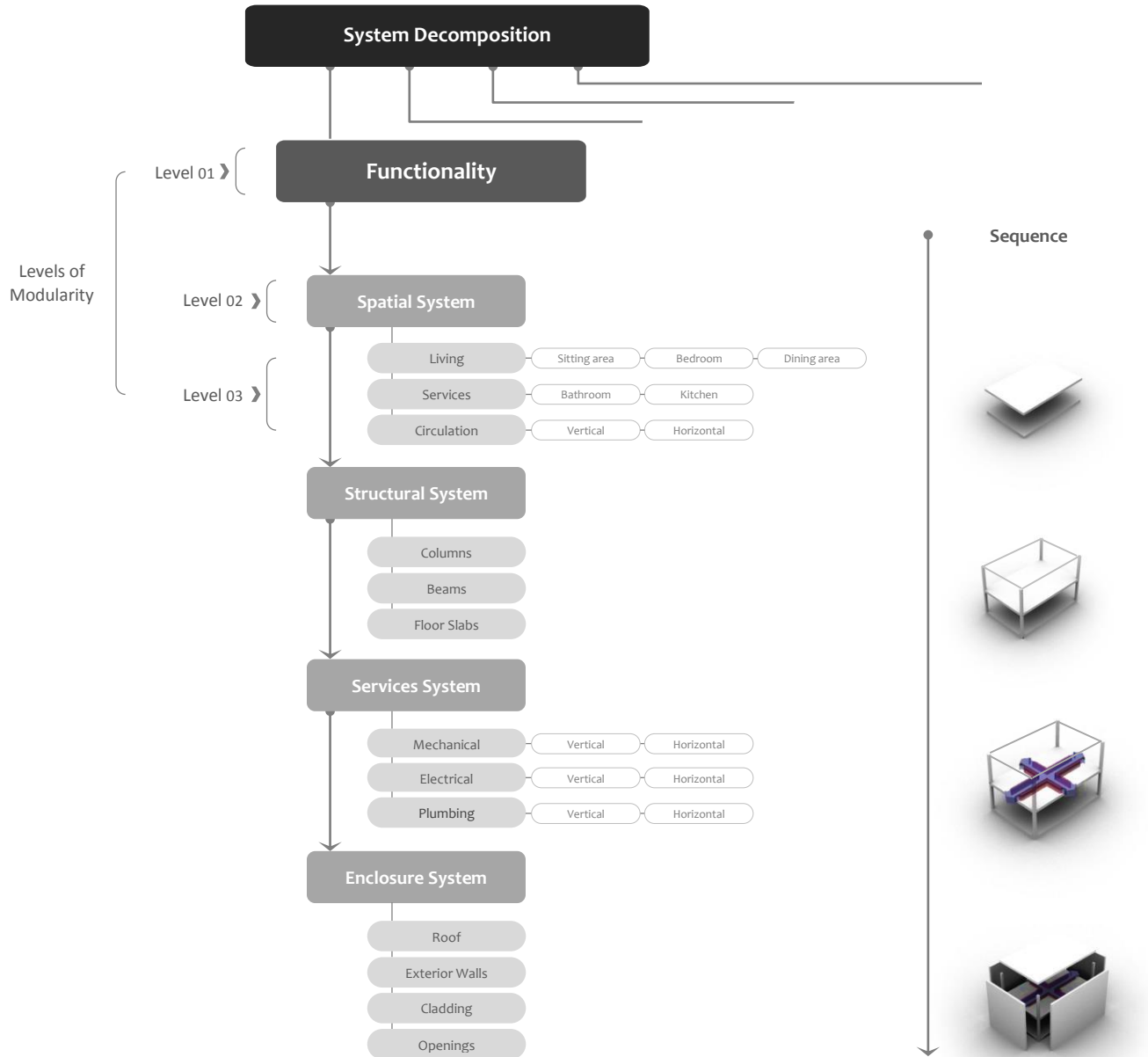

Figure 2.24: Levels of modularity based upon functionality

2.3.1 Digital Fabrication

Digital fabrication aids designers by linking a proposed solution to its production. It is important for designers to be familiar with the techniques of the fabrication process, such as cutting, subtractive, additive, and formative fabrication (Figure 2.25). In addition, each fabrication technique has limitations such as the size of the object, the materials used, the volume of production, and assembly techniques (Kolarevic, 2003). Knowing the capabilities of different fabrication equipment can help architects and engineers to better design while avoiding restrictions imposed by the process.

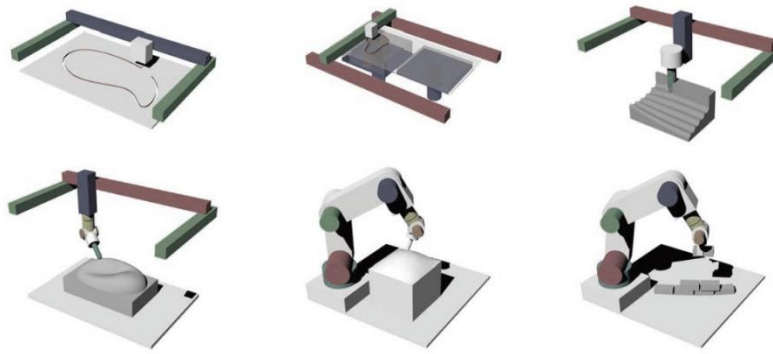

Figure 2.25: Examples of some fabrication tools (Pottmann and Bentley, 2007).

2.3.2 From Mass Production to Mass Customization

Computer-Aided Manufacturing (CAM), digital fabrication and mass-customization all demonstrate the ability to exchange information digitally between CAD/CAM technologies. Even with these emerging tools, geometrically complex building enclosures could be costly to produce and may be limited by traditional construction technologies (mass-production) (Kolarevic, 2003). Further discussion and definitions will be addressed in chapter four.

2.3.3 Fabrication Techniques

As mentioned previously, it is important for architects and engineers to be familiar with the operation of fabrication equipment in order to develop a design with specific requirements, and take that design to final construction. Based upon the complexity of the design, the design team may combine two or more techniques to produce the desired parts. Architects and engineers design buildings by blending primary elements within different systems, such as structural,

enclosure, services and finish systems. As shown in Figure 2.26, understanding the relationship between the primary elements within each system assists in developing new prefabrication methods for a specific building system.

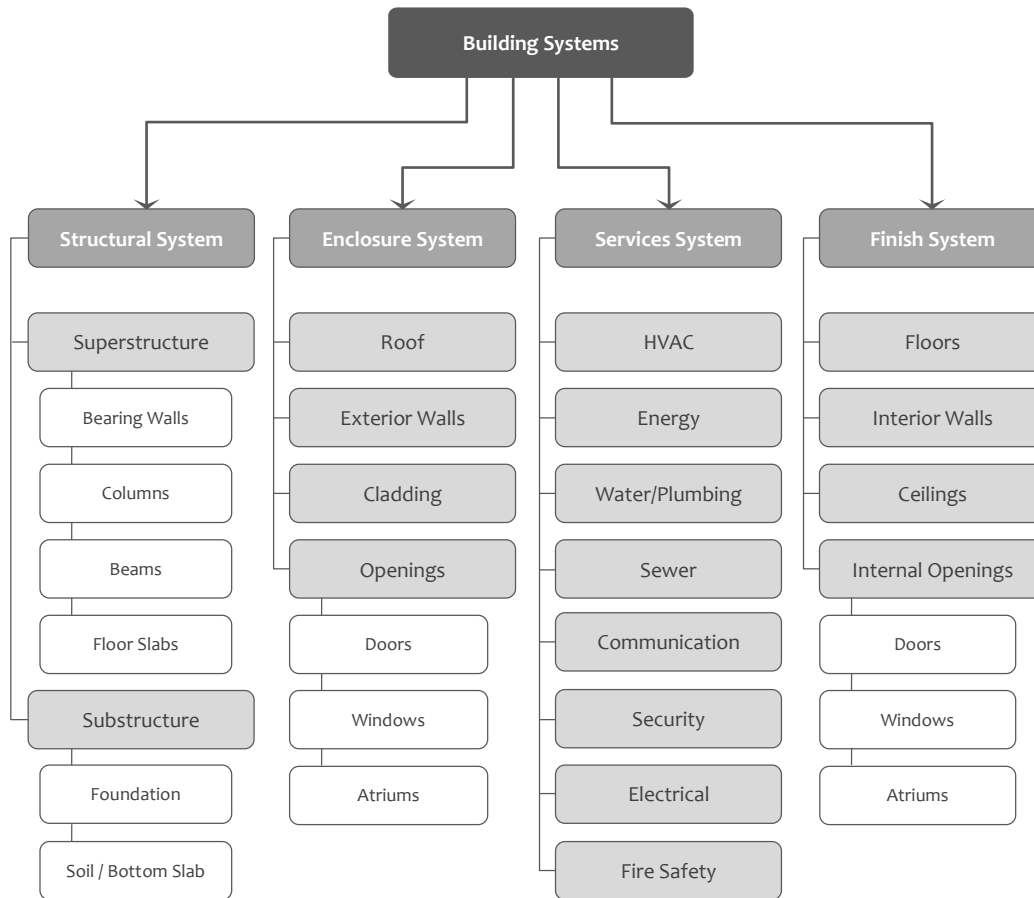

Figure 2.26: The relationship between the primary elements within each system.

As can be seen from Table 2.7 below, Gibb (1999) subdivided most building projects, civil engineering projects, and process plant projects into a number of primary elements. During the design development stage, this should enable the project team to take into consideration and classify exactly what are the elements that will be manufactured in the factory, and what the remaining work is on each element to be performed on site. Next, options for materials and methods for manufacturing building systems and elements are selected. Design and production

information is then prepared, including all the required details for prefabrication and pre-assembly techniques.

Table 2.7: Primary elements of building, civil engineering and process plant projects (Gibb, 1999).

<i>Building projects subdivided into primary elements</i>	
- Substructure	<i>Foundations and works below ground</i>
- Frame	<i>The structure of the building</i>
- Envelope	<i>The external walls and roof that form the perimeter of the building</i>
- Services	<i>The mechanical and electrical building services distribution</i>
- Internal works	<i>The internal walls, raised floors, suspended ceilings and applied finishes such as plaster, paint, wall coverings, etc.</i>
- Facilities	<i>The major parts of the building that are generally provided by the developer for the use of the end-user, such as the toilet/washrooms, kitchens, lifts/elevators, plant rooms, building management system rooms, etc.</i>
<i>Civil engineering projects subdivided into primary elements</i>	
- Substructure	<i>Foundations and works below ground</i>
- Structure	<i>The structure itself. For civil engineering projects this is usually the most significant element</i>
- Services	<i>The mechanical and electrical services where applicable</i>
- Special equipment	<i>Additional specialist items that are necessary for the function of the project</i>
<i>Process plant (or power generation) projects subdivided into primary elements</i>	
- Substructure	<i>Foundations and works below ground</i>
- Frame and envelope	<i>The structure of the facility and the external walls and roof that house the process plant. These two items are often considered together</i>
- Process equipment	<i>The plant and machinery which form part of the end-user's business. For example, process plant, manufacturing machinery, along with all necessary supply and waste removal services and distribution. For process plant projects this is almost always the major element, and all other aspects are subservient</i>

Based upon the complexity of the building enclosure (envelope) design, the design team may combine two or more techniques to produce the desired segments. Several types of digital fabrication techniques are presently available. These include: sectioning, tessellating, folding, contouring and forming (Iwamoto, 2009). Figure 2.27 shows some examples of fabrication techniques.



Figure 2.27: Examples of fabrication techniques.

2.3.4 Design for Manufacturing

Design is a process of translating information to an object or product, whereas manufacturing is a process of transforming the final design to its physical manifestation. It is important to take into consideration during the design phase the manufacturing processes based upon their availabilities and options. However, this is not the case with many of the manufacturing organizations in the United States.

According to Venkatachalam (1992), the design and manufacturing teams are isolated in many organizations in the manufacturing sector. One major drawback of this approach is that the design team may receive comments for design modifications from the manufacturing team several times, which means increasing design time and cost. McMahon and Browne (1998) reference an example of one large aerospace manufacturer, whose design revision phase and changes for each drawing may take up to 4.5 times before gaining final approval. The key problem with this approach is that at the beginning, the design team does not study the design drawings within the limitations of existing manufacturing methods, preferring to lean toward receiving feedback from the design analyst team and the manufacturing specialists.

As mentioned earlier, McMahon and Browne (1998) define the previous approach (the traditional design process) as an “over the wall” approach, sometimes called the sequential approach. Furthermore, lack of knowledge regarding the production restrictions may result in designing features that may not be possible to manufacture, specifically when the design team prepared the design documents with few or no manufacturing instructions (Venkatachalam, 1992).

The sequential approach could affect and increase the cost of the final product as a result of increases in cost during the design and manufacturing of the product. In general, redoing and developing the design to be compatible with the manufacturing production processes and limitations is considered the major reason behind the cost issue.

In his paper *Design for Manufacture*, O’Driscoll (2002) identifies the manufacturing costs based upon three factors:

- 1) *Labour (direct and indirect): 2-15% of total.*
- 2) *Materials and manufacturing processes: 50-80% of total.*
- 3) *Overheads: 15-45% of total.*

According to O’Driscoll, the overall cost of the design process is normally around 10% of the total financial plan; however, the design may directly affect the cost of manufacturing. The isolation between the design and manufacturing teams could increase the overall manufacturing costs of the product by as much as 80%, as stated earlier. Therefore, the sequential approach could be a major factor, if not the only one, causing an increase in the final product costs. Figure 2.28 presents the sequential design approach.

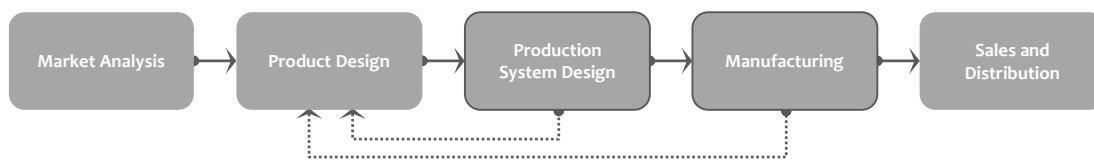

Figure 2.28: Sequential design approach in manufacturing industry. Adapted from Corbett (1991)

Increases in global competition have required many of the manufacturing organizations to adopt and search for new methods to design, develop, and manufacture their products. The objective behind this shift is to reduce the overall cost and increase quality and productivity. This can be achieved through a strong link between the design and manufacturing processes at the earliest stages of the design process. In the new global economy, Design for Manufacture (DFM) has become an essential new design process for solving the sequential approach cost problems. Many manufacturing organizations have implemented the DFM approach to increase their market share.

DFM can be defined as simultaneous or concurrent involvement among the design team, the design analyst team and the manufacturing specialists working together in parallel with product development. It aims to increase productivity and the efficiency of earlier collaborations between diverse design teams from different disciplines, through the design and manufacturing processes. Many benefits can result by implementing DFM, including enhancement and improvement of the design review process; faster and more efficient product development; reduction of the total number of parts to be manufactured, increased quality, and minimized manufacturing costs.

As can be seen from table 2.8 below, O’Driscoll (2002) lists nine main activities that need to be performed simultaneously under the DFM approach. These will provide the design teams with

instant feedback during the conceptual design stage, allowing for faster modification and progress, as well as higher productivity.

Table 2.8: The main activities that need to be performed simultaneously under the DFM approach (O'Driscoll, 2002)

-
- *User needs and requirements.*
 - *Market forecasts, projected sales volumes, unit price and demand.*
 - *Product development process (including concept, definition, development of prototype and testing phases).*
 - *Component design, subassembly design, and assembly analysis.*
 - *Quality requirements.*
 - *Process selection, materials selection and suitability.*
 - *Economic analysis and cost evaluation.*
 - *Design feasibility investigations and redesign.*
 - *Production and commercialization.*
-

Many organizations such as Hitachi, General Electric, IBM and Xerox have implemented the DFM methodology based upon their needs. O'Driscoll points out some of the advantages that might be achieved through DFM:

- *Reducing product assembly time by up to 61%.*
- *Reducing the number of assembly operations by as much as 53%.*
- *Reduction of 68% in the number of assembly defects.*
- *Cutting the time to market by as much as 50%.*

One example reflecting the success of the DFM implementation is Nortel Company (O'Driscoll, 2002), which used DFM to improve the design for one of their products. Accordingly, the cost of the product was reduced from \$410 to \$65 (U.S. dollars). The design team was able to reduce the product time to assembly from 15 to 5 minutes, as a result of reducing the total number of parts from 59 to 32. The total duration to develop and produce the product was 10 months, including the redesign process, defining the functional requirements, and selecting materials and manufacturing processes. An estimated \$3.45 million in cost savings was expected for Nortel, which shows how utilizing the DFM approach could optimize the design phase of a product to ensure manufacturing compatibilities. Figure 2.29 presents a typical DFM flowchart.

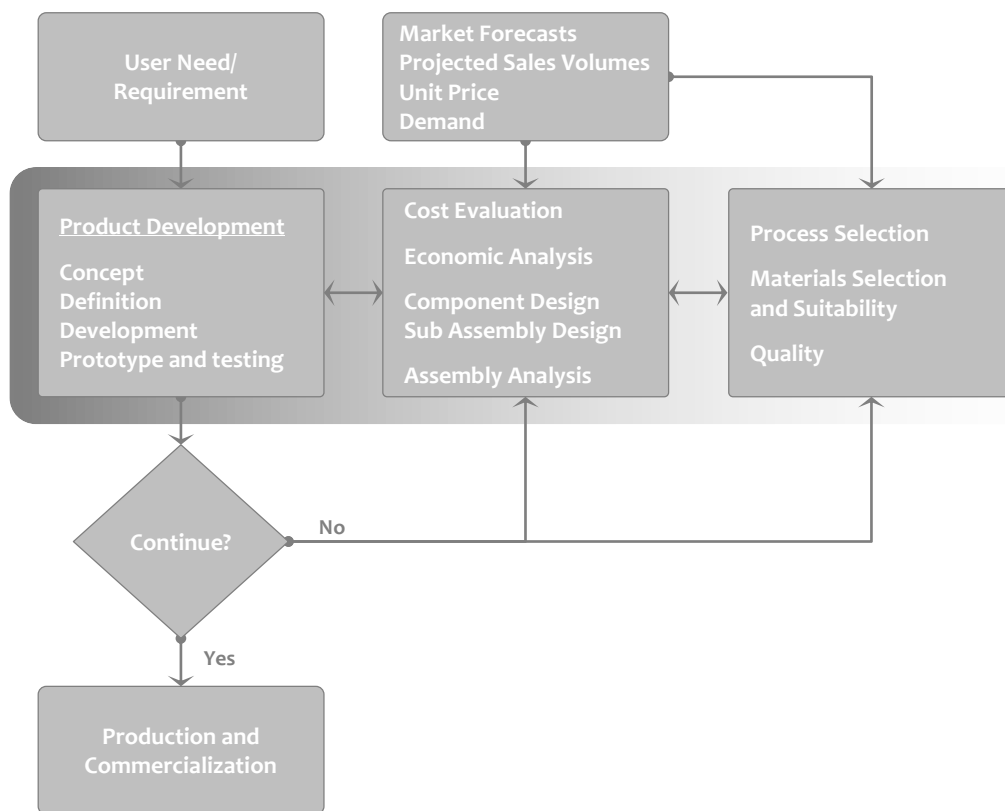

Figure 2.29: Typical DFM flowchart. Adopted from O’Driscoll (2002).

To implement DFM methodology into an organization, O’Driscoll (2002) suggests performing two arrangements: 1) restructuring of the organization’s product design process (PDP), and 2) establishment and functioning of the DFM team. O’Driscoll mentions that three months would be enough time for an organization with well-structured PDP to shift to DFM.

To form a team, it is important first to define the scale of the project. For small projects, the team can include four members. In large projects, the team may include 20 or more members. The team members should include every specialty in the organization (Corbett, 1991). Based upon their experience, the team should focus on integrating the DFM method through eliminating weaknesses within the previous design process. This may assist in making a smooth transition from the traditional (sequential) approach to the DFM (concurrent) approach.

2.3.5 Design for Assembly

Design for Assembly (DFA) is an important aspect in the manufacturing industry, and plays a key role as part of DFM. With DFA, the design teams need to integrate the assembly not only as a process, but also as a way of thinking while designing the product. In his text, *Design for Assembly-The Key to Design for Manufacture (1987)*, Geoffrey Boothroyd pointed out the two main steps for effective DFA technique: 1) to minimize the number of the separate parts, and 2) to improve the integration 'assemblability' among the remaining parts. A fewer number of parts means reducing the costs of manufacturing and assembly. Boothroyd (1987) suggested asking three simple questions that may enhance the part count reduction and assembly, which are:

- *During the operation of the product, does this part move bodily with respect to all other parts already assembled?*
- *For fundamental reasons, does the part have to be of a different material from all the other parts already assembled?*
- *Does the part have to be separate from all other parts already assembled because otherwise assembly or disassembly of other separate parts could not be carried out?*

According to Boothroyd, these three simple questions can assist in understanding the characteristics of each part, and then support the design team when making decisions regarding part count reduction in an assembly process. Consequently, this leads to improved and simplified product design, less time to assemble, and significant cost savings for assembly. One must understand the given product based upon the design criteria to use the correct method for selecting materials and manufacturing processes for specific design problems using DFM and DFA approaches.

IBM Corp. was one of the examples that show applying DFA analysis for a new printer design assisted with achieving successful results, including a 40 percent reduction in the number of parts, 42 percent reduction in final assembly parts, and 14 percent reduction in manufacturing costs (Venkatachalam, 1992).

Henry W. Stoll, in his text *Design for manufacture: an overview*, discussed the importance of DFM and DFA principles and how applying such principles can allow the product- development teams (the design team, the design analyst team and the manufacturing specialists) to achieve faster modification and progress (Corbett, 1991). These principles are:

Minimize total number of parts

Fewer parts could save time and cost for all phases from design, to development, through manufacturing, and ending with the assembly of a product. However, it is important to take

into account that in some cases, minimizing parts might increase cost due to the difficulty of manufacturing and assembly.

Develop a modular design

A modular component is typically produced or manufactured from one or more parts and can be connected to another component to form a functioning item. Modular design can enhance the speed of the final assembly process, since each module is tried and tested in advance. Although a cost reduction might be achieved with modular design, cost can be increased if the modular design needs special requirements such as extra fittings.

Use standard components

A design team should know when and how to utilize stock items for many benefits: less expensive than a custom-made item; prior knowledge of features, specifications, and certain physical properties some of which are density, stiffness, thermal and electrical conductivity, and optical transparency; available in large quantities by more than one distributor and can be ordered at different times of the year.

Design parts to be multi-functional

To achieve successful results for manufacturing, it is recommended to combine more than one function together, if possible. Besides reducing the total number of parts, one advantage to this approach is that there is no need for the combined parts to be assembled. Also, it is less expensive to manufacture than the sum of each individual part. For example, the design team can develop modular units to perform as structural elements or as part of the structural support systems of a product, as well.

Design parts for multi-use

In a manufacturing organization, parts can be designed in a way that allows taking advantage of them in more than one product or function. For this, it is necessary to divide the parts into two groups: 1) parts which are limited for a specific design or product, and 2) parts that can be used in most of the products. Next, dividing each group into different part families will assist in identifying the multi-use parts. Therefore, the designer should be able to use these families of standard parts to develop existing or new product designs.

Design parts for ease of fabrication

There are different fabrication processes such as shaping and reshaping based upon cutting, subtractive, additive, and formative fabrication. Designers need to understand and



be more directly involved with the machine capabilities of each of these fabrication techniques. This, in turn, would guide the designers to design specifically for the limitations of those machines. Designers should take into consideration minimizing materials waste by selecting the right combination between the materials and fabrication processes. Also, having the right combination selected may assist in avoiding any secondary manufacturing processes.

Avoid separate fasteners

Reducing assembly costs mean a reduction in total manufacturing cost. In general, the use of fasteners has a direct impact on increasing manufacturing and assembly costs for both automated and manual assembly. Designers need to eliminate the use of fasteners (screws, nuts, and washers) as much as possible and replace them with tabs or snap-fit options. Whenever there is a need to use fasteners, it is necessary for designers to focus on minimizing the number, size, and variation and utilize standard fasteners whenever possible.

Minimize assembly directions

To expedite the assembly process, all parts should be assembled from one direction. Otherwise, many difficulties may arise when there is more than one direction such as extra time, more transfer stations, inspection stations, and fixture nests. To increase efficiency in an assembly line, parts should be designed and arranged to be added in a vertical direction (top-down fashion).

Maximize compliance

To avoid errors and damages in both the product and production process, designers should include compliance in the parts design and assembly process, so that they are easy to align and to insert. For example, a part can be easily aligned when tapers or chamfers features are considered for smooth insertion.

Minimize handling

In designing parts, positioning and maintaining position should be taken into consideration to minimize handling. In addition, another method to minimize handling is designing symmetrical parts, which in turn assist in orientation. If asymmetry is essential, then the method would be to emphasize an existing asymmetry or designing the asymmetry in.

As can be seen from the previous discussions about DFM and DFA methods, many companies within the modular building as an emerging construction industry can benefit from adopting the DFM and DFA principles.

Figure 2.30 shows the assembly diagram for the Cellophane House, designed by Kieran Timberlake Associates.

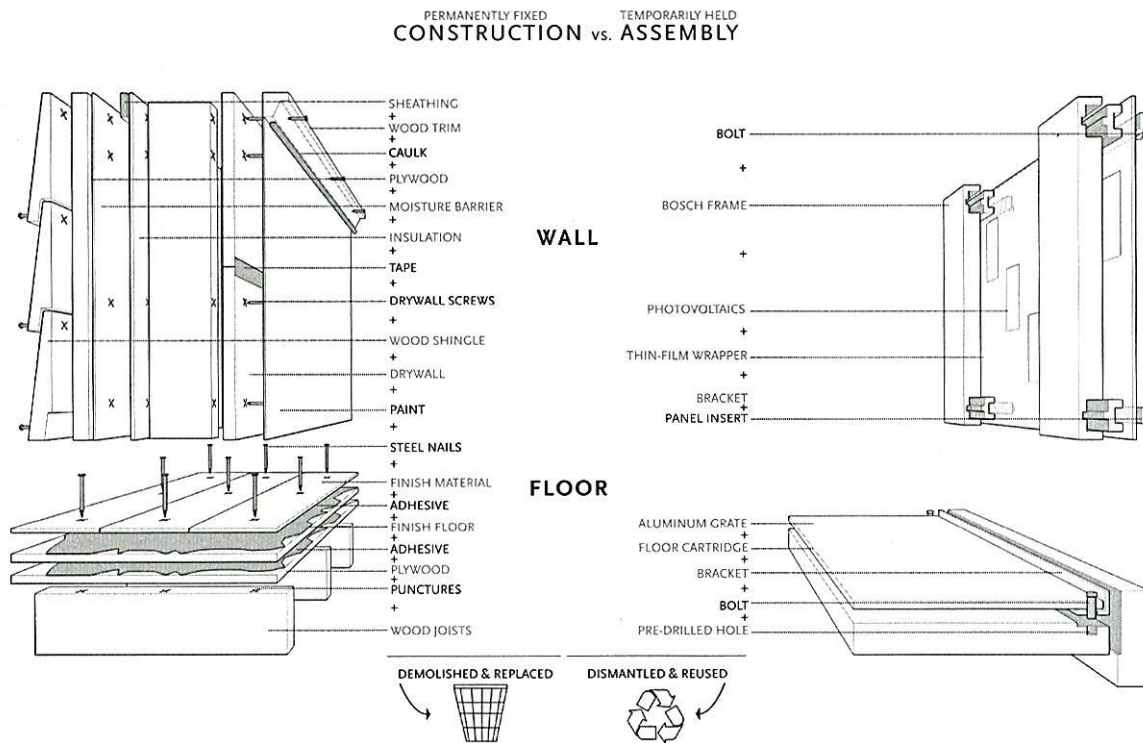

Figure 2.30: Comparative structural sectional perspectives (Bergdoll et al., 2008).

2.3.6 Types of Off-Site Fabrication

Gibb (1999) divided off-site fabrication into the three different types, which are described below: non-volumetric off-site fabrication, volumetric off-site fabrication, and modular building.

2.3.6.1 Non-Volumetric Off-Site Fabrication

Gibb (1999) was apparently the first to use the term non-volumetric off-site fabrication. According to his definition, non-volumetric off-site fabrication is “*items that do not enclose usable space, to distinguish it from volumetric off-site fabrication (p.8).*” In other words, non-volumetric is any space that cannot be occupied or inhabited by the project’s users.

As mentioned before, these terms are important for different project teams, especially during their assessment process, as they categorize the elements that will be manufactured or fabricated as part of the non-volumetric category. Non-volumetric off-site fabrication may perform different functions that derive from any of the different elements listed earlier (Table 2.4). These functions include, but are not limited to, elemental systems such as structural frame, kit of parts, cladding system, and integrated building services based on mechanical, electrical, and plumbing (MEP) systems racks.

In general, the main advantages of using non-volumetric off-site fabrication are the following:

- Reduce the project program
- Reduce costs on site setup items
- Customizable
- Less on-site material waste
- Elimination of site storage cabins
- Could free up greater areas for raised floor installation
- Reducing site based labor and better quality end-product
- Transport logistics and costs can be less than volumetric and modular building approaches.

Some of the disadvantages of using non-volumetric off-site fabrication are:

- Complex installation
- New risk introduced on-site because of the heavy load

Figure 2.31 shows prefabricated utility racks including HVAC ducts and control boxes, gas, plumbing and sprinkler lines, and electrical conduit and cable trays.

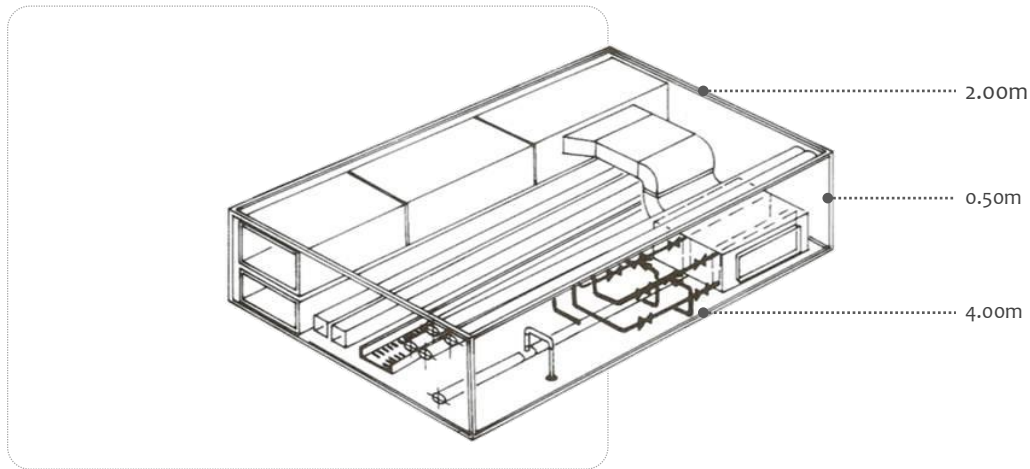

Figure 2.31: Prefabricated utility rack (Gibb, 1999).

2.3.6.2 Volumetric Off-Site Fabrication

The term volumetric off-site fabrication is used by Gibb (1999) to refer to “units that enclose usable space, but do not of themselves constitute the whole building (p.8).” A volumetric unit is typically built off-site with all the required construction materials, details and finishes as the conventionally site-built method, however, part of the work remains to be completed during the installation time on-site.

According to Gibb (1999) and as illustrated earlier in Table 2.3, volumetric off-site fabrication is specifically used for facilities. Examples of these units include, but are not limited to, plant equipment rooms and toilet, bathroom, washroom, and kitchen pods. Units produced by using the volumetric off-site fabrication method typically are not considered part of the structural support of the building. Thus, they are placed inside the structural frame already erected on-site (Figure 2.32).

Some of the advantages of volumetric off-site fabrication are:

- On-site erection periods are dramatically reduced
- Reduction in waste materials
- Less noise, dust and local disruption
- Lower number of on-site workers
- Cost reduction for on-site setup items
- Higher quality construction
- Easy plug and play installation

Some of the disadvantages of volumetric off-site fabrication are:

- Can leak when not installed correctly
- Work still needed to connect and fix the pod unit in place
- Careful handling of prefabricated components is required to avoid damages.

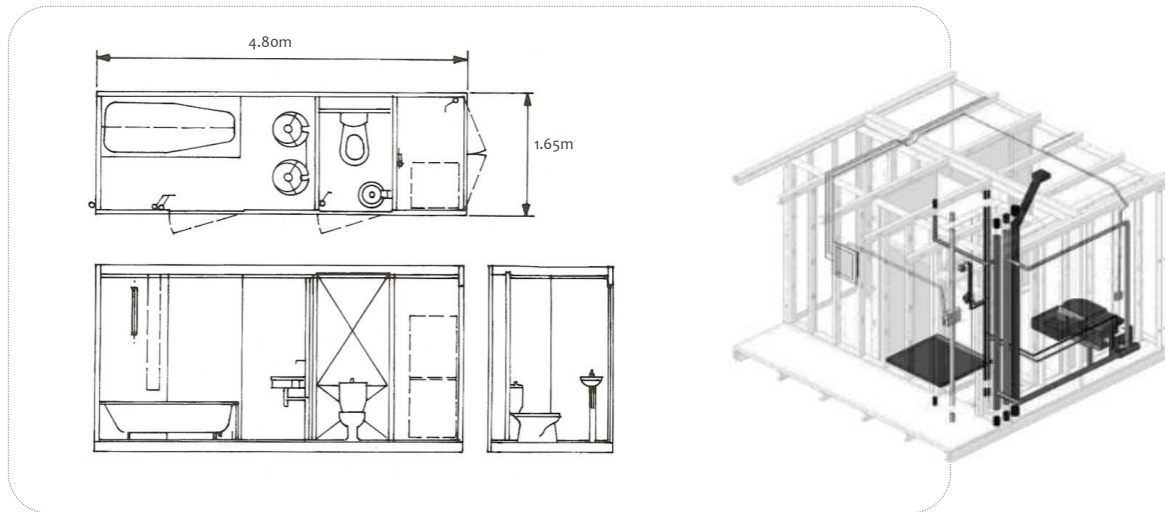

Figure 2.32: Prefabricated bathroom pod unit (Gibb, 1999) (Smith, 2010).

2.3.6.3 Modular Building

A modular building is typically produced or built from one or more sectional units out of a box-shaped form. Each unit is completely finished at the factory, containing the floor, walls, ceiling, interior/exterior finishes and mechanical, electrical, and plumbing systems (Figure 2.33). Although most of the different system elements are manufactured and fabricated in a factory, part of the work remains to be completed after connecting the units to each other on-site. Modular units are mainly considered structural elements or part of the structural support systems of the building. Examples of modular buildings include hotels, hospitals, medium-rise offices, residences, student accommodations, schools, fast food outlets and stand-alone retail units.

In general, the main advantages of using a modular building are the following:

- Reduce the project program/Less time on-site
- Cost reduction for on-site setup items
- Product is tried and tested in factory/ Higher quality
- Reductions in material waste
- Reduction in accidents and ill health
- More controlled conditions for weather (non-weather dependent)
- Fewer people on-site

Some of the disadvantages of utilizing modular building are:

- The availability of specialized components and materials for future maintenance
- The design needs to be finalized in much more detail in advance
- Lifting, loading and transportation costs

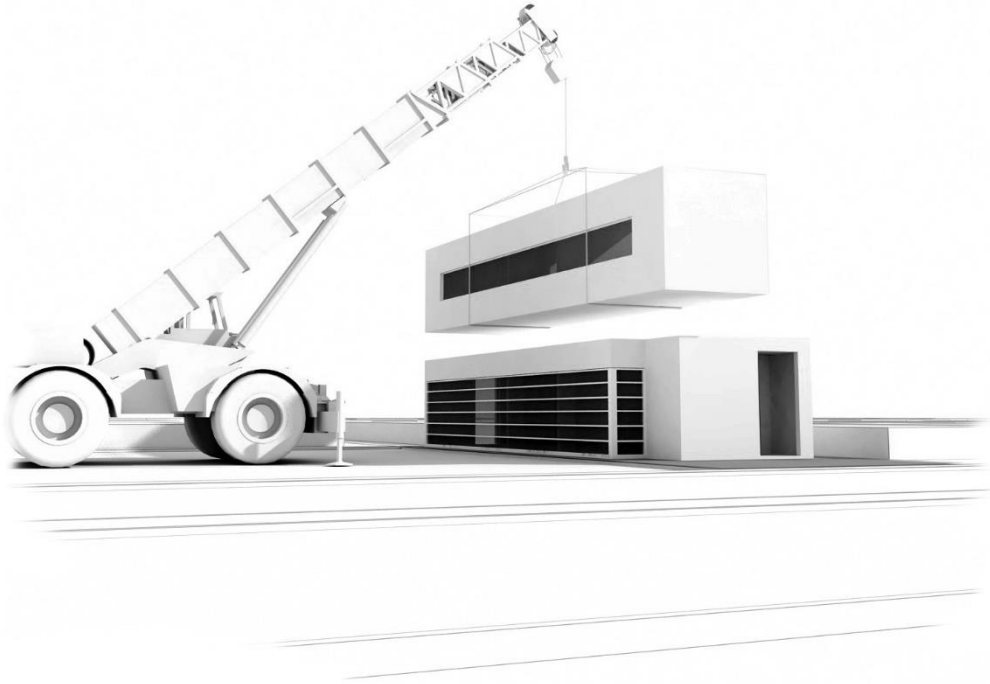

Figure 2.33: Prefabricated modular unit.

2.3.7 Sources and Causes of Construction Waste

An important advantage of the prefabrication method is that prefabrication controls waste and materials damage during construction, which is why most industries utilize the prefabrication process. In addition, prefabrication maintains better quality control, as well as reduces the costs associated with skilled labor, power, lost time due to inclement weather, and space hindrances.

Several studies have linked different categories of sources that contribute to materials waste during construction. In 2004, Ekanayake and Ofori published a paper called “Building Waste Assessment Score: Design-Based Tool”, in which they identified materials waste based upon four categories: 1) design related, 2) operational related, 3) material handling related and, 4) procurement related. Table 2.9 illustrates the main attributes under each of the four categories.

Ekanayake and Ofori (2004) pointed out that practicing waste minimization is far more cost effective and they suggested a number of strategies, which can be classified into two main groups; planning and controlling. Planning strategies may be classified into four main categories: design, construction scheduling, site layout, and procurement. Controlling strategies also have several divisions: storage, delivery and handling of materials, maintenance of machinery, waste accounting and recordkeeping, safety, security, and training and education.

Table 2.9: Sources of material waste (Ekanayake & Ofori, 2004)

Categories
<i>Design related</i>
<ul style="list-style-type: none"> • <i>Lack of attention paid to dimensional coordination of products</i> • <i>Design changes while construction is in progress</i> • <i>Designers' inexperience in method and sequence of construction</i> • <i>Lack of knowledge about standard sizes available in market</i> • <i>Designers' unfamiliarity with alternative products</i> • <i>Complexity of detailing in drawings</i> • <i>Lack of information in drawings</i> • <i>Errors in contract documents</i> • <i>Incomplete contract documents at commencement of project</i> • <i>Selection of low-quality products</i>
<i>Operational related</i>
<ul style="list-style-type: none"> • <i>Errors by trades persons or laborers</i> • <i>Accidents due to negligence</i> • <i>Damage to work done due to subsequent trades</i> • <i>Use of incorrect material, thus requiring replacement</i> • <i>Required quantity unclear due to improper planning</i> • <i>Delays in providing information to contractors regarding types and sizes of products to be used</i> • <i>Malfunctioning of equipment</i> • <i>Inclement weather</i>
<i>Material handling related</i>
<ul style="list-style-type: none"> • <i>Damages while transporting</i> • <i>Inappropriate site storage</i> • <i>Materials supplied loose</i> • <i>Use of materials which are close to work place</i> • <i>Unfriendly attitudes of project team and workers</i> • <i>Theft</i>
<i>Procurement related</i>
<ul style="list-style-type: none"> • <i>Ordering errors (too much or too little)</i> • <i>Lack of possibility to order small quantities</i> • <i>Purchases not complying with specifications</i>

According Ekanayake and Ofori (2004), design is considered one of the major factors in materials waste due to lack of knowledge about the different materials and the standard manufactured sizes available on the market. Furthermore, inadequate design information and specification may lead to requesting materials that are not compatible with the project function while the prefabrication and construction are in process. Therefore, there is a need to educate and train inexperienced architects about the different methods and sequences of off-site fabrication and onsite assembly, installation, and construction. Figure 2.34 presents the correlation among different processes of off-site fabrication.

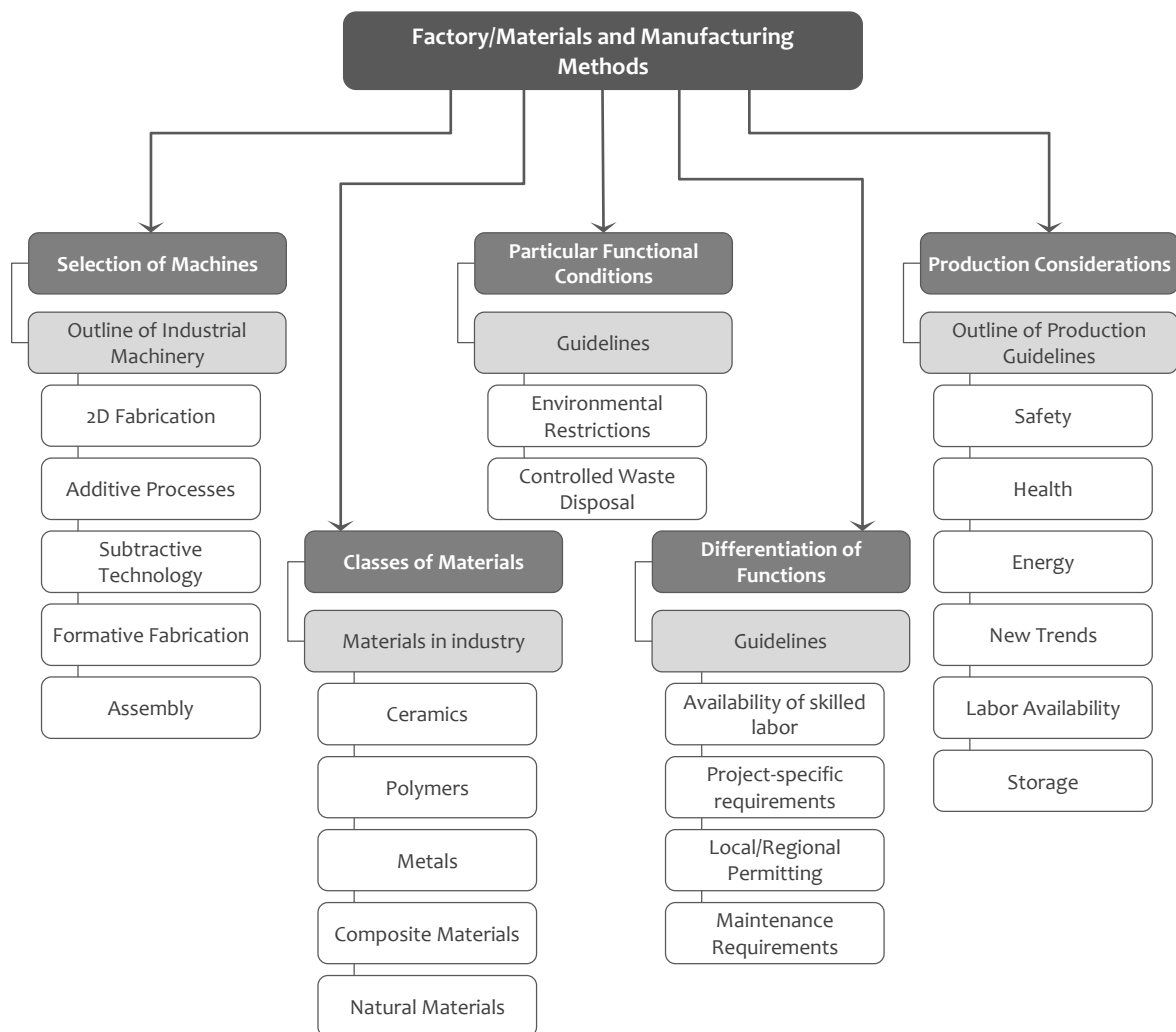

Figure 2.34: The correlation among different processes of off-site fabrication.

2.3.8 Materials Selection

Today, energy efficiency is a major factor when making decisions about the use of specific materials for projects. Typically, the building is a combination of different materials that are selected based on appearance and performance issues. Additional research of alternative materials is of paramount importance in order to achieve successful integration, not just for proper building detailing, but also to meet the performance intended during the design process. Costly design changes can be avoided if appropriate materials research is conducted during the conceptual design phase. An example of the use of new materials in the enclosure of buildings was Frank Gehry's use of titanium in the Guggenheim Museum in Bilbao. Gehry used titanium panels that were one third of an inch thick (8.4 mm) to clad irregular exterior geometries (Waters, 2003).

2.3.9 Material Properties

Advances in materials have also been a source of inspiration for designers. These new materials are not only chosen based on appearance, but most importantly to meet the building's intended performance, be sustainable, and contribute to energy efficiency. Different families of materials are used in various building elements such as metal, ceramics, natural, polymers, composites and recently Intelligent and smart materials. These all consist of certain physical properties some of which are density, stiffness, thermal and electrical conductivity, and optical transparency. These physical properties are valuable inputs used in evaluating the performance of the proposed design (Ashby et al., 2009). It is impossible to anticipate what new materials the future may hold. But, we know that these materials will often be affected by the geometry imposed on them and will require special practices for their manufacture and assembly.

2.3.10 The CES Material and Process Selection Software

The possibility of using new materials in buildings can be explored through new tools such as the CES material and process selection software by Granta. One must understand the given project based on the design criteria to use the correct method for selecting a material for specific design problems using CES software (Ashby, 2005). There are three steps to achieve the goal of the final material selection. For this we must ask:

- How is it assembled and who will use the product?
- What are the response characteristics of the material?
- What are the parameters to which the design must respond?

Once we start to determine and translate the design requirements resulting from the information gathered from the first step, this will lead to the determination of the materials functions, constraints, objectives and free variables (e.g. Table 2.10). We will then develop and address the design problems directly through the CES software. There is a strong relationship

between the last two steps. The design will be worked and developed until we reach the desired level for the proposed product. Once reached, the search for materials for the final product begins (e.g. Figure 2.35), based on the design constraints and objectives. Additionally, we can filter the initial result to reduce the number of materials that could possibly be used. By establishing limits early in the process all unusable materials can be eliminated (e.g. Figure 2.36). After identifying the top three materials, we can then rank them based on the design objectives.

Table 2.10: Translate the design requirements into material's functions, constraints, objectives and free variables.

<i>a. Function</i>	<ul style="list-style-type: none"> • I-beam
<i>b. Constraints</i>	<ul style="list-style-type: none"> • Must not fail under load F • Must spans long distances L • Section's Shape
<i>c. Objective</i>	<ul style="list-style-type: none"> • Maximize length span • Minimize cost
<i>d. Free Variables</i>	<ul style="list-style-type: none"> • Cross-section A • Choice of material

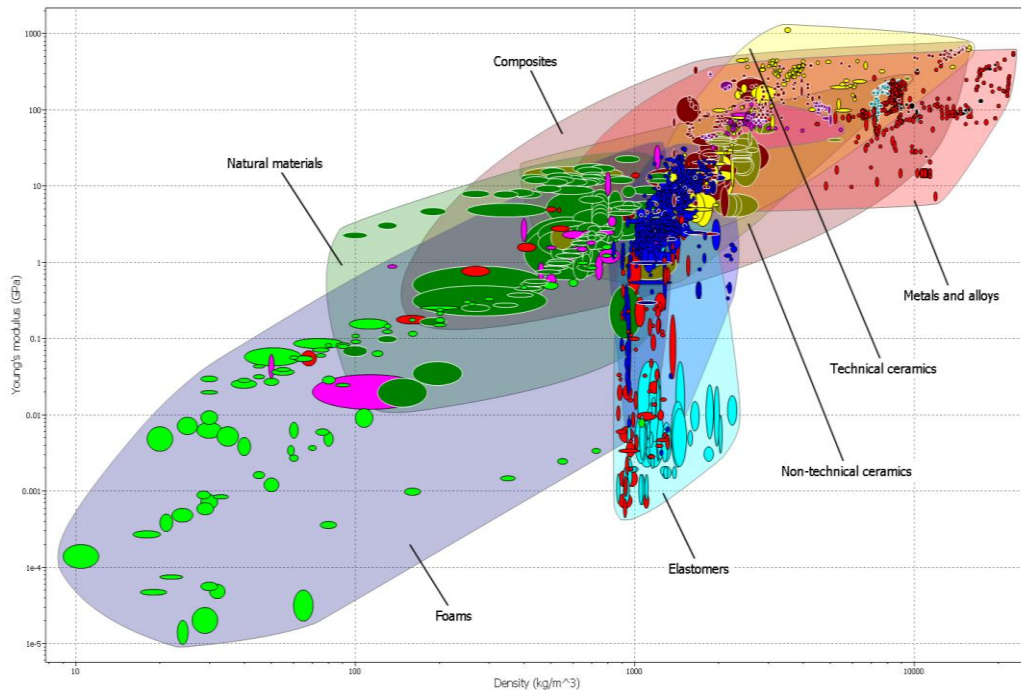

Figure 2.35: Chart of Materials Properties (Using CES)

Finally, for the ranked materials, alternative fabrication processes must be evaluated and compared (e.g. Figure 2.35). Linking these steps together guides and helps us to accomplish our goal for the intended design. Further discussion will be addressed at the end of this chapter concerning how implementing such CES software could help the design team during the earlier stages for the material selection.

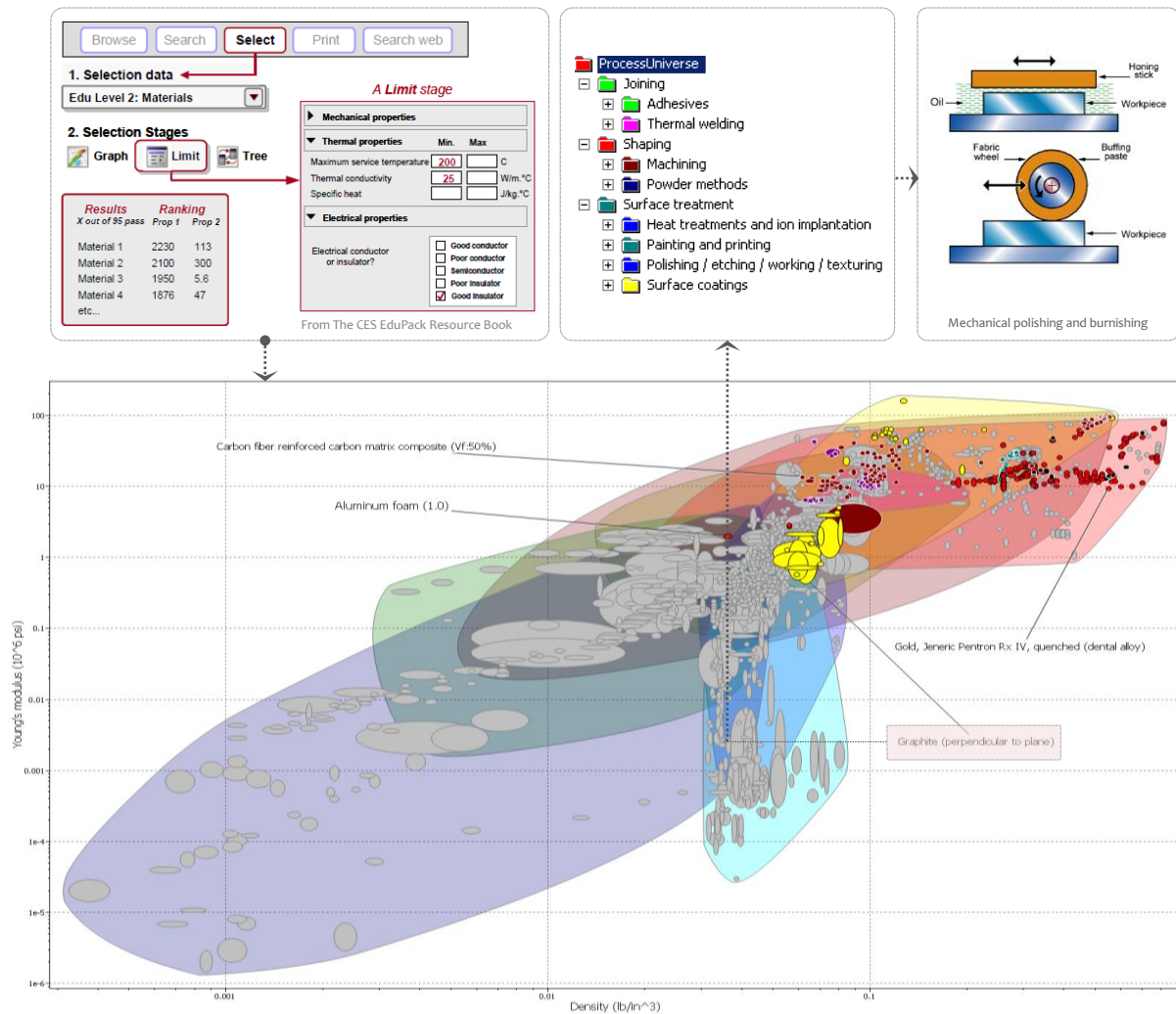

Figure 2.36: Chart of Materials Properties (Using CES)

2.4 Transportation

Transportation processes and limitations represent one of the most important factors for manufactured or prefabricated housing. Architects and engineers should work with the manufacturer and transportation specialists to understand the limitations and the regulations of different states or regions. This will assist the design team during the development phase of the project by taking into consideration the sizes of elements within different building systems, such as structural systems, enclosure systems, services systems, and finish systems. Also, understanding transportation processes and limitations will assist the design team to break down each system into different sets of volumetric and non-volumetric elements, so they can be easily shipped as discussed earlier. Determining the sequence of assembly is another important aspect for panels, components and modules and protecting these from damage during transportation is of paramount importance (Smith, 2010).

Furthermore, it is important to understand the sequencing and staging for loading or stacking off-site manufactured elements. This process should be planned based on jobsite scheduling. As a result of this understanding, the unloading process will be more efficient, since the installation and the assembly processes will occur directly after the time of unloading the elements. A major benefit from implementing such an approach is time and cost savings and protection for the finished building products from damage. Figure 2.37 shows the main packaging and transportation factors that a design team should take into consideration during the design development phase.

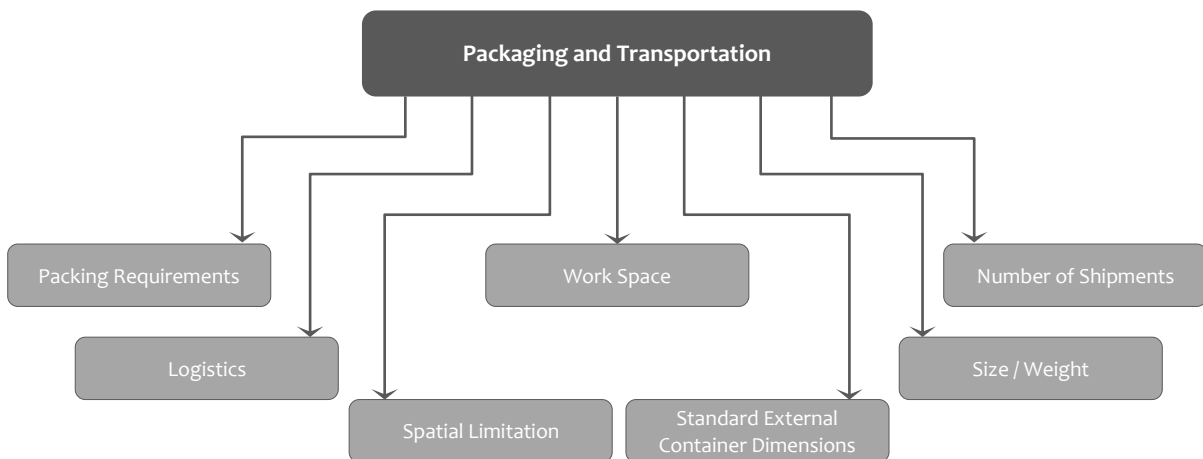

Figure 2.37: Packaging and transportation factors

In his book *Prefab Architecture: A Guide to Modular Design and Construction*, Ryan E. Smith (2010) thoroughly discusses the transportation methods, size limitations, and regulations. According to Smith (2010), off-site manufacturing and fabrication rely on two principal methods to transport the finished building elements for installation on site: container shipping and dimensional or cargo shipping.

Container shipping is designed and approved by the International Organization for Standards (IOS). The IOS is an international organization that works on the development and the unification of standards for different industries to avoid any restrictions or global challenges. As Smith points out, the features of these containers are standard, such as size, pick up points (method of lifting and locating), attachment between adjacent units, and shipping chasses and decks. Table 2.11 presents the details of size and weight constraints.

For dimensional or cargo shipping, the dimensions are not limited, nor are they limited by ISO standards. However, size and the weight restrictions would be imposed by the shipment method, such as truck, rail, ship, air or helicopter. These methods of shipment are useful for oversized building elements or modular components that cannot fit within the IOS containers. It should be noted that bridge height is also one of the major constraints for rail and truck transportation, as weight is the major constraint for air or helicopter transport.

IOS containers are considered affordable and more convenient to use than dimensional or cargo shipping for two reasons: 1) lower cost, and 2) there is no need for permits and special clearances from any transportation organization. By way of illustration, Smith (2010) showed an example about the difference in cost between the two transportation methods. Based upon the calculations of Anderson Anderson Architecture, a design and construction firm, the cost of dimensional shipping that they have experienced while they were shipping building elements to Japan is more than ten times that of shipping via IOS containers. This example illustrates the importance of including the transportation method and cost in the early stages of design development. In some cases, especially in international projects, an inexperienced design team may underestimate the cost of transportation (Smith, 2010).

2.4.1 Truck

This research will not discuss the commercial trucking regulations in depth, since there are different safety requirements for every region or country. For example, in the United States there are two main regulatory agency groups, 1) at the national level, Federal Size Regulations for Commercial Motor Vehicles, U.S. Department of Transportation, and Federal Highway Administration (FHWA), and 2) at the state level (Smith, 2010). This is where the transportation specialist plays a major role during design development by informing the different teams about the transportation options, regulations, restrictions, and limitations for the different regions. In

turn, knowing this information will assist the design team in accommodating transport logistics and help control the cost of the overall project.

Table 2.11: Detailed Container Dimensions for Standard: 8ft, 10ft, 20ft, 30ft and 40ft Containers

Standard External Container Dimensions: *Metric (unit)*

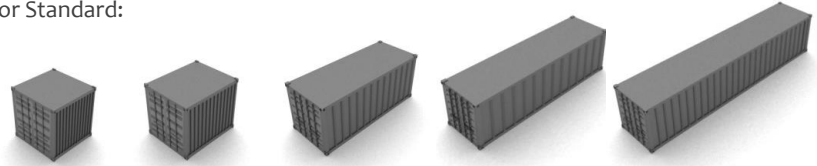

	(8ft)	(10ft)	(20ft)	(30ft)	(40ft)
Container Length	2.42m	3.05m	6.06m	9.12m	12.19m
Container Width	2.17m	2.44m	2.44m	2.44m	2.44m
Container Height:					
-Standard	2.26m	2.59m	2.59m	2.59m	2.59m
-High cube	-	2.89m	2.89m	2.89m	2.89m

Standard Internal Container Dimensions: *Metric (unit)*

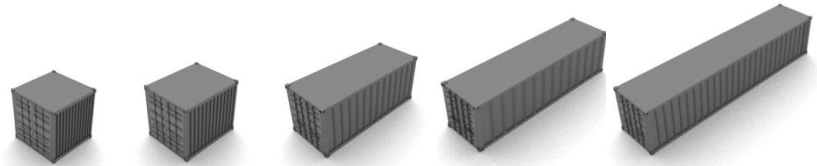

Internal Length	2.28m	2.80m	5.87m	8.93m	12.00m
Internal Width	2.10m	2.33m	2.33m	2.33m	2.33m
Internal Height:					
-Standard	2.04m	2.35m	2.35m	2.35m	2.35m
-High cube	-	2.65m	2.65m	2.65m	2.65m
End Door Aperture Width	2.09m	as req.	2.28m	2.28m	2.28m
End Door Aperture Height:					
-Standard	1.94m	as req.	2.26m	2.26m	2.26m
-High cube	-	as req.	2.56m	2.56m	2.56m
Floor area	4.78m ²	6.69m ²	13.93m ²	21.09m ²	28.33m ²
Cubic capacity					
-Standard	9.28m ³	15.89m ³	32.85m ³	49.84m ³	66.83m ³
-High cube	-	17.84m ³	37.09m ³	56.21m ³	75.32m ³
Weight	1.02 tons	1.52 tons	2.44 tons	3.25 tons	4.06 tons

Source: S. Jones Container Services Limited

2.4.2 Trailers

When transporting by trailer there is a relationship between the size of prefabricated elements and the trailer type. According to Smith (2010), there are two different types of trailers, a box trailer and flatbed trailer.

The box trailer is similar to the IOS containers in that prefabricated elements are shipped inside of the container. This transportation method protects the shipment from severe weather that may cause damage. There is one access to the trailer, typically from the back, and a forklift is needed for loading and unloading the elements. To avoid problems associated with size limits, it is important to know the internal length, width, and height of the box trailer. Below are the standard dimensions (Smith, 2010):

- Width: 8 ft or 8 ft-6in.
- Length: 28, 32, 34, 36, 40, 45, 48, and 53 ft
- Height: 8 ft-4 in. above deck
- Weight: 44,000 lbs maximum load.

For flatbed trailers, there are three main types: 1) standard flatbed, 2) single-drop deck, and 3) double-drop deck (Figure 2.38). A flatbed trailer is considered to be more flexible than the box trailer for transport of prefabricated elements for many reasons. For example, it can handle greater height, weight, and is more accommodating to load and unload products from any part of the trailer. In general, the major difference among the three types of flatbed trailers is the maximum height of the shipment.

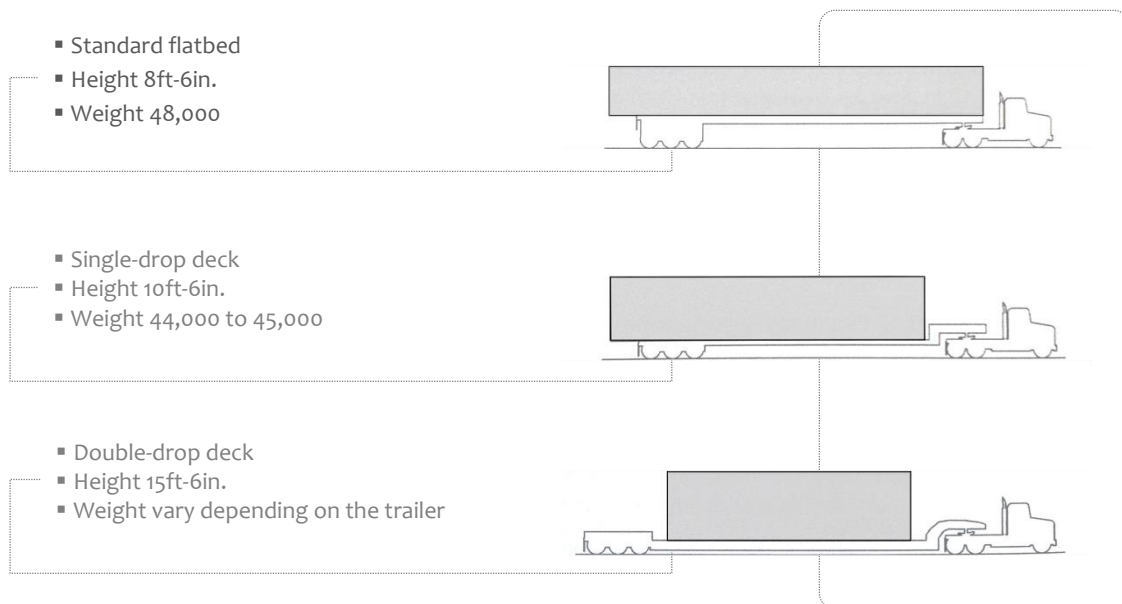

Figure 2.38: The three types of flatbed trailers. Adapted from Smith (2010)

2.4.3 Modular Transport

Smith (2010) points out that there are more restrictions when it comes to modular, mobile, and manufactured units. When the external total width of a manufactured units falls between 14 ft-6in. and 16ft, it will be “transported on their own running gear, may be issued a single trip permit but must comply with tire sidewall guidelines, axle/suspension must not exceed manufacturer’s capacity, and all trailers must have operational breaks. Mobile homes in excess of 16ft wall-to-wall width may be permitted on a case-by-case basis. Mobile/manufactured homes can be moved on all types of trailers.” (Smith, 2010).

Design teams must take into account the number of lifting processes for the prefabricated elements to proceed from the factory to the trailer, as well as placement and connection onsite. Additionally, the designers should consider the transportation time from the factory to the project site, and the need to avoid any challenges that may arise from job site conditions. This will assist the design teams to determine the proper loads for shipping, the pick points for loading and offloading, and the critical live loads.

2.4.4 Rail Transportation

As discussed earlier, this research will not address the rail transportation regulations in depth, since there are different safety and standards requirements for different regions or countries. According to Smith (2010), it is very rare to use the rail transport option to ship offsite-fabricated elements. However, in some cases where the advantages exceed the disadvantages, the rail transport option may be best. Below is a list of the advantages and disadvantages of rail transportation as pointed out by Smith (2010):

Table 2.12: Advantages and disadvantages of rail transportation (Smith, 2010)

Advantages	Disadvantages
<ul style="list-style-type: none">• Fuel efficiency• Heavier loads are possible (3 trucks to 1 railcar conversion)• Loading and unloading flexibility• Mitigates driver and equipment shortages in truck industry• Larger elements possible requiring less disassembly• No requirement for road permitting, escorts, night-time, and weather restrictions• Capacities often allow multiple pieces per railcar reducing per-piece transport costs	<ul style="list-style-type: none">• Generally more costly in comparison to trucking• Charge based on minimums; 50,000 lbs or less is same cost generally• Light-weight construction material such as wood panel and modules are difficult to recoup cost and justify rail• For heavy elements, load and unload locations must be identified• If not near the rail, where load can be craned from rail-to-rail location, then difficult to truck. If it can be trucked, then most likely the easiest option• Economies come in density, so flat-pack makes the most sense in rail

2.5 Assembly

One of the most significant current issues within the modular manufacturing and pre-fabrication industries is the importance of assembly, not only as a process, but also as a way of thinking while designing. This view is supported by Smith (2010) who shows the transformation before and after the industrial revolution. Advanced manufacturing tools have changed the demand from a skilled individual who was accountable for the entire project, including the procurement of materials and crafting, to the accessibility of diverse building products. Before the Industrial Revolution, there were new products and manufacturing methods, although production speeds were inefficient due to the absence of advanced manufacturing tools, such as drilling, milling, lathing, and deforming.

Smith argues that manufacturing methods have remained essentially unchanged since the beginning of industrialized manufacturing, but the tools and materials of production have evolved greatly. Smith (2010) lists two reasons that have contributed to this evolution. These are: 1) interchangeability and 2) an increase in production rate. The first is based upon the capability to exchange or interchange parts, and then assemble these parts into the finished product. The second is based upon breaking the construction of a product into two parts, manufacturing or fabrication and assembly. Fabrication occurs not onsite, but in a contained environment and, as a secondary process, assembly may be performed onsite or in the factory. Prefabrication, the technique of manufacturing and fabricating sections of a building at the factory, has increased the production rate on the building site by accelerating the assembly or erection time.

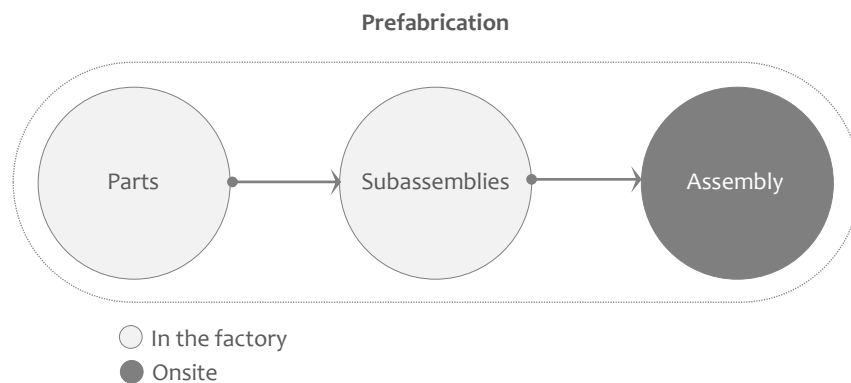

Figure 2.39: The three sequential levels of prefabrication in construction.

Smith (2010) suggests using the terms parts, subassemblies, and assembly to describe three sequential levels of manufacturing in construction that link the manufacturing and fabrication processes from materials to the final product (Figure 2.39). Most products start from selecting and then joining different parts in the factory. These parts typically are based upon manufactured materials, panels, components or modules. The manufacturing industry uses the term Made-To-Stock (MTS) to define this level.

Subassembly is the next level where different parts are combined to form a building element. The term Made-To-Order (MTO) is often used to refer to this level. The difference between MTS and MTO is that the first considers a finished product that is continually produced and held in a warehouse inventory to fulfill predictable incoming orders. By contrast, MTO products are used for a specific project and not held in quantities in warehouse inventory.

The last level of manufacturing in construction is assembly. In this level, the subassembly elements are installed, connected, and positioned onsite. For this level, it is very important to map the assembly sequence and prepare a detailed plan for how subassembly elements are assembled. This, in turn, may assist in avoiding any unexpected delays or damage to the elements before construction (Smith, 2010). More in-depth discussion will be addressed in chapter four concerning assembly strategies and principles in prefabrication.

Figure 2.40 shows the main assembly/installation factors that a design team should take into consideration during the design development phase.

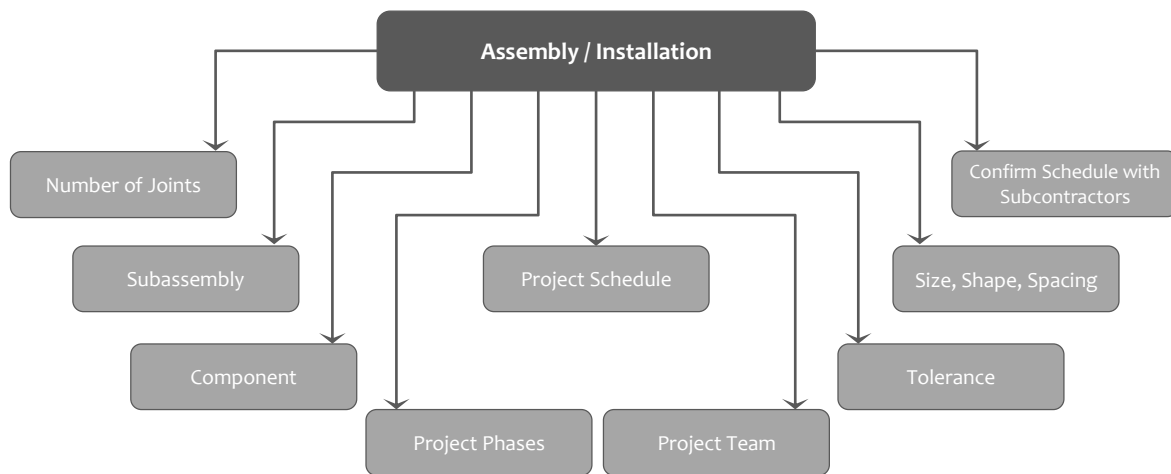

Figure 2.40: Assembly / Installation factors for prefabrication in construction.

2.6 Summary

The chapter begins by pointing out some of the major limitations of existing methods within housing projects, continues by illustrating information technologies for design and manufacturing, and concludes with most recent trend of the modular building industry. Most of the issues relating to housing in the United States stem from the lack of an architect’s involvement. To achieve high-quality modular housing, there is a need to reconnect architects with the design of housing projects. Prefabrication and modern technologies in manufacturing can greatly help in reducing time and cost, and increase the quality and efficiency of the single-family homes, however, architects need to understand and be more directly involved with the

machine capabilities and fabrication techniques. Architects also need to be aware of the transportation and assembly processes and constraints, since they represent one of the most important factors for prefabricated housing. The aim is to shift from a sequential approach in the architectural field to a concurrent approach.

The review shows the benefits and efficiency of earlier collaboration between different design teams from different disciplines, through the design, manufacturing and construction processes. This enhanced collaboration can help move housing projects to the next level of integration by connecting architects, engineers and contractors. BIM has advanced the information sharing process by enhancing the collaboration among different fields and clients. However, the relationships among digital design processes, materials, and digital manufacturing practices, remain unclear, and there is a need to bring knowledge of materials selection, manufacturing and fabrication processes to the early stage of design.

2.7 Suggested Strategies

As previously discussed, for projects with complex design it is important that designers be familiar with the techniques of the fabrication. In order to avoid conflicts between architect, consultant and fabricator, it would be desirable to share knowledge early in the design process. This link could be achieved in the conceptual design phase by providing the design team sufficient knowledge related to fabrication and construction to support their initial decisions. Through the application of a knowledge-sharing decision-support tool, unexpected results that a design team could face during later stages of the project could be avoided.

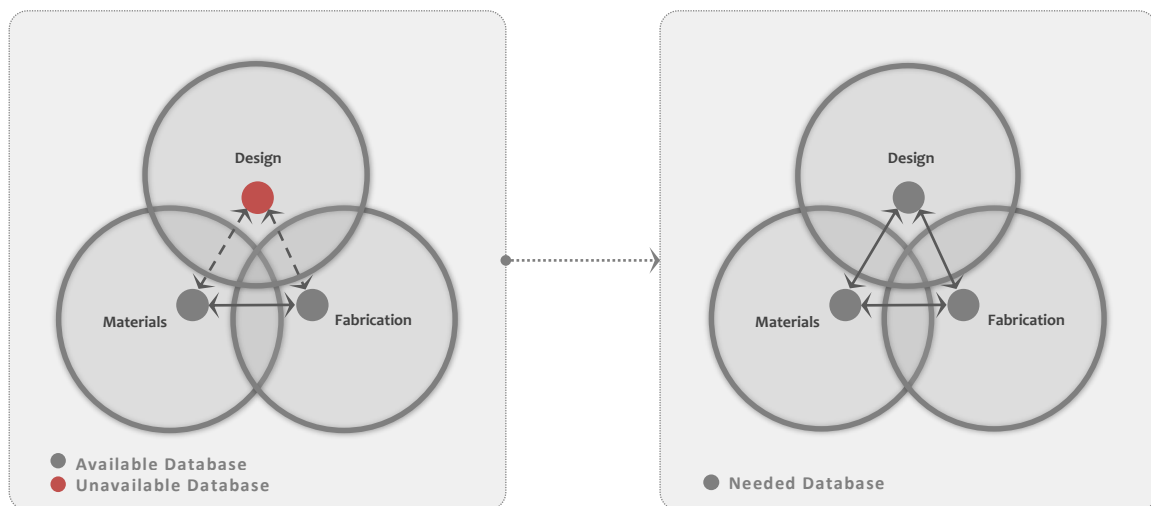

Figure 2.41: The left diagram shows the available and unavailable databases. The right diagram shows the needed database.

Implementing the CES database for material and process selection, along with knowledge of fabrication and manufacturing techniques within a BIM environment, can potentially improve CAD/CAM processes while better supporting design decision-making. Such a tool could provide the design teams with immediate information concerning the complexity of the building skin with regard to fabrication techniques, materials selection, and estimated costs and production times. Figure 2.41 shows two diagrams, on the left we see the unavailable database that needs to be created that is based on the design, and the available database based on the materials selection and the fabrication processes. The diagram on the right needs a database system that will connect the following three components; design, materials selection and fabrication techniques.

Based on the above suggestions, the researcher propose an Integrated Architectural Fabrication System (IAFS). The IAFS focuses on interactively exchanging information between the three different knowledge domains shown in Figure 2.42 as a decision-support system.

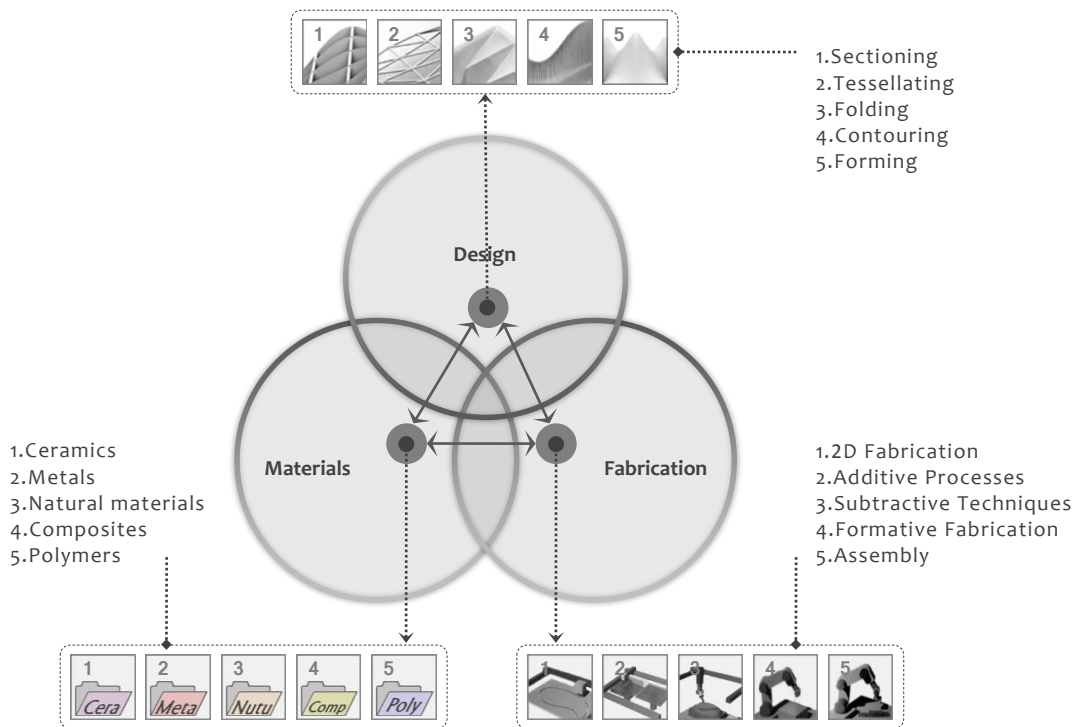

Figure 2.42: The existing tools and techniques for geometry, materials and fabrication within IAFS.

When fully developed, the IAFS could be implemented as a plug-in to BIM technology. The IAFS could serve as a database within the BIM server (online database), which will help team members explore options while directly considering issues related to fabrication. The core of the IAFS is based on defining and combining existing tools and techniques within each of the

three major domains; design, materials selection, and fabrication (Figure 2.43). Within design we see the five major techniques for complex geometry rationalization; sectioning, tessellating, folding, contouring, and forming. Then for material selection (a decision) we see the five major material families; ceramics, metals, natural, composites, and polymers. For fabrication there are five major techniques; 2D fabrication, additive processes, subtractive techniques, formative fabrication, and assembly.

The IAFS can be a one-step process that is initiated by selecting one of the geometry techniques for the proposed design. As a result of this selection, the IAFS will provide the designer with all the material options, and the fabrication techniques that could be applicable for the selected geometry. The same process could be reversed starting with the designer’s interest in a specific material, then providing the designer with all the geometry options and fabrication techniques that could be applicable. Likewise starting with a fabrication technique the IAFS will give the designer all the options for the other domains. The IAFS process and system will be discussed further and demonstrated in three different case studies (scenarios) for a complex surface geometry in chapter 5.

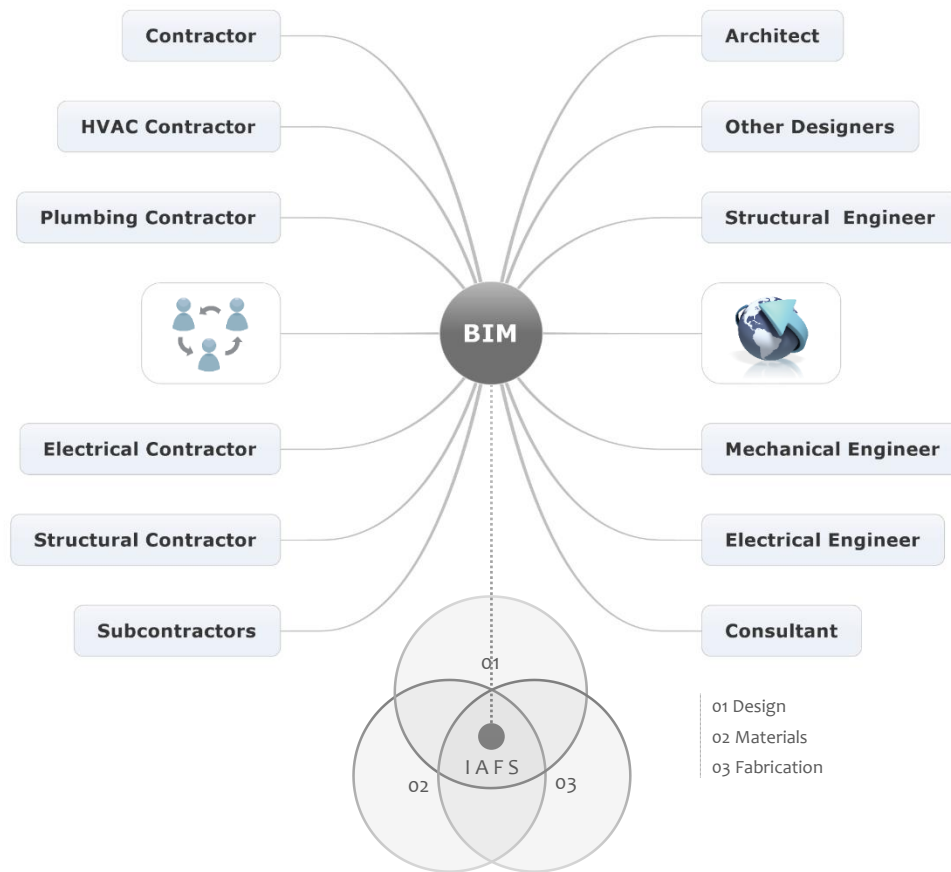

Figure 2.43: Implementing IAFS within BIM.

3. Methodology

3.1 Introduction

One of the most significant current discussions in the construction industry is how modular building methods can be pushed further as an advantageous alternative to site-built construction. This research will aim to develop a framework that maps the design and manufacturing processes as they relate to manufactured single-family housing. The anticipated result could assist in developing a “design language” to support variety in the modular housing industry. Recent developments in technological advances, such as digital design and digital manufacturing processes, have heightened the need for research that may assist architects in understanding how they can begin with a process and a system that progresses from the design stage, moving to fabrication then transportation, and finally ending with the assembly of the project.

In this research, both Computer-Aided Design (CAD) and Computer-Aided Manufacturing (CAM) systems will be evaluated based upon the degree of implementation of advanced computational tools within the modular housing industry. A CAD system typically is based upon two parts, hardware and software that allow architects and engineers to translate their design from ideas to the creation of a technical drawing. With a CAD system, architects and engineers may improve their productivity, the quality of design, and communications through manufacturing documentation. Similarly, a CAM system is based upon hardware and software that allows architects and engineers to translate their technical drawings into instructions for Computer Numerical Control (CNC) as manufacturing machinery.

There are four major stages for modular housing production: design, manufacturing or fabrication, transportation, and assembly. For the purpose of this research, each stage relies upon a combination of hardware and software systems. The software component can be considered as a common factor among all stages, since all the technical drawings and instructions for the four stages can be created with one or different CAD software. Analysis and then modifications might be applied for performance optimization, but the hardware differs from one stage to another. For the design stage, hardware is considered as part of the CAD system that includes, but is not limited to, the monitor, keyboard, mouse or digitizing tablet to create the design drawings, printer or plotter for printing technical drawings and specifications, advanced graphics card, high speed CPUs and large amounts of RAM for better performance. For the manufacturing stage, the hardware segment is based upon two different operation methods: 1) Manual operation, where the technician uses low technology mechanized hand tools such as drilling, milling, lathing, and deforming machines, and 2) Automated operation,

where the designs of the primary elements within each building system are attached to production processes through a common language: digital information. In this operation, the technician needs to convert digital information through CAM software into instructions linked directly to the CNC as manufacturing machinery to produce a 1:1 scale element. For the transportation and assembly stages, the hardware part is based upon the shipment method, such as truck, rail, ship, air or helicopter as well as crane types, such as truck-mounted hydraulic, crawler, and tower cranes. It should be pointed out that the importance of understanding the relationship between the primary stages within each system (hardware and software) may assist in simplifying and developing new prefabrication methods for the modular building industry (Figure 3.1). Additionally, understanding the relationship between the primary stages may assist in evaluating the projected performances of different teams and the relationship between the different teamwork patterns within each building system based upon the design criteria. Also, the evaluation will include a comparison between the off-site fabrication and site-built method based on permanence, constructability, assessments of reusability and recyclability, sustainability, and cost-benefit analyses.

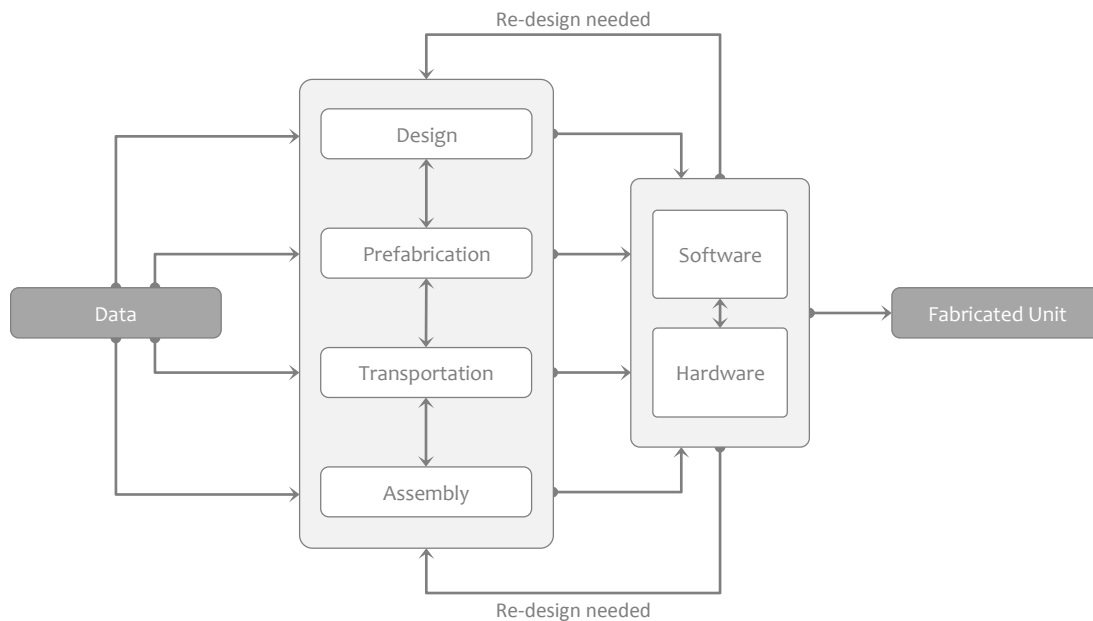

Figure 3.1: The relationship between the four major stages for modular housing production based upon hardware and software systems.

The first aim of this research is to map an as-is design-manufacture process model within the modular housing industry, where the segmentation between different stakeholders and problems such as time, cost, variation and quality will be exposed. Next, this research will propose a to-be framework (model) for the prefab industry and test it through a prototype within the home building industry. Then consensus and feedback of the proposed framework and prototype will be conducted. Qualitative research methods based upon a grounded theory

approach will be used for evaluating, capturing and structuring knowledge. As research tactics, interpretation of literature, case studies, and interviews with knowledge stakeholders combine with a prototype to demonstrate and then validate the viability of the proposed framework being used.

3.2 Immersive Study - Grounded Theory Approach

The grounded theory approach is considered one of the main qualitative research methods. The term grounded theory was first introduced by Barney Glaser and Anselm Strauss in 1967. Data collection techniques and data analysis procedures are core components, playing a key role in the grounded theory approach (Glaser and Strauss, 2006). It is important to understand that following this research process results in the emergence of a theory unlike other qualitative research methods that set a number of hypotheses that can be tested to determine their accuracy. The grounded theory research method develops theory through the analysis of data, giving it a value as compared to traditional research methods where preconceived theories are investigated.

Strauss and Corbin (1998) in their book, *Basics of Qualitative Research: Grounded Theory Procedures and Techniques*, describe grounded theory as:

Theory that is inductively derived from the data, systematically gathered and analyzed through the research process. In this method, data collection, analysis, and eventual theory stand in close relationship to one another. A researcher does not begin a project with a preconceived theory in mind (unless his or her purpose is to elaborate and extend existing theory). Rather, the researcher begins with an area of study and allows the theory to emerge from the data (p.12).

Bryant and Charmaz (2007) define grounded theory by saying, “The Grounded Theory Method (GTM) comprises a systematic, inductive, and comparative approach for conducting inquiry for the purpose of constructing theory” (p.1). According to the definitions provided by Strauss and Corbin, as well as Bryant and Charmaz, grounded theory is based upon an inductive process. However, Strauss, as one of the developers of the grounded theory approach, disavows this misconception. He suggests the equal importance of deduction, verification, and induction in terms of the requirements of building a theory from data (Groat and Wang, 2002).

According to the previous definitions of the grounded theory approach, this research is not intended to test any candidate theories. However, in this research, a number of theories have been introduced as part of the data and information collection task. The main objective was to search for and review the research problem from different perspectives. This may assist in understanding and then developing the research for further investigation.

In general, theories can illustrate and describe how complex systems work without specifying that complexity in detail. Such abstraction may assist in linking existing complex systems in one field to another (Friedman, 2003). To fulfill the objective of observing the research problem from a theoretical point of view, the research effort focused on the anticipated results of merging digital technologies into the design and production processes.

Generally, the grounded theory approach can be categorized into three tasks: data collection, coding, and creating memos. Data collection first cumulatively builds up knowledge on the basis of relevant data and empirical studies to the research topic. According to Glaser and Strauss (2006), there are multiple and different techniques for data collection. Having more than one technique may assist the researcher in understanding and then developing his/her research for further investigation. During the data collection task, the researcher may start the coding process based upon the gathered data and information.

The coding process may be defined as a data analysis process which consists of three phases: 1) open, 2) axial, and 3) selective coding. According to Strauss and Corbin (1990), open coding is the first phase involving “the process of breaking down, examining, comparing, conceptualizing, and categorizing data” (p. 61). Axial coding is defined as “a set of procedures whereby data are put back together in new ways after open coding, by making connections between categories. This is done by utilizing a coding paradigm involving conditions, context, action/interactional strategies and consequences.” (p. 96). Selective coding is “the process of selecting the core category, systematically relating it to other categories, validating those relationships, and filling in categories that need further refinement and development” (p. 116). Following these coding processes coincides with recording observations and creating memos may help in theory building.

In his book *Qualitative Analysis for Social Scientists*, Strauss (1987) mentions the special situation of a grounded theory approach versus other qualitative research approaches. In this case, the process of data collection, coding and creating memos continues back and forth until the researcher reaches the stage of development where theory can emerge as an end result of this research process (Figure 3.2).

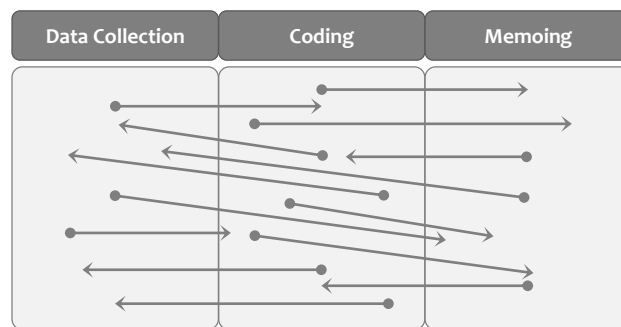

Figure 3.2: Grounded theory research tasks, adopted from Strauss (1987)

The grounded theory approach has a number of structured features that would usefully supplement and extend the qualitative analysis in this research.

3.3 Literature Review

In the history of research development, literature review has been considered a key factor in seeking prior and recent relevant information and data in a particular field. Information gathering is typically managed through a critical survey of various sources (Groat and Wang, 2002). Literature review sources include, but are not limited to, textbooks, conference papers, journals, lectures, newspapers, reports, seminars, theses, and meetings. These sources can usually be accessed via two methods, electronic media and hardcopy (Hart, 1998). Nunan (1992) defined literature review as a process that “extracts and synthesizes the main points, issues, findings and research methods which emerge from a critical review of the readings” (p. 217). In his book, *Doing A Literature Review: Releasing the Social Science Research Imagination*, Hart (1998) defined literature review as:

The selection of available documents (both published and unpublished) on the topic, which contain information, ideas, data and evidence written from a particular standpoint to fulfill certain aims or express certain views on the nature of the topic and how it is to be investigated, and the effective evaluation of these documents in relation to the research being proposed (p. 13).

According to the previous definitions, literature review is a research tactic that is considered an important source of knowledge and is a good reference for gathering information. Literature review is also an effective tool to support and clarify the magnitude of the current problem, and then help the researcher during the analysis phase to find a new system that could be proposed to resolve and develop the system in place.

There are four main domains that relate to the literature for modular housing industry in this research: design, manufacturing, transportation and assembly. Each of these has its own characteristics, constraints, and limitations. In order to understand the current relationship among these domains, taking a position in both the different fields (stakeholders) and the owner of the final product is of utmost importance. Although literature review may help with the development of a formative evaluation of previous work on the problem, there is a need for it to be combined with other research tactics to observe the problems and ways of solving them from different angles or perceptions. For this, further information and data collection are required through case studies and interviews with knowledge stakeholders to determine the current issues and problems within the modular housing industry.

In this research, the literature review as described in Chapter 1 will be applied as a two-tiered approach. First, general background information as discussed in Chapter 2 was collected and explored as an introduction to identify the state of knowledge that is related to the topic areas of digital design, manufacturing, transportation and assembly. This also assisted in identifying issues and problems, and in formulating research questions. Second, an interpretive literature review will be presented in Chapter 4, by starting the coding process. The gathered data and information will be analyzed and synthesized by following the coding phases as described earlier, which will assist in categorizing and extracting related information directly to the knowledge capturing process.

The role of interpretive research is not only to collect data through a variety of tactics, but also to fully understand and organize these data and then present them as useful information through the interpretation process. Groat and Wang (2002) define interpretive research as: “investigations into social-physical phenomena within complex contexts, with a view toward explaining those phenomena in narrative form and in a holistic fashion” (p.136).

3.4 The Case Study as a Research Tactic

In general, research aims to find effective solutions that can be adopted for the next phase of an existing problem or situation. Successful research goes beyond data collection techniques to the process of studying and analyzing the collected data. This research will focus on the use of a grounded theory approach; hence, case studies as a research method are used to collect in-depth information about a limited number of specific cases and projects. In his book *Case Study Research: Design and Methods*, Yin (2009) provides a twofold technical definition of case studies. First, he mentions the importance to begin with the scope of a case study:

1. *A case study is an empirical inquiry that*
 - *Investigates a contemporary phenomenon in depth and within its real-life context, especially when*
 - *the boundaries between phenomenon and context are not clearly evident*(p. 18).

According to Yin (2009), case studies are considered one of the more practical ways to understand how decisions were made within different organizations. For this research, it is important to reach an in-depth understanding when evaluating the interrelationships among different stakeholders in the modular housing industry, specifically in the context where they occur. Yin (2009) claims that phenomenon and context sometimes cannot be distinguished in

real-life situations, and therefore tactics such as data collection and data analysis are essential. This brings us to the second part of Yin's technical definition of case studies:

2. *The case study inquiry*

- *Copes with the technically distinctive situation in which there will be many more variables of interest than data points, and as one result*
- *Relies on multiple sources of evidence, with data needing to converge in a triangulating fashion, and as another result*
- *Benefits from the prior development of theoretical propositions to guide data collection and analysis (p. 18).*

The anticipated knowledge that could emerge from studying and analyzing case studies may in theory support through the building and development of the framework.

Types of Case Studies:

Case studies can effectively assist with the acquisition of information and subsequently the development of knowledge, which in turn may contribute to gaining valid and reliable research outcomes. There is a common thought that a case study is typically used as a research tactic to generate a hypothesis at the beginning of the research process. However, in 2006, Flyvbjerg published a paper in which he described the misunderstanding about limiting the use of a case study to generate a hypothesis. First, Flyvbjerg pointed out that *“the case study is most useful for generating hypotheses, whereas other methods are more suitable for hypotheses testing and theory building.”* Flyvbjerg (2006) claims that case studies may support the access to useful information on a given problem or phenomenon. Therefore, it is better to use strategic selection of cases rather than a random sample.

According to Flyvbjerg, case studies can vastly contribute to the theory building process. Flyvbjerg supported his view by mentioning Eckstein (1975) who wrote that case studies *“are valuable at all stages of the theory-building process, but most valuable at that stage of theory-building where least value is generally attached to them: the stage at which candidate theories are tested.”* Flyvbjerg concludes that *“the case study is useful for both generating and testing of hypotheses but is not limited to these research activities alone.”* Case studies are differentiated in their focus based upon the discipline or specific area of interest. Common case studies include, but are not limited to, decisions, projects, processes, programs, individuals, originations, institutions, neighborhoods, and events (Laws and McLeod, 2004, Yin, 2009).

Laws and McLeod (2004) list three different kinds of case studies which, according to Yin's (2003) classification are: 1) exploratory, 2) descriptive, and 3) explanatory. Each of these can be applied based upon a single case or upon multiple cases. Data gathered from multiple case

studies typically includes two or more cases, while a single case study is limited to one source of information. Laws and McLeod define exploratory, descriptive, and explanatory case studies as:

- *An exploratory case study aims at defining the questions and hypotheses of a subsequent study or at determining the feasibility of the desired research procedures.*
- *A descriptive case study presents a complete description of a phenomenon within its context.*
- *An explanatory case study presents data that explains how events occurred and reflects a cause and effect relationship.*

In this research, case studies of previous and recently designed single-family modular homes will be reviewed to illustrate the development of the design processes and fabrication performance over time. This could be achieved by applying multiple analytical tools to evaluate the building's modular systems and prototypes that range from building elements to assemblies.

Advanced fabrication processes might be new for the architectural and construction fields, but they have been utilized by the automotive, shipbuilding, and aircraft industries over the last two decades. Case studies from such industries may assist in addressing how technological advances have been utilized and might provide help in transitioning some applicable innovative manufacturing processes to modular housing construction.

Based upon the case studies previously described, the descriptive and the explanatory case study styles identified earlier by Laws and McLeod (2004) seem to be good options. This is especially true since some of the main objectives in this research are to improve understanding of the barriers and constraints between architecture design and modular construction for the residential sector, to redefine the architectural design process by bringing issues of fabrication and modular construction earlier into the design process, as well as developing a new process for sharing information and knowledge related to fabrication and modular construction earlier into the design process. Some case studies are going to be based upon descriptive factors while others are explanatory or a combination of both.

3.5 Interviews as a Research Tactic

In the modular building industry, off-site construction and preassembly techniques differ from one company to another. Additionally, multiple stakeholders involved within this construction method and competitiveness applicable to the housing construction sector make interviews as a research technique a good source of information. Interviews can provide not only relevant knowledge, but in-depth visual observation providing the feel of modular housing production processes. These assist our understanding of the role of each participant (domain) in the single-family modular housing industry.

In reality, due to multiple stakeholders' involvement within the modular housing market, it is very critical to select an individual respondent or a group of people with specialized expertise in each domain. Typical participants in the modular housing industry include, but are not limited to, agents or developers, architects, manufacturers, general contractors, and sub-contractors (transportation, mechanical, electrical, and plumbing). To achieve the greatest possible amount of useful information, structured in-depth open-ended interviews with selected industry practitioners were performed. The term structured has come to refer to Interviews that raise specific problems through previously prepared questions that help guide the dialogue. Laws and McLeod (2004) have provided a definition of structured interviews: "This type of research instrument was excellent when standard information was needed from all respondents, but the data were too complex to gather in a closed-ended manner. Respondents were therefore free to tell their stories in their own words, unfettered by pre-established categories, but their data were codeable."

Although an interview with an expert may provide access to useful information, a broad range of experts' knowledge must be taken into account. More importantly, it is advisable to consider the views of other specialists to cover a specific issue or set of issues (Rouse, 1991). Thus, the researcher will aim to achieve two interviews in each of the four main domains: design, manufacture, transportation, and assembly. The majority of interviews will be conducted face-to-face, with a few via telephone due to interviewee preference.

Based upon the information gathered from the literature review and the case studies, the researcher will develop the interview questions, with the first draft to be reviewed by the committee members. When the final version is approved, a pilot test will be performed. The questions then might be refined or restructured based upon the results obtained from the pilot test. Next, the questions will be reviewed again by a questionnaire specialist in the Center for Survey Research at Virginia Tech. Afterward, the questions will be submitted to the Institutional Review Board (IRB) at Virginia Tech for final approval.

3.5.1 The Pilot Test

A pilot test may provide a researcher with a preliminary perception about the quality of the information and expected results. In turn, the researcher will be able to review and analyze the delivered information, which may assist in evaluating and clarifying the directions and categories of the interview questions before conducting the main interviews. Yin (2009) provides several reasons why the pilot test should be chosen, such as information accessibility, geographical convenience, provision of an unusual amount of documentation and data, and representation of a complicated case. According to Yin (2009), although a pilot case study can help with refining

and restructuring the questions, it is important to distinguish the difference between a pilot test and a pretest. Yin states:

The pilot case is more formative, assisting you to develop relevant lines of questions-possibly even providing some conceptual clarification for the research design as well. In contrast, the pretest is the occasion for a formal “dress rehearsal,” in which the data collection plan is used as the final plan as faithfully as possible (p.92).

Yin (2009) points out that with the pilot test IRB approval might be obtained after performing the test in comparison with the pretest, where IRB approval must be obtained in advance.

In this research, the LUMENHAUS project designed and built at Virginia Tech in 2009 will be used for the pilot test step. Based upon the information received, questions that are not providing useful information will be excluded. Therefore, a re-drafting for final revisions will be made and then final IRB approval will be obtained.

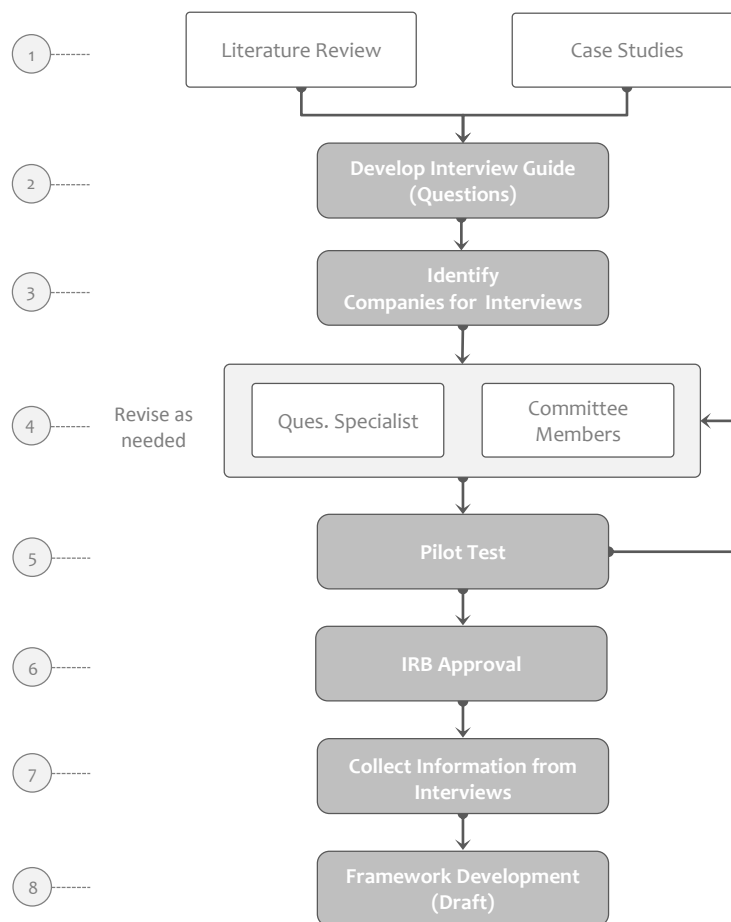

Figure 3.3: Interview questions development steps

Complete interview guides will be developed in Chapter 4 as part of the interview questions development steps as shown in Figure 3.3.

3.5.2 Avoiding Bias

Minimizing bias is considered to be an important factor that assists with result validation. Therefore, structured in-depth, open-ended interview questions will be developed. An important advantage from following such an interview method is to allow the informants to explain, discuss, and suggest a range of possibilities that are considered new to the researcher. Additionally, the informants may suggest other experts to be interviewed (Yin, 2009).

It is also a good idea to send the structure of the questions to the interviewees before the actual interview meeting. This may assist in minimizing bias by giving the interviewees enough time to think and address better answers and may help in generating rich details. Further, it may also avoid first-time misperceptions of the questions (Rouse, 1991).

There is some evidence that the wording of the questions may also affect how the respondents answer. With a structured in-depth interview, it is important to word the questions carefully. The intention from such an interview with experts is to learn more about a specific topic or process, while avoiding any leading questions. Another reason why wording of the questions is considered to be important is that it may assist knowledgeable interviewees in identifying other relevant sources of evidence (Yin, 2009).

Yin (2009) lists two tasks that a researcher should be able to manage. He states “throughout the interview process, you have two jobs: (a) to follow your own line of inquiry, as reflected by your case study protocol, and (b) to ask your actual (conversational) questions in an unbiased manner that also serves the needs of your line of inquiry.” (p.106). The purpose of having an interview with an expert is most likely to learn new useful findings. Thus, according to Yin, questions must be prepared in a manner which will not create a defensive reaction from the expert’s side. Yin supported his view by mentioning Becker (1998) , who preferred to use the word “how” instead of “why” in the interview questions and during the actual interview meeting.

3.5.3 Questionnaire Structure

The interview questions are constructed based upon six main topics:

- Topic No. 1: Introductory questions; interviewee's background and experience, the nature of the company, his/her role within and on which team.
- Topic No. 2: Design process; the client's involvement, the role of architects in design, time and design activities, example of design problems and issues, general design considerations, design for automation, the role of information technologies (BIM), information flow from design to the fabrication phase, bottlenecks in this flow that could cause delay, strength and weakness of current design process.
- Topic No. 3: Manufacturing process; the client's involvement, modular construction techniques in the residential sector, the current level of using offsite construction techniques in the residential sector, steps involved to get a finished product, the involvement of computer numerical control machines, barriers and constraints between architecture design and modular construction for the residential sector, benefits and challenges of using these techniques, participants involved in the manufacturing team, shop drawings requirements, issues of fabrication and modular construction, cost in percentage for manufacturing in comparison to transportation and installation.
- Topic No. 4: Transportation process; general transportation considerations, benefits and challenges, cost to transport the home from the factory, required permits, processes on-site.
- Topic No. 5: Assembly process; general assembly considerations, assembly techniques in the residential sector, benefits and challenges, required permits, processes on-site.
- Topic No. 6: General comments; suggested changes or strategies to improve the design process, manufacturing techniques, transportation options, and assembly methods.

3.6 Triangulation and Information Validity

Triangulation may be defined as a systematic review and results validation process which consists of applying more than two research methods to a specific research problem. Having different research methods may assist the researcher by observing the problem from a different perspective; however, the results should be sufficiently related at the end of the research. According to a definition provided by Laws and McLeod (2004) :

Triangulation required the use of multiple investigators, multiple sources of data, or multiple methods that confirmed the emerging findings. In research it combined independent yet complementary research methods that: enhanced the description of a process or processes under study; identified a chronology of events; provided evidence for internal validity estimates and served as a corroborating or validating process for study findings. Thus, an expanded understanding and contextual representation of the studies phenomena resulted.

In this research, the collected information will be validated through analyzing the outcome of the interviews via triangulation with literature review, case studies, and experts' feedback. Additionally, the results will be reviewed by the committee members with experience in the field.

3.7 Modeling Methodology – IDEFo

In this research, the Integration Definition (IDEF) for Function Modeling will be used as a graphical presentation technique. In the 1970s, the U.S. Air Force Program for Integrated Computer Aided Manufacturing (ICAM) started the development of IDEF as a new standard graphical modeling method. The goal was to enhance and improve the communication and analysis performances among people working in manufacturing and production sectors. In the 1980s, researchers at the ICAM program introduced a variety of IDEF methods. The IDEFo method is considered one of the most recognized and used graphical modeling techniques of the IDEF family in the government, industrial, and commercial sectors. Douglas T. Ross and SofTech, Inc. developed the IDEFo method 'function model' based upon the graphic modeling language Structured Analysis and Design Technique (SADT). This method is particularly useful in structuring and representing a modeled system through a sequence of functions, activities, and processes (Johnson, 2011).

The IDEFo approach has three types of information, which are: graphic diagrams, text, and glossary. The main advantage of having three sources of information cross-referenced to each

other is to clarify and emphasize each major function of a subject. As can be seen from Figure 3.4, the graphic diagram typically represented by boxes and arrows, where each box reflect an activity surrounded by arrows that can be used to model relationships between different activities. These arrows represent the inputs, controls, outputs, and mechanisms (ICOMs). Input is entering the right side while the output exits the left side of the activity box. Control is entering from the top while the mechanism enters from the bottom of the box.

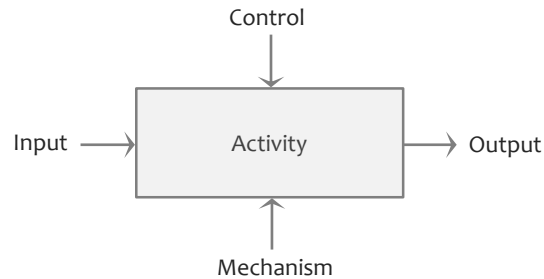

Figure 3.4: Box Format for Integration Definition (IDEFo) Function Modeling.

Figure 3.5 shows that the IDEF0 activities (functions) are normally represented in a hierarchical approach. The top-level diagram in the model represents less detailed activities than those at the lower levels. A detailed description about the graphical language IDEF0 will be presented in Chapter 5.

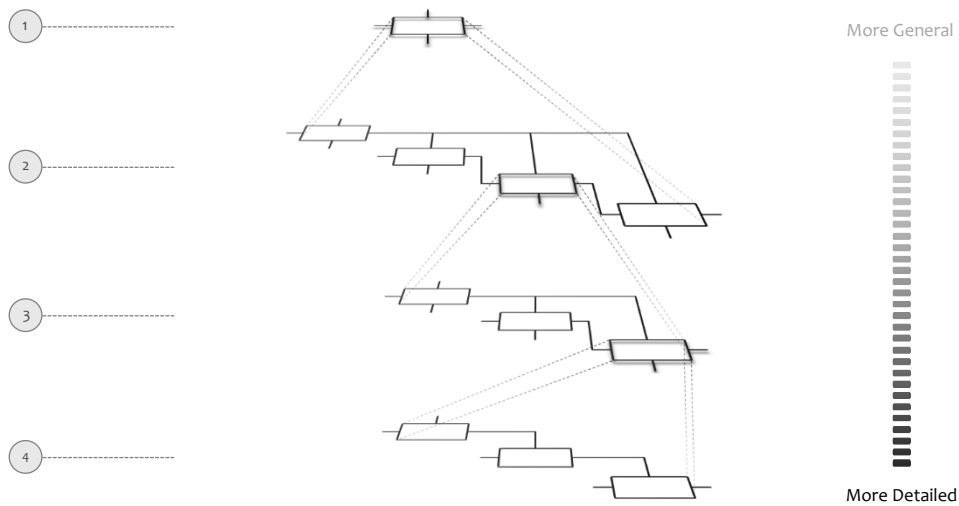

Figure 3.5: IDEF0 hierarchical approach.

3.8 Framework Development

The framework development will be performed through three phases including the following:

1. **Data Collection:** Qualitative research methods based upon a grounded theory approach will be used for collecting, evaluating and structuring knowledge (Figure 3.6). In this evaluation, three research tactics will be used:
 - 1.1. Literature review will be performed as a two-tiered approach. First, general background information will be explored as an introduction to identify the state of knowledge related to the modular housing industry and to identify issues and problems. Second, an interpretative literature review will be commenced, one which will assist in categorizing and extracting related information directly to the knowledge capturing process.
 - 1.2. Case studies are used to collect in-depth information of a limited number of specific cases and projects. For this research, it is important to understand the interrelationships among different stakeholders in the modular housing industry, specifically in the context where they occur. Therefore, case studies of previous and recently designed single-family modular homes will be reviewed to illustrate the development of the design processes and fabrication performance over time. Additionally, case studies from automotive industries may assist in addressing how technological advances have been utilized and might provide help in transitioning some applicable innovative manufacturing processes to modular housing construction.
 - 1.3. Interviews with knowledge stakeholders will be conducted to determine the current state of knowledge and development in the areas of design, manufacturing, transportation, and assembly, as well as the role of information technologies within the modular housing industry.
2. **Theory Building:** This phase starts with the coding process based upon the gathered data and information, and continues by, evaluating, capturing and structuring knowledge. Two drafts of framework structures will be developed based upon the collected data. First, an “As-is” design-manufacture process model within the modular housing industry will be created; and second, a “To-be” framework (model) for the prefab industry will be

developed. The proposed framework will be presented using The Integration Definition Function Modelling (IDEFo) technique as a graphical language. Throughout the data collection and analysis phases, the design language will be developed in parallel with the research progress.

3. Framework Demonstration: A test through a prototype within the home building industry will be used to demonstrate and then a consensus will be reached regarding the proposed framework. The framework will then be completed based upon stakeholders' feedback and comments.

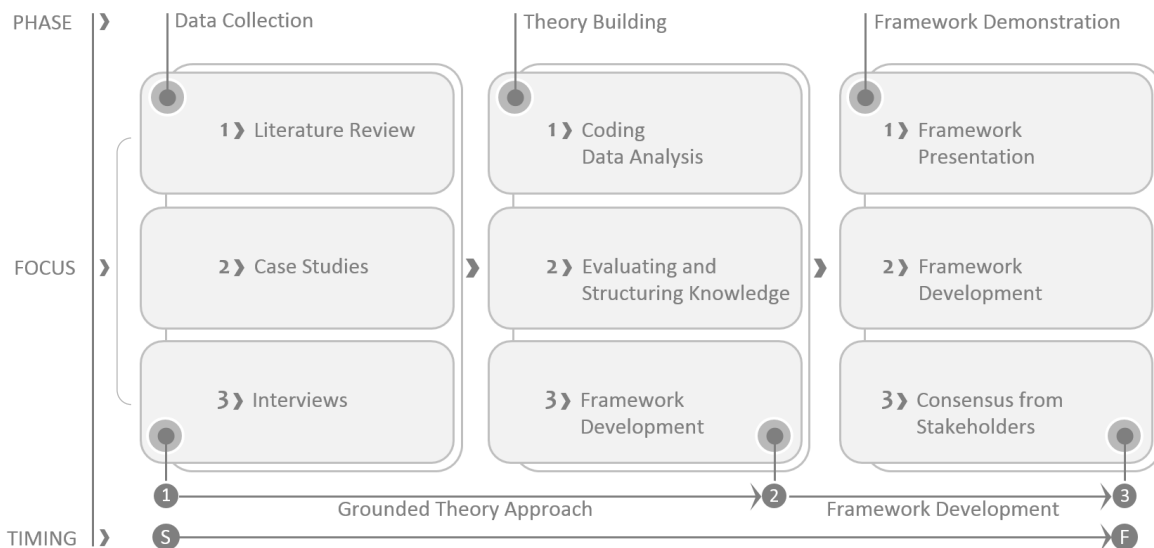

Figure 3.6: Research Timeline

Figure 3.7 maps out the research phases, focus, and timing starting from data collection through theory building and ending with the framework demonstration.

3.9 Summary

The first aim of this research is to map an as-is design-manufacture process model within the modular housing industry. Next, this research will propose a to-be framework (model) for the prefab industry.

This chapter has described the procedures and methods used in this investigation. Qualitative research method based upon a grounded theory approach will be used for collecting, evaluating and structuring knowledge. The grounded theory research method develops theory through the analysis of collected data. In this evaluation, three research tactics are used: 1) literature review, 2) case studies, and 3) interviews. Literature review has been considered a key factor in seeking prior and recent relevant information and data within a particular field. Case studies, as a research method, are used to collect in-depth information about a limited number of specific cases and projects. Interviews, used as a research technique, are considered a good source of information mainly from the multiple stakeholders involved within the modular home industry. A summary of the main findings and of the principal issues and suggestions which have arisen from the interviews are provided in the next chapter.

4. Immersive Study Interpretation

4.1 Introduction

The aim of this research as discussed previously in the research methodology is to map the design and manufacturing processes in an effort to better understand the relationships between these two domains. Through this mapping process, strategies to improve the emergent relationships will be proposed as a new To-Be design and manufacturing model for single-family housing projects. To achieve the greatest possible amount of useful information, case studies of on-site visits to manufactured housing production facilities and structured, in-depth, open-ended interviews of architects, engineers, production managers, business managers, owners, and other knowledge-holders within the manufactured housing industry were performed.

4.1.1 Data Collection Process

This chapter will discuss the extracted information and findings of the case studies and interviews with modular construction industry experts. Four on-site visits were completed for different modular manufacturer locations, each of which were based upon two parts: a tour of the facility to observe the production line and then conducting expert interviews. One of these on-site visits was performed as an immersive case study which required the researcher to join a modular manufacturer company for two weeks as an observer. The researcher observed and took notes of the day-to-day production-line activities and the communication strategies that the manufacturer uses to manage team interactions. The specific purpose was to increase the awareness and strengthen the knowledge capturing process and to compare the results with the other sources of information for reliability and consistency in findings.

The interview questions, as mentioned in the previous chapter, were structured as in-depth and open-ended as possible and were based upon four main topics: 1) design process, 2) manufacturing process, 3) transportation process, and 4) assembly process. The questions were submitted to the Institutional Review Board (IRB) at Virginia Tech and were approved. In order to provide the most recent and relevant data for this research, interviewees were chosen for data collection based upon their expert opinions in the use of modular construction methods. The majority of interviews were conducted face-to-face, with a few via telephone due to interviewee preference. For the purposes of this research, all information and supporting data

compiled from all interviewees will be kept confidential. Participants will not be identified by their names nor the companies they work for, only by their job titles. A coding scheme based upon numbers and letters has been applied to identify each participant's name and their company. All the recorded interviews were transcribed by the investigator. The interviews took place over the course of seven months (from June 2014 to December 2014) with a total of 13 interviewees. Figure 4.1 describes the interviews and case studies timeline including the following information:

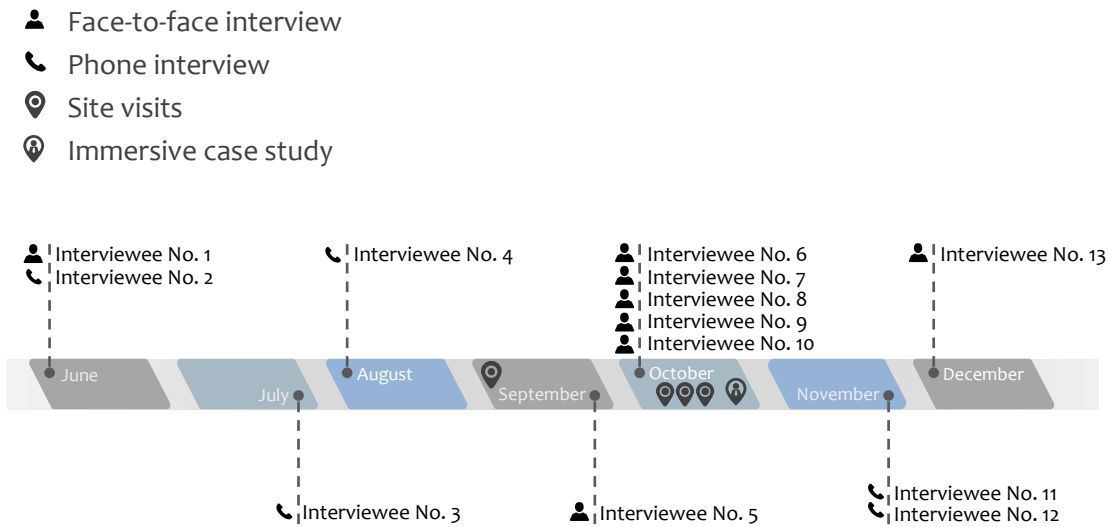

Figure 4.1: Interviews and Case Studies Timeline

4.1.2 Analysis Steps of Interview Data

This part of the thesis discusses the findings that emerged from the analysis of interview data. As was mentioned in the previous chapter, data collection techniques and data analysis procedures are core components, playing key roles in the grounded theory approach. The first stage, the initial phase of data analysis, was transcribing all recorded interviews into a text document. Each interview transcript was read and reviewed twice which assisted in identifying and highlighting main and common points to gain a deeper understanding of the material in each interview.

Once the transcripts were explored, the next stage was grouping and finding relationships among different themes according to 1) design process, 2) manufacturing process, 3) transportation process, and 4) assembly process. During data analysis, the coding process began, based upon the grouped data and information from every interviewee's discussion of each topic.

Figure 4.2 shows a sample of the data analysis process.

Interviewer: What are the primary advantages/disadvantages of the Permanent Modular Construction (PMC) method?

Interviewee 01: The **advantage** is **consistency, efficiency** in kind of two or three ways. Efficiency in the sense that it requires more amount of training in the factory part of that. It's also more efficient because its the same people working together all the time. So the **disadvantages** **shipping size** is a huge limitation, **shipping cost** is huge, I mean they are very limited to... **the typical limitation is a 100 mile radius** even that starts to get a little expensive. **I would not say that the design limitation is one**, I purposely didn't mention that so don't take it as disadvantages.

Interviewer: In general, what are the challenges for PMC?

Interviewee 03: Well, I would say there are several. **The existing language... some terms and existing languages** for design and development of structures and I think your focus is on single family but it applies to everything. It's very oriented to an **old craft-oriented and trade-oriented approach**. And I think the greatest **advantage** of off-site construction, we break down those traditional barriers and we do... we build things into different order with people with multiple talents and in the whole design process tends to be more adhering to the old ways of doing things and not usually aligned.

And so there's a **natural hesitancy on the part of general contractors** to know a bunch of architects and so forth to **embrace off-site construction** because **it's somewhat different**. And **when things are different**, it's an **opportunity for them** to take **additional risk**, the opportunity to **mess up, to lose money, to do things wrong**. So I think **there's a conservatism and reluctance to try to figure out and disputed general knowledge especially among architects and engineers** [03:11], I think, **on how to think through the offsite process**.

Interviewer: Can you give some common examples of design problems and issues for PMC method?

Interviewee 09: I guess **common examples** would be when we have to **get it calculated** we have to refer to an outside source to calculate width spans and so forth so one of the common problems is the **time that it takes** to get those **calculations** back from the third party.

Another problem we see is when we **deal with the other states** like say **New York state** if you are stick framing a house in New York state, you can go to your local with the engineering plans and pull a building permit, but we have to deal with the actual head of state we have to deal with the head of department for the whole state. So that takes a little bit longer because they have more timeframe that they review a lot of frames. So there is a **time delay** on that also.

Also with modular we have a **strict rule to go by**, where on-site built house have some leeway we do not that's some of the difficulties.

Figure 4.2: Identifying and highlighting main and common points in each interview.

As described in chapter 3, the coding process may be defined as a data analysis process consisting of three phases: 1) open, 2) axial, and 3) selective coding. The term “open coding” refers to the first phase of the coding process where all transcribed interviews (raw data) were broken down into clusters of categorized data. “Axial coding” is a process of producing and restructuring knowledge (categorized data) based upon causes, consequences, and connections among the four main interview topics. “Selective coding” can be defined as a systematic process which usually consists of creating labels to identify core categories, the selective coding process assisted in illustrating the main concepts in a narrative and graphical method. Additionally, the extracted and restructured knowledge can support the process of mapping the “As-is” and “To-be” framework.

Figure 4.3 shows the initial phase of data analysis and the coding process of the transcribed interviews.

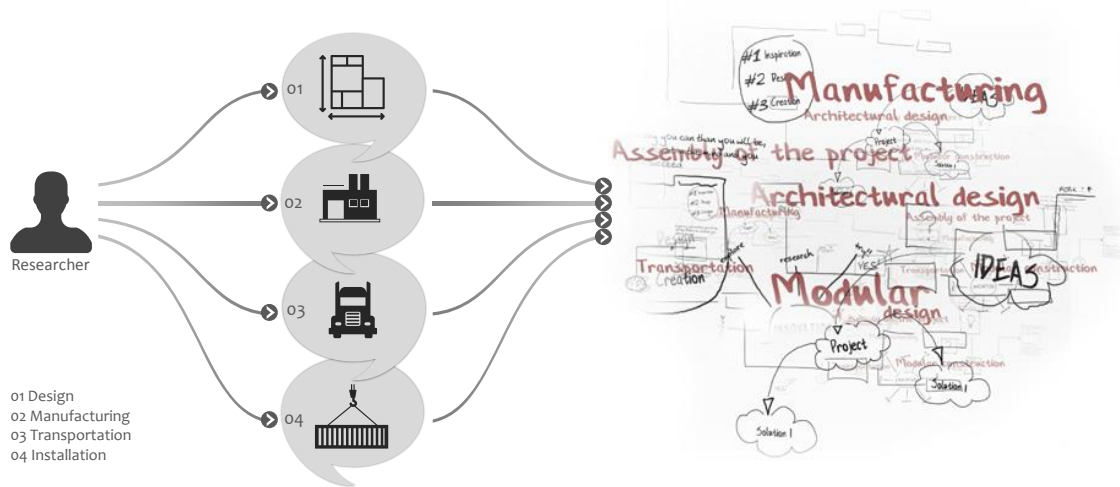

Figure 4.3: Initial phase of data analysis and coding process of the transcribed interviews.

There are a number of important steps which have been made to enhance the data analysis process during the coding phases. With these data, the researcher used the six steps of data analysis developed by Zina O’Leary for interviews. O’Leary’s 2010 book, *The Essential Guide to Doing Your Research Project*, describes the importance of not only the richness of data but how to capture, structure, prioritize, and implement knowledge as a result of the data analysis process. As O’Leary notes, “Richness is important, but qualitative analysis involves more than just preserving richness. Good qualitative analysis actually requires you to build it. Put it this way: raw data may be rich, but it is also messy and not publishable.” (p. 80).

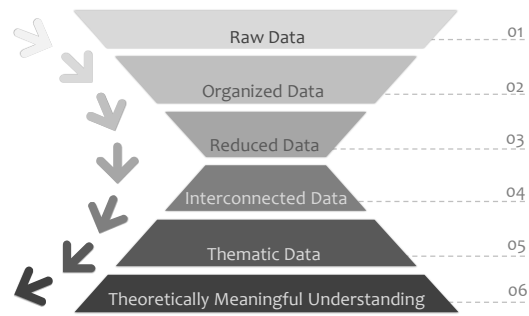

Figure 4.4: The six steps of data analysis, adopted from O’Leary (2010)

Figure 4.4, O’Leary points out six steps of data analysis: 1) raw data, 2) organized data, 3) reduced data, 4) Interconnected data, 5) Thematic data, and 6) theoretically meaningful understanding. The first three steps concentrate upon breaking down raw data into main points of information, whereas the next steps focus upon structuring knowledge, which emerged from a critical review of the initial drilling down process of the raw data.

4.1.3 Profile of the Interviewees

Interviewee No. 1 is a single-family modular home manufacturer, co-founder, and vice president who has been practicing for more than eight years. With a background in architecture, this interviewee has extensive experience in design, fabrication, and assembly of single-family homes. He/she holds multiple patents for designs of modular building units. His/her company provides clients with a number of pre-designed home options, detailing, materials, and project management services, including the transportation, installation, and the required finishes of the project on-site.

Interviewee No. 2 is a principal architect at an architectural firm and has more than 15 years of overall experience, and more than seven years of experience with modular construction methods. The firm he/she works for provides clients with high performance and prefabricated designs for single-family homes.

Interviewee No. 3 is the CEO of a modular manufacturer company for single-family homes, multi-family homes, and commercial projects. Throughout his career of more than 42 years of experience with modular construction methods, he/she has owned and directed four modular manufacturer companies. According to the Interviewee, the company has been focused lately on building homes that are Platinum level certified by the U.S. Green Building Council for

Leadership in Energy and Environmental Design (LEED) and has possibly built more LEED Platinum homes than any other manufacturer in North America.

Interviewee No. 4 is the president and sole owner of a modular consultant company and has 20 years in overall experience in construction and more than 13 years of experience with modular construction methods. The Interviewee's consultancy firm focused on modern methods of construction through the use of offsite and prefabrication buildings including high-rise apartments, student housing, health care, and government projects. The Interviewee is an active member of many professional committees focused on modular prefabrication buildings.

Interviewee No. 5 is a director of a modular manufacturer company with extensive experience (more than 38 years) in off-site modular construction for a wide range of building types including industrial, commercial, institutional, and retail buildings. The company offers their clients with an alternative contractual option which is "design-build," where the design engineering, off-site fabrication, and final on-site completion costs are incorporated into a total project package.

Interviewee No. 6 is the president and CEO of one of the largest modular manufacturer companies of single-family homes. The company also specializes in permanent modular construction for multi-family residences, apartment complexes, townhouses, and large projects including custom hotels and motels. The interviewee has over 41 years of experience in the modular manufacturing industry, and throughout this time the interviewee held various positions such as assembler, draftsman, sales representative, plant supervisor, sales manager, and vice president of operations. With all the experience the Interviewee has gained, many of the plant layouts and production lines of the companies he/she owned or directed were designed by him/her. Additionally, for the same amount of time, the Interviewee has been an active member of many professional committees and organizations focused on modular buildings including the Modular Building Systems Association (MBSA) and the National Association of Home Builders (NAHB).

Interviewee No. 7 has been the president and CEO for 31 years of a modular manufacturer company of single-family homes. The company is recognized nationally as a leader in the modular construction industry and has won many awards for different manufactured projects and their expertise. They developed a number of manufacturing techniques to increase the quality of their modular construction method for housing. The company has also worked on large-scale projects such as college dormitories, townhomes, hospitals, motels, and hotels. The Interviewee is an active member of two organizations: MBSA and NAHB.



Interviewee No. 8 is a draftsman in the engineering department at a modular manufacturer company and has 17 years of experience within the modular industry, which helped draw attention to some communication issues inside manufacturing companies. The interviewee's duties include preparing floor plans, elevation views, sectional plans, structural plans, foundation plans, structural details, electrical, mechanical, plumbing, and truss and roof framing plans.

Interviewee No. 9 is an account executive for a modular manufacturing company and has 18 years of experience within the modular industry. The interviewee's duties include building trust with prospective and existing builders and developers, searching for new builders and developers, meeting with clients to review floor plans and designs, breaking down the cost of a modular project, suggesting alternative ideas for existing plans, and assisting with concept drawings for builders who need help with clients that need to be able to see floor plans before proceeding.

Interviewee No. 10 is a vice president of sales and marketing for a modular consulting company. With a background in architecture, this interviewee has more than 12 years of experience in the modular construction industry. The Interviewee's responsibilities are to direct, coordinate, and manage the sales process of the company along with its marketing strategies. The Interviewee is also accountable for preparing and negotiating contracts. The Interviewee is an active member of the Modular Building Institute (MBI), which is an international non-profit trade association serving modular construction.

Interviewee No. 11 is an associate partner at an architectural firm and has 25 years in overall experience as a design architect and more than five years of experience with modular construction methods. The Interviewee is currently working on developing a pre-designed modular system for homes. According to the Interviewee, the expected time frame from design approval to manufacturing to moving in is 6-9 months. Finishes and exterior materials are usually selected by the firm to assist the clients with lower maintenance cost.

Interviewee No. 12 is a principal architect at an architectural firm (founded by the Interviewee and other partners) and has 19 years in overall experience as a design architect and more than 12 years of experience with modular construction systems. The firm is a full service architecture office that provides clients with a number of pre-designed home options and contract administration services. Part of the firm's services beyond schematic design and construction documentation is to supervise the preparation of the project with the factory and the site

contractor to ensure the project is built, assembled on-site, and completed with conformity with the design and construction specifications.

Interviewee No. 13 is the chief designer and president of an architectural firm and has 34 years in overall experience as a design architect and extensive knowledge of green architecture, energy efficient systems, and passive solar design. The Interviewee began a new professional practice 8 years ago that specializes and focuses on modern modular housing. The firm first started as a design-build model, providing their clients with clear steps to simplify the building process experience. Clients can pick one of the pre-designed standard modular houses designed by the firm and choose from a number of preselected finishes and materials. Once the client completes the previous two steps, the firm commences arrangements for the next steps, which are drawing the architectural, mechanical, electrical, and plumbing plans, acquiring the necessary permits, manufacturing the building, site preparation, transportation of materials, and assembly and installation of the project. According to the Interviewee, due to some difficulties, the firm recently changed from a design-build model to architects working with the modular manufacturing company.

Table 4.1 below, summarizes the Interviewees’ specialties and their work experience in years.

Table 4.1: Interviewees’ specialties and their work experience in years

Interviewee	Job Titles	Work Experience / Years
No. 1	Modular Manufacturer Co-Founder and Vice President	8
No. 2	Principal Architect at an Architectural Firm	15
No. 3	CEO of a Modular Manufacturer Company	42
No. 4	President of a Modular Consultant Company	20
No. 5	Director of a Modular Manufacturer Company	38
No. 6	President/CEO of a Modular Manufacturer Company	41
No. 7	President/CEO of a Modular Manufacturer Company	31
No. 8	Engineering Dept. at a Modular Manufacturer Company	17
No. 9	Account Executive at a Modular Manufacturer Company	18
No. 10	Vice President for Sales and Marketing at a Modular Manufacturer Company	12
No. 11	Associate Partner at an Architectural Firm	25
No. 12	Principal Architect at an Architectural Firm	12
No. 13	Chief Designer and President at an Architectural Firm	34

4.2 Findings from the Interviews (Qualitative Data)

The main focus of the analysis within this chapter deals with the knowledge and information capturing process from knowledgeable experts and producers. As players charged with manufacturing or implementing modular construction methods as an advantageous alternative to the site-built construction, their expertise in the field assisted with pointing out weak areas

in the current design and manufacturing process. Given that the main goal of this research is to map an “As-is” design-manufacture process model within the modular housing industry and then propose a “To-be” framework (model), the interview data analyzed in this chapter are mostly concerned with the design and manufacturing phases with information about transportation and on-site installation.

The first set of questions aims to review interviewees’ perceptions about their roles within modular construction with regards to the nature of their jobs and their experience, as well as the nature of the company as was discussed in the previous section. Additionally, the opportunities and challenges for modular construction, primary advantages and disadvantages of the modular construction method, and the key stakeholders, experts, and teams that are typically involved in a modular construction project will be reviewed.

The second set of questions aims to understand the existing design process for modular construction, the designer’s and manufacturer’s responsibilities, design limitations and constraints for modular construction and project deliverables, information technology tools, and the duration for reviewing and modifying those deliverables.

The third set of questions aims to understand the relationships among the digital design processes, materials, and digital manufacturing practices. To point out benefits, challenges, and limitations within each building system based upon the design criteria.

The fourth set of questions aims to understand general transportation limitations and constraints, transportation challenges, costs to transport the home from the factory, required permits, and loading processes off-site.

The fifth set of questions aims to understand general on-site assembly considerations, challenges, required permits, and unloading processes on-site.

4.2.1 The Benefits of the Modular Construction Method

All interviewees agreed that the time savings associated with the modular construction method is a major advantage when compared to traditional site-built construction. The project’s size and location play an important role in increasing or decreasing the time savings benefit. Figure 4.5 maps the construction schedule for both the modular and site-built construction methods. As can be seen below, the first two phases (design engineering and permits and approvals) for both construction methods are similar in terms of timing. Once the required project documentation is ready, the next phase begins with construction. It is apparent from this figure that the difference between modular construction and site-built construction exists primarily in

the timeline of the construction activities. With modular construction, site development, foundations, and building construction occur in a concurrent manner, whereas with conventional, site-built construction, the same activities are performed in a sequential manner. Generally, working simultaneously onsite and offsite often allows modular construction to save time, as much as half the time needed of stick-built construction.



Figure 4.5: Time savings in modular construction, adopted from the Permanent Modular Construction-2011 Annual Report

Interviewee No. 1 added that the consistency of output from the factory is considered one of the advantages. There is a pretty good chance that the second time a product comes from the factory it is going to look the same as the first one. However, there is a learning curve, so everything gets a little bit better; but it is consistent in the sense that architects or customers can consider the details, see the design of the previous house, visit a model-house (or a previous client who owns one), and know they can achieve the same results, which is uncommon in other construction methods.

Interviewee No. 12 said that a modular home is more accurate than a site-built home: less materials are wasted and most houses are built in about two weeks or less. To avoid slowing down the production line, most modular home manufacturers use top-grade materials specifically designed for the structural system, which usually increases the precision of assembly of modular component assembly.

The majority of Interviewees indicated that efficiency is another advantage. Interviewee No. 1 said that there is a significant difference between the modular construction and the site-built construction from the point of view of specialized labor needs. Typically, the modular industry draws from a less specialized labor pool, so they do not necessarily need a carpenter with 10 years of experience; they can use someone who knows how to use a nail gun since the laborer will be trained in the factory based upon their duty in the production line. It is also more efficient because it is the same people working together all the time. This is different from stick-built construction where the contractor hires a number of sub-contractors with different specialties

such as foundations, framing, mechanical, electrical, plumbing, and finished carpentry. Everything is performed by different people, it is always a different group each time consisting of workers who may not have worked together previously. However, in the factory it is always the same people working together.

Speaking about efficiency, Interviewee No. 6 said:

When I was in high school and college there was a lot of kids that went to trade schools. Those kids that went to those trade schools turned out to be carpenters or plumbers or electricians. A lot of those guys from those trade schools got to learn not only the trade but the business side of the industry or the craft that they were going to go in. That has become less and less as time goes on. That means that sooner or later those disciplines will become less available. We do not worry about that here. We train everybody to do exactly what it is we need done. Whether it's a carpenter or an electrician or a plumber, I can teach a guy how to put together walls, I can teach a guy how to plumb a house correctly, I can teach a guy how to wire a house correctly. I do not need to have them come out of those [specialties], and I think that we ultimately provide value to tomorrow's builders.

Those builders are going to have a difficult time in trying to find those disciplines. As a matter of fact, in many market areas it is tough right now to find framing crews and to find electricians and plumbers because when the industry got bad five years ago, they all scattered to other things. We had a lot of guys go to the gas fields or they are driving a water truck or they are driving a delivery truck. Those guys are gone; they are not coming back, so we fill in that labor void that builder has and I think that is singularly our largest advantage.

Based upon Interviewee No. 6's statement, what is unique to modular construction is the ability to finish between 80-95% of a project before it leaves the factory. Limited materials and lack of available skilled labor can be avoided by builders or site contractors in certain areas with the modular construction method. Interviewee No. 2 added:

The issues that I have encountered with modular construction are probably much different than what most people would. I think that most modular construction installations are done more in rural and suburban areas. The transportation in general can be difficult. Another thing that can be difficult in the urban areas is the presence of unions like labor unions. That can be a pretty big issue. It has been an issue, and it continues to be an issue.

Interviewee No. 7 mentioned that consistent pricing may make modular homes more cost-effective than site-built homes, knowing that once a modular manufacturer gives a price to a

client it is going to be guaranteed as opposed to stick building that never has guaranteed pricing. Modular home producers frequently buy materials in large volume and store them. This allows the manufacturer to maintain the price of materials for a longer period of time than most conventional builders who buy from local suppliers. By doing so, modular home manufacturers save more money and also time by not needing to constantly order and ship materials to their plants.

Other advantages mentioned by Interviewee No. 9 are the strength and energy efficiency of modular homes. Since modules need to be transported to a final destination (as much as 300 miles), they are assembled in an environmentally controlled factory in comparison to stick-built homes. Module components are nailed, screwed, and glued together to enhance the building's structural system. This enhanced construction method can withstand high wind forces and other adverse effects of Mother Nature during the transportation process. Modules typically arrive in the same condition as when they departed from the factory. Such quality construction of modular homes also enables homeowners to increase monetary savings by increasing the efficiency of the heating and cooling system. Additionally, modular homes go through more inspections than site-built homes, some of which occur through third party inspections to ensure conformity to building codes through the entire modular construction process.

Figure 4.6 presents an overview of the previous discussion regarding the benefits of the modular construction method.

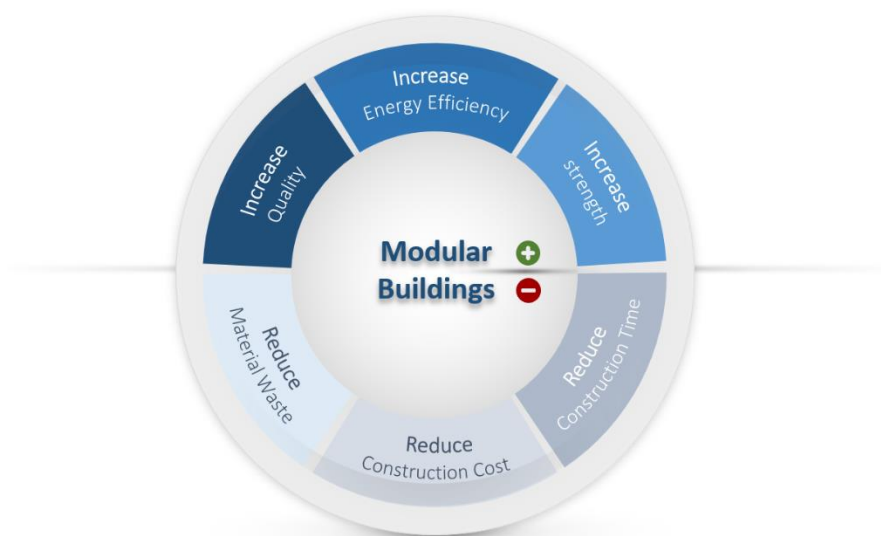

Figure 4.6: What modular construction provides

All interviewees agreed that the limitation of a module shipping size, which might affect desired room sizes, is the major disadvantage of off-site construction. Shipping modules can be expensive too, according to Interviewee No.1, the typical transportation limitation is a 100 mile radius, and even that starts to get expensive. Interviewee No.2 added that:

Specific to the urban area that I work in, there is a specific issue with building inspections because the Building Department in my area requires an on-site building inspection. So that is a difficulty when you are building a home that is built offsite 100 or more miles away from the project location.

Modular homes come with limited variety, as most of the modular manufacturing companies have pre-designed modular homes from which a home buyer can select a floor plan and then select from other preset options for finishes.

4.2.2 The Key Stakeholders Typically Involved in a Modular Home Project

All interviewees indicated that typically on a single family home the key stakeholders are the manufacturer and the builder (dealer). The builders are considered the main market of projects to the single family home manufacturers. Builders are those who find the retail customers or who the retail customers find and who contact the manufacturer to start the process. According to interviewee No. 10, the manufacturer sells the homes to an approved builder or a builder they have a relationship with, and that dealer, in turn, promotes the manufacturer as an independent entity so the builder is the connection to purchase a modular home for the end user and those roles are the key.

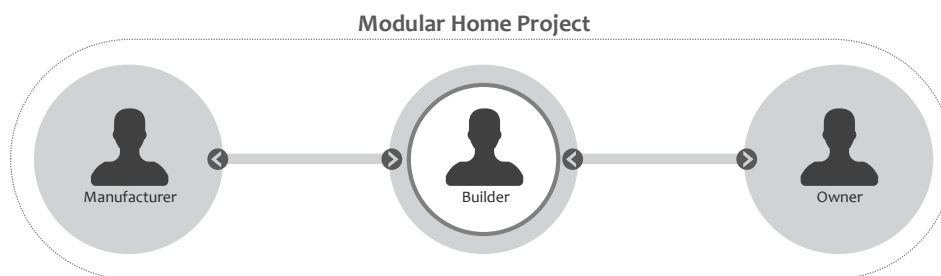

Figure 4.7: The communications among the manufacturer, builder and the owner.

Figure 4.7 shows that there is no direct interaction between the owner and the manufacturer. All the communications should go through a builder.

Other responsibilities mentioned by interviewees for a builder are to provide an owner with all necessary services and to be able to coordinate among all participants in a single-family modular project. These services typically cover the main four phases beyond obtaining all the required permits (which are design, manufacturing, transportation), and ending with the assembly of the project on-site.

In agreement, interviewee No. 6 said,

Between us, (manufacturer) we are a wholesaler, so we sell just to the builders or value added resellers, either one of the two. So the key stakeholders are ourselves and those builders. That's probably it. The builders sell to the retail customer, but the builder also contracts to have the foundation put in, have the house on the foundation and have the house finished after it's there. So what I mean as far as the transaction between our transactions, our transaction is between us and the builder period.

The previous discussion regarding the builder's role within the modular construction industry shows that usually all of the communications and responsibilities for any error that may result from any stage after manufacturing fall under the responsibility of the builder (dealer). This accountability saves the manufacturer from any legal prosecution by the owner in the event of any errors or damages resulting from the transportation or the installation of the project.

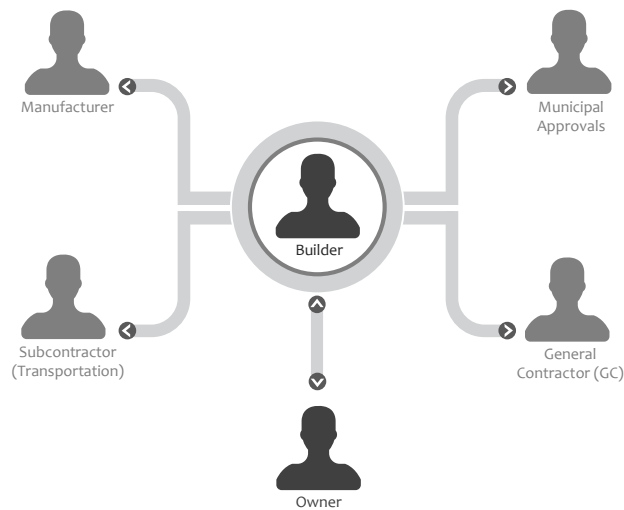

Figure 4.8: The role and responsibilities of a builder.

As shown in Figure 4.8, a builder is responsible for the design, pricing all the required services, and ordering the modular home from the manufacturer.

It should be mentioned that the interviewees from the manufacturing side emphasized that a client is not one of the stakeholders, not because there is no client but because the client is not necessarily involved in the interactions with the factory. More specifically, the majority of the manufacturers' interviewees stated that there are cases where they do communicate with the potential homebuyer. Many of the manufacturers' builders use the manufacturing facility and sample rooms for selecting plans and showing the customers (or their buyers) what it is they can get from the manufacturer. According to the interviewees, that has probably grown more over the past years, but it is not something that the modular manufacturers prefer to do. Interviewee No. 6 stated, "We do not always sit in the builders' office when color selections are being made. We are back here doing what we do, and the builder is taking care of all that because he's got all the samples."

Interviewee No. 9 added that

[w]e try to get core builders that will stay with us and get a good relationship between us and them. We try to get the builders that stay faithful to us. Once you get a builder that stays faithful to us, then we know we can entrust our men with any kind of faults or any kind of problems onsite. We know who we are dealing with, and we just believe in anything they tell us.

Interviews with the manufacturers' participants also indicated that they have one contract between a modular single-family home manufacturer and a builder (purchase order), there is no contract between a manufacturer and a retail customer except a form the retail customer needs to fill out which acknowledges that they (the customer) are going through the builder and are not buying directly from the manufacturer. Figure 4.9 shows the responsibilities for both the builder and the manufacturer that must be coordinated to build a modular home.



Figure 4.9: The stakeholders' responsibilities.

4.2.3 Design Process

The design process of a modular home, as explained by the interviewees, begins with a builder showing a client various pre-designed floor plans, allowing the client to choose one based upon his/her needs or to have the builder draw a new one. Next, the builder makes some minor changes for the client if required and selects all the interior and exterior finishes. The builder then sends the floor plans and specifications to the manufacturer for modular plans. After converting the design to modular drawings, taking into consideration factory production line and transportation limitations, the manufacturer sends the floor plans back to the builder along with the cost of the project to be constructed off-site. The builder might make some revisions to the drawings and return them to the manufacturer for update. These steps are a sequential back and forth until the builder has approved or signed a contract with the client and sends a purchase order to the manufacturer. Figure 4.10 shows the typical design process of a modular home as mentioned by the interviewees.

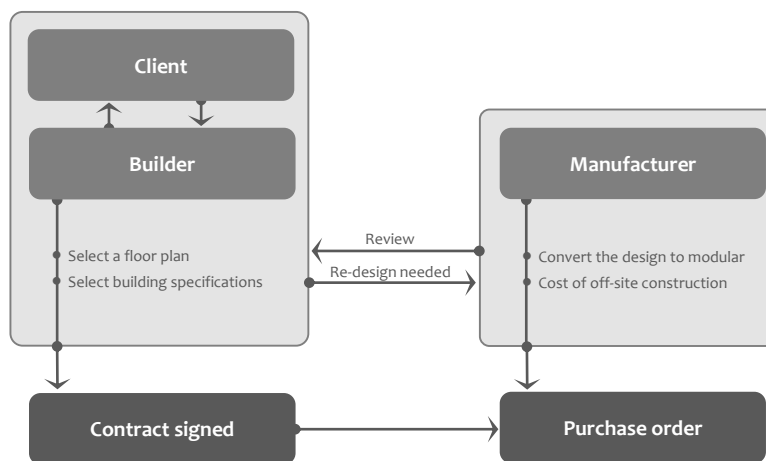

Figure 4.10: The preliminary design process of a modular home.

According to the interviewees, during the design process most of the modular manufacturers will provide the builders the required services such as converting the floor plans to modular drawings (preliminary drawings), design revisions and manufacturing cost estimates with no charge. The reason behind not charging a fee for these services is that, beside the pre-designed floor plans, manufacturers of modular homes are typically offering a variety and number of pre-defined finishing options for their buyers to select from. As long as the buyer is selecting from the manufacturer's design catalog and list of finishing options, there is no charge. Interviewee No. 6 mentioned that they have developed their own estimating software based upon their pre-

defined finishing options. According to Interviewee No. 6, once they receive the preliminary drawings and the list of finishing options from the builder, the estimating department can have price and cost information 12 hours before the converted modular drawings are completed.

4.2.4 The Decision Makers Involved in the Design Phase for Modular Homes

As mentioned earlier, modular manufacturers rarely deal directly with end-users (clients) and work directly with builders. This is because manufacturers do not want to be involved in the back and forth during the initial design phase. However, there is a back and forth during this phase between the builder and the manufacturer. As noted by Interviewee No. 3, whether a standard pre-designed floor plan with minor changes or a custom design, builders working with the modular construction industry commonly understand both the design constraints and the manufacturing possibilities and limitations based upon their relationship with a specific factory; therefore, the time needed to educate a client about the entire design process and requirements, including a manufacturer’s standard features and finishing options, is part of the builder responsibilities.

Interviewee No. 1 said that the most common decision maker is the builder, second-most is the manufacturer. When there is an architect, the architect usually represents the client and works closely with the builder to finalize all the required documentation. The builder can then contact the manufacturer and send the first draft of preliminary drawings along with the materials selection for a review and cost estimate.

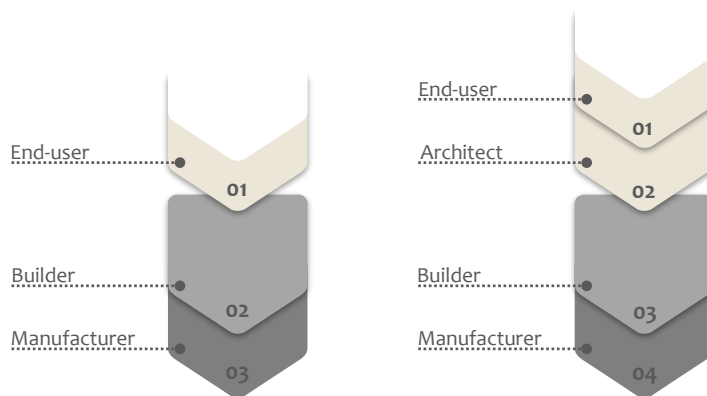



Figure 4.11: The decision makers involved in the design phase for modular homes

Figure 4.11 shows the decision-makers involved in the design phase for modular homes. The right diagram illustrates the flow of information from end-user to builder and from builder to



manufacturer. The left presents the architect's involvement; however, the information flow remains the same when the architect represents the end-user and there is no direct communication among the design team and the manufacturing team.

4.2.5 Modular vs. On-Site Construction in Terms of the Client's Involvement

All of the interviewees emphasized that the decision making process in a single-family home project using a modular construction method is a bit different than an on-site construction project. All the decisions regarding the design and finishes should be made early on, so the coordination in the design process among all the different trades such as, material selection, carpentry, finishes, doors and windows, all these selections should be made at the beginning. It is much more difficult to make those decisions after the construction has started. Modular manufacturers typically deal with late changes by charging huge fees.

Interviewee No. 1 stated that modular construction is different in the sense that the client needs to freeze the design at some point, which is very different than typical on-site construction where clients have more flexibility for making modifications. Interviewee No.2 added that in order to reap the benefits of the manufacturing process, you have to make the decisions ahead of time. If you have to go back and start modifying the building after or during manufacturing, then all of a sudden you start negating the advantages of modular construction in the first place (as discussed earlier). Also, the client is held responsible for any additional costs or schedule delays resulting from a change order request.

Interviewee No. 3 said there is a big difference within the planning process to gain a common understanding of where the boundaries exist between the work that will be done in the factory and on-site. So, because of a lack of knowledge in the construction industry in general with regard to off-site construction, there is quite a bit of time invested in educating participants and making sure they are prepared to work with modular construction. Interviewee No. 3 added that in some cases, custom home design clients will engage an architect; however, few of those architects are familiar with the advantages and constraints of modular construction methods. And the best way to describe a modular project is that part of the construction process is going to be executed partially off-site, where the other part of the construction will be completed on-site. Few manufacturers have relationships with architects that have never been involved with modular construction in the past, but were willing to learn its basics and come up with a design developed specifically for a modular project. Interviewee No. 3 said,

That has been probably one of our interests in continuing to stretch the boundaries and figure out what we might do to add more value to modular single-family home projects. Some architects might say this is my part, you figure out how to match this with your manufacturing process even if it is not maximally efficient. Working with such architects would be avoided by some other participants in this industry because they are complex and so forth.

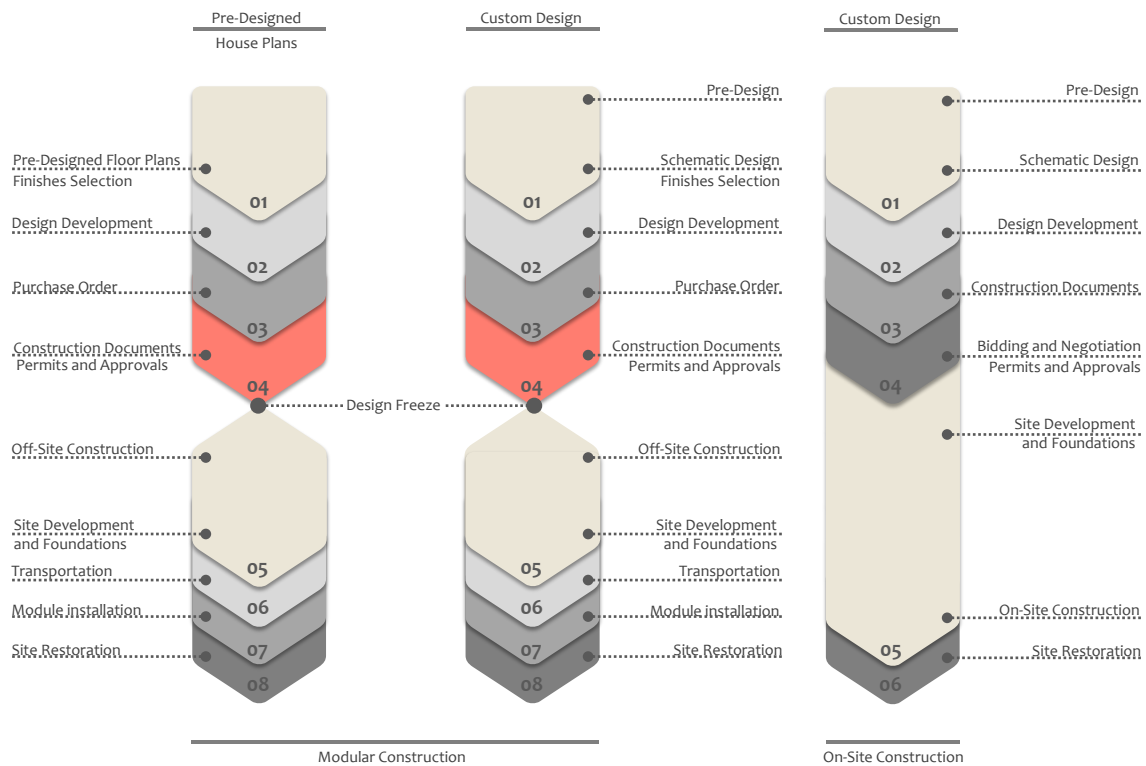

Figure 4.12: Relative design and construction phases for a modular project compared to fully on-site project.

Figure 4.12 shows the design and construction phases for a modular project compared to a traditional on-site project. The left two diagrams illustrate the two design options for modular construction: 1) pre-designed house plans and 2) custom design. As can be seen from the modular construction diagrams (above), once the module production started, the client cannot request to change or modify the design (design freeze), whereas in traditional on-site construction (as can be seen at the right diagram), there is more flexibility to change or modify the design.

4.2.6 Advanced Technologies Utilization

All interviewees were asked what type of advanced technologies they typically use: 1) to present the project to a client, 2) to exchange information among different modular service providers, or 3) to innovate, improve, and develop modular products, processes, and services.

Because there are different players in the field of a single-family modular home project at the same time, it is important to follow a common format. The format was consistent based upon six main areas which are:

1. Computer-aided design (CAD) based upon two-or three-dimensional (2D or 3D) graphical representations.
2. Computer-aided manufacturing (CAM)
3. Computer-numerical control (CNC)
4. 3D printing technology
5. Building Information Modeling (BIM)
6. Research and development (R&D)

Table 4.2 below, summarizes the Interviewees' answers to the integration of information technology (IT) tools in their work.

Table 4.2: Advanced technologies utilization

Interviewee	CAD (2D)	CAD (3D)	CAM	CNC	3D Printing	BIM	R&D
No. 1	●	●	●	●			
No. 2	●	●					
No. 3	●						
No. 4	●						
No. 5	●						
No. 6	●						
No. 7	●						
No. 8	●						
No. 9	●						
No. 10	●	●					
No. 11	●	●					
No. 12	●	●					
No. 13	●	●					

As can be seen from the table (above), the CAD (2D), based upon two dimensional graphical representation programs, is used by all the participants in this research. In the modular industry,

there are some interviewees that think AutoCAD is advanced enough to produce shop drawings. Interviewee No.1 added that some modular manufacturers primarily use AutoCAD to make shop drawings, focusing on the accuracy and how a certain thing is made as opposed to the quality of the design. As interviewee No.6 said,

We do not have a design department, we have an engineering department. Remember we are fabricators, we are manufacturers, we are not designers, we never claim to be design professionals. Most of our folks are trade school graduates: they learned how to use AutoCAD and things like that, but they did not go to any school for design or architecture.

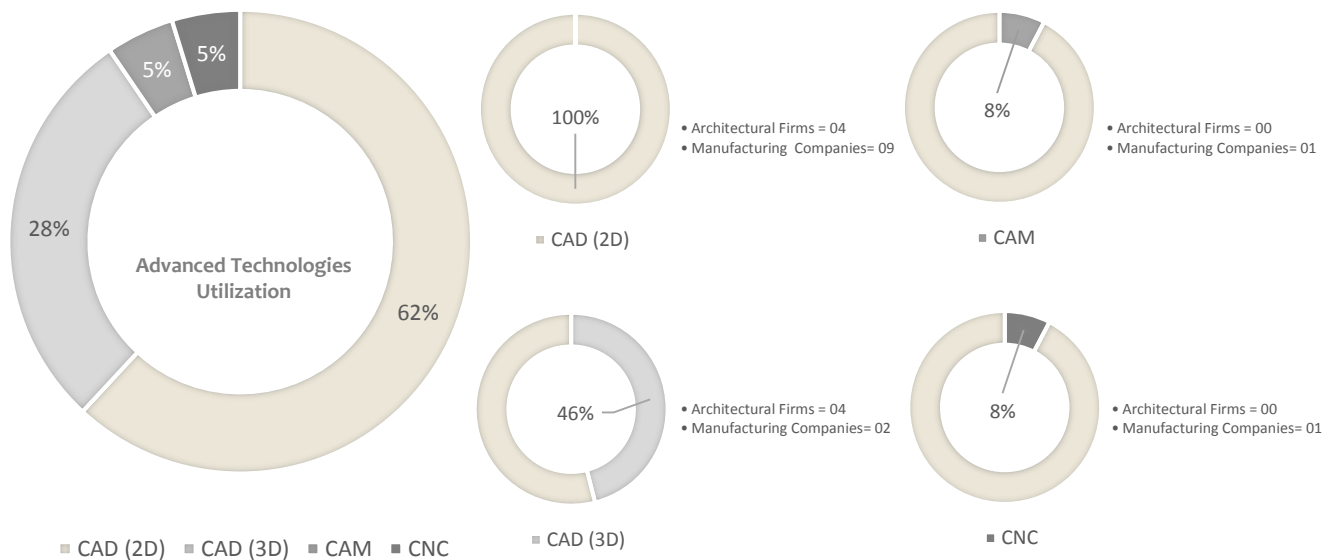

Figure 4.13: The use of IT tools during the design and manufacturing phases.

It is apparent from the previous table that very few participants use CAD (3D) based upon three dimensional graphical representation programs. Figure 4.13 compares the results obtained from the preliminary information of Table 4.2. The pie chart above (left) shows the main characteristics of the use of IT tools during the design and manufacturing phases. The pie charts (right) show a breakdown of each IT tool based upon the participants' specializations. From these charts, we can see that 3D CAD programs are mainly used for design and renderings by all four architectural firms that participated in this research. Only two manufacturing companies are using 3D CAD programs in a different manner: one for developing specific details as part of

their modular production shop drawings, and the other for an alternative tool to generate 2D drawings (such as Revit by Autodesk). Some of the main challenges faced by most of the modular manufacturing industries that do not utilize 3D CAD programs were presented by interviewee No.5:

Currently we are using Revit. In the past we used AutoCAD. The problem is Revit now, although it professed to be the greatest thing, in my mind it was overhyped, and it was oversold. We cannot find people who are trained in Revit. The people that we do find, we pay a premium to get them. And when you get them you cannot keep them because they are always looking for the next guys that can offer them the highest dollar. And that's becoming for us a problem. Right now we are trying to find another CAD person. We have been looking for six months now.

In regards to the challenges mentioned above, the result also shows that one modular construction company is using CAD (2D), CAD (3D), CAM and CNC technologies; however, the use of these promising technologies still remains within the manufacturer's standard production line that typically require repetitive, prefabricated components such as cutting steel brackets and sheathing panels. In order to enhance the level of automation in the manufacturing process, there is a need to integrate and involve the various design development stages. Such integration may not only enhance the manufacturing production process but also the quality of design. It may also interest more architects to develop new designs that would not be able to be built with typical on-site construction methods. A detailed example regarding the integration of design and manufacturing processes will be presented in the next chapter.

In response to the question "Does your company use any advanced technologies other than 2D-3D representations to present the project to a client, such as 3D printing?", all interviewees answered that they do not have 3D printing technology yet. The most surprising aspect of the data in the previous table is that none of the participant companies in this study have research and development (R&D) departments. This means there is no constant search for new strategies to increase not only the productivity of their modular fabrication but also other sources for innovations such as the development of new products, processes, and services.

Finally, the interviews revealed that Building Information Modeling (BIM) as a digital database for collaboration and the transfer of digital information among different fields and clients has not yet been adopted. Interviewee No. 5 said the problem is that most clients are not sophisticated enough to know about the benefits of BIM. Once they learn more about the value that a BIM model may add to their project lifecycle (such as facility management and

renovations), clients may request a building model. Some interviewees from the modular manufacturing industry pointed out that they are still finding Autodesk Revit as a BIM tool to be very challenging to adopt for smaller scale residential modular industry specifically, such as a single-family modular home.

Interviewee No. 2 mentioned that his/her firm has tried BIM in two single-family modular projects, and they spent an immense amount of time on project coordination and management. However, there was not enough investment in those projects dedicated to do a fully coordinated BIM model, so they lost money on every one of those projects. Interviewee No. 2 said, “I was willing to do a BIM project as an experiment, but you cannot do that and understand you are going to lose money on every contract to try to fully coordinate everything.”

Interviewee No. 2 added that, unfortunately, most of the subcontractors in the field do not follow the drawings. If all the subcontractors were in a factory and had a project manager to make them follow the drawings to order, then it would work well. However, with modular construction, part of the construction work is completed on-site, and once the drawings go out into the field, many times the contractors/subcontractors may ignore some information on the drawings that they do not understand and figure out their own approach to execute the remaining work.

According to interviewee No. 2, in small residential modular projects, there is a general contractor, but most of the time there is no dedicated site supervisor who coordinates all the different trades and is on-site all the time to answer questions. However, with most larger modular projects, especially in the commercial world, there is a dedicated site supervisor to guide and make sure that all contractors and sub-contractors understand the construction drawings. The main reason behind not having that level of supervision for smaller modular projects is the limited budget. Interviewee No. 2 stated, “You cannot afford to have \$85,000 of that ‘budget’ to be [allocated to] a dedicated supervisor for a four month project.”

4.2.7 The Common Project Delivery Methods in Modular Home Industry

As mentioned earlier in this chapter, all the interviewees mentioned that there is a purchase order (contract) between a modular single-family home manufacturer and a builder; there is no contract between a manufacturer and a retail customer.

Interviewee No. 1 stated that most modular home manufacturing companies do not use any of the American Institute of Architects (AIA) contracts such as, Design-Bid-Build (DBB), Design-

Build (DB) and Integrated Project Delivery (IPD) unless there is an architect involved, which is not a common case. Typically, none of those specific contracts are actually required. According to Interviewee No. 1, a purchase order usually specifies the payments, the modular units' shipping and on-site arrival dates, and the warranty section for modular units and the length of coverage.

Interviewee No. 2 said that the modular home industry would increase the quality of their end-product (specifically on-site), if all project players would agree to work under the IPD contract method. It can make a lot of sense to have the consultants, contractor, sub-contractors and manufacturers on board at the beginning; however, IPD probably applies more to larger projects. The problem is that the IPD contract method requires an expense and commitment from all those players to get to the table in the first place. And when you are working on a project that is less than a half-million dollars, there is no budget for coordinating all those people early and throughout the process. Once you have a \$10 million dollar project, you can have dedicated people working with you in a more integrated fashion, but there is not a lot of margin on single-family home projects. Interviewee No. 2 added, as an architect, "I am doing mostly Design-Bid-Build (DBB) right now; it is actually not my first choice." In Interviewee's No. 2 view, DBB can provide and assist in understanding what the costs are on a modular project. It is part of the educational side for both the architects and their clients to find and develop better relationships with contractors, who can work with them and get for them fair pricing for the time needed to complete the project. Using the cost information from DBB, may assist architects working with modular home projects in the future ideally to move more towards the Design-Build (DB) type of arrangement.

Tables 4.3 and 4.4 below, illustrate the advantages and considerations of DBB and DB methods (Maurice, 2008).

Table 4.3: Advantages and considerations of the Design-Bid-Build (DBB) method, adopted from Maurice (2008)

Advantages	Considerations
Owner controls design and construction	Requires significant owner expertise and resources
Design changes easily accommodated prior to start of construction	Shared responsibility for project delivery
Design is complete prior to construction award	Owner at risk to contractor for design errors
Construction cost is fixed at contract award	Design and construction are sequential, typically resulting in longer schedules
Low bid cost, maximum competition	Construction cost unknown until contract award
Relative ease of implementation	No contractor input in design, planning or value engineering (VE).

Table 4.4: Advantages and considerations of the Design- Build (DB) method, adopted from Maurice (2008)

Advantages	Considerations
Single entity responsible for design and construction	Minimal owner control of both design and construction quality
Construction often starts before design completion reducing project schedule	Requires a comprehensive and carefully prepared performance specification
Construction cost known and fixed during design, price certainty	Design changes after construction begins are costly
Transfer of design and construction risk from owner to the DB entity	Potentially conflicting interests as both designer and contractor
Emphasis on cost control	High bid costs/fewer bidders
Requires less owner expertise and resources	Use may be restricted by regulation

Interviewee No. 2 also added that when an architect is hired by a client to design a modular home, there are typically two different scenarios of contracts:

- 1) The client will have two contracts: one with the architect and another with the builder (Figure 4.14).

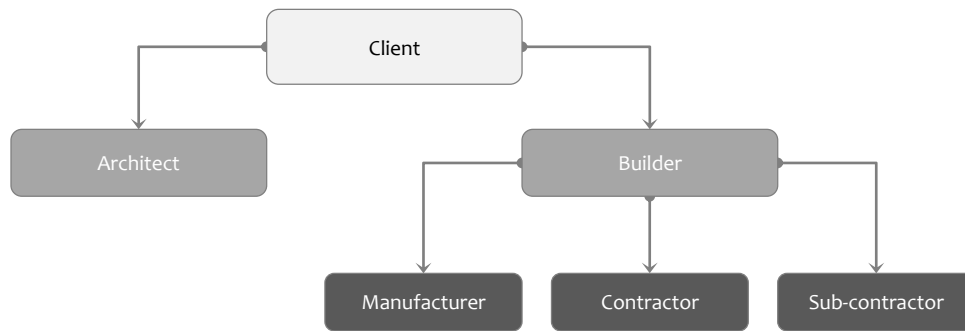

Figure 4.14: Contractual relationship between (client-architect) and (client-builder).

- 2) The architect will be a sub-contractor to the builder which means the client will have one contract (Figure 4.15).

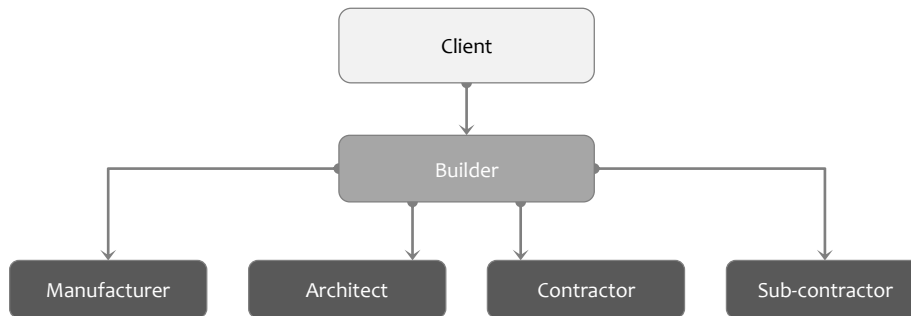

Figure 4.15: Contractual relationship between a client and a builder.

According to Interviewee No. 2, choosing which type of contract to use depends on the financing agreement and how the client is working with financial planning.

Interviewee No. 3 pointed out that in the presence of an architect, the most common method, is that the modular manufacturer will sign a contract with the builder that requires the manufacturer to conform to the plans developed by the architect. There are exceptions, as when a manufacturer is working directly with an architect. (In such a situation, the architect's firm has either a design-build capability or is acting as both an architect and a construction manager.) (Figure 4.16) In that case, a modular home manufacturer would have a contract with the architect. Interviewee No. 3 added that, typically, modular manufacturers do not engage architects for consulting when developing pre-designed plans, they usually work for or with them.

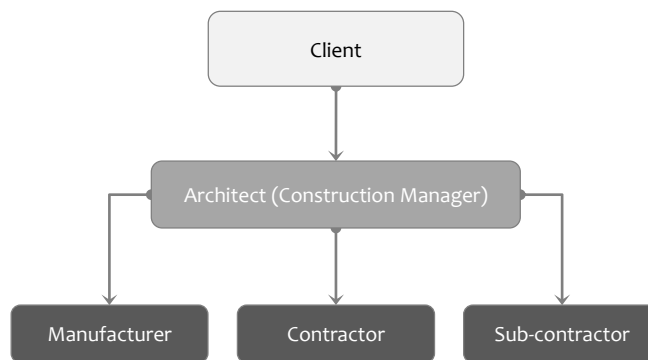

Figure 4.16: Contractual relationship between a client and an architect.

Interviewee No. 12 suggested that if an architect wants to work with the DB contractual method, it is important to limit the geographic area. It cannot be a DB and be everywhere, particularly with single-family modular homes. It is important for an architect to take into consideration the distance between the modular factory plant and site location. The cost increases to send the employees out, and there is also a need to hire local workers because it is very difficult financially to bring an entire crew to the site for many reasons: one of which is relocation expenses. So that an architect does not lose money, time, or both on a very tricky contract method like DB, it is important to build a high volume of modular homes.

Interviewee No. 12 highlighted the need to rethink the existing process between off-site and on-site construction for single-family modular homes. For example, according to interviewee No. 12, Superior Walls used to have a delivery model that they made and made local builders (dealers) responsible for the on-site installation. However, there were numerous complaints

from their clients. To correct the situation, the company has hired sales people as well as builders who sell Superior Wall's products for a fixed percentage of the sale. To ensure quality, Superior Walls request that clients procure their own crane, but Superior Walls sends their own crew. This crew travels with the panels and installs them. Interviewee No. 12 said, "So, it is a Design-Build but that is a very discreet way. There is a very big difference between putting together a bunch of concrete panels and building a house."

Interviewee No. 12 stated that for architects working with modular home projects, one constructive approach to obtain a better product is to add a fee in addition to the design cost and supervise all the people involved in the project, as a representative of the client. Such an approach can assist to ensure that everyone is following the drawings' instructions. According to Interviewee No. 12, it is a typical contractual relationship in design and development, bidding and then contract administration, but instead of making a set of drawings being handed to a builder and receiving a single price, a multiple set of bid documents are handed to different sub-contractors for bidding. The architect will typically control the bidding phase, and the client sees directly all of the process. It is a better delivery method for single-family modular projects versus the DB method in which everything is contained within a bubble, and then time is short and the probability of losing money is high (Figure 4.17).

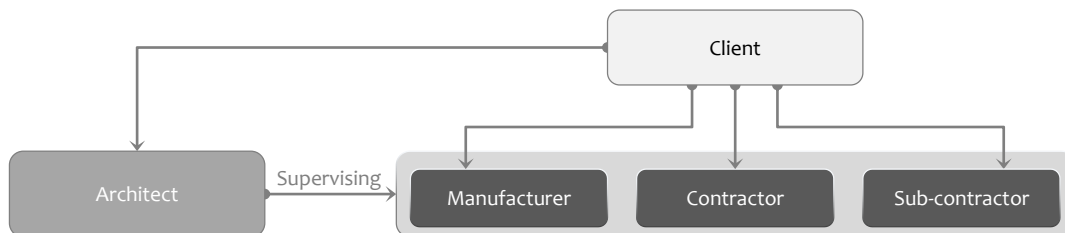

Figure 4.17: Suggested project delivery method for architects working with modular home industry.

Interviewee No. 4 added DB and IPD seem to be the only contractual relationship that allows for that kind of integration among the design phase, off-site and on-site construction. Interviewee No. 4 also mentioned the need for new models for contracting methodology within the modular home industry. Such a contract may assist in bridging the gap between the two construction phases as discussed earlier: 1) The off-site creation by the manufacturer, and 2) the on-site construction by the contractor.

There has been such an increase in popularity of the modular home industry; however, the contractual relationship needs to shift from traditional methods where the multiple entities responsible for design and construction become a single entity. This may help with addressing and solving problems faster and without blame being passed among the different players.

4.2.8 The Information Flow from Design to the Manufacturing Phase

As shown earlier in the Design Process section of this chapter, there are two main communication networks: 1) client-builder, and 2) builder-manufacturer. Once the client has approved the design of the project and all the interior and exterior finishes, the builder will sign a contract with the client and send a purchase order to the manufacturer. According to Interviewee No. 10, when the manufacturer receives the purchase order (project development agreement), the engineering team² begins developing the construction documents (CDs) and shop drawings (when needed). After CDs are completed, reviewed, and approved by state and local authorities, the production drawings are developed by the engineering team in order to start the manufacturing process.

As discussed In Chapter 2, the information gathering and analysis process is one of the most important steps before design begins. The point here lies in the importance of providing information that will contribute effectively in translating user needs and requirements to facilitate the process of communication among all parties involved, from design to manufacturing and ending with the on-site installation of the project.

To better understand the information flow from the design phase to the manufacturing phase within the modular single-family homes industry, a more detailed clarification by interviewee No.8 will be discussed next, focusing upon the aspects of design development phases and the exchange of information.

Speaking about the process of communication during the design phase, Interviewee No. 8 commented:

The biggest weakness that I can see is the breakdown in the communication from where it can actually get from the customer through to the architect, then to the builder, then to a sales representative, then to the engineering manager, and then into our hands [engineering team]. And I think in dealing with specific designs, in

² According to Interviewee No. 1, the engineering team typically are technical drafters and part of the factory.

my experience, in my opinion, the best way to handle that is for one to be able to sit down with the customer directly or sit down with the architect directly: not to cut out the middle man but just to alleviate that breakdown in communication from the customer to when it gets to the engineering process. And I think that is where a lot of the problems lies with time.

You know one of the biggest things is to get the project done as quick as possible, get it on the production line as quick as possible, and some of that communication process ends up creating more time because it might not have gotten translated properly to us or vice versa, and then you're getting back into more changes that need to take place. And I think a lot of that can be taking care of with a direct call to the customer or architect or vice versa.

Based upon Interviewee No. 8's comment, Figure 4.18 shows that there is no direct interaction between the client/architect and the engineering team during the design phase. All communications regarding design should go through the builder first, to the sales representative next, then to the engineering manager, and finally to the engineering team. The engineering team will generate a preliminary design with engineering requirements based upon the received information. Once the preliminary drawings are generated, the engineering manager sends the drawings back to the sales representative who resends it back to the builder, and the builder sends it back to the client for review. It is important to note, however, that if the client approves or has some comments regarding the design, the preliminary drawings go through that same chain of process for revision.

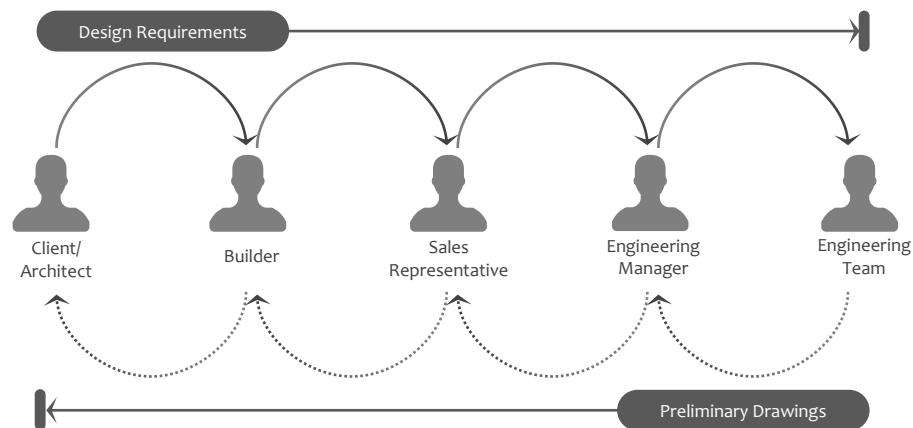

Figure 4.18: The communication process during the design phase.

In architectural practice, meeting with the client face-to-face by a design specialist is considered one of the most critical activities to ensure understanding not only the client’s needs for his/her future home, but also to discuss design ideas along with basic and technical approaches to develop the design. Yet that is typically not the case within the modular single-family home industry. Interviewee No. 8 added that the engineering team should be more involved upfront with the client and builder during the design development phase. According to the interviewee, such direct contact between the client/builder and engineering team (design specialists), may assist with accelerating the preliminary design process by understanding 1) what the client is looking for and helping to guarantee that 2) the design requirements do not get lost in translation while traveling from the client/builder all the way to the engineering team.

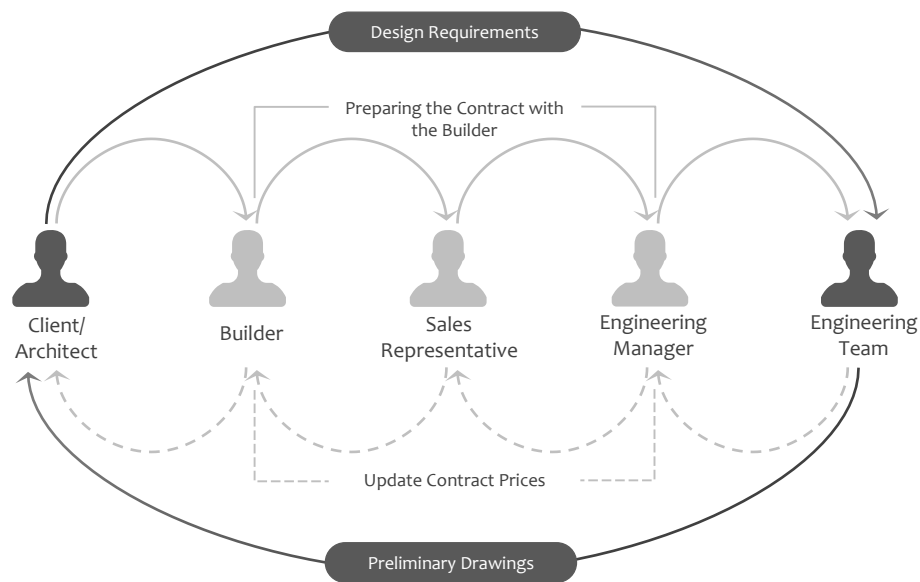

Figure 4.19: The proposed communication process during the design phase.

During the preliminary design process, the goal is not only to listen to the client’s requirements, it should clarify the basic design strategies for the modular construction method and how the project will be executed. Based upon Interviewee No. 8’s clarifications, Figure 4.19 proposes direct contact between the client/architect and the engineering team during the preliminary design phase. As the project moves into concept development, the sales representative and engineering manager can start preparing the contract with the builder. The contract will then be updated with regard to any changes requested by the client.

Based upon the interviewee's description, the information flow from design to the manufacturing phase within the modular single-family home industry could be summarized in the following steps:

1. The process typically begins with a meeting between a client and a builder to discuss the client's needs and requirements for his/her future modular home. After the meeting, the builder should have a clear understanding of what the client is looking for in the new home, and the client should be aware of the design and construction procedures for modular homes.
2. Next, the builder contacts a modular manufacturer sales representative to request a preliminary pricing proposal based upon the client's new home requirements along with pre-designed (sketch) floor plans. The pricing proposal may be updated during the design process depending upon any changes requested by the client.
3. Once the client accepts the preliminary pricing proposal, the builder sends back the pricing proposal to the sales representative. The engineering team then generates the preliminary drawings and sends them to the sales representative, who will pass them to the builder for client review, which includes the site plans, preliminary floor plans, and elevations.
4. After all the client's requested changes are finalized by the engineering team, the client should approve the preliminary drawings. Once the sales representative receives the client's approval from the builder, the engineering team then develops the preliminary drawings into a formal architectural set of drawings including a revised site plan, floor plans, electrical, plumbing, cross-sections, and exterior elevations necessary to obtain state approval.
5. Next, the builder should sign a contract with the client and send a purchase order to the manufacturer. The contract typically includes a pricing schedule and full details of all selected interior and exterior finishes. It will also have an estimated timeline from contract to moving-in day. Once the contract is signed, the client must pay a deposit equaling about 10-20% of the cost of the home.
6. The engineering team then begins working on all of the construction drawings and specifications, including architectural, structural, mechanical, and electrical documentation. The next step is to send project documents to a third-party consultant for revision. Any comments received from the third-party consultant are updated and

corrected by the engineering team. If there are no further comments, the third-party consultant stamps the project documents (and a sealed set if needed).

7. The sales representative sends the sealed set back to the builder to obtain the required permits and approvals from the local authority.
8. Once the permits are obtained, the house is released for production and returns to the engineering team where they then generate all the production drawings such as floor plans and framing (specific dimensions for wall framing, roof framing), and specific details about electrical and plumbing. After finishing the production drawings, the production process of the home starts and is put into the production queue.
9. Finished modular units are delivered to the jobsite to be set by the builder or general contractor who was hired by the client.

Figure 4.20 shows who is responsible for obtaining the local and state permits and approvals for the design phase based upon the previous steps.

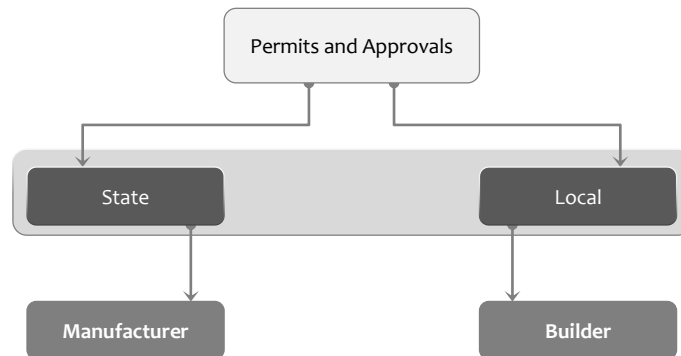

Figure 4.20: Local and state permits for the design phase.

4.2.9 Bottlenecks in the Information and Production Flow that could Cause Delay

Interviewees No. 1, No. 9, and No. 12 pointed out that one of the main problems is the project approval times from local authorities, which could cause delay or stop the flow of information (especially in the big factories). Interviewee No. 1 added that project approval times tend to be too long for different reasons: one reason being the location of the project. With permanent modular construction, single-family home factories are certified by a third party agency (local authority) and that third party agency is certified by the state. In some states, according to

Interviewee No. 1, the local authority may give the permit to build the project but will not send their inspectors to look at anything started in the factory, specifically if the factory is in a different state or far away from the actual project site location. Interviewee No. 1 said,

Some factories, including my company, will start building before there is a local permit. The reason is local permit takes a lot of time and in certain places there may not be people working fulltime at the permit office, so if there is an issue where the client does not receive the building permit, that could stop a project.

Interviewee No. 12 indicated that good factories will not start constructing the modules until the foundation is built on-site and is checked to match their modules production drawings, because it could technically not match up. The factory will then take the construction drawings to obtain state approval. Afterward, the builder will take the state approved construction drawings to get the permit from the local authority.

Clearly, the above conditions point to the need of a new information flow structure among the factory, builder, and state and local authorities, in which they all can work simultaneously through a shared platform to not only expedite the state and local approvals, but to also update the construction drawings if needed.

Interviewee No. 1 added that supply chain issues are another bottleneck in the information and production flow that could cause delay. Modular home manufacturers usually do not like working with different and/or new materials such as customized window frames and different types of tiles, because manufacturers want their suppliers to fulfill predictable incoming material orders on time; if they do not get it on time, this can slow down or stop the factory's production flow. Usually factories have repositories or open space next to the production line where they can move modules out of the line when needed to avoid delay issues. If the factory does not have a repository or open space next to the production line and there is a new project down the line, any affected module(s) usually goes to the back of the line.

Interviewee No.2 indicated that in general there is not a whole lot of coordination or dialogue between professional designers, architects, and people in the modular industry, specifically to custom design single family homes. A lot of manufacturers have their own set of standard stocks and floor plans or homes that they like to do, and so basically stick to what they know. Interviewee No. 3 agreed with this point and added that when dealing with an architect's custom design, typically, much of the contact in the earlier design phase (as discussed earlier) is going to be managed by sales representative or project manager with some sales skills. Afterward, the sales representative will translate the project requirements, based upon the

information received from the architect, to the teams that are developing the shop materials (both drawings and written instructions).

However, according to Interviewee No. 3 many manufacturers can get into a situation where teams that are focused on execution on the floor (production line) said, “I don’t understand what you mean by that. That’s not sufficiently clear.”

And so the process of going back and getting those definitions which may flow through the architect’s definitions can cause delays and add some time for two teams: 1) engineering team need to update and clarify the production drawings, 2) execution teams need to move the affected modules out of the production line to avoid delay issues with other projects.

Interviewee No. 13 mentioned that production delays can have many different causes, such as removal of framing after it has been installed. The reason behind this issue is that the factory floor workers building the modules usually do not read drawings, and most of what they build is a stock design they can do over and over again. Interviewee No. 11 agreed with this point, adding that the limited skill level of the manufacturers’ workers increases the chance of facing problems with low quality and scheduling of work.

The majority of problems that can cause delays for modular single-family home custom design projects usually appear during the beginning of the manufacturing phase and could also be found in any of the later production line stations. So the focus of the initial stages of the design and understanding is not only the requirements of the project, but all the architectural and engineering details which may assist with avoiding delay problems commonly resulting from poor communication, translation, and implementation of both detailed drawings and written production instructions. Interviewee No. 10 alluded to the notion of design development activities and how important it is to stop at a point (see section 4.2.5 for more details) in order to start preparing the construction documents. As the project moves into the construction development phase, the client and the architect should make a decision and stop making any additional design changes that might add extra cost and expand the time frame of the project. With the modular construction method, according to Interviewee No. 10, the bottleneck is actually getting the construction documents completed, because if the construction document work is not ready, a manufacturer cannot start buying materials to build the project.

Interviewee No. 9 mentioned that most of the big modular single-family home manufacturers do not have in-house structural, mechanical, and electrical engineers, so one of the common problems that can cause delay is the time that it takes to get the plans and calculations back from a third-party consultant.

The main constraints during the information and production flow that could cause delay are summarized below in Figure 4.21 based upon the previous discussion.

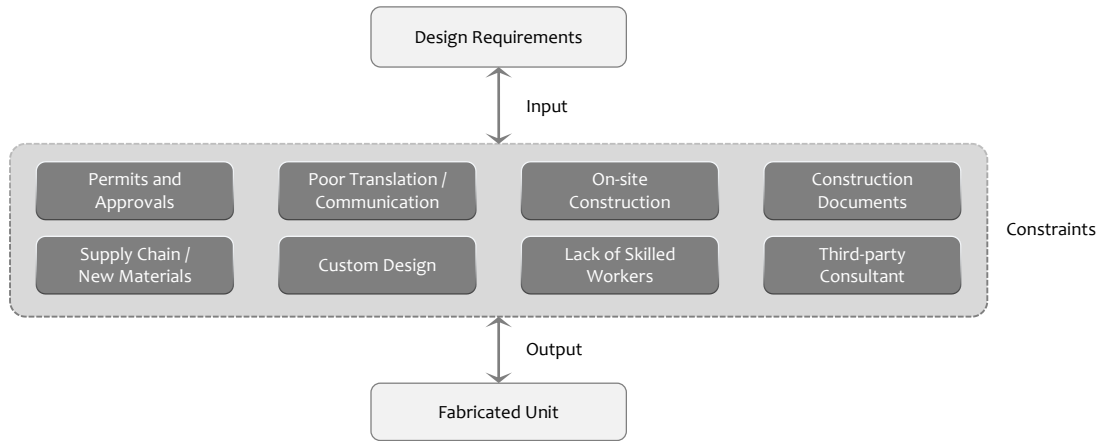

Figure 4.21: Constraints in the information and production flow that could cause delay.

4.2.10 Common Design Problems and Issues for the Modular Construction Method

A number of issues were identified; however, there is one common design problem for the modular construction method mentioned by all of the interviewees: the shipping and size limitations of each module (maximum length, width, and height). Interviewee No. 1 specified that the maximum shipping height in most of the states is typically 13 feet 6 inches, but a truck is somewhere between 2 feet and 4 feet above the ground, so that only leaves 9 feet to 11 feet (module) clear height. The most affected volumetric (see section 2.3.6.2 for more details) space with height limitation is the bathrooms, because generally with some plumbing systems and components, the ideal space needed is around a 12-foot height; however, because of shipping height limitations, the maximum usable height is limited to 8 feet with 2 feet above to accommodate the needed plumbing space. Interviewee No. 1 listed another internal layout space issue that design teams need to take into consideration: connecting modules together. A modular home is typically built from one or more sectional units (modules) in a box-shaped form (so for a typical module there are four walls), and when a bunch of modules are connected, space for internal layouts are challenging because there will be a double wall wherever two modules come together which can stretch or reduce some of the internal space a bit.

The size limitation of each module due to shipping factors is the biggest design constraint for modular construction. Based upon Department of Transportation guidelines, most modular manufacturers can build modules up to 60 feet long. Production varies depending on the

capabilities of each manufacturer. There are a number of modular manufacturers that can build up to 72-foot long modules; however, such a length may not be allowed to be transported through many states. The width of each module can be built from 12 feet to 15 feet 9 inches. The maximum height of a module as discussed earlier is 11 feet, and it should be taken into consideration during the design phase that the total height of the module and the flatbed of the trailer is 13 feet 6 inches (Gianino, 2005). The size of the module will vary depending on the location of the project. According to interviewee No. 2, the maximum module size to be transported to the project's location in a city is 14 feet wide, whereas for some locations in rural areas, module width can be as much as 15 feet and 9 inches. Figure 4.22 shows the size limits of each module.

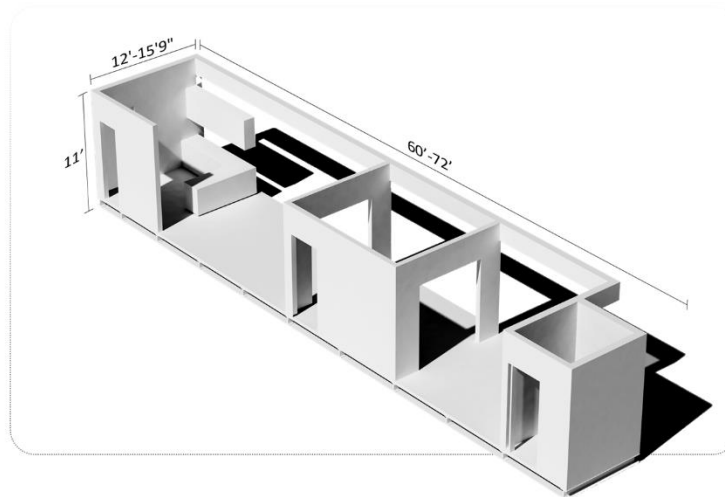



Figure 4.22: The maximum length, width, and height of a module.

The discussions also revealed that there is a real need to have a business in off-site consulting. As was mentioned by interviewee No. 4, most architects currently do not understand how to design for off-site construction and how to optimize it. The role of the off-site consultant, according to interviewee No. 4, should go beyond enabling off-site construction to include the holistic optimization across all elements, not only the fabricated units, for off-site and on-site operations. By way of illustration, Interviewee No. 4 gave an example of something sophisticated like an elevator: there are elevators consultants that help the design team to understand how to design and optimize the project for proper elevator solution.

Interviewee No. 3 added another common design problem: the importance of making sure any custom design—particularly from architects—provides sufficient and adequate details that may help to avoid any delays in the progress of the project. The more details provided earlier in the design phase the better, specifically when an architect requests to work with a new material



such as an innovative cladding system. These details may provide information for what might be a new material or information to the manufacturer or to the parties that will complete some of the on-site work. Interviewee No. 3 said details and information are a key part in any custom design and can assist all parties involved in a single-family modular home project with understanding the installation process and what needs to be completed off-site and on-site.

Interviewee No. 8 agreed with the previous point that a modern custom design will take more time to develop component details for construction and production documents. Additionally, it will take longer to build and improve those components and make sure everything works properly. Conventional and standard designs, according to Interviewee No. 8, are easier than custom designs in terms of developing construction and production drawings since most modular single-family home manufacturers have developed standard packages along with many of the construction details (e.g. truss packages); so when a modular home manufacturer starts working on new conventional or standard design, the engineering team retrieves those details and implements them into the project. However, with custom design it is hard to develop a standard package because custom designs characteristically differ from one home to another.

Interviewee No. 5 and interviewee No. 11 indicated that design coordination among the different teams needs to be improved. Improving design coordination can minimize coordination problems between what is happening in the factory and what is happening on site even though different teams may have construction documents showing all information precisely translated.

A unanimous suggestion was for architects to visit the manufacturing plant before starting to design a single-family modular home to understand how the modular construction method works within the factory, how the assembly line process works, the limitations and the parameters of the modules that can be produced by the factory, and the constraints of transportation and shipping. Interviewee No. 7 stated that when an architect is not familiar with modular construction and submits architectural drawings to a manufacturer for appraisal, it results in the rejection of the submitted drawings for review and redesign.

Interviewee No. 11 added that, in addition to the previous points, architects should be more aware of a factory's capabilities. Each factory has different operating characteristics and manufacturing capabilities. Major design and cost increase problems occur when a custom design home is going to be manufactured by a factory that does not have the production capabilities. Interviewee No. 3 pointed out that modular construction manufacturers vary widely in their production capabilities, technologies, materials, and assembly approaches. Many good

modular home manufacturers encourage architects not only to visit their plant but also to participate during the production details and development phase. Interviewee No. 3 said,

We'll tell the architects we work with particularly if it's the first job, project, they've done with us or with anyone of our manufacturers. We'll say, "Look, if you're willing, if your schedule and arrangements with your client allow, you are welcome to come in this plant while we're producing it so you can watch it progress down the line, not just how it looks in general but your particular project, how it works in general."

As can be seen from the previous discussion, common design problems and issues for modular construction method might be avoided when architects (the design team) work directly with the factory and present their concepts in order to get feedback during the earliest stages of the design process.

4.2.11 Guidelines for Designing for Modular Homes

All interviewees were asked if their companies had developed in-house guidelines (recommendations) for designing when using the modular construction method that can be shared with outside participants. The results indicate that 10 interviewees answered that their companies have not developed guidelines and that two interviewees answered that their companies have developed only in-house guidelines, while the company of one interviewee has developed general guidelines for designing for modular construction which they share with the public online through their website. Table 4.5 below summarizes the Interviewees' answers to the previous question.

Table 4.5: Guidelines for designing for modular homes

Interviewee	No. 1	No. 2	No. 3	No. 4	No. 5	No. 6	No. 7	No. 8	No. 9	No. 10	No. 11	No. 12	No. 13
Yes In-house				•						•			
Yes Sharable					•								
No	•	•	•			•	•	•	•		•	•	•

According to Interviewee No. 3, one of the reasons for the absence of existing guidelines is that many manufacturers believe modular construction is a very simple and quick process to take designers or architects through and to educate them on the basic constraints of transportation,

manufacturing ability (in terms of the size of the modules), and design breakdown (how the design can be broken apart on module boundaries which keeps transportation costs low.

Interviewee No. 5 mentioned another reason behind the absence of existing guidelines for modular construction design as being many manufacturers might fear the process having a sense of limiting architects in what they want to accomplish with their designs. Interviewee No. 5 said, “If you set sort of guidelines or rules, then you would have the architect thinking, ‘I got to draw within blocks, right?’ I do not want to set the guidelines to restrict the architect from his or her free thinking.”

Interviewee No. 9 indicated that when an architect decided to design a project, taking the modular construction method into consideration for the first time, a manufacturer will usually share an AutoCAD version of one of their standard pre-designed modular homes for the architect to use as a reference during the design phase.

4.2.12 Modular Production Process

Typically, a building is a combination of four different main systems, which are structural systems, services systems, finish systems, and enclosure systems, which define the outer and inner surfaces. Most systems start from selecting and then joining different parts in the factory. These parts are typically based upon manufactured materials, panels, components, or modules. Interviewees were asked: What type of industrial development processes does the manufacturing team follow for these four systems? Is it developed entirely in-house; or are some modular components (*i.e.* mechanical, electrical, and plumbing (MEP) systems racks, bathrooms, and kitchen Pods) outsourced to vendor specialists?

The overall response to this question was that there is not much further subcontracting of components in single-family home projects using modular construction method. There is no sub-assemblies that are outsourced to vendor specialists and sent to a modular manufacturer to incorporate, other than what would be typically supplied such as windows, doors, and kitchen and bathroom cabinets by the cabinet factory.

Interviewee No. 9 stated:

The only thing that is made outside is the actual material and components. I can say the only difference between a modular and an on-site built house is where it's all put together. An on-site built house is still modular even though it's built on-site

because all of the windows, doors, cabinets and everything is still made at the factory, we just happen to be putting it here.

Interviewee No. 7 noted that sometimes, if it is a fairly technical system such as sprinkler system or rubber roofing, a manufacturer will bring in a sub-contractor to work in their plant.

Interviewee No. 5 mentioned that single-family home manufacturers should shift from the typical, existing modular production process into new whole-modularization process in which some of the main systems' components might be separated and recombined as sub-modules of the main project modules. Interviewee No. 5 added that there are now plenty of companies specialized in elemental systems such as cladding systems and integrated building services based on MEP racks. Collaborating with such specialized companies might enhance the quality of some systems' components, expedite the process, and competitively improve the manufacturing. Interviewee No. 5 also said that modular home manufacturers should look at these specialized companies as a great opportunity to take the modular construction industry to the next level, otherwise there is a great chance that some of the traditional modular home manufacturers are going to be one of these companies that would go out of business.

4.2.13 Transportation Process

Many modular home manufacturers have a transportation specialist in-house even though they outsource the transportation process to a transport company. Typically, before any drawing efforts, the transportation specialist's job is to verify that the manufacturer can get the modules from the factory (Point A) to the project site (Point B) because if they cannot, the manufacturer will reject the project due to the transportation issue.

Most often the modular home manufacturers has a contract with the transport company: sometimes the builder pays the transport company, but that is very rare. Sometimes the modular manufacturer has its own transport division; however, according to Interviewee No. 11, they may have to set it up as a separate company for financial or legal reasons.

All interviewees indicated that about two to three weeks before the house is ready for transport, the manufacturer contacts the transport company with all the necessary information including shipping date, carrier sizes, dimensions of the modules (widths, heights, and lengths), axle dimensions, and destination. Additionally, all interviewees mentioned that transport companies are responsible for obtaining the local/regional permits and approvals for the transportation phase.



Interviewee No. 1 mentioned that, for safety criteria and to protect a project's components and modules from damage during transportation, the whole module is usually shrink wrapped in plastic. In addition, the shrink wrap creates a waterproof cover.

4.2.14 On-Site Assembly Process

All interviewees indicated that the general contractor joins the project at the beginning in the case of a typical modular home project. As discussed earlier, in most cases the modular manufacturer is a sub-contractor to the builder or the general contractor. Having said that, when an architect is involved, the discussion between the architect and the manufacturer focuses on a design that is compatible with off-site construction, that conversation may start quite a bit earlier than the recruitment and engagement of a general contractor. In many cases it is almost a simultaneous process.

According to the interviewees, the general contractor begins working on the project site's foundation almost right away after receiving the local permit. So all the underground facility and foundation work are being done in the field, while the modular work is performed simultaneously in the factory. Sometimes the general contractor is responsible for putting the modules together, but that is often the responsibility of the modular manufacturer or the set crew company. The set crew could be a different business, not the manufacturer or the builder; it is a specialized company with the necessary skills to coincide with the crane operator to lift the modules from the trucks and set them on the foundations. As soon as they have anchored the building to the foundation, and anchored the different modules to each other, the crew installs a temporary roof. This essentially makes the building weather-resistant so that, if it rains, the modular single-family home would not be damaged. At that point the general contractor takes over which means that the manufacturer has delivered the project to the project site.

4.2.15 Summery and Recommendations

This chapter begins with an explanation of the steps involved in the process of data collection and analysis of the interview data in an effort to better understand the relationships between design and manufacturing processes within the modular single-family homes industry. The aim is to describe and design new communication processes through the analysis of interview data that would be common to the manufactures that would streamline and/or improve their current communication methods. In order to provide the most recent and relevant data for this research, interviewees were chosen for data collection based upon their expert opinions in the

use of modular construction methods. With a total of 13 interviewees, a number of common design problems and issues for modular single-family home construction were identified. The discussions also revealed that there is a real need to restructure the process of communication among all parties involved, from design to manufacturing and ending with the on-site installation of the project.

The interviewees pointed out a number of recommendations for architects and modular home manufacturers working in the field:

- Find a manufacturer who is willing to work with an architect.
- Interviewee No. 2 indicated that it has to be the architect who weighs the options as to whether or not it makes sense to design for modular construction (*i.e.* is the project in an area where labor costs are very expensive? If so, then it might be better to work with modular construction methods for higher quality and lower cost). It is an educational process that an architect needs to go through to understand how modular construction works and what the limitations and parameters are.
- Architects need to understand and be aware of all expenses associated with the modular construction method in urban vs. suburban vs. rural areas. Interviewee No. 2 gave an example that, when designing for modular construction in urban areas, there is a fee that needs to be paid to shut down the streets on the arrival date of the modules. This fee has a huge impact on whether it is going to be cost effective for all parties involved or not, and this is where some of the biggest risk is involved.
- Interviewee No. 3 said the experience that an architect gains spending time in the plant with their project as it is being assembled is also invaluable in the future. The architect can really play a very helpful role in helping work through that definition of boundary between the off-site work and on-site work.
- Interviewee No. 3 added that modular home manufacturers can gain much more by not only helping to educate architects in modular or off-site construction but by also listening to what the architects are trying to accomplish.
- Modular home industry needs to work more often with architects to assist with building homes of higher value, higher quality, and energy efficiency.
- Interviewee No. 5 recommended that architects should check the background of the manufacturer prior to starting any work with them. In addition, the manufacturers should be asked questions such as 1) What are their roles and responsibilities during on-



site installation? 2) Can they share if they have done these types of projects in the past? 3) What is their record regarding the client/architect/builder satisfaction? 4) What is their status within the industry? 5) Who are their competitors?

- Interviewee No. 6 said the biggest problem the modular home industry has is that they have not, until recently, been able to agree with the need to promote the industry as a whole and not as a company's brand and how modular homes are an advantage to the architects.
- Interviewees No. 7 and No. 8 mentioned the need for marketing through education. They said architectural schools can play a major role in expanding and developing the modular home industry by educating young architecture students' in modular construction as an advantageous alternative to site-built construction.

5. The IDM Framework

5.1 Introduction

There are two primary aims of this chapter: 1) to map an “As-is” design and manufacturing process as they relate to manufactured single-family housing, and then 2) to propose a “To-be” framework (model). The interview data analyzed in the previous chapter will be used to map and then develop the framework, which is mostly concerned with the design and manufacturing phases, with information about transportation and on-site installation. Capturing and structuring information as a process will support the anticipated results from this research. The anticipated framework could assist architects in understanding how to begin with a process and system that progresses from the design stage, moving to manufacturing then to transportation, and finally ending with the on-site assembly of the project by addressing issues of fabrication and modular construction early during the design process. Additionally, the anticipated framework may improve the understanding of the barriers and constraints between architectural design and modular construction for the residential building sector.

5.2 The Framework Development Process

The framework development described in Chapter 3 will be performed through two main phases including the following:

- **Framework Development:** This phase starts with the coding process, based upon the gathered data and information, and continues by evaluating, capturing, and structuring knowledge. Two drafts of framework structures will be developed based upon the collected data. First, an “As-is” design-manufacture process model within the modular housing industry will be created. Second, a “To-be” framework (model) for the prefab industry will be developed. The proposed framework will be presented using The Integration Definition Function Modelling (IDEFo) technique as a graphical language.
- **Framework Demonstration:** Both “As-is” and “To-be” frameworks will be presented to a number of previous interviews’ participants within the manufactured single-family housing industry and then a consensus will be reached regarding the proposed framework. The framework will then be completed based upon stakeholders’ feedback and comments.

5.3 Integration Definition for Function Modeling (IDEFo)

As was pointed out in section 3.7 of this research, the Integration Definition (IDEF) for Function Modeling will be used as a graphical presentation technique. The goal of using such a graphical technique was first, to understand and analyze the functions of the existing (As-is) design-manufacture communication process; and second, to enhance and improve the communication and productivity performances (To-be) among people working in the design, manufacturing, and production sectors.

The IDEFo method is considered one of the most recognized and used graphical modeling techniques of the IDEF family in the government, industrial, and commercial sectors (Force, 1993). Generally, IDEFo is a very simple technique to use and is easy to understand. This means using such a graphical modeling method can assist with mapping the entire work and activity system including organizations, teams, decisions, actions, and activities. The nature of the IDEFo method may also facilitate the development and modification process of an existing system rapidly and accurately (Austin et al., 1999).

The table below illustrates some of the main characteristics of the IDEFo function modeling language (Force, 1993).

Table 5.1: IDEFo characteristics (Force, 1993)

-
- *It is comprehensive and expressive, capable of graphically representing a wide variety of business, manufacturing and other types of enterprise operations to any level of detail.*
 - *It is a coherent and simple language, providing for rigorous and precise expression, and promoting consistency of usage and interpretation.*
 - *It enhances communication between systems analysts, developers and users through ease of learning and its emphasis on hierarchical exposition of detail.*
 - *It is well-tested and proven, through many years of use in Air Force and other government development projects, and by private industry.*
 - *It can be generated by a variety of computer graphics tools; numerous commercial products specifically support development and analysis of IDEFo diagrams and models.*
-

In order to use the IDEFo method, a set of rules and instructions (Syntax) governing the arrangement of the modeling language need to be followed. The IDEFo syntax is based upon four main components which are boxes, arrows, rules, and diagrams. Table 5.2 presents an overview of the syntax rules for both the boxes and the arrows (Force, 1993).

Table 5.2: Syntax rules (Force, 1993)

Boxes
<ul style="list-style-type: none"> • Boxes shall be sufficient in size to insert box name. • Boxes shall be rectangular in shape, with square corners. • Boxes shall be drawn with solid lines.
Arrows
<ul style="list-style-type: none"> • Arrows that bend shall be curved using only 90 degree arcs. • Arrows shall be drawn in solid line segments. • Arrows shall be drawn vertically or horizontally, not diagonally. • Arrow ends shall touch the outer perimeter of the function box and shall not cross into the box. • Arrows shall attach at box sides, not at corners.

As mentioned in Chapter 3, the IDEF0 approach has three types of information: graphic diagram, text, and glossary. Boxes and arrows are commonly used to represent the graphic diagram. Each activity in the process is demonstrated by a single rectangular box surrounded by arrows from each side of the box. These arrows symbolize the Inputs, Controls, Outputs, and Mechanisms (ICOMs). Each arrow can be identified based upon which side of the activity box it is touching. Input enters the right side of the activity box while output exits the left. Control enters from the top of the box while mechanism enters from the bottom. As shown in Figure 5.1, there are six elements that define the IDEF0 functional model: the box representing the activity; the arrows representing the ICOMs; and the activity number at the right lower corner side of the box (Presley and Liles, 1995).

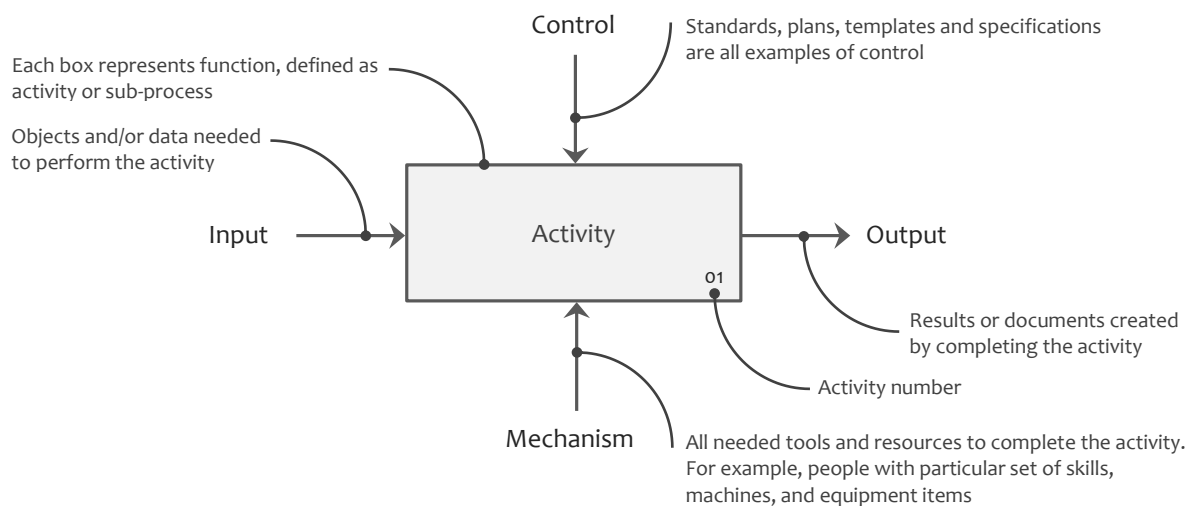

Figure 5.1: IDEF0's graphical format (box and arrows).

5.3.1 Types of IDEF0 Diagrams

There are three types of IDEF0 functional diagrams: 1) the top-level diagram, 2) the parent diagram, and 3) the child diagram. The IDEF0 approach has a number of attractive features, one of which is the hierarchical nature of the diagrams. This means a top-down flow of information can be achieved to represent data not only from one organization but from more than one organization. Another attractive feature is the consistency of the diagrams which make them very easy to check.

5.3.1.1 Top-Level Diagram

The analysis of information starts from the top-level diagram in the model which represents the general or abstract description of the activity. In modular home industry there are four main activities: 1) design process, 2) manufacturing process, 3) transportation process, and 4) on-site assembly process. Each one of the previous activities represents the top-level context diagram (subject) within a single box and the ICOMs arrows. Furthermore, each single activity or process can be decomposed from the level one box into a number of sequential activities in lower-level boxes that have been generated from the top-level box; also it can state whether they are linear or nonlinear approaches (Barton, 2012).

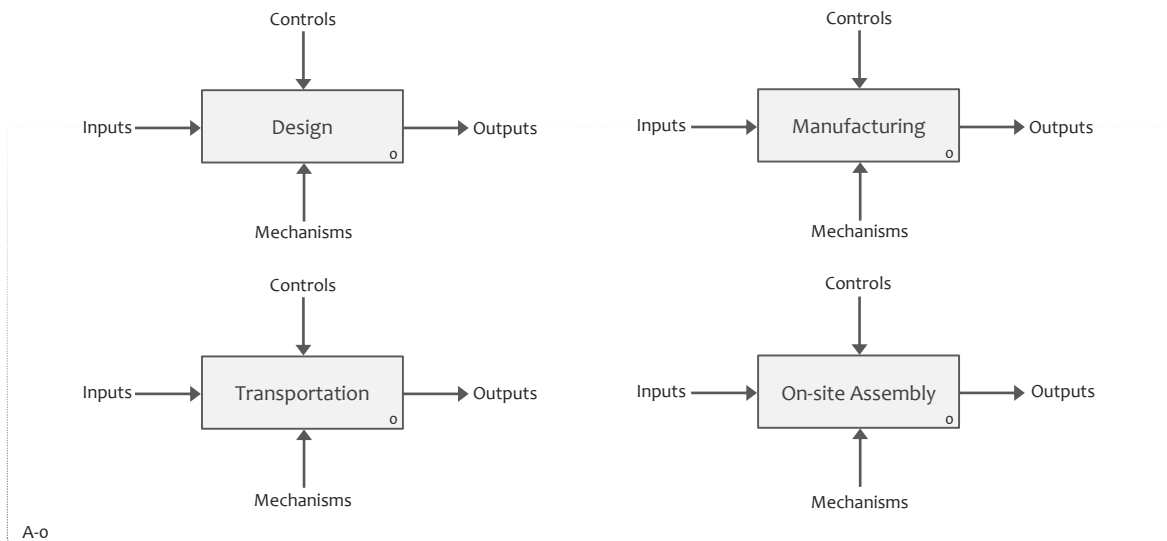

Figure 5.2: IDEF0 top-level context diagram.

The IDEF0 model, as seen in Figure 5.2, is based upon the four major modular home industry processes at the top-level stage of each activity. The model, at this level called an A-o diagram, also indicates the node number. The node numbers system will be explained further next.

It is important to understand the different characteristics between the IDEF0 diagrams and boxes which can be classified into four main types: 1) a parent diagram generally encloses parent boxes, 2) a child diagram is typically decomposed from a parent box, 3) a parent box can be decomposed (or exploded) into more detailed levels of analysis by a child diagram, and 4) a child box can be used to model relationships among different activities (child boxes) on a child diagram.

5.3.1.2 Parent Diagram

It is necessary here to clarify exactly what is meant by “parent diagram.” A parent diagram is an activity where data is analyzed and passed on to perform the next subsequent activities of the whole process. A parent diagram can be one or more parent boxes. In this research, the IDEF0 model is composed of four main parent boxes, which are: 1) design, 2) manufacturing, 3) transportation, and 4) on-site assembly processes. Since the top-level diagram (single box) is considered level-one, the parent diagram is part of the next lower-level and considered the second level. The model at this level is called an A-0 diagram as shown in Figure 5.2.

5.3.1.3 Child Diagram

A child diagram is a sub-activity and might be defined as a branch (lower-level) of the main activity (the parent diagram or box). This definition highlights the hierarchical relationship between a parent box and the child diagram that provides additional details of the main activity (Figure 5.3). Each child diagram can then be decomposed into another lower-level child diagram. Typically, other than the top-level (single-box) context diagram, there are a minimum of three, and a maximum of six, boxes in any level of IDEF0 functional diagrams. It should be noted that the outputs of each activity box are the inputs or controls of the next activity box (Ang et al., 1995, Force, 1993).

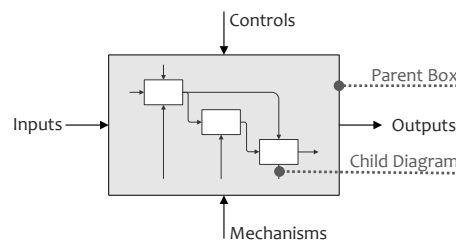

Figure 5.3: The relationship between a parent box and child diagram.

One of the main IDEF0 rules is to organize the boxes from the upper left to the lower right corner in a diagonal direction. There is a node number for every diagram, once a parent box is decomposed into a lower-level child diagram, the new node number is based upon the

combination numbers of the parent diagram and the decomposed box. For illustration, Figure 5.4 presents the IDEF0 decomposition structure between the main four parent boxes within a parent diagram and child diagrams.

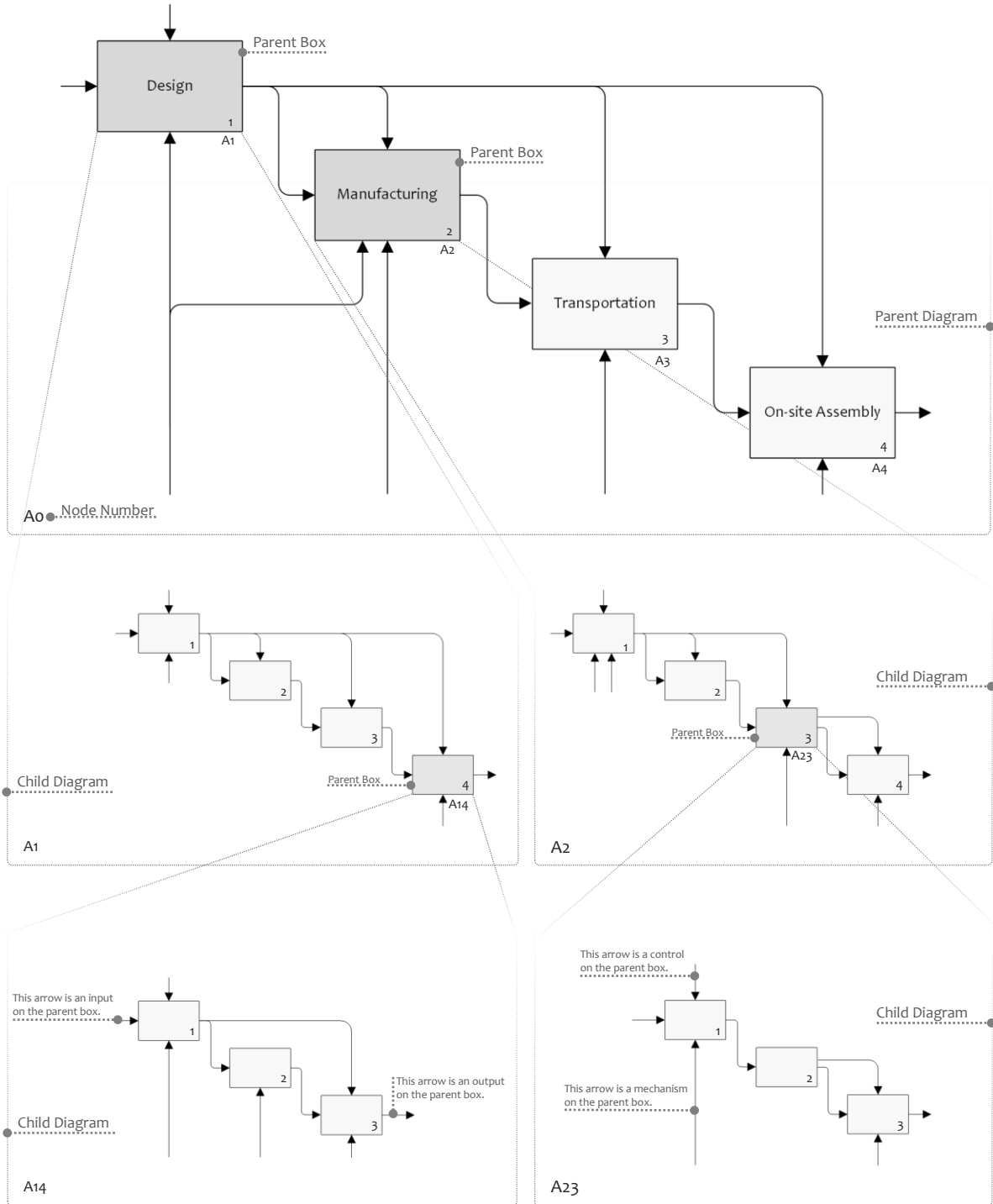

Figure 5.4: IDEF0 decomposition structure.

5.4 Mapping the “As-is” Framework

One of the main objectives in this research, mentioned earlier in Chapter 1, is to map the existing “As-is” framework and then propose a “To-be” framework as it relates to the design and manufacturing processes of modular single-family housing industry. Yet, it is important to point out the main activities of each of the different phases from the beginning design stage to the on-site installation of the project.

There are many ways to introduce the main activities. Most well-known manufacturers for modular single-family housing, however, appear to follow six phases in their practice, which are:

- **Phase 01| Design:**
 - Pre-Designed Floor Plans
 - Schematic Design (SD)
 - Finishes Selection
 - Design Development (DD)
 - Purchase Order
 - Construction Documents (CD)
- **Phase 02| Coordination:**
 - Deposit
 - Engineering Coordination
 - General Contractor Coordination
 - Permits and Approvals
- **Phase 03| On-site Construction:**
 - Site Development
 - Foundations

As mentioned previously in Chapter 4, most good modular manufacturers will not start constructing the modules until the foundation is built on-site and checked to match their modules’ production drawings, because it could technically not match up.

- **Phase 04| Off-site Construction:**
 - Framing components
 - Installation of windows and exterior doors
 - Roofing
 - Rough electrical
 - Rough plumbing

- Rough HVAC
- Insulation
- Drywall
- Interior doors installed
- Install molding
- Painting
- Installation of bathrooms
- Installation of kitchen cabinets and countertops
- Installation of siding

There are around 45 steps for this phase. A more detailed description about off-site construction steps will be presented later in this chapter.

▪ **Phase 05| Transportation:**

- Load module on carrier
- Set crew
- Module installation

▪ **Phase 06| On-site finishes:**

- Install finish electrical
- Install finish plumbing
- Install finish HVAC
- Carpet and flooring
- Finish painting (Touch up)
- Hookup to water main
- Hookup to sewer
- Site Restoration
- Final inspection
- Move-in

According to the interviewees, the typical building timeframe for a modular single-family home project is between 18 to 24 weeks. Since most of the construction occurs off-site in a controlled environment plant, the work schedule is commonly accurate because is not dependent upon weather conditions, whereas the work schedule can be delayed for both of the on-site phases based upon the weather conditions. Project approval times needed for both state and local authorities is considered another factor that could cause delay during the coordination phase process.

Figure 5.5 below presents an overview of a typical modular construction timeline for a single-family home.

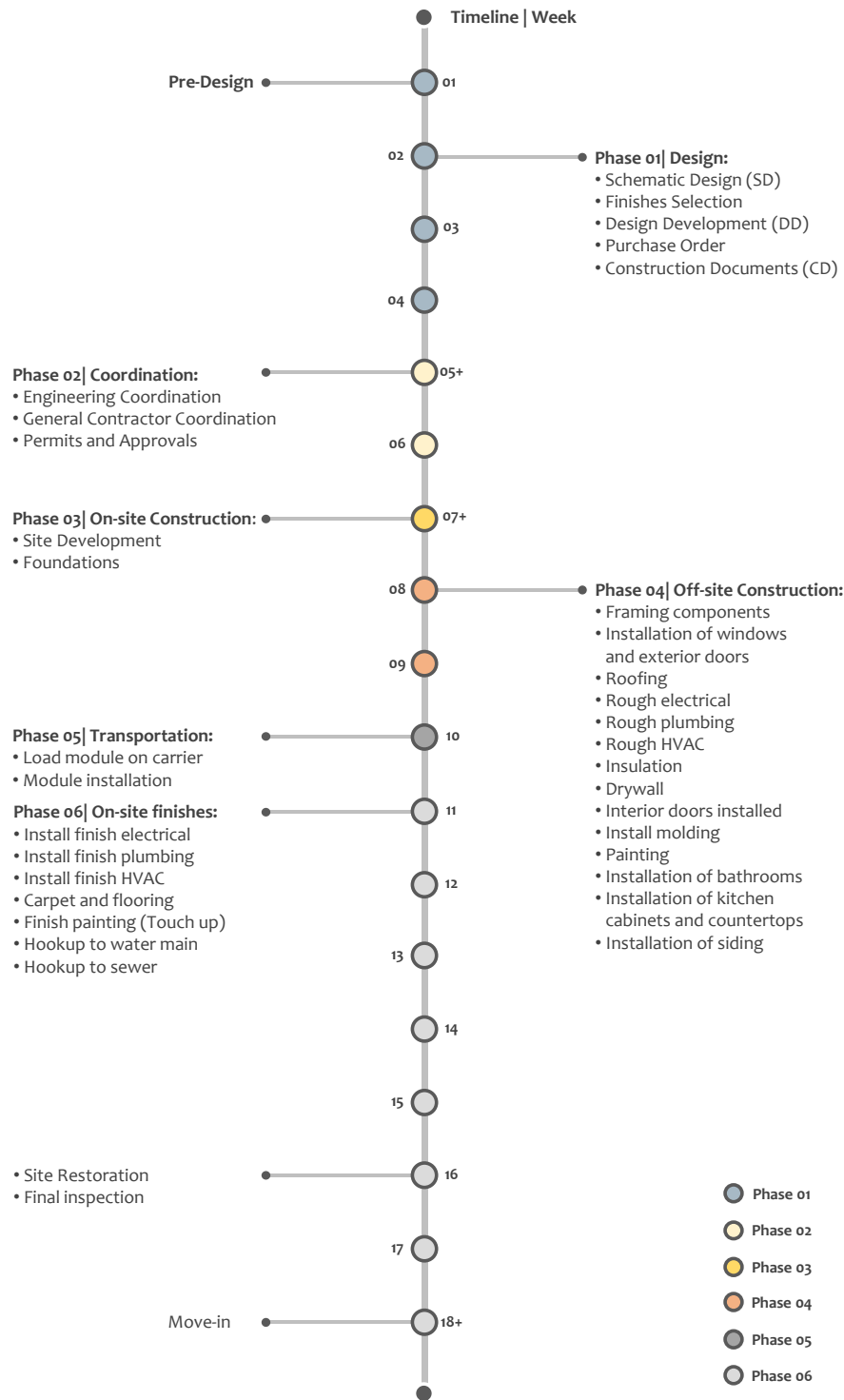

Figure 5.5: Modular home building timeline.

5.4.1 The Overall Modular Construction Process

The aim of this section is to map the overall activities and flows of information in the single-family home modular construction industry, based on the IDEFo modelling method. The information of the main (parent diagram) and sub-activity models (child diagrams) was developed according to the collected information from all interviewees from the previous chapter.

As can be seen in Figure 5.6, there are four main activities within the modular construction industry representing the overall model (parent diagram) and its flows, which are: 1) design, 2) manufacturing, 3) transportation, and 4) on-site assembly processes. However, as mentioned previously, the sub-activity models (child diagrams) focus on the design and manufacturing activities and their interrelationships, main participants, and the flow of information among them. Below are the list of detailed sub-activity models which will be discussed next:

- The conceptual design process
- The design development process
- The production process

The first two sub-activity models are considered lower-level diagrams (child diagrams) of the top-level design activity (parent box); whereas, the last sub-activity model is considered the lower-level diagram of the top-level manufacturing activity (parent box). The node number as shown in Figure 5.6 is (A0) which represents the parent diagram.

As is shown in the overall modular construction process (Figure 5.6), the IDEFo model starts with the design activity moving to manufacturing activity through transportation activity and ending with on-site assembly activity. Each activity has a number reference at the bottom-right corner of each activity box that can be used to represent a lower-level sub-activity or process. In order to start the design activity, the client's design requirements input is needed first. The main control characteristics during the top-level (A0) are:

- Pre-designed floor plans
- Estimated cost
- Time schedule
- Building and construction codes

The main participants (mechanisms) during the design activity are:

- Builder
- Sales representative

- Engineering manager
- Engineering team

It is important to know that the outputs of each activity are the inputs or controls of the next activity.

Manufacturing activity is normally carried out directly after the design activity is completed. In this phase, the main participants (mechanisms) are:

- Engineering team
- Plant manager
- Factory floor workers
- Quality control inspector
- Third-party inspector

During the manufacturing process, the physical quality of the project will be determined by a quality control inspector. Most modular home manufacturers have a quality assurance department in-house to monitor the execution process through different stations of the production line and ensure that they meet production standards. Additionally, there is a third-party inspection agency that is certified by the state to ensure building quality and code compliance and standards at the state level. More details about manufacturing activity will be discussed later in (A2) sub-activity diagram (Figure 5.9).

Once all off-site activities are completed, the transportation activity will follow the requirements from the contract and time schedule to deliver the modules to the on-site location. The main participants and equipment items needed during this activity (mechanisms) are:

- Flatbed trailers
- Transportation sub-contractor

All of the underground facility and foundation work should be completed before the arrival of the modules. Once the modules arrive at the project's site, the on-site assembly activity begins with the crane operator lifting the modules from the trucks and setting them on the foundations. The main participants during this activity (mechanisms) are:

- Set crew
- General contractor
- Local building inspector

After the general contractor completes all on-site connections and finishes, the modular home will again be inspected by a local building inspector for final approval.

5.4.2 The Conceptual Design Process

The (A1) IDEF0 model, shown in Figure 5.7, is composed of four activities representing the child diagram of the design activity (parent box). Number 1 next to the letter A refers to the design box number in the parent diagram (A0) as can be seen in Figure 5.6. All four activities in this phase focus on the conceptual design and are handled by four different people:

- Builder
- Sales representative
- Engineering manager
- Engineering team

The first conceptual design activity (initiation) typically begins with a meeting between a client and a builder to discuss the design requirements and needs of the client's future modular home. The main tasks that the builder needs to assist the client with are:

- Pre-designed floor plans
- Selection of finishes

Once the sales representative receives the required information regarding the project from the builder, the second conceptual design activity (brief) starts. A preliminary pricing proposal, based upon the client's requirements, is prepared by the sales representative and sent to the builder for client's review.

As soon as the sales representative receives the client's acceptance of the preliminary pricing proposal from the builder, the third conceptual design activity (design instructions) begins. A meeting takes place between the sales representative and the engineering manager to discuss the design requirements. The first main task for the engineering manager during this activity is ensuring that the project can be manufactured and delivered to the site location based upon the state and local standards and regulations.

The fourth conceptual design activity (preliminary drawings) starts after the engineering manager determines that the project can be completed successfully with high efficiency. The engineering team then prepares preliminary drawings that follow the design instructions and requirements received from the engineering manager. After the preliminary drawings are generated, the engineering manager sends them to the sales representative, who passes them to the builder for client review and approval. As can be seen in Figure 5.7, if the client has some comments regarding the design, the drawings go through that same chain of process for revision. Once the client approves the preliminary drawings, the process moves into the design development phase.

5.4.3 The Design Development Process

The (A14) IDEF0 model for the design development process, shown in Figure 5.8, is composed of four activities representing the child diagram of the conceptual design activity (preliminary drawings). Number 4 has been added to the previous diagram node number A1 to refer to the decomposed box number, as seen in Figure 5.7, and also provides a direct indication that when the diagram nodes have two digit numbers, it means those nodes are second-level diagrams. The engineering team, during this phase, develops the preliminary drawings into a formal architectural set of drawings that includes:

- Architectural drawings
- Structural drawings
- Mechanical, electrical, and plumbing services (MEP) drawings
- Construction documents (CDs)

The main control requirements to start the design development process are:

- Purchase order
- Deposit
- Building and construction codes

As mentioned earlier, when the client approves the preliminary drawings, the builder should sign a contract with the client and send a purchase order to the manufacturer. Additionally, the client must pay a deposit on the cost of the home. All four activities in this phase are mainly managed by the engineering team, and they are responsible to follow the state and local building and construction codes. Figure 5.8 illustrates that the outputs of architectural drawings, structural drawings, and MEP drawings activities are the inputs of the construction documents activity. The main participants beside the engineering team during the construction documents activity are:

- General contractor
- Builder
- Third-Party Consultant

The engineering team are typically, as mentioned in the previous chapter, technical drafters and a part of the factory; thus, the next step is to send project documents to a third-party consultant for revision. Any comments received from the third-party consultant are updated and corrected by the engineering team. After CDs are completed, reviewed, and approved by state and local authorities, the production process is started next.

5.4.4 The Production Process

The production process (A2) IDEF0 model, shown in Figure 5.9, integrates four activities representing the child diagram of the manufacturing activity (parent box). Number 2 next to the letter A refers to the manufacturing box number in the parent diagram (A0) as seen in Figure 5.6. These four activities are:

- Production drawings
- Structural systems
- Services systems
- Finish systems

Once the permits are obtained, the house is released for production. The engineering team then will generate all the production drawings such as specific dimensions for wall framing, roof framing, and details about electrical, plumbing, and interior and exterior finishes instructions. The main control requirements to begin the production drawings activity are:

- Production standards
- Quality control manual
- Safety standards
- Time schedule
- Purchasing of materials

After finishing the production drawings (along with purchasing the required materials to build the project), the production process of the home starts and is put into the production queue. The production line is based upon three main stations: 1) structural, 2) services, and 3) finish systems. The main participants, beside the engineering team, during the production process activity are:

- Materials manager
- Plant manager
- Factory floor workers
- Quality control inspector
- Third-party inspector
- Builder
- General contractor

Figure 5.9 shows the output of the production drawings activity feeding inputs into the next three main activities.

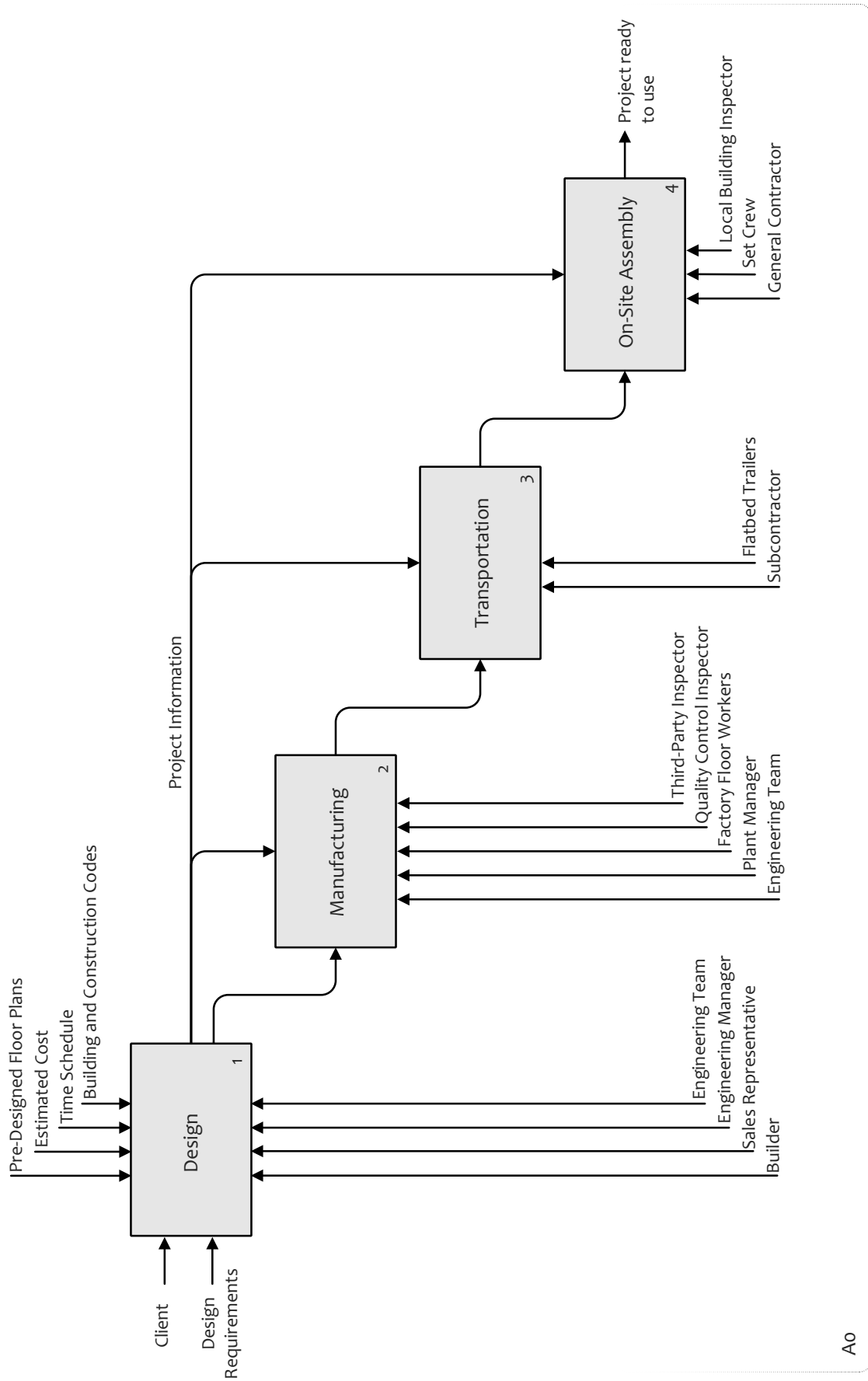

A0

Figure 5.6: The overall modular construction process.

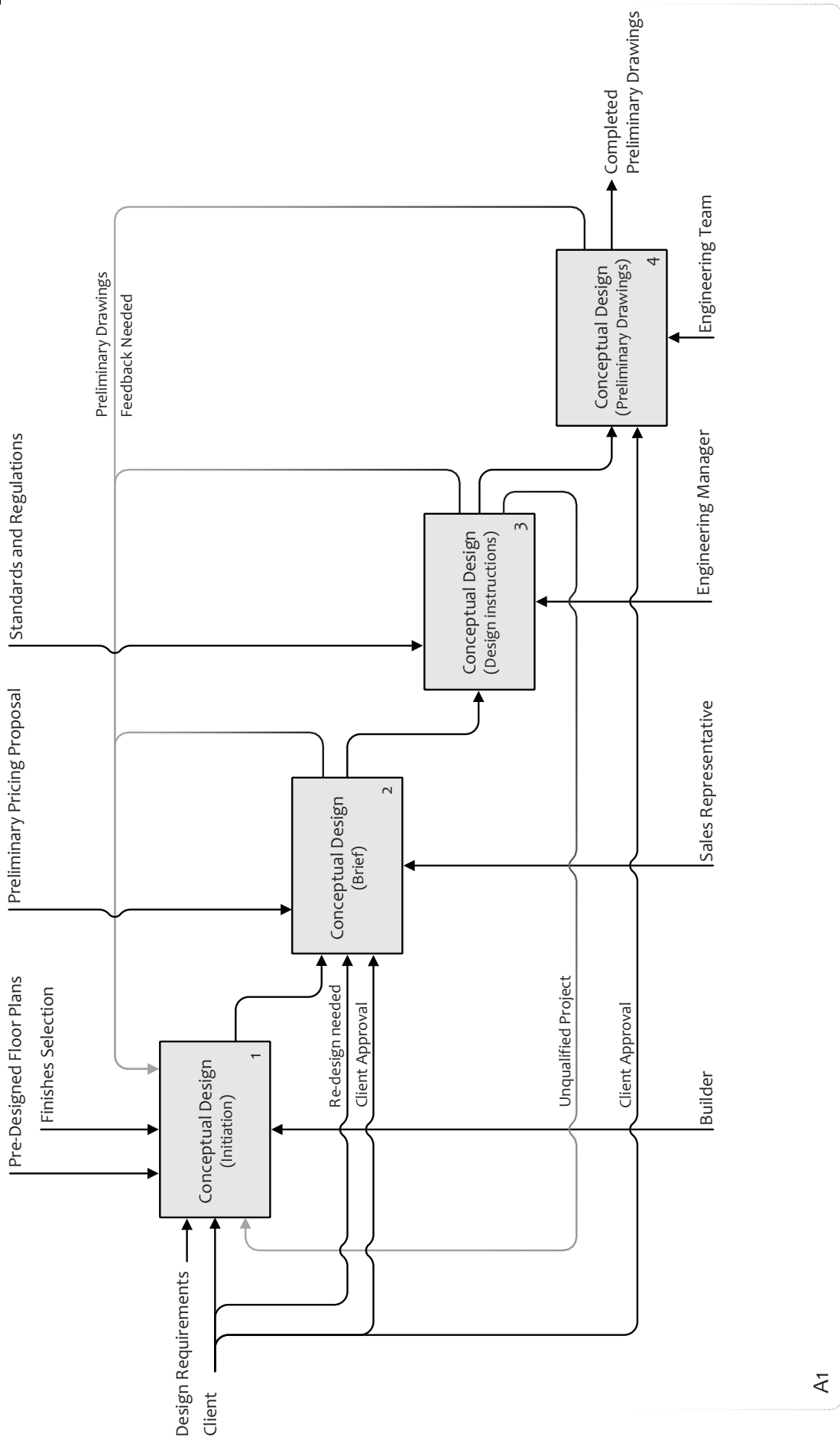

Figure 5.7: The conceptual design process.

A1

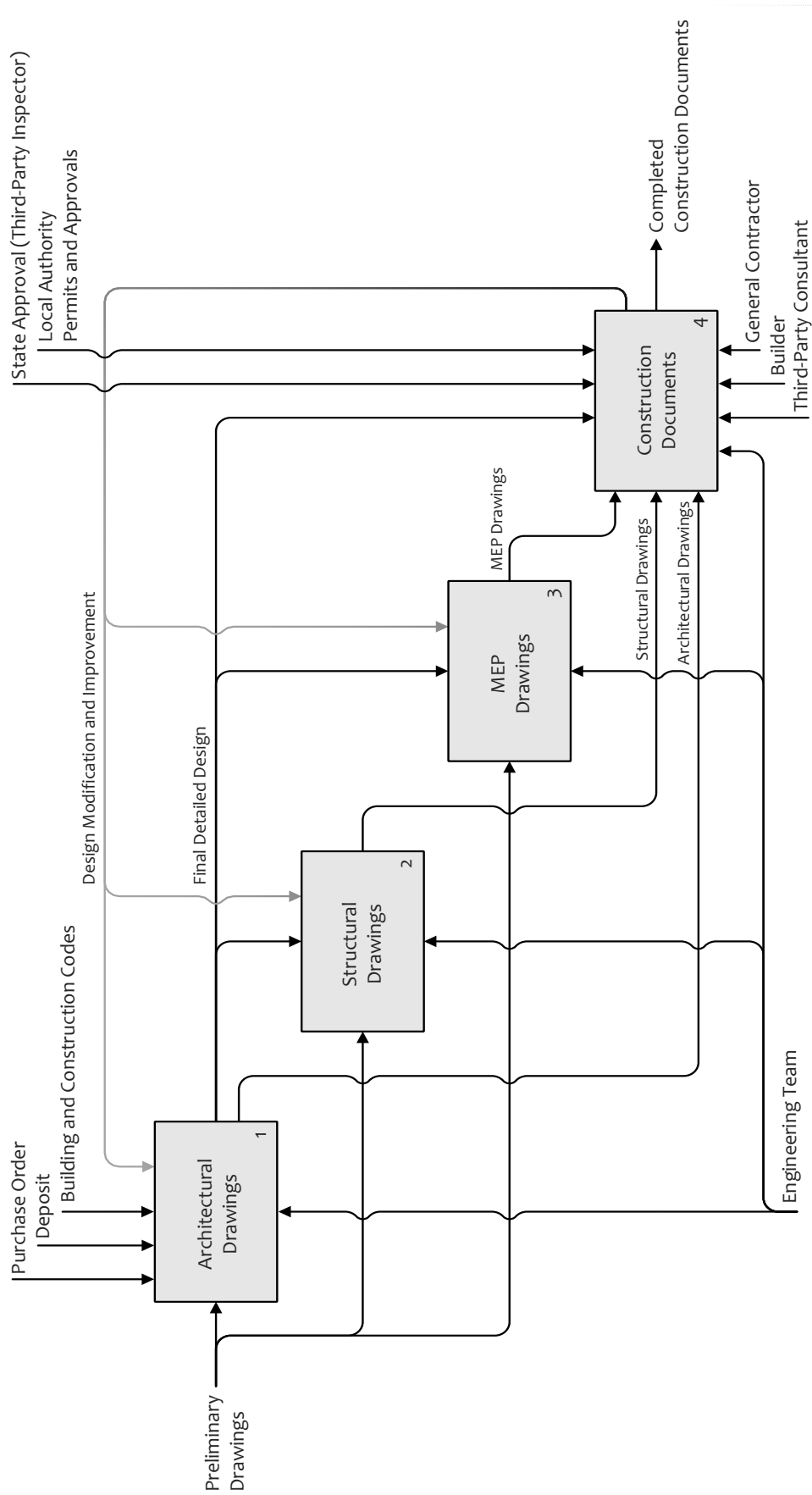

Figure 5-8: The design development process and construction documents phase.

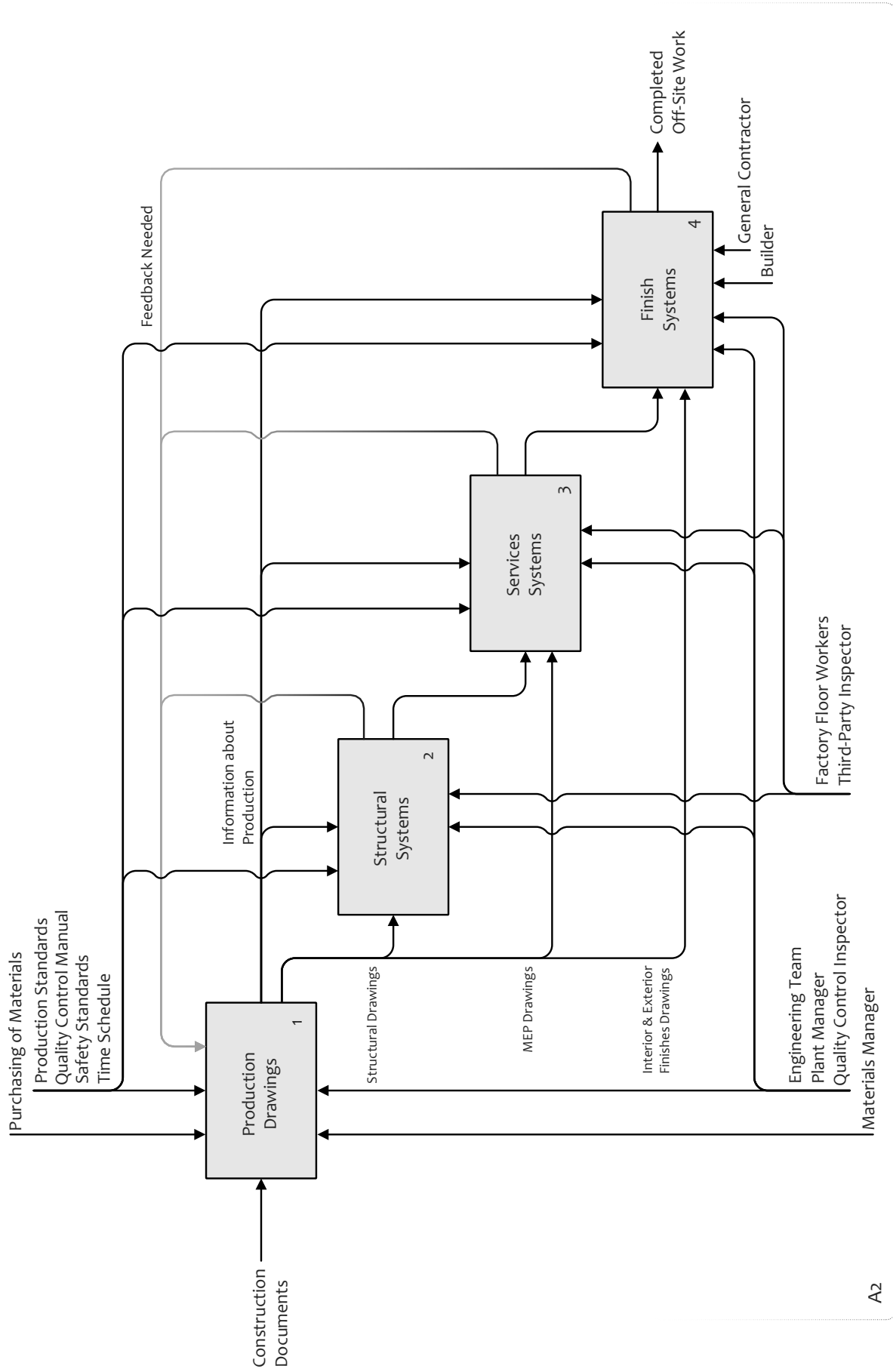

Figure 5-9: The production process.

A2

5.5 The “As-is” Framework Related Issues

As was pointed out in the introduction to this chapter, mapping the “As-is” framework for design and manufacturing processes could assist in understanding how the single-family home modular construction industry begins with the design process, through communication and information flow among different teams, and ends with manufacturing the project. Such a framework also could assist by bringing in issues of fabrication and modular construction earlier during the design process.

5.5.1 Lack of Architect Involvement

Through the previously demonstrated “As-is” IDEFo models (the overall modular construction process, the conceptual design process, the design development process, and the production process), it was shown that the architect is not involved in the entire design and manufacturing processes.

All modular manufacturers have developed a number of standard single-family home floor plans with limited design options. Most of these plans focus only on the functional configuration such as living area, dining room, kitchen, bedrooms and bathrooms. Almost all of the pre-designed floor plans are traditional in style. Aside from the lack of aesthetic appeal, the façade is a combination of pitched roofs and different materials with limited siding options. Another issue with the pre-designed home is that the bottom and tops of the doors and windows, most of the time, are not lined-up across the entire façade. Also, pre-designed floor plans do not include exterior on-site construction work such as garages and porches.

In his book, *The Complete Guide to Factory-Made Houses* published in 1984, Watkins listed and discussed 22 common design issues in most pre-designed modular homes. Table 5.3 below provides the main challenges and limitations as stated by Watkins.

Table 5.3: Common pre-designed single-family modular home issues (Watkins, 1984)

-
- *No separate entranceway or foyer to receive visitors.*
 - *No opening in the front door, or no window or glass outlook alongside that lets you see who's at the door.*
 - *No roof overhang or similar protection over the front door for shelter from rainy weather.*
 - *No direct access route from the driveway to the kitchen.*
-

-
- No direct route from outdoors to bathroom so children can come in and out with minimum of bother and mud-tracking.
 - Gas, electric, and water meters inside the house or in the garage or basement, rather than outside. Outside meters do away with the need to let meter men in every month.
 - Fishbowl picture window in the front of the house, exposing you to every passerby.
 - The nightmare driveway that opens out on a blind curve so you cannot see oncoming traffic when backing out. A driveway that slopes up to the street is almost as bad, especially for trapping you hopelessly on a winter morning when your car won't start.
 - Isolated garage or carport with no direct or protected access from car to house.
 - Accident-inviting doors that open toward the basement stairs.
 - Cut-up rooms with windows haphazardly located. Sometimes too many doors make it impossible to arrange furniture.
 - Windows in children's rooms that are too low for safety, too high to see out of, and/or too small or difficult to get out of in case of fire.
 - A hard-to-open window, usually the double-hung type, over the kitchen sink. An easily cranked casement window is usually best here; a sliding window second best.
 - A window over the bathroom tub. This generally causes cold drafts as well as rotted windowsills as a result of condensation.
 - Stage-front bathrooms placed squarely in view of a space like the living room or smack in view at the top of the stairway. Ideally, one should be able to go from any bedroom to the bathroom without being seen from another part of the house.
 - Only one bathroom, especially tough on you in a two-story or split-level house.
 - No light switches at every room entrance and exit.
 - No light or electrical outlet on a porch, patio, or terrace.
 - No outside light to light up the front path to and from the house.
 - Noisy light switches that go on and off like a pistol shot. Silently operating switches cost only a little more, and no new house can be called modern without them today.
 - Child-trap closets that cannot be opened from inside.
 - Small economy-size closets that are hardly big enough for half your wardrobe. Also watch out for narrow closet doors that keep half of the closet out of reach without a fishing pole, basket-ball-player shelves too high for a person of normal height, and clothes poles so low that dresses and trousers cannot hang without hitting the floor.
-

Speaking about the traditional pre-designed single-family home floor plans, Interviewee No. 12 commented:

Most people look at designing a home this way, sort of just build something, add rooms together like in a box and they call it a home. So, very few people go beyond that. It is a very strange economy that exists in the society. Space is very much undervalued in some ways. Some people appreciate it. Most people don't like building smaller; everything has to be big, so people prefer to build huge. I think that's going away a little bit. People don't really want to pay for it. People think they're getting a deal by hiring a builder, but they don't know what they're paying for. With the architect, people can get a deal, but it's all based on the additional cost that goes on top that they think they could save by not hiring an architect. And, if people don't give priority to what the home looks like (and they think they do), then it's a problem. Nobody can make their own computer or their own software but everybody can design their own house. So they will pay for their computer but when it comes to their house, they know how to do it. So this is unfortunately one of the major problems.

Interviewee No. 12 also added that the majority of modular single-family home manufacturers try to avoid working directly with architects by raising the cost. Many modular producers believe having an architect involved might slow down the design and manufacturing processes. When Interviewee No. 12 contacted a modular factory for a preliminary pricing proposal on a new project, the cost was much more than what the builder offered for the same project. Interviewee No. 9 specified that a builder who buys more traditional houses and builds more typically receives a better price from modular manufacturers than an architect would be quoted for his/her client on one project.

Most home buyers consider a non-standard design floor plan a very important factor for their future new home design. Until recently, most modular manufacturers focused only on the efficiency of their production line and very little, if at all, on the quality of the design. Limited design variation has been cited as an issue for modular manufacturers. Architects can play a major role when it comes to the quality of design.

Interviewee No. 12 specified that most modular factories are based upon a production line with different stations as another issue related to customization and flexibility, saying,

Each station has a number of people [even] if you want to leave any of those stations out. For example, if you don't want to put the window or you don't want to put the kitchen in, you still pay for the kitchen because those people are sitting there, so if they are not used you can't speed it up, you can't take it out of the sequence, so that sequence is stuck there—is a box sitting there empty. These people are not working, but you're paying for their time. You can't even say I'm going to install an expensive kitchen in the factory, you can't do that because you're stuck with the modular manufacturer's system. If you put the kitchen in, or you don't put it in, you're paying for it. You're not paying for the material, the material is not the big cost: usually it's the labor—that's the big cost.

In his book, *Architect? A Candid Guide to the Profession* published in 2001, Lewis pointed out specific aptitudes that most well-trained architects can provide to their clients (Table 5.4).

Table 5.4: Essential skills for an architect (Lewis, 2001)

• <i>Graphic and visual skills</i>	<i>The ability to see and to express things in graphic form.</i>
• <i>Technical aptitude</i>	<i>Proficiency in mathematics and scientific analysis (Not necessarily in a particular science).</i>
• <i>Verbal skills</i>	<i>The ability to read, write, and speak, to organize or analyze effective verbal expression.</i>
• <i>Organizational skills</i>	<i>The ability to analyze and synthesize, to create order and direction out of disorder and chaos.</i>
• <i>Memory</i>	<i>The ability to store and recall information, images, or ideas.</i>
• <i>Compositional talent</i>	<i>The artistic ability to compose aesthetically successful visual form in two and three dimensions.</i>

Most homes that are well-designed by architects are based upon a set of activities and tasks, such as thinking, drawing, analyzing, organizing, rationalizing, crafting, and visualizing. The quality of exterior and interior appearance, the proper exterior and interior elements and shape proportions, and textures and material usage, are all results of diverse skills commonly provided by good architects.

As seen from Figure 5.10 (below), the house is a combination of architectural sophistication and simplicity. The architect plays on the contrast between the internal walls' color and the open glazed surfaces. The spacious living room with double-height, fully-glazed surfaces offers generous views over the surroundings.

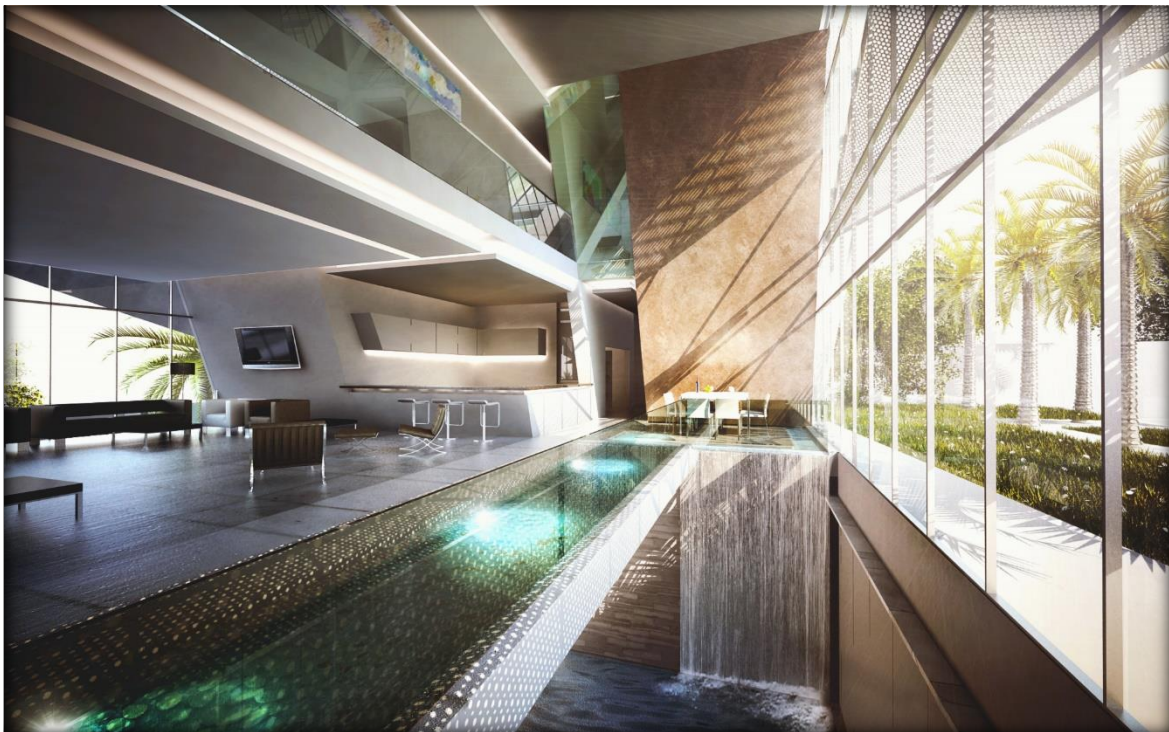

Figure 5.10: The quality of space extends the usable surface of the house (FA Consultants, 2014).

To enhance the quality of design, it is important to improve the relationship between architects and modular single-family home manufacturers. Such an improvement could also increase the market share of the modular housing market by developing new design processes, features, and various different options that might not be viable within the traditional method of modular home construction.

5.5.2 Direct Communication Challenges

To enhance and improve the communication and analysis performances among people working in the manufacturing and production sectors, it is important to point out some of the communication issues within modular single-family home manufacturer companies:

- Lack of advanced technologies utilization
- Limited information flow from design to the manufacturing phase
- Off-site manufacturing and on-site installation-related communication issues

Presently, with the ability to exchange information between CAD/CAM/CNC technologies, the design and manufacturing processes for modular housing need to evolve. However, almost all of the modular construction industry interviewees in this research indicated that they are still working with only two-dimensional graphical representation programs. More details about advanced technologies utilization within the modular housing industry have been discussed in the previous chapter.

The process of information gathering and analysis is one of the most important steps before design begins. The previous Figure 5.7 illustrates a sequential process to deliver the design requirements through different departments during the conceptual design process. There is no direct interaction between the client and the engineering team during the design phase. All communications regarding design go through the builder first, to the sales representative next, then to the engineering manager, and finally to the engineering team. The point here lies in the importance of providing information that will contribute effectively toward translating user needs and requirements to facilitate the process of communication among all teams involved, from design to manufacturing.

Speaking about the process of communication during the conceptual design phase, Interviewee No. 3 commented:

I've become convinced that one of the largest obstacles to the wider adoption of "off-site" construction is the incompatibility of the "languages" used by those who design buildings, the "languages" that have been evolved by modular manufacturers, and the language used in common construction bidding.

It is very important to initiate organized platforms of communication within the modular housing industry such as Building Information Modeling (BIM). BIM has advanced the technology of information sharing and collaborative design. This enhanced collaboration can

assist with moving modular housing projects to the next level of integration by connecting architects, engineers, manufacturers, fabricators, and contractors.

Another problem with poor communication would be failing to take the design quality aspect into account. Quality should be managed not only during the off-site construction phase, but also throughout the on-site assembly phase of the project. Perhaps the most disadvantageous aspect of the sequential modular construction process for single-family homes is problems occurring as a result of the poor communication between the builder and the local contractor. The builder (representing the manufacturer) is typically responsible for the first half of the house (off-site manufacturing), while the local contractor is responsible for the second half of the house (on-site installation). Interviewee No. 12 said,

That's probably the trickiest part of modular construction because, in construction, you want one guy to be 100% responsible, otherwise you get blame shift. By having these two people there, there is going to be blame shift. That's a problem. That's the biggest issue.

Interviewee No. 13, agreeing with Interviewee No. 12's point, added,

There is, essentially, absolutely zero interrelationship between architectural design and manufactured housing. Zero. Some East Coast factories will build architect-designed houses, but they still screw that up. That relationship is akin to working with a bad contractor who only builds half a house (the factory) and expects the site contractor to finish off whatever remains—and take responsibility for what the factory screwed up. [None] of the large (1,000+ houses/year) manufacturers [will] work with architects and only build from their catalog. Most small (100–500 houses/year) manufacturers do the same thing or will work with architects when times are slow. Now that the economy is back, they throw big numbers at architect-designed projects; and as a result, the project is site-built instead. All of our upper-Midwest factories are currently swamped, building badly designed homes for the North Dakota oil boom and won't touch something not in their catalog.

Manufactured, or in our case, modular—since “manufactured housing” is technically a HUD code trailer home term—does not endeavor to build a better product, only a cheaper one. People don't seek out modular because it's better; they incorrectly think it will be cheaper, but still high quality. It's worth keeping in mind that the workers are not craftspeople, but rather low skill assemblers. They



don't read drawings and are not accustomed to thinking, because most of what they build is a stock design and they can do it over and over again. Ask for window head heights to be 8'-0" and they'll miss it and set everything at 6'-8". There are some great efficiencies and technological improvements over conventional construction, but those advantages can be diluted quickly by poor detailing and lack of integrity when it comes to warranty and standing behind their work. Most clients care more about the finish quality and warranty than whether the walls are extra strong due to belt rails mortised into the wall studs. There are only two or three factories that I know of in North America that are truly "boutique" high-end operations that do exceptional work and will honor their warranty. Unfortunately, they typically price themselves out of most markets.

Sorry for the dour perspective. We've been at this for 10 years and are very close to getting out of modular and returning to conventional construction types. Most of our current work [is] with site-built or built panelized or with SIPs because modular is now more expensive and of poorer quality. I'd suggest you focus on manufacturers and designers in markets where labor is expensive, in short supply, or where there is a thriving market. Building via modular in a community such as Calgary, for example, is a perfect solution because most labor is working in oil fields, the weather is terrible, and the local builders are slow. Unfortunately, because it's thriving, most of the infill projects are monopolized by developers that don't use architects, and most regional modular manufacturers are bad or busy building houses for their oil communities.

Problems such as site conditions, construction budget constraints, environmental regulations, and building and safety codes might be avoided by increasing the productivity and efficiency of earlier collaborations with instant feedback among diverse design and engineering teams from different disciplines, throughout the design, manufacturing, and on-site assembly processes.

The previous discussions also revealed that there is a real need to restructure the process of communication among all parties involved, from design to manufacturing and ending with the on-site installation of the project.

5.5.3 Building Systems

Architects and engineers design buildings by blending primary elements within different systems, such as structural, enclosure, services, and finish systems. Understanding the relationship between the primary elements within each system assists in developing new prefabrication methods for a specific building system. This approach can be used to develop a communication technique among architects, engineers, modular home manufacturers, and contractors. The need for a generic formulation design language is of paramount importance, specifically within the modular housing industry. This could also assist with avoiding any miscommunication among disciplines and the various parties involved in the design, off-site manufacturing, and on-site construction processes. The table below illustrates some of the main characteristics of these four building systems:

Table 5.5: The main characteristics of building systems

• Structural Systems	<i>Superstructure: Bearing Walls, Columns, Beams, Floor Slabs, Roof Substructure: Foundation, floor Slab</i>
• Services Systems	<i>Mechanical, Electrical, Plumbing</i>
• Finish Systems	<i>Floors, Interior Walls, Ceilings, Internal Openings</i>
• Enclosure Systems	<i>Cladding, External Openings</i>

All interviewees were asked whether or not they agree with the following statement:

Typically, a building is a combination of four main different systems, which are, structural systems, services systems, finish systems, and enclosure systems, which define the outer and inner surfaces.

Table 5.6 below summarizes the Interviewees' responses to that statement.

Table 5.6: Guidelines for designing for modular homes

Interviewee	No. 1	No. 2	No. 3	No. 4	No. 5	No. 6	No. 7	No. 8	No. 9	No. 10	No. 11	No. 12	No. 13
Yes	●	●	●	●	●	●	●	●	●	●	●	●	●
No													

When the interviewees were asked which one of the four building systems requires more attention, all interviewees from the modular manufacturers group mentioned the structural system, whereas all interviewees from the architectural side indicated the enclosure system (form and appearance).

Typically, as mentioned earlier, there are around 45 production activity steps that most modular manufacturers follow for off-site construction. Table 5.7 below shows the breakdown of the production activity steps based upon the building systems.

Table 5.7: Typical production activity steps for modular home manufacturer. Adapted from (Mullens, 2011)

Typical Production Activity	Building Systems			
	Structural systems	Services systems	Finish systems	Enclosure systems
1. Cut framing components (Mill)	•			
2. Build floor	•			
3. Build window/door opening subassemblies			•	
4. Build partition walls	•			
5. Build side walls	•			
6. Build end walls	•			
7. Build marriage wall	•			
8. Set partition walls	•			
9. Set exterior and marriage walls	•			
10. Install rough electric in walls		•		
11. Build plumbing subassemblies		•		
12. Install rough plumbing in wall and tubs		•		
13. Build subassemblies for roof	•			
14. Build roof/ceiling	•			
15. Set roof	•			
16. Install rough electric in roof		•		
17. Install rough plumbing in roof		•		
18. Insulate roof			•	
19. Sheath and install subassemblies for roof	•			
20. Shingle roof			•	
21. Prep/drop roof and wrap for shipment	•			
22. Install fascia and soffit		•		
23. Insulate walls			•	
24. Sheath walls	•			

25. Install windows and exterior doors			•	
26. Install siding and trim			•	
27. Hang drywall on walls			•	
28. Tape and mud drywall			•	
29. Sand and paint			•	
30. Install cabinets and vanities			•	
31. Fabricate and install kitchen countertops			•	
32. Build finish plumbing subassemblies		•		
33. Install finish plumbing		•		
34. Install finish electric		•		
35. Build interior door subassemblies			•	
36. Install interior doors			•	
37. Install molding			•	
38. Install miscellaneous finish items			•	
39. Install flooring			•	
40. Load shiploose			•	
41. Factory touch-up			•	
42. Install plumbing in floor			•	
43. Load module on carrier	•			
44. Final wrap and prep for shipment			•	
45. Build major shiploose subassemblies	•			

From the information in Table 5.7, it can be seen that all 45 production activity steps are related to the structural, services, and finish systems, and none are related to the enclosure system. Until now, most single-family modular home manufacturers focused on the speed of their production line, and since the enclosure system is considered the last layer of the building's elements, one of the main quality aspects of design can be achieved by adding a third-party building enclosure specialist manufacturer into the overall framework process. Architects should take into consideration not only the conception phase of design, but the production process as well. Further discussion of this process will be illustrated in the next section.

Building enclosures have multiple functions. Their main purpose is to protect the users from uncomfortable environmental conditions, such as heat, cold, rain, snow, and wind. Other functions include their use as protective barriers from outside dangers. Enclosures also serve to control the amount of natural light in response to the occupants' needs, since the lighting and

climate inside buildings can be modified by controlling opening sizes and locations throughout the enclosure.

At the present time, generally the use of the enclosure is still limited to protective uses and climate control. Architects should use Design for Manufacture (DFM) and Design for Assembly (DFA) methods with CAD/CAM/CNC technologies to design beautiful forms as well as to create systems within those forms that have the ability to accommodate change and provide future flexibility and adaptability. Architects should integrate the ability for future change into the enclosure design, including the flexibility of adding and subtracting from the original building. The process should truly reflect the users' needs, taking into consideration different requirements, ranging from cold-weather climates to the hottest desert locations. As can be seen in Figure 5.11, the architect animates the exterior enclosure of the house taking into consideration the natural ventilation and day lighting.

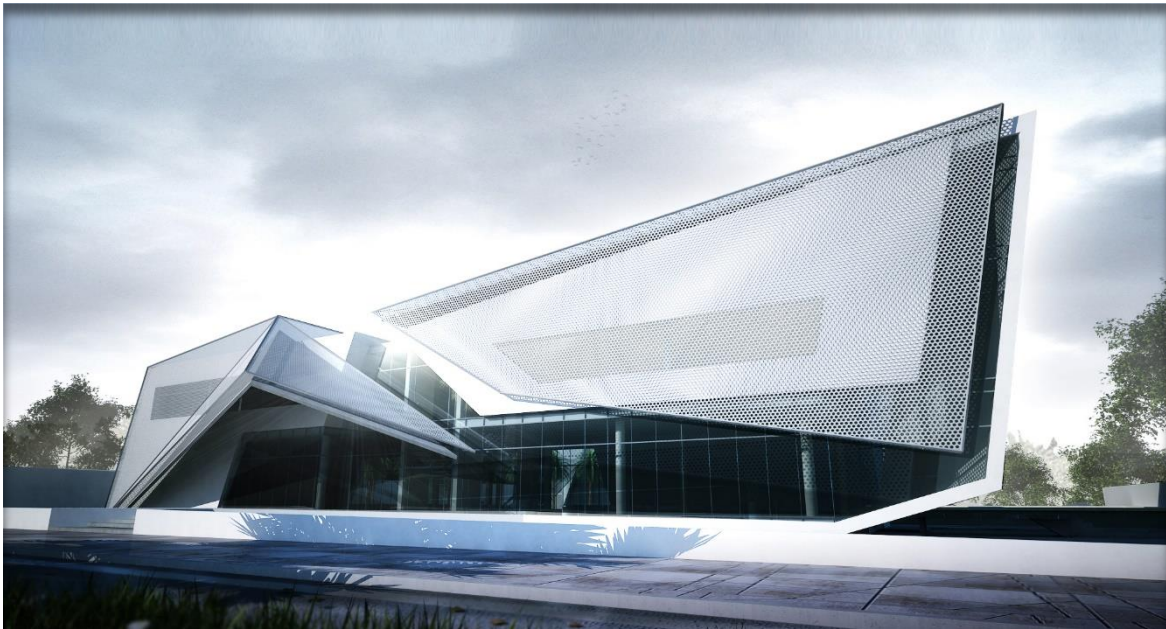

Figure 5.11: Natural ventilation and day lighting were major factors in the design of the house (FA Consultants, 2014).

5.6 Enclosure System as a Sub-Model

The concept of modularity is based upon a systematic hierarchical modeling approach that involves a higher level (global model) and lower level (sub-model). A modular home, which is considered the first level of modularity, can be decomposed into a number of sub-models as second level of modularity, such as enclosure system. One of the main advantages of the sub-model technique is the user's (architect's) ability to study and analyze the subdivided module separately as an independent functional component of the overall model. It allows an architect to focus attention regarding the integration between components of a single building system or between different building systems into an integrated whole product. As learned from the previous "As-is" framework related issues, most modular home manufacturers focus mainly on the design and manufacturing of the structural, services, and finish systems, where the enclosure system is not part of the design development process. Architects can assist with designing the enclosure system while maintaining cost effectiveness; however, a data analysis phase is an important sub-process within the design process and plays a key role in modeling. Through the development of the design, more information such as material properties, dimension, and structure will be added to the model. This information will assist in the evaluation of the design, by generating information to be used in the "To-be" framework for manufacturing and assembly processes.

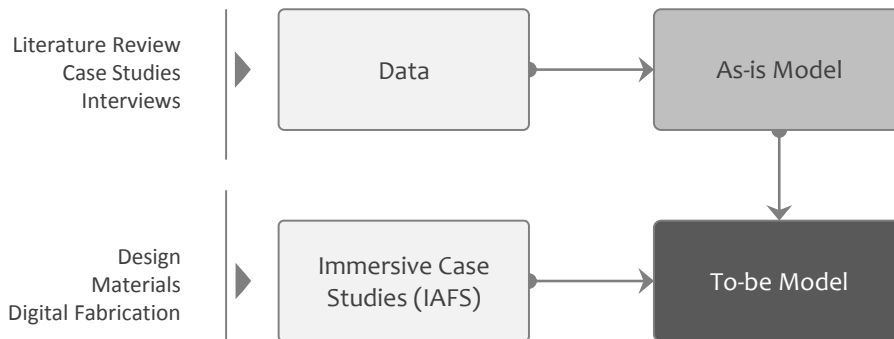

Figure 5.12: An overview of the data analysis approach.

Figure 5.12 presents an overview of the data analysis approach to three sources of information (literature review, case studies, and interviews) to map the "As-is" model. Such an analytical approach assisted with identifying issues related to the *status quo* within the modular home industry. As mentioned above, the enclosure system is one issue related to the design aspect. Likewise, there is a need for a data analysis phase through immersive case studies of the enclosure system using three sources of information (design, materials, and digital fabrication).

Thus, analyzing, capturing, and structuring knowledge as a process from both, the “As-is” model and the immersive case studies may support the anticipated results for the “To-be” model.

The Integrated Architectural Fabrication System (IAFS), as introduced previously in Chapter 2 (section 2.7), may help not only to bridge the gap between the enclosure system’s design and the modular home industry, it may also help to increase productivity, workflow, decision making, and profits while reducing operating costs. This outcome occurs by implementing IAFS within BIM technology (Figure 2.43), or as a database accessible through the World Wide Web, allowing information to be collected and shared in near real-time, through multiple analytical tools that simultaneously evaluate geometry, material options, and fabrication techniques during the conceptual design phase. However, the IAFS may assist as a one-node knowledge domain through a long and complicated process that needs to be identified.

The new IAFS tool may alter the design process for modular housing by linking construction and fabrication issues earlier in the process and may be received by practicing architects as a useful approach to achieving this transformation. Figure 5.13 shows an overview of the possibilities and options of existing tools and techniques for geometry, materials and fabrication within IAFS.

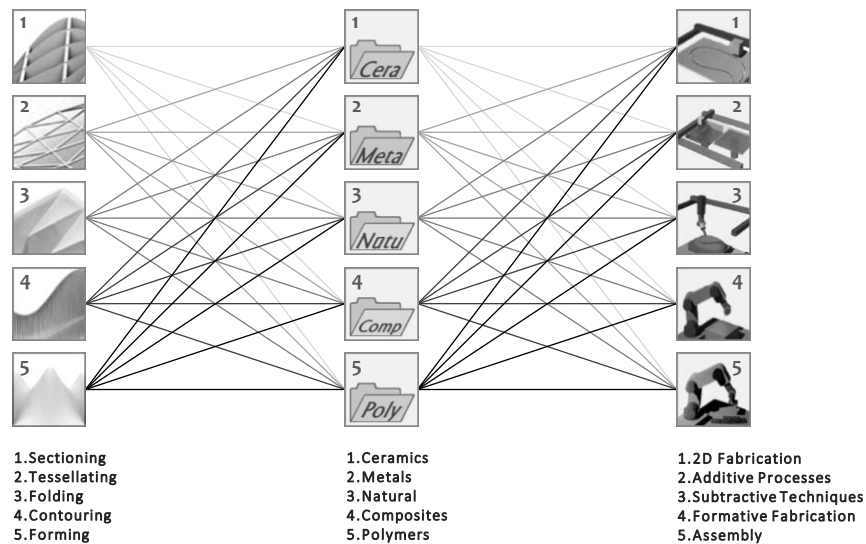



Figure 5.13: The possibilities of existing tools and techniques for geometry, materials and fabrication within IAFS.

Based upon the previous discussion, architects can enhance and expand the role of the modular housing industry with innovative designs and variations through understanding modular construction techniques, barriers and constraints. However, there is a definite need for



architects to adapt and be aware of methods such as Design for Manufacture (DFM) and Design for Assembly (DFA) in their process of design thinking. Both methods may assist not only architects, but also modular producers by giving them an overall view regarding the applicability or difficulty to manufacture and then assemble a specific component. Also, as pointed out by Mullens (2011), the employment of DFM and DFA during the design process may assist architects in overcoming some of the major causes behind the low economic growth of the modular construction industry, which includes the limited design variation.

An owner usually considers his or her home's appearance essential. As discussed earlier, part of this research is to develop a design process that can understand all of the different systems, which also operates within the limitations of the manufacturing and fabrication processes. In order to achieve this, modular building producers also need to agree to shift from mass-production to mass-customization processes through the employment of technological advances such as CAD/CAM/CNC, which may also assist in bridging the gap between design and manufacturing. According to Mullens (2011), most modular producers are still based on low technology mechanized hand tools.

Advanced fabrication processes might be new for the architectural and construction fields, but these have been utilized by the automotive, shipbuilding, and aircraft industries over the last two decades. For example, if we look at the design of cars, there are some fixed factors such as the number of wheels and the position of the steering wheels. However, most car manufacturing companies offer their clients the ability to customize their cars with some features that do not affect their main manufacturing process based upon mass production. In general, these customized features include different selection or combinations for the interior and exterior colors, the wheel rim design, and engine power. However, the overall shape and design of the car are typically fixed and cannot be modified or customized by the client.

Unlike the automotive industry, implementing DFM and DFA methods as part of the design process with technological advances such as CAD/CAM/CNC within the modular homes industry, could revolutionize the modular construction industry. Such a design process can give potential owners the experience of instant changes and alterations until they reach their desired design. These instant changes and alterations are not limited to design floor plans, exterior and interior colors and materials, but also the overall shape of the building enclosure system. Additionally, rapid prototyping of the final design can be created in a matter of hours. This will give owners a unique hands-on experience very closely mirroring what the final design should be like. The IAFS process and system will be demonstrated next in three different case studies (scenarios) for a complex surface geometry.

5.6.1 Scenario 01 (Sectioning-A)

In this experiment, the design team chooses to start by using IAFS from geometry to rationalize complex surface geometry. The team selects the sectioning technique as an input. At this point, the design team may fill in other parameter information, such as the orientation degree (x, y) of directions. As a result of the input geometry information, the system provides the design team with all related information regarding the various options available for materials and fabrications for that specific design. For materials, the system shows what metals and natural materials could be utilized for this geometric technique. The system then shows that this 2D fabrication, based on a Computer Numerical Control (CNC) machine, would be the correct method to fabricate this geometry. Additionally, the design team is able to explore even further, by obtaining added information such as the material options under each family, properties, price, and suggested providers from the program's menu choices.

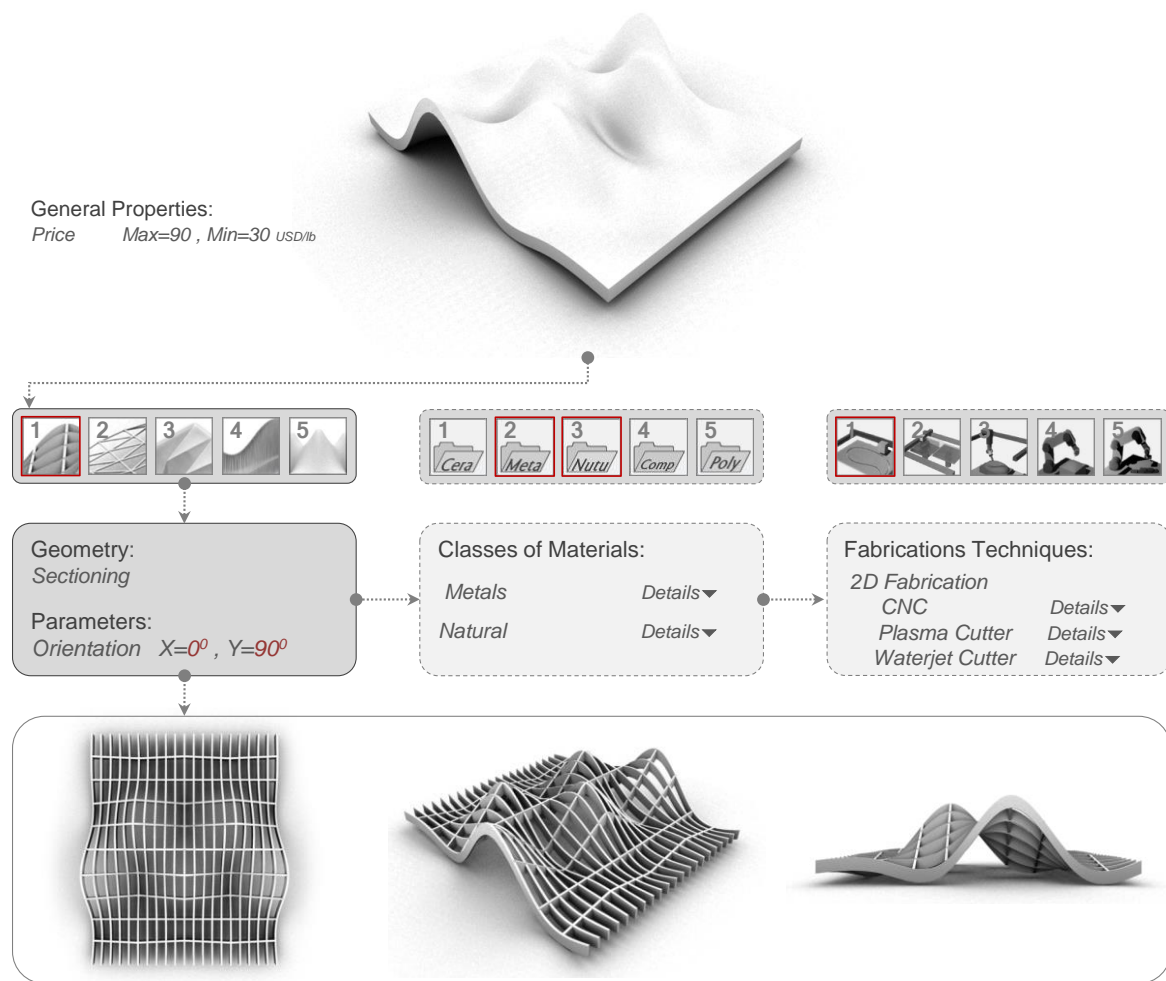

Figure 5.14: Scenario 01 (Sectioning-A).

5.6.2 Scenario 02 (Sectioning-B)

In this experiment the design team chose the sectioning technique as the primary input, but tests different parameters for the orientation degree of (x,y) directions. For this, they chose ($x=45^\circ$, $y=45^\circ$). As a result of the information input under geometry, the system provides the design team with all the related information for materials and fabrications options needed for this specific design, which are similar to the information output from the previous experiment. This occurs because the design team explored the creation of the system using the same geometric technique. The only change is the orientation of the structural ribs.

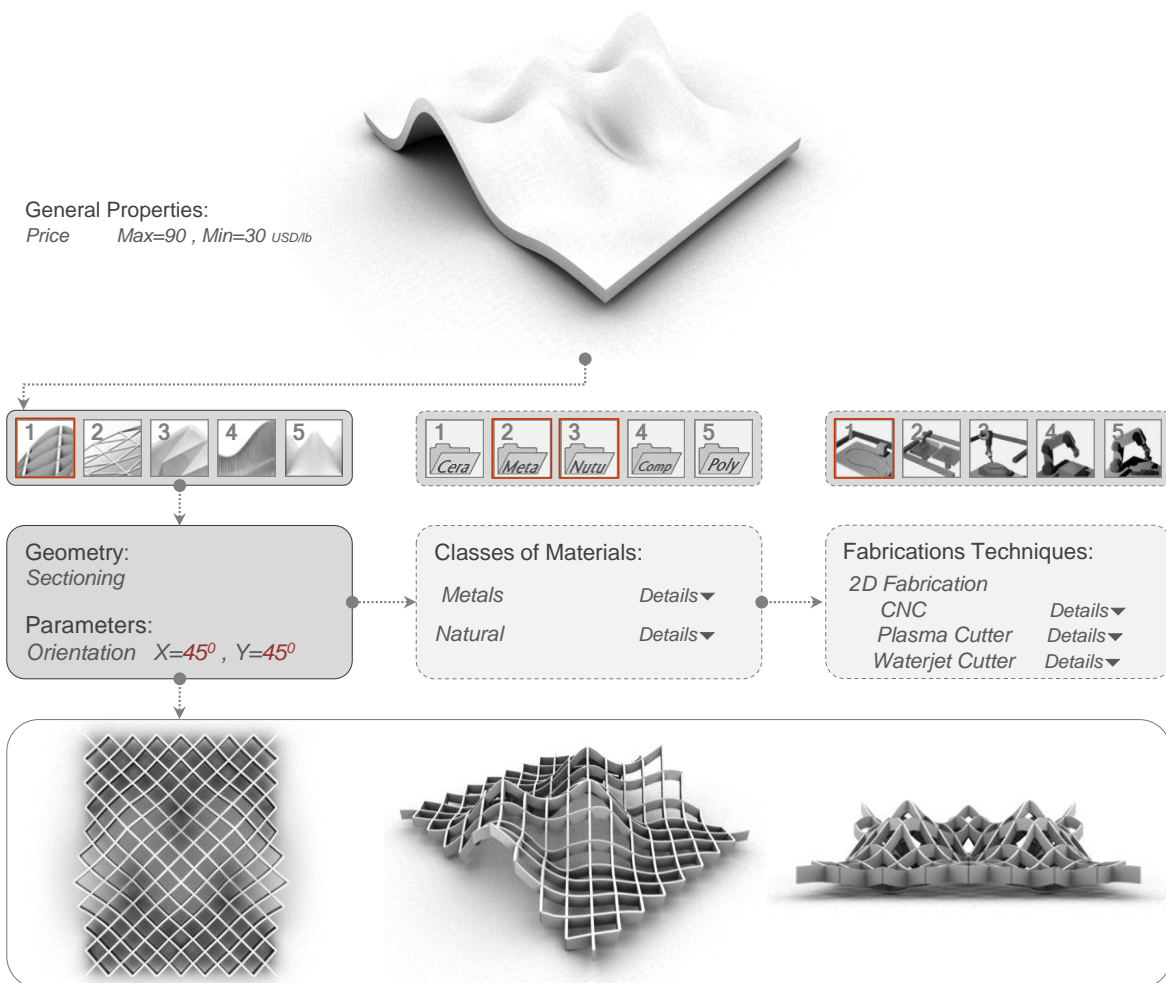

Figure 5.15: Scenario 02 (Sectioning-B).

5.6.3 Scenario 03 (Tessellating)

The design team, in this experiment, begins by selecting the tessellating technique as input. The team then fills in the parameter information for the orientation degree of (x,y) directions. As a result of the input information under geometry, the system provides the team with all the related information for materials and fabrication options needed for the specific design. Regarding materials, the system indicates that metals and composite materials should be utilized for this geometry. In regards to fabrication techniques, the system shows that formative and subtractive techniques would be the correct methods to manufacture this geometry. The design team can explore further to obtain additional information such as materials options under each family, properties, price, and suggested providers.

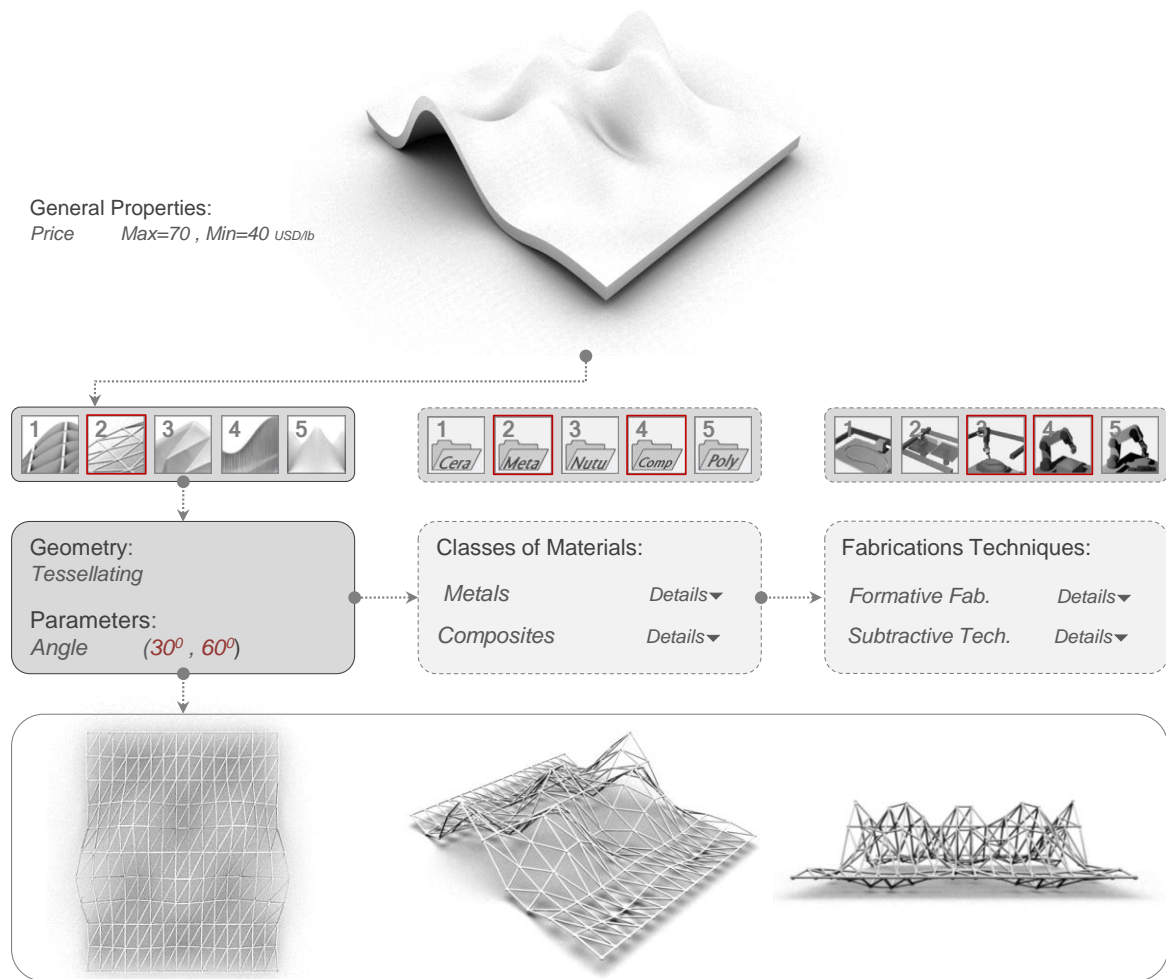

Figure 5.16: Scenario 03 (Tessellating).

5.7 Building Enclosure Specialists—Case Studies

Two companies known for being specialists in dealing with geometrically complex building enclosures were contacted. The goal was to understand how to link the conceptual analysis phase of an enclosure system to the development phases of production drawings and manufacturing process. Such an understanding assisted with developing the “To-be” framework.

Through these two companies our understanding for the different issues related to three questions can be improved:

- How does the information flow from design to the fabrication phase?
- Is there a bottleneck in this flow that could cause delay?
- How do these two companies see IT changing this information flow within the next 10 years from design to fabrication?

The first company consults with architects in studying and rationalizing their building’s enclosures and making all the required digital models that make the intended project constructible. The second company is known for developing and applying fabrication technologies as tools and techniques to produce and build the complex projects from visual to physical components.

A project consultant at the first company was contacted to answer the above questions, and he gave a detailed explanation regarding how digital information typically flows from the design to the fabrication phase.

This process begins with the company being hired as consultants, either by a client or an architectural firm, to study and rationalize a project with a complex geometrical enclosure. The company then forms different teams to begin work on the project based on the scale and type of project. The next step is to import the 3D digital model and redraw what the engineering team wants to study and rationalize in AutoCAD as 2D drawing. Once finished, the 2D drawing is taken to the Digital Project (DP), a software program based on the Catia engine. When work is completed on the DP, the studies and results are redrawn in AutoCAD as construction drawings. The completed construction documents are then sent to the architectural firm who has the responsibility of studying and reviewing the documents through the fabricator for accuracy. The architectural firm then sends any comments and questions they may have back to the company.

The complexity of the information flow for these types of projects is clearly seen throughout this process; the question raised here is, “What if the client or the architect does not agree with the outcome from the enclosure specialist?” The answer to this question addresses the possible bottleneck situation. When asked this question, the project consultant responded that one of the most likely bottlenecks in this network is the architect. This occurs because different



architects may disagree about whether or not to change or modify the design to solve issues of constructability that may arise within the project. The project consultant feels that if they become involved during the initial conceptual phase of the project, it smoothes out the bottleneck, as it is easier to solve any and all problems in the beginning of a project as opposed to nearer the end of the project.

The project consultant further explains that within the next 10 years, the informational flow and technological advances will be not only available, but will be superior to what it is used presently, allowing the design and construction stage to become easier. He feels that because most of the complex geometries' problems will be identified quickly by the AEC industries, many of these problems will disappear with time.

The Vice President (VP) of the second company addresses information flow from the design to the fabrication phase from a different perspective. He stated that after being hired by either a client, architect, or design team, he forms a team of engineers, designers, and fabricators. This team then develops the digital model to make it fabricatable by breaking it down into multiple components (chunks). The VP stated that the ability of exchanging information directly between CAD/CAM technologies makes their work easier since they can work on the same digital model provided by the architect. He explains that his team adds attributes that contribute to defining their work. He reiterates that this is the beauty of the digital model: you use the same model and only have to add to it until it is satisfactory. Once the model has been developed to be fabricatable, it is sent to the architect for approval. When the architect's approval is received, the engineering team sends each chunk to a different fabrication team, based on each team's expertise, to begin the fabrication process. The VP mentions that knowing their machines' capabilities makes the in-house development phase much easier for them than waiting on construction documents from other organizations.

In the construction company's case, information flows from design to fabrication in a less complicated way than at the consulting company, based upon the development method and the advantage of having the direct interaction with fabrication tools (machines).

The VP addresses three major problems in this network. First, everyone is not working in the same digital model due to using different software and conversion issues. Second, he points to working with different professions as the problem of material tolerance. Lastly, there can be delay that might be caused by the fabrication company not working on the project from the beginning. The VP states that the size of the architectural firm does not equate to superior CAD/CAM documentation. What is important is for designers to be familiar with the fabrication equipment techniques to help link innovative designs to their physical phase. He feels that, with the assistance of information technology, information flow in the future will be faster, easier, and more efficient, and will occur as a direct result of all expert team members having the ability to work on the project from inception.

5.8 Closed Systems

Closed systems are made up of fabricated elements from a single manufacturer. In the modular home industry, closed systems can be created for the entire building, the wall and roof truss subsystems of the building, partial systems in the building, or even for load bearing structures. In a closed system, all elements are coordinated and match each other. Elements of a closed system cannot be altered or exchanged. All elements within a closed system can only be used within the particular system. One example of a closed system is the car industry. In the automobile industry, the range of design options is limited due to the lack of flexibility in building parts (Staib et al., 2008).

In the modular single-family home construction industry, closed systems present a number of limitations and disadvantages; this becomes very clear when architects take into account the users' individual requirements (Figure 5.17).

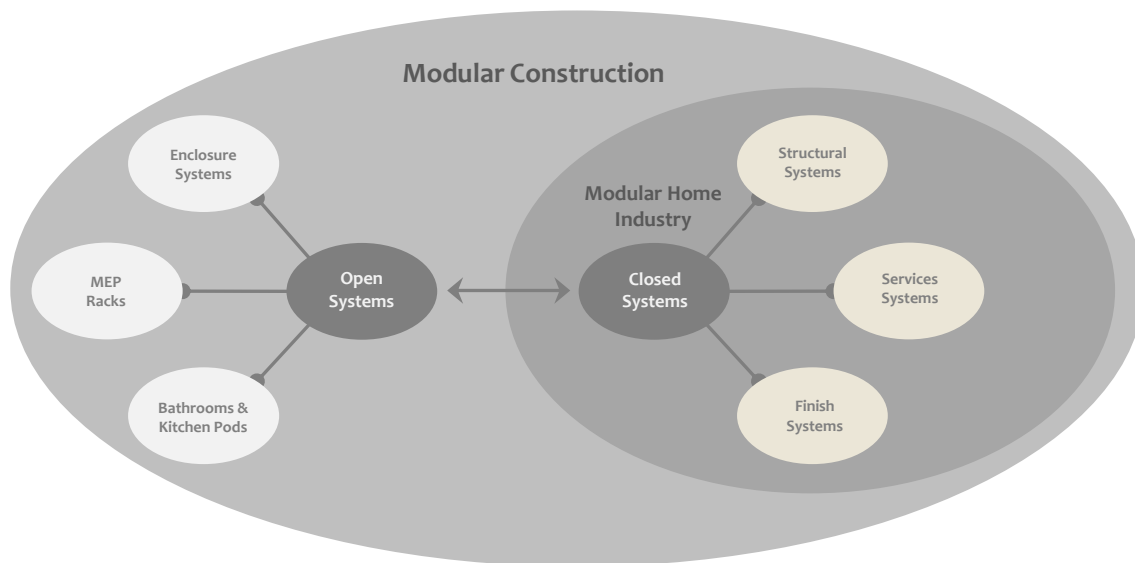

Figure 5.17: Open vs. closed systems

5.9 Open Systems

Open systems are based on the combination of various prefabricated parts. Therefore using an open system in the building industry allows the use of products from different manufacturers. The prefabricated elements can be combined allowing the creation of a wide range of very different construction projects (Staib et al., 2008).

With an open system, architects determine the function of the building components and select manufacturers. In an open system, the elements are standardized, dimensionally coordinated, and rules of classification are decided upon.

5.10 Mapping the “To-be” Framework

Figure 5.18 below presents an overview of the “To-be” modular construction timeline for a single-family home.

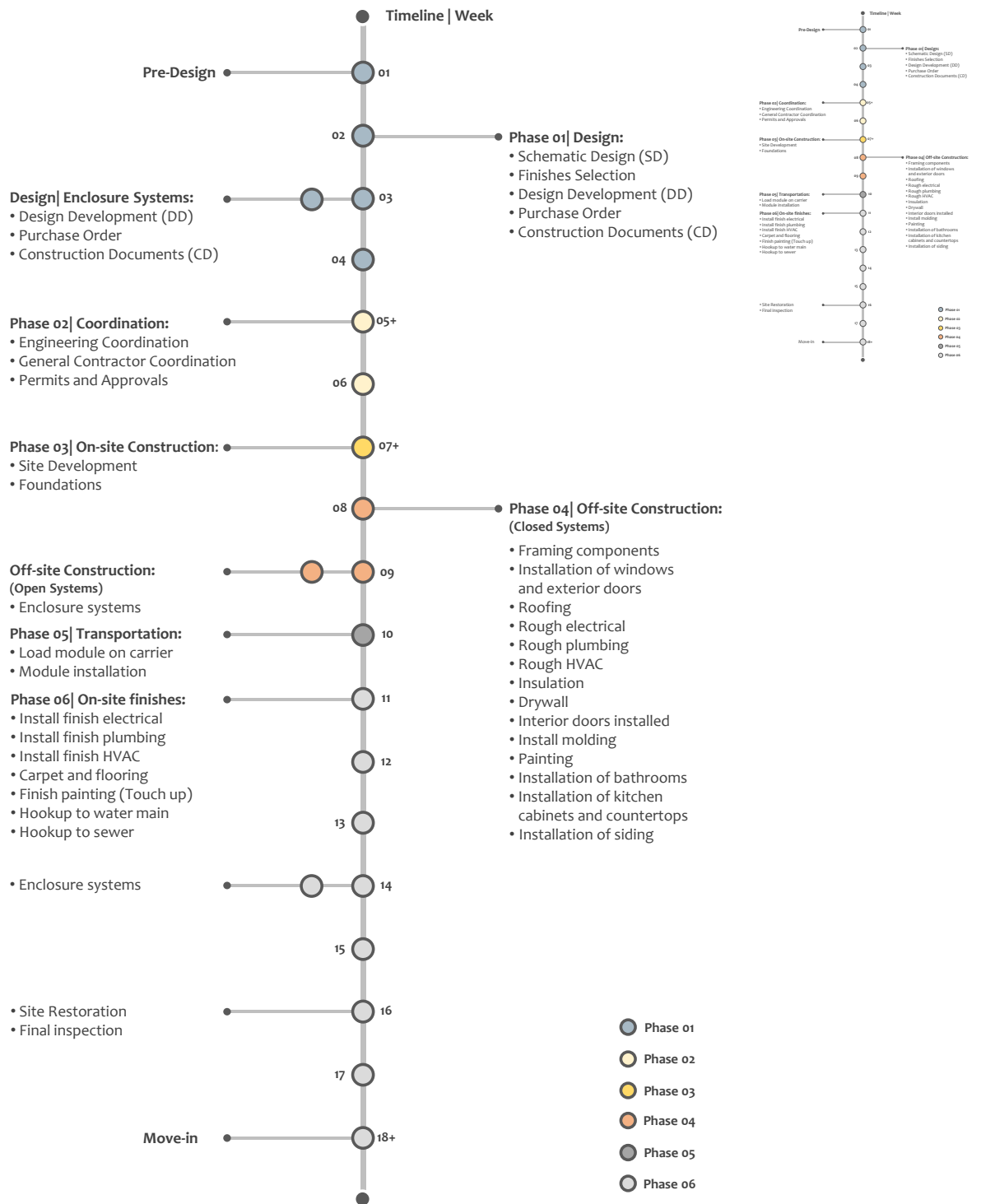

Figure 5.18: To-be modular home building timeline.

5.10.1 The “To-be” Overall Modular Construction Process

The aim of this section is to propose a “To-be” framework as it relates to the design and manufacturing processes of modular single-family housing industry, based on the IDEF0 modelling method. The frameworks presented in this section were modified and developed based upon the interviewees’ feedback and comments.

There is no differences between the existing “As-is” framework and the proposed “To-be” framework in terms of main activities. As can be seen in Figure 5.19, the four main activities are 1) design, 2) manufacturing, 3) transportation, and 4) on-site assembly processes.

As is shown in the overall “To-be” modular construction process (Figure 5.19), the client’s design requirement input is needed prior to the start of design activity. The main control characteristics during the top-level (Ao) are:

- Custom design
- Estimated cost
- Time schedule
- Building and construction codes

In contrast to the “As-is” framework, the architect is part of the design process and represents the client. The main participants (mechanisms) during the design activity are:

- Architect
- Sales representative
- Engineering manager
- Engineering team

The main participants during the manufacturing activity (mechanisms) are:

- Engineering team
- Plant manager
- Factory floor workers
- Quality control inspector
- Third-party inspector
- Third-party specialist

As can be seen from the list (above), there is a third-party specialist as a new participant. More details about manufacturing activity will be discussed later in (A2|To-be) sub-activity diagrams (Figure 5.22). There are no changes related to transportation and on-site assembly activities.

5.10.2 The “To-be” Conceptual Design Process

The (A1|To-be) IDEF0 model, shown in Figure 5.20, is composed of three activities representing the child diagram of the design activity (parent box). All three activities in this phase still focus on the conceptual design and are handled by four different people:

- Architect
- Sales representative
- Engineering manager
- Engineering team

The first conceptual design activity (initiation) begins with a meeting between the client and an Architect to discuss the design requirements and needs of the client’s future modular home. The main tasks the architect needs to assist the client with are:

- Custom design
- Selection of finishes

This is unlike the existing “As-is” framework where there is no direct interaction between the client and the engineering team during the design phase, where all communications regarding design go through the builder first, to the sales representative next, then to the engineering manager. The second conceptual design activity (design instructions) begins with a direct meeting among the architect, engineering manager, and sales representative. According to the interviewees, sales representatives are typically much less technical than the engineering manager. The “To-be” conceptual design process can assist with saving time and avoiding missing any information that might be lost in translation. Additionally, the sales representative will be able to provide a much more accurate preliminary pricing proposal: for example, if the design requires special structural components, the engineering manager will point that out to the sales representative.

As soon as the sales representative receives the client’s acceptance of the preliminary pricing proposal from the architect, the third conceptual design activity (preliminary drawings) begins. Two extra steps within the “As-is” framework are eliminated in the “To-be” framework: 1) a meeting between the sales representative and the engineering manager to discuss the design requirements and 2) ensuring that the project can be manufactured and delivered to the site location.

The engineering team then prepares preliminary drawings that follow the design instructions and requirements received from the engineering manager. After the preliminary drawings are generated, the engineering manager sends them to the architect and the client for review and approval. Once the architect approves the preliminary drawings, the process moves into the design development phase.

5.10.3 The “To-be” Design Development Process

The (A13|To-be) IDEF0 model for the design development process, shown in Figure 5.21, is composed of five activities representing the child diagram of the conceptual design activity (preliminary drawings). During this phase, there are two different engineering teams who develop the preliminary drawings into a formal architectural set of drawings: 1) the engineering team of the modular home manufacturer and 2) the enclosure engineering team (third-party specialist). The formal architectural set of drawings can be rearranged based upon two systems, which are:

- Closed Systems:
 - Architectural drawings
 - Structural drawings
 - Mechanical, electrical, and plumbing services (MEP) drawings
- Open Systems:
 - Enclosure drawings

The closed systems’ drawings are part of the modular home manufacturer engineering team’s scope of work, where the enclosure drawings of the open systems will be developed by the enclosure engineering team. The main control requirements needed to begin the design development process are:

- Purchase order
- Deposit
- Building and construction codes

When the client and architect approve the preliminary drawings, the architect then sends a purchase order to the manufacturer and the client must pay a deposit on the cost of the home. Additionally, the architect will hire a third-party specialist to develop the enclosure drawings. Both engineering teams are responsible for following state and local building and construction codes. Figure 5.21 shows that the outputs of architectural drawings, structural drawings, MEP drawings, and enclosure drawings activities are the inputs of the construction documents (CDs) activity. The main participants beside the two engineering teams during the construction documents activity are:

- General contractor
- Engineering manager
- Third-Party Consultant
- Architectural team

The next step is to send the project documents to a third-party consultant for revision. Any comments received from the consultant are updated and corrected by the engineering team. After CDs are completed, reviewed, and approved by state and local authorities, the production process starts.

5.10.4 The “To-be” Production Process

The production process (A2|To-be) IDEFo model, shown in Figure 5.22, integrates the five activities that represent the child diagram of the manufacturing activity (parent box), which are:

- Production drawings
- Structural systems
- Services systems
- Finish systems
- Enclosure systems

Once the permits are obtained, the house is released for production. Both engineering teams then will generate all the production drawings and instructions. The main control requirements to begin the production drawings activity for both closed and open systems are:

- Production standards
- Quality control manual
- Safety standards
- Time schedule
- Purchasing of materials

After finishing the production drawings (along with purchasing the required materials to build the project), the production process of the home starts and is put into the production queue. The production line for the closed systems is based upon three main stations: 1) structural, 2) services, and 3) finish systems, while the enclosure systems (open systems) are fabricated at the third-party specialist’s plant. The main participants, besides the two engineering teams, during the production process activity are:

- Materials manager
- Plant manager
- Factory floor workers
- Quality control inspector
- Third-party inspector
- Architectural team
- General contractor

Figure 5.22 shows the output of the production drawings activity feeding inputs into the next four main activities. The end-result provides two completed off-site construction methods (Figure 5.22) based upon closed systems and open systems.

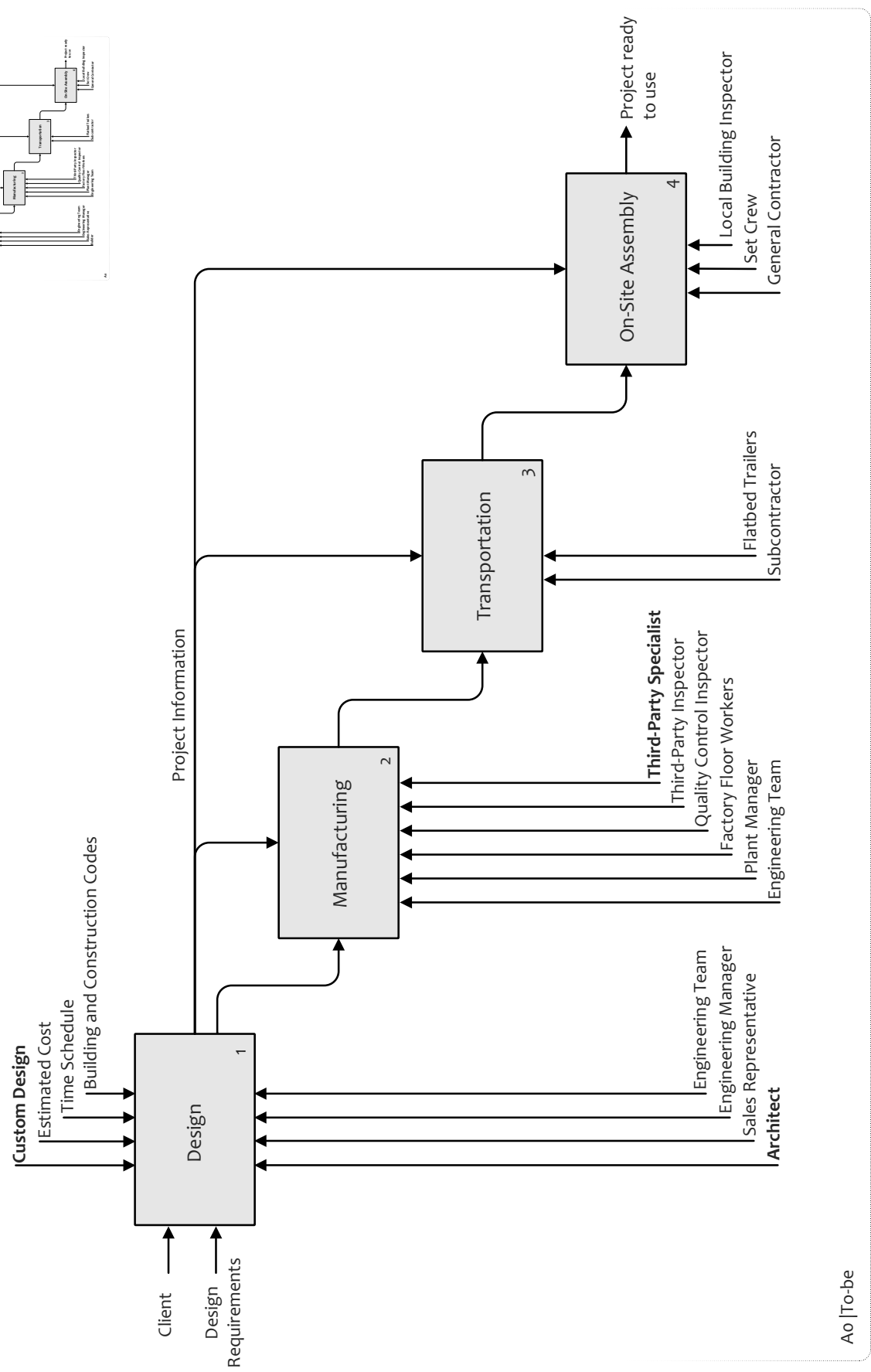
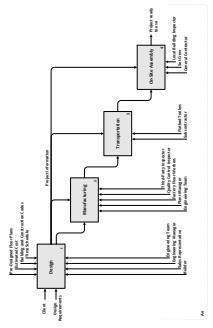

Ao | To-be

Figure 5-19: The overall modular construction process.

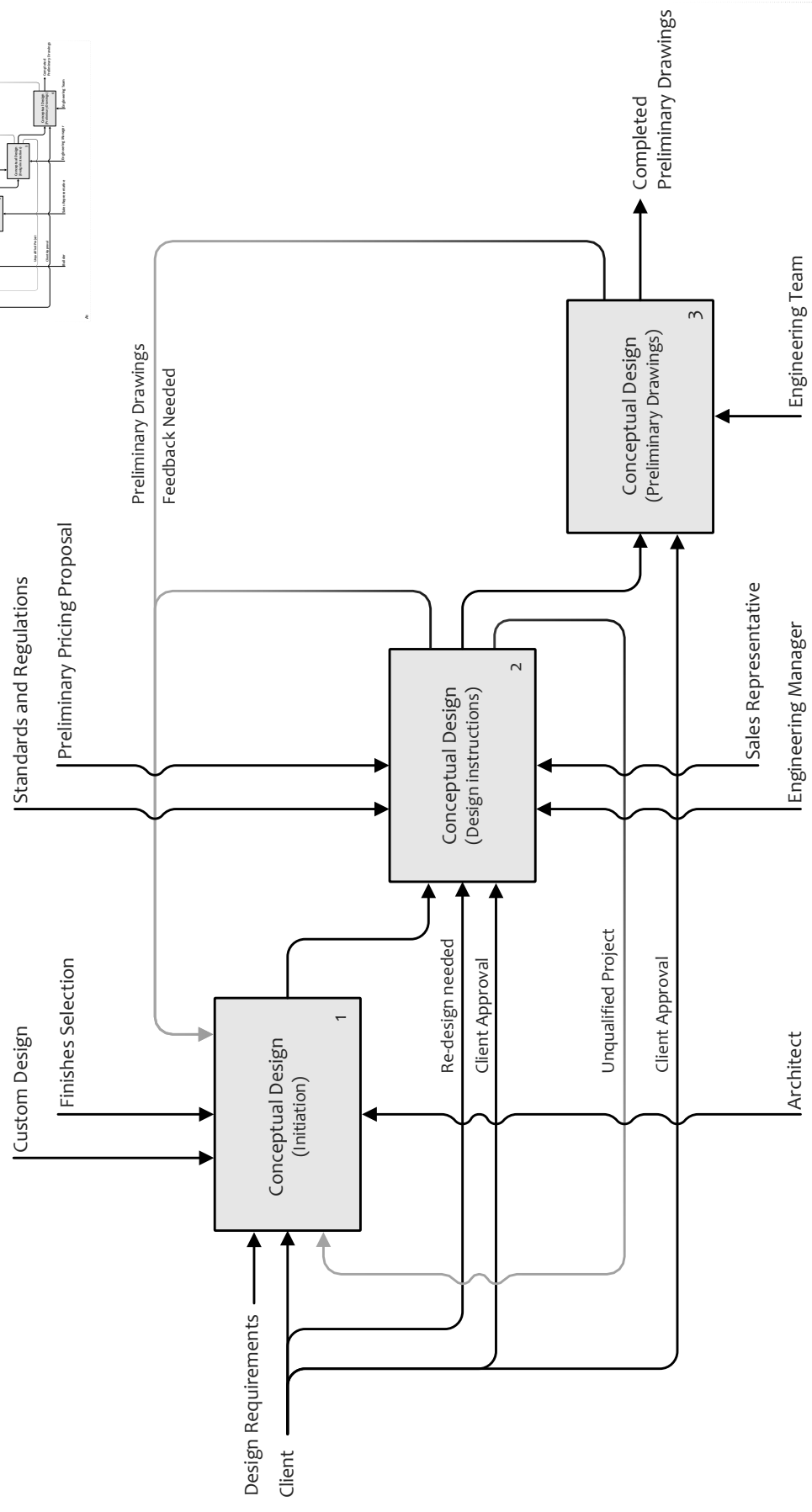
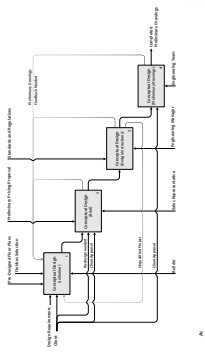

A1 | To-be

Figure 5.20: The conceptual design process.

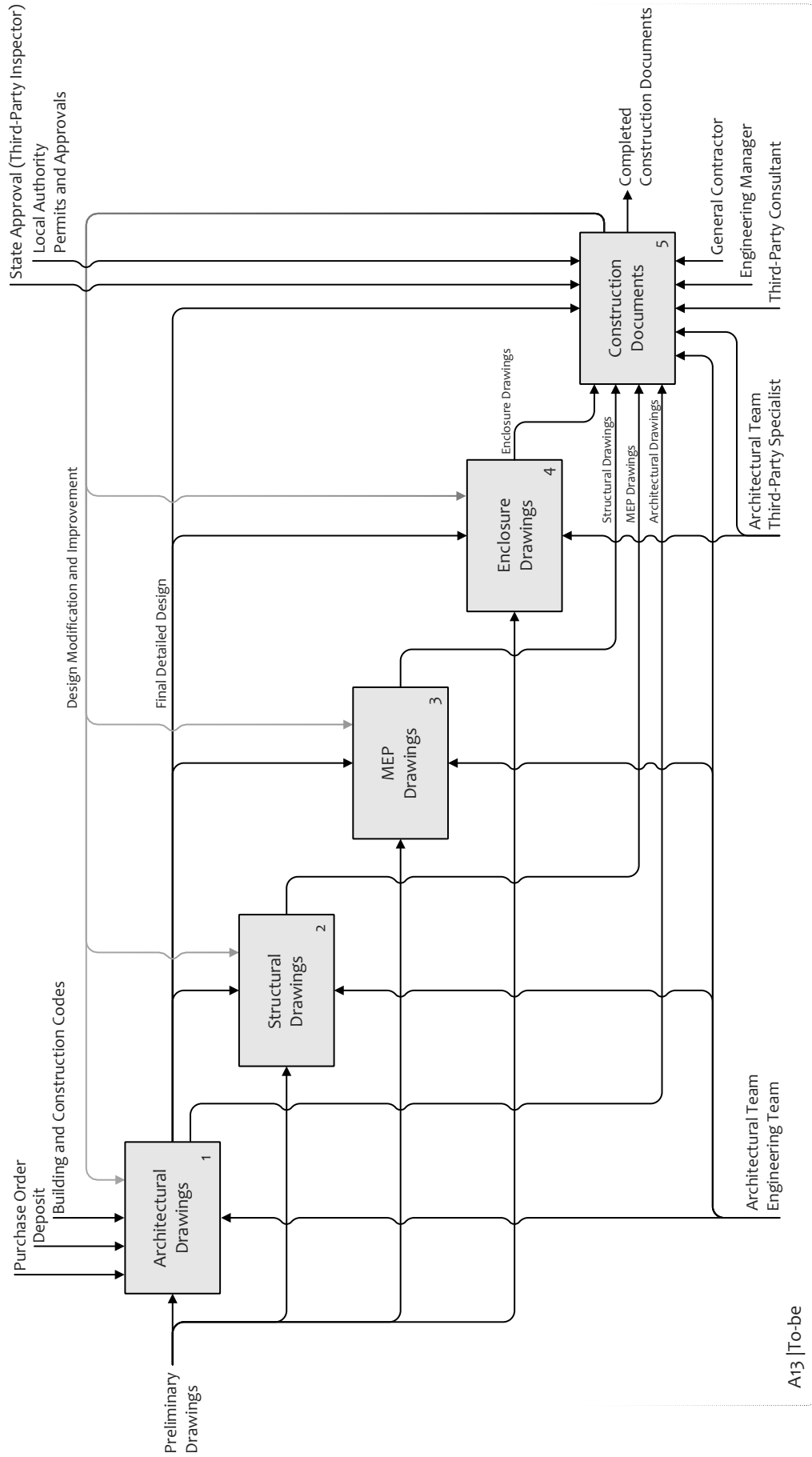
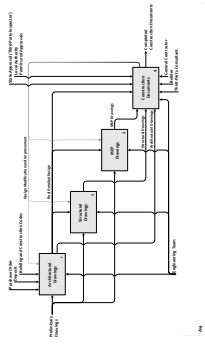

Figure 5.21: The design development process and construction documents phase.

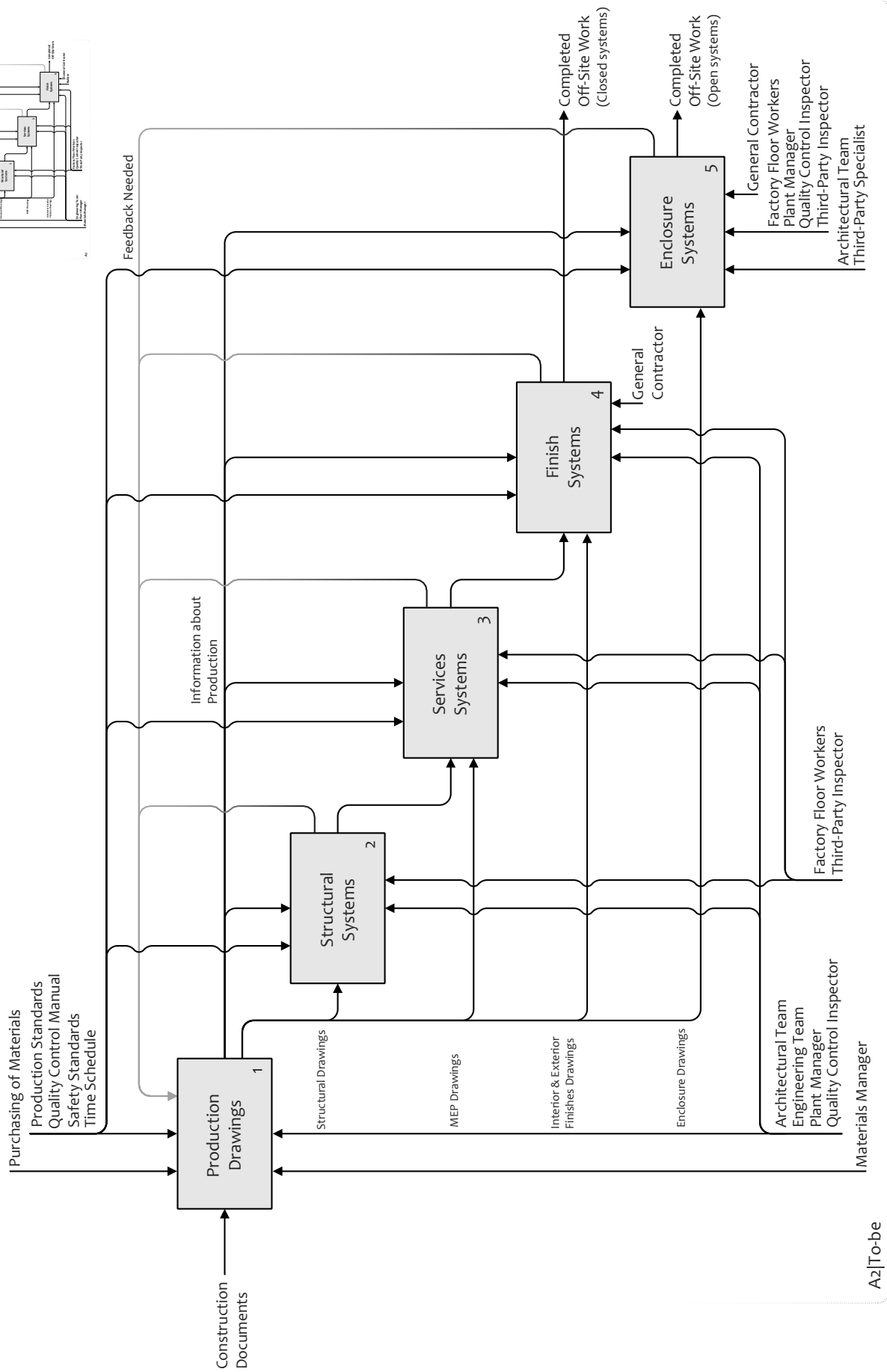
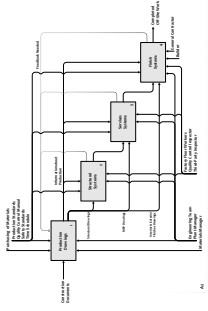

Figure 5.22: The production process.

Tables 5.8 and 5.9 below, demonstrate the difference among activity steps and people involved in the design and manufacturing processes for “As-is” and “To-be” frameworks in closed and open systems.

Table 5.8: Activity steps for “As-is” and “To-be” frameworks.

Activity	As-is		To-be	
	Closed systems	Open systems	Closed systems	Open systems
The Overall Modular Construction Process				
1. Design	•		•	•
2. Manufacturing	•		•	•
3. Transportation	•		•	•
4. On-Site Assembly	•		•	•
The Conceptual Design Process				
1. Conceptual Design (Initiation)	•		•	•
2. Conceptual Design (Brief)	•			
3. Conceptual Design (Design instructions)	•		•	
4. Conceptual Design (Preliminary Drawings)	•		•	
The Design Development Process				
1. Architectural Drawings	•		•	•
2. Structural Drawings	•		•	
3. MEP Drawings	•		•	
4. Enclosure Drawings				•
5. Construction Documents	•		•	•
The Production Process				
1. Production Drawings	•		•	•
2. Structural Systems	•		•	
3. Services Systems	•		•	
4. Finish Systems	•		•	
5. Enclosure Systems				•

Table 5.9: People involved in the process for “As-is” and “To-be” frameworks.

Mechanisms	As-is		To-be	
	Closed systems	Open systems	Closed systems	Open systems
The Overall Modular Construction Process				
1. Builder	●			
2. Architect			●	●
3. Sales Representative	●		●	●
4. Engineering Manager	●		●	●
5. Engineering Team	●		●	●
6. Plant Manager	●		●	●
7. Factory Floor Workers	●		●	●
8. Quality Control Inspector	●		●	●
9. Third-Party Inspector	●		●	●
10. Third-Party Specialist				●
11. Flatbed Trailers	●		●	●
12. Subcontractor	●		●	●
13. Local Building Inspector	●		●	●
14. Set Crew	●		●	●
15. General Contractor	●		●	●
The Conceptual Design Process				
1. Builder	●			
2. Architect			●	●
3. Sales Representative	●		●	●
4. Engineering Manager	●		●	●
5. Engineering Team	●		●	●
The Design Development Process				
1. Builder	●			
2. Architectural Team			●	●
4. Engineering Manager	●		●	●
5. Engineering Team	●		●	●
6. Third-Party Specialist				●
7. Third-Party Consultant	●		●	●
8. General Contractor	●		●	●
The Production Process				
1. Builder	●			
2. Architectural Team			●	●
3. Engineering Team	●		●	●
4. Plant Manager	●		●	●
5. Factory Floor Workers	●		●	●
6. Quality Control Inspector	●		●	●
7. Third-Party Inspector	●		●	●
8. Third-Party Specialist				●
9. Third-Party Consultant	●		●	●
10. General Contractor	●		●	●

5.11 Interviewees Feedback and Comments

The “As-is” and “To-be” frameworks were presented to a number of previous interviews’ participants within the manufactured single-family housing industry for feedback and comments. Interviewees were selected to participate in this stage based upon their different levels of experience within the modular home industry. More importantly, it is advisable to consider the views of other specialists to cover a specific issue or set of issues. The interviewees are: Interviewee No. 1, Interviewee No. 5, Interviewee No. 7, and Interviewee No. 8. All interviews were conducted face-to-face, taking place at each participants’ location.

Each meeting started with the researcher presenting the main goals and objectives of the research, some of the major causes of the low economic growth of the modular construction industry, and finished with the captured “As-is” design and manufacturing process model and the proposed “To-be” framework using The Integration Definition Function Modelling (IDEFo) technique as a graphical language. Prior to the “As-is” and “To-be” frameworks demonstration, the participants were provided with a detailed explanation of the IDEFo modeling language, including the main rules and instructions that need to be followed in order to use and understand the IDEFo method. Such description assisted the interviewees in providing feedback to improve and point out any missing information regarding the captured and proposed frameworks, including organizations, teams, decisions, actions, and activities. It should be noted that both the “As-is” and “To-be” frameworks presented earlier in this chapter were modified and developed based upon the interviewees’ feedback and comments.

Finally, interviewees were asked for their feedback and comments concerning the role of an architect in the proposed framework, the new communication process during the conceptual design phase, the implementation of the enclosure systems (sub-model), and the usefulness of the proposed “To-be” framework (IDEFo as a graphical language) in understanding the modular single-family home construction practice.

5.11.1 The Architect’s Involvement

Interviewee No. 1 stated that in terms of where the builder is involved and where the architect would typically be involved from a business model point of view, the typical customary modular factory is the builder. Contractual reasons are why this is relevant, but mainly because the builder is responsible (ultimately as the general contractor) for what the factory is providing more than the architect in any case.

In the past, the builder was someone who assisted clients with their design, finding a respected modular home manufacturer, and hiring an experienced general contractor and subcontractors. However, according to Interviewee No. 1, the role of the builder has changed and, interestingly, during a similar time period, in a way similar to how the financial industry has changed in terms of stock brokers and stock advisors. Typically, in banking, the investment advisors are selling products from certain companies or certain portfolios. The same thing began happening within modular construction where the builder is becoming more of an outsourced salesperson.

So, in the case of having a builder who purely has the client's design interest in mind, having the architect involved throughout the entire design and manufacturing processes to provide better assistance and quality of life through design is a good thing. Yet, interviewee No.1 indicated that unless architects practiced modular construction, it would be a challenging task for them to gain the experience or learn enough about the modular industry in order to take on the role of the builder. Additionally, architects need to work with different modular manufacturers so they can understand the strengths and weaknesses of various manufacturers' production processes and pricing methods.

Interviewee No. 5 supported the architects' involvement throughout the design-manufacturing process and said,

Typically, the holdup in such involvement is that the client and the architect haven't thoroughly gone over the design analysis and what it is that the customer wants or needs, and so it's just constant change in design, — [the architect] changes the exterior siding, completely changes the exterior siding, and that made differences on substrate. It made differences on supplying materials, and availability of materials (special order versus in-stock). And then once they did that, they found out when they changed the elevation drawings, they didn't like the way it looked and they changed window sizes. So, it's just this constant change.

Interviewee No. 5 added that unlike on-site construction where an architect has the ability to modify and change the design, the architect needs to understand that in off-site construction (once the production process has started) any changes would not only affect one project but all the other projects on the production line.

Interviewee No. 7 explained that the reason behind why many modular home manufacturers discourage and do not use architects more often is because most modular manufacturers have their own engineering departments in-house, and they use these as a selling tool. Interviewee No. 7 said,

When we try to sell a single family builder, we say [that] if you use our products, then we are going to do all of your engineering, so that will help decrease some of your architectural fees. We purposely are not trying to work with architects because that's part of our marketing strategy. Especially in the sale of family home.

Interviewee No. 7 added that the modular home industry is just coming out of the worst building recession ever, so most modular manufacturers were in a survival mode. But now, as the business picks up, the modular industry would be able to utilize custom designs by architects more often.

When asked about the current business model of most modular home manufacturers and the opportunity of architects' involvement, Interviewee No. 8 commented:

We should keep in mind, though, that the modular industry has really evolved from one generation from the '70s through that one generation. Now we are starting to see the different technologies that are out there, and we are more willing to take a look at that kind of stuff where the guys that are usually getting ready to retire, they don't want to have to take the time to learn that. They have been so used to the ways that they've done business and the ways that they've communicated in the past that there is just a little bit of unwillingness to look into these kinds of things.

Interviewee No. 8 added that modular home manufacturers should be willing to look at the bigger picture. Getting architects involved in the design and manufacturing process from the beginning may assist the modular home manufacturers with being able to build a much more innovative and nicer product for clients.

5.11.2 The New Communication Process

Interviewee No. 1 supported the proposed "To-be" communication process during the conceptual design phase, and explained that the sales representative is typically the intermediary between the builder and the engineering manager for a few reasons: one of which being the personality of the engineering manager which often would be either very likely to say yes to everything or no to everything. Having both the sales representative and engineering manager meet with the client at the same time as proposed may provide both the technical experience and that role of saying yes or no in a rational way.

Interviewee No. 5 also agreed with the concept of having both the sales representative and engineering manager meet with clients during the conceptual design phase, adding that typically the sales representatives are not detail-oriented people, especially if they are relatively new, and may not understand the manufacturing process of the factory or its capabilities; so they are much less technical than the engineering team. The proposed communication process between the two departments to service a client who has come to the factory would be much better and greatly improved.

Interviewee No. 7 indicated that having such communication procedures as shown in the proposed “To-be” framework is important and helpful for two reasons: 1) to save time, and 2) to avoid missing any information that might be lost in translation or by using different terminologies.

Talking about the proposed conceptual design process, interviewee No. 8 gave an example of a common miscommunication issue: the client receives a pricing estimate from the sales representative and has agreed to the pricing. Sometimes due to the lack of technical background by the sales representative, once the engineering team receives the client’s project requirements, the engineering team may request special structural components that were not included in the pricing estimate that has been agreed upon. Interviewee No. 8 added that such a line of communication needs to be direct right from the start and not having to go through all those channels.

5.11.3 The Implementation of the Enclosure Systems

Interviewee No. 1 supported the implementation of the enclosure systems as a sub-model for many reasons such as it being very difficult to have the efficiencies of mass production coupled with the benefits of customization, so outsourcing the enclosure systems to a third-party specialist could assist with avoiding any interruption to the flow of the modular manufacturer production line. Another reason is the limited skill set of the factory floor workers, unlike on-site construction where the possibility of hiring a sub-contractor specialist is more applicable than in off-site construction. If the design of the house has a curtain wall assembly, the client can hire a curtain wall sub-contractor. Modular home manufacturers usually do not hire specialized sub-contractors, so they will reject any project if their floor workers cannot build a particular component.

Another reason to outsource the enclosure systems is related to safety standards. According to Interviewee No. 1 the Occupational Safety Hazard Association (OSHA), the government body of

workplace safety, requires a certain minimum and maximum distance that someone can work against something. So, if the design has a complex or exposed façade that comes off from the building, the factory workers could not actually build that façade—not because they cannot physically build it, but because OSHA will not allow the manufacturer to build it based on their layout.

Interviewee No. 1 believes that having custom-designed enclosure systems prefabricated as a separate component and attached on-site is probably the most likely to be necessary for safety, production efficiency, and better quality.

Interviewee No. 5 expressed the belief that a modular home manufacturer needs to be willing to identify when a particular component should or should not be outsourced, and added that the modular home industry needs to push further and expand the concept of modularization from fabricating all of the building components in-house to where a modular component (such as a building enclosure) can be integrated into the structures of the module units.

Interviewee No. 5 added that modular home manufacturers need to accept new possibilities. Otherwise, they might go out of business. Architects should also start recognizing and forcing the modular home industry to accept the concept of open systems.

Interviewee No. 7 indicated that usually, for custom-designed enclosure systems, some modular home manufacturers will reject the project to avoid going through any type of variation that may happen.

Interviewee No. 8 supported the enclosure systems implementation and mentioned that the modular home industry has more expertise with structural integrity than with architectural features. Such an approach toward enclosure systems may work very well in the modular single-family home industry.

5.11.4 The Proposed “To-be” IDEFo Framework

Interviewee No. 1 specified that having such IDEFo diagrams would benefit both architects and modular home industry members by easily facilitating the understanding of design and manufacturing development phases while also helping to improve and enhance the architectural design process. Interviewee No. 1 believes that such IDEFo diagrams may assist the modular home industry in beginning to look to the outside world to help them fix or modify their internal processes.

Interviewee No. 5 indicated that the key is the architect who needs to understand modular home manufacturing activities; however, the proposed “To-be” framework is important to all participants involved in the project to understand the processes. Interviewee No. 5 said that IDEFo, as a graphical language, was easy to follow and understand, adding that such IDEFo diagrams will also assist in educating some general contractors about the modular process and what needs to be done on-site and when. Interviewee No. 5 further stated that it would be useful to add the IDEFo framework as a reference to the contract.

Interviewee No. 7 said people in general work visually, so sharing such framework diagrams to explain not only how a modular home is built, but also the scope of work, the constraints, and all players and their responsibilities in the process is very helpful.

Interviewee No. 8 specified that with such an IDEFo framework, the possibility to walk someone through the modular home design and manufacturing processes without missing a step is great. Seeing that kind of format gives a great perspective of how the entire process works. It may alleviate some of the misconceptions about the modular home industry. It gives a much smoother, clear cut understanding as to who is responsible for what, when, and where.

5.12 Summary

This chapter began by describing the Integration Definition (IDEF) for Function Modeling as a graphical presentation technique. The IDEFo method is one of the IDEF family used to understand and analyze the activities of the existing “As-is” design-manufacture communication process. After mapping the current framework (including organizations, teams, decisions, actions, and activities), the “As-is” framework-related issues were discussed, such as the lack of architect involvement, direct communication challenges, and building systems. Prefabrication industry system concepts, in particular closed and open systems, were discussed and have been implemented in the “To-be” framework.

A case study of two building enclosure specialists was presented, revealing a common pattern in collaborative design and manufacturing processes. Afterward, a “To-be” framework was proposed to enhance and improve the communication and productivity performances among people working in the design, manufacturing, and production sectors. Lastly, a number of previous interviewees within the modular single-family housing industry were asked for their feedback and comments regarding the proposed framework.

6. Summary and Conclusion

6.1 Introduction

Spatial design and creativity are the hallmarks of an architect's work. These unique qualities are fundamentally challenged by the modular home industry. Making buildings has always been a collaborative effort and has not been the burden of the architect alone since different members of the team including engineers, contractors, subcontractors (and even the site workers) contribute to the making and design of every building. Having an architect in charge of the process allows for the unique opportunity for collaboration with clients while creating a stronger relationship between the designer and the buyer of a modular home.

In the modular home industry, the client morphs from being an individual into being a consumer in a market, which mandates that the product or house must have general appeal and share the common charm of domestic architecture that everyone understands. This by itself merits a challenge to the architect who has been accustomed to authoring individual creations (Davies, 2005). Therefore, in the modular home industry, architects need to understand the factory production advantages and limitations in order to develop new design processes, features, and various options that might not be viable in the traditional method of modular construction. Additionally, architects should learn to speak the common language of modular production and execute it elegantly. This is of particular significance since most home buyers consider a non-standard design floor plan a very important factor for their future home design. Presently, however, the majority of the modular housing industry is still based upon pre-designed floor plans and standard products that are modified for a variety of sites.

Architects usually assume responsibility of both spatial design and structural design. In the modular home industry, spatial design is cheap due to the abundance of pre-designed floor plans and house types which are usually provided by builders (or modular home manufacturers) to their clients. There is no doubt that most house plans created by architects are well-designed, more aesthetically pleasing, and typically work better. These features could make modular homes more valuable for both buyers, and manufacturers. Therefore, to enhance the involvement of architects in the modular home industry, architects first need to understand methodologies such as design for manufacturing (DFM) and design for assembly (DFA) and learn to use them to their advantage.



Architects have always argued that modular home manufacturers are for mass production of identical units; therefore, modular homes coming out of factories would be standardized and result in a monotonous built environment. In the status quo of the modular home industry in particular, architects believe buildings are better made on-site rather than prefabricated in a factory.

Most modular producers (until now) are still based on low technology, mechanized hand tools adapted from older technologies that have been available for decades. Consequently, there is a need for rapid transition to modern technologies in manufacturing, since it is faster and can produce better quality. The modular construction industry, in general, was always an industry of systems such as closed and open systems. An industry such as this mandates the continuous development of improved models and systems. That is why, in the modular home industry, there is a need to shift from the current model based upon mass production and closed systems to more improved open model systems. Today, computer-aided design (CAD), computer-aided manufacturing (CAM), and computer numerical control (CNC) machines create better opportunities to link the role of architects with the production and fabrication processes. CAD, CAM, and CNC function as technological tools; they can be used to explore new forms and sophisticated shapes or used for developing innovative designs and ideas derived from industrialized production.

Advanced fabrication processes might be new for the architectural and construction fields, but these have been utilized by the automotive, shipbuilding, and aircraft industries over the past two decades. For example, most car manufacturing companies offer their clients the ability to customize their cars with some features that do not affect their main manufacturing process, which is based upon mass production. Generally, these customized features include different selections or combinations for the interior and exterior features, colors, and engine power. Customization in automobile factories became more relevant with the arrival of numerically controlled machines and CAD/CAM technology. On the other hand, the modular home industry continued to produce factory-made homes without exploring the new possibilities of integrating such CAD/CAM/CNC tools.

In the modular home industry, clients can be actively involved in the design of their own modular house through choosing from a range of pre-designed floor plan options and selecting from the limited possibilities of interior and exterior finishes. And although architects view standardization as a restrictive aspect, this is not necessarily the case as architects should be able to utilize some standardized products without compromising their creative design. Therefore, a better modular home system would offer choices to clients and architects, but not

require the client or architect to select from limited design and finish options for the entire project. A system that would be successful would offer custom design by experts, each with a range of different options, to enhance the customizability of the modular home.

The existing “As-is” framework presented earlier shows that the modular home industry is an already established industry without the involvement of the architect. The output of such separation between the modular home industry and the direct involvement of the architect led to a world of monotonous houses. But the reality is that homes are diverse and can be designed based upon different quality aspects including scale, style, space, and cost. The major determinant of these qualities should be the architect, since he/she is the design’s only expert who can make those judgements. Hence, this dissertation calls for greater involvement of architects in the modular home industry.

Finally, design and fabrication technologies can focus on improving the quality of production processes. However, these technologies might not necessarily solve existing issues concerning stakeholders within the modular home industry, which suggests the need to rethink the relationships among these stakeholders. The proposed “To-be” framework may assist with redefining these relationships in both design and production and in the adjustment in expected results among the client, architect, engineer, general contractor, subcontractor, manufacturer, and fabricator.

6.2 Research Summary and Findings

By looking at the modular homes construction industry, there is often a noticeable lack of understanding of the constraints in linking architectural design to modular construction for single-family housing. In addition, no framework exists which seeks to support overcoming these constraints for the architectural design process while simultaneously bringing knowledge of fabrication, materials selection, and modular construction to the early stage of design.

This research intended to focus upon mapping the design and manufacturing processes for a specific scale of projects: residential single-family units. The research also aimed to understand the relationships among design, the role of emerging technologies, and manufacturing within the modular home construction industry in order to develop a design process that is based upon mass customization, not only mass production. Thus, qualitative research methods based upon a grounded theory approach were used for evaluating, capturing, and structuring knowledge. The evaluation process was addressed throughout five chapters:

The literature review was conducted as a two-tiered approach. Chapter 1's general background information was explored as an introduction to identify the state of knowledge related to these topic areas and to identify issues and problems.

Chapter 2's interpretive literature review assisted in categorizing and extracting related information directly to the knowledge capturing process. The chapter was divided into four main sections (domains of knowledge), which were: 1) design, 2) modular manufacturing/fabrication, 3) transportation, and 4) assembly. The benefits and efficiency of earlier collaboration between different teams from different disciplines, through the design, manufacturing, and construction processes were discussed. Learning from previous problems and limitations of other industries were presented as well. Additionally, the chapter discussed the importance of Information technology (IT) systems such as computer-aided design (CAD), computer-aided manufacturing (CAM), computer-numerical control (CNC), and building information modeling (BIM) to the modular home industry, and the benefits of using them.

Chapter 3 dealt with the research methodology and techniques applied in this investigation. As mentioned earlier, the grounded theory approach was used to capture and structure knowledge related to the design and manufacturing processes for single-family modular homes. The chapter described the procedures and methods used in this study. Three research tactics were used: 1) literature review, 2) case studies, and 3) interviews. Literature review, as discussed previously, was considered a key factor in seeking prior and recent relevant information and data within a particular field. Case studies, as a research method, were used to collect in-depth information about a limited number of specific cases and projects. Interviews, to achieve the greatest possible amount of useful information, were structured and conducted as in-depth and open-ended interviews with selected industry practitioners. Interviews, as a research technique, were considered to be a good source of information mainly from the multiple stakeholders involved within the modular home construction industry. The interview questions were developed based upon the information gathered from the literature review and case studies.

It should be noted that the grounded theory research method develops theory through the analysis of collected data, giving it a value as compared to traditional research methods where preconceived theories are investigated. The adopted methodology and data collection methods used in this research added significance to existing knowledge. Following the grounded theory approach results in the emergence of a theory; however, in this research, analyzing and understanding the link among the three domains of architectural design, modular construction homes, and emerging technologies led to a shift in other theoretical positions related to the design and modular home manufacturing processes. Figure 6.1 shows how the interactions

among the three domains led to these new theoretical positions: descriptive theory led to a new normative theory for the process of designing and manufacturing modular homes. Descriptive theory simply describes an observed behavioral relationship between all participants involved in a project that are controlled by guidelines or rules, whereas normative theory is concerned with how participants are going to make the decisions consistent with, or based upon, rational analysis and agreed-upon reasons. It is important to understand that both theories are closely linked to the proposed “To-be” framework as a procedural model. A significant contribution to this research’s body of knowledge is that a consensus exists among some of the interviewees’ leaders and experts in the modular home industry with regard to the proposed framework of the design and manufacturing development phases. Another contribution is how important and helpful it is to have such framework diagrams as an educational method for all current and new participants involved in a modular home project for understanding the scope of work, the constraints, and the different teams involved and their responsibilities in the process.

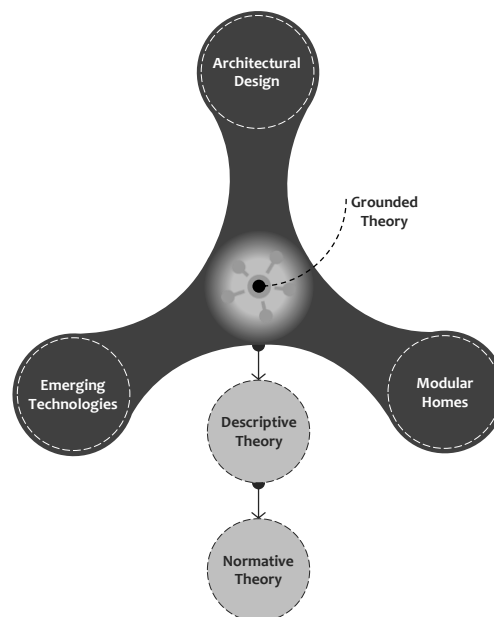

Figure 6.1: A shift in other theoretical positions related to the design and modular home construction processes.

Chapter 4 presents an immersive study interpretation. The chapter discusses the extracted information and findings of the case studies (on-site visits to modular home production facilities) and 13 open-ended interviews with modular construction industry experts (architects, engineers, production managers, business managers, and owners). Four on-site visits were completed at different modular manufacturer locations, each of which was based upon two parts: a tour of the facility to observe the production line and then conducting expert interviews. The gathered data and information were analyzed and synthesized by following the coding

phases as described earlier, which assisted in categorizing and extracting related information directly to the knowledge capturing process. A summary of the main findings and of the principal issues and suggestions which arose from the interviews were provided in the fifth chapter.

Chapter 5 used the interview data that was analyzed in the fourth chapter to map the existing “As-is” framework and then propose a “To-be” framework, which was concerned with the design and manufacturing phases. The Integration Definition (IDEFo) for Function Modeling was used as a graphical presentation technique. The goal of using such a graphical technique was, first, to understand and analyze the functions of the existing design-manufacture communication process; and second, to enhance and improve the communication and productivity performances among people working in the design, manufacturing, and production sectors. Using this graphical modeling method assisted with mapping the design and modular manufacturing processes, including organizations, teams, decisions, actions, and activities.

Mapping the “As-is” framework for design and manufacturing processes assisted in understanding how the single-family modular home construction industry begins with the design process and ends, through communication and information flow among different teams, with manufacturing the project. Additionally, the “As-is” framework also assisted with identifying issues of fabrication and modular construction earlier in the design process, such as:

- **Lack of architect involvement:** Through the demonstrated “As-is” IDEFo models (Chapter 5), it was shown that the architect is not involved in any of the design or manufacturing processes. All modular manufacturers commonly have developed a number of standard single-family home floor plans with limited design options. Moreover, almost all of the pre-designed floor plans are traditional in style. Most of these floor plans focus only on the functional configuration, such as living area, dining room, kitchen, bedrooms, and bathrooms and does not take into consideration the client’s desire of designing spaces that elevate quality of life. Also, pre-designed floor plans do not include exterior on-site construction work, such as garages and porches, which usually affect the unity of the project’s aesthetic appeal.
- **Direct communication challenges:** The process of information gathering and analysis is one of the most important steps before design begins. However, the “As-is” framework illustrated that there is no direct interaction between the client and the engineering team during the design phase. All communications regarding design currently go through the builder first, to the sales representative next, then to the engineering manager, and finally to the engineering team (a lengthy, sequential process). Having the

client's design requirements carried through different departments sequentially during the conceptual design process increases the chance of mistranslating the user needs and requirements. Another problem with poor communication would be failing to take the design quality aspect into account. Quality should be managed not only during the off-site construction phase, but also throughout the on-site assembly phase of the project. Perhaps the most disadvantageous aspect of the sequential modular construction process for single-family homes is problems occurring as a result of the poor communication between the builder and the local contractor.

- Building systems: There are about 45 production activity steps that most modular manufacturers follow for off-site construction. It can be seen in Table 5.7 that all 45 production activity steps are related to the structural, services, and finish systems, and none are related to the enclosure system. When the interviewees were asked which one of the four building systems (structural, services, finish, or enclosure systems) requires more attention, all interviewees from the modular manufacturers group mentioned the structural system, whereas all interviewees from the architectural side indicated the enclosure system.

Understanding and learning about design and manufacturing process issues related to the “As-is” framework assisted with the development of the “To-be” framework. To enhance the quality of design, it is important to improve the relationship between architects and modular single-family home manufacturers. Unlike the existing “As-is” framework where there is no direct interaction between the client and the engineering team during the design phase, the proposed “To-be” framework shows the architects’ early involvement beginning with a direct meeting between the architect, engineering manager, and sales representative. The “To-be” conceptual design process can assist with saving time and avoiding missing any information that might be lost in translation. Additionally, the sales representative (typically much less technical than the engineering manager) will be able to provide a much more accurate preliminary pricing proposal. For example, if the design requires special structural components, the engineering manager can point that out to the sales representative.

As learned from the previous “As-is” framework, most modular home manufacturers focus mainly on the design and manufacturing of the structural, services, and finish systems, where the enclosure system is typically not part of the design development process. Architects can assist with designing the enclosure system (sub-model) while controlling costs; however, a data analysis phase is an important sub-process within the design process and plays a key role in modeling. The Integrated Architectural Fabrication System (IAFS), as introduced in Chapter 5,

may help to not only bridge the gap between the enclosure system’s design and the modular home industry, it may also help to increase productivity, workflow, decision making, and profits while reducing operating costs. Through development of the design, more information (such as material properties, dimension, and structure) will be added to the model. This information assists in the evaluation of the design by generating information to be used in the “To-be” framework for manufacturing and assembly processes.

For successfully implementing the “To-be” framework, the modular home manufacturers need to agree, first, to shift in part from mass-production to mass-customization processes through the employment of prefabrication industry system concepts: in particular, closed and open systems, and technological advances such as CAD/CAM/CNC, which may also assist in bridging the gap between designing and manufacturing processes. Second, architects need to gain the experience and learn enough about the modular home industry in order to take on the role of the builder. Table 6.1 below presents the significant differences between the design and modular home manufacturing processes for “As-is” and “To-be” frameworks.

Table 6.1: The significant differences in the process for “As-is” and “To-be” frameworks.

“As-is” Framework	“To-be” Framework
<ul style="list-style-type: none"> • <i>Pre-designed floor plans (limited options)</i> • <i>Provided by a builder or manufacturer</i> • <i>Restricted finishes selection</i> • <i>No direct interaction between the builder and the engineering team during the design phase</i> • <i>The builder is not involved in the entire design and manufacturing processes</i> • <i>Poor communication between the builder and the local contractor</i> • <i>Volumetric off-site fabrication</i> • <i>Closed systems</i> • <i>Based on low technology mechanized hand tools</i> • <i>Focused mainly on structural, services, and finish systems</i> • <i>All of the building components Manufactured in-house by one company</i> 	<ul style="list-style-type: none"> • <i>Custom design</i> • <i>Designed by an architect</i> • <i>Non-standard finishes</i> • <i>Direct interaction between the architect and the engineering team during the design and manufacturing phases</i> • <i>The architect is involved in the entire design and manufacturing processes</i> • <i>Better communication among the stakeholders</i> • <i>Non-volumetric and volumetric off-site fabrication</i> • <i>Closed and open systems</i> • <i>Low technology mechanized hand tools and advanced technologies (CAD/CAM/CNC)</i> • <i>Concentrated on all four main systems: structural, services, finish, and enclosure systems</i> • <i>Some of the main systems’ components can be separated and recombined as sub-modules of the main project modules.</i>

6.3 Contributions to the Body of Knowledge

As discussed earlier in the introductory chapter of this research, there is a need to restructure the process of communication among all parties involved, beginning with design, extending through manufacturing and ending with the on-site installation of the project. The findings from this research will hopefully make several contributions to current architectural education and the architectural, engineering, manufacturing, and construction (AEMC) industries with seamless collaboration between these different domains.

For architectural education, the outcome of this research may assist students' understanding of the design concept for building systems based upon production processes. It may also help them better understand and increase their knowledge regarding the methods of building and the role of advanced computation technologies within the manufacturing industry as well as improve their analytical design problem solving abilities for manufacturing. The researcher intends to extend the knowledge of design and manufacturing for modular home projects by developing a curriculum proposal that can be implemented in many professional degree programs for both undergraduate and graduate studies in the architectural field.

The research aims to better elucidate the relationship between the design and modular home manufacturing processes through mapping these two domains. Following the mapping process, the new "To-be" modular housing design and manufacturing model was proposed. The proposal of this particular model further enhances the role of the architect in the design and manufacturing processes which results in unique designs catering to the users' needs and to a future of mass-customization of modular housing that takes into consideration the different sites' requirements and conditions. One of the important knowledge contributions of this research study is demonstrated through the interviews and knowledge capturing process with modular home industry experts. It appears that experts from both sides (architects and modular manufacturers) have different professional visions of/for the modular home industry. While modular home manufacturers concentrate more on the standardization and production efficiency, the architects focus more on the quality of design, energy efficiency, and aesthetics. This research is considered the beginning of connecting the dots between quality of design and production efficiency among the different disciplines throughout the various stages (activities) in the design and manufacturing processes.

Additionally, the proposed "To-be" framework will utilize and redefine the role of advanced technologies such as CAD/CAM/CNC/BIM in order to enhance the level of automation in the manufacturing process. However, there is a need to integrate and involve the various design



development stages of different building systems. Such integration may not only enhance the manufacturing production process but also enhance the quality of design. It may also interest more architects in developing new designs that would not be able to be built with typical on-site construction methods. Current research identifies and maps strategies to help overcome the barriers to and the constraints of the implementation of such advanced technologies. The impact of this research's outcomes on the practice of AEMC industries may enhance design methodologies and processes through the introduction of an efficient system in the present digital information age.

6.4 Future Research

One important knowledge contribution expected from this research is that it could provide a type of reference or guideline to develop the Integrated Architectural Fabrication System (IAFS) as a decision support tool. Presently there is no software tool developed for analyzing and evaluating the design of an enclosure system. The IAFS focuses on interactively exchanging information between the three different knowledge domains of design, materials selection and fabrication techniques.

The proposed “To-be” framework will be used to develop The IAFS software tool. The IAFS and “To-be” framework will be tested in a prototype fabrication facility for developing a modular single-family home within the context of Saudi Arabia, through the King Abdulaziz City for Science and Technology (National Labs of Saudi Arabia).

Future research will also aim to develop a “design language” to support variety in the modular housing industry. The term “design language” is used to mean a pattern language, a term first used by architect Christopher Alexander. In the book, *A Pattern Language* (Alexander et al., 1977), Alexander and his colleagues provide the following definition of pattern language: “The elements of this language are entities called patterns. Each pattern describes a problem which occurs over and over again in our environment, and then describes the core of the solution to that problem, in such a way that you can use this solution a million times over, without ever doing it the same way twice” (p. x). According to this definition, the term pattern language has come to be used to refer to a specific design approach that can provide different solutions. For example, limited design variation in single-family modular homes is considered one of the major issues that has held back off-site construction from expanding within the housing development sector. In addition, the lack of involvement by architects in the modular building industry increased the problem.



Today, there is a need to adopt off-site modular housing as an alternative, innovative construction technology through understanding the barriers and constraints between architectural design and modular construction for the residential sector. Architects can enhance and expand the role of the modular housing industry with innovative designs and variations by understanding modular home construction techniques, limitations, and restrictions. Also, employment of technological advances such as CAD/CAM/CNC should help to bridge the gap between design and manufacturing.

An owner usually considers his/her home's appearance essential, so there is a need to develop a design language that can understand all of the different systems, which also operates within the limitations of the manufacturing processes. Such a design language can give potential owners the experience of instant changes and alterations until they reach their desired design. Additionally, rapid prototyping of the final design can be created in a matter of hours. This will give owners a unique hands-on experience very closely mirroring what the final design should be like.

There are four main phases in the modular housing industry: design, manufacturing, transportation and assembly. Each of these has its own characteristics, constraints, and limitations. However, in future research, the modular home prototype will focus only on the design phase through developing a “design language” to support variety in the modular housing industry. Additionally, understanding the potential impacts on design from other phases is a goal for this work.

The design language will be developed upon the collected and analyzed data of this research. When the design language reaches the point of development—where most of the abilities and limitations of the four main phases (design, manufacturing, transportation and assembly) in the modular housing industry are integrated within the design process—it will go through three different measurement stages for validation: 1) evaluation, 2) demonstration, and 3) testing. In the evolution stage, the researcher will design a small modular home via computer programs to evaluate a number of different design solutions and how the four main systems under design (spatial, structural, services, and enclosure systems) interact with each other. If the design at this point provides the needed solutions and requirements, the next validation stage is initiated.

In the demonstration stage, the researcher will present the developed design language to expert members within the modular home industry for feedback with respect to design and modular systems. Two different scales of modular homes will be demonstrated via 2D and 3D representations to the modular home industry's experts for feedback, using computer

programs for their professional perspective as well as the perspective of potential modular home owners. Then, the design language will be developed based upon the received comments and feedback.

The last validation stage, which is the testing stage, is intended to be within the modular home industry. A test through a modular home prototype via 2D and 3D representations using computer programs will be used to demonstrate the capabilities and different options that could be generated by using such a design language. The final version will then be completed based upon stakeholders' feedback and comments. Figure 6.2 presents the sequence of the three measurement stages for validation.

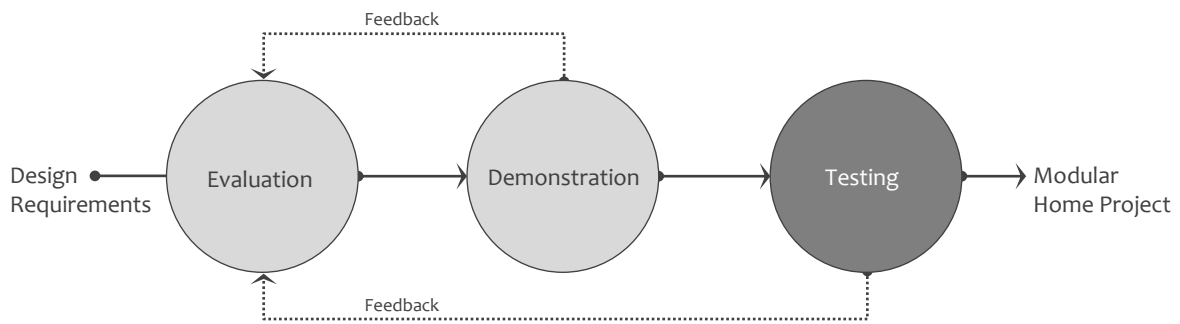

Figure 6.2: The three measurement stages for validation

7. References

AITSAHLIA, F., JOHNSON, E. & WILL, P. 1995. Is concurrent engineering always a sensible proposition? *Engineering Management, IEEE Transactions on*, 42, 166-170.

ALEXANDER, C., ISHIKAWA, S. & SILVERSTEIN, M. 1977. *A Pattern Language: Towns, Buildings, Construction*, Oxford University Press.

AMERICAN INSTITUTE OF, A. 2002. *The architect's handbook of professional practice. Student edition*, New York, Wiley.

ANDREASEN, M. M. 1994. Modelling--the language of the designer. *Journal of Engineering Design*, 5, 103.

ANG, C. L., LUO, M. & GAY, R. K. L. 1995. Knowledge-based approach to the generation of IDEFo models. *Computer Integrated Manufacturing Systems*, 8, 279-290.

ASHBY, M. F. 2005. *Materials selection in mechanical design*, Elsevier Butterworth-Heinemann.

ASHBY, M. F., FERREIRA, P. J. S. G. & SCHODEK, D. L. 2009. *Nanomaterials, nanotechnologies and design : an introduction for engineers and architects*, Amsterdam ; Boston, Butterworth-Heinemann.

AUSTIN, S., BALDWIN, A., LI, B. & WASKETT, P. 1999. Analytical design planning technique: a model of the detailed building design process. *Design Studies*, 20, 279-296.

BARTON, R. R. 2012. *Graphical methods for the design of experiments*, Springer Science & Business Media.

BECKER, H. S. 1998. *Tricks of the Trade: How to Think About Your Research While You're Doing It*, University of Chicago Press.

BENJAMIN, W., ARENDT, H. & ZOHAN, H. 1968. *Illuminations*, New York, Harcourt, Brace & World.

BONGIORNI, M. J. & COHORT, I. 2011. INTEGRATED PROJECT DELIVERY.

BOOTHROYD, G. 1987. Design for assembly—The key to design for manufacture. *The International Journal of Advanced Manufacturing Technology*, 2, 3-11.

BRAND, S. 1994. *How buildings learn : what happens after they're built*, New York, NY, Viking.

BROUGHTON, T. 1990. Simultaneous engineering in aero gas turbine design and manufacture. In *Proceedings of the 1st International Conference on Concurrent Engineering*, London, pp. 25–36.

BRYANT, A. & CHARMAZ, K. 2007. *The SAGE handbook of grounded theory*, Los Angeles; London, SAGE.

BUCKMINSTER FULLER INSTITUTE. 2010. *Dymaxion Bathroom* [Online]. Available: <http://bfi.org/about-bucky/buckys-big-ideas/dymaxion-world/dymaxion-bathroom> [Accessed August 2013].

CIRIA (1997) SNAPSHOT – STANDARDISATION AND PRE-ASSEMBLY, C. B. G., A.G.F., GROÁK, S. AND SPARKSMAN, W. G., CONSTRUCTION INDUSTRY RESEARCH AND INFORMATION ASSOCIATION, LONDON, PP. 1–8.

CORBETT, J. 1991. *Design for manufacture: strategies, principles, and techniques*, Addison-Wesley.

CORNICK, T. C. 1991. *Quality management for building design*, London, Butterworth Architecture.

DAVIES, C. 2005. *The prefabricated home*, London, UK, Reaktion Books.

DEAMER, P. & BERNSTEIN, P. 2010. *Building (in) the future : recasting labor in architecture*, New Haven; New York, Yale School of Architecture ; Princeton Architectural Press.

EASTMAN, C. M. 2008. *BIM handbook : a guide to building information modeling for owners, managers, designers, engineers, and contractors*, Hoboken, N.J., Wiley.

EKANAYAKE, L. L. & OFORI, G. 2004. Building waste assessment score: design-based tool. *Building and environment.*, 39, 851-861.

EL WARDANI, M., MESSNER, J. & HORMAN, M. 2006. Comparing Procurement Methods for Design-Build Projects. *Journal of Construction Engineering and Management*, 132, 230-238.

FA CONSULTANTS. 2014. *Single-Family Home Project* [Online]. Available: <http://www.faconsultants.net/> [Accessed March 2016].

FLYVBJERG, B. 2006. Five Misunderstandings About Case-Study Research. *Qualitative Inquiry*, 12, 219-245.

FORCE, U. A. Integration Definition For Function Modeling (IDEFo). 1993. ICAM.

FRIEDMAN, K. 2003. Theory construction in design research: criteria: approaches, and methods. *Design Studies*, 24, 507-522.

GAMBATESE, J. & HINZE, J. 1999. Addressing construction worker safety in the design phase: Designing for construction worker safety. *Automation in Construction*, 8, 643-649.

GANGOLELLS, M., CASALS, M., FORCADA, N., ROCA, X. & FUERTES, A. 2010. Mitigating construction safety risks using prevention through design. *Journal of Safety Research*, 41, 107-122.

GIANINO, A. 2005. *The modular home*, North Adams, Mass., Storey Pub.

GIBB, A. G. F. 1999. *Off-site fabrication : prefabrication, pre-assembly and modularisation*, New York, J. Wiley.

GLASER, B. G. & STRAUSS, A. L. 2006. *The discovery of grounded theory : strategies for qualitative research*, New Brunswick, N.J., Aldine Transaction (a division of Transaction Publishers).

GROAT, L. N. & WANG, D. 2002. *Architectural research methods*, New York, J. Wiley.

HART, C. 1998. *Doing a literature review : releasing the social science research imagination*, London, Sage Publications.

HAYS, K. M. 1998. *Architecture theory since 1968*, Cambridge, Mass, The MIT Press.

ILI, S., ALBERS, A. & MILLER, S. 2010. Open innovation in the automotive industry. *R&D Management*, 40, 246-255.

IWAMOTO, L. 2009. *Digital fabrications : architectural and material techniques*, New York, Princeton Architectural Press.

JENCKS, C. 1977. *The language of post-modern architecture*, New York, Rizzoli.

JODIDIO, P. 2004. *Architecture Now! 3*, Köln, Taschen.

JOHNSON, M. 2011. *Service level management : what you need to know for it operations management*, S.I., Tebbo.

KIERAN, S. & TIMBERLAKE, J. 2004. *Refabricating architecture : how manufacturing methodologies are poised to transform building construction*, New York, McGraw-Hill.

KIVINIEMI, A. 2011. The effects of integrated BIM in processes and business models. *Distributed Intelligence in Design*, 125-135.

KIVINIEMI, A. & FISCHER, M. 2009. Potential obstacles to use BIM in architectural design.

KNAACK, U. C.-K. S. H. R. 2012. *Prefabricated systems : principles of construction*, Basel, Switzerland, Birkhäuser.

KOLAREVIC, B. 2003. *Architecture in the digital age : design and manufacturing*, New York, NY, Spon Press.

KÜHL, I., LOWIS, K. & THIEL-SILING, S. 2008. *50 architects you should know*, Munich; New York, Prestel.

KUHN, T. S. 1962. *The structure of scientific revolutions*, Chicago, University of Chicago Press.

LAWS, K. & MCLEOD, R. Case study and grounded theory: Sharing some alternative qualitative research methodologies with systems professionals. Proceedings of the 22nd International Conference of the Systems Dynamics Society, 2004.

LEWIS, R. K. 2001. *Architect? : a candid guide to the profession*, Cambridge, Mass.; London, The MIT Press.

LI, H., HUANG, T., KONG, C. W., GUO, H. L., BALDWIN, A., CHAN, N. & WONG, J. 2008. Integrating design and construction through virtual prototyping. *Automation in Construction*, 17, 915-922.

LING, F., CHAN, S., CHONG, E. & EE, L. 2004. Predicting Performance of Design-Build and Design-Bid-Build Projects. *Journal of Construction Engineering and Management*, 130, 75-83.

MACDONALD, J. V. 2005. *High fit home: Designing your home for health and fitness*, HarperCollins.

MAURICE, M., PE 2008. Project Delivery Systems: Pro vs. Con. *Hill International, Inc.*

MCCMAHON, C. & BROWNE, J. 1998. *CADCAM : principles, practice, and manufacturing management*, Harlow, England; Reading, Mass., Addison-Wesley.

MULLENS, M. A. 2011. *Factory Design for Modular Homebuilding*, Constructability Press.

NEAL, J. 2001. *Architecture : a visual history*, London; New York, PRC Pub. Lt. ; Distributed in the U.S. by Sterling Pub.

NUNAN, D. 1992. *Research methods in language learning*, Cambridge; New York, NY, USA, Cambridge University Press.

O'LEARY, Z. 2010. *The essential guide to doing your research project*, Los Angeles, Sage.

O'DRISCOLL, M. 2002. Design for manufacture. *Journal of Materials Processing Technology*, 122, 318-321.

OHSUGA, S. 1989. Toward intelligent CAD systems. *Computer-Aided Design*, 21, 315-337.

PAHL, G. & BEITZ, W. 1984. *Engineering design : a systematic approach*, London; New York, Springer.

PENG, C. 2001. *Design through digital interaction : computing communications and collaboration on design*, Bristol, U.K.; Portland, Or., Intellect.

POTTMANN, H. & BENTLEY, D. 2007. *Architectural geometry*, Exton, Pa., Bentley Institute Press.

PRASAD, B. 1995. Sequential versus concurrent engineering - An analogy. *Concurrent engineering, research and applications*, 3, 250-255.

PRESLEY, A. & LILES, D. H. The use of IDEF0 for the design and specification of methodologies. *Proceedings of the 4th Industrial Engineering Research Conference*, 1995.

ROUSE, W. B. 1991. *Design for success : a human-centered approach to designing successful products and systems*, New York, Wiley.

SANI, P. 1994. Designs in the automotive industry. *Managing Intellectual Property*, 13-13.

SASS, L. 2007. Synthesis of design production with integrated digital fabrication. *Automation in Construction*, 16, 298-310.

SCHODEK, D. L. 2004. *Digital design and manufacturing : CAD/CAM technologies in architecture*, Hoboken, N.J., John Wiley & Sons.

SIEDEN, L. S. 1989. *Buckminster Fuller's universe : his life and work*, Cambridge, Mass, Perseus.

SMITH, R. E. 2010. *Prefab architecture : a guide to modular design and construction*, Hoboken, N.J., John Wiley & Sons.

SOHLENIUS, G. 1992. Concurrent Engineering. *CIRP Annals - Manufacturing Technology*, 41, 645-655.

SÖRENSEN, D. 2006. The Automotive Development Process. *The Automotive Development Process*. DUV.

STAIB, G., DÖRRHÖFER, A. & ROSENTHAL, M. J. 2008. *Components and systems : modular construction : design, structure, new technologies*, München; Basel [Switzerland]; Boston, Edition Detail, Institut für internationale Architektur-Dokumentation ; Birkhäuser.

STEVENSON, W. J. 1999. *Production/operations management*, Boston, Irwin/McGraw-Hill.

STRAUSS, A. L. 1987. *Qualitative analysis for social scientists*, Cambridge [Cambridgeshire]; New York, Cambridge University Press.

STRAUSS, A. L. & CORBIN, J. M. 1990. *Basics of qualitative research: grounded theory procedures and techniques*, Newbury Park, Calif., Sage Publications.

STRAUSS, A. L. & CORBIN, J. M. 1998. *Basics of qualitative research : techniques and procedures for developing grounded theory*, Thousand Oaks, Sage Publications.

TATUM, C. B., VANEGAS, J. A. & WILLIAMS, J. M. 1986. *Constructability improvement using prefabrication, preassembly, and modularization*, Construction Industry Institute, Stanford University, California, Technical Report No. 297, November.

THE MODULAR BUILDING INSTITUTE 2011. *Permanent Modular Construction 2011: Annual Report*.

TJALVE, E., ANDREASEN, M. M. & FRACKMANN SCHMIDT, F. 1979. *Engineering graphic modelling : a workbook for design engineers*, London; Boston, Newnes-Butterworths.

TOVEY, M. 1992. Intuitive and objective processes in automotive design. *Design Studies*, 13, 23-41.



TOVEY, M., PORTER, S. & NEWMAN, R. 2003. Sketching, concept development and automotive design. *Design Studies*, 24, 135-153.

VENKATACHALAM, A. R. 1992. Design for Manufacturability: A Survival Strategy for the American Manufacturing Industry. *Industrial Management*, 34, 7-7.

WATERS, J. K. 2003. *Blobitecture : waveform architecture and digital design*, Gloucester, Mass., Rockport Publishers.

WATKINS, A. M. 1984. *The complete guide to factory-made houses*, Piermont, N.Y., Building Institute.

YIN, R. K. 2009. *Case study research : design and methods*, Los Angeles, Calif., Sage Publications.

ZHOU, W., WHYTE, J. & SACKS, R. 2012. Construction safety and digital design: A review. *Automation in Construction*, 22, 102-111.