

A FRAME + INFILL HOUSE IN LIMA, PERU

A FRAME + INFILL HOUSE
IN LIMA, PERU
by Edwin Baruch

Thesis submitted to the faculty of the
Virginia Polytechnic Institute and State
University in partial fulfillment of the
requirement for the degree of:

Master of Architecture

James Jones, Chairman

Paul Emmons

Marcia Feuerstein

2017, April 27
Alexandria, Virginia

keywords: frame, infill, Peru, informal

ABSTRACT

This work is a study of the relationship between frame, infill, and earth. A search of structure defining space through threshold. Ultimately, it proposes a structural frame as a collection of rooms.

ACKNOWLEDGEMENTS

I wish to thank Jim Jones, Paul Emmons, Marcia Feuerstein, Humberto Rodriguez-Camilloni, William Tate, Jaime Ortiz de Zevallos, Ortrebor Jean-Francois, Renzo Martin Rodriguez Rivas, Jhenyfer Espinoza Falcon, Rigoberto Titi, and Max Werner.

Additionally, family, friends, colleagues, and professors, thank you.

This book is dedicated to my family for their love, patience, and support. Thank you Ed, Lucha, and Matty.

TABLE OF CONTENTS

| | |
|----|------------------------|
| 01 | Introduction |
| 03 | Search |
| 11 | Rooms |
| 25 | Site |
| 33 | Frame |
| 41 | Infill |
| 57 | Sources |
| 59 | Appendix A: Drawings |
| 81 | Appendix B: Precedents |
| 89 | Appendix C: Family |



01

INTRODUCTION

The work that follows explores structural parameters creating a framework for living. It does this through examining the relationship found between formal and informal building methods in Lima, Peru. Acknowledging the need to build gradually, a series of rooms were developed using the space provided by the frame. With the participation of a family of five, this model has been developed and applied to help guide in planning a structure for living and generating income over the period of a lifetime.

01. Perspective of a concrete frame.



01

SEARCH

The following images illustrate a building culture found throughout Peru. Informal neighborhoods bordering formal districts, developing and expanding the city of Lima.

Typically, settlers moving toward the city of Lima from Peru's mountain and desert regions creating shanty towns on undesirable land. Often staking out land, then building basic dwellings, self-constructed of straw, plywood, sheet metal, and other found materials on a floating foundation with the goal of eventually building in concrete. The combination of poor earth quality and building on floating foundations makes for a dangerous living situation. Eventually, building in concrete and masonry is typically a gradual process without professional guidance. The process of building a home incrementally over a lifetime is common and can be found in both informal and formal districts throughout Peru.

01. Contrast of two bordering districts in Lima. La Molina on the left, San Juan de Miraflores on the right.
02. Collage of building types found throughout Lima.
03. Self-constructed dwellings forming a neighborhood in Pamplona Alta, San Juan de Miraflores, Lima.
04. State of a home built gradually in Pamplona Alta, San Juan de Miraflores, Lima.
05. Hollow clay brick infill anticipating a concrete frame in Villa Maria del Triunfo, San Juan de Miraflores, Lima.
06. Columns and brick infill in Cajamarca, Peru.
07. An addition under construction to a home with a store in Cajamarca, Peru.
08. Concrete frame in Puno, Peru.





03



04



05



07



06



08

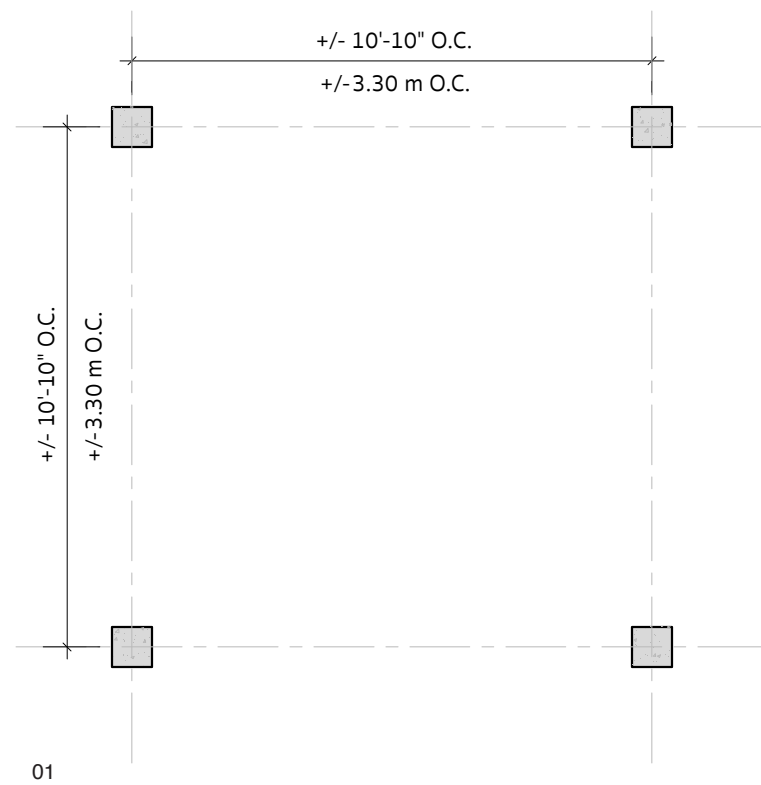

ROOMS

Working with the structural parameters of columns spanning approximately 10'-10" or 3.30 meters on-center, a series of rooms were developed within the space provided by (4) columns. The following graphics illustrate these rooms independently and dependently in various iterations, activating each other and creating dwellings at various stages or sizes.

01. Columns in plan (+/-) 10'-10" x 10'-10" on-center.
02. Bathroom and stair, to stack vertically.
03. Bedroom.
04. Kitchen, to stack vertically.
05. Dining room.
06. Living room.
07. Balcony / outdoor space.
08. Plan of a single square column grid showing a bathroom and stair. The bathroom and stair are shown to emphasize identifying the location of this block first, as it will stack vertically. Additionally, a section is also shown to show the orientation of the stair in elevation. Here, it has a floor-to-floor height of 9'-4" or 2.85 meters. Scale: 3/16"=1'-0".
09. 2-square column grid. Kitchen, bedroom, and bathroom (anticipating stair). Scale: 3/16" = 1'-0".
10. 4-square column grid. 2 bedrooms, kitchen, bathroom, and stair. Scale: 3/16"=1'-0".
11. 1/4" = 1'-0" scale model. 4-square column grid frame.
12. 1/4" = 1'-0" scale model. 4-square column grid gradual frame from the ground level to level 03.
13. 1/4" = 1'-0" scale model. 4-square column grid gradual frame and infill. A range from a 2-square house infilled to a 4-square house infilled on 3 levels.
14. 9-square column grid. 3 bedrooms, 2 bathrooms, 1 stair, kitchen, dining room, living room, and a central outdoor space.
15. 1/8" = 1'-0" scale model of 9 square house infill.

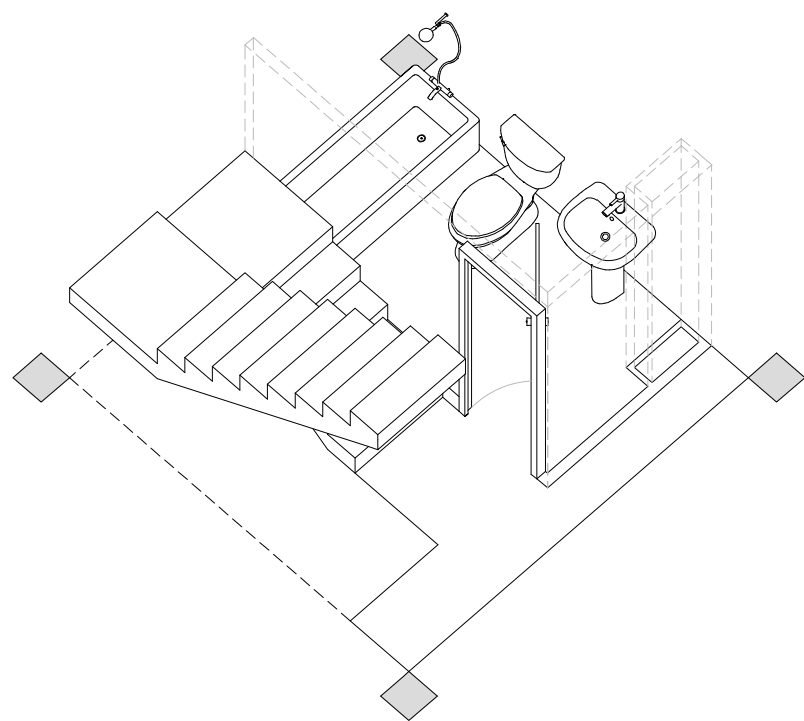

02

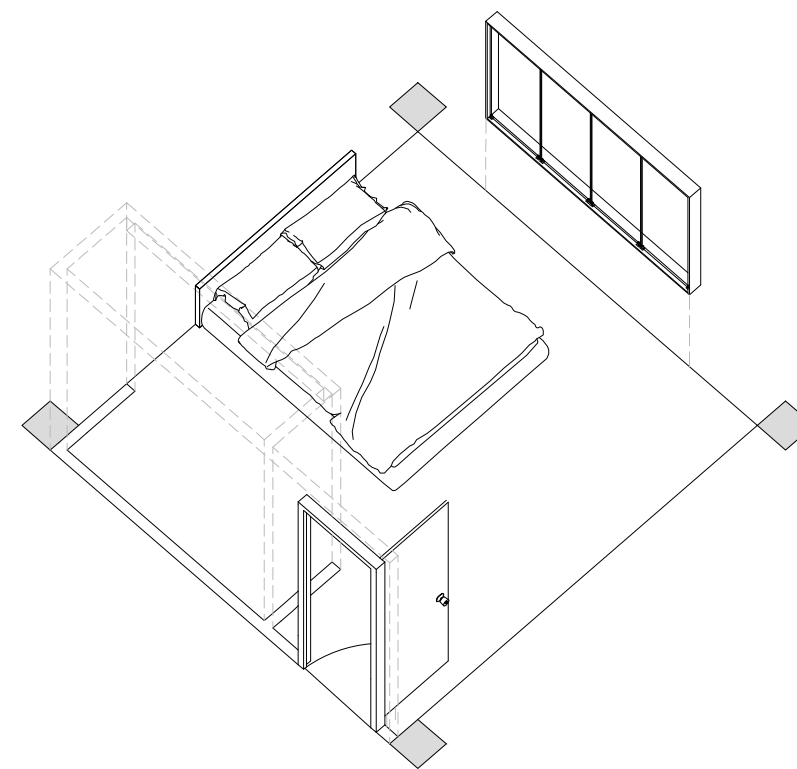

03

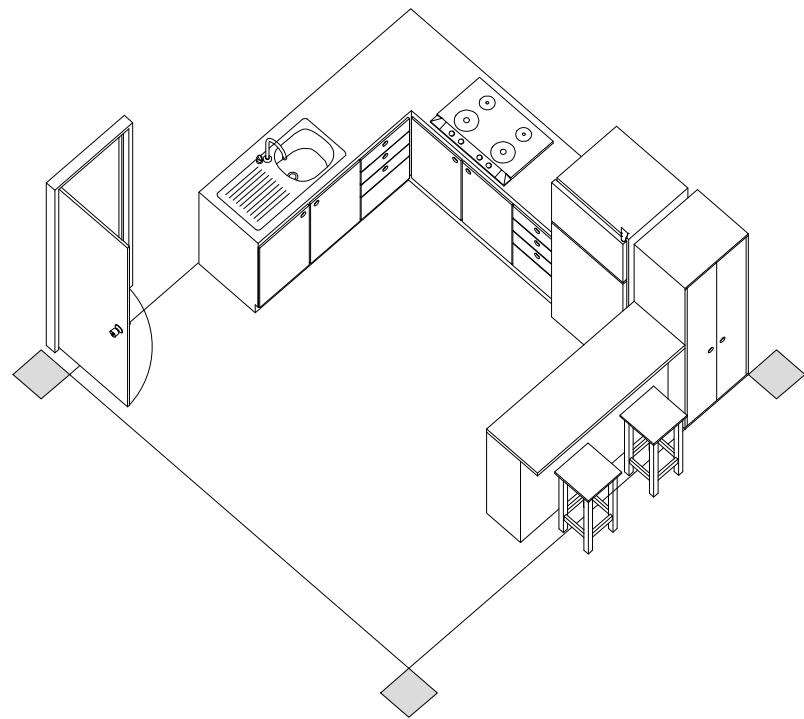

04

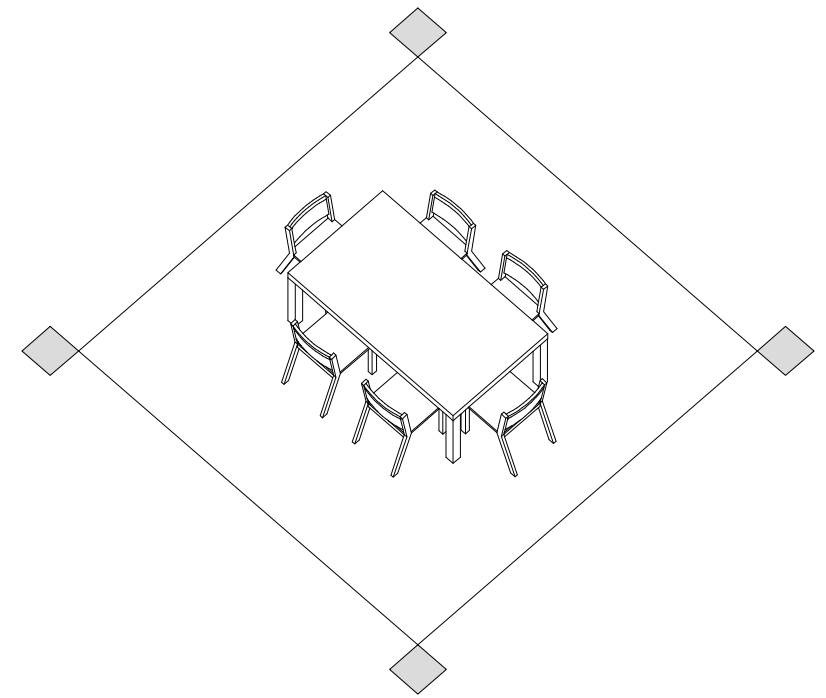

05

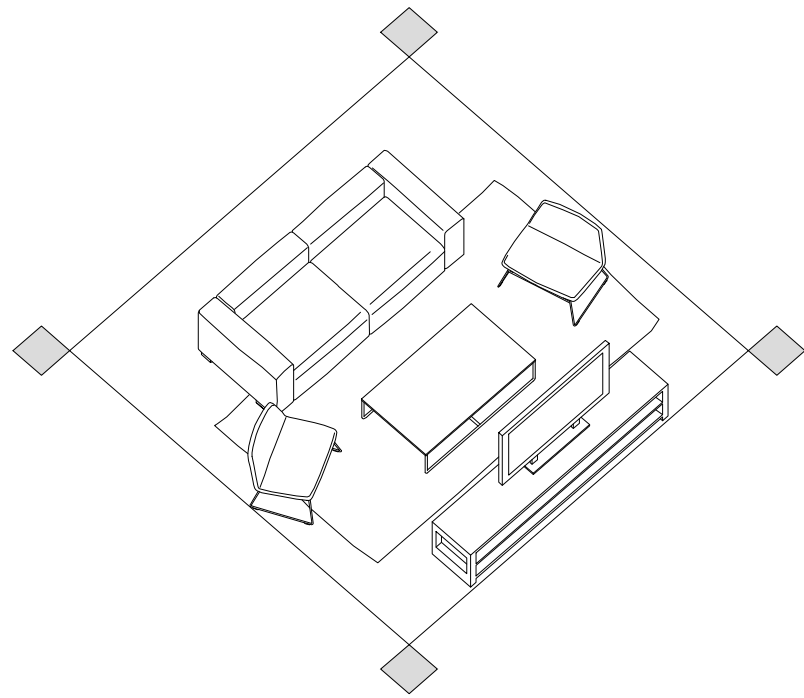

06

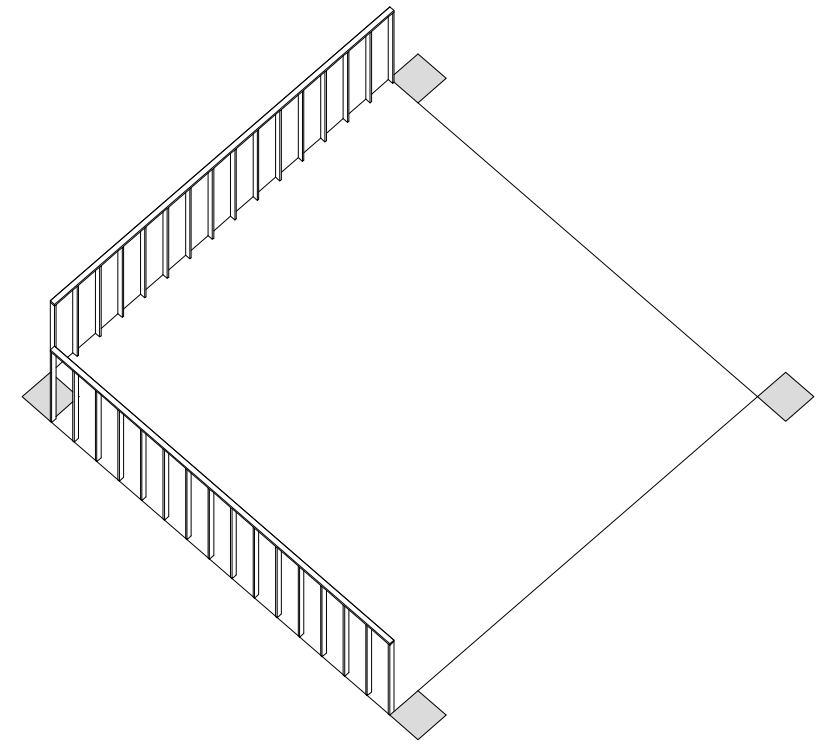

07

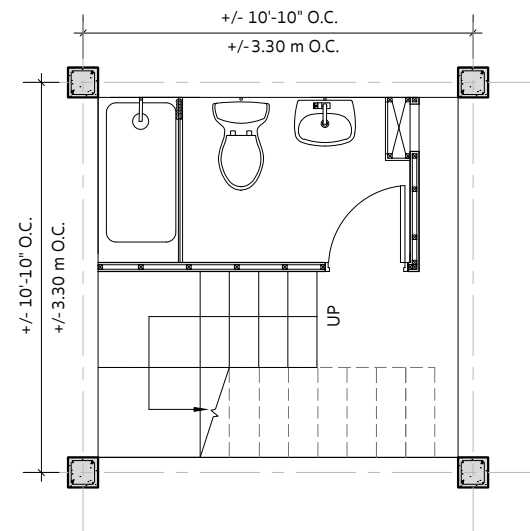

PLAN / PLANTA

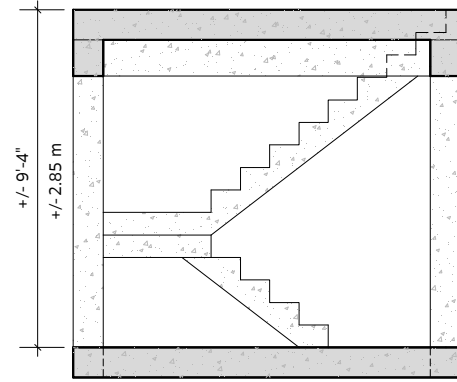

SECTION / CORTE

08

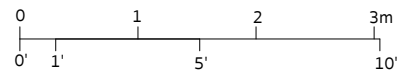
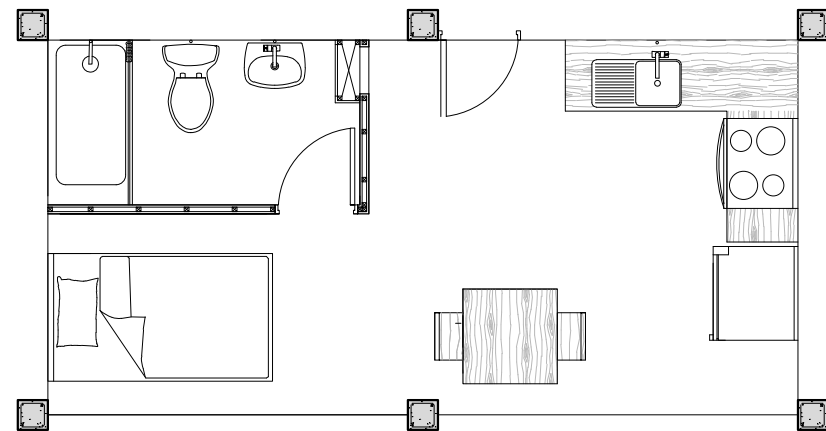

09

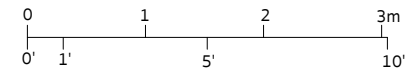
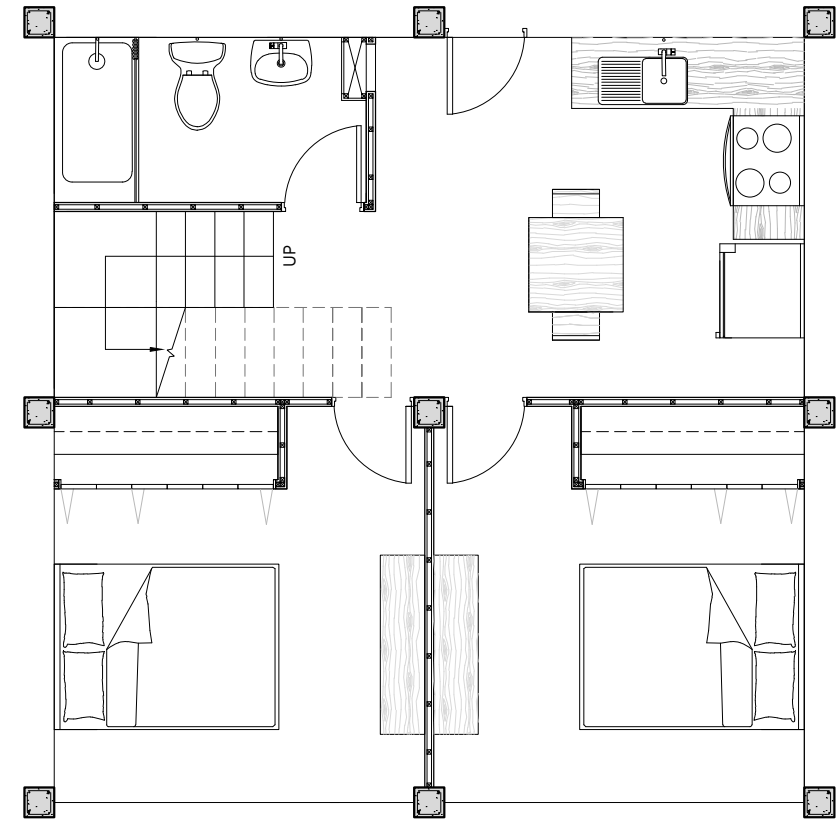

10



11

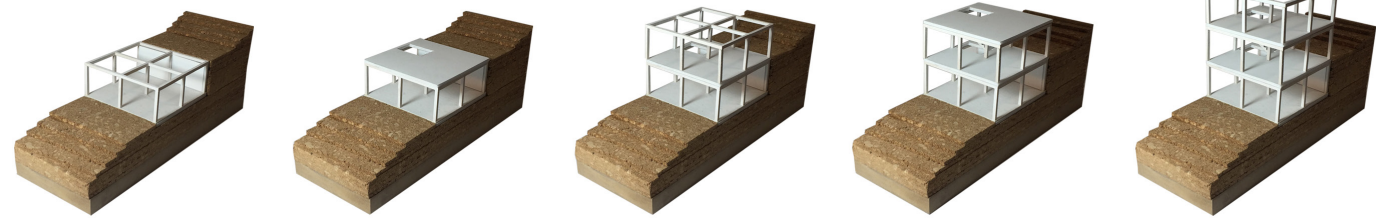

12

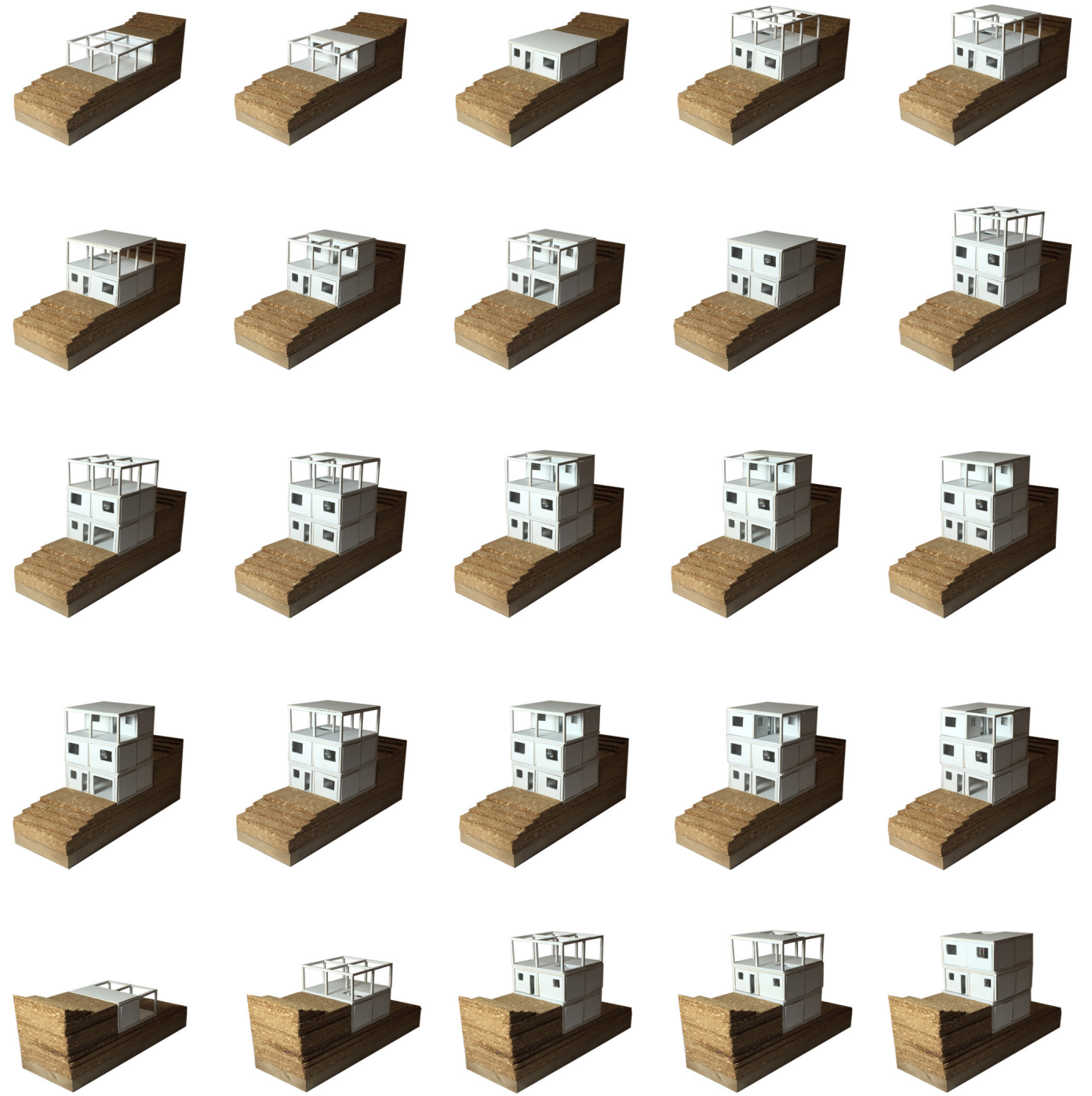

13

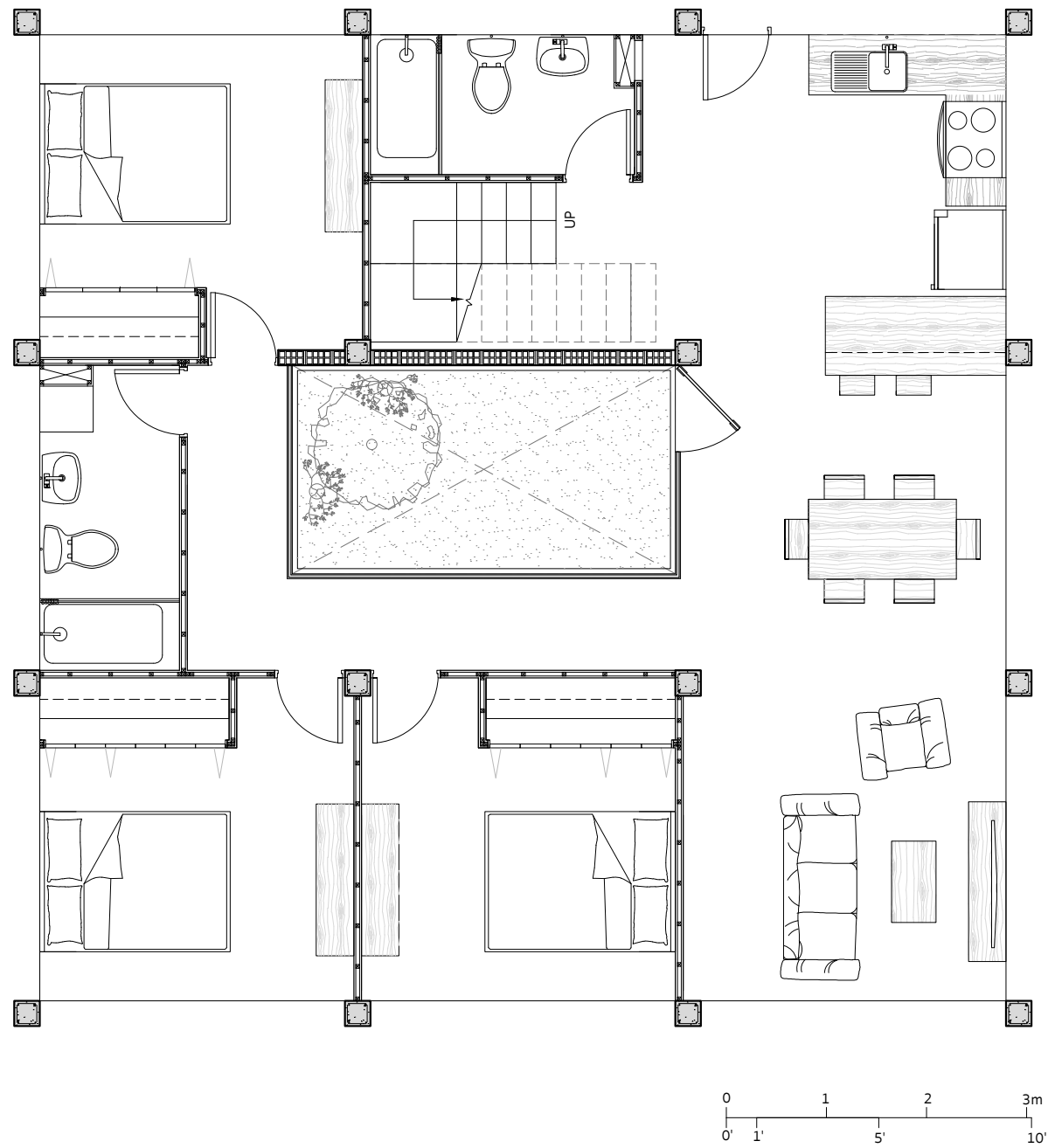

14

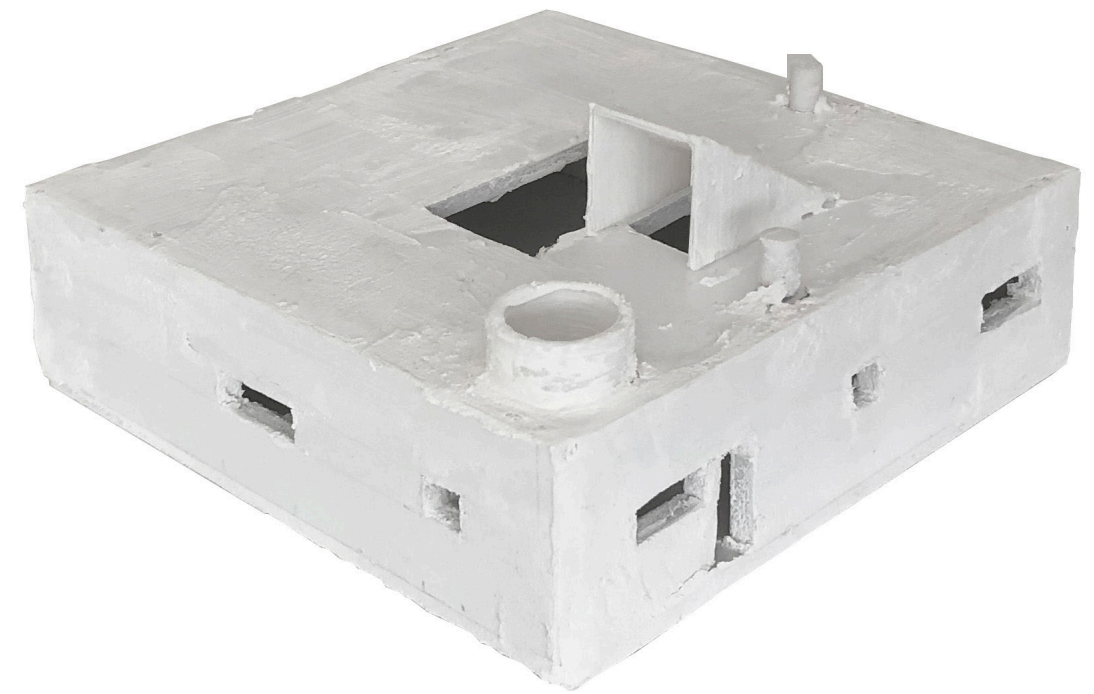

15



01

SITE

In January of 2017, contact with a family living in Villa Maria del Triunfo, Lima was established. The family currently lives in an informally built home constructed of mostly plywood and sheet metal over a floating foundation.

The family has the goal of building a structurally safe home with a frame of poured-in-place concrete. The home would need the flexibility of being built gradually over years, if necessary. It would need the ability to convert a portion of the first level to a bodega, as well as provide an office or additional working space, and entry to the home above.

01. Overview of neighborhood in Villa Maria del Triunfo, Lima.
02. Existing home, 2016.
03. Existing home with alterations, 2017.
04. Roof of existing home with addition of a bedroom and kitchen / dining room behind, 2017.
05. Bodega at entry of home, 2017.
06. 1/8" = 1'-0" scale model of existing home in 2016.
07. 1/8" = 1'-0" scale model of existing home in 2017.
08. Existing site plan. Scale: 1/8" = 1'-0".
09. Existing home, drawing in oil pastel.
10. Diagram of column grid over site, drawing in oil pastel.



02



04



03



05

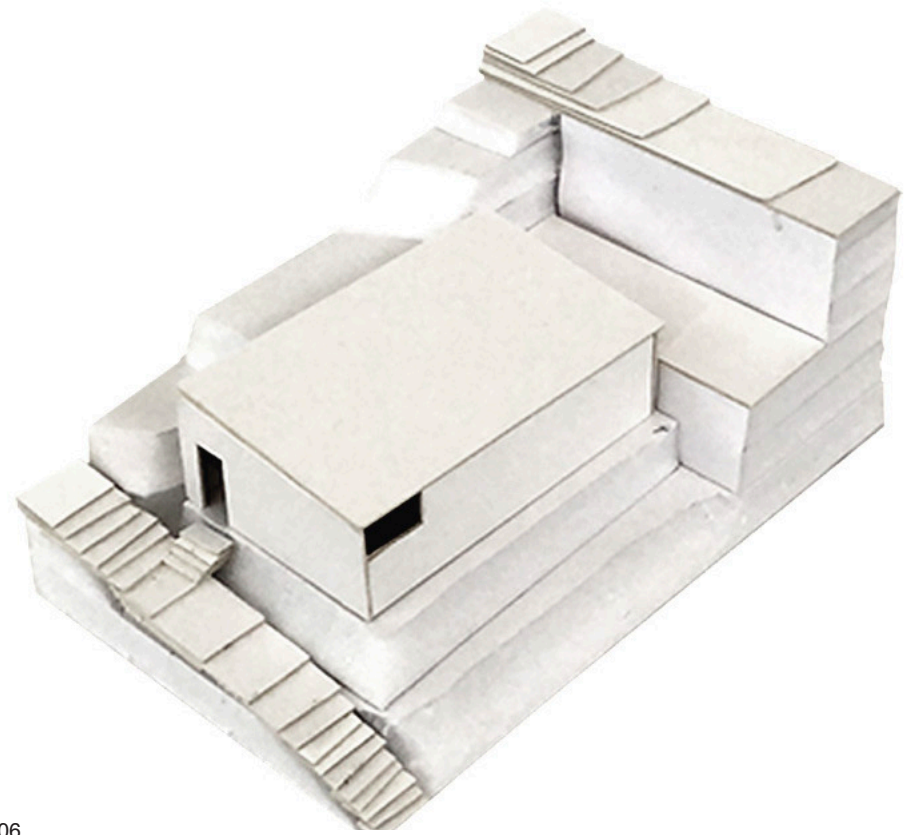

06



07

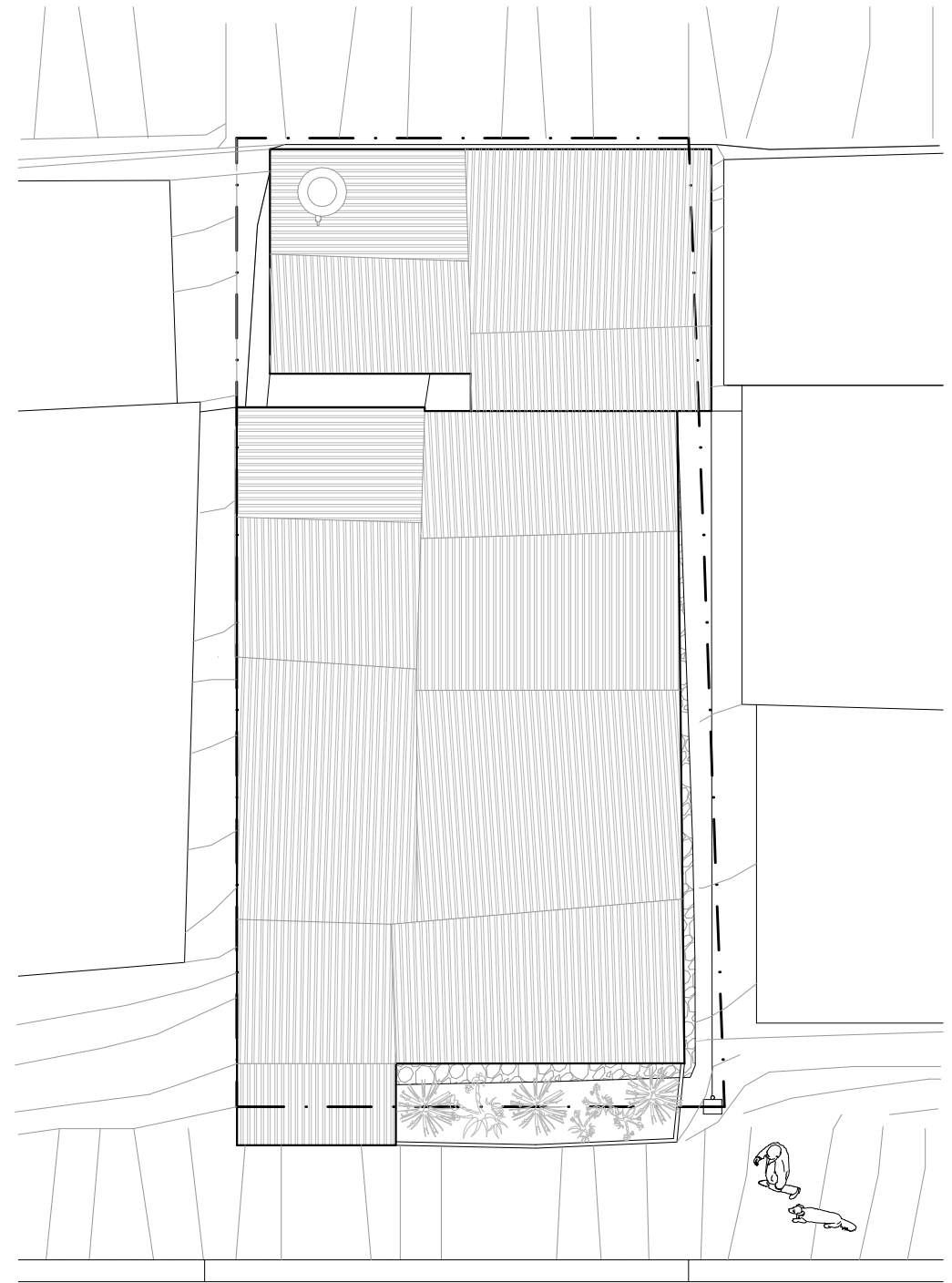

08

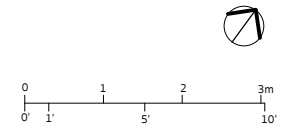

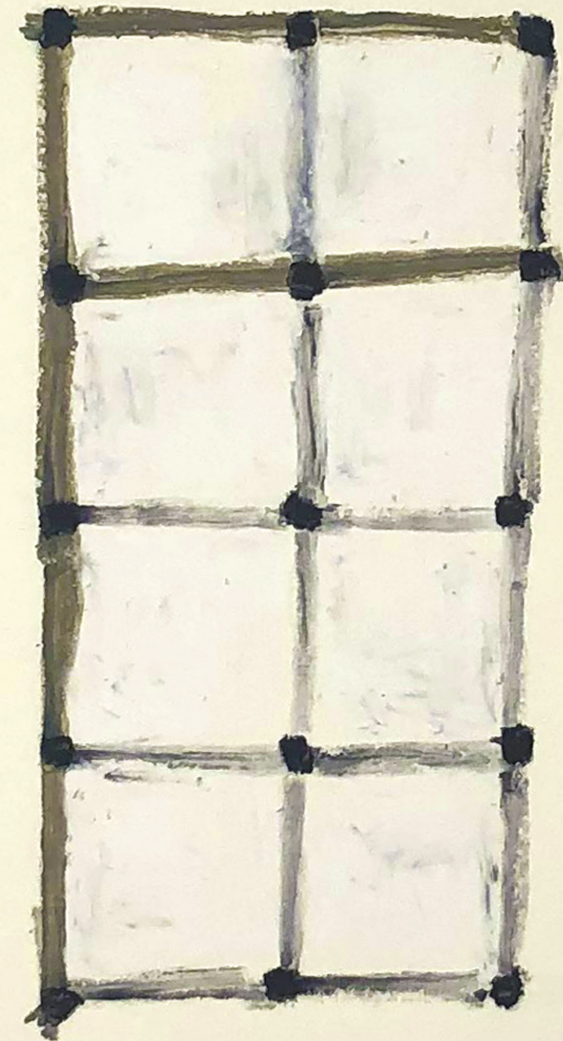

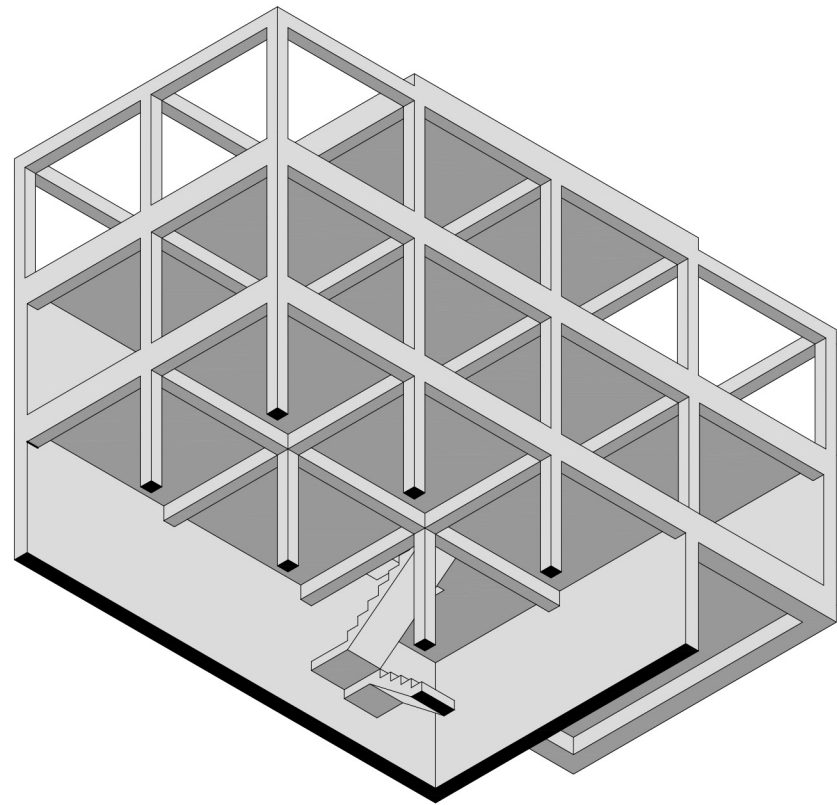

01

FRAME

After the application of a column grid to the site, spanning approximately 10'-10" on-center, the frame was established with the initial consideration of locating the stair and bathroom. The following graphics illustrate the proposition of the frame.

01. Worm's eye view of frame.
02. Axonometric drawing of foundation formwork.
03. Axonometric drawing of retaining wall formwork.
04. Axonometric drawing of column formwork.
05. Axonometric drawing of beam formwork.

The following images are of a 1/8" = 1'-0" scale model.

06. Existing home over floating foundation.
07. Demolition of existing home and floating foundation.
08. Retaining wall and slabs on grade.
09. Level 1 frame, columns and beams.
10. Level 1 frame supporting level 2 floor slab.
11. Level 2 frame, columns and beams.
12. Level 2 frame supporting level 3 floor slab.
13. Level 3 frame, columns and beams.
14. Level 3 frame supporting roof slab.
15. Level 3 supporting level 4 addition slab.
16. Level 4 frame, columns and slabs.
17. Level 4 frame supporting roof slab.

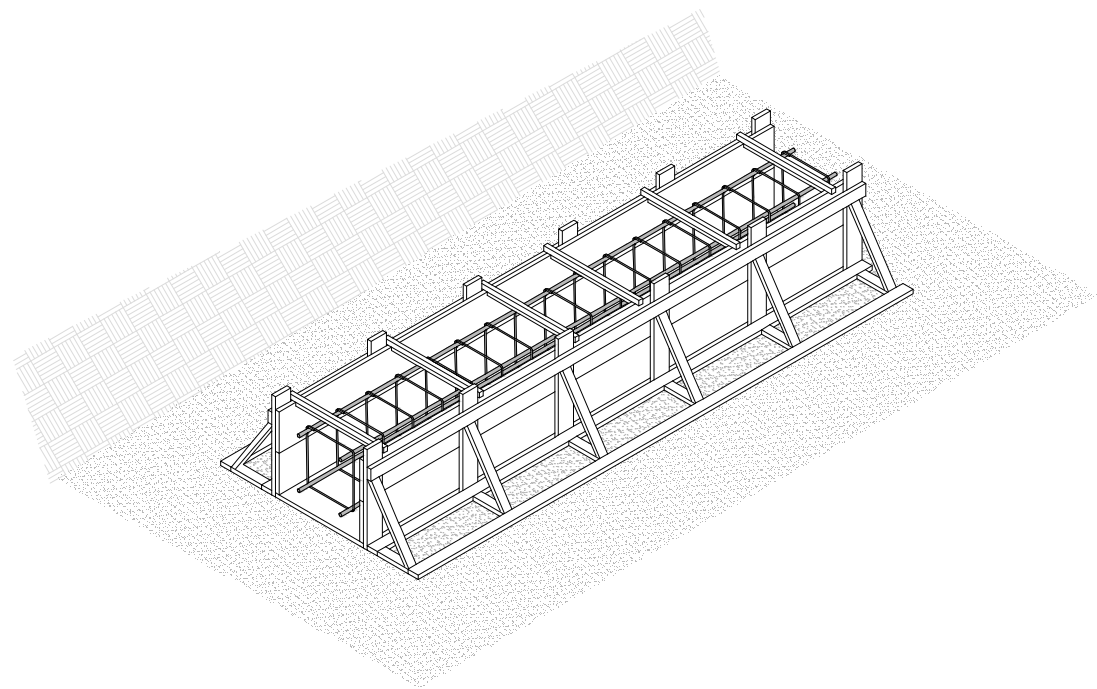

02

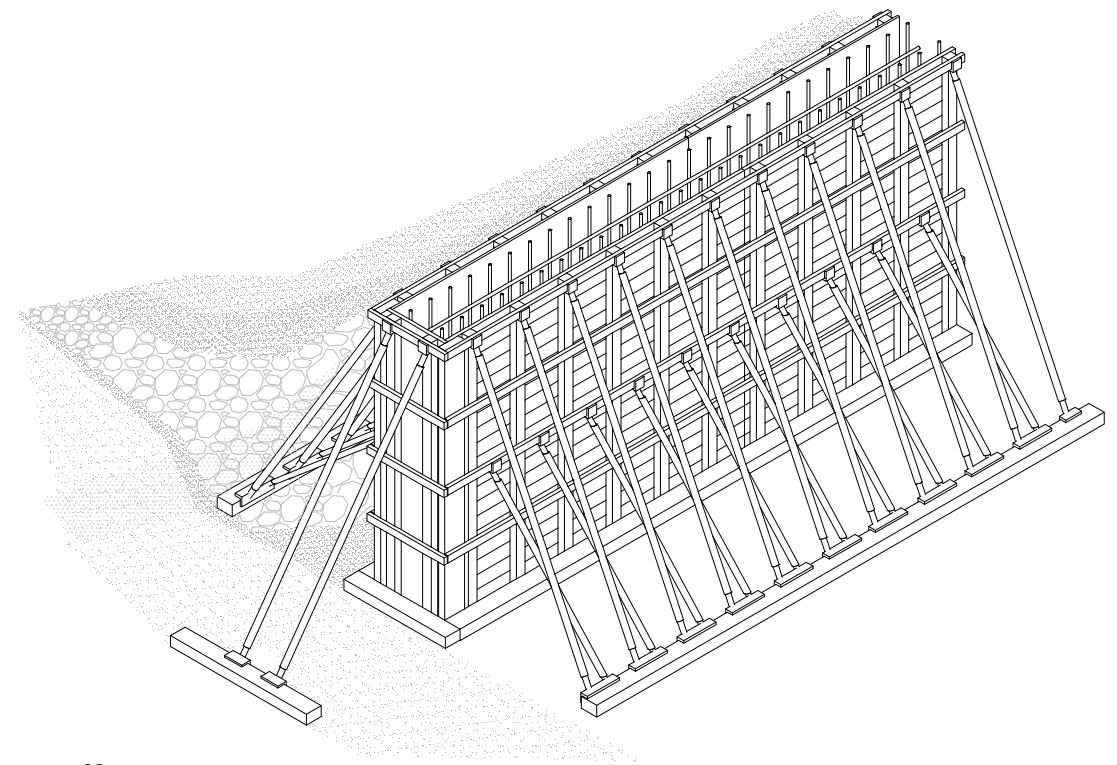

03

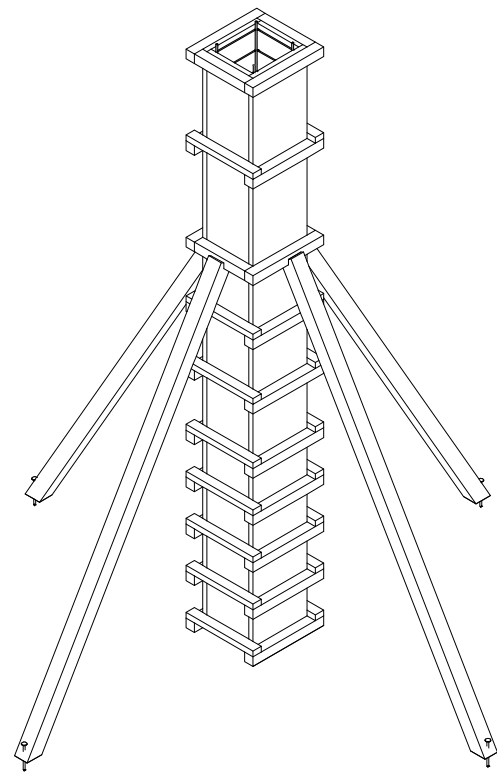

04

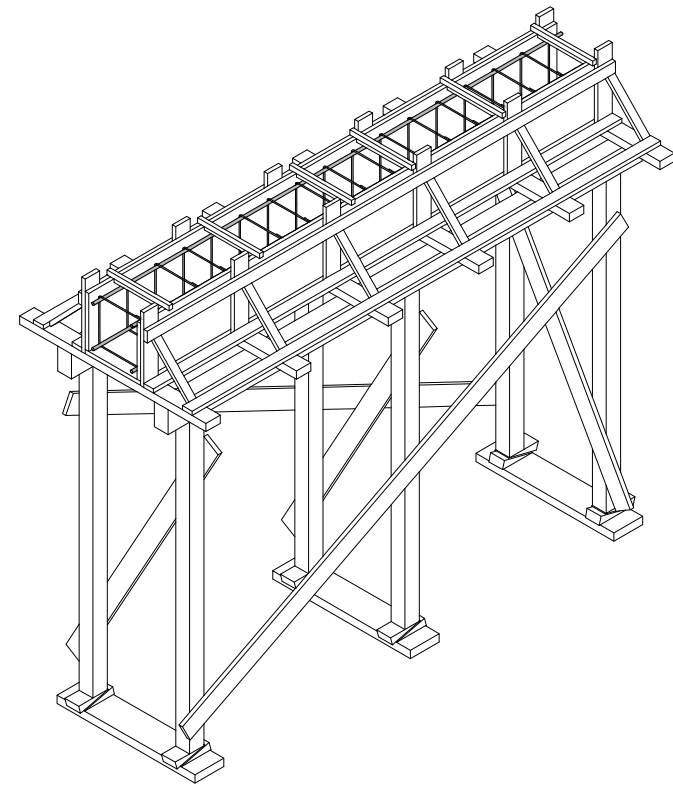

05

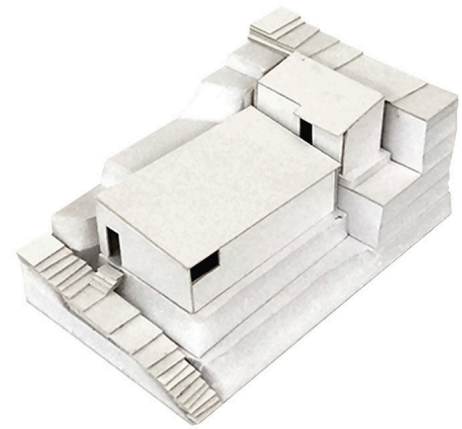

06

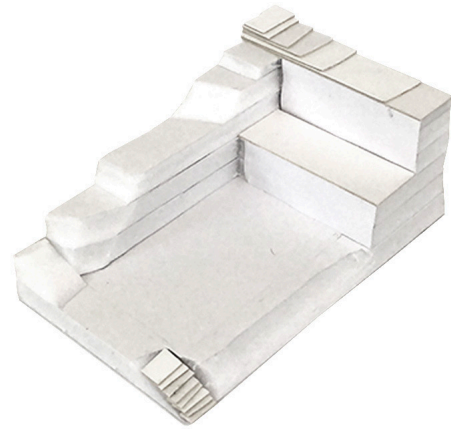

07

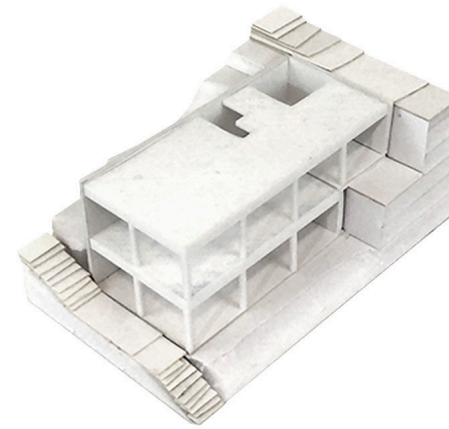

12

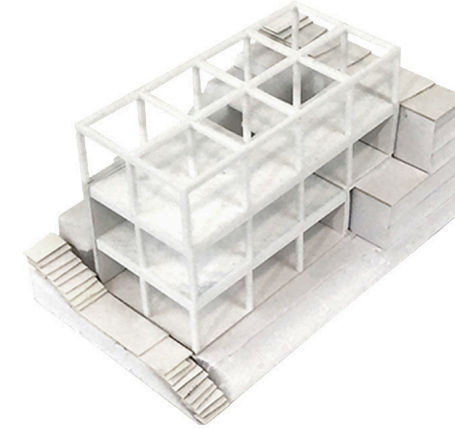

13

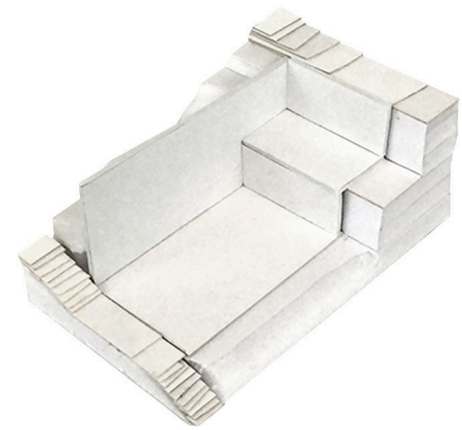

08

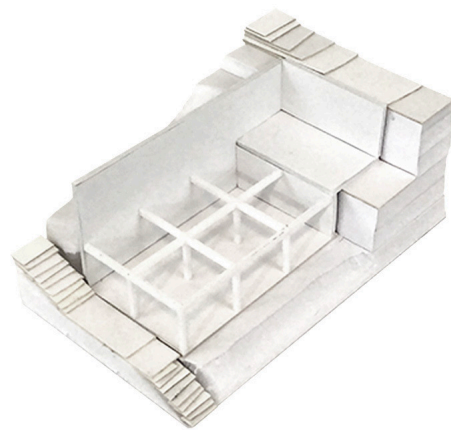

09



14

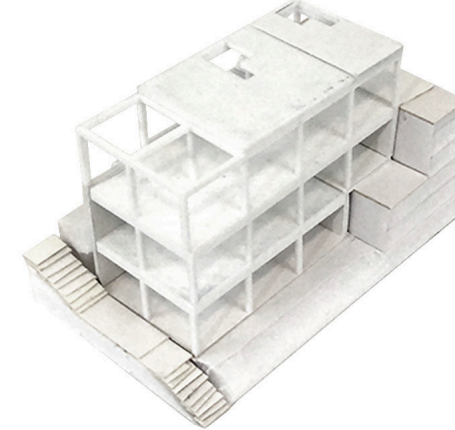

15

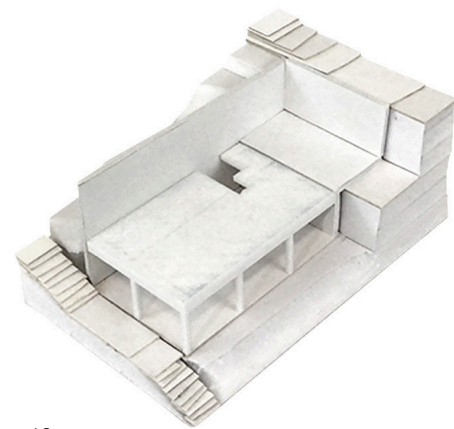

10

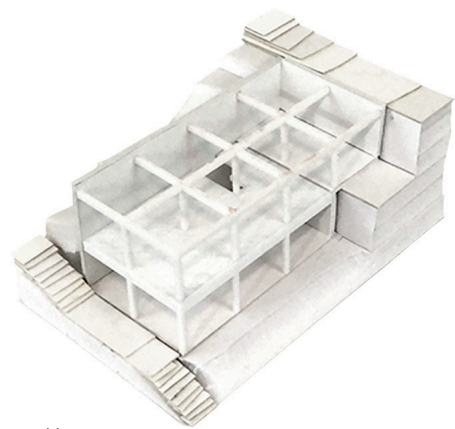

11

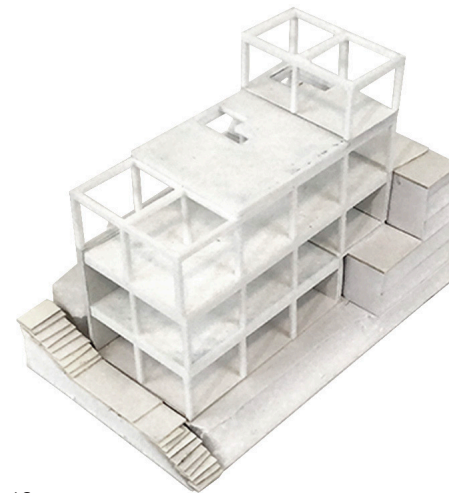

16



17



01

INFILL

The following graphics envision the infill of the proposed frame built up to third level. At this level of completion, the structure has a lower level functioning as a bodega and office/study, with the upper two levels providing the family two bathrooms, four bedrooms, a living room, a dining room for the daughters, a laundry room, a kitchen, a dining room, and multiple outdoor spaces.

01. Elevation looking south, model $1/4" = 1'-0"$.
02. Perspective looking north west, model $1/4" = 1'-0"$.
03. Perspective looking south east, model $1/4" = 1'-0"$.
04. Elevation looking north, model $1/4" = 1'-0"$.
05. Elevation looking south, model $1/4" = 1'-0"$.
06. Perspective at the courtyard, model $1/2" = 1'-0"$.
07. Perspective at the ground level looking out.
08. Perspective at the back room, model $1/4" = 1'-0"$.
09. Perspective at the back room.
10. Perspective at the bedroom.
11. Perspective at the stair and bathroom.
12. Perspective at the dining room looking out onto balcony.
13. Perspective at the balcony.



02



03

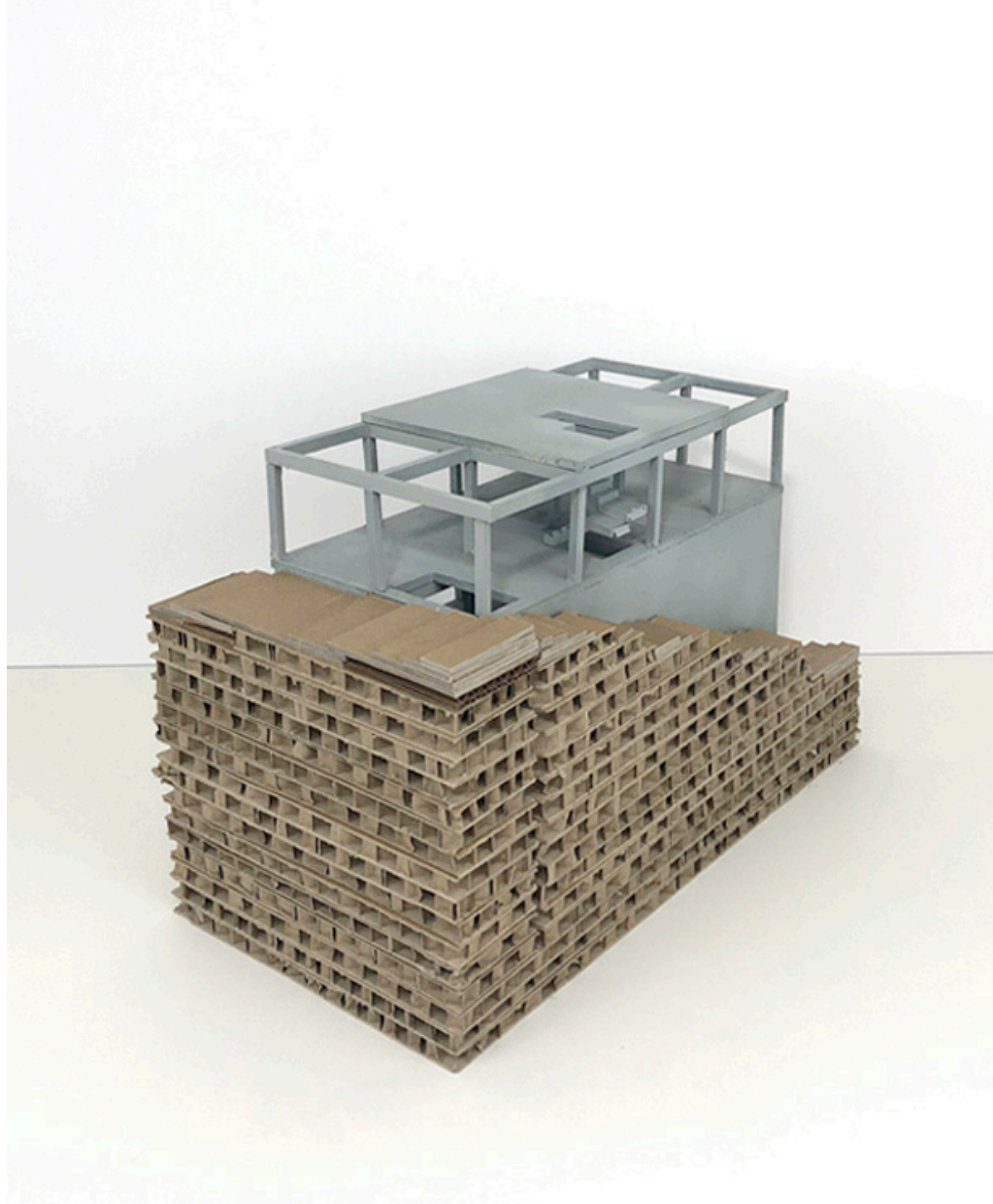

04

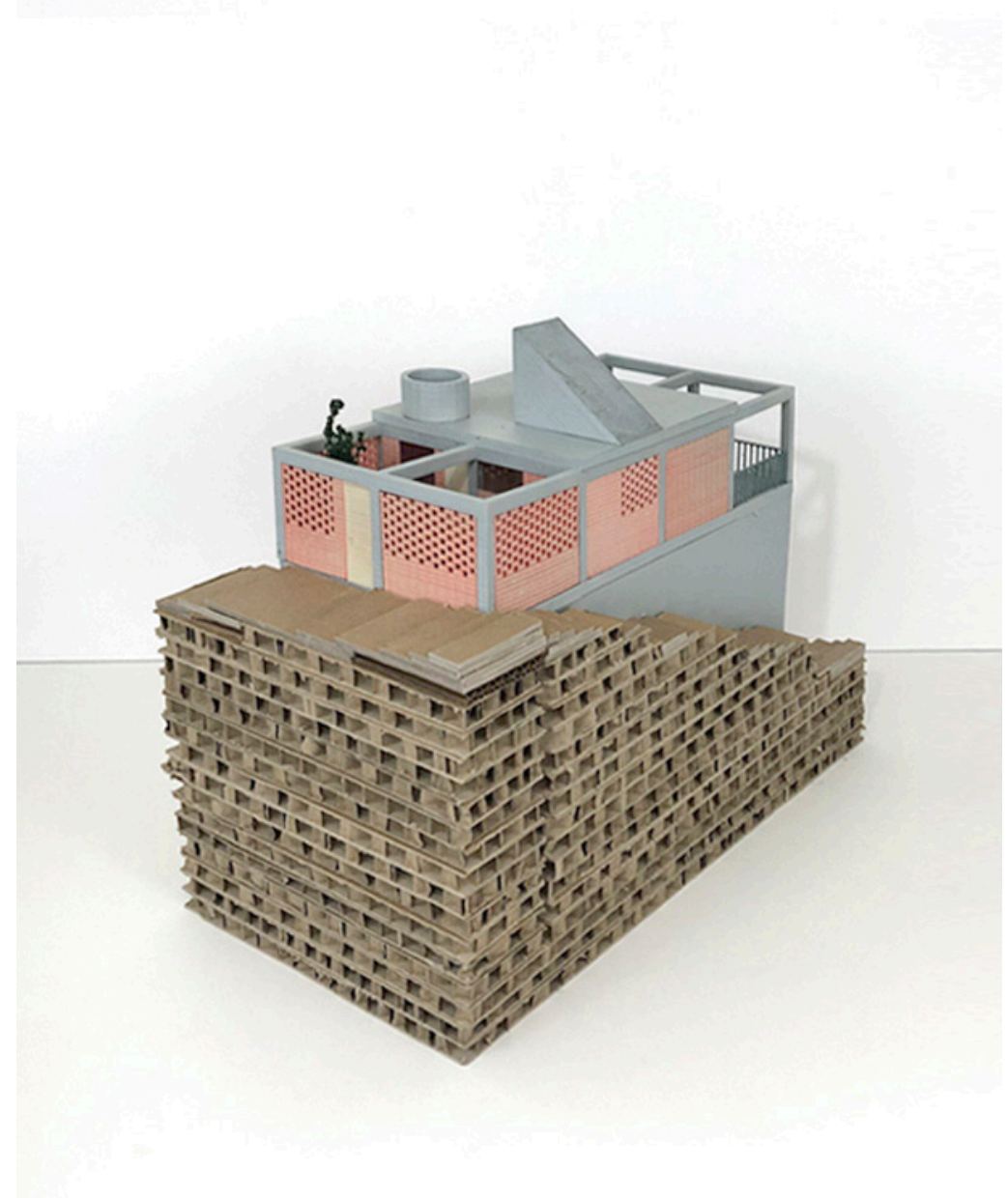

05



06

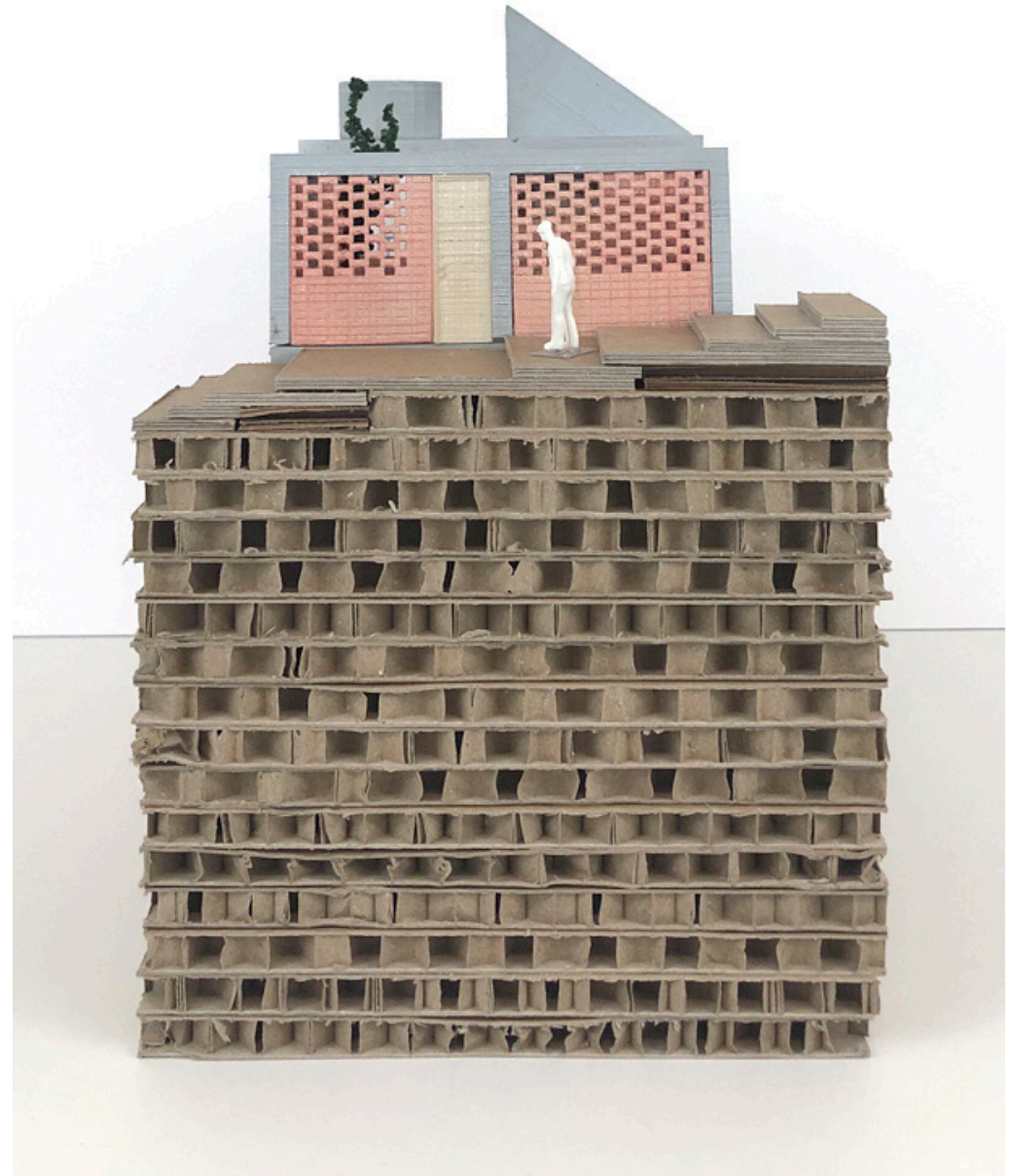

07



08



09



10



11



12



13



14



15

SOURCES

- Aghayere, Abi O. and George F. Limbrunner. Reinforced Concrete Design. 8th ed. Boston: Pearson, 2014.
- Aravena, Alejandro and Andres Iacobelli. Elemental: Incremental Housing and Participatory Design Manual. 2nd ed. Germany: Hatje Cantz, 2016.
- Ching, Francis D.K, Barry S. Onouye, and Douglas Zuberbuhler. Building Structures Illustrated: Patterns, Systems, and Design. 2nd ed. New Jersey: John Wiley & Sons, Inc., 2014.
- Dercelles, Arnaud, et al. The Fondation Le Corbusier: Maison Dom-ino. Apr. 2017 < <http://www6.fondationlecorbusier.fr/corbuweb>>
- Di Tolla, Enrique Bonilla, et al. Lima y El Callao: Guia de Arquitectura y Paisaje. Lima: Sevilla, 2009.
- Garcia-Huidobro, Fernando, Diego Torres Torriti, and Nicolas Tugas. ¡El Tiempo Construye!. Trans. Paul Hammond. Barcelona: Gustavo Gili, SL, 2008.
- Guzman, Sergio. LIMA. Lima: U. de San Martin de Porres, 2012.
- Heilmeyer, Florian. "Constructing Identities: Contributions from Iran, Morocco, and the UAE." Uncube Magazine. Venice: 16 Jun. 2014. < <http://www.uncubemagazine.com>>.
- McGuirk, Justin. Radical Cities: Across Latin America in Search of a New Architecture. London: Verso, 2015.
- Rudofsky, Bernard. Architecture Without Architects: A Short Introduction to Non-Pedigreed Architecture. Albuquerque: U. of New Mexico Press, 1964.
- Turner, John F.C. Housing by People: Towards Autonomy in Building Environments. London: Marion Boyars, 1976.

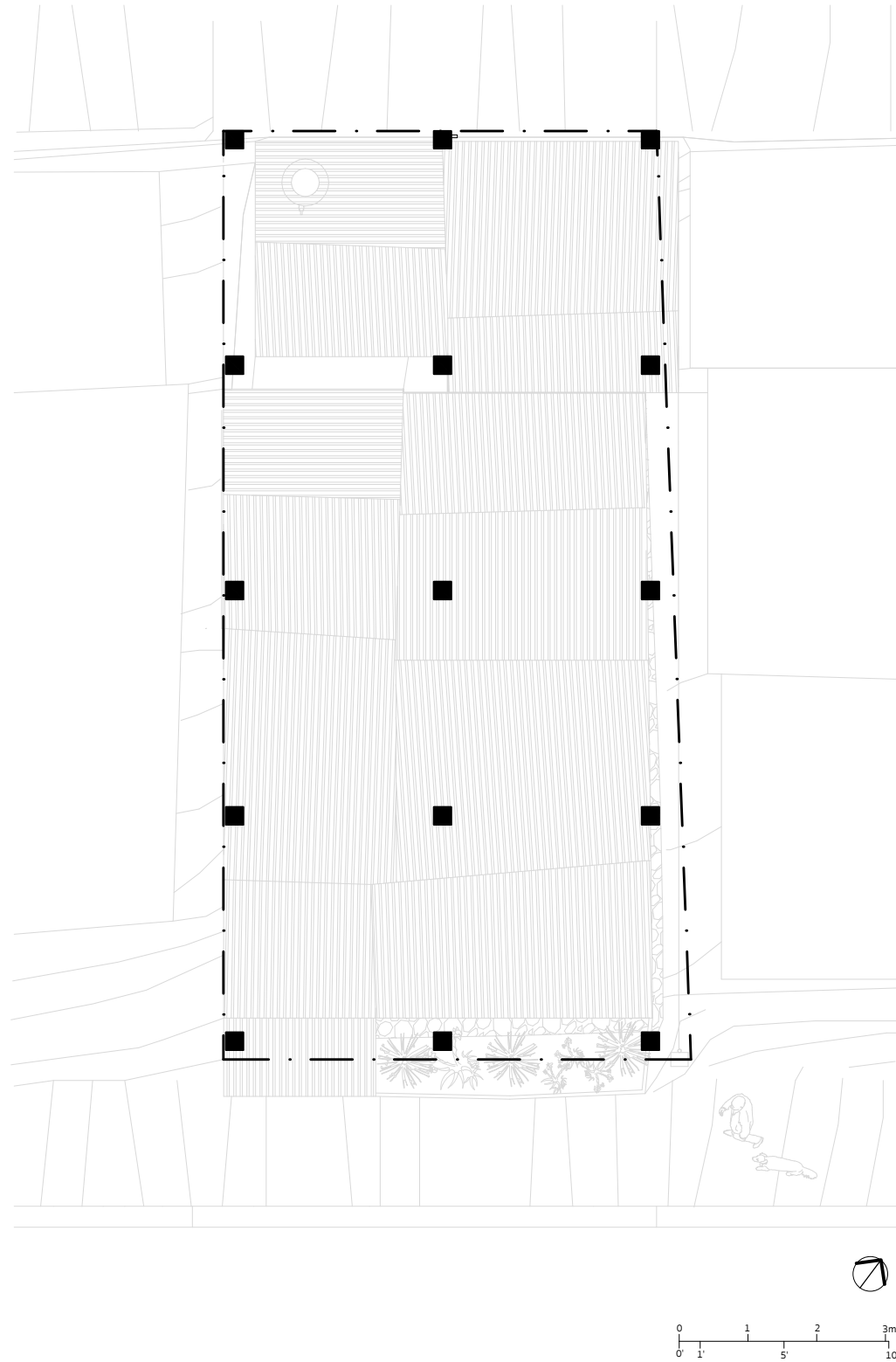

01

APPENDIX A: DRAWINGS

The following drawings illustrate the proposed structure built up to third level and infilled.

01. Column grid over the site. Scale: $1/8" = 1'-0"$.
02. Elevation looking west of existing conditions with extents of excavation for proposed structure outlined. Scale: $1/4" = 1'-0"$.
03. Level 01 plan. Scale: $1/4" = 1'-0"$.
04. Level 02 plan. Scale: $1/4" = 1'-0"$.
05. Level 03 plan. Scale: $1/4" = 1'-0"$.
06. Roof plan. Scale: $1/4" = 1'-0"$.
07. Elevation looking north. Scale: $1/4" = 1'-0"$.
08. Elevation looking south. Scale: $1/4" = 1'-0"$.
09. Elevation looking east. Scale: $1/4" = 1'-0"$.
10. Elevation looking west. Scale: $1/4" = 1'-0"$.
11. Section looking north. Scale: $1/4" = 1'-0"$.
12. Section looking south. Scale: $1/4" = 1'-0"$.
13. Section looking west. Scale: $1/4" = 1'-0"$.

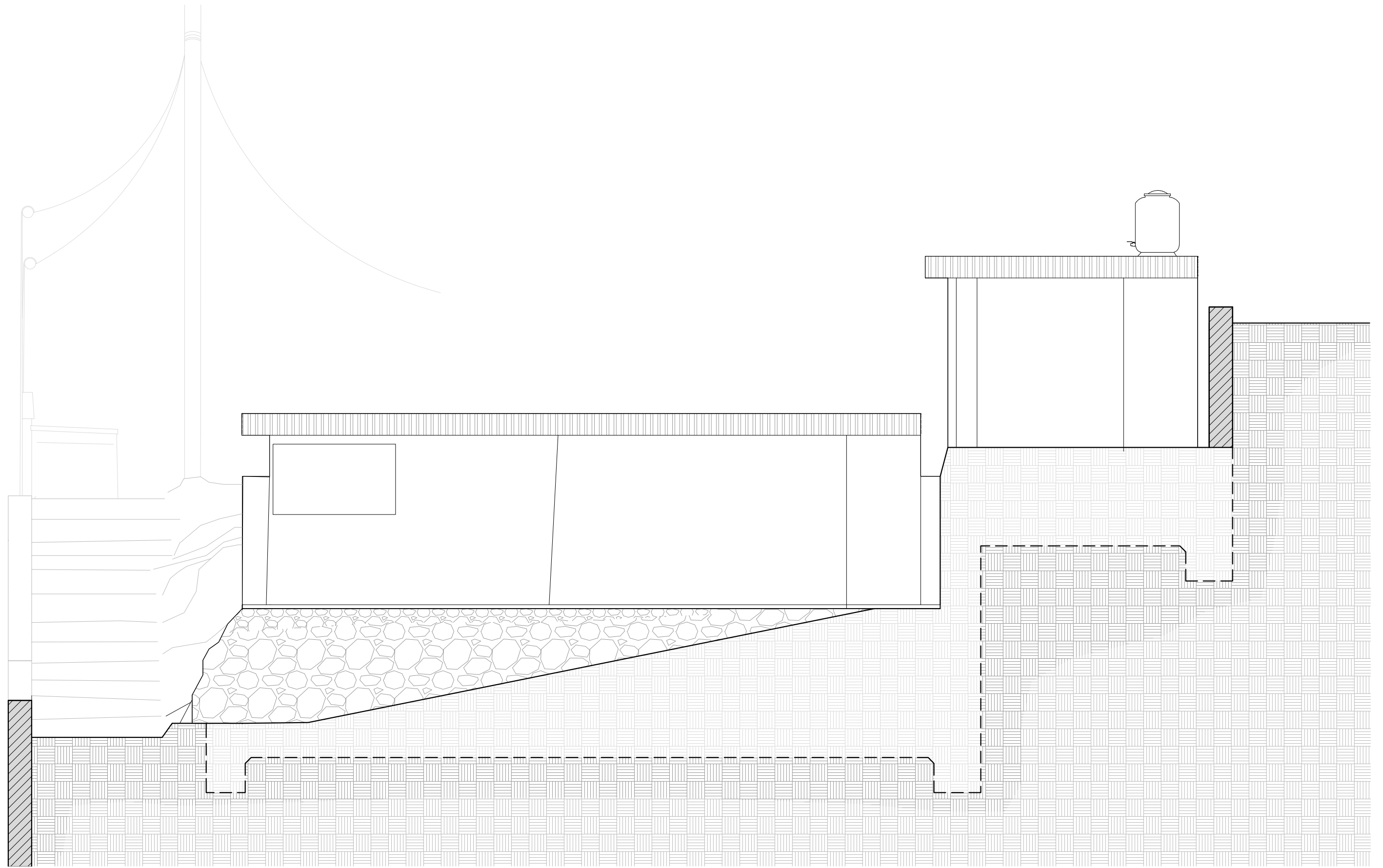

02

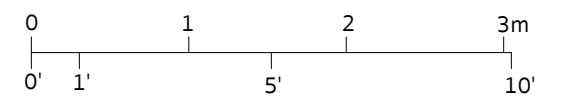

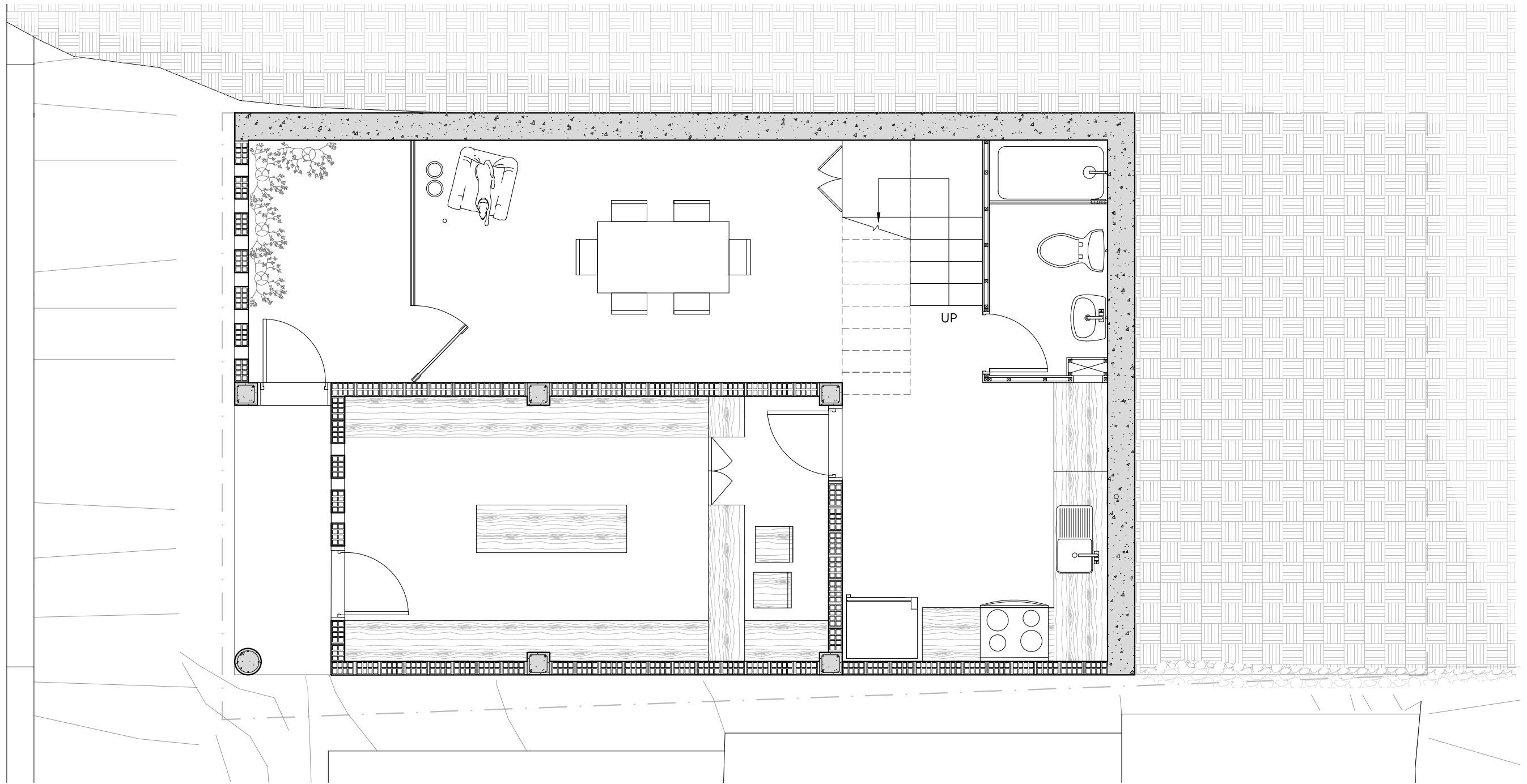

03

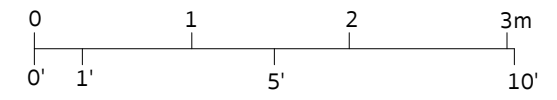

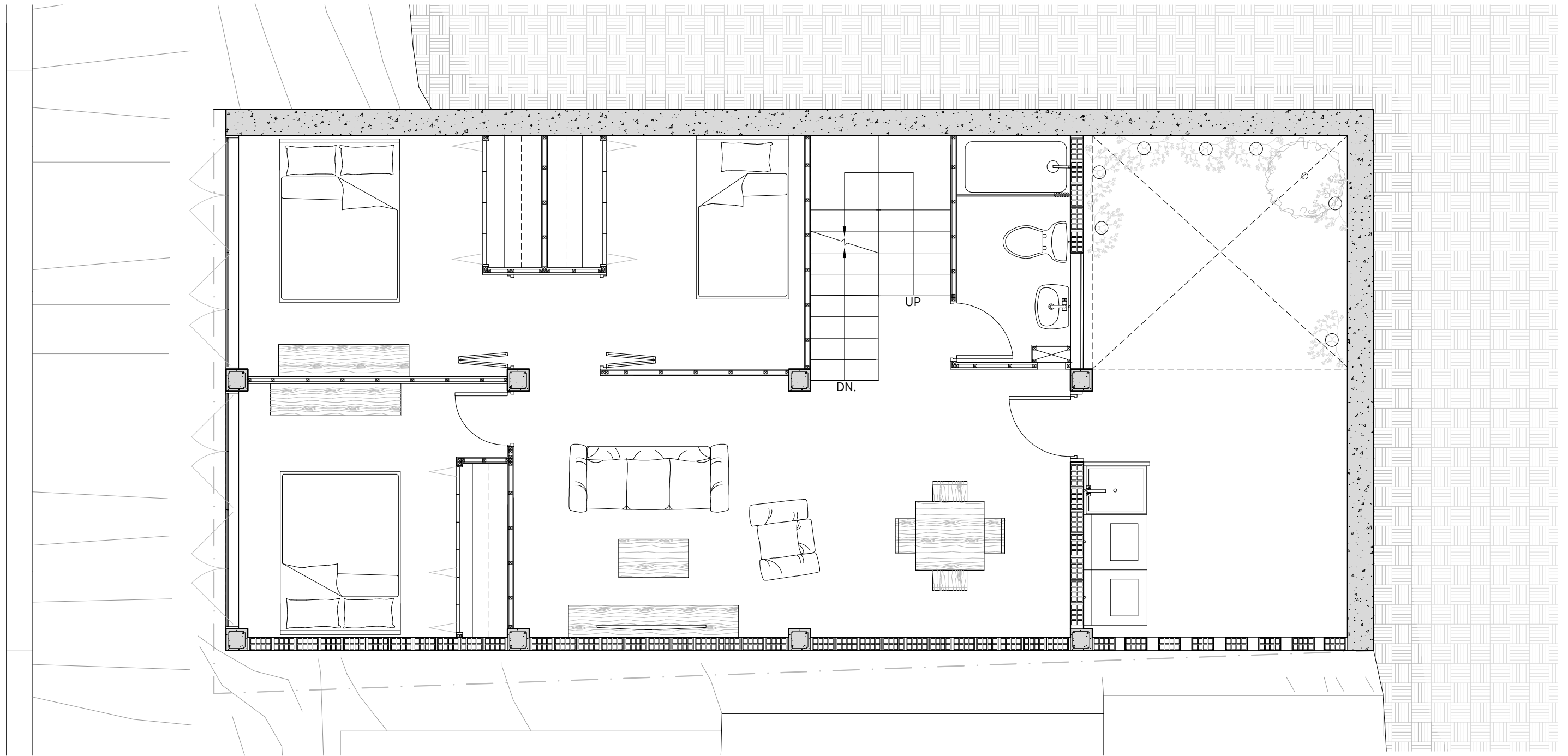

04

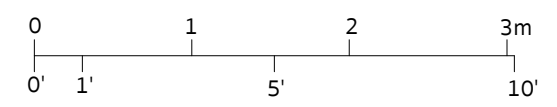

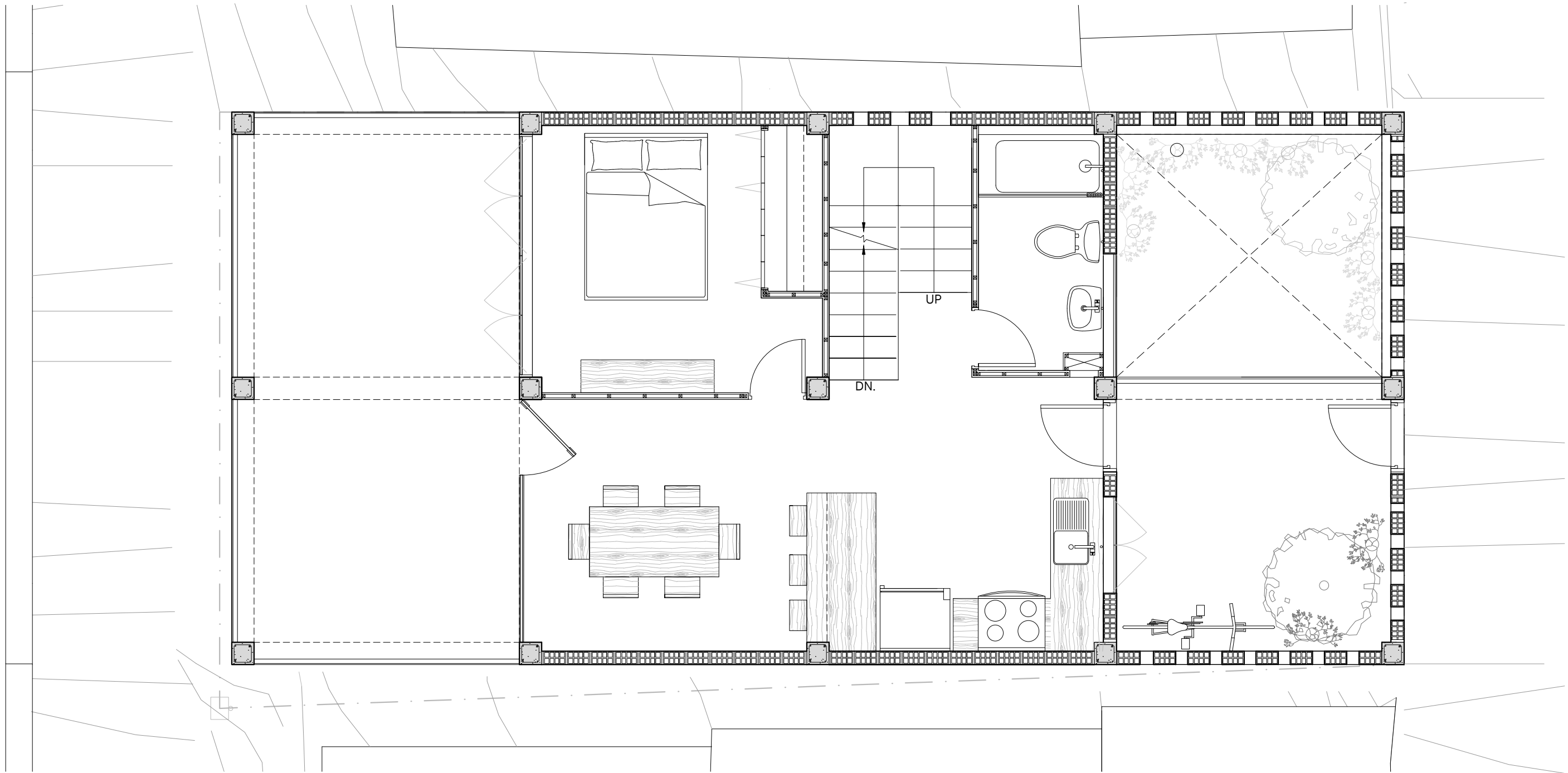

05

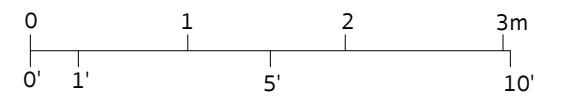

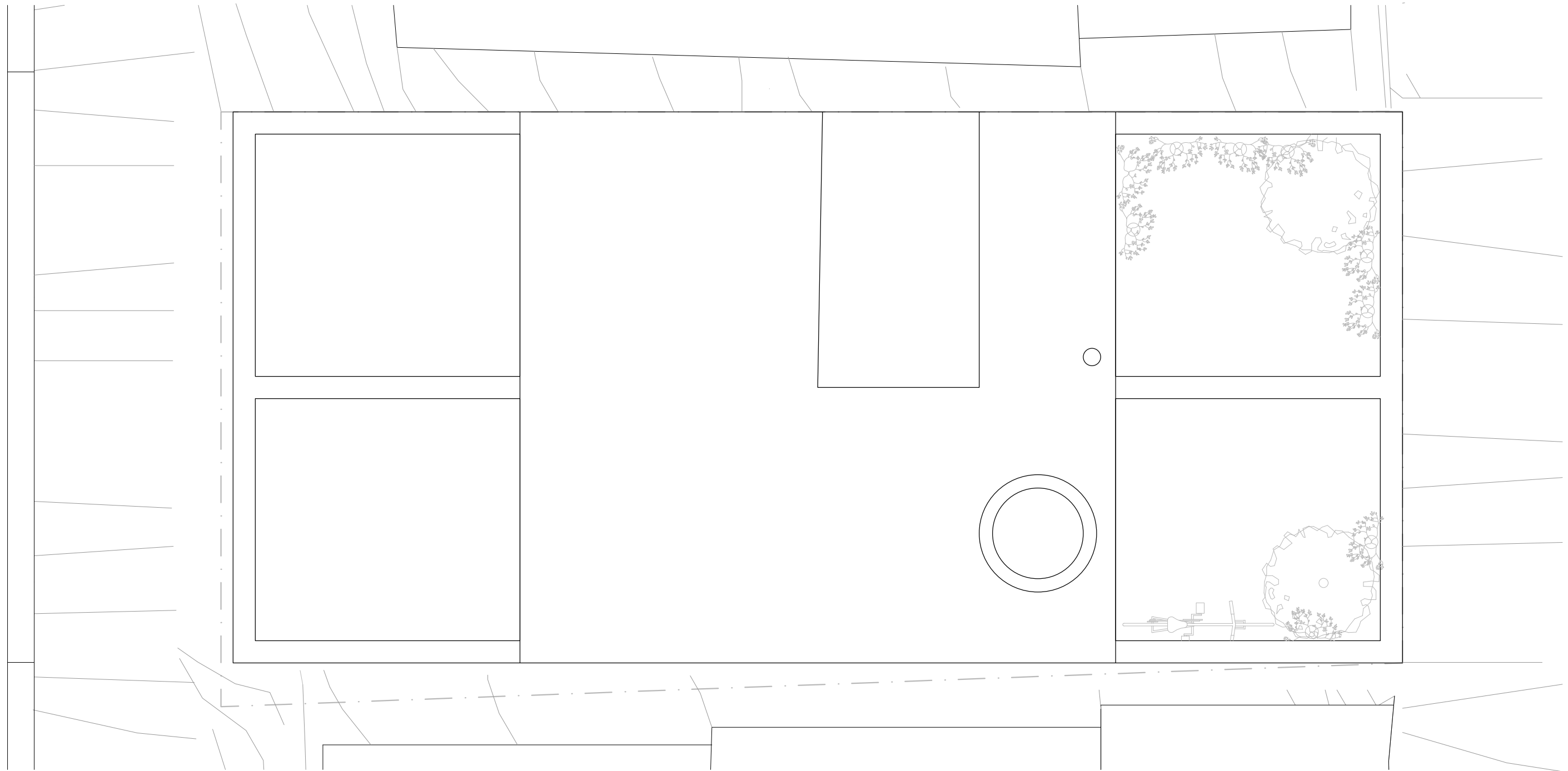

06

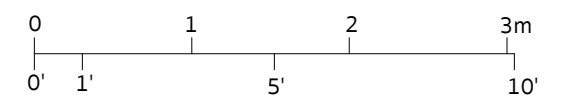



07

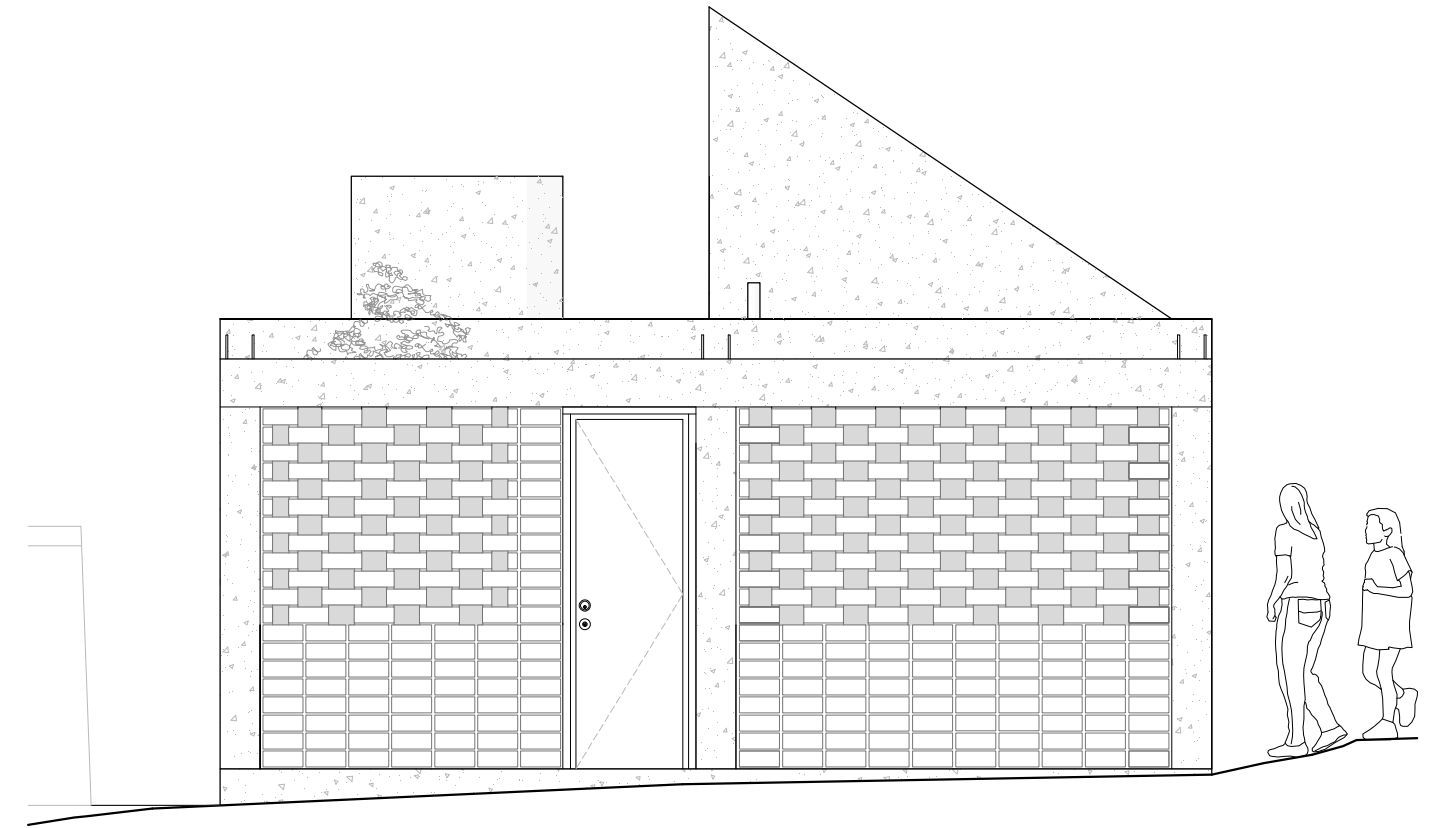

08

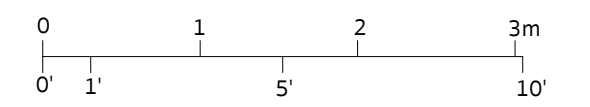

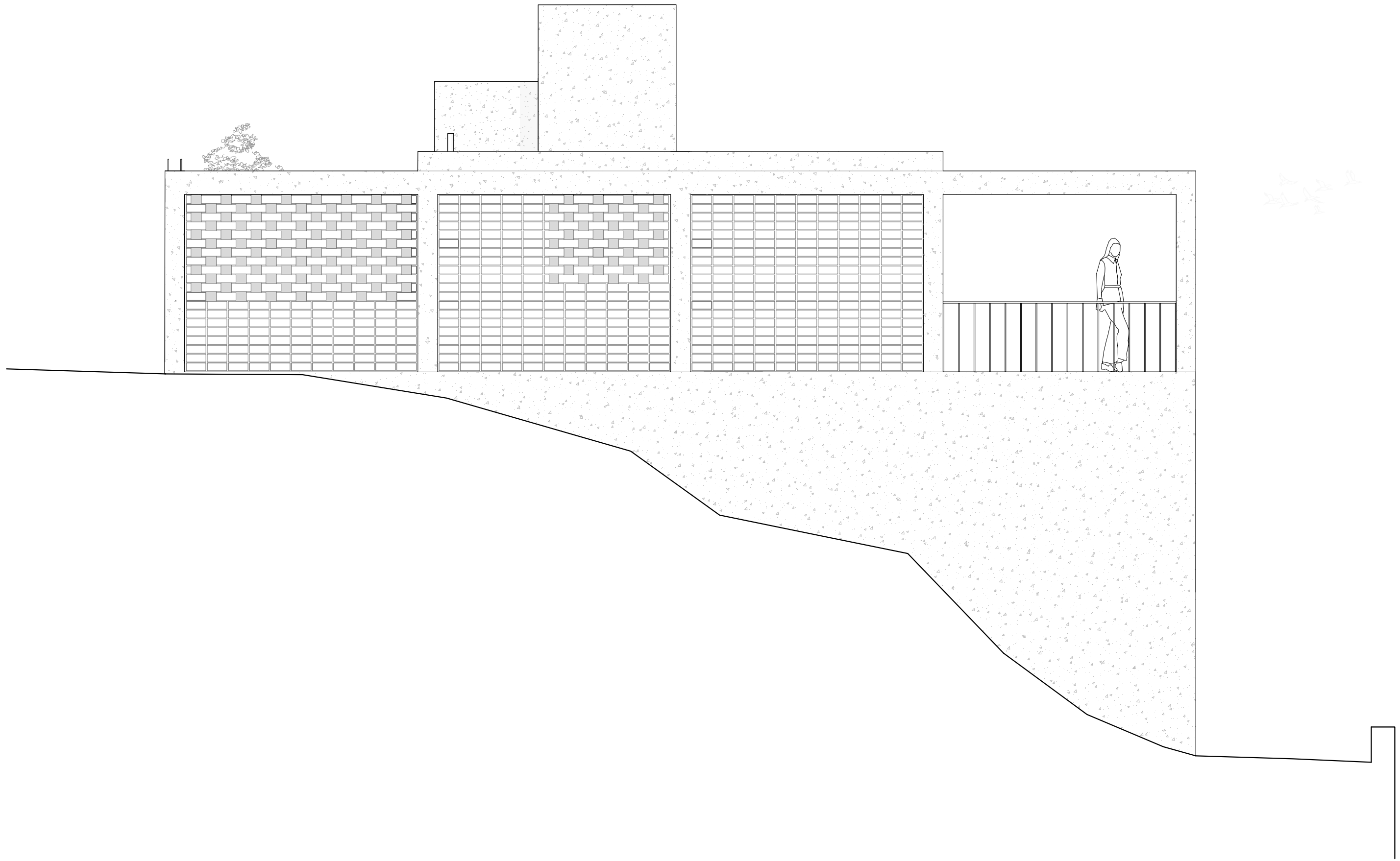

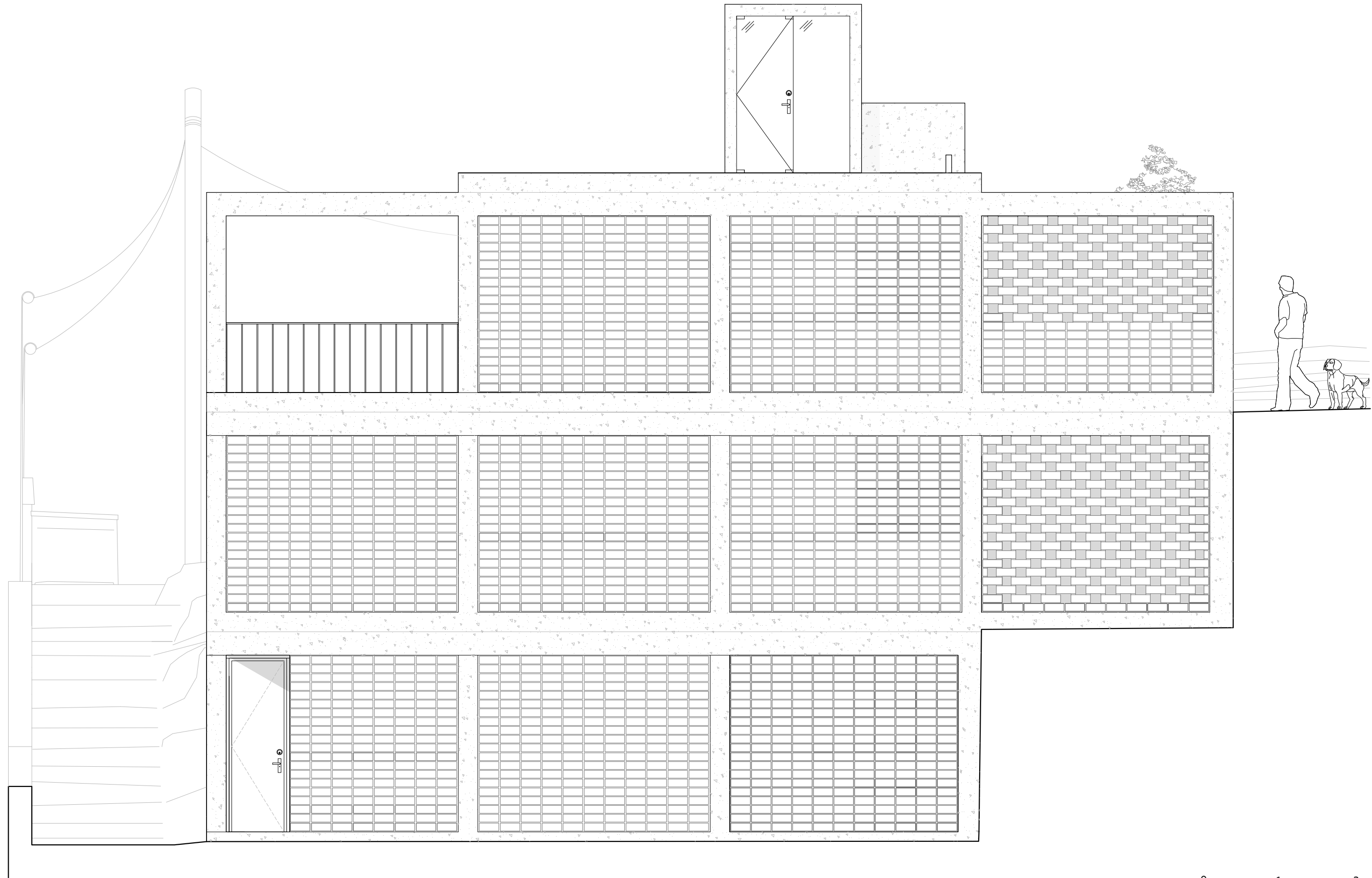

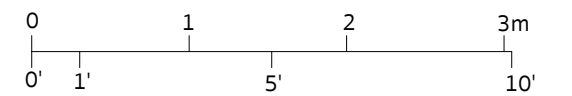
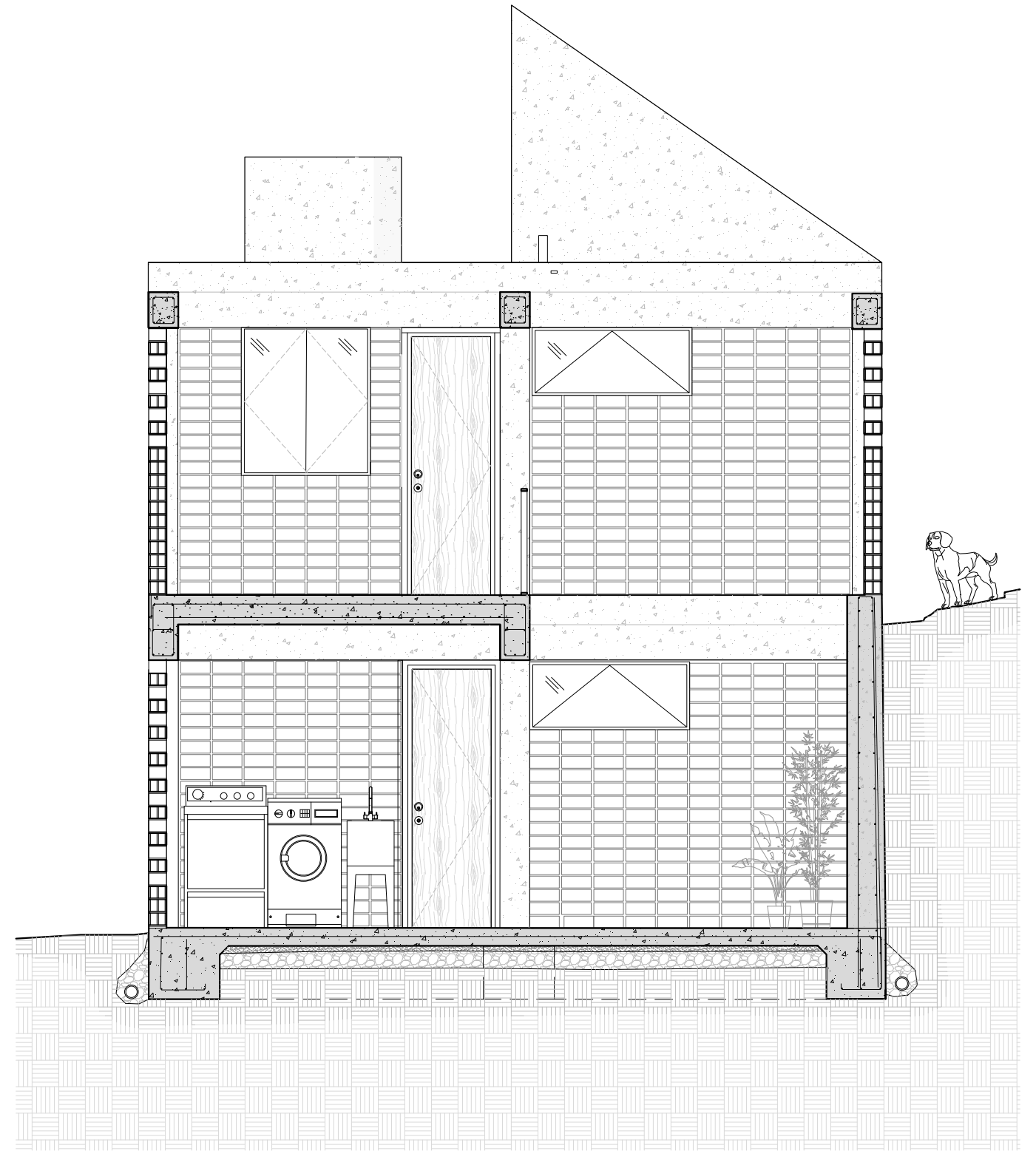
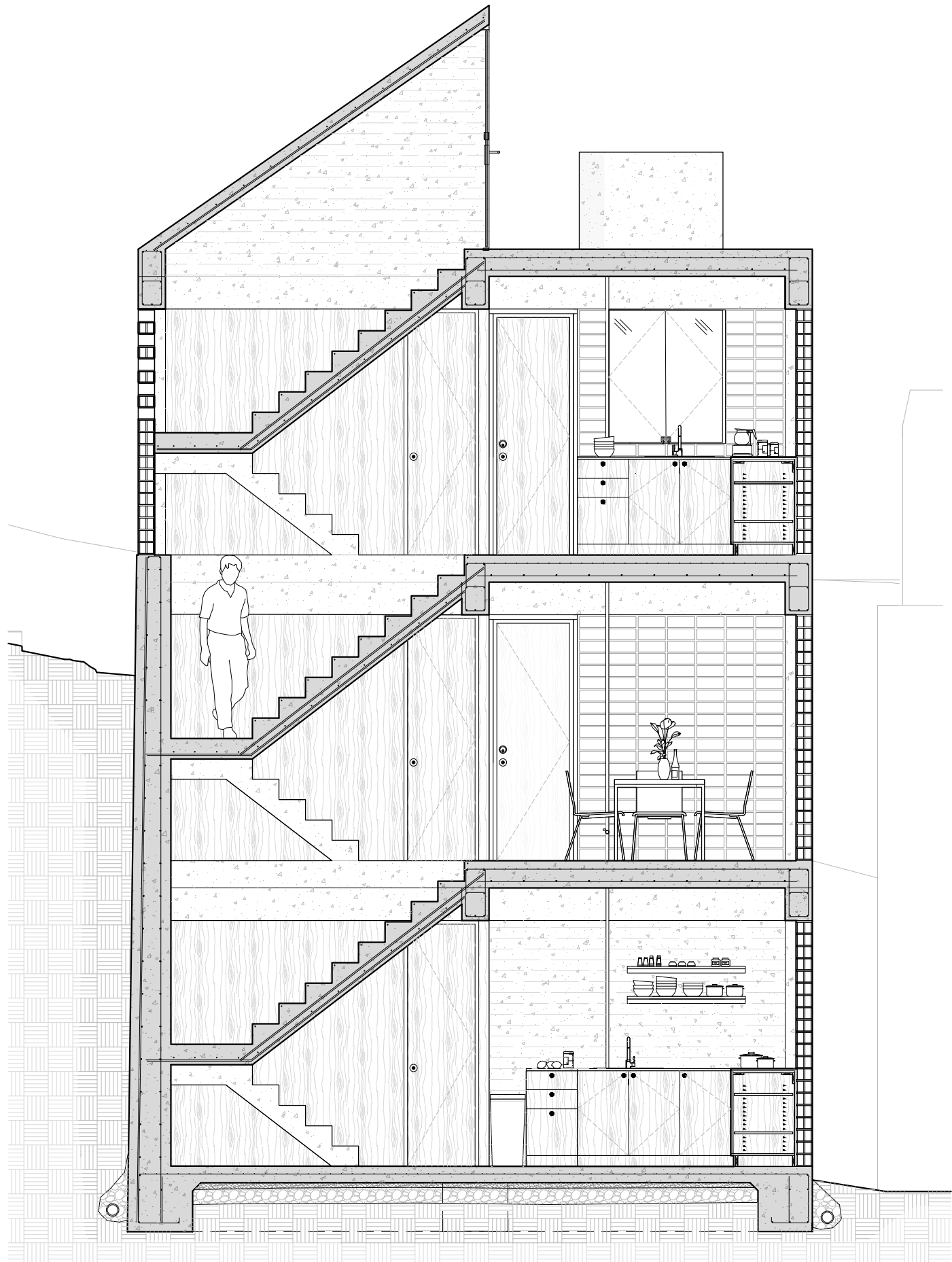

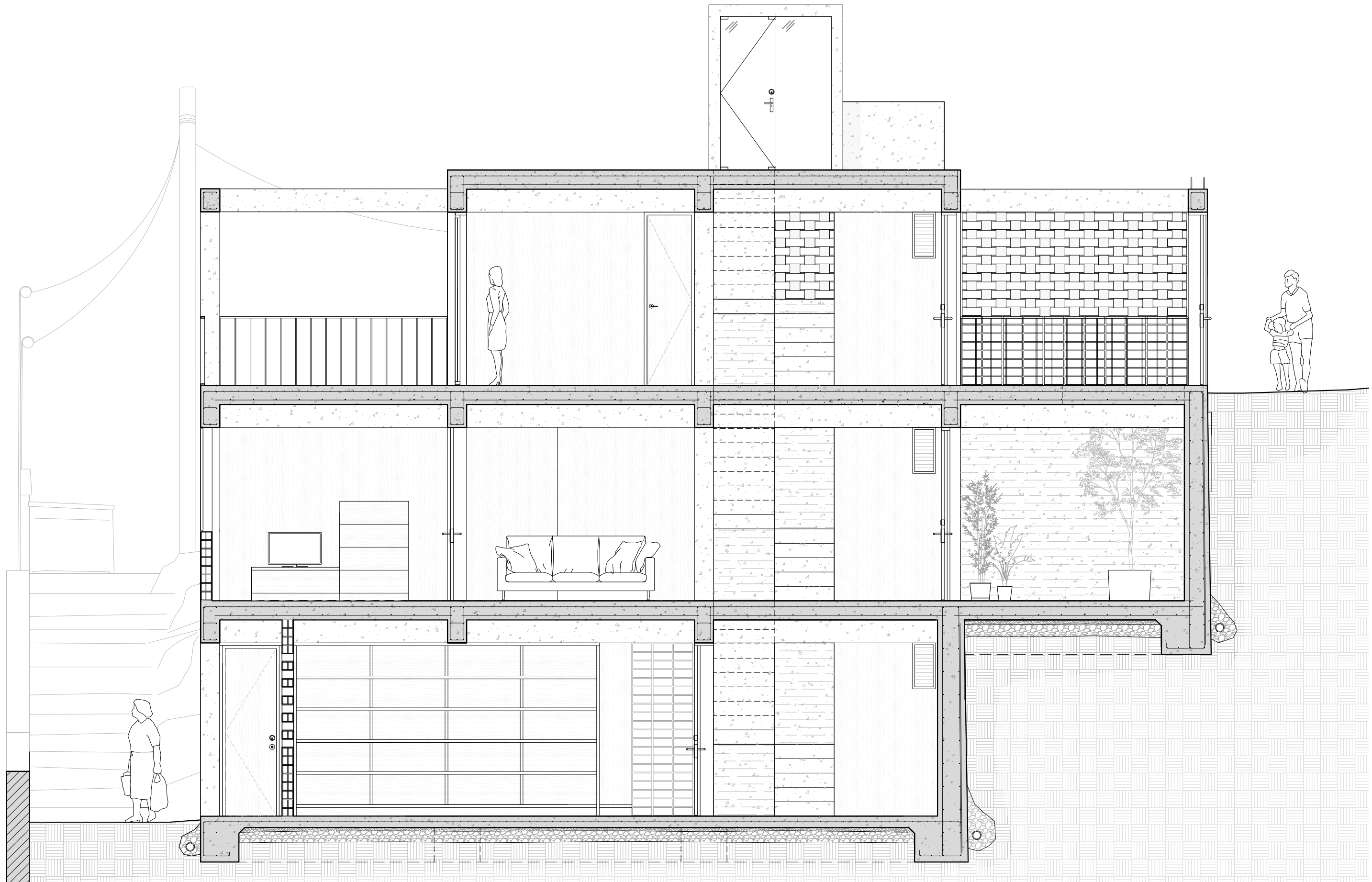

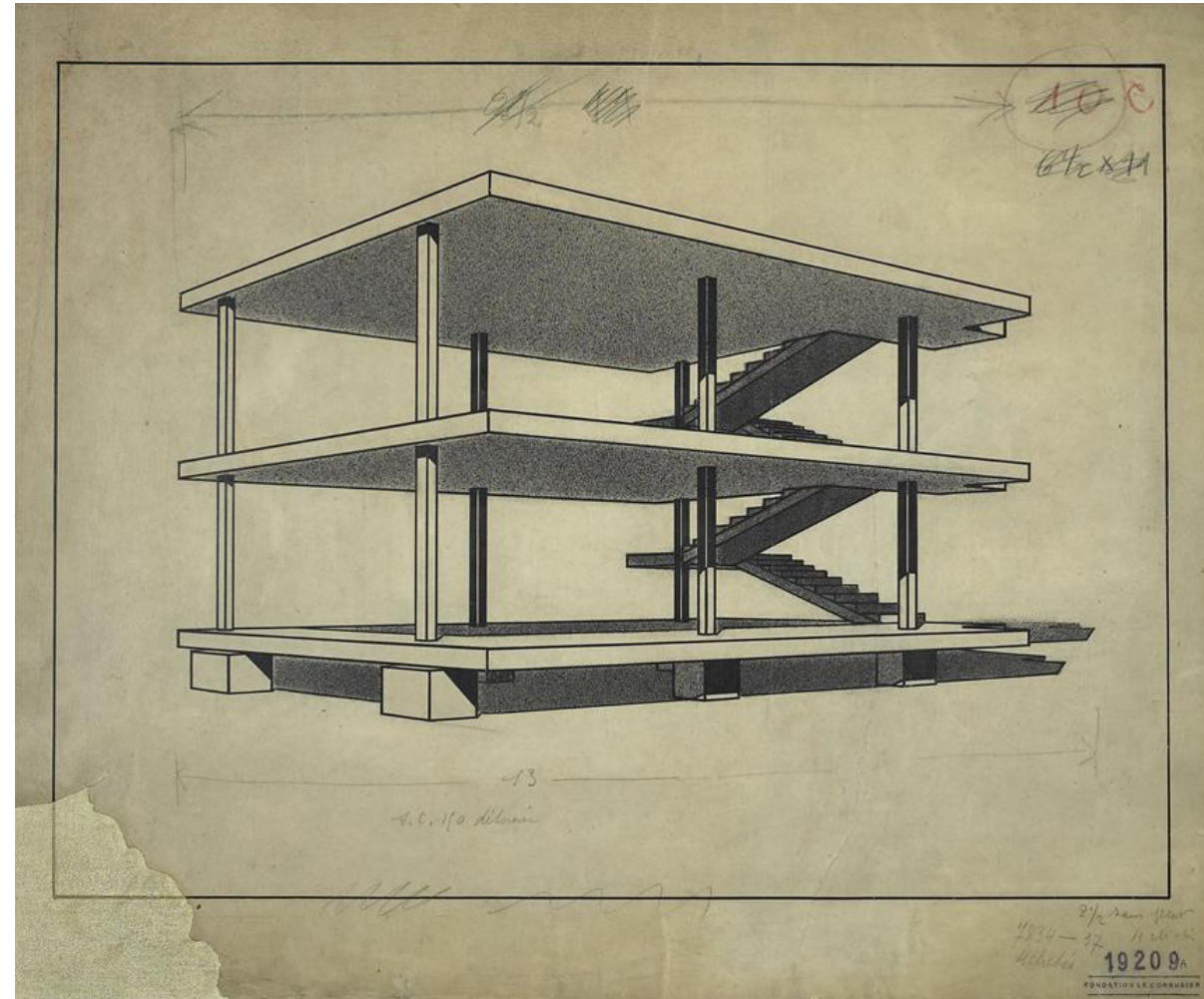

01

APPENDIX B: PRECEDENTS

The following exemplar projects are models in the exploration of frame and infill. Through frame, the projects address density resulting in both expected and unexpected outcomes.

01. Le Corbusier's Dom-ino House, 1914-1915. A model concrete frame independent of exterior and interior walls, allowing for flexibility and an open floor plan. The model provided the possibility of use as a stand alone house or in a sequence yielding row house configurations. (source: Dercelles, Arnaud, et al.)
02. The Nid D'Abeille or "Honeycomb" Housing project in Casablanca, Morocco as completed in 1952. The project was a collaborative effort by George Candilis, Shadrach Woods, Alexis Josic, Vladimir Bodianski, Henri Pirot, and the Group of Modern Moroccan Architects (GAMMA). (source: Heilmeyer)
03. The Nid D'Abeille as transformed by inhabitants, photographed in 1988 by Jean-Louis Cohen. The "honeycomb" balconies were not intended to be infilled upon the original design. (source: Heilmeyer)
04. The "half a house" housing concept by Elemental in Chile, led by Alejandro Aravena. The project was initially built as a relief effort in response to an earthquake and tsunami which struck Chile in 2010. Elemental provided half of the home built, leaving the remaining half a void to be built and infilled by the resident. The project went on to be built in various locations in Chile reacting to urbanization. (source: Aravena)
05. Elemental's "half a house" infilled by a resident, seen here in Lo Espejo, Santiago. (source: Aravena)
06. Aerial photograph of PREVI Lima, Peru in 1976 (1 of 2). PREVI (Proyecto Experimental de Vivienda, Experimental Housing Project), now the name of the district, was both a national and international competition held in 1965 by the Peruvian Government and the United Nations. Both of which invited architect Peter Land to design a housing strategy in response to the rapidly increasing number of informal settlements in Lima at the time. Land master planned the competition, which resulted in 26 national and international selected winners announced in 1969. (source: Garcia-Huidobro, Torriti, and Tugas)
07. Aerial photograph of PREVI Lima, Peru in 1976 (2 of 2). The PREVI competition was based on the implementation five (5) experimental concepts, one being "a growing house concept, with integral courtyard". (source: Garcia-Huidobro, Torriti, and Tugas)

While PREVI was designed to be a foundation for expanding and building gradually over time, the radical transformation found today far exceeds expectations 50 years ago. The following images are pairs of photographs comparing what was constructed in 1978 to photos taken in 2003 by a team of Chilean architects, Fernando García-Huidobro, Diego Torres Torriti, and Nicolás Tuga, documenting the changes. (source: Garcia-Huidobro, Torriti, and Tugas)

08. Vier, Zanelli / Peru
09. Toivo Korhonen / Finland
10. Esquerria, Samper, Sáenz, Urdaneta / Columbia
11. Gunther, Seminario / Peru
12. Atelier 5 / Switzerland
13. Montage, Morales / Peru
14. James Stirling / UK
15. Charles Correa / India

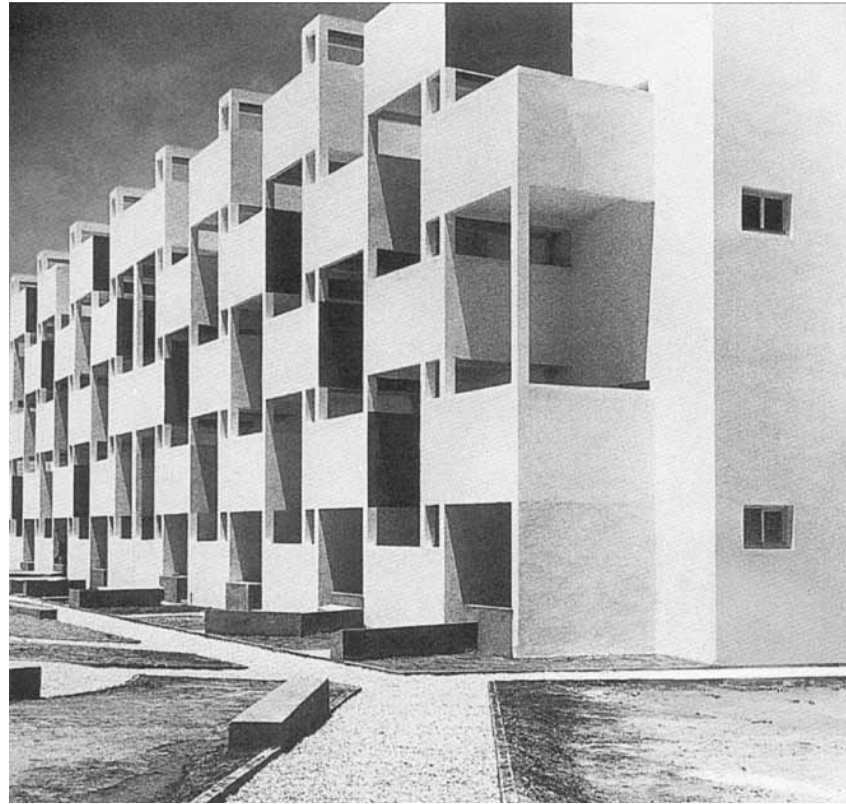

02



04



03



05



06



07

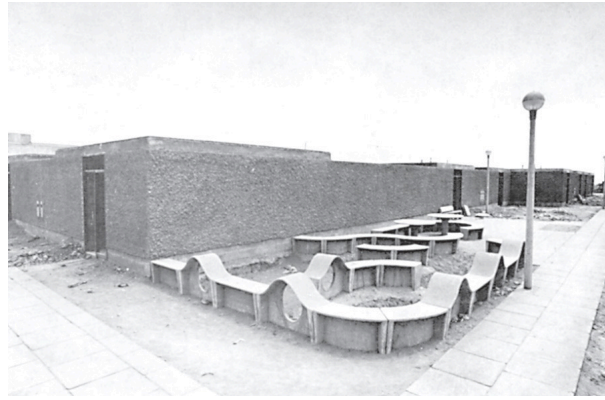

08

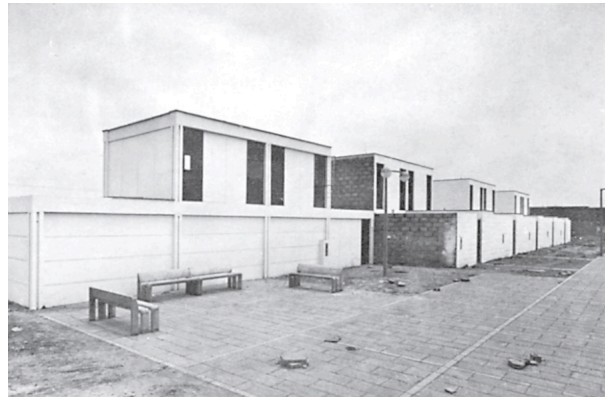

09



10



11



12

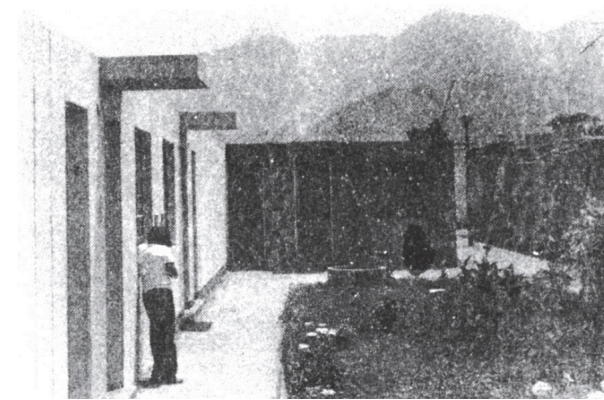

13

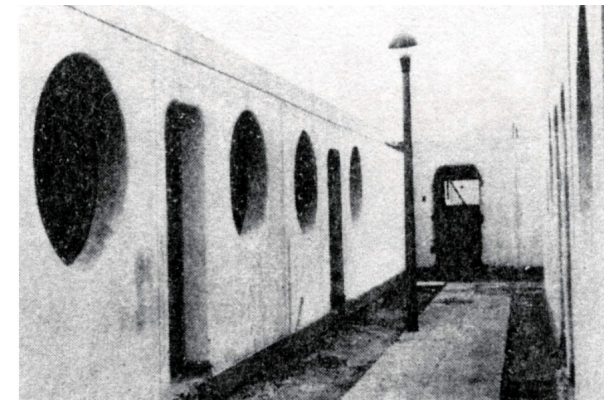

14



15



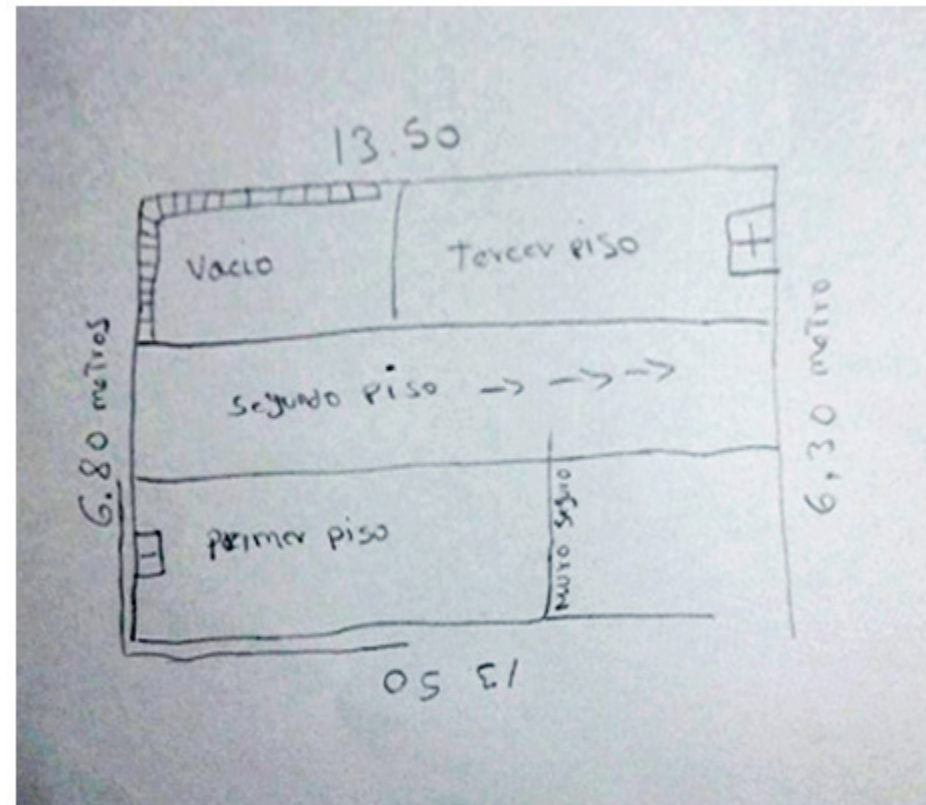

01

APPENDIX C: FAMILY

Since January 2017, regular discussions have occurred with a family of five, previously referenced. The wife and mother, Jhenyfer, was the primary contact. She and her husband, Rigoberto, have three daughters. Jhenyfer is a housekeeper in various locations in Lima, while Rigoberto works for a commercial window supply and installation contractor. Jhenyfer has also been establishing a bodega at the front of her home to generate income. She hopes to develop this into a full time occupation. Both Jhenyfer and Rigoberto commute from their home in Villa Maria del Triunfo to various locations in the city of Lima for work. Their three daughters are all currently in school.

Since initial contact, Jhenyfer has provided information on the initial and existing conditions of their home. She has shared photographs, videos, documents, and sketches. Regular phone calls, text message conversations, and video calls have been held. In September of 2018, a trip was made to meet the family and visit them at their home.

01. A sketch shared by Jhenyfer in January of 2017. It is a diagram in section or elevation of their future home.
02. A photo of Rigoberto, Jhenyfer, and their three daughters, shared by Jhenyfer.
03. A photograph of Jhenyfer and two of her daughters during the visit to their home. At this visit, the project was shared and discussed. Seen seated and pointing, is her daughter Monserrat. Monserrat, 11, dreams to become an architect. She would like to study and practice architecture in Paris one day. She was heavily involved in the conversation sharing her thoughts and sketching.
04. An elevation drawn by Monserrat, shared by Jhenyfer in January of 2017.
05. A plan drawn by Monserrat, showing a dining room, living room, and outdoor space. Also shared by Jhenyfer in January of 2017.



02



03

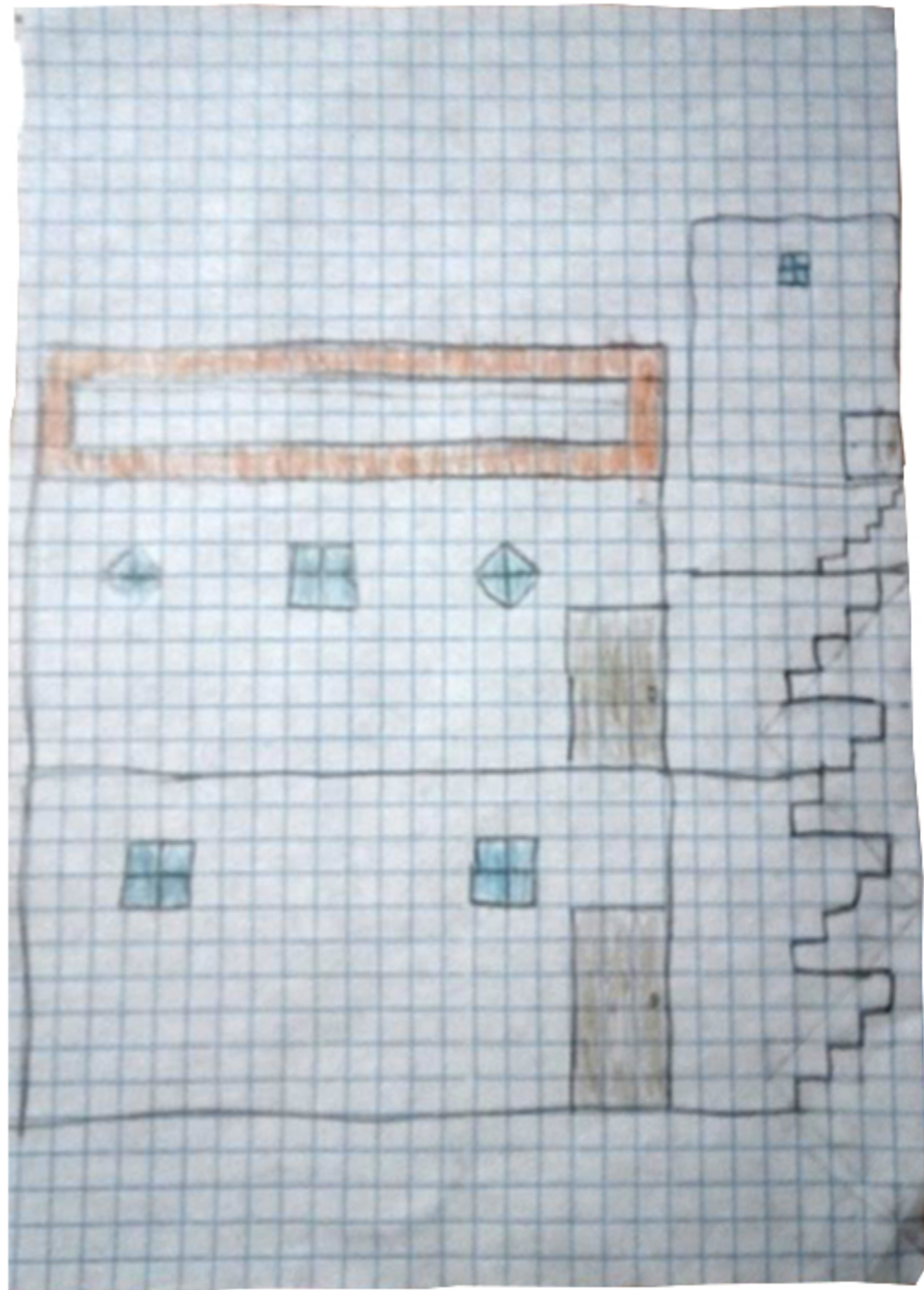

04

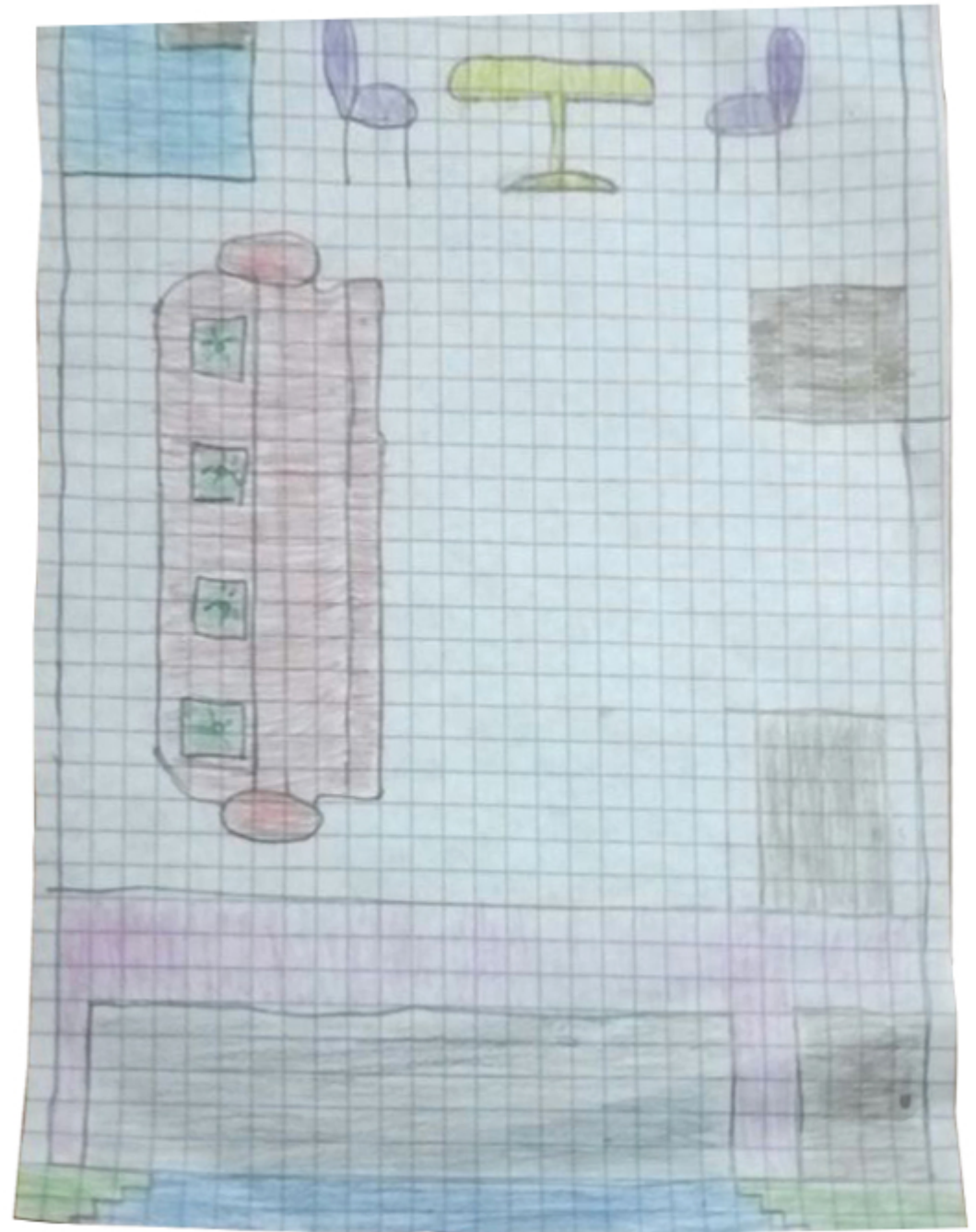

05



