

ENHANCING INDOOR AIR MOVEMENT THROUGH ROOF DESIGN;
A PROCESS OF INCREASING THERMAL COMFORT
IN HOT HUMID REGION HOUSING

by

Esther Olajumoke Oluyemi

Thesis submitted to the Faculty of the
Virginia Polytechnic Institute and State University
in partial fulfillment of the requirements for the degree of

MASTER OF ARCHITECTURE

in

Architecture

APPROVED:

Robert N. S. Chiang, Chairman

Robert P. Schubert

Joseph C. Wang

June, 1984

Blacksburg, Virginia

ENHANCING INDOOR AIR MOVEMENT THROUGH ROOF DESIGN;
A PROCESS OF INCREASING THERMAL COMFORT
IN HOT HUMID REGION HOUSING

by

Esther Olajumoke Oluyemi

Committee Chairman: Robert N. S. Chiang

Architecture

(ABSTRACT)

Insignificant diurnal variations make the reliance on thermal inertia to ameliorate the thermal discomfort in the hot humid region impossible. Natural ventilation, therefore, is not only important, but the velocity of air that gets into the living area is crucial. Various ways of creating negative pressure (a process of increasing the interior air speed) are examined. The performance of roof types with different horizontal openings in enhancing interior air movement was investigated in an open throat wind tunnel. The results indicate a significant difference in the interior air velocity with roof type A opening type 1 (see fig. 27 and fig. 28).

The thesis explores other ways of creating climate adapted architecture in providing acceptable comfort level in the hot humid climate. Warm humid climates are defined, and data for one example (Lagos, Nigeria) are analysed. Comfort zones are established relative to the region being investigated and the methods of limiting interior heat gain are described. The effects of orientation, cross ventilation and material choice are discussed.

Acknowledgement

I would like to acknowledge the contributions of my committee members through whose guidance, understanding and constructive criticisms I was able to come to the successful conclusion of this thesis.

Thanks are due to my brother, Kola, and my children--Bunmi and Wole for bearing with the inconveniences my late nights must have caused them. Special thanks to Bisi, my husband, for his support, love and understanding.

I am also indebted to my parents; their support and encouragement throughout my education is much appreciated. Thanks for my life.

TABLE OF CONTENTS

Chapter	Page
1. Introduction	2
2. Fundamental Issues that Influenced Housing Design . . .	5
A. Relative Human Comfort	6
B. Appropriate Building Materials for Hot Humid Climate	14
3. Basic Method of Climatic Balanced Housing Design	18
A. Design Techniques	18
(I) Micro-climatic Analysis	18
(II) Building Geometry and Planning	25
(III) Wall Concept	29
(IV) Opening Concept	31
(V) Energy Conscious Landscaping	35
B. Details for Optimizing Environmental Conditions .	41
(I) Window Systems for Ventilative Cooling . .	41
(II) Sun Control Devices	47
(III) Solar Possibilities	49
4. Special Experimentation on Roof Type Performance With Horizontal Openings	51
A. Roof As An Air Velocity Enhancer	52
B. Roof As A Solar Heat Protector	61
References	68
Appendix: A. Nigeria Climatic Analysis	69
B. Thermal Performance of Selected Walls and Floor Construction	79
C. The Performance of Major Building Materials in the Hot Humid Climate	82
D. The Mahoney Tables	85
E. Planting in the Humid Tropics	92
F. The Overheated Periods of the Year	97
G. Solar Possibilities	100
H. Experimentation Graphs	122
End Notes	129
Vita	130

LIST OF FIGURES

Figure	Page
1A. Bio-climatic Chart	8
1B. Bio-climatic Chart for Hot Humid Regions	9
2. Comfort Zone	12
3. Climatic Conditions in Major Nigeria Cities	13
4. Heat Transfer Mechanism	15
5. Climatic Data for Lagos, Nigeria	20
6. Land and Sea Breezes	23
7. Climatic Sunshine Hours Data	24
8. Concept for Building Geometry	26
9. Direct Solar Radiation on Walls of Selected Orientations .	27
10. Wall Concept	28
11. Loose Planning Concept	30
12. Window Design Concept	32
13. Spatial Planning Concept	33
14. Landscaping Concept	36
15. Landscaping to Promote Cross Ventilation	37
16. Effect of Vegetation, Overhang and Slot on Cross Ventilation	38
17. Landscaped Trellis and Patio	39
18. Typical Landscaped Design for Hot Humid Region	40
19. Flow Pattern Through Buildings	43
20. One Wall Opening Ventilation Analysis	44
21a. Simple Openings	46
21b. Horizontal Openings	46
22. Solar Altitude and Azimuth During Overheated Period of the Year	48
23. Types of Sunshading Devices	50
24. Different Roof Types	53
25. Types of Openings	55
26. Roof Type & Performance in Relation to Horizontal Openings	56
27. Roof-Opening Matrix	58
28. Roof Type-Opening Combination Performance Bar Chart . . .	60
29. Thermal Performance of Material	62
30. Annual Hourly Temperature Graph of Ikeja	30
31a. Thermosiphon Solar System-Vertical Tank	104
31b. Thermosiphon Solar System-Horizontal Tank	104
32a. Thermosiphon System-Section	105
32b. Miromit's System	105
33. Anabatic or Stack Effect	108
34a. Pressure or Down Draft	109
34b. Katabatic or Cold Draft	109
35. Sawtooth Arrangement for Windows on East and West Facade of a Building	111
36. Solar Power Absorption Air Conditioner	112

LIST OF FIGURES (continued)

Figure		Page
37.	Solar Safety Controls	119
38.	Solar safety Controls	120
39.	Solar Safety Controls	121
40.	Window Shaft Performance in Relation to Wind Direction . .	123

LIST OF MAPS

Map	Page
1. Location of Site Within Lagos	19
2. Geographical Location of Nigeria	71
3. Temperature	72
4. Relative Humidity	73
5. Rainfall	74
6. Wind	75
7. Vegetation	76
8. Physical Factors	77

LIST OF TABLES

Table	Page
1. Climatic Data For Selected Cities in Nigeria	11
2. Climatic Data for Lagos, Nigeria	21
3. Thermal Performance of Selected Walls and Floor Construction	80
4. Time Lag of Heat Flow Through Walls and Roofs	81
5. The Performance of Major Building Materials in the Hot Humid Climate	83
6. Mahoney Table	89
7. Sketch Design Recommendations	90
8. Climate Design Recommendations	91
9. Trees and Shrubs Suitable for Planting in Hot Humid Climate	94
10. Classification of Trees According to Shape	96
11. DHW Recommended Temperature	102

1 INTRODUCTION

INTRODUCTION

Historically natural forces played a major role in the decision of location, settlement pattern and building forms of people. The general forms of habitation were born of the various environments.

However, the increasing demand for housing and unguided international demonstration disseminated different forms in most of the oil-rich developing countries' cities. Some of the building forms evolved from the challenge of cool climates which many designers and local elites undigestedly adopted as what was in vogue. Ironically, most of these forms could not work without mechanical means in a hot humid region. Buildings designed for this region (hot humid) should be naturally climate balanced for human comfort; since majority cannot afford both the initial and the running cost of mechanical equipment.

In view of the world energy situation, optimization of the thermal performance of buildings has become a real challenge to designers. They are to come up with buildings in which interior environment mitigates the climatic extreme and also fulfills the basic human requirements for comfort. This objective has to be accomplished with minimum expenditure of exhaustible energy resources and maximum utilization of natural sources. The desirable procedure will be to work with and not against the forces of nature and to make use of their potentialities to create better living conditions. This could only be achieved through clear understanding of the natural environment.

The pressure of providing high density housing to meet the demand of rapid urban growth overshadows the need for thermal comfort requirement for the newly created environment. "Substandard is better than subhuman" is the present slogan. But a poorly constructed low income housing where comfort can only be achieved through mechanical means, (which the poor people cannot afford) is quite inhuman. The research will identify the environmental potentials within the reach of every hot humid housing designer to create climatic responsive housing. It will offer techniques and guidelines of eliminating excessive heat from the living areas. It will also investigate various ways of enhancing indoor air movement with special emphasis on the effect of roof type and opening on the velocity of the indoor air. Among other things it will present significant solar possibilities and their applicability to the hot humid region with special reference to Lagos, Nigeria.

The thesis does not suggest specific design solution in terms of shape or form of the building; as this may vary according to the cultural, taste and income differences. But the guidelines offered and the result of the experimentation are intended for general reference for the design of hot humid region.

2 FUNDAMENTAL ISSUES THAT INFLUENCED HOUSING DESIGN

Lagos state is one of the 19 states of Nigeria. It is the smallest state in land area--0.4% of Nigeria; but it accommodates 5% of the population of the country.¹ Also, out of the population of Lagos state, Lagos metropolitan area (including the Ikorodu urban area) contains 88% of the total state population; whereas it occupies only 37% of its land area.² The rate of population growth also stands in excess of 6-8% annually.

Lagos' rapid urban growth is much associated with her accelerated socio-economic development. This seriously aggravated the shortage of dwelling units. The shortage in turn resulted in high rent and overcrowding; which are visible features of the urban scene throughout the country. If an average standard of 5 persons per housing unit is used, based on the population projection--2,000 housing units will be needed annually for the very low income group, who cannot afford decent shelter because of high rent.³

The provision of adequate housing has been a major task for the military and civilian administrations. The past governments made tremendous efforts both at the federal and state levels to meet the housing needs of the people. Their efforts unfortunately were geared towards the wrong group of the community. This is a consequence of non-availability of appropriate planning statistics. Getting the housing units to the needy is crucial. Its problems and solutions however are outside the scope of this thesis.

Climate is the natural factor that most conditions environment, and those basic elements resulting from it are relatively constant factors than those imposed by human beings through their actions, life style and fashions. For example, four of the six parameters for expressing comfort conditions of a place are environmental, namely:

- (i) mean air temperature around the human body temperature
- (ii) mean radiant temperature in relations to the body temperature
- (iii) mean air velocity around the body--prevailing winds
- (iv) water vapour pressure in ambient air--relative humidity

Apart from adaptations or acclimatization to one's environment, human activity (which affects internal heat production in the body) and thermal resistance of clothing account greatly for the variation of comfort zone of one region to another. Therefore, any design process for passive cooling or heating requires the precise evaluation of climatic variables on both a daily and seasonal basis. The climatic characteristics of Nigeria as an example of hot humid region are discussed in Appendix A.

A. Relative Human Comfort

Though it is difficult to define comfort precisely, it is evident that thermal-comfort is the most important aspect of human comfort. In hot regions it is also directly related to metabolism--heat removal from body and environmental conditions.

Different methods and indexes have been developed to measure and understand the interrelationship between climate and man. These ranges

from effective temperature index (Ashrae) to the index of thermal stress (Givoni) and the bioclimatic chart (Olgyay).

The bioclimatic chart created by the Florida Solar Energy Center delimits the acceptable temperature and humidity ranges. The shaded portion of comfort zone (fig. 1A) represents the acceptable range of conditions. But the comfort zones varied in different parts of the world depending on the outdoor climate, clothing, thermal resistance and level of human adaptability. People can acclimatized themselves to their environment so that they can absorb beyond the acceptable temperature and humidity ranges of another region and still feel comfortable. For example, in the tropical region of Nigeria, where the traditional clothing is loose style and perforated, people can still feel comfortable at 85°F (30°C) temperature and 85% relative humidity (see fig. 1B). Beyond these conditions discomfort will be sensed, unless balancing factors are introduced such as shading, moisture control and increase in air motion or velocity. As air-speed across the human body increases either by natural breeze or power driven fan, the body loses more heat. Thus the human body can be comfortable at reasonable high temperature and humidity. This effect is illustrated by the airspeed dotted lines in Figures 1A&B.

Studies conducted by Givoni in Abidjan and Conakry (West Africa) and the Department of Scientific Industrial Research and Building Station in England provide the basis for establishing the comfort zone in Nigeria. Both studies used the psychometric charts as a basis for indicating the comfort zone based on temperature, relative humidity and

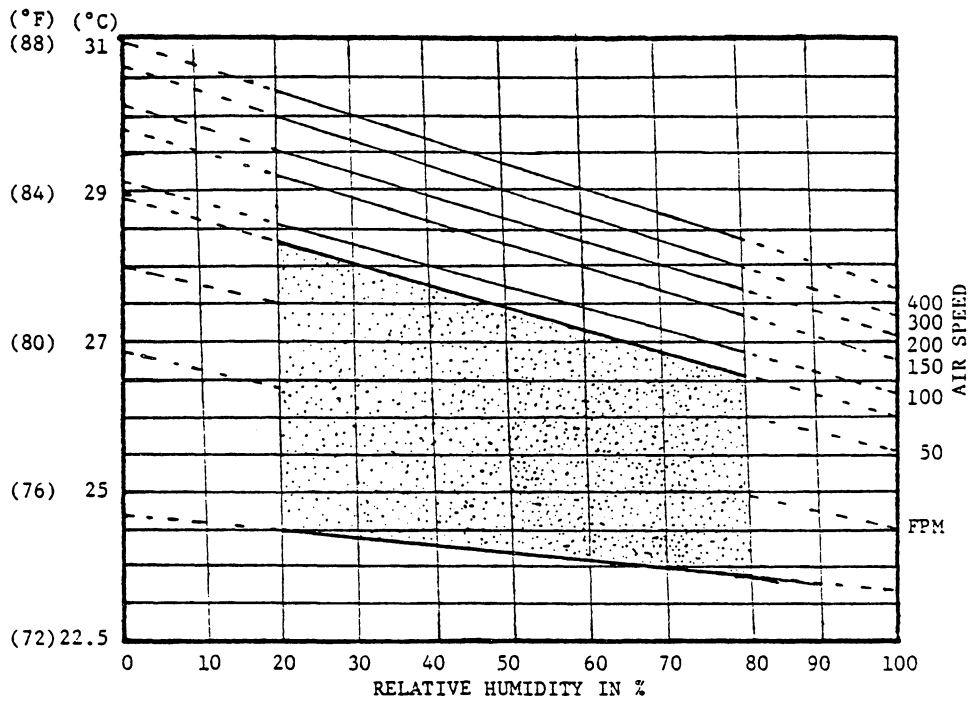

Figure 1A

Bio-climatic Chart

Source: Florida Solar Energy Center, Cape Canaveral, Florida.

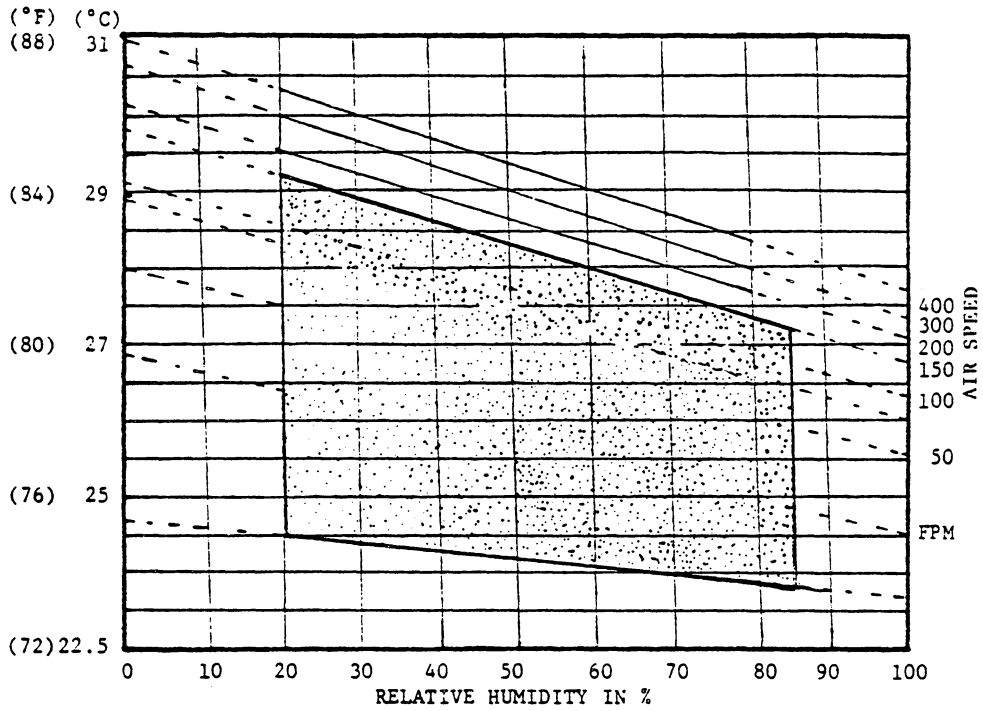

Figure 1B

Bio-climatic Chart for Hot Humid Region
of Lagos, Nigeria

vapor pressure. Givoni's method is based on the fact that the body has a certain rate of sweat production that changes according to the environmental conditions of temperature, humidity, radiation, wind, clothing level and building envelope. Using these recommendations and the data in Table 1, the comfort zone for major cities in Nigeria is plotted and classified in Figs. 2 and 3.

Table 1. Climatic Data for Selected Cities in Nigeria

Cities	Elements	Jan.	Feb.	Mar.	Apr.	May	June	July	Aug.	Sept.	Oct.	Nov.	Dec.	Year	
Port Harcourt	Rainfall (Inches)	1.2	2.3	5.0	7.5	9.9	13.3	12.9	12.3	15.5	10.7	5.5	1.8	97	
	Temp. (°F)	Max.	88.7	90.6	90.3	89.3	87.7	85.3	82.9	83.7	84.4	85.6	87.3	88.2	87.0
		Min.	72.7	73.5	74.5	74.5	73.8	73.4	72.7	72.2	72.7	72.7	73.1	73.1	73.3
	Relative Humidity (%)	6 a.m.	94	95	95	95	95	95	95	95	95	96	96	95	95
		12 noon	65	60	67	70	73	76	78	75	75	76	71	69	71
Lagos	Rainfall (Inches)	1.1	1.6	3.8	5.6	10.8	18.1	11.1	2.7	5.5	8.1	2.7	1.0	72.0	
	Temp. (°F)	Max.	90.5	91.0	91.5	90.2	87.9	84.2	82.2	81.7	83.9	85.7	89.3	89.3	87.3
		Min.	69.8	72.6	73.1	71.7	72.1	71.2	70.0	69.7	70.5	71.0	71.7	70.9	71.2
	Relative Humidity (%)	6 a.m.	98	97	98	98	98	98	97	97	97	98	98	98	98
		12 noon	62	64	65	73	78	82	79	78	77	77	70	69	73
Enugu	Rainfall (Inches)	0.7	1.1	2.6	5.9	10.4	11.4	7.6	6.7	12.8	9.8	2.1	0.5	71.5	
	Temp. (°F)	Max.	89.7	92.1	92.7	91.1	88.1	85.1	82.9	83.0	84.5	86.5	89.2	89.3	87.8
		Min.	72.2	73.3	75.0	74.8	72.9	71.6	71.5	71.1	70.8	71.0	72.6	72.1	72.4
	Relative Humidity (%)	6 a.m.	82	80	86	88	91	92	92	91	93	93	91	83	89
		12 noon	46	46	54	62	69	73	75	73	73	70	58	50	62
Ibadan	Rainfall (Inches)	0.4	0.9	3.5	5.5	5.9	7.5	6.3	3.4	7.0	6.1	1.6	0.4	48.4	
	Temp. (°F)	Max.	91.2	93.5	93.9	92.4	88.8	85.6	82.2	82.1	84.7	86.7	89.5	90.3	88.5
		Min.	69.2	70.5	72.7	72.5	71.9	71.0	70.0	70.0	70.0	69.7	69.9	69.2	70.5
	Relative Humidity (%)	6 a.m.	94	92	95	95	96	97	97	97	97	98	97	96	96
		12 noon	51	49	54	60	67	74	78	78	75	79	63	56	65
Yola	Rainfall (Inches)	0.0	0.0	0.3	1.9	4.9	6.2	6.8	7.7	7.8	3.2	0.2	0.0	39.0	
	Temp. (°F)	Max.	95.1	98.4	102.0	103.0	96.9	90.5	87.4	86.2	87.2	91.1	96.9	96.0	94.2
		Min.	65.2	69.4	75.5	78.8	76.1	73.4	72.4	72.5	71.5	71.9	67.5	65.1	71.6
	Relative Humidity (%)	6 a.m.	35	33	34	55	76	87	90	92	93	91	71	47	67
		12 noon	16	15	17	26	39	61	66	68	69	60	29	19	40
Jos	Rainfall (Inches)	0.1	0.1	1.0	3.5	7.9	9.1	12.9	11.6	8.4	1.6	0.1	0.1	56.4	
	Temp. (°F)	Max.	82.1	85.6	87.2	88.5	85.0	80.9	76.4	74.9	78.6	82.2	83.4	82.4	82.2
		Min.	57.0	59.3	64.1	66.3	65.4	63.4	62.7	62.3	62.2	62.2	60.3	57.2	61.9
	Relative Humidity (%)	6 a.m.	33	40	45	66	83	92	95	97	96	86	51	40	69
		12 noon	14	17	18	24	46	62	71	76	63	45	21	17	39
Sokoto	Rainfall (Inches)	0.0	0.0	0.0	0.4	2.0	3.5	5.8	9.3	5.7	0.5	0.0	0.0	27.3	
	Temp. (°F)	Max.	96.1	95.5	100.7	104.9	102.8	97.6	90.7	86.3	89.4	96.1	97.7	92.6	95.5
		Min.	59.6	62.9	70.2	76.2	78.6	76.4	72.5	72.1	71.6	70.5	64.3	59.8	69.6
	Relative Humidity (%)	6 a.m.	28	31	23	33	56	71	81	90	90	82	47	38	56
		12 noon	12	16	10	17	29	41	55	68	63	41	16	17	32
Kano	Rainfall (Inches)	0.0	0.0	0.1	0.4	2.5	4.4	8.0	12.4	5.0	0.5	0.0	0.0	33.3	
	Temp. (°F)	Max.	85.6	89.9	95.7	100.8	99.3	94.5	87.2	85.1	88.0	93.5	92.5	87.1	91.6
		Min.	56.1	59.5	65.9	72.4	74.6	73.9	71.1	69.6	69.4	68.1	61.1	56.9	66.6
	Relative Humidity (%)	6 a.m.	37	33	31	42	63	74	88	94	92	80	48	43	60
		12 noon	13	12	12	19	32	46	60	71	61	36	15	12	32
Maiduguri	Rainfall (Inches)	0.0	0.0	0.0	0.3	1.6	2.7	6.9	8.8	4.1	0.8	0.0	0.0	25.2	
	Temp. (°F)	Max.	88.9	92.9	98.2	104.1	102.1	97.4	89.4	85.6	89.4	95.3	95.1	90.3	94.0
		Min.	54.7	58.0	64.9	71.1	75.4	74.8	72.7	71.2	70.9	68.5	59.6	55.4	66.4
	Relative Humidity (%)	6 a.m.	40	41	34	32	53	73	87	94	93	83	60	56	61
		12 noon	17	13	11	12	25	40	60	69	59	37	18	20	32

Notes--For each city the data given are: (1) Mean monthly rainfall in inches
 (2) Mean daily maximum temperatures (°F)
 (3) Mean daily minimum temperatures (°F)
 (4) Mean relative humidity at 6 a.m. (%)
 (5) Mean relative humidity at 12 noon (%)

COMFORT ZONE

CLIMATIC CONTROL STRATEGIES

- 1-None Existent
- 2 Comfort Zone Shading Required
- 3,4 Promote Natural Ventilation
- 5 Enhance Ventilative Cooling With High Mass
- 6 Promote Evaporative Cooling & Active Natural Cooling With Thermal Mass

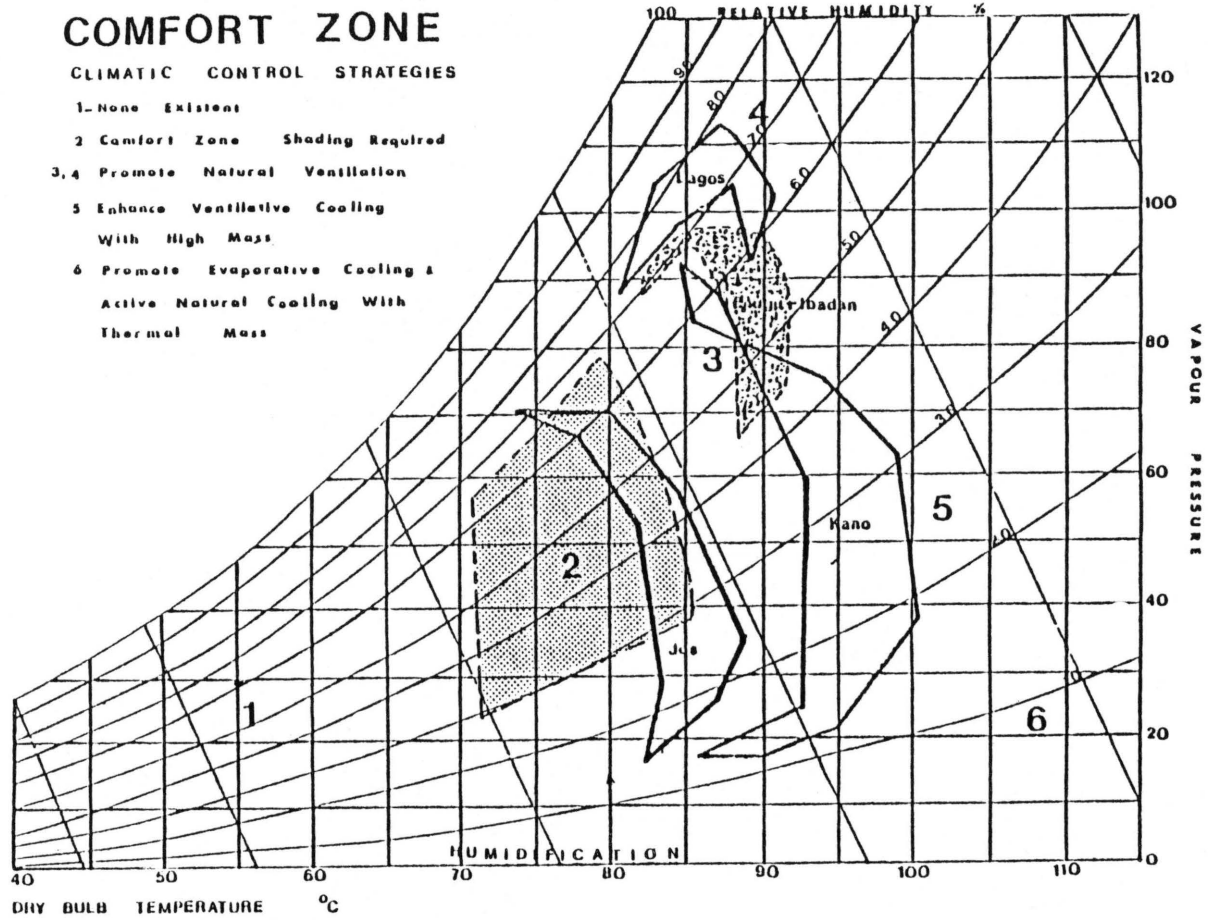
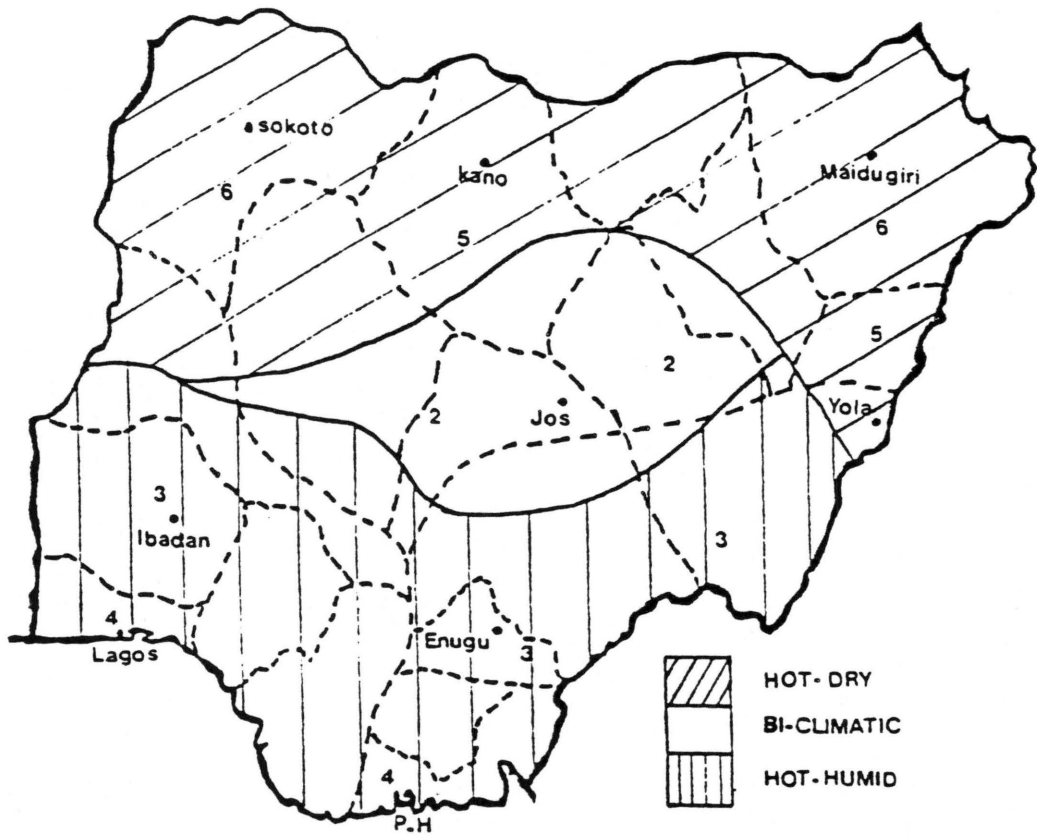

Figure 2. Comfort Zone



COMFORT ZONE

CLIMATIC CONTROL STRATEGIES

- 1 - None Existent
- 2 - Comfort Zone Shading Required
- 3, 4 - Promote Natural Ventilation
- 5 - Enhance Night Time Cooling & High Thermal Mass
- 6 - Promote Evaporative Cooling & Active Natural Cooling; Use Thermal Mass

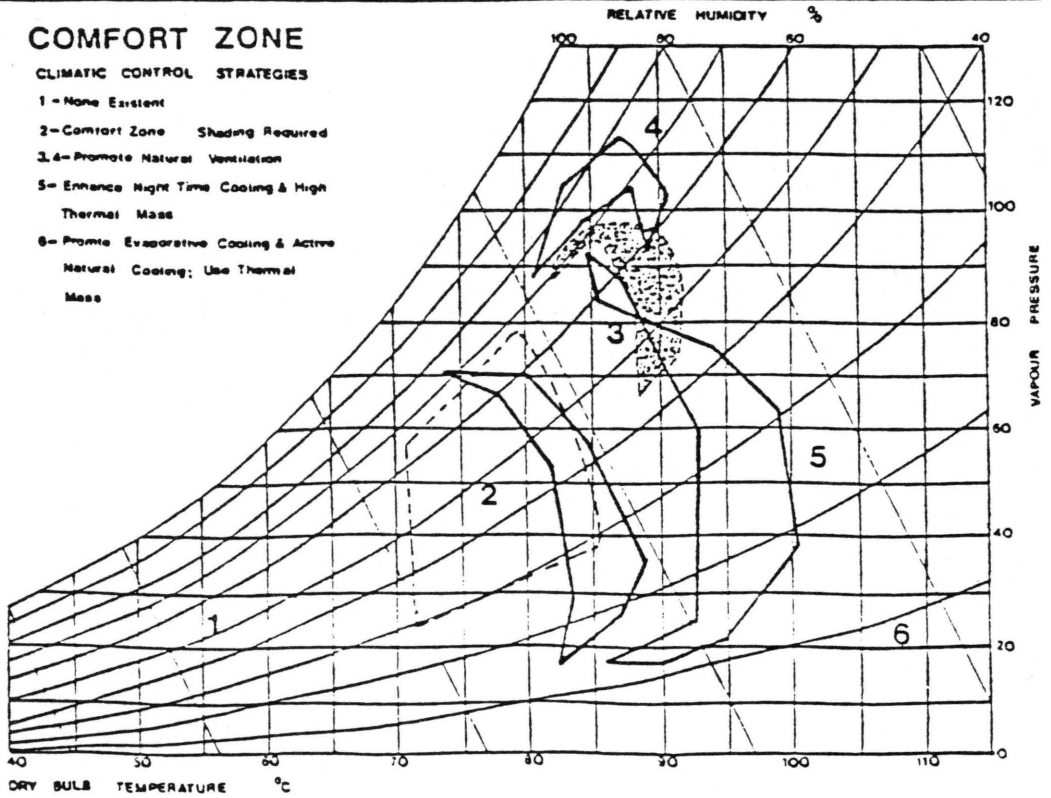

Figure 3. Climatic Conditions in Major Nigeria Cities

B. Appropriate Building Materials for Hot Humid Climate

Materials of good thermal characteristics are necessary in order to control indoor temperature fluctuations during the day and at night. The choice of building materials rested on two major criteria; the thermal characteristics and the configuration within which materials are used. The materials which have thermal characteristics suitable for use are those with low heat capacity and short time lag. Heat capacity is the amount of heat a material can absorb when exposed to heat over a period of time. Time lag is a measurement of how long a material takes to respond to temperature change. See Appendix B for thermal performance of major building material in hot humid regions. The recommended time lag for materials to be used for wall and roof construction in the hot humid climate is 3 hours.⁴ The configuration within which the materials are used, that is, walls, roofs, floors and screens, must take advantage of the thermal characteristics in process of balancing form, volume, mass and void into combinations which in a most positive way balance negative and positive thermal capacities. The two main variables used to evaluate their performance standards are U-value and the solar heat factor. U-value is the amount of heat transmitted from an outside surface to an interior surface of the wall when there is a change in temperature. Speaking of heat transfer, there are three modes that exist in nature; namely, conduction, convection and radiation (see Fig. 4).

HEAT MOVES FROM HOT TO COLD**CONDUCTION****CONVECTION****RADIATION**

Figure 4

Heat Transfer Mechanisms

The following recommendations have been established by climate and house design as minimum thermal performance standards for roof and wall construction in hot humid region.⁵

For walls U value 2.8 in/m²/deg C

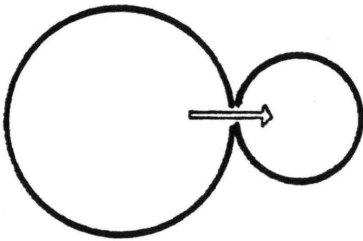
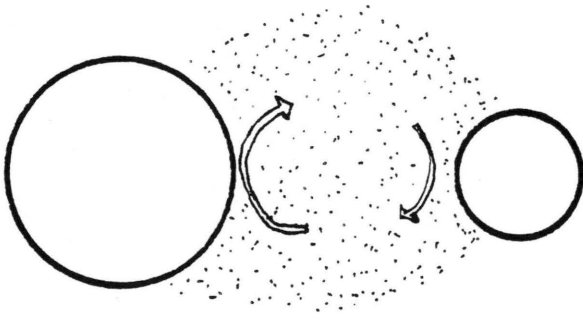
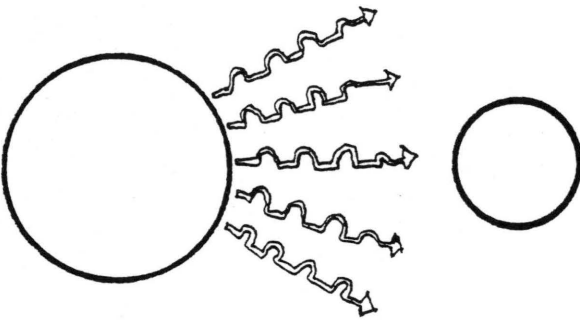
Solar heat factor 4%

For roofs U value 1.1 in/m²/deg C

Solar heat factor 4%

Detailed standard heat performance is given in the Appendix B.

3 BASIC METHOD OF CLIMATIC BALANCED HOUSING DESIGN

The site of illustration is located on latitude 6°N in the vicinity of Ikeja at the mainland of Lagos. The site is designated for housing project by the Lagos state government. It is Ojaa Housing Project (see Map 1), and is expected to accommodate the high, middle and low income groups with the necessary community conveniences.

A. Design Techniques

(I) Micro-Climatic Analysis

The most obvious characteristics of Ikeja climate is that it is warm and continually damp. There is very little seasonal variation due to its nearness to the coast. The climatic variables that play major roles in the architectural forms of the site of illustration are temperature, humidity, wind and rainfall. The annual climatic data for Ikeja Lagos is illustrated in Fig. 5 and Table 2. The temperature varies between 23°C (73°F) and 32°C . (90°F). Humidity is high during most of the year and varies from a low of 70% at 2:00 p.m. to a high of 95% at 6:00 a.m.⁶ Winds are generally gentle and almost constant in direction. The southwest wind dominates the moisture laden southwest and the northeast winds are the major wind systems. From February to November, the southwest monsoon wind prevails and brings rain to the area. In December and January the northeast wind moves the tropical continental air masses from the Sahara (see Map 6 in Appendix A). This, however, has little effect on the coastal areas because of the distance

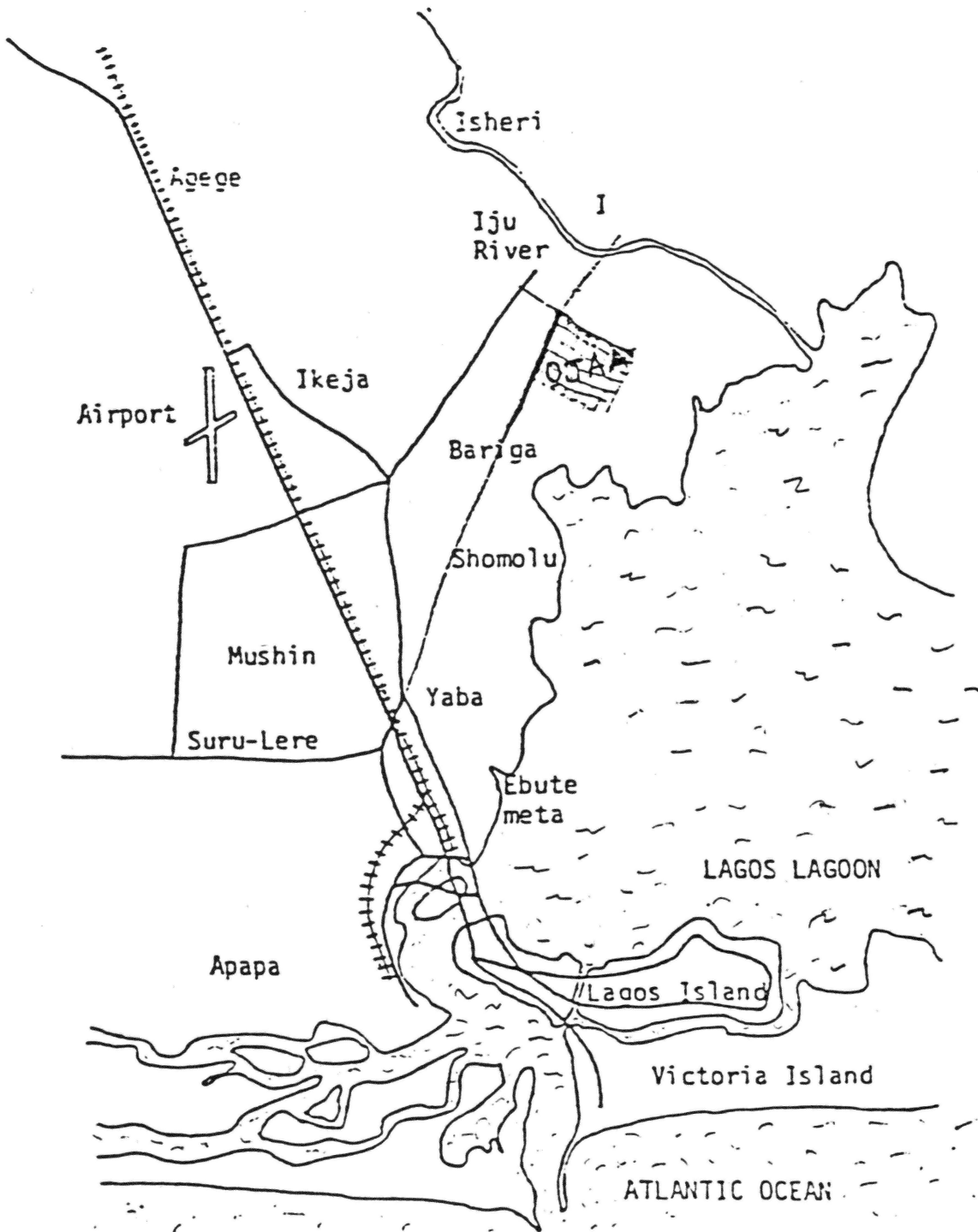

Map 1: Location of Site Within Lagos

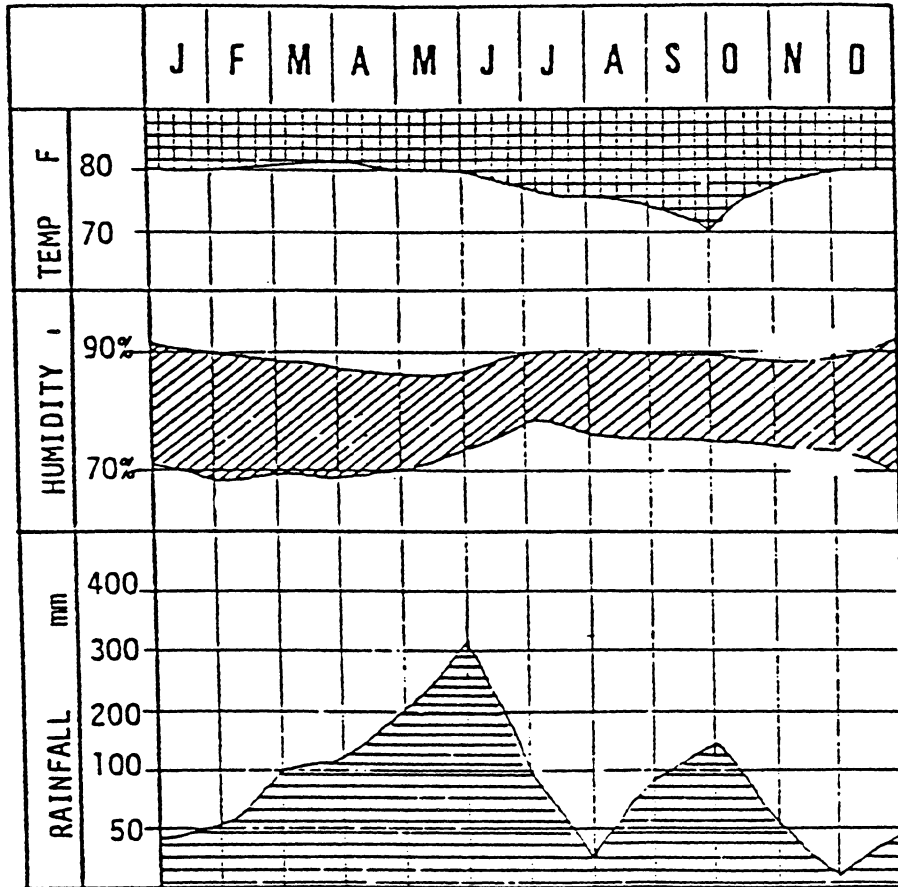

Figure 5

Climatic Data for Lagos

Source: World Handbook of Climatic Data

Table 2. Climatic Data for Lagos

LOCATION	LAGOS, NIGERIA
LONGITUDE	3° 36 'E
LATITUDE	6°N
ALTITUDE	10M

RELATIVE HUMIDITY %	J	F	M	A	M	J	J	A	S	O	N	D
Monthly Mean Max. 6 a.m.	92	91	89	90	92	94	91	91	92	95	96	98
Monthly Mean Min. 2:00 p.m.	62	64	65	73	78	82	79	78	77	77	70	69
Average Monthly Mean	77	77	77	81	85	88	85	84	84	86	83	83

Monthly Mean Max. - °F	90.5	91.0	91.5	90.2	87.9	84.2	82.2	81.7	83.9	85.7	89.3	89.3
Monthly Mean Min. - °F	69.8	72.6	73.1	71.1	72.1	71.2	70.0	69.7	70.5	71.0	71.7	70.9
Average Monthly Mean	80	82	82	81	80	78	76	76	77	78	80	80

Source: 1982-83 Lagos State Meteorological Report.

to the source and vegetative cover (see Map 7 in Appendix A). Ojaa, therefore, remains all year round under the influence of the maritime southwest wind (see Map 6 in Appendix A).

The land and sea breezes are very important in determining the weather of Ojaa site because of its proximity to Lagos Lagoon. During the day, the land atmospheric air is warmer than that of the sea. This creates pressure difference between the land and the sea. The warmer air rises; creating a suction effect, drawing in cooler air from the lagoon. Within half an hour of arrival of the cooler breezes from the lagoon, the temperature may drop between 5°F and 8°F and thus bring relief to the occupants of this location (Fig. 6). The direction of the breeze reverses at night. The wind speed varies normally between 9 and 19 km/hr. But in wet season the wind gusts accompanying the rainfall can reach a speed as high as 30 km/hr. The rainfall is most intense during the monsoon period. The 24 hour-rainfall varies from a low of 25 mm. (an inch) in December to a high of 170 mm. (7 inches) in July. The annual rainfall range is 1800 mm (72 inches).

Solar movement in this latitude is pivotal. Being on latitude 6°N from the equator, the sun shines from the northern hemisphere from March to September and from the southern hemisphere for the remaining six months of the year. Night and day are almost equal throughout the year. Since it is constantly humid, the sky generally is cloudy and direct solar radiation is relatively rare. Figure 7 shows how the hours of sunshine vary during the year. The yearly mean gives only 4.47 hours of direct sunshine per day.⁷ This means only 35-40% of the daylight time have direct sunrays not shielded by the clouds.

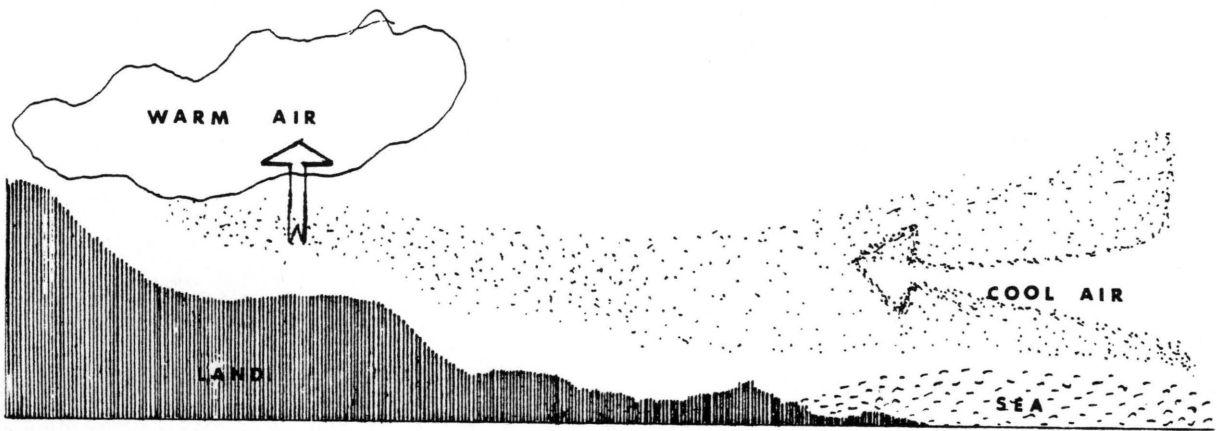

Figure 6

Land and Sea Breezes

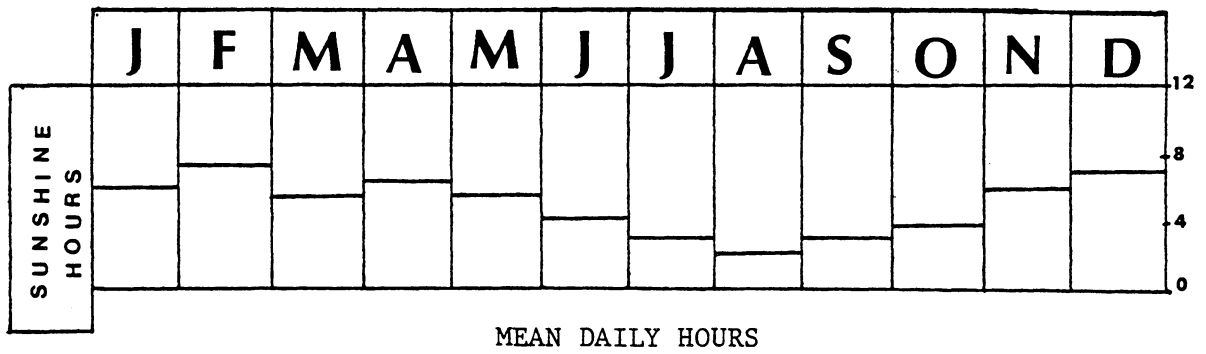

Figure 7
Climatic Data

Source: Lagos State Master Plan

(II) Building Geometry and Planning

Orientation is one of the most important factors which influences the effect of solar radiation and ventilation on buildings. In a hot humid climate it is very important to orientate the buildings to maximize the cooling effect of ventilation and minimize the direct solar heat gain. This climate favors elongating the building on an east-west axis, so that it provides generous southern and northern exposure. Buffer zone which could accommodate the services like patio, dining, kitchen, pantry, toilets, etc., are best located on east and west ends. This is to prevent all year round direct solar heat gain of low altitude sun angle (which is very difficult to control by shading) from penetrating into the livable areas. Solar radiation on north and south walls are seasonal. It is of high altitude sun angle and could be easily controlled by shading devices. Openings are therefore best on the north and south walls and with little or none, if possible, on the east and west walls (Figs. 8, 9 and 10).

N

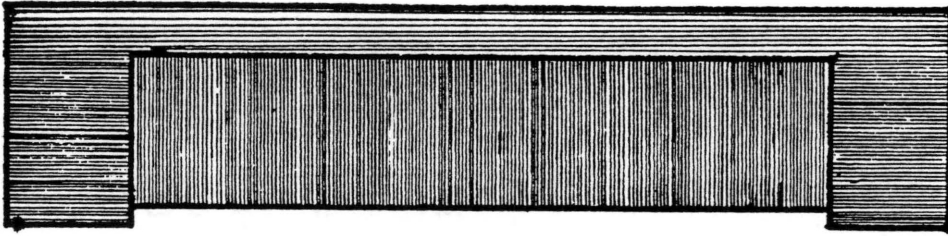

S

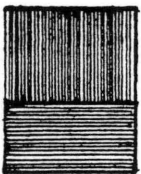

Liveable Zone

Buffer Zone

Figure 8

Concept for Building Geometry

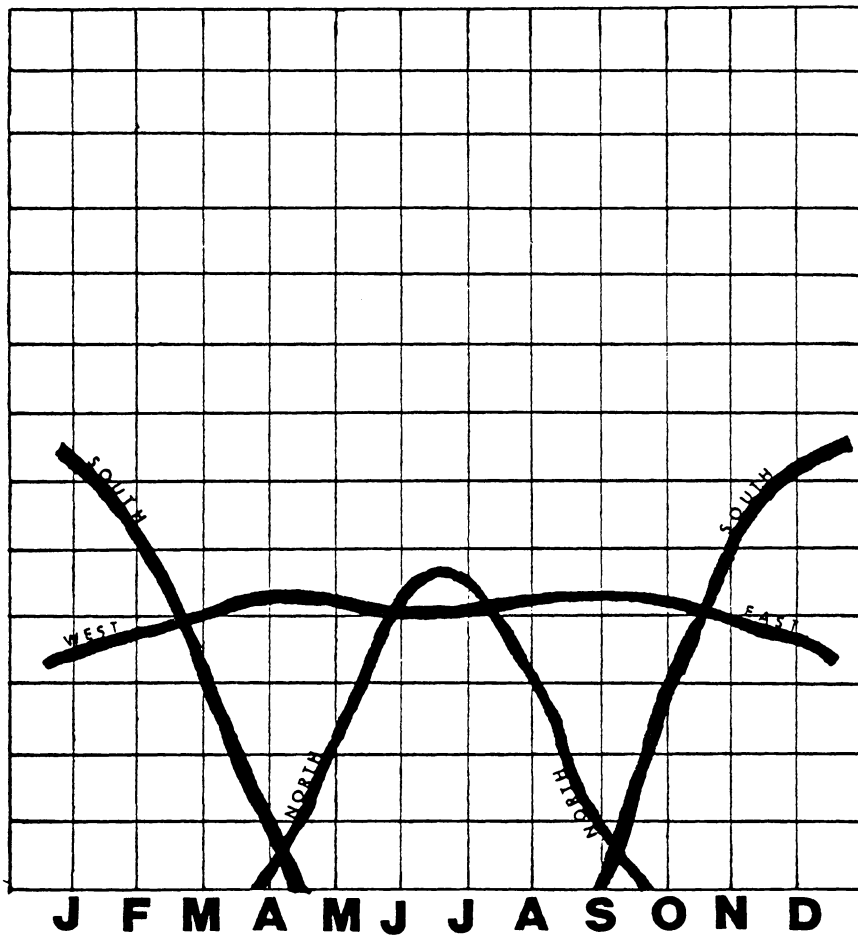

Figure 9

Direct Solar Radiation Incident on Walls Oriented to the North and South Are Seasonal. On the East and West Walls Solar radiation Is All Year Round.

Source: Passive Solar Handbook.

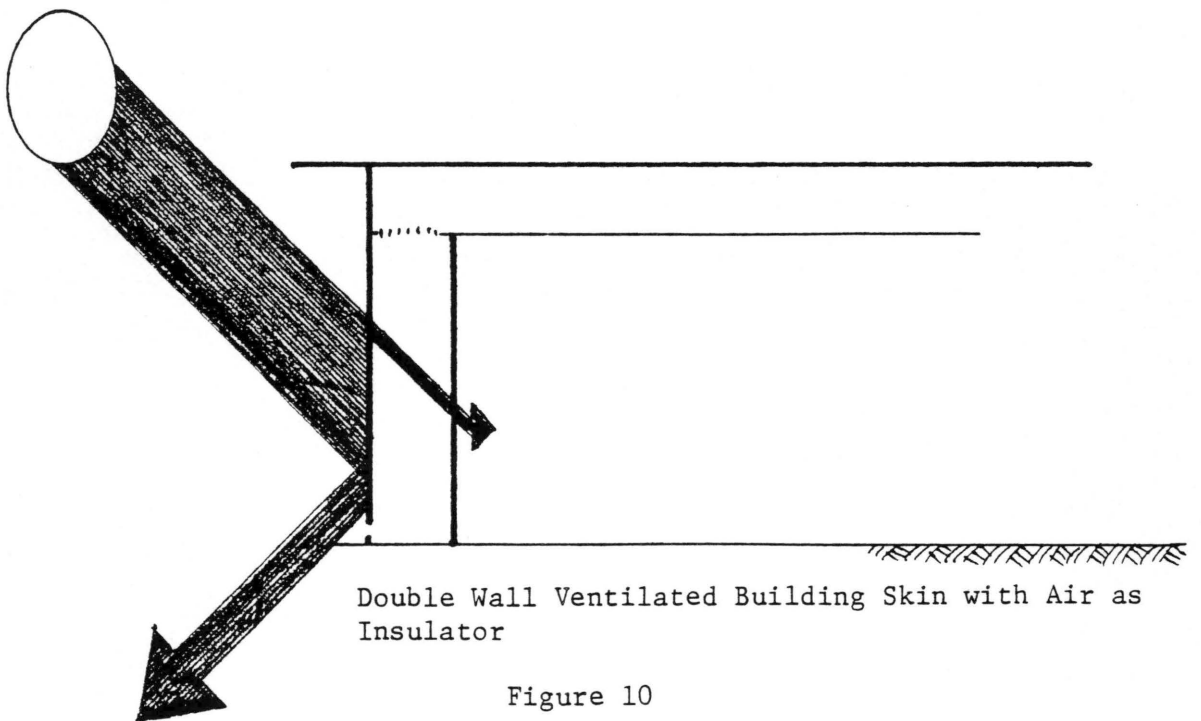
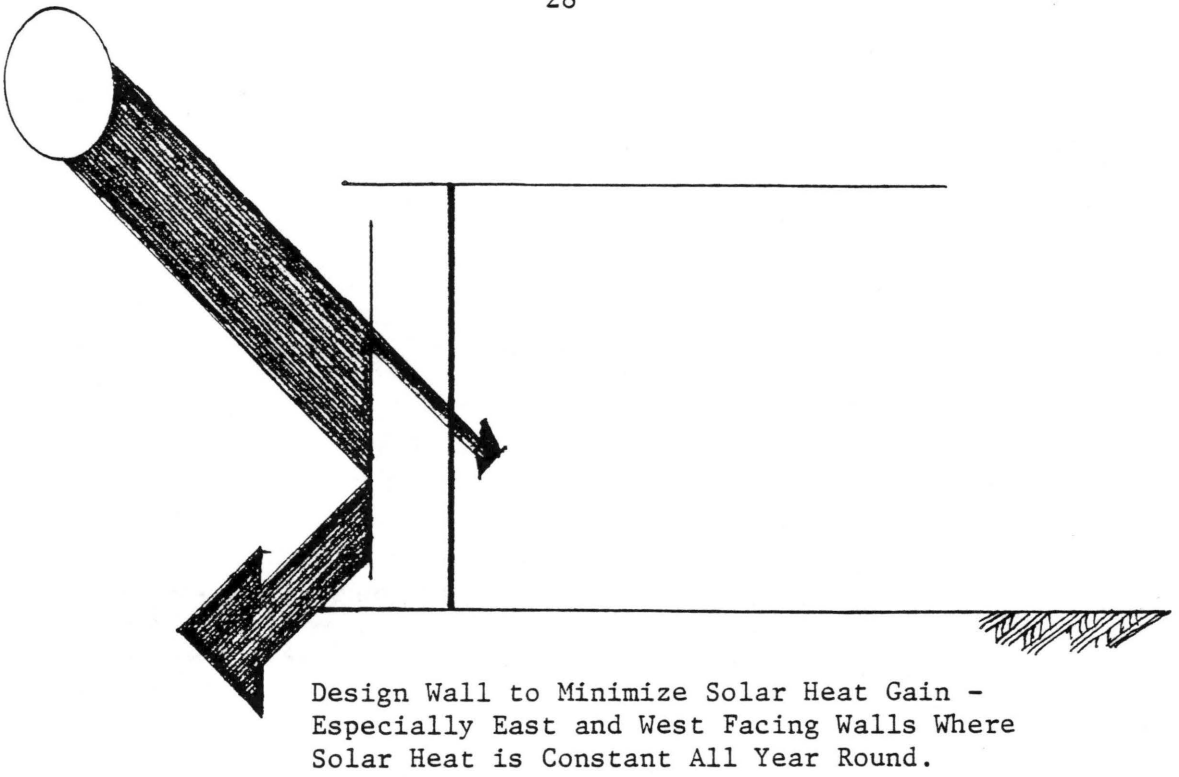
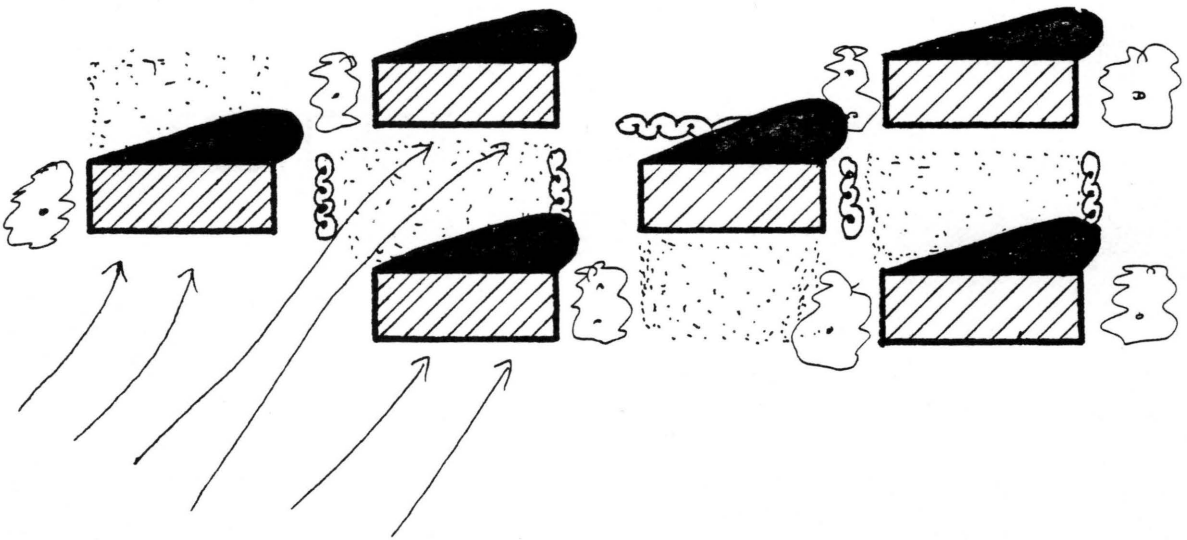

Figure 10
Wall Concept

(III) Planning Concept

Staggered buildings around courtyard to allow for free flow of air. Adequate distance between buildings--depends on each building's height. Avoid locating a building in another building windshadow. Courtyards created between buildings could be put to very good use like an extension of indoor livable area and recreation purposes if well planned (Fig. 11).



Stagger buildings around court-yard to allow for free flow of air.

Figure 11

Loose Planning

IV. Opening Concept

Buildings and their occupants have been cooled by simply opening the building windows and ventilating the space whenever the outdoors are pleasant. With mechanical air conditioning and energy becoming increasingly expensive, natural ventilation is being critically reexamined. Natural ventilation is one of the most effective, practical cooling strategies for hot humid regions. A thorough knowledge of natural air flow and its basic characteristics is essential. For example, location of openings are very typical for each room since each has different ventilation needs. For example, the bedroom needs air movement at the bed level to facilitate the optimum comfort of the occupant, whereas a family room needs ventilation at sitting level. Some regions require maximum air changes per second whereas some require maximum velocity for comfort. Where maximum air changes are required, openings as large as possible on two opposite walls will be desirable. Where maximum velocity of air per second is needed, inlet opening should be smaller than the outlet opening to achieve this goal. Sizing the openings to obtain the desired air flow is also of great importance.

For effective natural ventilation, consideration should be given to the following design tips:

- Locate buildings in the free sweep of the wind
- Design buildings with consideration given to location of pressure areas and wind shadows

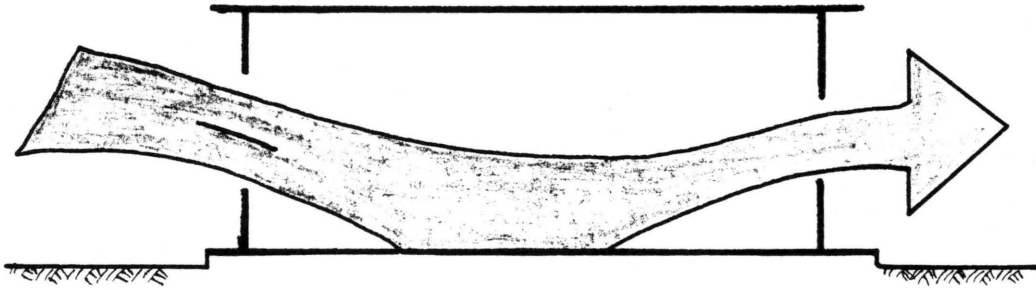

Design windows to maximize breeze and cross-ventilation of the interior.

Figure 12
Window Design Concept

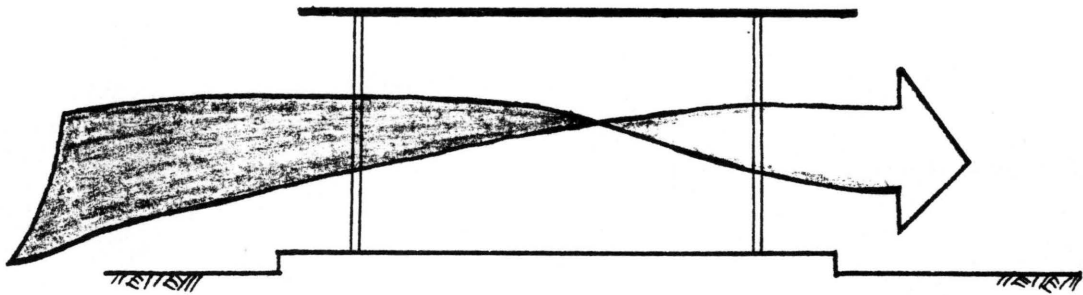

Open interior planning to maximize air flow inside the building.

Figure 13
Spatial Planning Concept

- Provide inlet openings on the high pressure walls and outlet on the the low pressure walls
- Design interior partitions and landscaping to facilitate air flow
- Control the direction of air flow by proper location and design of openings
- Control amount of airflow by proper sizing of openings

(V) Energy Conscious Landscaping

Landscaping reduces the retention of heat by preventing direct solar radiation on walls, windows and roofs. High branching tree like palm tree will shade an opening and still channel cool breezes into the living area (fig. 14). Trees, hedges and shrubs have to be carefully selected since heavy plantings could generate the unwanted humidity and also inhibit free flow of air. A list of shapes and sizes of tropical trees suitable is provided in Appendix E, Table 10. Landscaping can also be used to redirect air flow and to promote cross ventilation. It can be effectively used to screen undesirable view and enhance privacy, and control noise to some extent. Landscaping can also be expanded beyond single site; it could be used to channel desirable breezes into a neighborhood. Landscaping also increases comfort by expanding the use of outdoor space (fig. 17). Outdoors, if properly shaded and screened, can be comfortable all year round. Carefully selected plants can decorate shelter trellises, pergolas, patios and make outdoor living space very attractive (fig. 17). The creation of this beautiful outdoor living space will also provide a screen from neighbors and from heat and noise from the street.

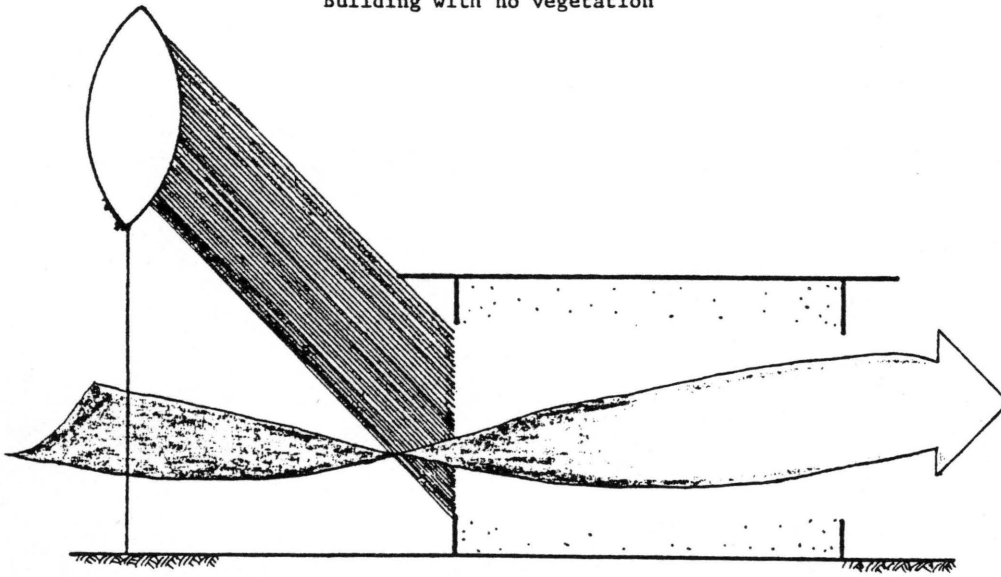
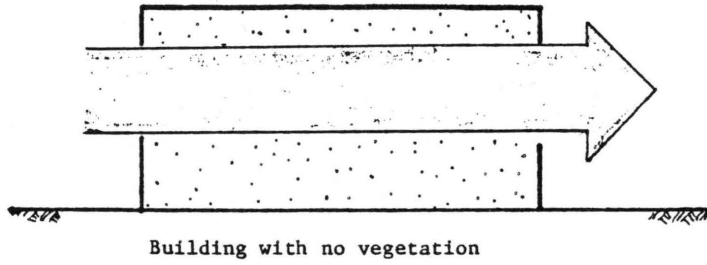

Tree shades the opening, minimizes direct solar heat gain by wall, and still provides free flow of air through opening.

Figure 14

Landscaping Concept

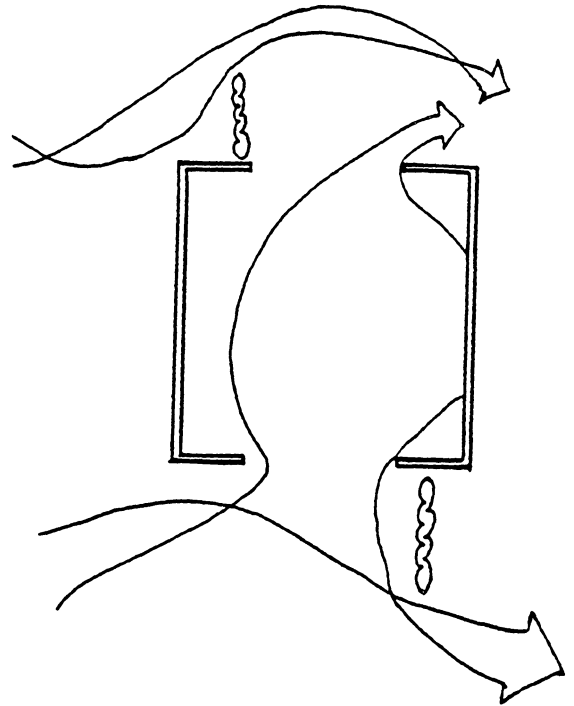
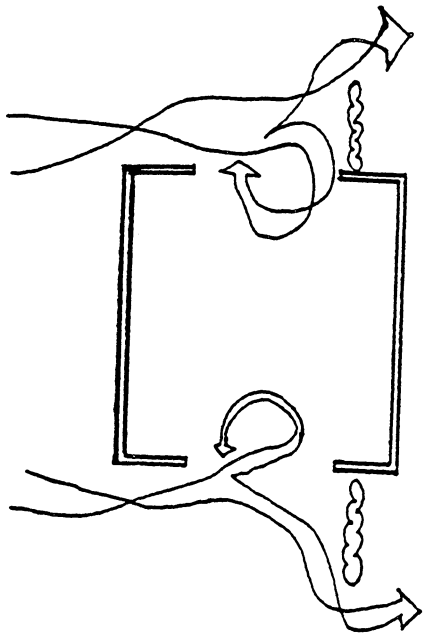

Plans: Bad

Good

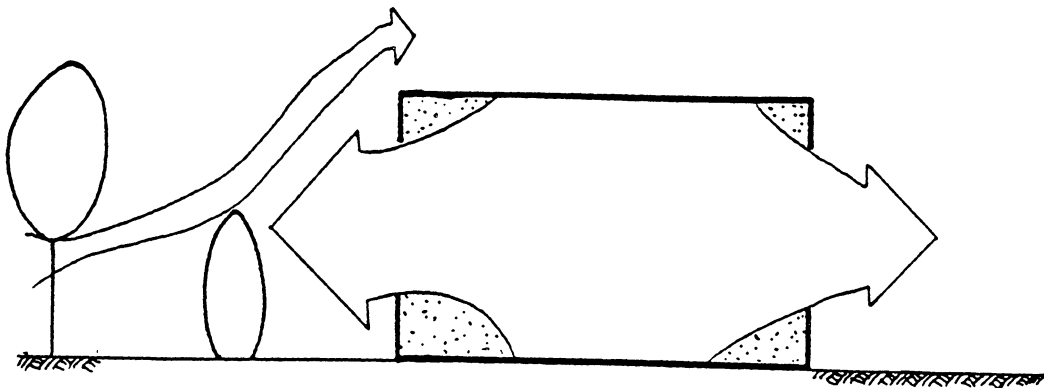

Figure 15

Using Hedges and Trees to Re-Direct Section-Wind and to Promote Cross-Ventilation in Buildings.

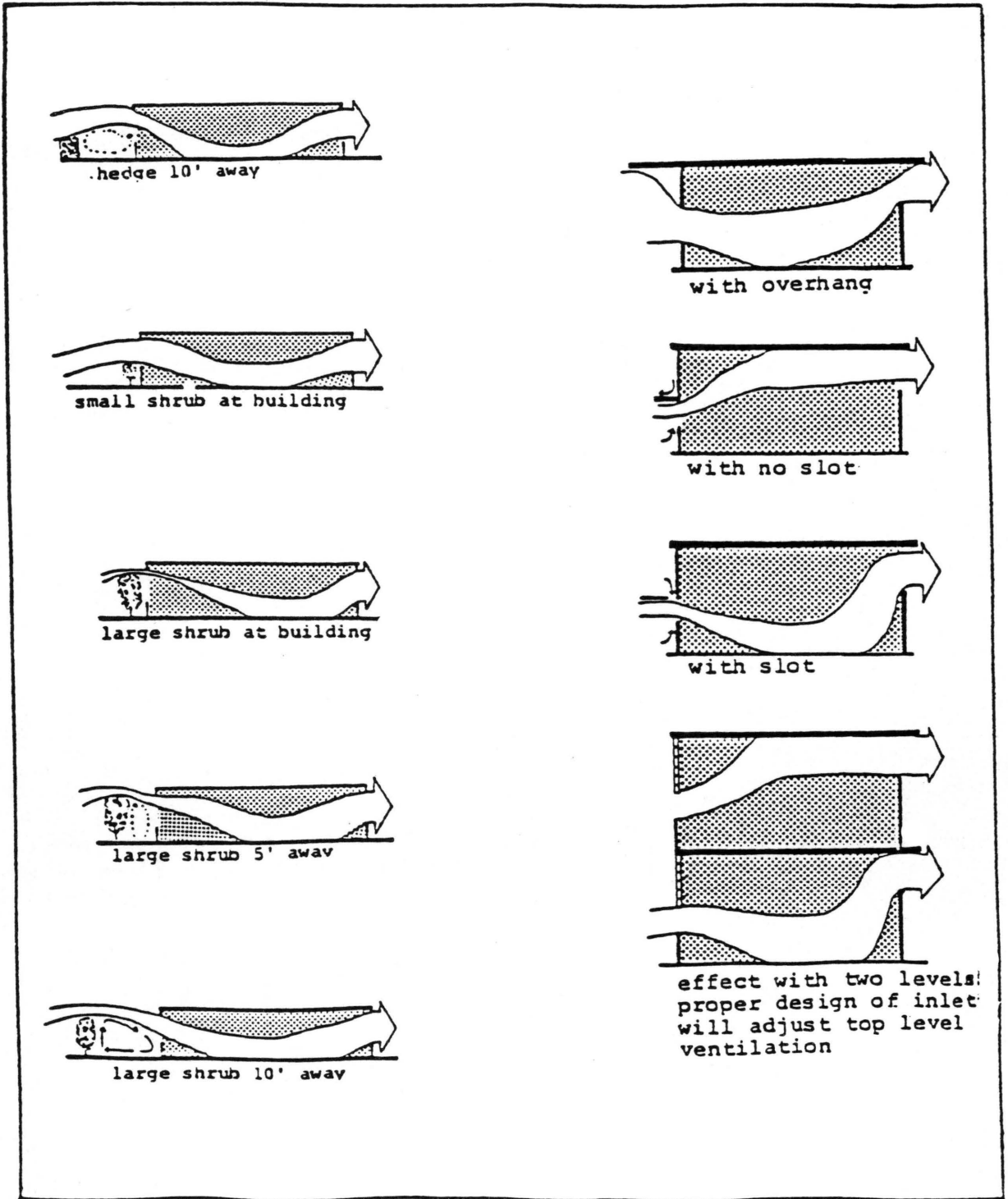

Figure 16

Effect of Vegetation, Overhang and Slot on Cross Ventilation

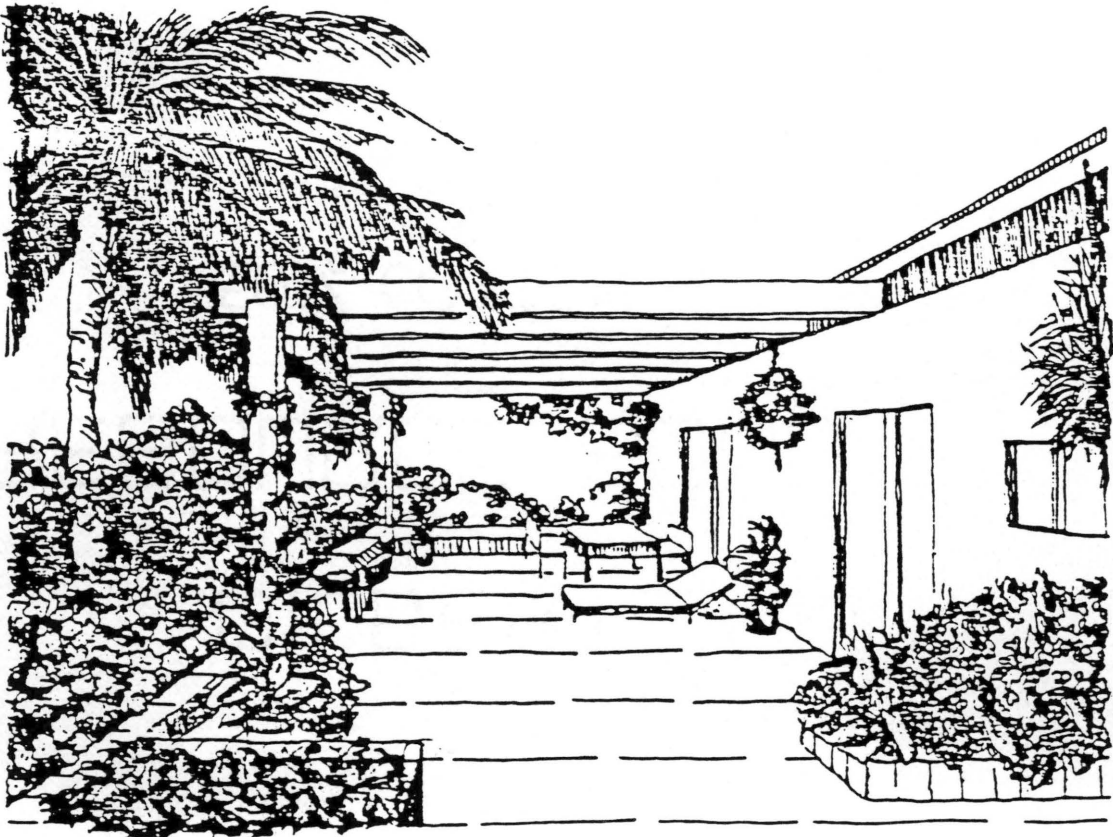

Figure 17

Landscaped Trellis and Patio

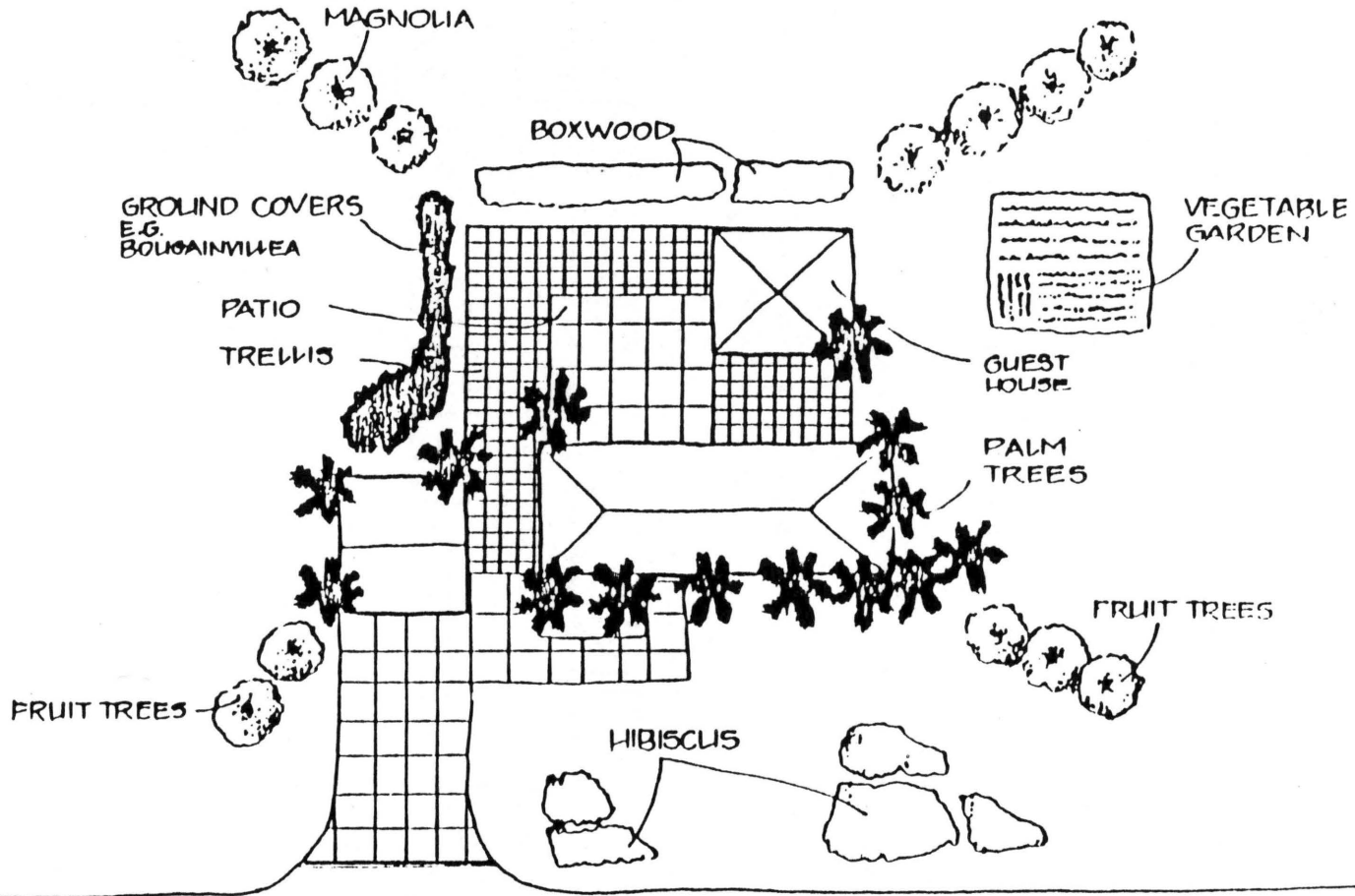

Figure 18. Typical Landscape Design for Hot Humid Region

B. Details for Optimizing Environmental Conditions

An intimate knowledge of the natural resources of an environment and a knowledgeable manipulation of its assets and liabilities are essential for the designing of "a climate balanced housing" that provides comfort to its occupant. To achieve this end, the window systems, sun control devices and the roof should be well synchronized with the exigencies of the given natural environment. Also the solar possibilities have to be explored.

(I) Window Systems for Ventilative Cooling

Three steps have to be identified in designing window systems for natural cooling. First, it is essential to make an assessment of the need for ventilative cooling--which has been confirmed in Fig. 2. Second, it is important to have a clear picture of the directional range of the wind on the site. Third, it is vital to choose a window system which corresponds in its functional characteristics to both the wind and the thermal comfort requirements of the site.

Reviewing the laboratory studies on window systems done by Givoni, Evans, Harris, Sobin, Reed and Caudill, the major concern is investigating the degree and manner in which various window configurations convert the kinetic energy of the natural wind into useful indoor air movement. Particular emphasis being placed on examining the airflow effect of:

- Orientation to wind
- Cross-ventilation
- Relative size of inlet and outlet openings

- The shape of inlets, and
- Window types

Orientation to wind angle varies with the physical characteristics of window location, size and shape. Figs. 19a and 19b show inlet opening at 90° to the wind direction. Note the eddys which develop against the main stream of airflow in Fig. 19a. This can be further improved by locating two outlets of total equal area to the inlet on the side walls as shown by Fig. 19b. Figures 19c and 19d show the same situation but with the wind at 45° to the inlet opening--which shows a better ventilated space.

A sufficient effective area of inlet and outlet openings are required for optimum cross ventilative cooling, with inlet openings located at positive pressure zone and outlet not necessarily opposite the inlet openings (Figs. 19b and 19c). One window room gets only one-third of the average speed ratio provided by a cross-ventilated room. This could be greatly improved by providing two windows as far apart as possible on the same wall (Fig. 20a). It could be further augmented by wing walls added to the wall exterior at the inner edges of the windows achieving cross ventilation in a one wall opening room (see Fig. 23b).

Increase in inlet/outlet opening area increases interior cooling. Since window sizes are not solely determined by ventilation, but with other factors such as daylighting, privacy, security and solar controls, inlet/outlet ratio that gives best cooling effect has to be known. Studies show that for maximum airflow velocity in a space (which is needed for comfort in hot humid region) the inlet opening has to be relatively smaller than the outlet opening.

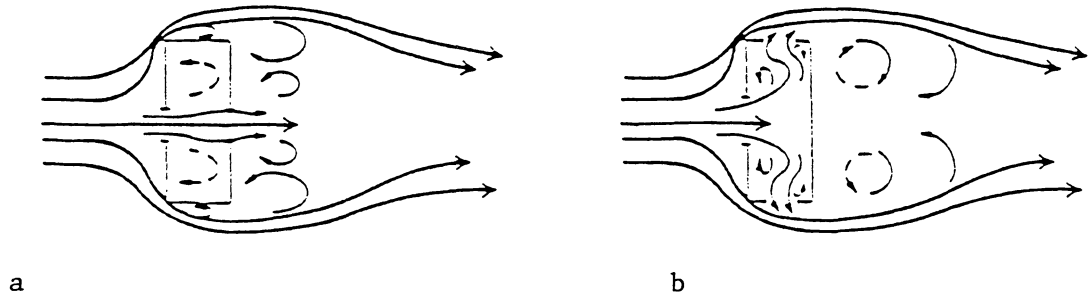

Flow through a building ventilated by (a) windward and leeward and (b) windward and side windows.

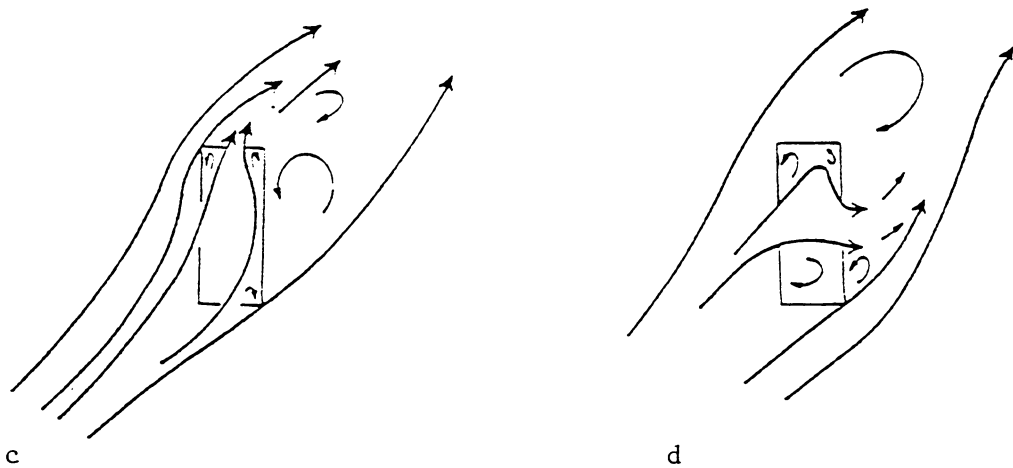

Flow through a building with windows (c) on adjacent walls for oblique winds and (d) on opposite walls for oblique winds.

Figure 19

Flow Pattern Through Buildings

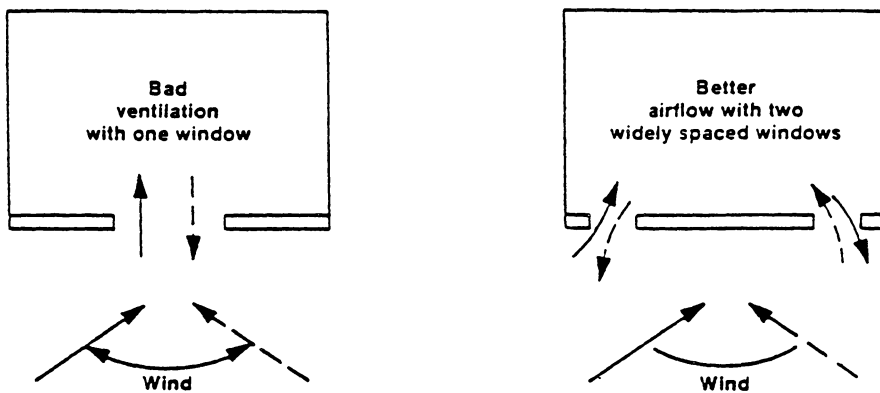

a. Two windows ventilate better than one in rooms with one outside wall.

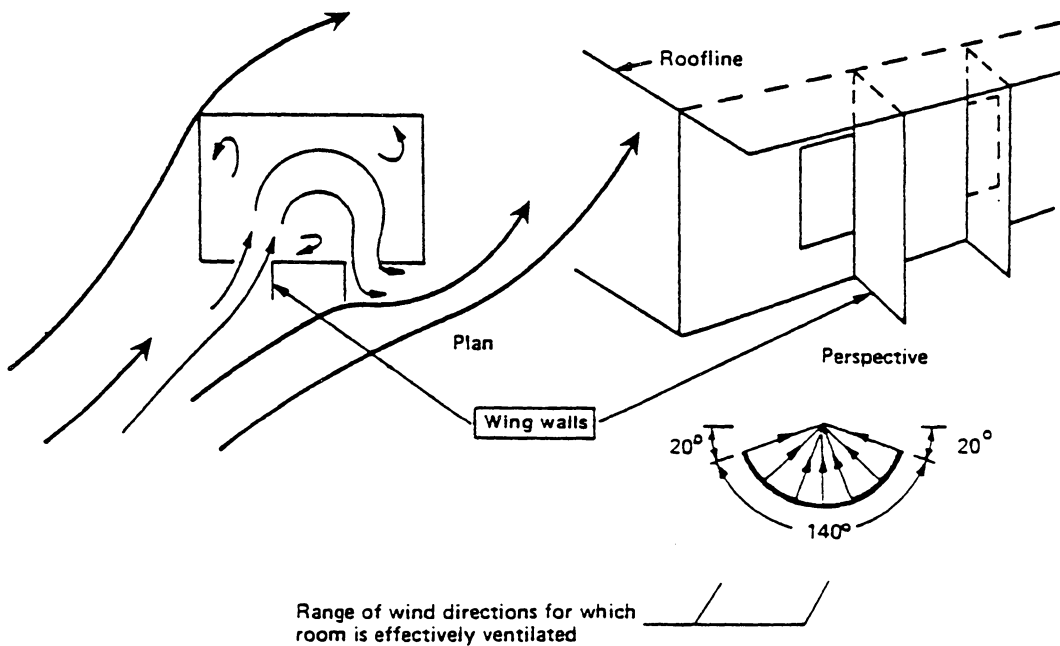

b. Good ventilation through windows on one wall when wing walls are added.

Figure 20

One Wall Opening Ventilation Analysis

Wind-tunnel tests conducted by H. J. Sobin shows the ventilative performance of equal area of horizontal, vertical and square inlets for various wind angles in cross ventilated rooms.⁸ Both square and vertical inlet openings produce a great difference under changing wind direction. Attaining maximum performance when wind is perpendicular to the opening and dropping off fastly. Note the horizontal opening (see fig. 40 in appendix H) not only produces more airflow, but also does it over a wider range, proving its superiority over both vertical and square openings. This strongly suggests that horizontally shaped openings should always be used whenever possible, since wind is rarely constant in direction even in areas of strong directional tradewinds.

For the purpose of clarity, windows will be broadly divided into two basic types in regard to effect on airflow patterns. They are

- Simple openings, and
- Horizontal vanes

Simple opening windows are such that opens by sliding, in a single plane horizontally and pivots on a single vertical axis. Examples are double-hung, horizontal sliding, side hinged casement also folding casement (see Fig. 21a). Horizontal vane windows are the projected sash, the awning, horizontal pivoted, the jalousie or louvered window--any window which opens by pivots on an horizontal axis (Fig. 21b). The jalousie is the most versatile of the window types for airflow control qualities. It can be adjusted to take the advantage of the wind regardless of the direction of the exterior wind. However, there is limitation to its use when two sources of cooling--(mechanical

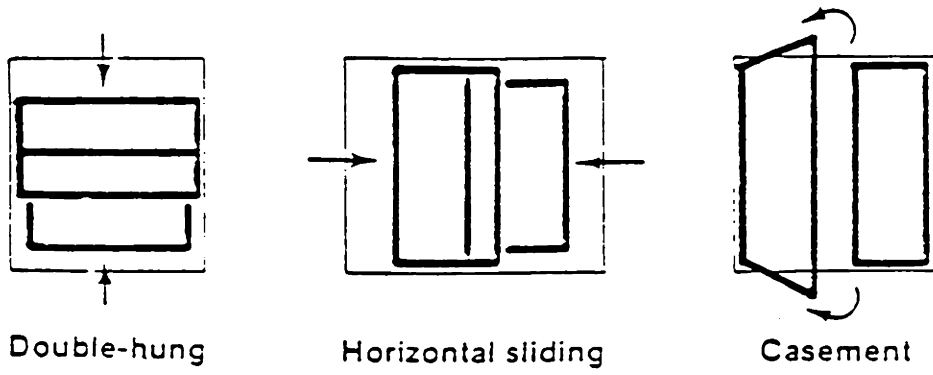

Figure 21a

Simple Openings

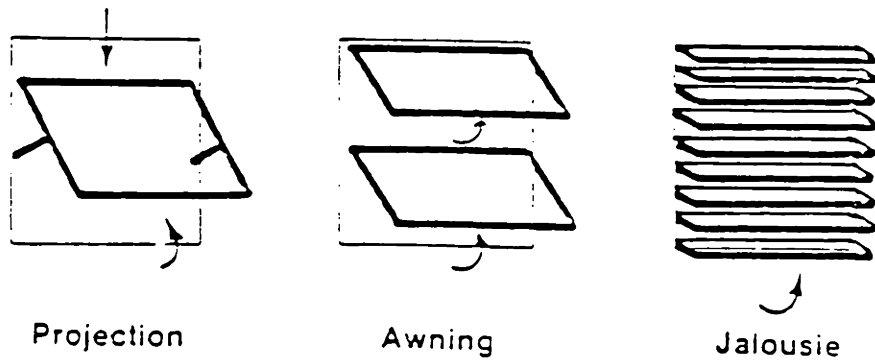

Figure 21b

Horizontal Vanes

air conditioning and natural ventilation through openings) are being considered for a building; this type of window cannot be completely sealed. Most simple openings give only 50% openable areas and at times divert air away from the living area. The casement is found to be solely dependent on the external wind direction.

There are too many variables in the design of buildings--climatic conditions, geographical location, human psychology, etc., to allow any one set of standard to govern the type, size and placement of windows to be used for natural ventilation. It is however possible to ascertain favorable conditions for a specific building, with the knowledge of air control of each window type, to choose the most capable of meeting the desired conditions.

(II) Sun Control Devices

One of the principal sources of heat gain into the building is through the windows. It is estimated that heat gain could be reduced by up to 70% if windows are adequately protected from direct sun rays. Using shading to prevent direct solar radiation from striking a glazed area or entering a window opening is a geometric problem which is defined by the path of the sun through the sky. Shading is time and latitude dependent due to the tilt of the Earth on its axis. To avoid over designing of sun shading devices, the over heated period of the year when protection from the sun is absolutely necessary needs to be calculated for that particular location. For example, the time when shading is needed for the illustrated site is shown in the shaded portion of the isopleth diagram for Ikeja (see Fig. 30 in appendix F)

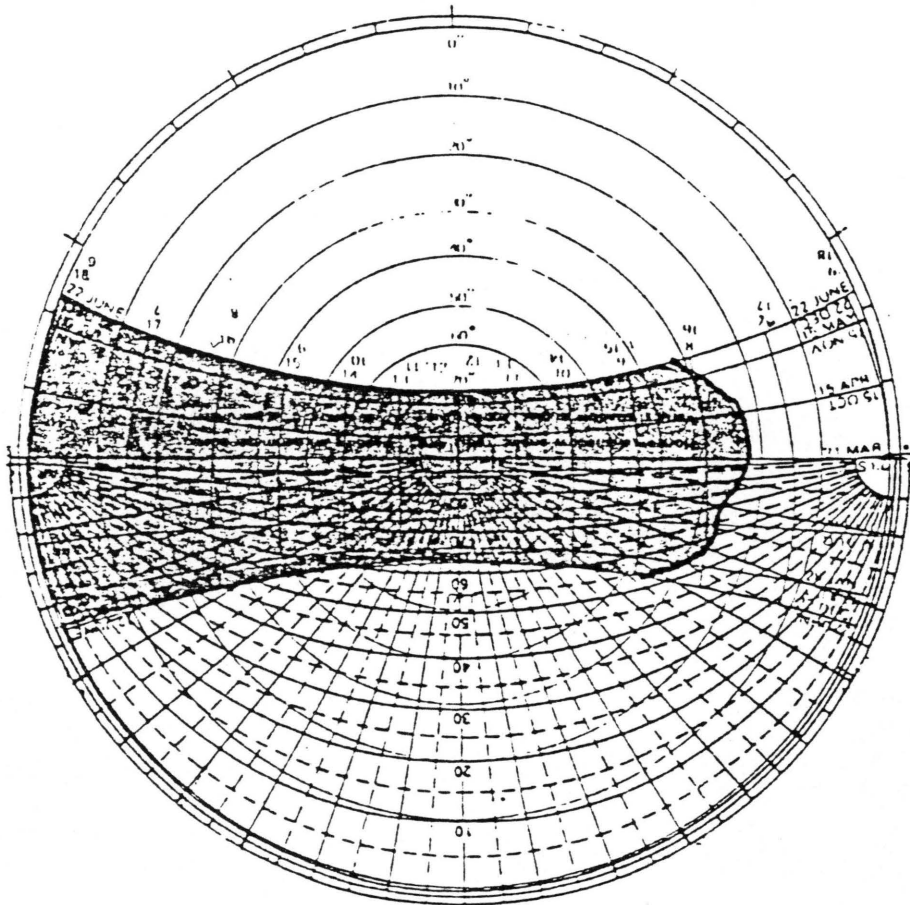

Fig. 22. Solar altitude and azimuth during over-heated periods of the year. The critical over-heated periods are shown in the shaded portion of the chart.

Source: Manual of Tropical Housing and Building. Part One: Climate Design.

an area closest to the site. This information when transferred to the solar chart (Fig. 22) will determine the type and angle of sunshading device necessary for a specific opening.

Figure 23 shows various types of sunshading device systems which could be applied to different situations, depending on its orientation. Other methods of sun control devices are double envelope buildings, double roof systems, movable shades, window films, careful selected vegetation and window curtains which has its short-comings.

(III) Solar Possibilities

The energy shortage and the astronomically high prices of the available source is triggering a renaissance in thought of means of alternative sources of energy in developed and developing countries. Solar energy is one of the few options that involves simple technology, non-pollutive and the least dangerous to handle by any developing country. This source will greatly reduce the energy expenses on hot water and air conditioned systems. This will also improve the living condition of the inhabitants of the hot humid region of Nigeria which is blessed with abundance of sunshine throughout the year. For detailed solar possibilities and DHW heating, solar induced ventilation and solar cooling systems see appendix G.

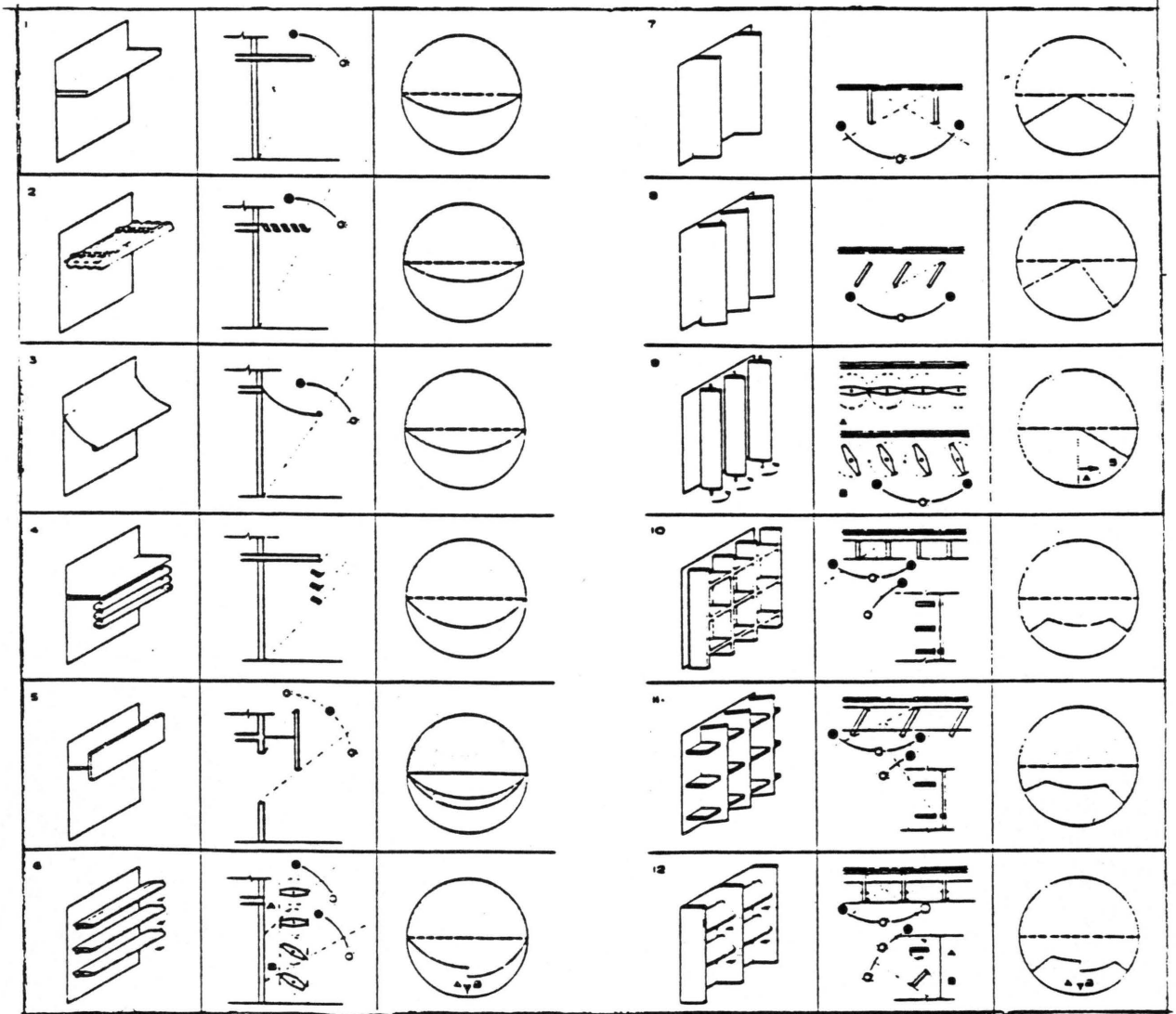

Figure 23

Types of Sunshading Devices

4 SPECIAL EXPERIMENT- ATION ON ROOF TYPE PERFORMANCE WITH HORIZONTAL OPENINGS

The conceptual ideas presented in this chapter were generated from careful study of the region's micro-climatic conditions, and thoughtful manipulation of both physical and natural resources to attain the level of human comfort desired in this region. The processes attempt a simplification of the complex climate and comfort relationship into a guiding tool towards the selection of opening and roofing system.

Roof is part of the building major membranes that separates the interior space from the climatic variables (sun, rain, wind temperature and humidity) of the outdoor. There are two basic ways in which roof systems could be made to enhance comfortability within the living units.

- As air velocity enhancer--(roof type in relation to horizontal openings) to the wall plane as opposed to floor to ceiling openings
- As solar heat protector--functions of roof material

A. Roof as Air Velocity Enhancer

Insignificant diurnal variations of temperature make the reliance of thermal inertia principle to ameliorate the thermal discomfort in the hot humid region difficult if not impossible. The use of evaporative cooling as in the hot dry region would provide no help, because the high temperature of the region is aggravated by high humidity. Natural ventilation is the only known passive cooling process that can be used to reduce the sheer rigour of the heat discomfort. Getting air into the

Roof Types

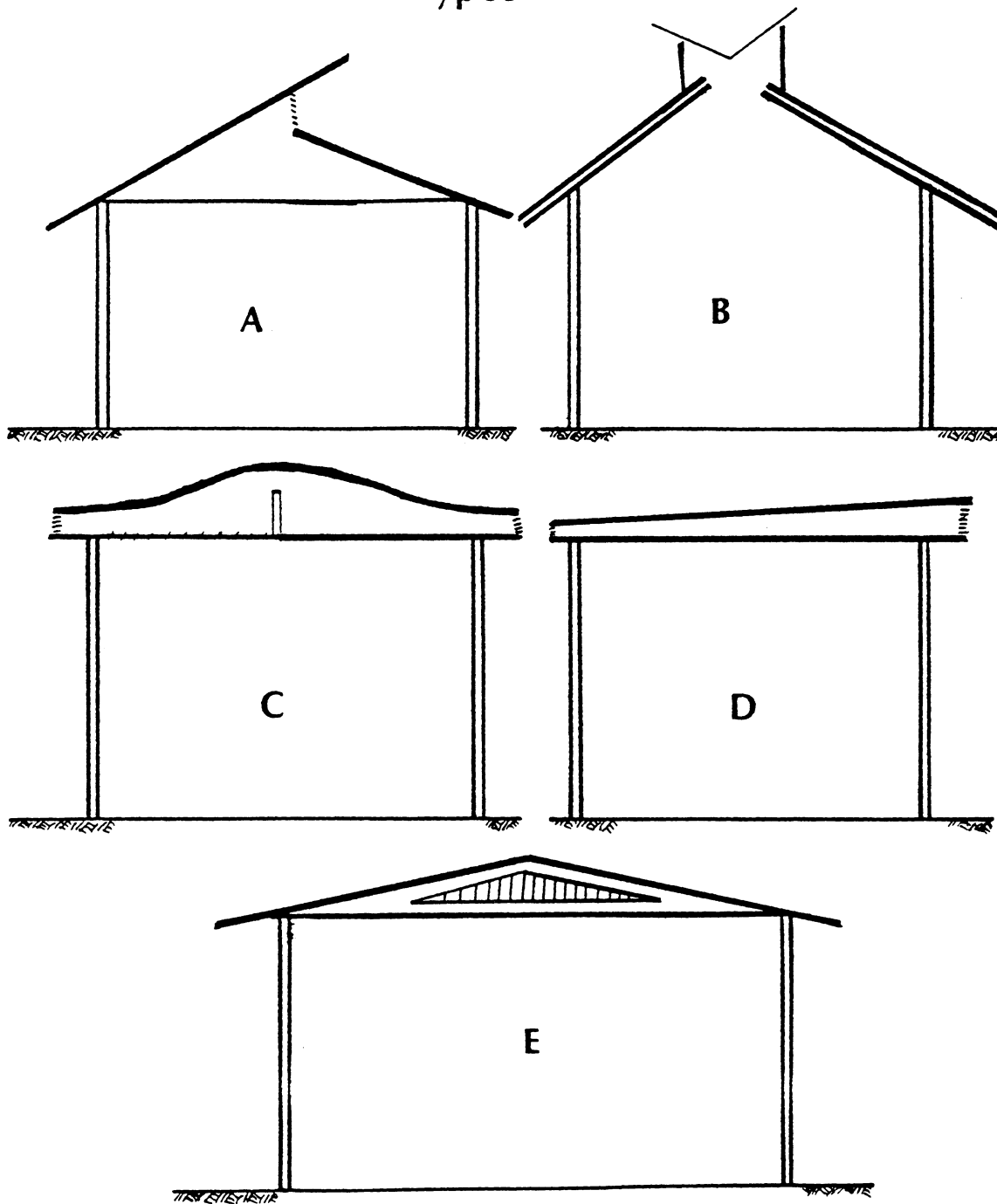

Different Roof Types

interior spaces is not only important, but the velocity of the air that gets into the living space is pragmatic to thermal comfort.

A lot of studies had been done on method of inducing air into the building--through creation of negative pressure. Reed and Caudill have researched on window shape performance in relation to wind direction, and Givoni had also experimented the effectiveness of radiant and evaporative cooling of roof processes, but combining different roof types with different horizontal openings to generate interior air is not common in literature.⁹ The result of the experiment offers the possibility of increasing the air speed within the building through appropriate selection of roof and horizontal opening types. This intuitive manipulation of one building component with another to attain the desired comfort level reinforces the modest premises on which the research thesis is based.

A wind tunnel study was undertaken to investigate the degree and manner in which various roof shapes combined with specific horizontal openings to convert kinetic energy of the natural wind into useful indoor air movement to further enhance comfortability--especially when the outdoor air speed is very low. Particular attention was placed on the relative size of inlet and outlet of openings, cross ventilated in combination with different roof types.

Five different roof shapes (fig. 24) were tested with five different horizontal opening combinations (fig. 25). These various configurations were tested with the aid of one-room building model in a open-throat wind tunnel. A hotwire anemometer was used in measuring both the

TYPES OF OPENING

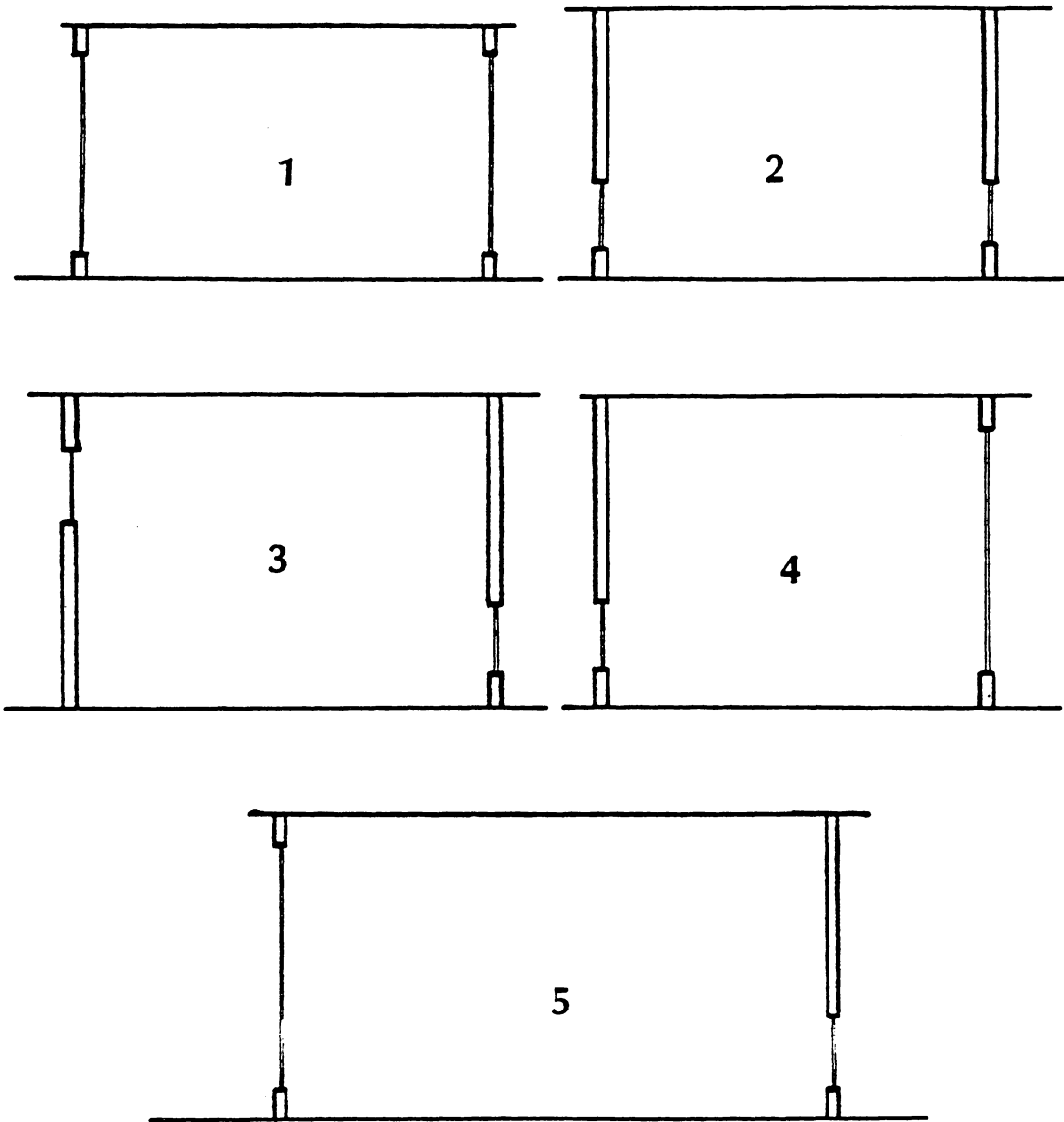

Figure 25

Types of Opening

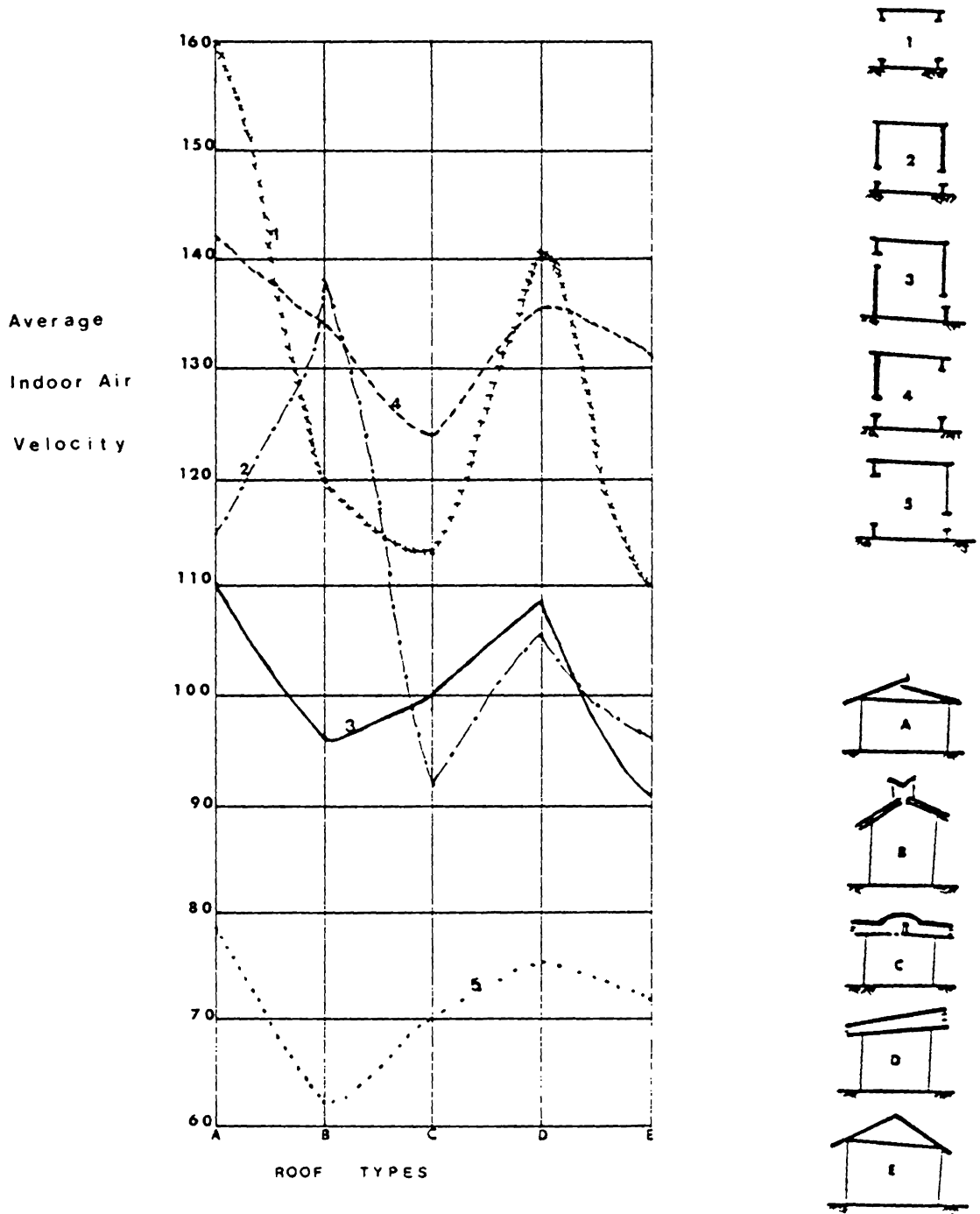

Figure 26

Roof Type Performance In Relation to Horizontal Openings

external wind velocity (relative to the model) and wind velocity at different various specific points within the model. The wind direction was kept constant to the model throughout the whole experimentation. The readings are as tabulated in appendix H.

It is apparent from the analysis and review of the graphs in the appendix H and matrix (fig. 27) that different roof types combine with different horizontal wall openings to enhance indoor airflow velocity differently, even at very low outside air speed. Of the various combinations, it is obvious that the bigger inlet with a smaller outlet (opening 5 of fig. 27) shows a very poor result with every roof type tested; while relatively smaller inlet than the outlet (opening 4 of fig. 27) reflects a distributed velocity range result with every roof type. This further confirms the findings of Givoni on window performance in relation to wind direction.¹⁰ Also roof type A displays good characteristics and best option with most of the horizontal openings when greater indoor air velocity is demanded (see fig. 27).

From the interpretation of the matrix (fig. 27) that emerges from the analysis of the data, the following combinations are suggested for optimum indoor air velocity performance. They are:

roof type A with opening combination 1

roof type B with opening combination 2

roof type C with opening combination 4

roof type D with opening combination 1

roof type E with opening combination 4

	1	2	3	4	5
A					
B					
C					
D					
E					

BEST (165-125)
 GOOD (120-97)
 POOR (78-60)
 BETTER (145-110)
 FAIR (110-90)

(UNITS IN fpm/ft/min)

Figure 27
Roof-Opening Matrix

In a situation when all things are equal and no site limitation nor roof cost restrictions and consideration is strictly based on indoor air velocity enhancement, the best combination is roof type A with opening type 1 as shown in fig. 28.

Ideal situation as above may not be practicable. In any design program there are always some limitations which may be cost, site restrictions or users' different needs. A design solution that satisfies both ends without trade offs can be achieved if the situation is evaluated thoroughly. For example, if privacy demands the use of opening type 2 as in fig. 27 "roof type B" will be the best option. In a situation where view demands big openings on both sides of a building, "roof type A or D" will be the best choice without compensating comfort for visual access. Broadly speaking, depending on the type of opening intended for a particular building be it privacy, solar control or otherwise, there is always a roof type best for the situation. The study displays the velocity enhancement ability of each roof type with different wall openings in aiding cooling due to air movement.

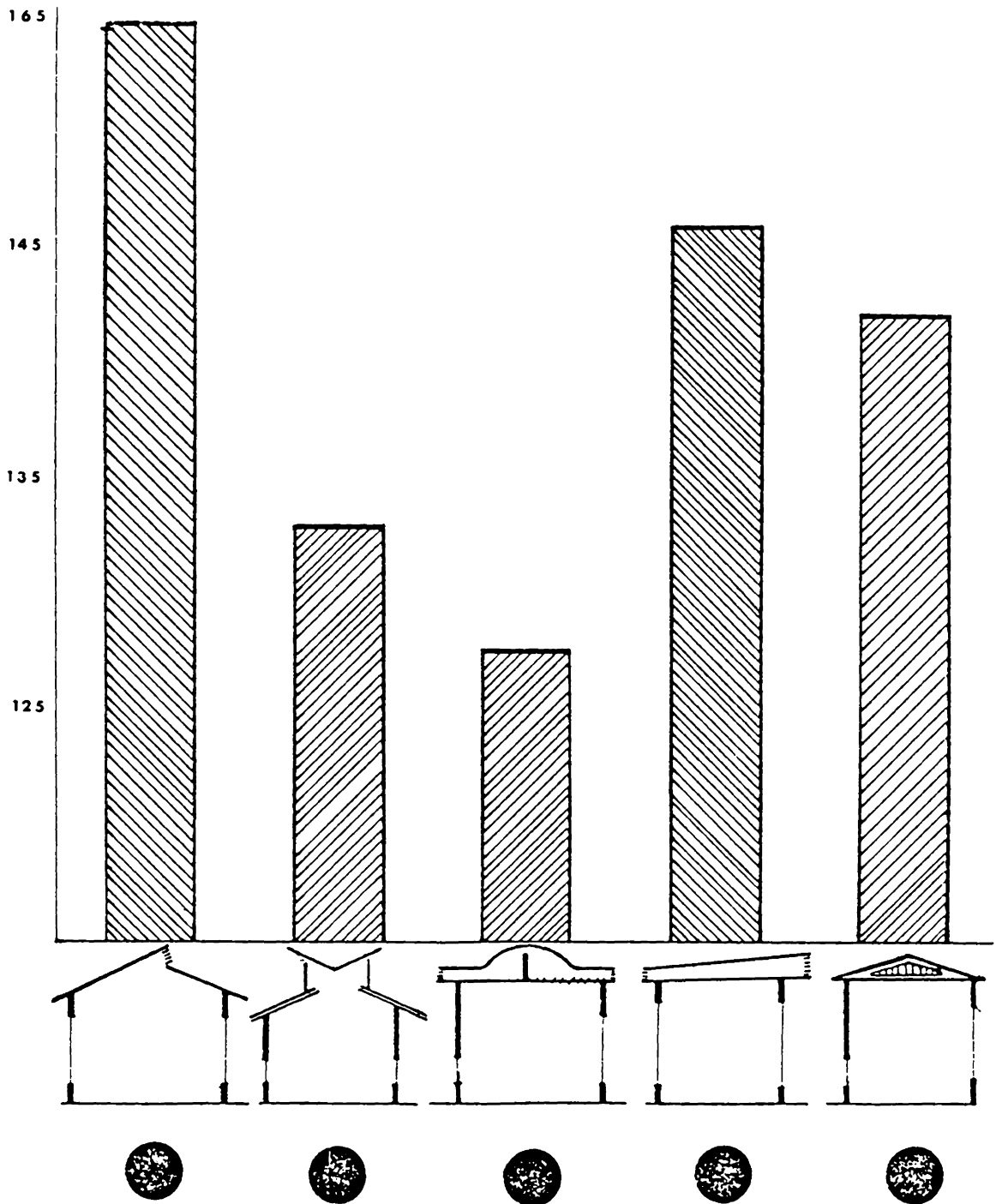

Figure 28

Roof Type Opening Combination Performance Bar Chart

B. Roof As A Solar Heat Protector

Heat is generated during the day; the effectiveness of any roofing system depends on its ability to reduce the penetration of heat into the interior and disperse any accumulation to prevent radiation to the living zone at night. These are functions of roof material, colour and age.

Roof Material

Undoubtedly, the most technically critical part of the building envelope is the roof. In any location of hot humid climate, this receives the greatest amount of solar radiation. Thus capable of transferring the most heat load to the interior of the building. But it is also the surface most exposed to the clear night sky. Therefore, selection of surface roof material is pragmatic on the thermal performance of the roof system. With respect to radiant heat exchange materials absorptivity, reflectivity and emissivity must be known before a final decision is made. For example, a bright metal surface such as aluminum sheet and a white painted surface both will have an absorbance of about 0.2, but the latter will have an emittance value of about eight times as high as the bright metal (0.8 as compared with 0.1) (see fig. 29).

Van Straaten quotes the results of a study in which temperatures of galvanized steel roofs were measured under different external colors; as shown:

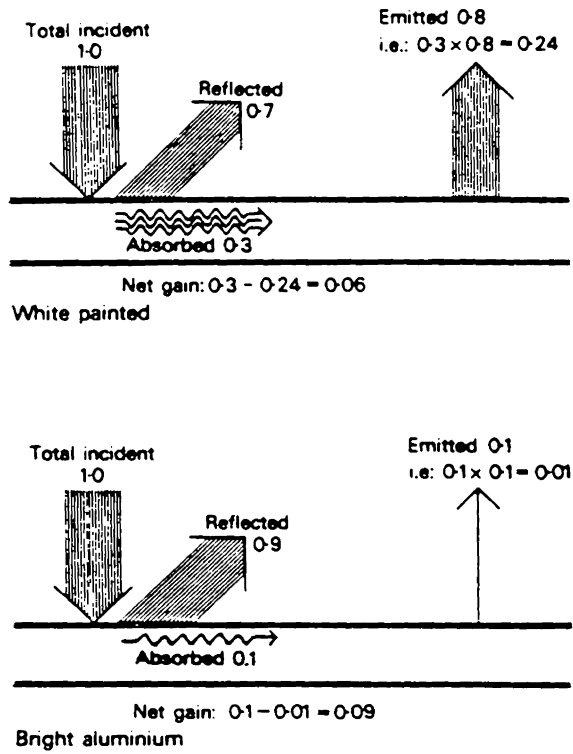

Figure 29

Thermal Performance of Material

Source: Koenigsberger, Ingersoll and Co-Author. Manual of Tropical Architecture and Building

Painted black roof was at 158°F

Painted red roof was at 146°F

Unpainted roof was at 140°F

Aluminum roof was at 123°F

Cream roof was at 119°F

White roof was at 111°F

Definitely, surface characteristics (emissivity, nature, color and reflectivity) play a decisive role in roofing system (roof and ceiling). Nature and color of the external roof surface determine the amount of solar radiation absorbed in the roof structure during the day and the amount of long-wave radioactive heat loss into space at night and consequently the roof temperature and the internal heat exchange with the roof. Corrugated iron sheets retain their shiny surface for a year. Later, it turns dark brown with rust and loses its thermal characteristics. Asbestos-cement sheets that are good reflectors while new are easily covered with algal growth in humid climate. This reduces the effectiveness of these materials considerably, but they can be greatly modified by repeated applications of lime wash or white paint after every rainy season.

Aluminum sheets retain their thermal properties a lot longer than any of the previously discussed ones. Conventional roofing materials are tiles (clay or cement) asbestos-cement, galvanized steel and aluminum sheets. Ceiling materials include plastering, fiber-boards, timber boards, gypsum sheets, etc. See appendix C for the thermal performance of building materials in the hot humid region of Nigeria.

The addition of ceiling to any roof cannot be overemphasized. It creates an air space between the two, which could be a great advantage if properly ventilated. Most of the conventional outer roofing materials are only good for temporary use, without human interventions (lime or white wash) to maintain their original thermal properties. And with time and money for maintenance becoming scarce, there is urgent need, therefore, for search for ideal roofing material for hot humid climate with the following characteristics:

- Double Construction
- High reflectivity of outer surface
- Weathering and dust-proofed
- High resistance to heat flow
- Low emissivity on the inner surface
- Imperviousness to rain
- Life expectancy of about 20 years with little or no maintenance
- Easy to cut and join (for the construction of roofs of various sizes and shapes)
- Easy to transport
- Capable of mass manufacturing from abundantly available "local" raw materials, and
- Above all, relatively cheap

The above seems a long tall order list, but there is already an existing broad base market for this or these materials which may not be homogeneous in nature. It could be a combination of traditional with

new, or natural with synthetic products. One that comes to mind is organic high polymer, a synthetic material known as plastic, which is a by-product of petroleum.

CONCLUSION

Given today's knowledge of air conditioning and sufficient energy, any degree of environmental comfort can be attained and maintained. This approach can no longer be adopted since energy has become expensive and scarce, we have to learn how to live comfortably in a world where artificial energy must be conserved. The themes of conservation and climatic control in hot humid region were explored in the thesis.

High humidity and temperature are identified as the major sources of discomfort in hot humid regions. The use of building envelope, unit arrangements, shading as a means of reducing the effect of heat are discussed. Reducing humidity from the region is still a major task. The most inexpensive means of ameliorating its effect is conventional cooling through natural ventilation. Various ways of enhancing indoor air movements are examined. The result shows an enhancement in indoor air velocity through the proper choice of roof-window type combination. Other means of creating negative pressure to enhance the speed of indoor air are also studied.

From the foregone analyses and the result of the roof and window type experimentation it is clear that a knowledgeable manipulation of our natural environments' assets and liabilities, can produce an extremely thermal efficient building design at little or no extra cost.

Public awareness of the architectural findings is as important as the basis of the research itself. People should be made to realize the capability of their natural environment and should be encouraged in

their uses. Governments in the developing countries should encourage more research works in the field of environmental designs through funding and application of research findings to their various housing projects. Example, they say, is better than precept. Organized seminars and architectural publications are ways of improving the practicing architects' knowledge. This should be encouraged.

The climate of Lagos, Nigeria has been used as an example in this thesis, but the design guidelines that emerge from the study are not blueprints for Nigerian situation alone. The guidelines could be used for all other hot humid regions of the world. Of course, varied cultural background and construction cost limitation may generate conflicts between program requirements and some basic design considerations. However, intelligent compromise can only be made after all tradeoffs have been properly evaluated.

BIBLIOGRAPHY

- Evans, Benjamin H., Nature of Airflow Around Buildings, College Station: Texas A&M press, 1957.
- Fry, Maxwell and Drew, Jane, Tropical Architecture in the Humid Zone, New York: Reinhold, 1956.
- Koenisberger, Otto; Ingersoll, T. G.; Mayhew, A.; and Szokolay, S. V., Manual of Tropical Housing and Building Part One: Climate Design, London, Longman, 1973.
- Kukreja, C. P., Tropical Architecture, New York: McGraw-Hill, 1978.
- U. N. Department of Economic and Social Affairs, Design of Low Cost Housing and Community Facilities Volume One: Climate and Housing Design, New York, 1969.
- Iloeje, H. P., A New Geography of Nigeria, New revised edition, Longman Nigeria Limited.
- U. S. Department of Housing & Urban Development in Cooperation with the U.S. Department of Energy, Installation Guidelines for Solar DHW Systems in Family Dwellings.
- Davis, A. J. and Schubert, R. P., Alternative Natural Energy Sources in Building Design, Van Nostrand Reinhold Company, 1981.
- Givoni, B., Man, Climate and Architecture, Van Nostrand Reinhold Company, N.Y. 1976.
- Olgyay, A. and Olgyay, V., Solar Control and Shading Devices, Princeton University Press, New Jersey, 1957.
- Olgyay, Victor, Design with Climate, Princeton University Press, N.J., 1973.
- Kultarman, Udo, New Directions in African Architecture, George Braziller Inc. N.Y., 1969.
- United Nations, Climate and House Design, New York, 1971, Vol. 1.
- Caudill, William, A publication of the Texas Engineering Experimental Station Texas A&M, 1950.

APPENDIX A
NIGERIA CLIMATIC ANALYSES

The three climatic variables that play major roles in the architectural forms in the country are temperature, humidity and wind. Their intensities are influenced by rainfall, latitudinal and altitudinal location of different parts of the country.

A. Temperature Distribution

Nigeria is situated along the West Africa Coast (see Map 2). It lies between latitude 4° and 14° North of the equator and longitude 3° and 14° East. It is within the tropics. The temperature is therefore high throughout the year (see Map 3). The hottest months in the north are April and May, while that of the south are February and March. Cloud covers tend to keep the temperature down. The coolest period of the year is therefore in the middle of the rainy season (August). In the northern part of the country, December and January are other months of low mean temperature. The night temperature can be as low as 1°C (33°F). The cold harmattan winds from the Sahara desert prevail during this time of the year (see Map 6).

B. Humidity and Rainfall Distribution

Relative humidity measures the amount of water in the air. The amount of water in the atmospheric air depends largely on nearness to a large body of water and the intensity of rainfall of the area. Rainfall is heavier and more reliable in the south. The annual rainfall decreases as one moves further from the coast inland. This is evident

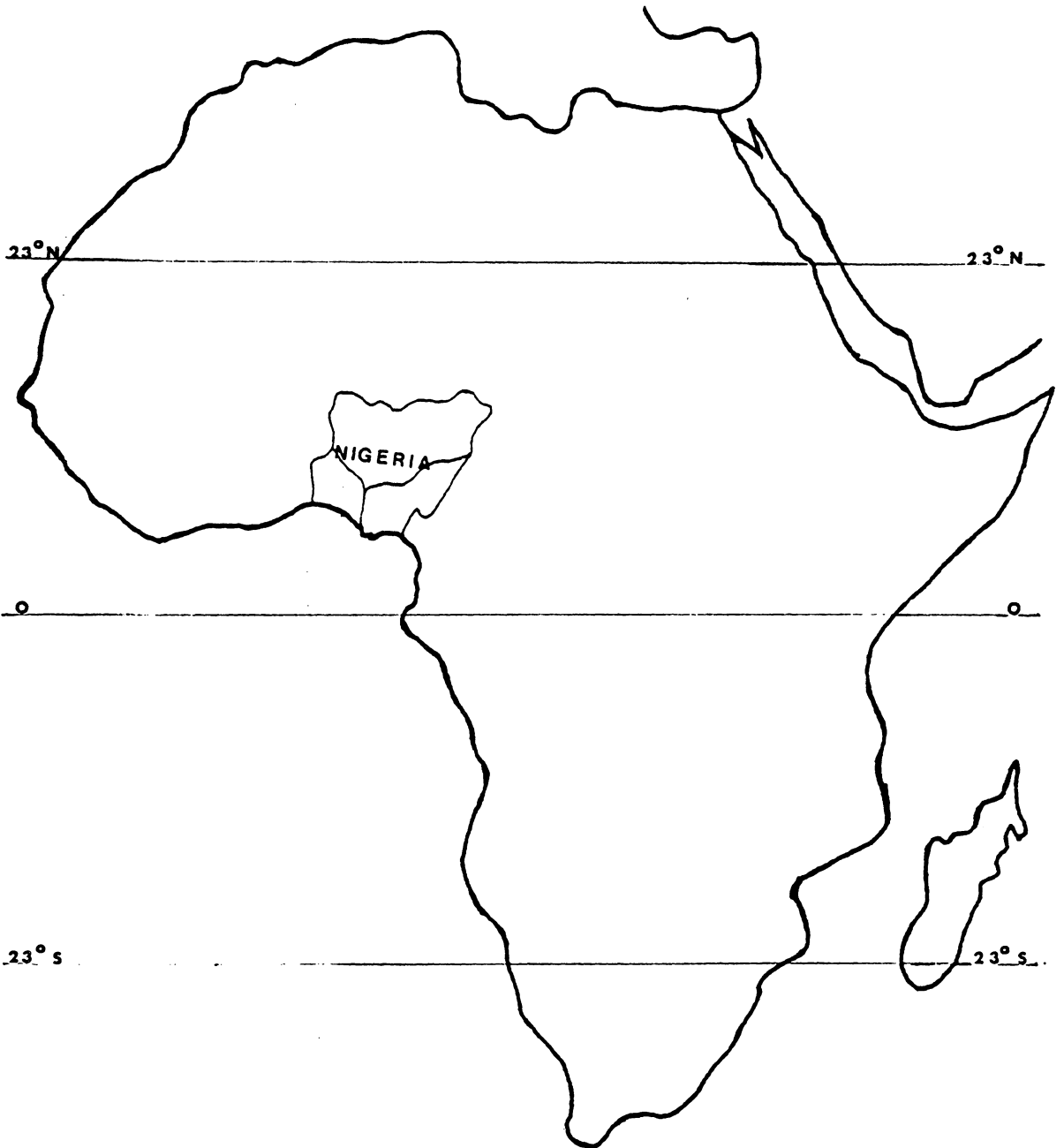

Map 2. Nigeria is located on the western coast of the continent of Africa.

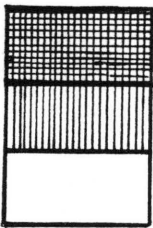
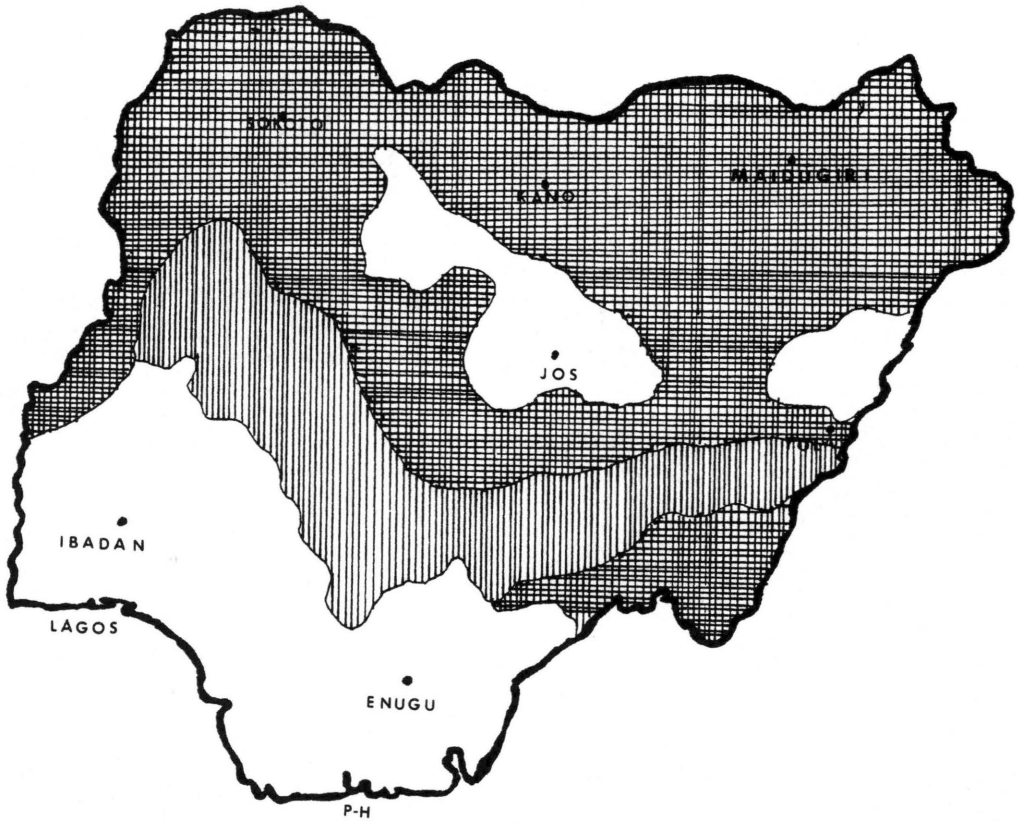

Hottest area over 27°C (80°F)

Moderately hot area 24°C - 27°C (75-80°F)

Cool area less than 24°C (75°F)

Map 3: Temperature

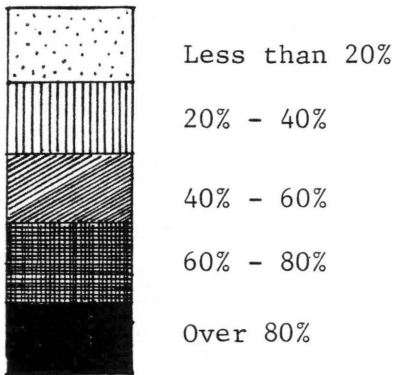
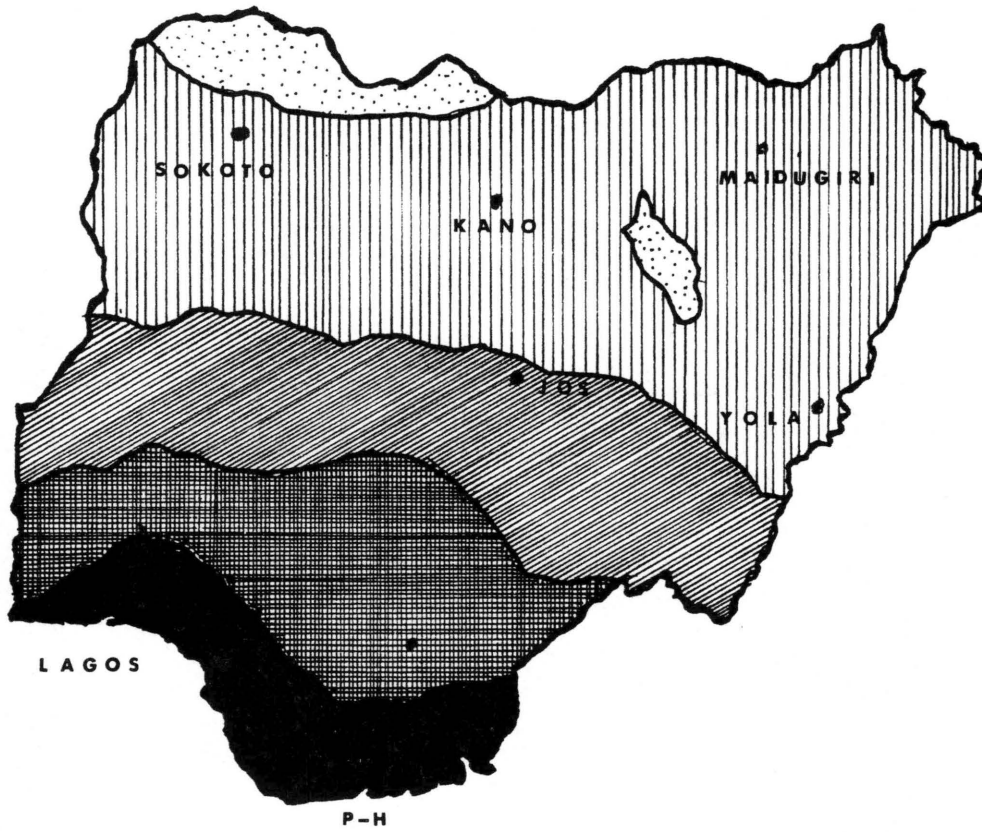

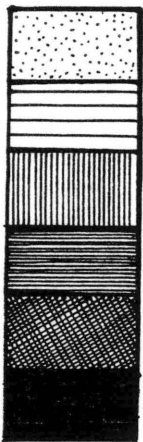
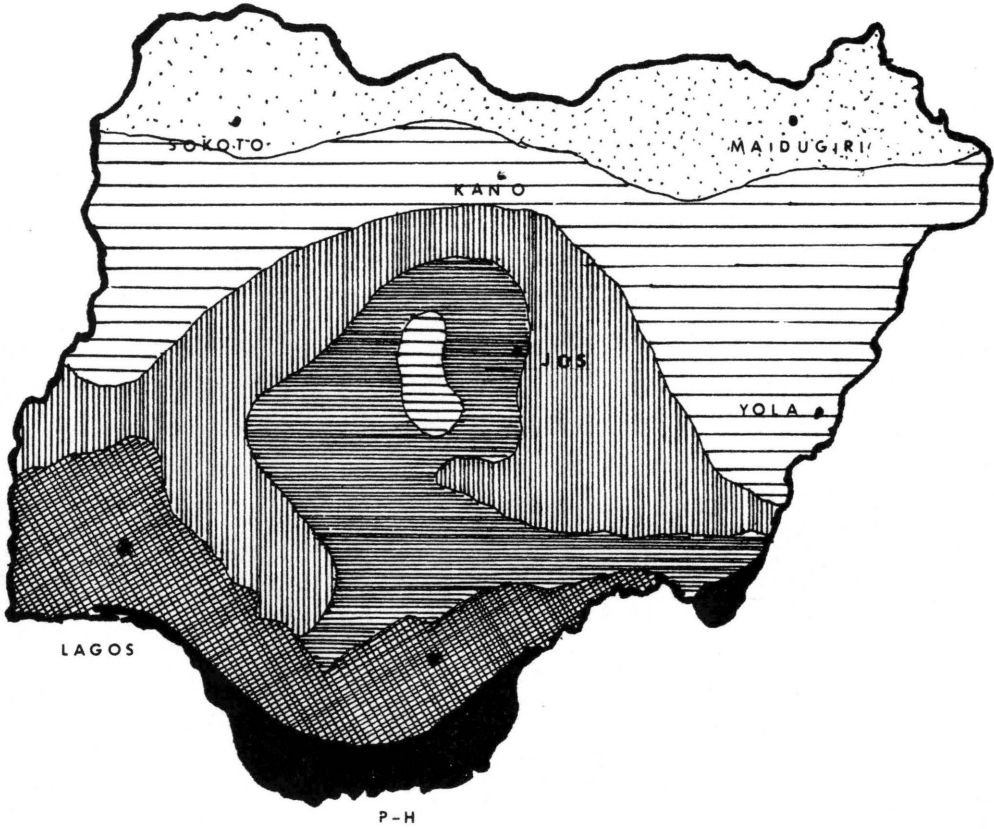

Map 4: Relative Humidity

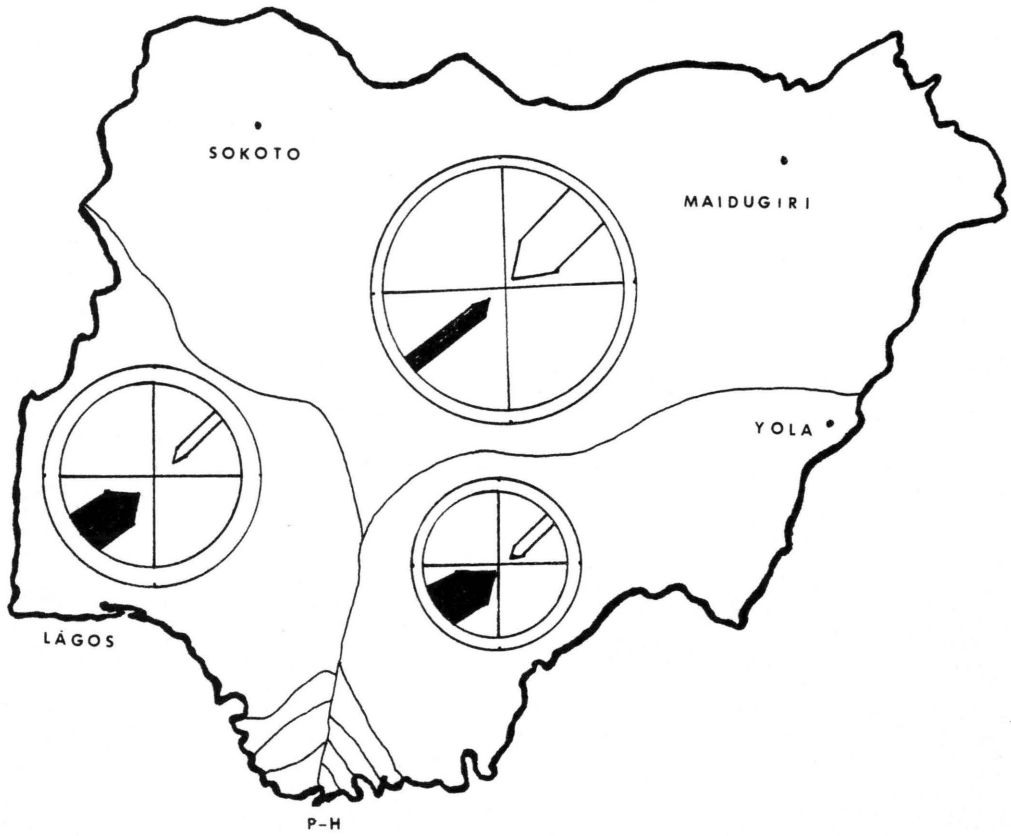

- 500-1000 mm annually, i.e. (20-40 inches)
- 1000-1500 mm annually
- 1500-2000 mm annually
- 2000-2500 mm annually
- 2500-3000 mm annually
- over 3000 mm annually (120 inches)

Map 5: Rainfall



 Southwest Trade Wind, Rainy Season (March-Sept.)

 Northeast Trade Wind, Dry Season (Oct. - Feb.)

Map 6: Wind

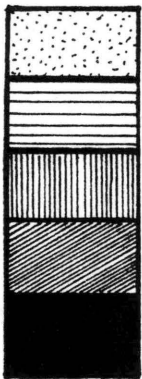
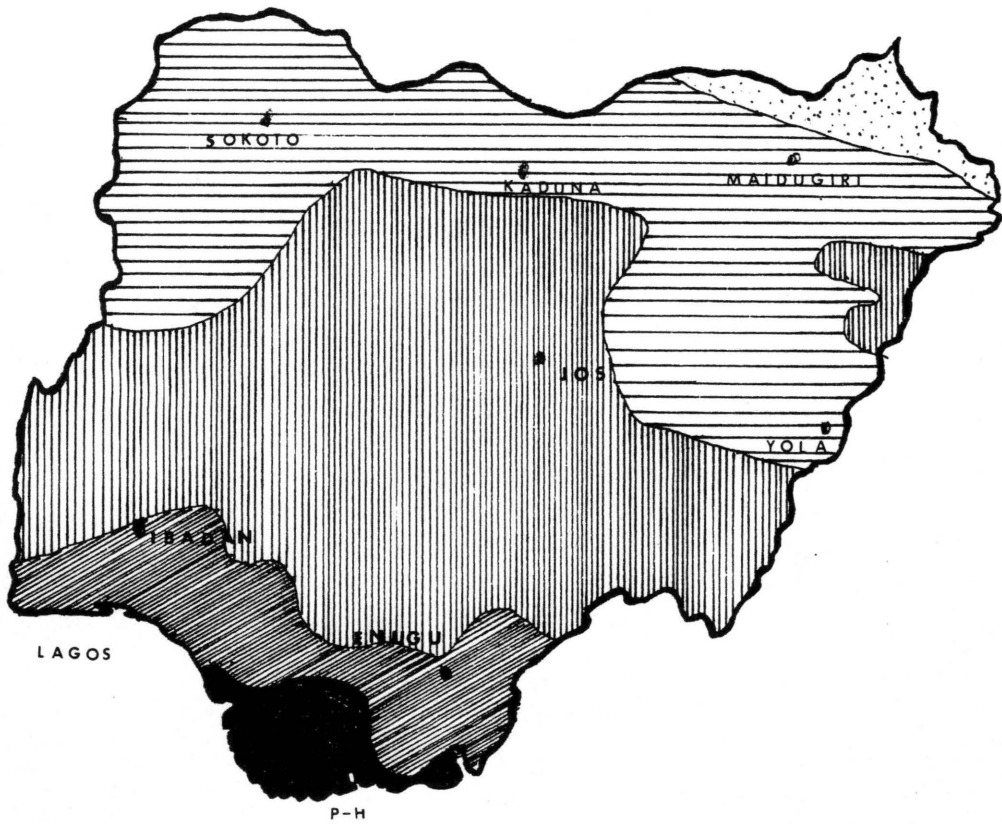

- Short grass and thorn bushes
sahel savanna or scrubland
- Low Savanna with short grass
and short flat topped trees
- High savanna with trees of
moderate height
- Rain forest with tall trees and
palm trees
- Mangrove and fresh water swamp
forest

Map 7: Vegetation

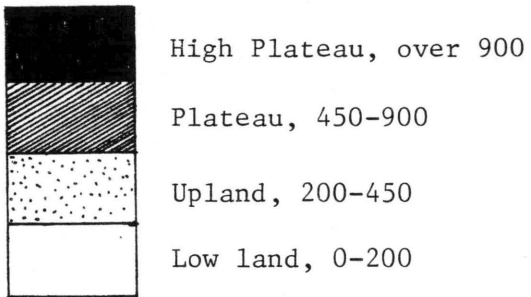
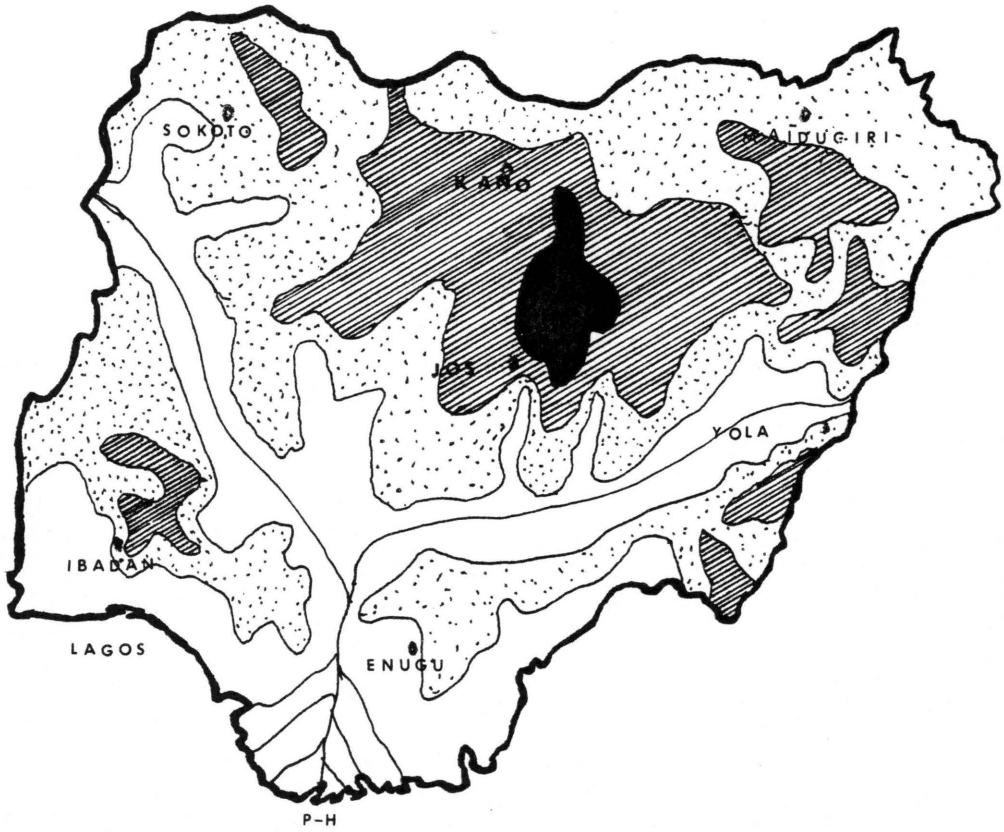

Map 8: Physical Factors

from its rainfall and relative humidity distribution patterns (Maps 4 and 5). Both the physical and vegetative characteristics of the country are shown in Maps 7 and 8.

APPENDIX B
THERMAL PERFORMANCE OF SELECTED WALLS
AND FLOOR CONSTRUCTION

Table 3. Thermal Performance of Selected Walls and Floor Construction

Material	Conductivity k W/M deg. C	Resistivity 1/k M deg. C/W
Concrete: ordinary, dense	1.440	0.69
Adobe	0.3	
Brickwork commongs: light	0.806	1.24
average	1.210	0.83
dense	1.470	0.68
Timber: softwood	0.138	7.25
hardwood	0.160	6.25
plywood	0.138	7.25
Metals: steel	58.0	0.0172
aluminum	220	0.0045
copper	350	0.0029
silver	407	0.0024
Air	0.026	38.45
Water	0.580	1.72

Material	Transmittance (U-value) in W/m ² deg C
Brick: solid, unplastered 114 mm	3.64
plastered both sides 114 mm	3.24
solid, unplastered, 228 mm	2.67
plastered both sides 228 mm	2.44
Concrete, ordinary dense 152 mm	3.58
203 mm	3.18
Concrete block with cavity 250 mm (aerates)	1.19
Hollow concrete block 228 mm (aerates)	1.70
Corrugated asbestor cement sheet	6.53
Corrugated iron sheets	8.52
Aluminum deck (13 mm) with 2 layers bituminous felt	2.16
Reinforced concrete slab of 100 mm, screen 63-12 m and 3 layers of bituminous	1.08
Glass--single glazing	5.00

Table 4. Time Lag of Heat Flow Through Walls and Roof

Walls:	Time Lag (hours)
Bricks: 4-inch	2.3
8-inch	5.5
12-inch	8.0
Concrete solid	
or block: 2-inch	1.0
4-inch	2.6
6-inch	3.8
8-inch	5.1
10-inch	6.4
12-inch	7.6
Glass window	0.0
Glass block	2.0
Roof: light construction	0.7 to 1.3
medium construction	1.4 to 2.4
heavy construction	2.5 to 5.0

Source: Koenigsberger, Ingersoll and Co. Manual of Tropical Housing and Building (Climatic Design Part 1).

APPENDIX C
THE PERFORMANCE OF MAJOR BUILDING MATERIALS
IN THE HOT HUMID CLIMATE

Table 5. The Performance of Major Building Materials
in the Hot Humid Climate

Materials	Defects	Virtues
ferrous metals and zinc	Corrode rapidly, unless prominently exposed and free of ground	None
Aluminum and its alloys	High cost of sheets sufficiently strong	Will stand humidity high reflectivity, little affected by ageing. Is light and transportable, does not easily leak
Copper and its alloys and lead	Copper leaks due to thermal expansion and contraction	Performance of Copper, brass and bronze in humid climate is generally excellent
Concrete and other cement products	Cement products are particularly susceptible to intense blackening of exposed surfaces	Ease of transportability to most sites. Extreme adaptability to most conditions.
Asbestos Cement Sheeting	High breakage rate	Economic and easy to handle
Stone	High temperatures may produce stresses and cracking in masonry	Stones of even low quality can be used with satisfactory results. Local low skill labor can be used easily
Building boards	Untreated hardboard and plywood liable to termite attack	Hardboard and resin-bonded plywood used with satisfactory results (clear of termites). Painting is also considered as desirable.

Materials	Defects	Virtues
Earth and stabilized earth	Earth walls are highly susceptible to termites unless stabilised. Stabilised earth blocks have lower strength than concrete blocks. Depending on type of earth used may restrict building height.	Certain types of earth and quite durable. Greatly improved by rendering and soil-stabilisation. Has the advantage of being largely a site material and so cuts down on transport costs. It can be made with fairly unskilled labor.
Timber	Depradations of fungus and insects. Also deterioration due to rotting is also apparent.	Abundance of supply. Servicability.
Thatch	Deterioration becomes inevitable after 18 months to 2 years. Fire risk.	Simply and speedily erected and repaired.
Plastic materials	Most plastics are susceptible to termite attack, so must be kept free of ground.	One positive way is of thermo-plastic tubing for plumbing in hot humid
Burned clay products	Not always satisfactory where there is no technical know how.	No abnormal deterioration.

Source: Tropical Architecture in the Dry and Humid Zones (2nd edition) by Maxwell Fry & Jane Drew

APPENDIX D
THE MAHONEY TABLES

(Source - Carl Mahoney: Climate and House design, United Nations Publications).

This is a simple set of tables for recording and analyzing climatic informations. The designer who follows it is led step by step from the climatic informations to the type of specification for the layout, orientation, shape and structure of his building which he needs at the sketch design stage.

The Process of Completing Mahoney Tables
[Source: Climate and House Design by UN]

Step #1--Table 6A

- a. Record the mean maxima and minima of temperature.
- b. Enter to the right of the air temperature highest monthly mean maxima and lowest of the monthly mean minima.
- c. Find the "annual mean temperature" (AMT) by adding the highest of the monthly mean maxima to the lowest of the monthly mean minima, and dividing by two. Enter the result in the box marked AMT at the right of Table 6A.
- d. Find the "monthly mean range" (MMR) of temperatures by deducting the monthly mean minima from the maxima and enter the results for each month in the bottom line of Table 6A.
- e. Find the "annual mean range" (AMR) of temperatures by deducting the lowest of the monthly mean minima from the highest of the monthly mean maxima and entering the result in box market AMR.

Step #2--Table 6B

- a. Record the monthly mean maxima and minima of relative humidity (RH) for each month (early morning and early afternoon readings).
- b. Record below these maxima and minima the average relative humidity for each month.
- c. Note below this the "humidity group" (HG) for each month, using the following code"

Average RH	Humidity Group
Below 30 percent	1
30 to 50 percent	2
50 to 70 percent	3
Above 70 percent	4

d. Record the monthly rainfall figures and sum up to find the annual rainfall.

e. Record the direction of prevailing wind and that of the secondary wind.

Step #3--Table 6C

a. Repeat for each month the humidity group from the previous table.

b. Note the amount from Table 6A.

c. Enter into this table, the day and night comfort limits taken from Table 2 (Comfort Limits) using the appropriate humidity group and relevant AMT range; i.e., over 20° C, between 15 and 20° C, or under 15° C.

d. Compare the monthly mean maxima with the day comfort limits and compare the monthly mean minima with the night comfort limits and enter the following symbols into the last two lines of Table 6C under the rating of thermal stress (day and night).

Above comfort limits	H (hot)
Within comfort limits	- (comfort)
Below comfort limits	C (cold)

Step #4--Table 6D (Indicators)

One indicator by itself does not automatically lead to a solution. Recommendations can be framed only after adding the indicators for a whole year and completing Table 6D.

Humid Indicators:

H1 indicates that air movement is essential. It applies when high temperature (Day thermal stress = H) is combined with high humidity (HG=4) or when the high temperature (day thermal stress = H) is combined with moderate humidity (HG+2) or 3) and a small diurnal range (DR less than 10° C).

H2 indicates the air movement is desirable. It applies when temperatures within the comfort limits (day thermal stress = -) are combined with high humidity (HG=4).

H3 indicates that precautions against rain penetration are needed. Problems may arise even when low precipitation figures, but will be inevitable when rainfall exceeds 200 mm per month.

Arid Indicators

A1 indicates the need for thermal storage. It applies when a large diurnal range (10° C or more) coincides with moderate or low humidity (HG = 1, 2, or 3).

A2 indicates the desirability of outdoor sleeping space. It is needed when the night temperature is high (night thermal stress = H) and the humidity is low (HG = 1 or 2). It may be needed also when nights are comfortable outdoors but hot indoors as a result of heavy thermal storage (i.e. day = H, night = 1, humidity group = 1 or 2 and when the diurnal range is above 10° C).

A3 indicates winter or cool-season problems. These occur when the day temperature falls below the comfort limits (day thermal stress = C).

Tick in Table the months when these indicators apply and add the total number of months for each indicator.

Step #5--Table 7

- a. Transfer the indicator totals from Table 6D to Table 7.
- b. Deal with the eight subjects one by one; i.e., layout, spacing, air movement, etc.
- c. Examine the indicator columns for each subject to find the appropriate recommendation.
- d. There can be only one recommendation per subject.
- e. A further alternative exists in a few cases, namely recommendations 1 or 2, 6 or 7, and 7 or 8. In these cases, the choice is made by proceeding with the scanning of the indicator columns to the right and deciding according to the range of months given in the table.

Table 7. Sketch Design Recommendations

Indicator totals from table 4						Recommendations
Humid			Arid			
H1	H2	H3	A1	A2	A3	
12	12	8	0	0	0	
						Layout
			0-10			✓ 1. Buildings orientated on east-west axis to reduce exposure to sun
			11 or 12		5-12	2. Compact courtyard planning
					0-4	
						Spacing
11 or 12						✓ 3. Open spacing for breeze penetration
2-10						4. As 3, but protect from cold/hot wind
0 or 1						5. Compact planning
						Air movement
3-12						✓ 6. Rooms single banked. Permanent provision for air movement
1 or 2			0-5			7. Double-banked rooms with temporary provision for air movement
			6-12			
0	2-12					8. No air movement requirement
	0 or 1					
						Openings
			0 or 1		0	✓ 9. Large openings, 40-80% of N and S walls
			11 or 12		0 or 1	10. Very small openings, 10-20%
			Any other conditions			11. Medium openings, 20-40%
						Walls
			0-2			✓ 12. Light walls; short time lag
			3-12			13. Heavy external and internal walls
						Roofs
			0-5			✓ 14. Light insulated roofs
			6-12			15. Heavy roofs, over 8 hours' time lag
						Outdoor sleeping
				2-12		16. Space for outdoor sleeping required
						Rain protection
		3-12				✓ 17. Protection from heavy rain needed

Table 8. Element Design Recommendations

Indicator totals from table 4						Recommendations
Humid			Arid			
H1	H2	H3	A1	A2	A3	
						Size of openings
			0 or 1		0	✓ 1. Large, 40-80% of N and S walls
			2-5		1-12	2. Medium, 25-40% of wall area
			6-10			3. Composite, 20-35% of wall area
			11 or 12		0-3	4. Small, 15-25% of wall area
					4-12	5. Medium, 25-40% of wall area
						Position of openings
3-12						✓ 6. Openings in N and S walls at body height on the windward side
1-2			0-5			7. As above, but including openings in internal walls
0	2-12		6-12			
						Protection for openings
					0-2	8. Exclude direct sunlight
		2-12				✓ 9. Provide protection from rain
						Walls and floors
			0-2			✓ 10. Light, low heat capacity
			3-12			11. Heavy, over 8 hours' time lag
						Roofs
10-12			0-2			✓ 12. Light, reflective surface and cavity
			3-12			13. Light and well insulated
0-9			0-5			14. Heavy, over 8 hours' time lag
			6-12			
						External surface treatments
				1-12		15. Space for outdoor sleeping
		1-12				✓ 16. Adequate drainage for rainwater

APPENDIX E
PLANTING IN THE HUMID TROPICS

To aid in the selection of vegetation for the landscape design, a list of trees, shrubs and plants suitable for planting in this climate is presented. The shapes of known trees is presented in table 4.

Table 9. Trees and Shrubs Suitable for Planting in Hot Humid Climate

Some large trees suitable for avenues*

(Heights given where known)

- Swietenia macrophylla* (British Honduras Mahogany), 70–80 ft.
Cedrella Mexicana (W.I. Cedar), 80–120 ft.
Palmas spp.
Peltophorum ferrugineum, 50–60 ft.
Terminalia Catappa, 60–80 ft. (Almond).
 Very good for shade
Poinciana regia (*Deionix regia*), 40–50 ft. (Flame Tree)
Chrysophyllum cainito (Star Apple), 60 ft.
Hymenea courbaril (Stinking Toe), 100 ft.
Parkia biglandulosa (Locust)
Grevillea robusta (Silky Oak), 60–100 ft.
Catalpa longissima (Yoke Wood)
Homalium dolichophyllum
Hymenostegia Afzelii
Khaya Senegalensis
Tamarindus indicus
Fagraea fragrans (Tembusu)

Some trees suitable for smaller avenues

(Heights given where known)

- Cassia siamea*
Casuarina equisetifolia (Whistling Pine)
Guaicum officinale (Lignum Vitae), 30 ft. plus
Cordia sebestana, 20–25 ft.
Tabebuia pentaphylla (Pink Poui)
Cupressus benthamii (Fir Tree)
Casalpinia Pulcherrima (Pride of Barbados)
Nim
Acacia spp.
Palma spp.
Eucalyptus
Murraya exotica
Monddora tenuifolia
Securidaca spp.
Barteria nigritiana
Dalbergia sisoo

* Also suitable for single planting and landscaping.

- Glicidia maculata*
Sclerocarya birrea
Spondias magnifera
Azidarachta indica

Trees suitable for clumps, groves and single planting

- Ficus benjamina* (Ceylon Willow). Large and spreading, 60 ft. plus. Very good for shade
Ficus bengalensis (Fig). Large and spreading. 100 ft plus
Enterolobium cyclocarpum (Devil's Ear), 80 ft. Spreading (100 ft. plus)
Blighia sapida (Akee), 50 ft.
Pithecellobium saman (*Samanea Saman*). Saman Rain Tree, 100 ft. plus
Triplaris surimanensis (Long John), 60 ft. Tall, not spreading more than 20 ft. Quick growing
Triplaris cumingiana (Long John), 60 ft. Tall, not spreading more than 20 ft. Quick growing
Lagerstræmia flos-reginæ (Queen's Flower), 60 ft.
Spathodea campanulata (Tulip Tree), 50–60 ft.
Araucaria spp.
Hura crepitans (Sandbox), 60 ft.
Brownea coccinea
Cassia nodosa
Cassia fistula
Bauhinia galpini (semi-climber)
Parmentiera cereifera (Candle Tree)
Plumeria acutifolia (Frangipani)
Posoqueria longiflora
Erythrina umbrosa
Michelia champaca
Kigelia pinata (Sausage Tree)
Tecoma spectabilis (Poui)
Genipa americana, 40–50 ft.
Gliricidia sepium (Quick Stick Madura)
Datura suaveolens (Angels' Trumpets)

Cordia

Casuarina equestifolia
Milletia spp.
Punica granatum
Ochna spp.
Ourates spp.
Distrosachys glomerata
Baphia nitida
Erythrina altissima
Erythrina senegalensis
Chrysophyllum spp.
Holharrhena Wulfsburgii
Rauwolfia vomitoria
Stereospermum spp.
Eucalyptus spp.
Parkia spp.
Anogeissus leiocarpus
Lonchocarpus Griffonianus
Moringa pterygosperma
Oncoba spinosa
Combretum abbreviatum
Nerium oleander
Allamanda spp.

Hedges

Hibiscus sp.
Euphorbia milii (splendens)
Euphorbia pulcherrima (Poinsettia)
Breynia nívosa
Galphimia glauca (Shower of Gold)
Barleria cristata (Blue Bell)
Allamanda schottii (Alamander)
Pithecolobum dulce (Madras Thorn)
Pithecolobum unguiscarti (Bread and Cheese)
Eugenia spp. (*Pitanga Cherry*)
Bougainvillea spp.
Panax fruticosum
Thevetia nerifolia
Bauhinia refescens
Casuarina equestifolia (Whistling Pine)
Thespesia populula
Lawsonia alba (Henna)
Acalypha tricolor

Nim

Flacourtia flavescens
Eugenia sp.
Coffea sp.
Fiuggea virosa
Baphia nitida
Sesbania aegyptica
Connarus africanus
Aralia filicosolia
Bambusa nana
Croton
Malpighia glabra (Barbados Cherry)
Carissa edulis
Acalypha vars.
Durania plumeri
Punica granatum
Murraya exotica
Lagerstramia indica
Balanities aegyptica
Zisypus spp.
Commiphra africana
Quisqualis indica
Aralia guilfoylei
Barleria cristata
Justicia gendarussa
Panax fruticosum

Quick growing climbers for shade, i.e. covering verandahs, etc.





Argyreia speciosa
Allamanda hendersonii
Bignonia venusta
Bougainvillea sp.
Clerodendron speciosum
Clerodendron thomsona
Lonicera japonica
Pandorea ricasoliana
Petrea volubilis
Quisqualis indica
Thunbergia grandiflora

Clinging plant for rough walls

Ficus stipulata

Table 10

Classification of Trees According to Shape

SHAPE OF TREE	Colour of flowers							
	GREEN	WHITE	RED	YELLOW	BLUE	ORANGE	MAUVE	PINK
	<i>Acacia moniliformis</i>	<i>Melia indica</i> (Neem). <i>Pterospermum</i> . <i>Acerifolium</i> (flowers: cream). <i>Crataeva Religiosa</i> .	<i>Spathodea canpanulata</i> . <i>Erythrina indica</i> . <i>Erythrina suberosa</i> .	<i>Cassia Fistula</i> . <i>Peltophorum Inermis</i> . <i>Schleichera trijuga</i> .	<i>Jacaranda mimosaefolia</i> .	<i>Butea monosperma</i> (Dhak, or Flame of the Forest).	<i>Melia azadirachta</i> (Persian lilac). <i>Milletia ovalifolia</i> (flowers: lilac). <i>Lagerstroemia Flos-regina</i> (flowers: mauve-purple). <i>Lagerstroemia Throlli</i> . <i>Kagelia pinnata</i> .	
	<i>Diospyros embryopteris</i> . <i>Ficus Infectoria</i> (Pakur). <i>Tamarindus Indica</i> . <i>Ficus retusa</i> .	<i>Plumeria acutifolia</i> . <i>Plumeria alba</i> . <i>Pongamia glabra</i> .	<i>Delonix regia</i> (Gul Mohur).	<i>Thespesia populnea</i> .				<i>Cassia Java-nica</i> . <i>Cassia nodosa</i> . <i>Enterolobium saman</i> (Rain tree).
	<i>Casuarina equisetifolia</i> . <i>Acacia auriculiformis</i> (Australian acacia). <i>Phyllanthus Emblica</i> .	<i>Bauhinia acuminata</i> . <i>Dillenia indica</i> . <i>Chorisia speciosa</i> .	<i>Bombax malabaricum</i> (Silk cotton).	<i>Cassia siamea</i> . <i>Grevillea robusta</i> .	<i>Guaiacum officinale</i> (Lignum vitae).	<i>Colvillea racemosa</i> .		<i>Bauhinia Variegata</i> . <i>Cassia renigera</i> . <i>B. Triandra</i> .
	<i>Eugenia jambulana</i> . <i>Eugenia fruticosa</i> . <i>Calophyllum Inophyllum</i> .	<i>Bigonia crista</i> . <i>Ailanthus excelsa</i> . <i>Cedrella toona</i> . <i>Bassia latifolia</i> (Mahua).						
	Palms: <i>Coryphya taliera</i> . <i>Livistonia chinensis</i> . <i>Oreodossia regia</i> (bottle palm).							

SOURCE: Tropical Architecture in the Humid Zone.

APPENDIX F
THE OVER-HEATED PERIODS OF THE YEAR

To avoid over designing a shading device it is necessary to determine those times of the day when protection is needed from the sun. The comfort zone in the hot humid climate is estimated to lie between 22° C and 27° C (see Figure 1B). For temperatures above the lower limit of the comfort zone it is recommended that protection should be provided against direct solar radiation. The period when shading is needed is shown in the shaded portion of the isopleth diagram for Ikeja an area near Ojaa village (see Figure 30). The isopleth diagram shows an hourly temperature variation for the whole year. To determine the solar azimuth and altitude, the over heated times indicated in the isopleth diagram are shaded in the solar chart diagram illustrated in Figure 22.

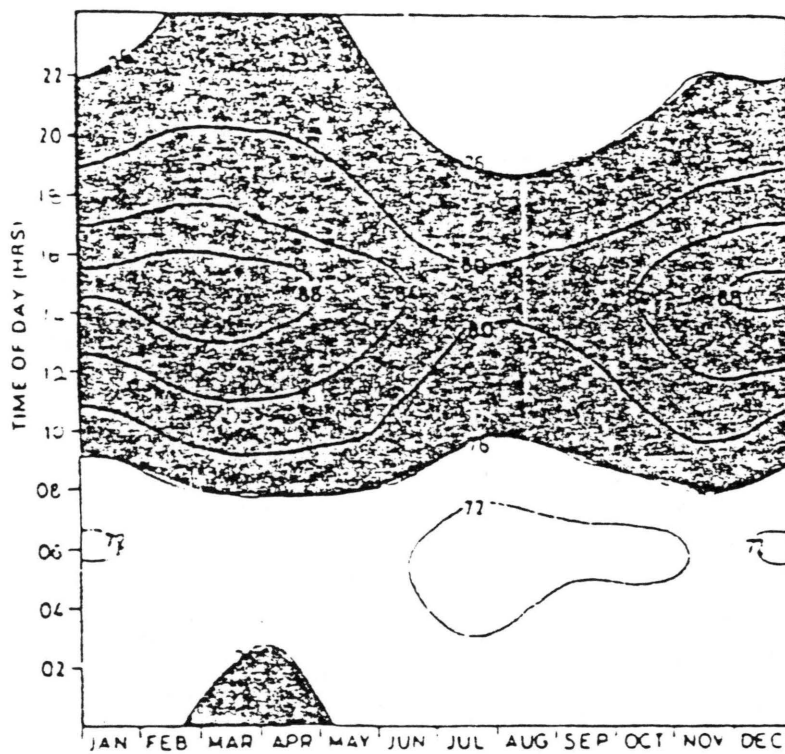

Fig. 30. Annual hourly temperature graph for Ikeja.

Source: The Climates of West Africa.

APPENDIX G
SOLAR POSSIBILITIES

DHW

Domestic water heating by solar energy is important to developing countries in more sun-intensive areas of the world. The appropriate climate, the high cost of the electrical power used for domestic water heating compared with family gross income are some of the factors that brought about the thought of solar alternatives. Water heating accounts for sizeable percentage of the total energy consumption of a typical family located in hot humid region of Nigeria. It is an all year requirement of homes. This section, therefore looks into the possibilities of using the abundantly available solar radiation under favorable weather conditions virtually all year round to generate domestic hot water.

A domestic hot water (DHW) system should be designed to provide sufficient hot water when needed. Its usage at homes includes bathing, cooking, dishwashing, clothes washing and personal hygiene. However it will not be satisfactory to the users, if it is not at the proper temperature. Table 11 lists the temperature requirements that will satisfy the majority of users for various hot water applications.

The actual time of day that hot water demand imposed on a daily basis. For domestic use purposes, peak demand generally runs in a short period when people are bathing or showering.

Thermosiphon Systems

Basically, no freezing occurs in the hot humid region of Nigeria. Relatively simple solar units can be used such as the thermosiphon units

Table 11. DHW Recommended Temperature

Use	Temp.
Toilet hand washing	40.6°C -- 105°F
Shaving	46.1 -- 115
Showers and tubs	43.3 -- 110
Therapeutic baths	43.3 -- 110
Dishwashing & laundry	55.0 -- 131
Sanitizing rinse	82.2 -- 180

Source: Nigeria Federal Ministry of Statistics

with the collector and the tanks mounted on the roof. The water to be used will be directly supplied to the heating unit and after passing through the collectors and storage tank, can then be used by the consumer, Fig. 31a and 32a. The heating unit will consist of one or two flat plate collectors either made of steel or copper and of a tank of considerable capacity, depending on the size of the family. The tank and the collector will be connected to the main water supply and operate under the existing city pressure. The tank will be mounted on the roof and above the collectors in order to be able to obtain the thermosiphon flow. This motion is accomplished without a pump. The "heavier" cold water in the tank sinks to the lowest point in the system and displaces the "lighter" hot water to the top (Fig. 32a). The hotter the water in the collector and the colder the water in the tank, the greater will be the flow between the collector and the tank.

There is little maintenance involved with the thermosiphon solar system, except for probably occasional glass breakage and cleansing of dirt from the glass surface. This system is known as the open system. It should be emphasized that the tank is to be insulated to store the heated water with little temperature loss until it is required. The proportion of diffused radiation is high in hot humid region of Nigeria. It is therefore important that collectors be capable of utilizing both diffuse and direct radiation.

The limitation of the above system lies in the poor roof-scape the mounted water tank creates. This distorts the urban scenery a lot, especially where the city is poorly landscaped and dusty. This makes

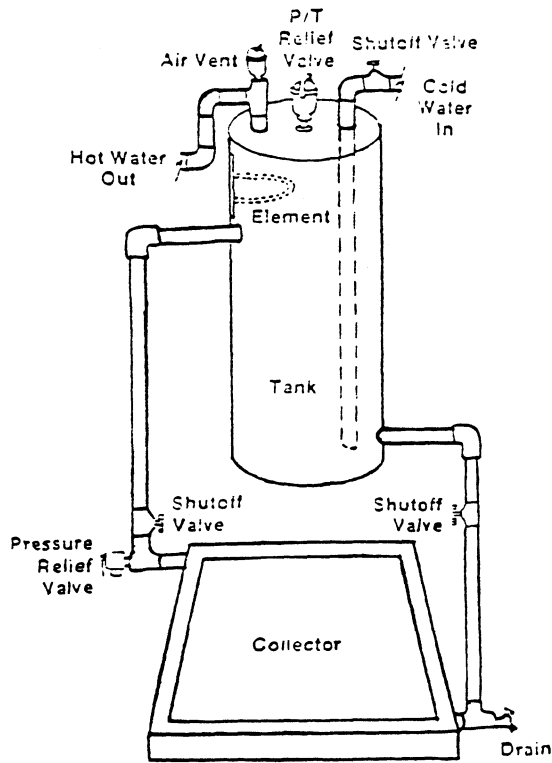

Figure 31a. Thermosiphon Solar System - Vertical Tank

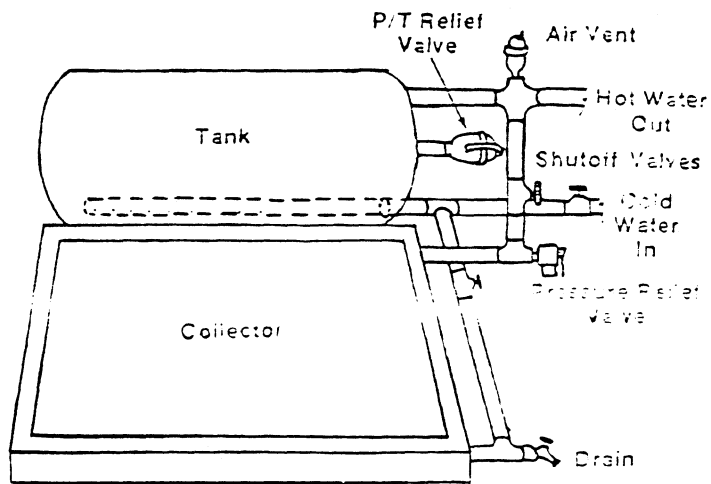
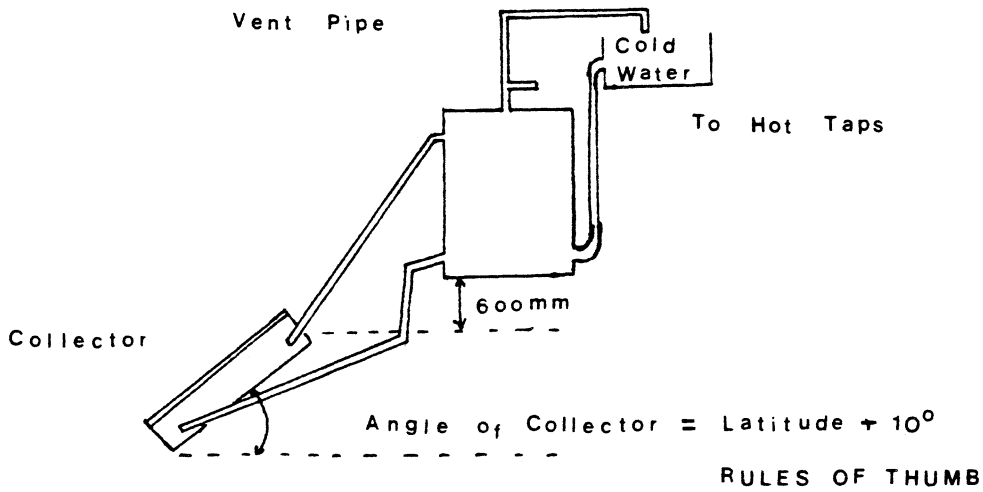
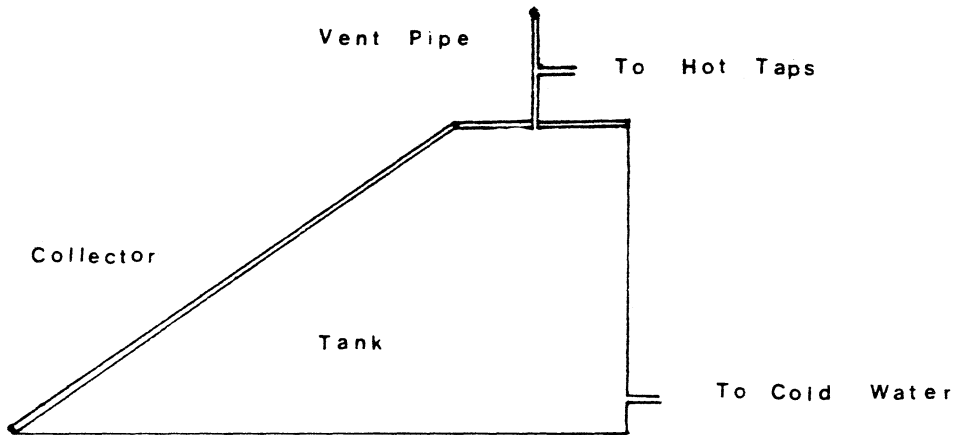

Figure 31b. Thermosiphon Solar System - Horizontal Tank



SOLAR WATER HEATER

a. Thermosiphon system



Angle of Collector = Latitude + 10°

RULES OF THUMB

b. Miromit's system

Figure 32

the system less feasible for a city like Lagos. However, a "low profile" solar water heater has been developed and designed by an Israeli company. The Miromit's break-through which enables the tank to be functionally mounted directly behind the collector (i.e., the collector on the roof surface and the tank between the ceiling and the roof) makes the heaters less obtrusive on flat roofs as well as pitched roofs. It still works like a perfect thermosiphon--without pumps to circulate water through the collector. Miromit's technical advances are backed up by modern producing facilities. The 10,000 m² plant located in Ashkelon can produce over 100,000 collectors per year, more than any other manufacturer in Israel. Miromit receives orders from all over the world.¹² Demand for Miromit's is so great that the company has been manufacturing under license in many countries. Miromit's superiority is in its selective coating, "Miroblack" developed with the Wiezmann Institute, and already in use for some years. Unlike other coatings, "Microblack" does not deteriorate in high temperature or humidity and therefore has a much longer working life than nickel, chrome or black coatings. Also in absorptivity and emissivity "Miro-black" surpasses its competitors.

Solar Induced Ventilation

Occasionally, when there is not much breeze natural ventilation can be induced by creating temperature differentials. These differentials can be generated by allowing the sun to heat a portion of the building to a temperature greater than ambient. Air coming in contact with the building surface becomes more buoyant and rises. If this rising column

of air is allowed to escape from the building, it can be used to pull conditioned air into the space. The principle of operation here is the stack effect. Briefly stated, the stack effect is a rising column of air caused by a difference in pressure and temperature. The simplest example of this is a chimney. Hot air on the inside of a chimney becomes buoyant, producing a negative pressure and inward draft of air through the bottom opening. In its effort to seek equilibrium, the rising column of air creates a positive pressure and outward flow at the top of the chimney. The stack effect can be used to advantage in passive cooling, where the rising column can be used to induce natural ventilation by pulling air along its path. In designing stack effect ventilation, the greatest air flow is achieved by maximizing both the height of stack and the temperature of air in the stack. The airflow is proportional to the inlet area and to the square root of the height times the average temperature difference; i.e.,

$$Q = 9.4 A \sqrt{h(T_1 - T_2)}$$

where Q is air flow in ft^3/min

A is the area of the inlet in ft^2

h is the height between inlet and outlet

T_1 is the average temperature of the air in the chimney

T_2 is the average temperature of outdoor air

and 9.4 is the constant of proportionality.

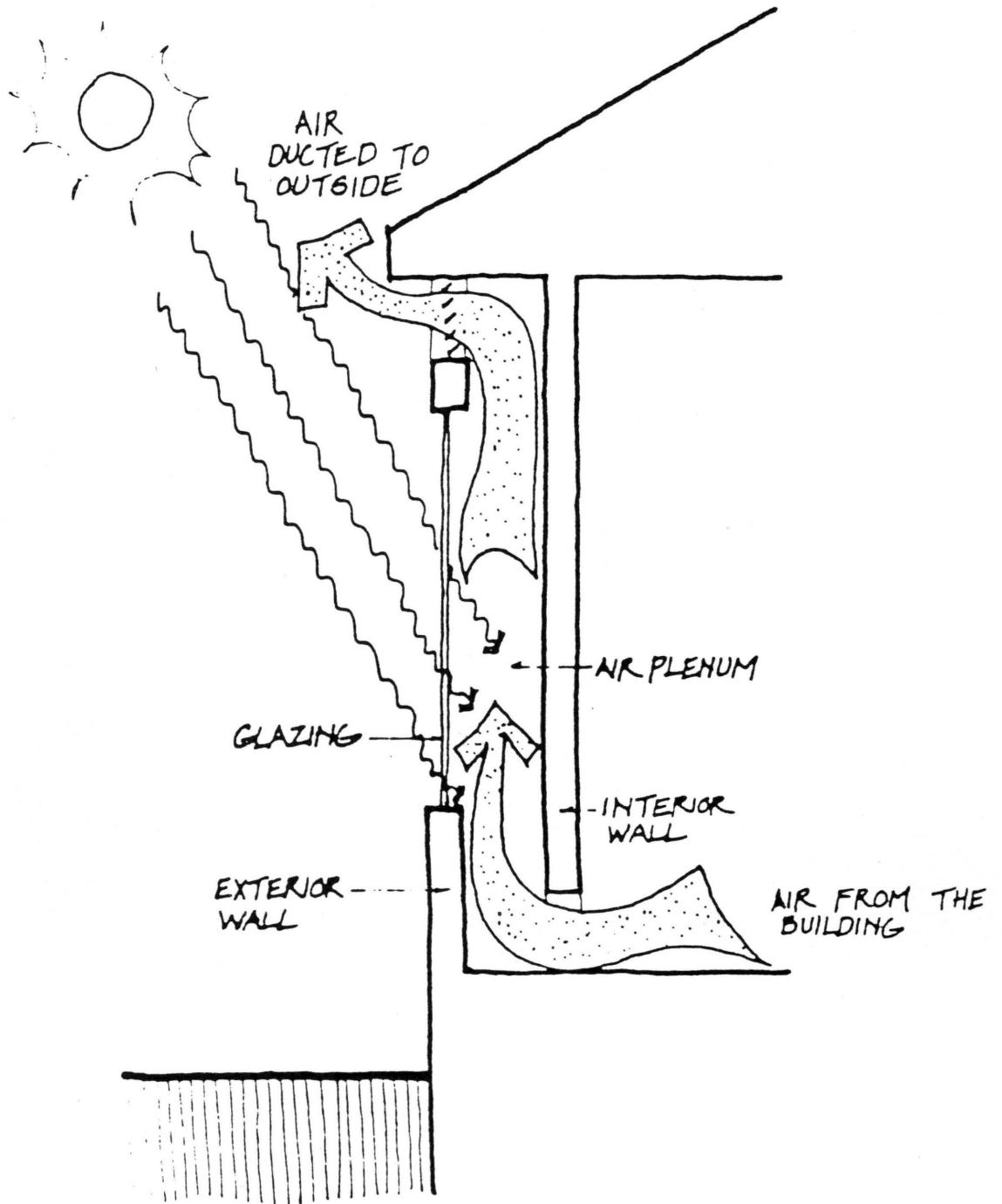
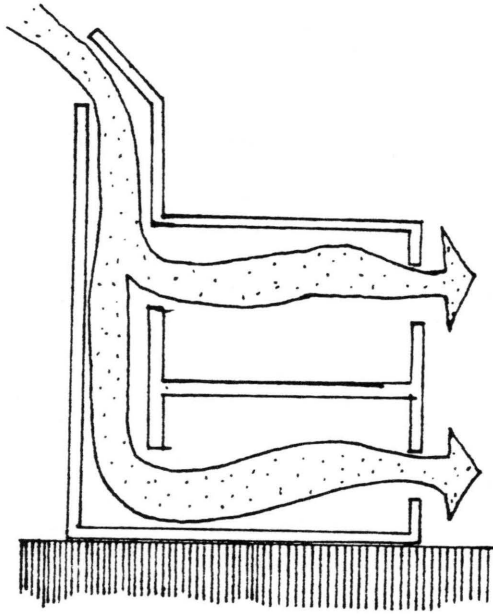

Fig. 33

ANABATIC OR STACK EFFECT

Source: Passive Solar Design Handbook.



a. PRESSURE OR DOWN DRAFT

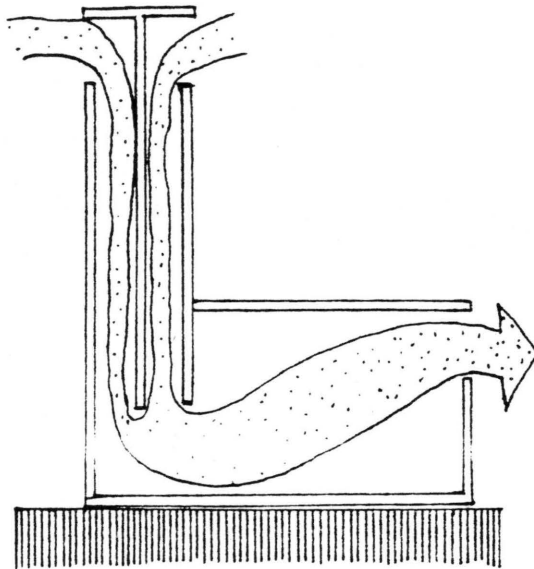

b. KATABATIC OR COLD DRAFT

Fig. 34

Three categories of thermal "chimneys" that can generate airflow are:

- Anabatic or "stack effect" which is a conventional method of hot air release from interior space (Fig. 33);
- Pressure or "down draft" chimney, which functions efficiently when predictable direction and velocity wind occur (Fig. 34a)
- Karabatic or "cold draft" chimney, which will function efficiently only when large diurnal temperature differences occur (Fig. 34b).

Solar Cooling Systems

Just as there is a distinction between active and passive solar heating, so also there is one between active and passive solar cooling. Although many passive solar cooling techniques are not strictly "solar" they are common sense methods that require little or no mechanical power.

In hot humid climate buildings can be designed and constructed not only to reduce building temperature but, in most cases, to reduce the need for mechanical cooling to its bearest minimum.

In the long run, the most important step is solar control--keeping the sun rays from hitting and entering the glazed area (Fig. 35) or specifically directing it in a positive manner (Fig. 33). The most effective passive cooling for hot humid climate is natural or induced ventilation which has been described in earlier chapters. Solar cooling can also be accomplished by combining an evaporative cooler with a rock bed or by using an indirect plate type heat exchanger; so that the humid evaporatively cooled air will not have to mix with the air being

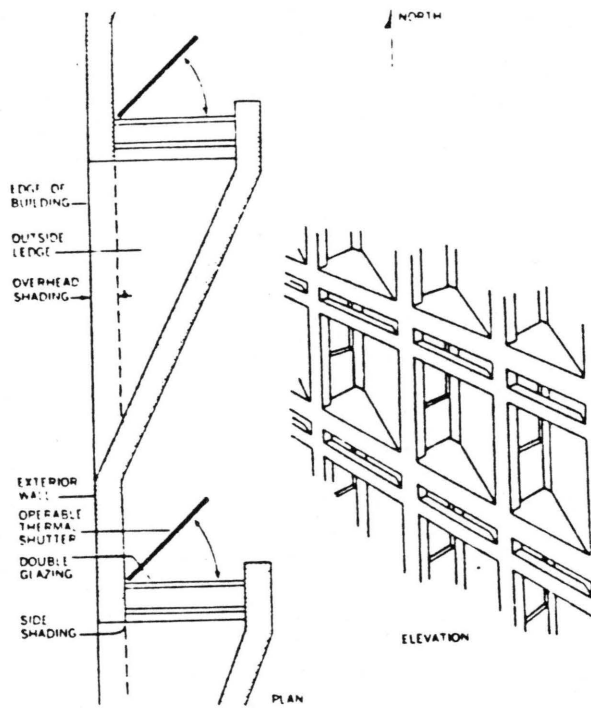

Fig. 35 . Sawtooth arrangement for windows on the east and west facade of a building excluding solar heat from striking the glazed area.

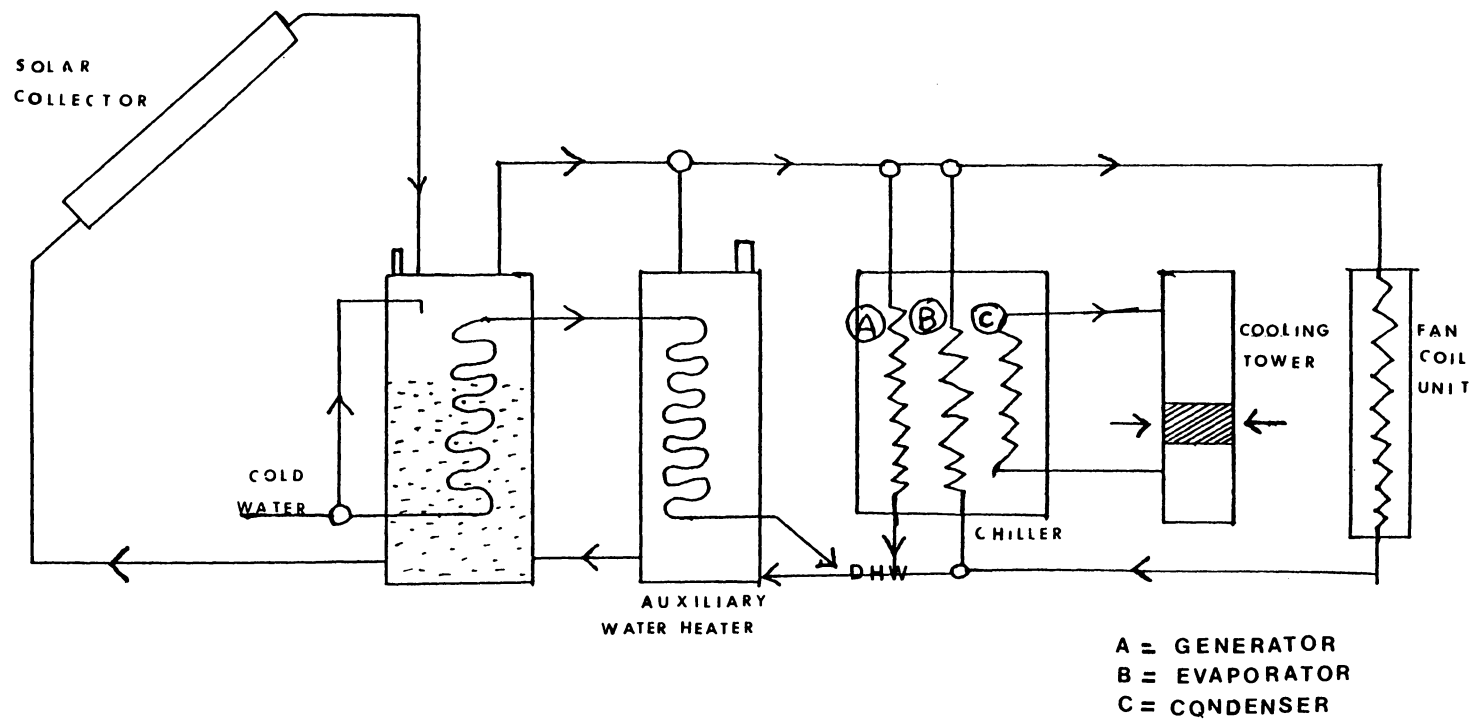

Fig. 36. Solar power absorption air conditioner.

supplied by the space. (Such systems have been widely used in Australia.)

Heat gathered at moderately high temperatures (175-195°F) by solar collector can be used successfully to operate lithium bromide water absorption cooling systems. When the unit is in operation a continuous supply of "rich" lithium bromide-water solution is provided by the generator to the evaporator where water vapor of very low pressure is absorbed by the LiBr-H₂O solution (Fig. 36).

Safety Controls

The use of solar collectors in various capacities involves adherence to some precautions and precisions. Care must be taken in the selection and placement of safety devices. A variety of valves, gauges and other components are often needed for the safe and efficient operation of the particular system. Some of the very necessary devices and their uses are briefly described below:

Backflow Preventer:

It is a device installed in the supply water line to prevent water to change flow direction when nonpotable heat transfer fluid is used. A check valve is not a substitute for back flow preventer. It should not be installed near electrical components.

Check Valve (one-way):

Check valves are designed to permit liquid flow in only one direction. They should be installed in closed-loop systems to prevent reverse thermosiphoning of heated water from the storage tank into the

collector array. When installing, be sure the arrow on the valve is pointed in the desired direction of flow. Check valves should also be installed in the drain loop of draindown systems to direct water through the collectors properly while the system is operating. Usually a swing check valve mounted horizontally is preferable to a spring check valve mounted vertically in a small pump system.

Pressure Relief Valve:

Pressure relief valve is designed to allow transfer fluids to escape from a closed loop if maximum working pressure is exceeded. If the system is not operating and the collectors reach stagnation temperature, the pressure relief valve will permit steam to escape and prevent damage to the system. The relief valve may be installed anywhere along the closed loop, but the general practice is to install it in the return side of the loop near the expansion tank and on the suction side of the pump. There should be a relief valve between all closable valves. Collectors must not be isolated without a relief valve in line. Discharge from a pressure relief valve will be very hot and should be connected to a waste drain or a container.

Temperature and Pressure Relief Valve:

This is very similar to pressure relief valve but contains a temperature sensing element at the valve inlet that extends about six inches into the top of each storage tank where the hottest water is stored. Valve limits are usually set to 125 psi and 210°F. Rating should be listed on the valve. These valves are sometimes installed in

the upper end of a tee fitting. The lower end of the tee should be connected by tapping into the top of the tank by means of a close nipple. The hot water supply line is connected to the branch of the tee when used in the domestic hot water system. Temperature and pressure relief valves should be connected to within 6 inches of a waste drain or dry wall to prevent unexpected discharge from scalding occupants or service personnel. The end of the pipe should not be threaded. Operating a hot water tank or two tanks in series without a temperature and pressure relief valve is EXTREMELY DANGEROUS.

Tempering or Mixing Valve:

Mixing valve (or tempering valve) is used to add cold water to the flow of water from the storage tank that exceeds a preset temperature. This allows the collection of hotter solar water while protecting users from being scalded. It should be installed 12 inches below the hot water outlet with cold water entering from the bottom. The heat sensing element of a tempering valve must be removed before soldering and replaced afterwards. High soldering temperatures will render the sensing element useless.

Air Vents:

It eliminates air bubbles from the system. Vents are installed at high points in the system, usually in the collector manifold and above the air eliminator. There are basically two types of vents, the manual vent and the automatic float vent. The manual is becoming uncommon. It is operated by hand, and with roof-mounted collectors, operation becomes

impossible. Automatic vents are more commonly used. The cap on the vent must not be tightened. It should only sit loosely on the threads. It is a device to prevent dust from clogging the port. The vent must be mounted vertically. For proper operation, tighten the cap and then loosen it at full two turns. This is the last step in any float vent installation.

Pressure Reducing Valve:

It is often used in a conventional water supply system. It is used to reduce the incoming water pressure and prevent damage to other components. The valve is usually installed when the incoming pressure is greater than the working pressure of any component, such as parts of a draindown system. Pressure reducing valve should be preceded by a strainer and isolated by shutoffs for cleaning.

Air Separator (or Air Eliminator):

This is used to remove air from the heat transfer fluid. The fluid flows across a series of baffles that causes air to bubble up out of the fluid stream. It is then eliminated through an automatic air vent threaded onto the top of the scoop. Eliminators are usually installed above the expansion tank.

Expansion Tank:

It is a necessary component of a close circuit solar energy water system. As the temperature of the heat transfer fluid in the loop rises, the volume of fluid expands. The apparent expansion rate per degree rise will depend on the heat transfer fluid used. The tank must

compensate for this variation in volume to keep system pressure below the maximum allowed. If the temperature and pressure rise beyond preset limits, the pressure relief valve will blow off fluid to keep the system functioning within the allowable pressure range. Nonpressurized open systems do not require a separate expansion tank because volume variations are usually handled by the storage tank.

Vacuum Relief Valve:

Vacuum relief valves are used in draindown systems and are installed at the highest point of the system. This valve lets in atmospheric pressure into the return piping and permits the system to drain by gravity. The valve is at times installed above the cold water inlet or storage tank to eliminate vacuum conditions that could collapse the tank.

Isolation Valve (Shut Off):

Isolation valve should be installed to permit sectionalized maintenance without necessarily having to drain and refill the whole system. Valve handles should be removed and stored in a safe place to avoid unauthorized tampering of the system; or use tool-operated valves. Globe valves should not be used because they restrict flow and reduce system efficiency. Isolation valve should be installed at the city water supply inlet to shut down the system if need be. Also one on each side of any device that could require occasional maintenance or potential replacement.

Isolation valve should not be installed in a way that could cut-off collectors from either pressure or temperature and pressure relief valves and the expansion tank. Else collectors could burst during maintenance period.

Boiler Drain Valve:

It is installed at the bottom of the storage tank for occasional cleaning. Also used to charge-up the system when needed.

Pressure Gauge:

A pressure gauge should be installed on the collector loop or on top of the air eliminator to indicate the operating pressure of the system.

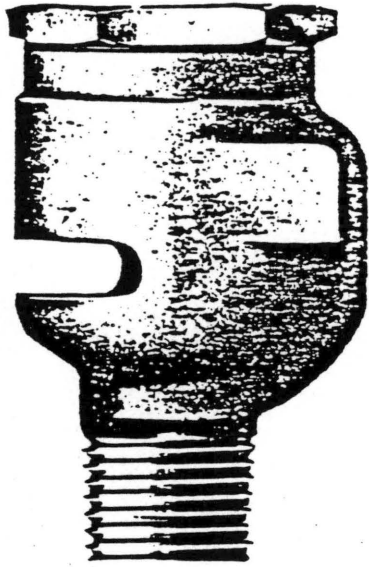

VACUUM RELIEF VALVE



BOILER DRAIN VALVE



ISOLATION VALVE

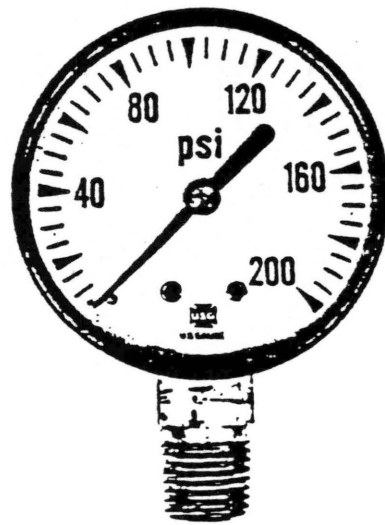

PRESSURE GAUGE

Fig. 37

Source: Prof. Chiang, N. S. Solar Energy Information Sheets.

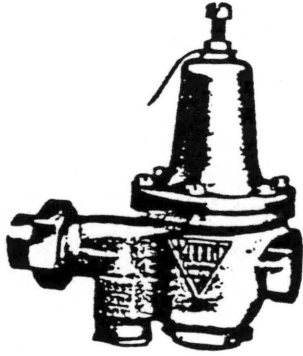

PRESSURE REDUCING VALVE

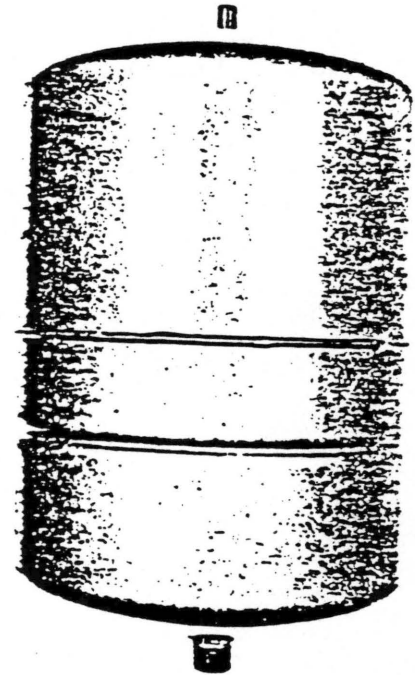

EXPANSION TANK



AIR VENT



AIR SEPARATOR

Fig. 38

Source: Prof. Chiang, N. S. Solar Energy System Information Sheets.

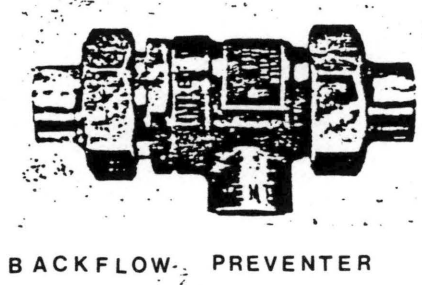

BACKFLOW PREVENTER

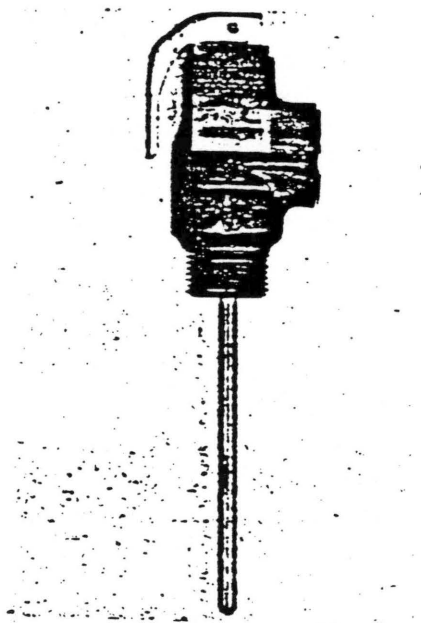

TEMPERATURE AND PRESSURE REL. VALVE

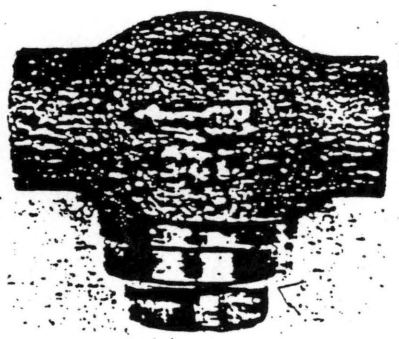

CHECK VALVE

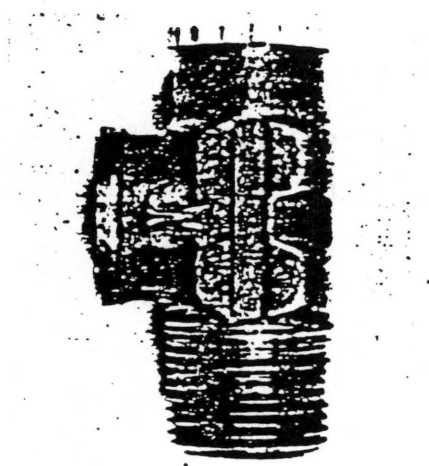

PRESSURE RELIEF VALVE

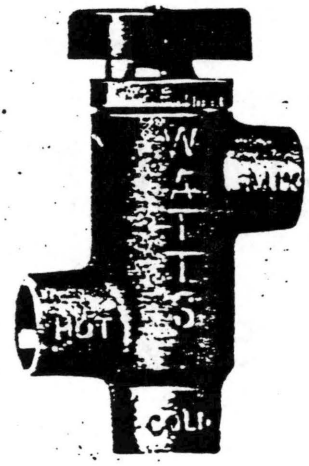

MIXING VALVE

Fig. 39

Source: Prof. Chiang, N. S. Solar Energy System Information Sheets.

APPENDIX H

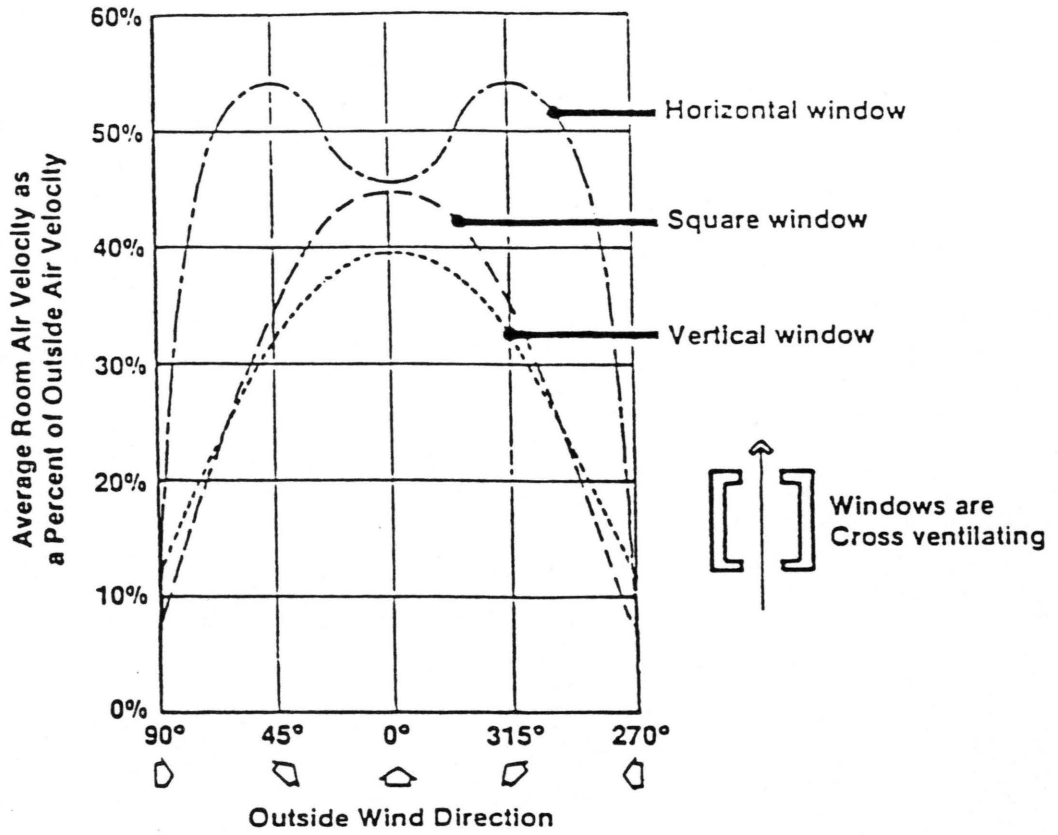
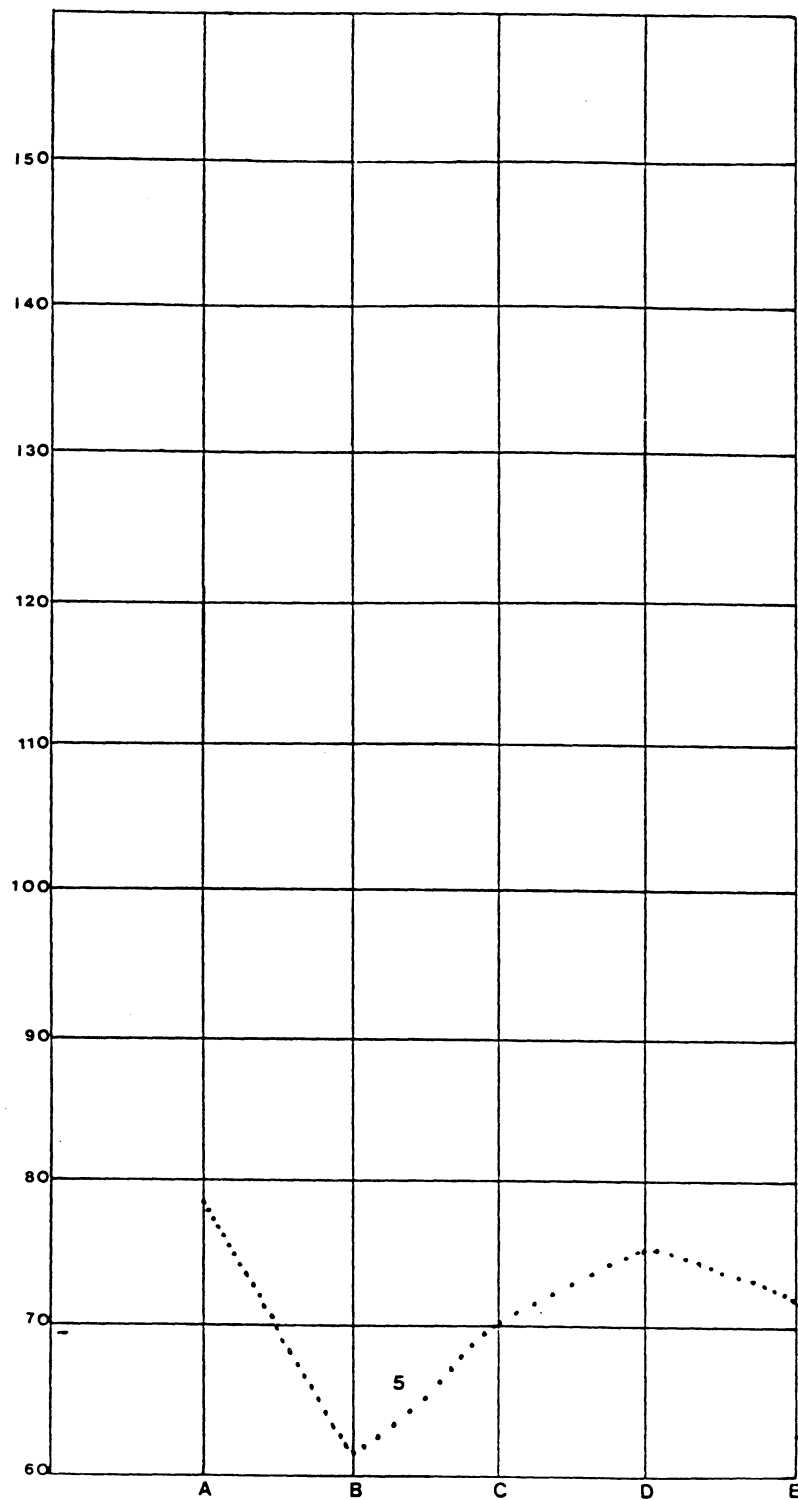
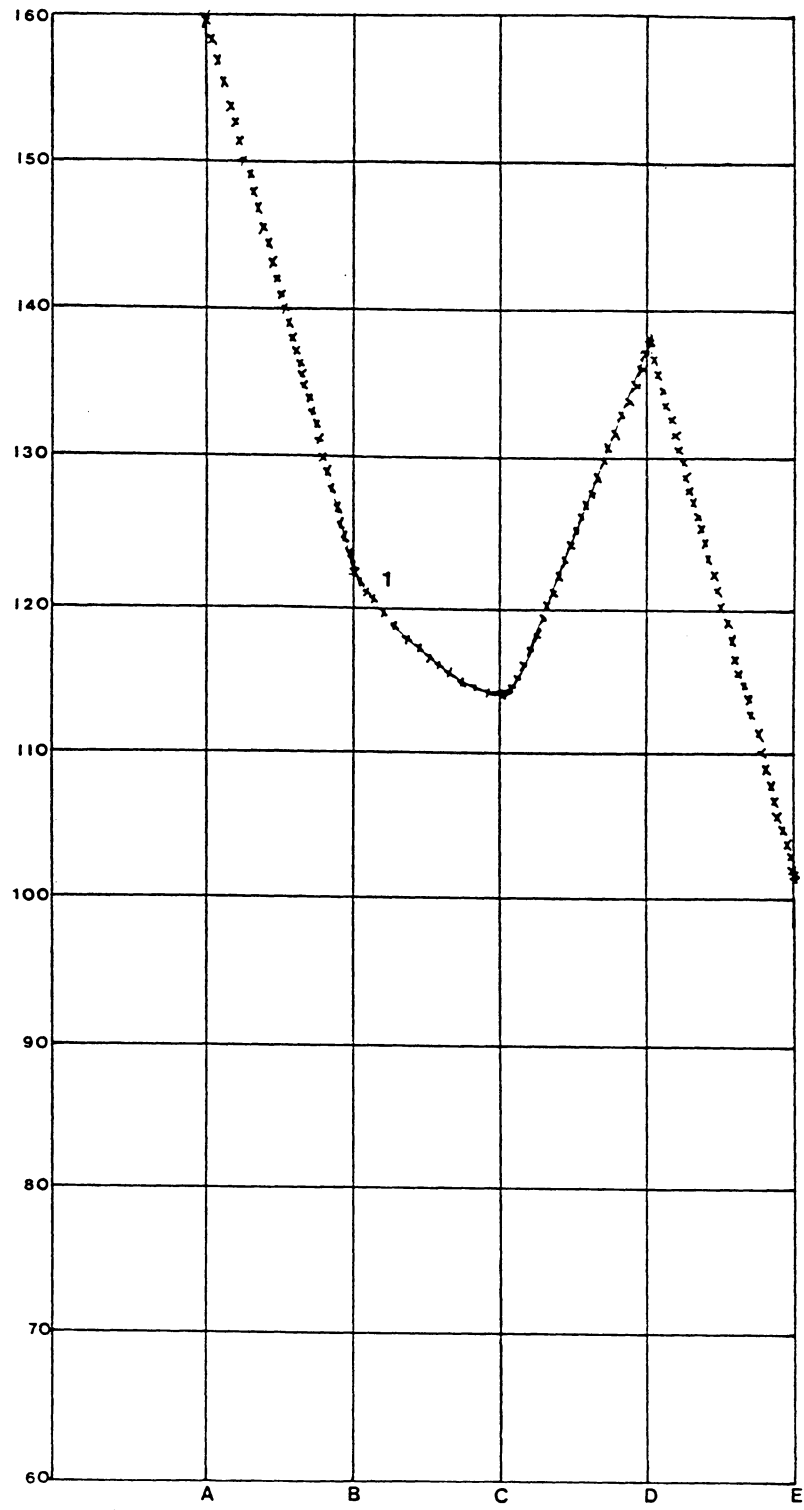
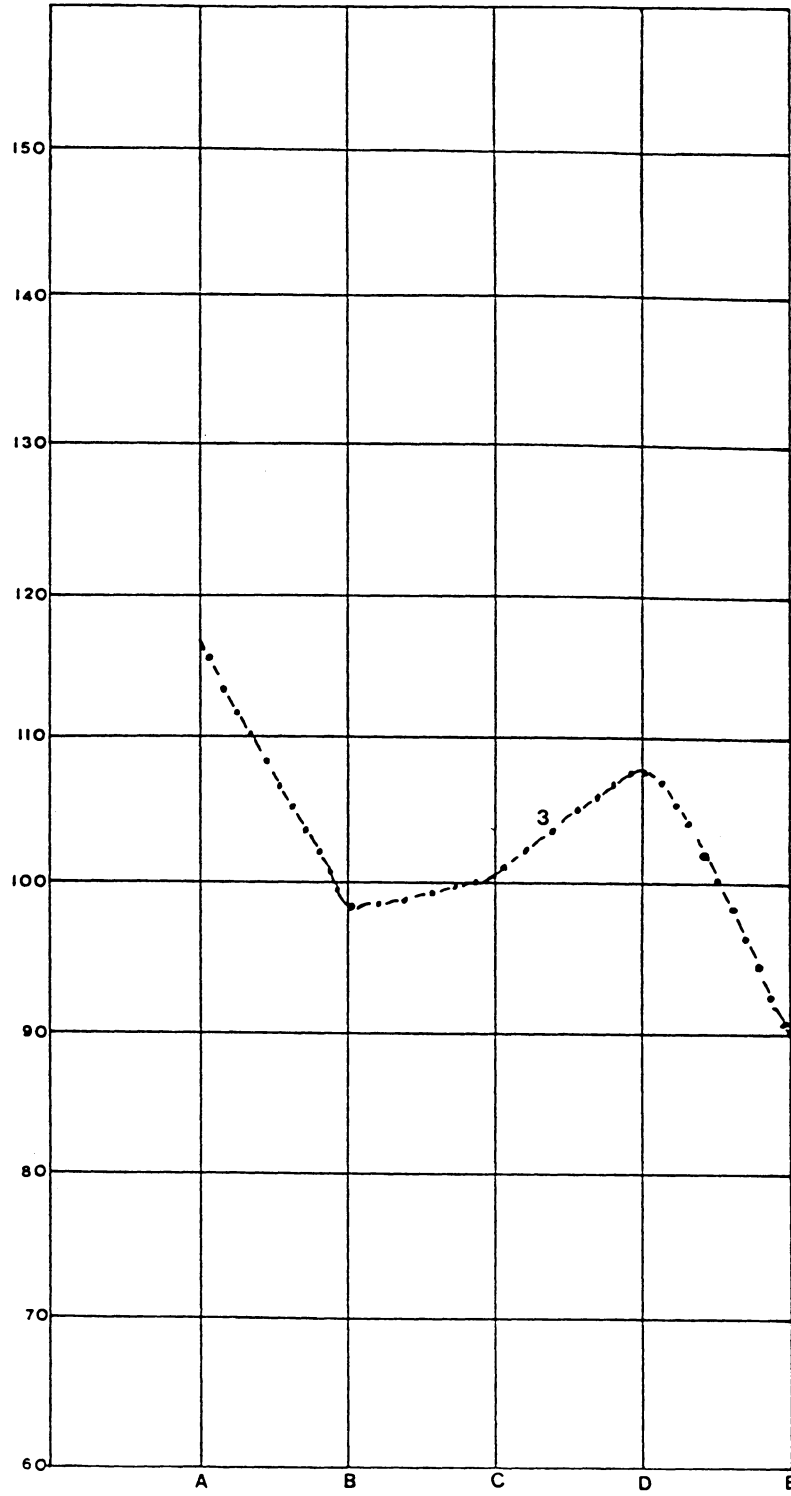
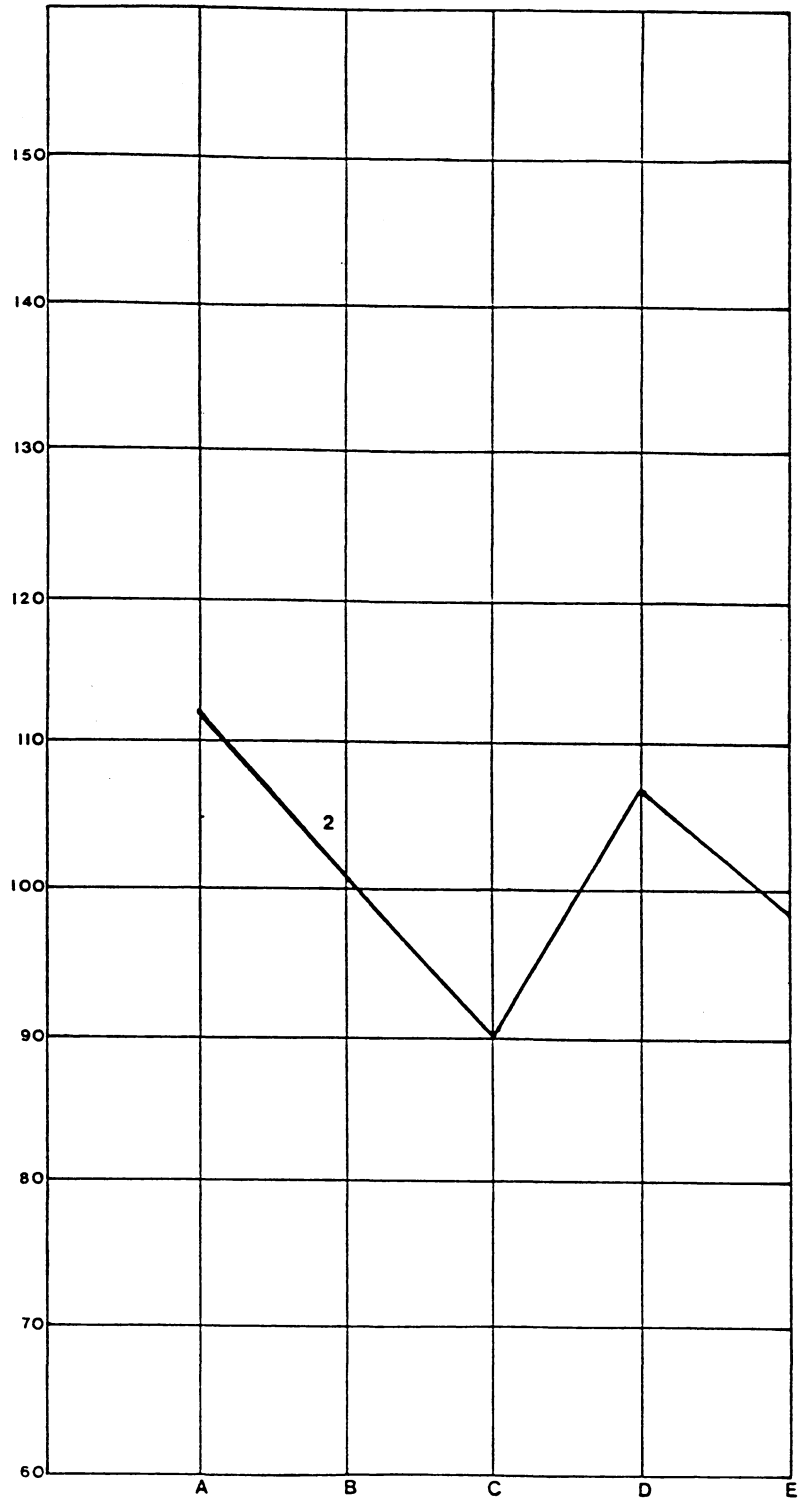

Fig. 40 Window shape performance in relation to wind direction









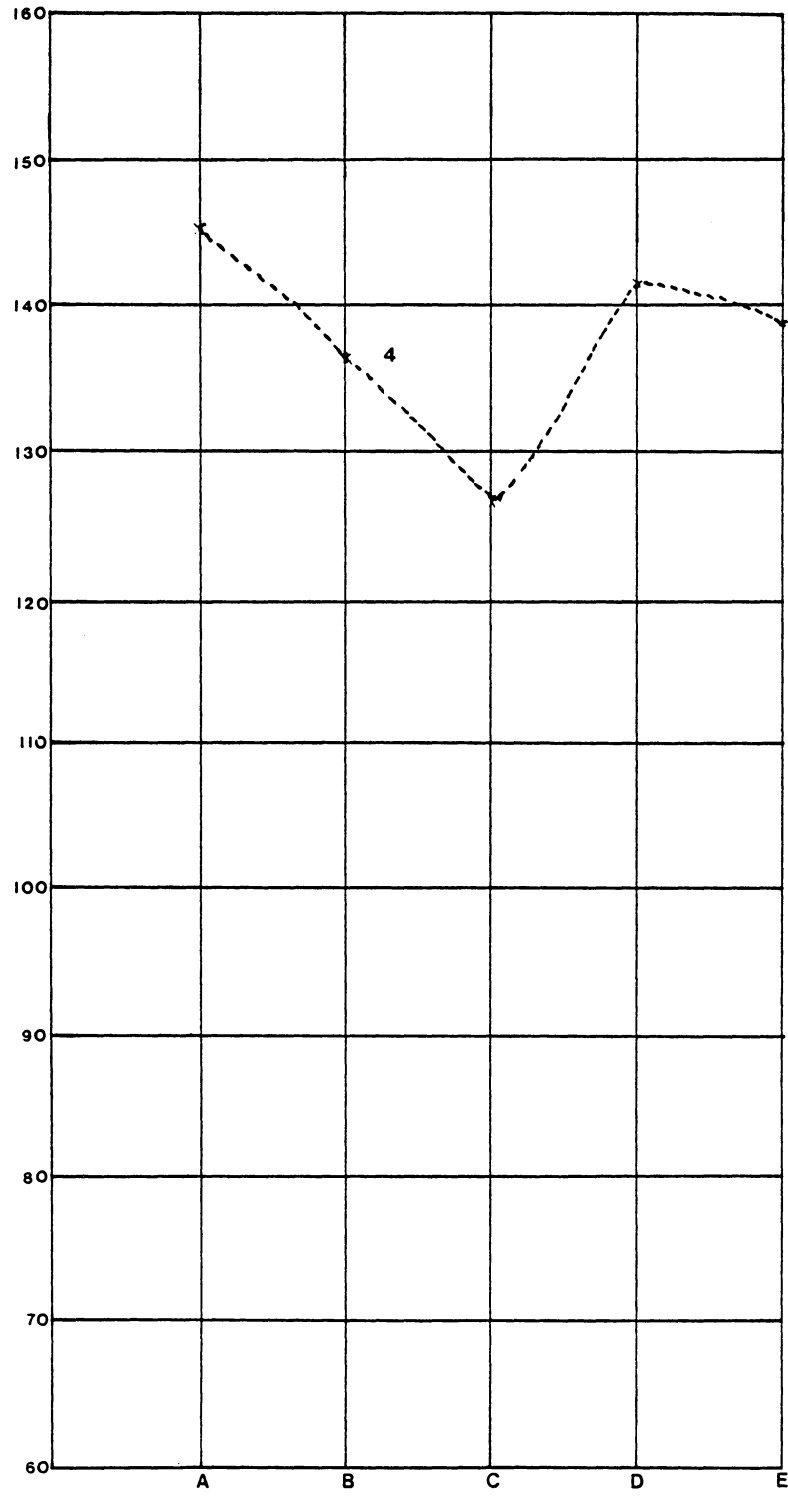

FOOTNOTES

¹Ministry of Economic Planning and Land Matters , Urban and Regional Planning Division, Lagos State Secretariat Ikaja 1982, Lagos State Regional Plan (1980-2000) pg. 1.

²Lagos State Regional Plan (1980-2000) pg. 1.

³Lagos State Annual Report, 1982, pg. 4.

⁴United Nations Department of Social and Economic Affairs. Design of Low Cost Housing and Community Facilities Vol. One: Climate and House Design. New York: UN Publication, 1971, pg. 82.

⁵United Nations Dept. of Social and Economic Affairs, New York: UN Publication, 1971, pg. 82.

⁶The New Geography of Nigeria by Iloeje, pg. 24.

⁷Lagos State Metreological Station Report, 1982-83, pg. 10.

⁸Sobin, Harris, Window Design for Passive Ventilative Cooling: An Experimental Study, pg. 3.

⁹Caudill, W; Read, B. H. (1951) A Publication of the Texas Engineering & Experimental Station, Texas A&M, 1951, Research No. 22.

¹⁰Givoni, Man, Climate and Architecture, pg. 145-158.

¹¹J. F. Van Straateen, The effect of the ventilation on the indoor thermal and ventilation conditions in dwellings of conventional constructions, H.B.R. Bulletin No. 15, Jan. 1957, pg. 38-64.

**The vita has been removed from
the scanned document**