

A PRELIMINARY INVESTIGATION OF
MICROBUBBLE FLOTATION OF FINE COAL

by

Gregory S. Halsey

Submitted to the Faculty of the
Virginia Polytechnic Institute and State University
in partial fulfillment of the requirements for the degree of

MASTER OF SCIENCE

in

Mining and Minerals Engineering

APPROVED:

R. H. Yoon, Chairman

F. Sebba

J. R. Lucas

W. E. Foreman

G. T. Adel

December, 1986

Blacksburg, Virginia

A PRELIMINARY INVESTIGATION OF
MICROBUBBLE FLOTATION OF FINE COAL

by

Gregory S. Halsey

Committee Chairman: R. H. Yoon
Mining and Minerals Engineering

(ABSTRACT)

Although froth flotation is generally recognized as the most viable means of cleaning fine coal, a loss in recovery rate and selectivity is encountered when attempting to apply the process to clean ultrafine coals. In this work, batch flotation tests were conducted on several Appalachian coals using microbubbles in a cylindro-conical flotation column. Results indicate that this technique shows improvements over the conventional technique using larger bubbles, when the coal is ultrafine. The improvement in recovery rate with the microbubbles is due to improved hydrodynamic conditions which are more conducive to bubble/particle collision, while the improvement in selectivity is due to the absence of turbulent wakes.

ACKNOWLEDGEMENTS

The author acknowledges Dr. R. H. Yoon for his invaluable assistance and Mr. Mark Spangler and Ms. Jane Kerstetter for their help with the experimental work. Acknowledgements are also extended to Dr. J. R. Lucas and to Dr. F. Sebba for their guidance, and to Mr. and Mrs. Carson R. Halsey and to Ms. Beth Dillinger for their encouragement. Thanks to Ms. Jeni Hunley for typing the manuscript.

The author appreciates the funding for this project provided by the Department of Energy and the fellowships awarded by the Department of Health, Education, and Welfare during the 1980-82 academic years.

TABLE OF CONTENTS

Abstract	ii
Acknowledgements	iii
List of Figures	vii
List of Tables	xiv
Introduction	1
I. General	1
II. Literature Review	5
III. Objectives	10
Experimental	11
I. Materials	11
A. Collection and Storage of Coal Samples	11
B. Sample Preparation	12
C. Reagents	13
II. Equipment	13
A. Microflotation Apparatus	13
B. Microbubble Generators	14
C. Microbubble Flotation Cells	16
D. Automated Conventional Flotation Machine	17

III.	Procedures	17
	A. Microflotation Tests	17
	B. Microbubble Generation	18
	C. Microbubble Stability Measurements	19
	D. Microbubble Flotation Tests	20
	E. Conventional Flotation Tests	21
	F. Kinetics Flotation Tests	22
IV.	Results	23
	A. Microflotation Tests	23
	B. Microbubble Stability Measurements	23
	Effect of Frothers	23
	Effect of pH	24
	Type of Microbubble Generator	25
	Effect of Temperature	25
	Effect of Volume of Solution	26
	C. Microbubble Flotation Tests	27
	Effect of Frothers	27
	Effect of pH	34
	Effect of Collector Additions	35
	Effect of Pulp Density	38
	Effect of Settling Time	41
	Effect of Particle Size	42
	D. Conventional Versus Microbubble Flotation Tests	43

E. Effect of Bubble Size on Flotation Kinetics	48
Discussion	52
I. Microbubble Generation	52
II. Optimization of Microbubble Flotation	53
III. Effect of Particle Size and Bubble Size	57
Summary and Conclusions	60
References	61
Figures	63
Tables	113
Appendix	121
Material Balance Sheets for Kinetics Tests	
Vita	126

LIST OF FIGURES

Figure 1.	Microflotation apparatus.	64
Figure 2.	Aspirator apparatus used to generate microbubbles.	65
Figure 3.	Blender apparatus used to generate microbubbles.	66
Figure 4.	Microbubble flotation cells.	67
Figure 5.	Conventional flotation machine.	68
Figure 6.	Floatability of various size fractions of Jawbone coal.	69
Figure 7.	Stability of microbubbles generated by the aspirator technique using various frothers.	70
Figure 8.	Stability of microbubbles generated by the blender technique using various frothers.	71
Figure 9.	Results of flotation tests conducted on -100 mesh Eagle Coal using 3 lb/ton of kerosene and microbubbles generated by the blender technique with varying amounts of Aerofroth 73.	72
Figure 10.	Results of flotation tests conducted on -100 mesh Eagle Coal using 3 lb/ton of kerosene and microbubbles generated by the blender technique with varying amounts of pine oil.	73
Figure 11.	Results of flotation tests conducted on -100 mesh Eagle Coal using 3 lb/ton of kerosene and microbubbles generated by the blender technique with varying amounts of Dowfroth M210.	74
Figure 12.	Results of flotation tests conducted on -100 mesh Eagle Coal using 3 lb/ton of kerosene and microbubbles generated by the blender technique with varying amounts of Dowfroth E1128.	75

Figure 13.	Results of flotation tests conducted on -100 mesh Eagle Coal using 3 lb/ton of kerosene and microbubbles generated by the blender technique with varying amounts of Tergitol TMN-6.	76
Figure 14.	Results of flotation tests conducted on -100 mesh R & F Coal using 3 lb/ton of kerosene and microbubbles generated by the blender technique with varying amounts of Silicone L7001.	77
Figure 15.	Results of flotation tests conducted on -100 mesh Eagle Coal using 1 lb/ton of kerosene and microbubbles generated by the aspirator technique with varying amount of MIBC.	78
Figure 16.	Results of flotation tests conducted on -100 mesh Eagle Coal using 3 lb/ton of kerosene and microbubbles generated by the aspirator technique with varying amounts of MIBC.	79
Figure 17.	Results of flotation tests conducted on -400 mesh Taggart Coal using 5 lb/ton of kerosene and microbubbles generated by the aspirator technique with varying amounts of MIBC.	80
Figure 18.	Results of flotation tests conducted on -100 mesh Eagle Coal using 1 lb/ton of kerosene and microbubbles generated by the blender technique with varying amounts of Dowfroth M150. Different volumes and microbubbles were injected in each series.	81
Figure 19.	Results of flotation tests conducted on -100 mesh Eagle Coal using 3 lb/ton of kerosene and microbubbles generated by the aspirator technique with varying amounts of Dowfroth M150. Different volumes of microbubbles were injected in each series.	82
Figure 20.	Results of flotation tests conducted on -100 mesh R & F Coal using 3 lb/ton of kerosene and microbubbles generated by the aspirator technique with varying amounts of Dowfroth M150.	83

- Figure 21. Results of flotation tests conducted on -400 mesh Taggart Coal using 5 lb/ton of kerosene and microbubbles generated by the aspirator technique with varying amounts of Dowfroth M150. 84
- Figure 22. Results of two state flotation tests conducted on -400 mesh Taggart Coal using 5 lb/ton of kerosene and microbubbles generated by the aspirator technique with 10 lb/ton of Dowfroth M150 in the first stage and varying amounts of Dowfroth M150 in the second stage. 85
- Figure 23. Results of two stage flotation tests conducted on -400 mesh Taggart Coal using 5 lb/ton of kerosene and microbubbles generated by the aspirator technique with 10 lb/ton of Dowfroth M150 in the first stage and varying amounts of MIBC in the second stage. 86
- Figure 24. Results of flotation tests conducted on -100 mesh Eagle Coal using 6 lb/ton of kerosene and microbubbles generated by the blender technique with 6 lb/ton of Dowfroth M150 and varying amounts of MIBC. 87
- Figure 25. Results of flotation tests conducted on -100 mesh Eagle Coal using 6 lb/ton of kerosene and microbubbles generated by the blender technique with 6 lb/ton of Dowfroth M150. Various amounts of MIBC were added to the coal during conditioning. 88
- Figure 26. Results of flotation tests conducted on -100 mesh Eagle Coal using 6 lb/ton of kerosene and microbubbles generated by the blender technique with 6 lb/ton of MIBC and varying amounts of Dowfroth M150. 89
- Figure 27. Results of flotation tests conducted on -100 mesh Eagle Coal using 3 lb/ton of #2 diesel fuel and microbubbles generated by the blender technique with 3 lb/ton of Dowfroth M150 and varying amounts of MIBC. 90

Figure 28.	Results of flotation tests conducted on -100 mesh Eagle Coal using 3 lb/ton of #2 diesel fuel and microbubbles generated by the blender technique with 1 lb/ton of Dowfroth M150 and varying amounts of MIBC.	91
Figure 29.	Results of flotation tests conducted on -100 mesh Eagle Coal using 3 lb/ton of kerosene and microbubbles generated at varying pH by the blender technique with 3 lb/ton of Dowfroth M150.	92
Figure 30.	Stability of microbubbles generated by the blender technique using .15 ml/L of Dowfroth M150 and varying the pH.	93
Figure 31.	Results of two stage flotation tests conducted on -100 mesh Eagle Coal using varying amounts of kerosene and microbubbles generated by the aspirator technique with 6 lb/ton of Dowfroth M150 in the first stage and 3 lb/ton of Dowfroth M150 in the second stage.	94
Figure 32.	Results of two stage flotation tests conducted on -100 mesh Eagle Coal using varying amounts of kerosene and microbubbles generated by the blender technique with 6 lb/ton of Dowfroth M150 in the first stage and 3 lb/ton of Dowfroth M150 in the second stage.	95
Figure 33.	Results of two stage flotation tests conducted on -100 mesh Eagle Coal using varying amounts of #2 diesel fuel and microbubbles generated by the blender technique with 6 lb/ton of Dowfroth M150 in the first stage and 3 lb/ton of Dowfroth M150 in the second stage.	96
Figure 34.	Results of two stage flotation tests conducted on -100 mesh R & F Coal using varying amounts of kerosene and microbubbles generated by the aspirator technique with 6 lb/ton of Dowfroth M150 in the first stage and 3 lb/ton of Dowfroth M150 in the second stage.	97

- Figure 35. Results of two stage flotation tests conducted on -400 mesh Taggart Coal using varying amounts of kerosene and microbubbles generated by the aspirator technique with 6 lb/ton of Dowfroth M150 in the first stage and 3 lb/ton of Dowfroth M150 in the second stage. 98
- Figure 36. Results of flotation tests conducted on -100 mesh Eagle Coal using 3 lb/ton of kerosene and microbubbles generated by the blender technique with 6 lb/ton of Dowfroth M150. Different portions of the kerosene were added directly to the microbubbles. 99
- Figure 37. Results of flotation tests conducted on -100 mesh Eagle Coal using varying amounts of kerosene and microbubbles generated by the blender technique with 6 lb/ton of Dowfroth M150. The kerosene was added directly to the microbubbles. 100
- Figure 38. Results of two stage flotation tests conducted on -400 mesh Taggart Coal using 5 lb/ton of kerosene and microbubbles generated by the aspirator technique with 0.10 ml/l of Dowfroth M150 in the first stage and 0/5 ml/l of Dowfroth M150 in the second stage. The pulp density (sample size) was varied in each test. 101
- Figure 39. Results of two stage flotation tests conducted on -400 mesh Taggart Coal using 5 lb/ton of Dowfroth M150 and microbubbles generated by the aspirator technique with 4 lb/ton of Dowfroth M150 in the first stage and 2 lb/ton of Dowfroth M150 in the second stage. The pulp density (Dowfroth M150 concentration) was varied in each test. 102
- Figure 40. Results of flotation tests conducted on -100 mesh Eagle Coal using 3 lb/ton of kerosene and microbubbles generated by the aspirator technique with 6 lb/ton of MIBC in one series and 3 lb/ton of MIBC in the other series. The amount of time allowed for the ash to settle was varied in each test. 103

Figure 41.	Results of flotation tests conducted on various size fractions of the Eagle Coal using 3 lb/ton of kerosene and microbubbles generated by the aspirator technique with 6 lb/ton of Dowfroth M150.	104
Figure 42.	Results of flotation tests conducted on attrition ground Eagle Coal using varying amounts of kerosene and microbubbles generated by the aspirator technique with 6 lb/ton of Dowfroth M150.	105
Figure 43.	Results of conventional flotation tests conducted on -400 mesh Taggart Coal using 5 lb/ton of kerosene and using varying amounts of Dowfroth M150 in the first stage.	106
Figure 44.	Results of conventional flotation tests conducted on -400 mesh Taggart Coal using 5 lb/ton of kerosene and using 1 lb/ton of Dowfroth M150 in the first stage and varying amounts of Dowfroth M150 in the second stage.	107
Figure 45.	Recovery of coal of kinetics flotation tests conducted on -100 mesh Eagle Coal using 3 lb/ton of kerosene and various sized bubbles generated with 3 lb/ton of Dowfroth M150.	108
Figure 46.	Cumulative ash of clean coal of kinetics flotation tests conducted on -100 mesh Eagle Coal using 3 lb/ton of kerosene and various sized bubbles generated with 3 lb/ton of Dowfroth M150.	109
Figure 47.	Recovery of coal of kinetics flotation tests conducted on attrition ground Eagle Coal using 3 lb/ton of kerosene and various sized bubbles generated with 3 lb/ton of Dowfroth M150.	110
Figure 48.	Incremental ash of clean coal of kinetics flotation tests conducted on attrition ground Eagle Coal using 3 lb/ton of kerosene and various sized bubbles generated with 3 lb/ton of Dowfroth M150.	111

Figure 49. Cumulative ash of clean coal of kinetics flotation tests conducted on attrition ground Eagle Coal using 3 lb/ton of kerosene and various sized bubbles generated with 3 lb/ton of Dowfroth M150.

112

LIST OF TABLES

I.	Coal Samples	114
II.	Reagents	115
III.	Results of the Flotation Tests Conducted on the -100 Mesh Eagle Coal	116
IV.	Results of the Flotation Tests Conducted on the -100 Mesh R & F Coal	117
V.	Results of the Flotation Tests Conducted on the -400 Mesh Taggart Coal	118
VI.	Results of the Flotation Tests Conducted on the Attrition Ground Eagle Coal	119
VII.	Summary of the Results of the Conventional Versus Microbubble Flotation Tests	120

INTRODUCTION

I. General

The production of coal in the United States will soon reach 900 million tons annually (Guccione, 1986a). Coal cleaning is performed on run-of-mine coal to remove ash and sulfur and produce a uniform product which meets market use. Virtually all of the coals used for metallurgical purposes are cleaned, while more than 70% of coal burned for electric power generation is cleaned (Guccione, 1986b).

Ash is a ceramic property (the residue after combustion of the carbon) related to the mineral matter present in the coal. From a traditional viewpoint, it consists of inherent ash which was present in the original vegetable matter and is generally inseparable by physical means, and segregated ash which occurs as physically discrete particles and can be physically separated from the coal. The intended end-use of the coal and the economics of any situation dictate the extent to which ash is separated from the coal before use. Generally speaking, the ash content of coal to be burned in an electric power generating plant is in the range of 7 to 10 percent. Recently, much interest has generated in the preparation of superclean coals which contain less than 2% ash to be used for the production of liquid coal fuels to replace oil and gas currently burned by electric

utilities.

Sulfur occurs in coal in three forms. Pyritic sulfur occurs as physically discrete particles which can be separated from the coal, while organic sulfur is molecularly bound to the coal matrix and generally cannot be removed physically. Much research is ongoing, however, with some success, in attempts to find viable chemical or biological means of removing the organic sulfur. Sulfates, which rarely exceed a few hundredths percent except in highly oxidized samples, are generally removed by water washing. Again, the intended use of the coal and the economics of the situation dictate the extent to which sulfur is removed from the coal. For example, in a few cases with coal used for electric power generation, higher sulfur coals are blended with low sulfur coals to raise the sulfur level so that already installed smokestack scrubbers will work properly.

The bulk of coal cleaning is done on coarse (+1/4 inch) and intermediate (1/4 inch x 28 mesh) particles and relies on gravity separation techniques. However, as much as 25% of a plant's feed (usually 10-15%) may be present as fines (-28 mesh). The cost of efficiently processing the fine fraction is comparatively high, and therefore it is not uncommon to simply discard this fraction or to incorporate it into the clean coal. Recently, however, the benefits of cleaning the fines, for both economic and environmental reasons, are becoming realized and the practice is becoming

more widespread. In some cases, it has even become a practice to reclaim fine coal previously discarded (Green, 1983). Deister tables, spirals, water only cyclones, and heavy medium cyclones have proven somewhat effective in cleaning coal fines down to roughly 200 mesh, but these devices have difficulty in efficiently cleaning the ultrafines. Oil agglomeration is effective in cleaning ultrafines, but oil consumption is usually prohibitively high. Froth flotation is generally recognized as the most viable means of cleaning ultrafines and is the most commonly applied process for cleaning the 28 x 0 coal fraction (O'Brien, 1980).

Approximately 10 to 15 million tons of coal are currently cleaned annually by flotation. In the United States during the period from 1960 to 1980, coal flotation capacity grew from 26,500 tpd to 78,300 tpd (Miller, 1982). Aplan (1976) gives two reasons for the recent growth rate: 1) flotation is an excellent means of mitigating the black water problem in plants and 2) with substantial increases in the value of coal and its cost of production, the fines previously wasted become a valuable product. Furthermore, with increased mechanization of mining methods, more fines are being produced. In some cases, coal is even crushed to very fine sizes for improved liberation of ash material and flotation is used as a means of producing a superclean coal to be used in liquid fuels (Burguss et al, 1983).

Coal flotation is not without its share of problems.

Some of these are 1) cost and effectiveness of dewatering, 2) inability to make clean separations with the ultrafine fractions, and 3) inability to clean slurries containing a high percentage of clay. Ultrafine coal fractions frequently contain a high percentage of clays and other silicate minerals, and the loss of selectivity encountered when attempting to float these fractions can be disastrous. A large amount of ultrafine coal may be lost to the tailings as well. It is not uncommon for the ultrafine fraction to be removed (usually by hydrocyclone) prior to flotation and discarded.

The difficulty in floating ultrafine coal may be ascribed to the fact that the bubbles generated in industrial flotation machines are too large (.2 to 2 mm) to selectively capture the ultrafines. Hydrodynamic considerations suggest that ultrafine particle flotation can be improved by using smaller gas bubbles than those conventionally used. Sebba (1975) has recently described an alternate method of generating micron-size gas bubbles externally of the flotation cell. It is the purpose of this study to investigate the application of such microbubbles for the flotation of ultrafine coals.

II. Literature Review

The basic mechanisms of bubble/particle interaction necessary for flotation to occur may be viewed as collision of the particle with the bubble followed by attachment or adhesion of the particle to the bubble. For successful flotation to occur, the two must remain attached and float to the surface of the pulp. Mathematically, the probability of collection (P), which is defined as the fraction of particles in the path of a bubble which are in fact actually collected by the bubble, may be given as:

$$P = P_c P_a \quad [1]$$

where P_c is the fraction of particles in the path of a bubble which actually collides with the bubble and P_a is the fraction of particles which actually adhere to the bubble after having collided with it. In the case of a very hydrophobic material, it could be assumed that P_a equals unity, but with ash containing coal, P_a would equal less than unity.

Omitting gravitational collision because of the small size and mass of ultrafines, Weber and Paddock (1983) developed an equation to theoretically calculate the probability of interceptional collision of particle and bubble as:

$$P_c = \frac{3}{2} \left(\frac{D_p}{D_b} \right)^2 \left(1 + \frac{\frac{3}{16} Re}{1 + 0.249 Re^{0.56}} \right), \quad [2]$$

where D_p is the particle diameter, D_b is bubble diameter, and Re is the Reynolds number of the bubble. Because of assumptions

made in deriving the equation, it is strictly valid only for rigid spheres of $\frac{D_p}{D_b} < 0.1$ and for $0 < Re < 300$. As witnessed by this equation, theoretically, the smaller the bubble diameter, the greater the probability that a given particle will collide with (and be collected by) a bubble in a flotation system.

Yoon and Luttrell (1985) constructed an apparatus to measure probability of collection and using very hydrophobic Buehler seam coal from New Zealand (0.13% ash), conducted experiments to test the validity of Weber and Paddock's equation discussed previously over a range of bubble sizes. They found excellent agreement between their experimental results and the equation. A slight discrepancy did occur, however, when using very fine particles (11.4 μm mean size), and bubbles less than 100 microns in diameter. This discrepancy may be linked to the fact that Weber and Paddock's equation is strictly valid only for spheres of $D_p/D_b < 0.1$.

Considering the significantly increasing value of P_c and P with decreasing bubble size, one would expect a corresponding increase in flotation rate. Brown (1965) stated simply that an increase in the number of bubbles and a decrease in bubble size, for a given air rate, gives an increase in the rate of coal flotation. Other investigators have shown for different flotation systems that

$$k \propto \frac{1}{D_b^m} \quad [3]$$

where k is the flotation rate constant, D_b is bubble diameter,

and m is a constant for a given system. Reay and Ratcliff (1975) showed that $m = -2.9$ for the flotation of quartz beads using bubbles less than 100 microns in diameter, while Bennett et al (1958) carried out conventional coal flotation experiments to obtain $m = -2.0$ to -2.5 for bubbles in the 300-450 micron range. Taken collectively, these equations concerning the probability of collision of particle and bubble and the flotation rate constant, strongly suggest smaller bubbles will improve flotation rate.

Yoon and Luttrell (1985) continued their work to also derive a mathematical relationship between bubble size and flotation rate. For flotation of particles in a cylindrical column, they derived that:

$$k = \frac{6PQ}{D_b D_c^2} \quad [4]$$

where k is the flotation rate constant, P is the probability of collection, Q is the volumetric flow rate of air, D_b is bubble diameter, and D_c is the diameter of the flotation cell. Assuming that with very hydrophic particles whose P_a values are unity, P can be approximated by P_c , and this flotation rate equation can be combined with Weber and Paddock's equation to yield that:

$$k = \frac{C_1}{D_b^3} \left(1 + \frac{1}{(C_2/D_b^{2.14}) + (C_3/D_b^{0.94})} \right) \quad [5]$$

where C_1 , C_2 and C_3 are constants for a given set of experimental conditions.

By taking the first derivative of the logarithm of this

equation, Yoon and Luttrell continued to show that the slope (m) of a log-log plot of k versus D_b is given by:

$$m = \frac{2.14x + 0.94z}{(x + y)^2 + (x + y)} - 3 \quad [6]$$

where

$$x = C_2 / D_b^{2.14}, \quad [7]$$

and

$$y = C_3 / D_b^{0.94}. \quad [8]$$

C_2 and C_3 are dependent upon liquid viscosity and the densities of the liquid and gas. Thus, the power relationship (m) between flotation rate (k) and bubble diameter (D_b) does indeed vary with bubble diameter. Yoon and Luttrell also conducted flotation experiments with a ROM coal (Elkhorn seam, 16% ash) using a specially designed column to test the validity of the equation. Using their experimental results, they plotted flotation rate constant (k) versus bubble diameter (D_b), and found the slope (m) to be in good agreement with that predicated with the equation. The experimentally derived k values were, however, significantly lower than those predicted by the equation. This was attributed to the Elkhorn coal having a probability of adhesion (P_a) of less than unity, which reduced the flotation rate.

The relationship derived by Yoon and Luttrell compares favorably with other calculations of m by both Reay and Ratcliff (1975) and Bennett et al (1958). For the flotation of quartz beads using bubbles less than 100 microns in diameter, Reay and Ratcliff showed that $m = -2.5$, while Yoon and Luttrell's

equation under these conditions calculates $m = -2.8$. Also Bennett, et al carried out conventional coal flotation experiments to obtain $m = -2.0$ to -2.5 for bubbles in the 300-450 micron range, while Yoon and Luttrell's equation under these conditions, calculates $m = -2.1$ to -2.3 .

Several techniques of generating fine bubbles and using them for flotation have been developed, including vacuum (or pressure release) flotation and electroflotation. The commercial application of these two techniques for coal flotation, however, is yet to be established. One process, employing very small bubbles used commercially in the metals industry, though, was the Trona flotation process used from 1944 to 1978 to recover lithium. It used porous carbon plates located in the bottom of the flotation cell to generate the bubbles (Roe, 1980). A process used currently in the coal industry is the Flotaire flotation cell developed by the Deister Concentrator Company, Inc. This process uses aspirators to produce small bubbles, of which the size distribution is not known. United Coal Company has found this cell to work particularly well on coarser (+100 mesh) size fractions (Burgess, 1986). Quite fundamentally, it should be noted that Bechtel National, Inc. and Energy International, Inc. are currently jointly developing a commercial microbubble flotation system (Miller, 1986) separate of this work. Humboldt Wedag is currently marketing this pneumatic type flotation cell which shows some promise in cleaning ultrafines, but again,

the size distribution of the bubbles is not known. The bubbles are formed by passing the conditioned coal slurry through a "porous element." The Pittston Coal Group has recently purchased one of these systems for a 6400 g.p.m. flotation circuit (Snoby, 1986).

III. Objectives

The objectives of this work were 1) to develop and refine laboratory flotation techniques using microbubbles; 2) to compare flotation using the microbubbles with conventional flotation with several Appalachian coals; and 3) to generally investigate the effect of bubble size on coal flotation.

Success of this work could encourage further research into flotation using microbubbles and conceivably lead to a scale-up of the process, i.e. development of a pilot plant to conduct continuous tests.

EXPERIMENTAL

I. Materials

A. Collection and Storage of Coal Samples

Several Appalachian coal companies were contacted and asked to supply us with coals with which they were having particular problems in cleaning the fines. Table I lists the coal samples used in this work, the preparation plant from which it came, and its approximate feed ash.

The Jawbone coal sample was picked up at Clinchfield Coal Company's Central Lab, having been sampled R-O-M by Clinchfield at the Hurricane Creek Mine. The Eagle coal sample was picked up at the laboratory of United Coal Company's Wellmore No. 7 and No. 8 plants, having been sampled R-O-M by United off an incoming truck. The Taggart coal sample was picked up sealed in plastic bags at Westmoreland's Bullit plant. This sample was taken by Westmoreland off the plant feed belt, having already been crushed to -10 mesh. Each sample was sealed under nitrogen at the pick up site in an attempt to minimize further oxidation and transported to Blacksburg. The R & F Coal Company's composite sample of three seams was taken at their plant in Cadiz, Ohio and was shipped to Blacksburg sealed in plastic bags. Upon reaching the laboratory, all samples were sealed under nitrogen

in a modified pickle bucket (fast food type) until preparation for experimental work.

B. Sample Preparation

The Jawbone sample, used in the microflotation tests, was crushed and screened to obtain a -1/4 inch +10 mesh fraction, which was subsequently cleaned of its ash by heavy medium separation at a specific gravity of 1.30. Magnetite was used as the dense medium, and care was taken to remove the magnetite particles from the clean coal sample by repeated washings with water. The clean coal sample was crushed and pulverized with a microanalytical mill (Tekmar A-10). Each size fraction, thus obtained, was stored in a sample vial and stored in a vacuum desiccator over silica gel.

The Eagle and R & F samples were riffled and portions were hammer-milled to -100 mesh. These crushed samples were riffled into 200-gram lots, sealed in zip-loc bags, and stored in a freezer. For flotation tests on ultrafine particles, some of the -100 mesh Eagle samples were wet-ground for four hours in the 200-gram lots in a pebble mill (12-inch diameter). The pulverized coal was filtered, and the filter cake was divided into 25-gram lots for microbubble flotation tests. Other samples of the -100 mesh Eagle coal were pulverized for kinetics tests using an attrition mill. The mill consisted of a set of steel blades mounted on the

impeller of a Wemco flotation machine. The coal was ground in 100-gram lots in a one-liter cell containing assorted small steel balls and 200 milliliters of water.

The Taggart sample was riffled and a portion hammer-milled to -100 mesh. This portion was pulverized to -400 mesh using an air-jet mill, riffled into 200-gram lots, sealed in zip-loc bags, and stored in the freezer.

C. Reagents

The reagents used in this work and the source of each are shown in Table II. Blacksburg tap water was used for the grinding and for the flotation tests.

II. Equipment

A. Microflotation Apparatus

As the sizes above and below which flotation become difficult are rather nebulous values, it was attempted to determine the flotation characteristics of a clean coal as a function of particle size. The microflotation apparatus used for this is shown in Figure 1. The glass flotation cell has design features similar to the Flotaire cell, although with the microflotation cell, only 350 ml of water are used. In this work, a "medium" porosity frit was used

to generate the bubbles and a 3-gram coal sample was used in each flotation test.

B. Microbubble Generators

Several means of generating microbubbles exist. Unlike with bubble generators in which the bubbles grow to a certain size and then break free, microbubbles are sheared off from their nucleation sites as they grow. Sebba has developed (1971) and patented (1975) a technique in which the microbubbles are formed by rapidly passing a stream of surfactant solution through a venturi throat at which point gas is admitted. A simple design of a microbubble generator using this principle is a modification of a glass aspirator, shown in Figure 2. In order to ensure that the bubbles formed are small, it is helpful to slightly roughen the touching edges of the ground glass joint. Although the venturi conditions of increased velocity and reduced pressure tend to draw gas into the liquid, the gap in the joint is very tight, and the gas must be introduced under pressure. By trial and error, it is possible to determine the correct pressure for any particular aspirator. A number of aspirators with differing sized glass joints were constructed and tested in an attempt to produce the smallest and most proficient microbubbles possible. A ground glass joint having a gap "the width of a rolling paper" and operated at a pressure

of 20 psi, was found to work quite well and was used for the majority of this work.

To get sufficient velocity for the liquid through the aspirator, a centrifugal pump must be employed. A flow rate of 10 liters/min has been found to produce satisfactory microbubbles (Sebba, 1971). A 1-hp pump (Eastern Model MDH-32) providing a water flow rate of 11 liters/min was used for the majority of this work. The entire apparatus used to generate microbubbles with the aspirator is shown in Figure 2. A cylinder of compressed nitrogen was hooked up in line with the aspirator to provide gas. Tygon tubing (1/2 inch I.D.) was used to conduit the surfactant solution, and a heat exchanger was employed to cool the system. A glass funnel was attached to the bottom of the tubing in the reservoir in order to minimize splashing and subsequent foaming. All stopcocks and valves were made of teflon.

The method of generating microbubbles using the glass aspirator could prove difficult to apply industrially, and as such, several other techniques were developed. It was found, for example, that microbubbles could be generated using an ordinary kitchen blender by agitating a surfactant solution at high speed. As is shown in Figure 3, after production, the microbubbles are drawn for use from the blender using a peristaltic pump.

C. Microbubble Flotation Cells

The two flotation cells used for the majority of this work are shown in Figure 4. The first is a glass squib-shaped separatory funnel having a volume of 1000 ml. The second employs a glass cylindro-conical section having a volume of 1790 ml and a plexiglass catch pan. Teflon stopcocks were used with both of the cells. With the separatory funnel, froth and refuse were each drained through the bottom opening. The cylindro-conical cell had a stopcock located on the side of the flotation column which was used to flood the froth over into the catch pan with minimal disturbance of the froth and the pulp. In this work, the separatory funnel was used mostly with blender-generated microbubbles, while the cylindro-conical cell was used mostly with aspirator-generated microbubbles.

Another flotation cell, also shown in Figure 4, was used to conduct kinetic studies. It is also similar in design to the Flotaire cell, but the glass cylindro-conical section has a volume of only 1000 ml, and the plexiglass catch pan is sloped to allow rapid runoff of the froth into a beaker. When used with the microbubbles, the tygon tubing from the aspirator apparatus was simply clamped on. A valve was placed in this line at the bottom of the cell to prevent coal slurry from leaving the cell. This valve was opened

to inject microbubbles. When comparative tests were performed with this cell, the microbubble line was detached and in its place a fritted glass tube (attached to a compressed gas line) was clamped on. A three-way valve in the gas line allowed the gas flow to be stabilized and then switched to a dummy cell while preparing the coal slurry in the flotation cell.

D. Automated Conventional Flotation Machine

A commercial laboratory flotation machine (Denver Model D-12) was automated to perform comparative tests. The design allowed for independent control of impeller speed, froth removal rate, air flow rate, and pulp level. Details of its construction and performance may be found with Luttrell (1983). A schematic of this machine is shown in Figure 5.

III. Procedures

A. Microflotation Tests

Using the apparatus shown in Figure 1, the three-way stopcock was opened to the empty flotation cell for a minute and then switched to the dummy cell. Approximately 20 ml of double-distilled water was introduced into the flotation cell. After adding three grams of coal sample, 1 lb/ton

of MIBC was added (when used), and the coal suspension was agitated by means of a glass rod. More water was carefully added to fill the remaining volume (350 ml) of the cell. The gas flow rate was adjusted to 20 ml/min by means of a Gilmont flow control valve through the dummy cell before switching the three-way stopcock to the flotation cell to begin flotation. After 20 seconds of flotation time, the float and sink products were filtered, dried, and weighed to determine the floatability.

B. Microbubble Generation

The apparatus used to generate microbubbles with the aspirator is shown in Figure 2. Initially, the cooling water for the heat exchanger was turned on. With all stopcocks closed, a measured volume (usually 1500-2000 ml) of frother solution was poured into the reservoir and the pump was turned on. The valve on the nitrogen tank was then opened and the gas pressure was adjusted to the desired level. With the microbubble solution circulating, stopcock A was intermittently opened and the sides of the reservoir were washed down and the foam on the top of the solution dispersed. After a uniform flow of stable microbubbles was established (usually 2-4 minutes), stopcock A was opened and the microbubble solution was pumped through the attached 1/4 I.D. tygon tubing for use. After each generation of

microbubbles, stopcocks B and C were opened and the system was drained and then thoroughly rinsed with tap water.

When generating microbubbles using the blender technique, a measured volume (usually 300 ml) of frother solution was first poured into the blender. This was then agitated at the highest speed until stable microbubbles were produced (usually 1-3 minutes). The valve (Figure 3) to the attached 1/4 I.D. tygon tubing was then opened, and the microbubble solution was pumped with a peristaltic pump for use. Between each generation of microbubbles, the blender and pump were thoroughly rinsed with tap water.

C. Microbubble Stability Measurements

To assess the stability of microbubbles, the following method was employed. When using the aspirator technique, microbubbles were generated as described previously and a predetermined volume of the microbubble solution was injected into a graduated cylinder. With the blender-generated microbubbles, a volume of the microbubble solution was transferred via the peristaltic pump into the cylinder. As the bubbles rose in the cylinder, a nebulous rising boundary separating the clear solution from the cloudy microbubble solution was observed. The time required for this boundary to reach finite volumes was recorded, and the two were plotted against each other.

D. Microbubble Flotation Tests

Prior to flotation, the coal samples were conditioned. The sample (usually 20 to 25 grams) was first wetted by placing it and 300 ml of tap water in a blender and agitating both for four minutes. A volume of kerosene or #2 diesel fuel was then added with a microliter syringe and conditioning continued for an additional four minutes. The top and sides of the blender were washed down at each two minute intervals throughout the process to ensure that all the sample was conditioned. After conditioning, the slurry was poured into the flotation cell.

Microbubbles were generated and pumped to the flotation cell as described previously. After injection of the bubbles, the mixture was allowed to stand for at least five minutes during which time the bubbles levitated the coal particles and the refuse settled to the bottom. When using the Flotaire-type cell, care was taken to ensure that the froth level would be above the point of flood water addition so that the froth would not be disturbed when this water was added. When doing a two-stage test, the refuse was drained, and the froth was repulped vigorously within the cell with a stirring rod. Additional microbubbles were then generated and the single-stage flotation procedure employed again.

The products obtained from each of the flotation tests were filtered, dried, weighed, and assayed for ash following

the general procedure described in ASTM 271.

E. Conventional Flotation Tests

Each test was conducted on a 100-gram coal sample in a 2-liter flotation cell using tap water. The pulp was agitated at 1000 rpm for four minutes to wet the sample. (An exception to this was that the -400 mesh Taggart sample was conditioned for fifteen minutes.) A volume of kerosene was then added and conditioning continued for four minutes. A known amount of frother was added and the pulp was further conditioned for another minute. Flotation commenced upon opening the air valve to provide 4.5 l/min of air. The froth was collected for 2.5 minutes in both the first and the second stages. Between cleanings, the froth was repulped within the flotation cell and additional frother (when used) added. The flotation products were filtered, dried, and assayed for ash (ASTM 271).

Several of these operating procedures were altered when testing the ball-milled Eagle sample; a 200-gram sample was used, it was wetted for six minutes and conditioned for four minutes, and the froth was collected for only one minute in each stage. The other procedures remained the same.

F. Kinetics Flotation Tests

In an attempt to examine the effect of bubble size on flotation rate, flotation tests were conducted using bubbles of different size distributions. Using the cell shown in Figure 4, initially a standard aspirator microbubble test was conducted. The flow rate of microbubble suspension and gas composition were determined by injecting microbubble solution into a graduated cylinder for a given period. After injection, the bubbles rose to the surface, leaving a clear solution. The difference between the initial and final volumes was taken as the gas volume. An equivalent gas flow rate was then calculated by multiplying the volume flow rate of the microbubble suspension by the volume fraction of gas in the suspension.

After completion of the microbubble flotation test, the microbubble line was detached from the cell. So that larger bubbles could then be produced, a fritted glass tube was attached to the bottom of the cell and connected in line with the compressed nitrogen.

The flotation cell was then filled with water and the gas flow rate to it was stabilized at the desired setting. The flow was then directed to a dummy cell and some of the water was siphoned out of the flotation cell. Frother was added to the cell, the conditioned coal was poured in, the pulp was stirred for several minutes, and the pulp level

was adjusted. The gas flow rate was then switched back to the cell, and flotation was initiated. During flotation, the catch pan was continuously washed down and the froth was trickled into the cell during flotation through the flood water valve.

IV. Results

A. Microflotation Tests

Figure 6 shows the results of the flotation tests conducted with and without using a frother (MIBC). When no frother was used, the maximum floatability was only about 80%. The use of a frother improved the floatability to nearly 100%, but the effective flotation range in terms of particle size did not change significantly. Note that the coal flotation began to deteriorate above 48 mesh (295 microns) and below 200 mesh (74 microns). This finding is consistent with general coal preparation practice.

B. Microbubble Stability Measurements

Effect of Frothers: Stability tests were conducted on both aspirator- and blender-generated microbubbles using several frothers. Figure 7 shows the stability of bubbles generated using the aspirator technique and the 1-hp pump with frother

concentrations of 1 ml/l. Dowfroth M150 produced the most stable suspension and, presumably, the smallest bubbles, while MIBC produced the least stable. Dowfroth 400 and 250 had approximately the same stability followed by Dowfroth 200.

Figure 8 shows the stability of bubbles generated by the blender technique, also using different frothers. Although not shown, attempts were made to generate microbubbles with pine oil and Dowfroth M210, but these suspensions were not at all stable. As is shown, MIBC produced a much less stable suspension than the Dowfroth frothers. Among the Dowfroth homologues, DF E1128 generated the most stable bubbles. Silicone L7001 and Tergitol TMN-6 also produced very stable bubbles. To generalize, it would seem that the higher the molecular weight of the frother, the more stable the micro-bubble suspension. A problem arises, however, when using longer-chained frothers for coal flotation as these frothers tend to float ash particles.

Tests were also conducted varying the frother (Dowfroth 400) concentration from 0.1 to 8 ml/l. Bubble stability was found to increase slightly with increasing concentration. Similar tests were performed with MIBC, but it was found that this reagent did not produce stable bubbles even at high concentrations.

Effect of pH: The effect of pH on bubble stability was also investigated. The bubbles were prepared by the blender tech-

nique using 0.15 ml/l of Dowfroth M150. The results are shown in Figure 30 adjacent to the flotation results. As shown, stability increased substantially with increasing pH up to pH about 9 and then levels off. At high pH, it was observed that a great deal of foaming occurred in the cylinder. Almost all of the present work was done at neutral pH.

Type of Microbubble Generator: In the initial stability work done by Sebba, microbubbles were generated by the aspirator technique using a 1/3 hp motor. Hoping that a more powerful pump could produce more stable bubbles, a 1-hp pump was used in this work. It was found that slightly more stable bubbles could be produced with the larger pump. In addition, microbubbles generated using the blender technique were found to be at least as stable as those generated with the 1-hp pump.

Effect of Temperature: After generating microbubbles for more than several (say, five) minutes, the stability of the bubbles began to decrease. This was most likely due to the rising temperature of the microbubble solution. Sebba (1982) notes that when the temperature of the solution reaches approximately 60°C, the bubbles have grown so large that even stirring will not keep them in suspension. Because of the loss of stability with the rising temperature, a heat exchanger was incorporated into the recycling system.

Effect of Volume of Solution: Using the aspirator apparatus, it was observed that, generally, the less the volume of solution recirculated (until pump cavitation began), the more dense the microbubbles. Yoon and Miller (1980) noted a similar effect in a preliminary investigation. This observation was more evident when a low gas pressure was used with the aspirator technique. Stability tests conducted on M150-generated microbubbles confirmed this observation. When using the blender to generate microbubbles, it was found that the higher the impeller speed of the blender, the more stable the bubbles generated. It appears the size of the bubbles depends upon the speed at which the bubbles are sheared off. The density of the bubbles seems to depend on the gas pressure and the volume of solution.

It was also observed that when some of the solution was recirculated directly back to the reservoir, bypassing the aspirator, better microbubbles were produced. A reason for this is that the injected solution helped break the foam and stir the solution in the reservoir. Sebba (1982) showed the life of the microbubbles could be significantly lengthened by simply agitating the microbubble solution (and lengthening the distance the bubble must traverse before reaching the surface).

C. Microbubble Flotation Tests

A great number of microbubble flotation tests were conducted using both the blender and the aspirator techniques with varied frother and collector combinations, pulp density, pH, and experimental operating methods. This work was done on different size fractions of several Appalachian coals.

Although not given for all the tests shown in the following figures, material balance sheets and reagent calculations were performed for each test. The reagent calculations are based upon the weight of the feed sample as it appeared in the balance sheet.

Effect of Frothers: In an attempt to find the most suitable frother for microbubble flotation of the coals used, several frothers were tested.

Figure 9 shows the results of flotation tests conducted on the Eagle coal (-100 mesh) using microbubbles generated with the blender technique with varying amounts of Aerofroth 73. As shown, a clean coal containing less than 8% ash was obtained, but even with reagent consumption as high as 25 lb/ton, a yield of only 36% was achieved. This indicates that Aerofroth 73 does not have collecting properties with this sample.

The next series of experiments were conducted using pine oil, and the results are shown in Figure 10. A maximum

yield of 38% was obtained at approximately 12 lb/ton of pine oil, with a corresponding clean coal content of 9%. It was found that increasing the frother addition beyond this point resulted in poor yields, due to the low stability of these microbubbles.

Similar sets of tests were made on the Eagle coal (-100 mesh) using 3 lb/ton of kerosene with Dowfroth M210, Dowfroth E1128, and Tergitol TMN-6. These results are shown in Figures 11, 12 and 13, respectively. Dowfroth M210 gave the poorest results with yields no higher than 13% and ash contents no less than 9%. This may be attributed to the extremely poor microbubbles produced with this reagent. On the contrary, Dowfroth E1128 produced some of the most stable microbubbles (Figure 12), and as a consequence, the yield was as high as 73%. The clean coal products contained relatively high ash, however, when more than 10 lb/ton of the frother was used. As mentioned previously, a primary problem of using longer-chained frothers such as Dowfroth E1128 and Tergitol TMN-6 for coal flotation is that they do float ash particles. Tergitol TMN-6 also produced very stable microbubbles (Figure 13) and achieved a maximum yield of 69% at 10 lb/ton. At higher frother additions, however, this yield decreased substantially. A possible explanation for this is the frother molecules may be inversely oriented in the second absorbed layer with their hydrophilic polar groups pointing toward the aqueous phase. Another possible explanation is

the excess frother molecules may act as a detergent and remove absorbed kerosene from the coal surface.

Figure 14 represents the results obtained with the R & F coal (-100 mesh) using 3 lb/ton of kerosene and varying amounts of Silicone L7001. According to the stability measurements, this frother produces the most stable microbubbles. As a result, high yields were obtained, but the froth product also contained high ash.

The next few series of experiments were conducted using MIBC. Figure 15 shows the results obtained with the Eagle coal (-100 mesh) using 1 lb/ton of kerosene and varying amounts of MIBC. In these tests, the microbubbles were produced using the aspirator technique. The maximum yield achieved was 24% at 6.3 lb/ton of frother, but the ash content of the clean coal was as low as 7%.

Hoping to increase the yield with MIBC, the next series using the Eagle coal was conducted using 3 lb/ton of kerosene. The aspirator technique was used and the results are shown in Figure 16. Even with frother additions as high as 21 lb/ton, a yield of only 43% was obtained. At this yield, the ash content of the clean coal was 10%.

A series was also conducted on the -400 mesh Taggart coal using microbubbles generated with MIBC and is shown in Figure 17. Bubbles were produced by the aspirator technique and the coal was conditioned with 5 lb/ton of kerosene. Although cleaning the coal to less than 15% ash (from 46%

ash in the feed) in one stage, the maximum yield achieved was only 41%. This was the case even with a frother addition of up to 54 lb/ton.

More promising flotation results were obtained with Dowfroth M150. This reagent is less selective than MIBC, but gives respectable yields. Figure 18 shows the results of two series of flotation tests conducted on the Eagle coal (-100 mesh) using 1 lb/ton of kerosene and varying amounts of frother. The microbubbles were produced by the blender technique. In one series, a total of 300 ml of solution was injected into the flotation cell, and in the other, 500 ml of solution was used. It should be noted that the microbubbles of the former series (300 ml) were more stable than those of the latter since (at given lb/ton addition) the frother solutions were at a higher concentration.

These two sets of experiments produced somewhat different results. The yields were higher by about 5% with 300 ml of microbubble solution, but the ash contents of the clean coal products were significantly lower when 500 ml of solution was used. For example, at 2 lb/ton of Dowfroth M150, the clean product obtained with 500 ml of solution contained approximately 8% lower ash than that obtained with 300 ml of solution. This suggests that when using a less stable microbubble solution, mechanical entrapment is less likely to occur, which explains why MIBC has proven to be the most selective frother.

Similar series were performed on the -100 mesh Eagle coal using the aspirator technique. In these series, the coal was conditioned with 3 lb/ton of kerosene. As shown in Figure 19, when injecting a volume greater than 400 ml, as opposed to a volume of 400 ml or less, improvement is noted in both yield and ash content in the clean coal. When injecting greater than 400 ml, a yield of 64% with a clean coal ash of 15% is achieved. With less than 400 ml, the highest yield obtained was 57% with a corresponding ash of 18%.

These findings suggest that when injecting a smaller volume of more concentrated bubbles, the bubbles rise as "clouds " entrapping ash particles. A more selective approach is to inject a larger volume of less concentrated bubbles. Why this gives a higher yield as well is not immediately clear. One explanation is that by adding the less concentrated solution over a longer period, a greater opportunity is provided for the coal particles to attach to the bubbles. At the same time, it may be possible to inject a large volume of too few bubbles. In a series conducted by injecting 1000 ml of solution, it was found that a loss of yield occurs at low (less than 3 lb/ton) frother additions. This was caused by the poor quality of microbubbles produced at these concentrations. The most effective method of microbubble flotation seems to be to concentrate the bubbles at an "adequate" concentration and then to closely

control the rate and density at which the bubbles are injected into the flotation cell.

Dowfroth M150 was also tested with the R & F coal (-100 mesh). The results, shown in Figure 20, were obtained by using 3 lb/ton of kerosene and microbubbles produced using the aspirator technique. A maximum yield of 87% was obtained at 6 lb/ton frother addition with 16% ash in the clean coal. The ash content remained relatively constant at frother additions higher than 1 lb/ton, while the yield increased steadily.

Several series were conducted on the -400 mesh Taggart coal using microbubbles generated with M150 by the aspirator technique. The first of these, shown in Figure 21, depicts single-stage tests conducted on coal conditioned with 5 lb/ton of kerosene. As expected, ash and yield increase with increasing frother addition. At a frother addition of 10 lb/ton, a yield of 62% with a clean coal ash of 21% was obtained. Upon examination of this curve, it was thought that two-stage cleaning could prove applicable to this sample. Figure 22 shows a series in which the coal was conditioned with 5 lb/ton of kerosene and floated in the first stage with 10 lb/ton of M150. The dosage of M150 in the second stage was varied. As shown, a considerable amount of ash can be rejected in the second stage. At a frother addition of 1.5 lb/ton in the second stage, the coal has been cleaned to 9% ash while maintaining a 45% yield. Another series,

shown in Figure 23, was conducted identical to this one, except that MIBC was used in the second stage. It was thought perhaps in this way that the yield could be maintained but with a reduction in the ash content. As it turned out, however, cleaner products were obtained, but with a loss in the yield. In one test, an identical result of 45% yield with 9% ash was obtained (identical to the M150 in the second stage), but it required 8 lb/ton of MIBC. At low MIBC additions, the yield dropped considerably. From these series, it appears that there is no distinct advantage to using these reagents in this manner.

Another approach attempted was the combined use of these two frothers in a single test in the hope of producing a synergistic effect. Figure 24 shows the results obtained by using 6 lb/ton of Dowfroth M150 and varying amounts of MIBC. The microbubbles were produced using the blender technique. The -100 mesh Eagle coal samples were conditioned with 6 lb/ton of kerosene. A comparison of these results with those obtained using 6 lb/ton of Dowfroth M150 produced a considerably lower ash (by about 2%) clean coal product. Further improvements were made when the MIBC was added to the coal during conditioning, as shown in Figure 25. Ash rejection was improved by about 2% with virtually no decrease in yields.

It appeared in these experiments the 6 lb/ton of Dowfroth M150 was overpowering any beneficial effect of the MIBC

addition, and thus, the next series of flotation tests were conducted with 6 lb/ton MIBC and varying amounts of Dowfroth M150. The Eagle coal (-100 mesh) was conditioned with 6 lb/ton of kerosene. The results are shown in Figure 26. Yields remained fairly constant when using more than 3 lb/ton of Dowfroth M150, while the ash content of the clean coal increased steadily with increasing Dowfroth M150 addition throughout the range tested. The ash content of the clean coal increased by 5% as the frother addition was increased from 1 to 6 lb/ton.

The next series of experiments were conducted on the same coal with only 3 lb/ton of Dowfroth M150 and varying amounts of MIBC. The collector addition was also reduced to 3 lb/ton. In an attempt to maintain respectable yields, however, the more powerful No. 2 diesel oil was used. Figure 27 gives the results. As compared to the results obtained with twice as much reagent addition (Figure 24), the froth products contained less ash with only a slight loss of yield. Encouraged by this improved selectivity, the next series of experiments were conducted with as little as 1 lb/ton of Dowfroth M150 and varying amounts of MIBC. As shown in Figure 28, the froth products assayed only 9% ash at the most, while maintaining 50% yields.

Effect of pH: Figure 29 represents the results of flotation tests conducted to investigate the effect of pH on the micro-

bubbles. The tests were made on the Eagle coal (-100 mesh) using 3 lb/ton of Dowfroth M150 and 3 lb/ton of kerosene. The coal samples were conditioned with kerosene at natural pH, and the microbubbles were prepared at various pH values using the blender technique. In general, the results agree with those of Zimmerman (1979) and Yoon (1984). The yield was relatively constant above a pH around 6, while the ash content of the clean coal increased substantially at alkaline pH values. These results coincide with the stability measurements conducted on the microbubbles at different pH values, as shown in Figure 30. At low pH, the bubbles produced with M150 are less stable and, as a result, the yield suffers. As bubble stability increases, so do the yield and the ash content of the clean coal. At high pH, where the bubbles are very stable, a high yield with a corresponding high ash content is obtained.

Effect of Collector Additions: To investigate the effect of collector additions, stable microbubbles were desired, and Dowfroth M150 was chosen as the frother.

Figure 31 shows the results of the two-stage flotation tests conducted on the Eagle coal (-100 mesh) as a function of kerosene addition. The microbubbles were generated with the aspirator technique, using 6 lb/ton of M150 in the first stage and 3 lb/ton in the second. A maximum yield of 72% was obtained at 6 lb/ton or more of kerosene. An approximate

loss of 5% in yield occurred with the second cleaning, but at the same time, the ash content of the clean coal was reduced by approximately 5-6%. Note that the ash content dropped significantly above 10 lb/ton of kerosene addition, which may indicate that an oil agglomeration mechanism begins to operate in this region.

A similar series of experiments was performed on the same sample using microbubbles produced by the blender technique. These results are shown in Figure 32. The loss of yield with the second stage flotation is considerably less in this series than that shown in Figure 31, as is the ash rejection. This may be attributed to a difference in experimental procedure: in the aspirator-generated microbubble flotation tests, a larger volume of less concentrated microbubbles was used with a lower pulp density in the flotation cell. This allowed for more selective flotation. Surprisingly, with the blender-generated microbubble flotation tests, the oil agglomeration effect is not evident at high kerosene additions.

Figure 33 gives the results of a series of flotation tests conducted on the Eagle coal (-100 mesh) using No. 2 diesel oil as the collector. Microbubbles were generated using the blender technique with 6 lb/ton of Dowfroth M150. As compared to the test results obtained using kerosene (Figure 32), slightly higher yields (by about 2-3%) were obtained with a concurrent increase in the ash content of

the clean coal. This suggests that No. 2 diesel oil is a more powerful collector than kerosene, and as such, selectivity is reduced. Like the blender-generated microbubble flotation tests using kerosene (Figure 32), no agglomeration effect was visible at higher collector additions, and, in fact, the ash content of the clean coal increased above 3 lb/ton. If tests had been conducted at kerosene additions higher than 40 lb/ton, however, the agglomeration effect might have become noticeable.

A similar series of flotation tests were conducted on the R & F coal sample (-100 mesh). These results are shown in Figure 34. Microbubbles were produced using the aspirator technique with 3 lb/ton of Dowfroth M150 in the first stage and 1.5 lb/ton in the second. As is shown, ash rejection improved 2-3% with the second stage of flotation.

Tests were also conducted on the -400 mesh Taggart coal and the results are shown in Figure 35. Bubbles were generated by the aspirator technique using 6 lb/ton of M150 in the first stage and 3 lb/ton in the second stage. As is shown, ash rejection improved considerably (by as much as 9%) with the second stage of flotation. As is also shown, even with no kerosene addition, after two cleanings a yield of 38% with an ash content of 12% is obtained. At and above a kerosene addition of 4.5 lb/ton, the yield plateaus at a value of roughly 46%.

In an attempt to reduce the collector consumption in

microbubble flotation, it was thought that the microbubbles themselves could be coated with the kerosene. As such, in the next two series, the kerosene was added to the blender in which the bubbles were being generated. Figure 36 shows the results obtained by using a total of 3 lb/ton of kerosene. In each experiment, different proportions of the kerosene were added directly to the coal during conditioning and to the microbubbles in the blender. The Eagle coal sample (-100 mesh) was used and Dowfroth M150 addition was kept constant at 6 lb/ton. A fairly uniform yield was obtained, but the ash content of the clean coal increased slightly when all of the 3 lb/ton of kerosene was added to the bubbles.

The next series of experiments were made by adding all of the kerosene to the microbubbles, again using the Eagle coal (-100 mesh) and 6 lb/ton of Dowfroth M150. With this series, shown in Figure 37, the kerosene addition was increased to a maximum of 30 lb/ton. Ash rejection improved progressively with increasing kerosene additions up to 20 lb/ton with only a slight loss of yield. At higher dosages, both the yield and the ash of the clean coal increased. It is possible that by coating the microbubbles with such large amounts of kerosene, the bubbles by "bridge" together and rise as a mass, entrapping ash particles.

Effect of Pulp Density: As a means of minimizing the ash entrapment problem, flotation tests were conducted at varied

pulp densities. In both series, the pulp density was varied by altering the weight of the -400 mesh Taggart feed sample. Bubbles were generated by the aspirator technique using Dowfroth M150 and the coal was conditioned with 5 lb/ton of kerosene. The pulp density for these tests is defined as that in the cell prior to the injection of any microbubble solution.

In the first series, shown in Figure 38, 500 ml of a .10 ml/l microbubble solution was injected in the first stage of each test, and in the second stage, 500 ml of a .05 ml/l solution was injected. The sample size was varied from 15 to 50 grams in this series of tests. In this way, the frother addition in terms of lb/ton varied in each test. As shown, the yield increased and the ash of the clean coal decreased with decreasing pulp density. This result is similar to that obtained when injecting different volumes of microbubbles (Figure 19). Two explanations may be given for the increase in yield with decreasing pulp density. The first is that with a given volume of M150, as in this series, its collecting properties become more evident as the total surface area (the sample size) decreases. The second explanation is that with a given volume of bubbles, as in this series, and with a decreasing number of particles with decreasing pulp density, there are more bubbles per particle in the cell. This reduces the probability of bubble overloading which would in turn increase the recovery. The

improvement in ash rejection with decreasing pulp density may be explained in that with more dispersed solids in the cell, mechanical entrapment of ash is less likely to occur.

In the second series, shown in Figure 39, the frother addition in terms of lb/ton was kept constant for each test. Again, 500 ml of microbubble solution was injected in each stage, but the concentration of the solution was varied such that 4 lb/ton of M150 was injected in the first stage and 2 lb/ton was injected in the second. Using this approach, the effect of pulp density is shown even more dramatically. With this series, the optimum pulp density appears to be about 3%. At pulp densities less than this, a loss of yield occurs due to decreased bubble stability. At higher pulp densities, ash is entrapped into the clean coal. Brown (1962) showed yield to generally increase with increasing pulp density. The loss of yield which occurs at high pulp densities in this series may be due to saturation of the bubbles with particles, or "inhibited" flotation. This would suggest the number of bubbles produced as concentration increases (in this concentration range) is not capable of picking up a proportionate increase in the number of particles. These findings are consistent with those flotation tests in which the volume of injected solution was varied, in that both indicate for batch microbubble tests both an optimum volume and an optimum concentration of injected microbubble solution exists.

Almost all of the microbubble flotation tests conducted in this work were done at a pulp density of approximately 3%. This figure concurs with industrial practice, as Aplan (1976) reports the percent solids in the U.S. to average 3-4% for coal flotation.

Effect of Settling Time: After injection of the microbubbles into the flotation cell, a period of time elapsed during which the microbubbles levitated the coal particles while the ash particles settled to the bottom. Two series of flotation tests were performed in which this settling time was varied. Both are shown in Figure 40. In both series, the -100 mesh Eagle coal was conditioned with 3 lb/ton of kerosene. In one series, the microbubbles were generated with 3 lb/ton MIBC, while in the other series, 6 lb/ton was used. As shown, there is little difference between the two sets of tests. For both series, yields ranged from 17-22% and the ash in the clean coal ranged from 4-6%. It was shown, however, that the ash in the froth products decreased with passing time. From a time period of 2-20 minutes, this ash decreased an average of 1% (from 5.5 to 4.5%) with virtually no loss of yield. (A settling time of at least 5 minutes was used for almost all of the microbubble work.) This reduction in ash could be attributed to the drainage of liquid lamellae between the bubbles which took loosely held ash particles from the froth. Yoon (1984) showed that

the ash content of a microbubble froth with the Pittsburgh No. 8 seam increased by about 1% (from 4-5%) as froth depth increased (the top 3.4 cm assayed 4% ash while the bottom 2 cm assayed 5% ash). Considering these findings and being aware of the tenacious stability of the microbubble froth (it can stand for days), it may be possible to spray or launder the froth and free entrapped ash particles. This could further improve the selectivity of the microbubble flotation process.

Effect of Particle Size: Figure 41 represents the results of the flotation tests conducted on various size fractions of the Eagle coal as obtained by dry screening. The microbubbles were produced by the aspirator technique using 6 lb/ton of Dowfroth M150 and each coal sample was conditioned with 3 lb/ton of kerosene. As shown, the yield decreased below 200 mesh. The improvement in ash rejection between 75 and 40 microns could be due to improved liberation of ash particles from the coal and also to the fact that when yields are low, the more floatable coal particles are those floated. The increasing ash content below 40 microns may be ascribed to the fact that the feed ash was higher in this size range. Another important reason is likely that the probability of ash entrainment increases with decreasing particle size.

In order to demonstrate the beneficial effect of using

microbubbles for ultrafine particle flotation, tests were made with Eagle coal samples wet-ground for 4 hours in a pebble mill. Wet-screen analysis revealed that 99% of the sample, thus prepared, passed a 400 mesh screen. The flotation tests were made using bubbles generated by the aspirator technique. Each test was made using 6 lb/ton of Dowfroth M150 and a varying amount of kerosene. This series is shown in Figure 42. A maximum yield of approximately 70% was obtained when using more than 8 lb/ton of kerosene. The best results were obtained when 8-14 lb/ton of kerosene was used. Under these conditions, the ash content of the clean coal was as low as 11%, with only one cleaning. This compares with an ash content of 16% and a yield of 71% when cleaning the -100 mesh Eagle coal in one stage microbubble flotation. Ten lb/ton of kerosene and 6 lb/ton of M150 were used in this test on the -100 mesh coal. Collectively, these results demonstrate it is possible to more thoroughly clean a coal by crushing it to finer sizes and liberating the ash from the coal. By crushing a coal to such sizes and then cleaning it repeatedly by flotation, it may be possible to produce a very clean coal.

D. Conventional Versus Microbubble Flotation Tests

In order to compare microbubble flotation with the conventional flotation process, several tests were conducted

with the automated Denver machine.

A series of such conventional tests were conducted on the -100 mesh Eagle coal. The samples were conditioned with 3 lb/ton of kerosene. The amount of Dowfroth M150 was varied in the first stage, while no frother was added in the second stage. The best of these tests (one using 2 lb/ton of M150 in the first stage) is shown in Table III, along with two comparable microbubble tests. In the first microbubble test, 4.2 lb/ton of M150 was used in the first stage and 1.9 lb/ton in the second stage. As can be seen, the conventional test cleaned the coal to a lower ash content (7.8% ash compared to 10.3% ash obtained with the microbubble test), while the microbubble test had a higher yield (61.4% compared to 59.2% obtained with the conventional test). Another comparative microbubble test of interest shown is one using the blender technique in which the coal was conditioned with 2.7 lb/ton of No. 2 diesel fuel, and 1.0 lb/ton of M150 and 5.6 lb/ton of MIBC were used in only a single stage flotation. In this test, a yield of 49.4% resulted with a corresponding clean coal ash of 8.6 %. In this test, the coal was cleaned almost as well in a single stage microbubble test as in the two stage conventional test, but did experience a loss in yield of roughly 10%.

Table IV depicts comparative conventional and microbubble tests conducted on the -100 mesh R & F coal. In both tests, the coal was conditioned with 3 lb/ton of kerosene. M150

additions were 1.0 lb/ton in the first stage and none in the second stage in the conventional test, and 3.2 lb/ton and 1.7 lb/ton, respectively, in the microbubble test. Again, the conventional technique cleaned the coal to a lower ash content. After two cleanings, the froth obtained with the conventional technique assayed 12.3% ash, while the microbubble froth assayed 14.6% ash. As evidenced by these tests, this coal is indeed a difficult one to clean. The microbubble test obtained higher yields than the conventional test by 4.7% in the first stage and 1.7% in the second stage.

Upon reviewing the comparative microbubble and conventional tests with the -100 mesh Eagle and R & F samples, it seemed that there were no improvements in selectivity when using microbubbles to clean coals of this size fraction. The conventional technique cleaned both these -100 mesh coals to a lower ash content and maintained yields nearly as high as those obtained with the microbubbles. In addition, the conventional technique required considerably less frother than did the microbubble technique. As such, conventional tests were next conducted on finer size fractions to determine if any advantages existed in using the microbubble technique to clean these coals.

Table V shows results of conventional and microbubble tests conducted on the -400 mesh Taggart coal. The coal in both tests was conditioned with 5 lb/ton of kerosene. In the conventional test, 1.0 lb/ton of M150 was used in

the first stage and 0.3 lb/ton in the second stage, while in the microbubble test, 4.6 lb/ton of M150 was used in the first stage and 2.3 lb/ton in the second. This particular conventional test was chosen from two series of conventional tests conducted on the -400 Taggart coal, shown in Figures 43 and 44. Figure 43 depicts a series in which M150 addition in the first stage was varied from 0.3 lb/ton to 2.0 lb/ton, with no M150 addition in the second stage. Figure 44 shows a series in which 1.0 lb/ton of M150 was used in the first stage and M150 addition in the second stage was varied from none to 0.5 lb/ton. The "best" of these tests is used for comparative purposes. As shown in Table V, both the conventional and microbubble tests cleaned the coal roughly as well (7.8 % ash after two cleanings in the conventional test compared to 8.2% ash after two cleanings in the microbubble test), while the microbubble test produced considerable higher yields (by 9.5% after one cleaning and by 5.5% after the second cleaning). It appears that as particle size becomes smaller, the benefits of microbubbles become more evident (at least with the Taggart coal), both in terms of recovery and selectivity.

Conventional tests were also conducted on the ball-milled Eagle coal. One lb/ton of M150 was added in the first stage, with no frother addition in the second stage. Table VI shows one of these tests, one in which the coal was conditioned with 12.3 lb/ton of kerosene, and along

with it, a comparative microbubble test. In the microbubble test, the coal was conditioned with 12.6 lb/ton of kerosene and floated in a single stage with 6.8 lb/ton M150. Such large amounts of kerosene were used in these tests to ensure that respectable yields could be obtained with such ultrafine coal. After the first cleaning with the conventional technique, the clean coal assayed 20.6% ash with a yield of 72.3%. With the second cleaning, the clean coal assayed 21.8% with a corresponding yield of 51.9%. As can be seen, the ash content of the clean coal actually increased with the second cleaning. According to K. Miller (personal correspondence with Yoon), this lack of selectivity in the second cleaning is not an uncommon occurrence when attempting to float ultrafine coals. With the microbubble technique, however, in one stage flotation, the coal was cleaned to 12.0% ash with a yield of 70.2%.

This indicates that with ultrafine coals (the median particle size of this coal was less than 10 microns), microbubble flotation shows definite advantage. Yields obtained after one stage flotation with the microbubble and conventional technique were comparable (70.2% and 72.3%, respectively), while the microbubble process showed significantly better selectivity (12.0% ash in the clean coal with microbubbles compared to 20.6% ash in the clean coal with the conventional process). The reason that the yields obtained with the microbubble and conventional tests were comparable may be

that a great deal of entrained material floated in the conventional test. It should be noted that the second cleaning of this coal using the conventional process showed virtually no selectivity.

E. Effect of Bubble Size on Flotation Kinetics

Two series of kinetics tests using bubbles of different sizes were conducted on the Eagle coal. In the first, -100 mesh coal was used as is, while in the second, the -100 mesh sample was attrition-ground to -500 mesh. Each 20-gram flotation sample was conditioned with 3 lb/ton of kerosene. Microbubbles were generated using the aspirator technique at a concentration of 0.082 ml/l of Dowfroth M150.

To generate bubbles of different sizes, frits having porosities of 145-175 microns and 4-8 microns, were used. The results obtained with these bubbles were compared with those obtained with microbubbles. In the series with -100 mesh coal, 330 ml of microbubble solution (7.8% gas) was injected over a period of 37 seconds. The amount of gas injected into the coal slurry in this manner corresponded with a gas flow of 42 ml per minute over the entire test. In the series with -500 mesh material, 360 ml of solution was injected also over 37 seconds, which was equivalent to a gas flow of 46 ml per minute.

Note that when performing a microbubble test, the bubbles

were injected for only 37 seconds, while when producing bubbles with the frits, bubbles were generated the duration of the test. As such, the total volume of gas used with the frits was much larger than in the microbubble tests.

Figure 45 shows the results of the tests conducted on the -100 mesh samples. A comparison of the curves clearly demonstrates significant improvement in flotation rate as bubble size decreases. Upon examination of Figure 46, in which the cumulative ash of the float product is shown, it is evident, however, that the microbubbles produce a higher ash product. (Material balance sheets for each kinetics test is shown in the Appendix.) Rather surprisingly, the lowest ash product (17.0% after 6 minutes) was provided by the 4-8 um frit. Having the slowest kinetics, it was expected that the 145-175 um frit would produce the cleanest coal, but this was not the case. An explanation for this would be, however, that the bubbles produced by this frit were so large at this gas volume, that large amounts of ash were entrained in the wake of the rising bubble (Luttrell, 1985). The microbubbles, on the other hand, floated the coal very quickly and entrapped ash particles within the rising mass. For this size fraction of coal, say -100 mesh and this gas volume, bubbles in the range of those produced by the 4-8 um frit appear to be optimum in terms of ash rejection. It may be possible, however, to produce a cleaner product by using diluted microbubbles. The test results

obtained with the -100 mesh coal show in summary that microbubbles provide greatly improved kinetics and recovery with an associated problem of entrapped ash, while bubbles in the size range of that produced by the 4-8 um frit provide the most selectivity.

The results of the kinetics tests on the -500 mesh samples are shown in Figure 47. With this coal, the slopes of the curves are much reduced compared to those of Figure 45, indicating slower kinetics with the small particles. Reagent additions were identical in both series. Again the microbubbles provided faster flotation rates than did the larger bubbles.

An interesting finding from this series of tests with the ultrafine coal was that the froths obtained with the microbubbles contained (by 3.7% after 6 minutes) less ash than both of the other tests. The ash content of each timed out for these tests is shown in Figure 48, while the cumulative ash is shown in Figure 49. With this ultrafine coal, the larger bubbles generated by the frits showed virtually no selectivity. This strongly suggests that when using larger bubbles, ultrafine particles may be floated along with the bubbles by entrainment rather than by true flotation. It also suggests that when attempting to selectively float coal particles in this ultrafine size range, the bubbles must be very small. Although considerably more work is needed, the present results suggest that for the benefici-

ation of micronized coals, microbubble flotation may provide both improved kinetics and improved ash rejection as well.

DISCUSSION

The experimental phase of this work was done from September, 1980 through July, 1983, while much of this discussion was written in June and July, 1986. During the period from July, 1983 to July, 1986, much work was done to better understand the fundamentals of the microbubble flotation process (Yoon, 1984, Yoon et al, 1985, Yoon and Luttrell, 1985). During this period, the major finding of this work, i.e., improved recovery and selectivity of the microbubble process compared to the conventional flotation technique, has been further substantiated by other investigation at Virginia Tech. In addition, new techniques for applying microbubble flotation have been developed.

I. Microbubble Generation

Two methods were used in this work to generate microbubbles, i.e., the glass aspirator and the blender.

Using the aspirator, the bubbles are sheared from their nucleation sites by the flowing frother solution before they grow very large. It was found that an aspirator having a gap "the width of a rolling paper" and operated at a pressure of 20 psi produced good microbubbles. It was also found that by reducing the volume of circulating solution and by bypassing some of the solution around the aspirator and

using it to break the foam in the reservoir, more dense microbubbles could be produced. It seems the size of the bubbles depends upon the speed at which they are sheared off, while the density of the bubbles depends upon the volume of circulating solution. Along this line, it was also found that a 1-hp motor produced more stable microbubbles than did a 1/3 hp motor.

Using the blender technique, microbubbles may be similarly formed by either the shearing action of the impeller itself or by drawing air into the swirling vortex of the solution where the bubbles are pinched off and are formed by shear forces. It was found that more stable microbubbles could be generated with the blender by increasing the speed of the impeller. It was also found that microbubbles generated using the blender technique were at least as stable as those generated using the aspirator technique with the 1-hp motor.

The aspirator method of generating microbubbles would prove difficult to apply industrially, however, and as such, several other techniques in addition to the blender technique, have been developed. Details of these methods and their application to fine coal flotation may be found in the continued work of the coal preparation group at Virginia Tech.

II. Optimization of Microbubble Flotation

Concerning use of different frothers for microbubble

generation, it appears that generally the higher the molecular weight, the more stable the microbubble suspension (Figure 8). As far as flotation results are concerned, two nonionic frothers commonly used in industry, MIBC and Dowfroth M150, gave the best results. The use of MIBC gave relatively high selectivity with low yields, while the use of Dowfroth M150 produced high yields with a relatively higher ash content in the froth.

The molecular structure of MIBC (M.W. = 102) is represented by:

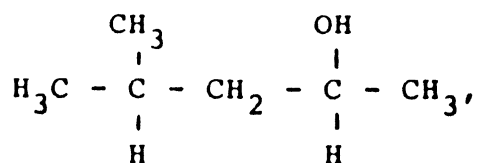

while the structure of Dowfroth M150 (M.W. = 400) is:

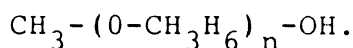

With M150, n is approximately 6, thus, the total number of carbon atoms in the M150 molecule is 19, while in the MIBC molecule, this number is 6. Reagents used in flotation usually possess hydrocarbon chains containing 6-20 carbon atoms (Yoon, 1984). Reagents with less than 6 carbon atoms do not exhibit enough surface activity, while those with more than 20 are too insoluble to be used for flotation.

Considering the large difference in the molecular weights of these frothers, one would expect that M150 would be more surface active than MIBC. Yoon (1984) conducted surface tension tests on the two frothers and showed this to be

the case. He further calculated the surface excess for the two frothers, each at a concentration of 50 mg/l, and showed M150 had a much higher surface excess than MIBC. The differences observed in the surface activities of the two frothers may account for 1) the more stable microbubbles and froth produced by M150 and 2) the higher flotation yields obtained using M150, although with a loss in selectivity. Yoon (1984) also showed that M150 solutions are more viscous than MIBC solutions. This suggests that a froth produced using M150 would be more tenacious and entrap more ash than a froth produced using MIBC.

Concerning the operating variables which control microbubble flotation, it should be noted that such factors as the volume and concentration of microbubbles injected and the pulp density in the cell play a great role in determining the effectiveness of the process. For example, as shown in Figure 19, improvements in both yield and selectivity at the same reagent usage can be realized by control of the volume of microbubbles injected. When injecting a concentrated volume of microbubbles in batch tests, the bubbles rise as a mass entrapping ash particles. Brown (1965) referred to this phenomenon as flotation "like a solid piston." At the same time, when injecting too large a volume of bubbles, a loss of yield occurs at low reagent additions due to the poor quality of the microbubbles. Using too high a pulp density in the cell (Figure 40) may result in a loss in selectivity

due to ash entrapment and a loss in yield due to "inhibited" flotation caused by overloading the bubbles. Too low a pulp density in the cell results in a loss in yield. The most effective means of microbubble flotation is to generate the bubbles at an "adequate" concentration and to control the rate and density at which the bubbles are injected into the flotation cell, while maintaining a pulp density of say 3%.

Concerning the settling time of the ash particles after the coal particles have risen with the bubbles while doing batch tests, it is shown in Figure 40 that a reduction in the ash content of the clean product by approximately 1% can be achieved by extending the time allowed for settling. This reduction in ash could be attributed to the drainage of liquid lamellae between the bubbles, which removed loosely held ash particles from the froth. Due to the tenacity of microbubble froths, it may be possible to spray the froth and to free these particles, while maintaining high yields. The AFT (Advanced Fuel Technology) process (Burgess, et al, 1983) is presently exploiting this concept. Yoon (1984) also suggests that in a continuous microbubble flotation operation, it could be advantageous to build up a thick froth layer and remove only the top portion of the froth (as this portion has had time to drain).

III. Effect of Particle Size and Bubble Size

As is widely known and is shown several times in this work, flotation rate decreases significantly with decreasing particle size. Fine particles having small masses simply cannot deviate from the streamlines around large bubbles and are less likely to collide with and attach to the bubbles.

From a theoretical standpoint as discussed in the Literature Review and also as shown experimentally by Yoon and Luttrell, recovery rate can be improved by using smaller bubbles. This is shown quite dramatically in the kinetics flotation tests on the -100 mesh Eagle (Figure 45) and on the attrition ground Eagle (Figure 47). It is unfortunate that bubble size measurements were not made so that a mathematical relationship between bubble size and flotation rate could be determined for this work.

In addition to the improved flotation kinetics provided by smaller bubbles, another finding of this work was that as particle size decreases, smaller bubbles also clean the coal to a lower ash content. This trend is observed in examining the conventional versus microbubble flotation tests and the kinetics tests. On the -100 mesh Eagle and the -100 mesh R & F samples, the microbubble process produced a higher ash coal (Tables III and IV). This may be attributed to the higher recovery rate observed in microbubble flotation (Figure 45), which in turn gives rise to a higher rate of

entrainment. This is shown in the kinetics tests on the -100 mesh Eagle where the microbubble test produced the highest clean coal ash.

On the -400 mesh Taggart sample though, the microbubble process obtained a considerably higher recovery than did the conventional technique, while the two produced comparable clean coal ashes. On even finer coal, i.e., the attrition ground Eagle samples, the conventional and microbubble processes produced comparable yields, but the microbubble process showed much more selectivity. A reason that such comparable yields were obtained with this ultrafine coal is that a high dosage (12 lb/ton) of kerosene was used in both of these tests. Again, this result is duplicated in the kinetics flotation tests, where the microbubble test on the attrition ground Eagle coal produced the lowest clean coal ash.

Luttrell, et al (1985) has further investigated the effect of bubble size on flotation selectivity and has shown that microbubbles are more selective than larger bubbles because they do not have a turbulent wake as they rise, and thus, no particles are indiscriminately entrained during flotation. Conducting frothless flotation experiments on particles less than 50 microns, they showed that the ratio of recoveries of coal to quartz, a measure of selectivity, was fairly constant using bubbles less than 300 microns in diameter, but selectivity dropped quickly as the bubbles became larger than 300 microns. Selectivity was also shown to decrease

with decreasing particle size over the range of bubble sizes tested. These results corresponded closely with photographs taken of rising bubbles which showed that bubbles of less than 300 microns in diameter carried virtually no wake, but wake volume actually increased with increasing bubble size for bubbles larger than 300 microns in diameter. Furthermore, they showed using flotation experiments which did not involve entrainment (probability of collection measurements), that the ratio of probabilities of coal to quartz did not change with changing bubble size. This finding indicates that the loss of selectivity encountered when floating ultrafines has little bearing with simple collision and attachment probabilities, but is in fact due to entrainment.

In summary, with smaller bubbles the probability of collection is improved which in turn provides improved flotation kinetics. Concerning selectivity, the size of the bubble determines whether or not wake entrainment occurs, while the size of the particle determines the degree of entrainment.

SUMMARY AND CONCLUSIONS

1) Of the frothers tested, Dowfroth M150 has proven to be the most effective for microbubble flotation. Dowfroth M150 produces more stable microbubbles than does MIBC, which can be attributed to M150's higher surface activity.

2) Such factors as the volume and concentration of microbubbles injected, the pulp density in the flotation cell, and the time allowed for settling of the surface and drainage of the froth layer, play critical roles in determining the effectiveness of the process.

3) Microbubble flotation using a cylindro-conical cell has demonstrated both improved recovery rate and selectivity over the conventional technique using larger bubbles, when cleaning ultrafine coals.

4) Flotation rate has been shown to increase with decreasing bubble size, which can be attributed to an increasing probability of collision with decreasing bubble size.

5) The use of small bubbles increases the selectivity of the flotation process, which may be attributed to a decreasing wake volume with decreasing bubble size.

REFERENCES

- Aplan, F. F., "Coal Flotation," Flotation - A. M. Gaudin Memorial Volume, Vol. 2, Fuerstenau, M. C., ed., AIME, New York, 1976, p. 1235-1264.
- Bennett, A. J. R., Chapman, W. R., and Dell, C. C., "Froth Flotation of Coal," Proceedings 3rd International Coal Preparation Congress, Brussels-Leige; Vol. EZ, 1958, p. 452-462.
- Brown, D. J., "Coal Flotation," Froth Flotation - 50th Anniversary Volume, Fuerstenau, D. W., ed., AIME, New York, 1962, p. 518-538.
- Brown, D. J., "A Photographic Study of Froth Flotation," Fuel Society Journal, Vol. 16, 1965, p. 22-34.
- Burgess, J. R., "It Takes Fewer Men to Make Cleaner Coal," Coal Age, Vol. 91, No. 6, June, 1986, p. 85-91.
- Burgess, L. E., McGarry, P. E., Herman, D. E., and Koppelman, L. N., "The AFT Beneficiation System: A New Way to Clean Coal," Fifth International Symposium on Coal Slurry Combustion and Technology, Tampa, Florida, 1983.
- Guccione, Eugene, 1986, "1986 Will Be Better Than 1985, Maybe," Coal Mining, January 1986, p. 26-30.
- Guccione, Eugene, 1986, "Getting the Most From Coal Prep 86," Coal Mining, April, 1986, p. 26-29.
- Luttrell, G. H., Keyser, P. M., Adel, G. T., and Yoon, R. H., "Improvements in Recovery and Selectivity With the Microbubble Flotation Process," Proceedings Pittsburgh Coal Conference, 1985, p. 43-54.
- Luttrell, G. H., and Yoon, R. H., 1983, "Automation of a Laboratory Flotation Machine for Improved Performance," International Journal of Mineral Processing, 10, p. 165-172.
- Miller, J. D., 1982, "Coal Flotation Chemistry," Final Report Prepared for United States Department of Energy, Contract #AC22-75ET 11419, p. 3-4.
- Miller, K. J., "Coal Preparation," Mining Engineering, Vol. 38, No. 5, May, 1986, p. 351-352.

- O'Brien, Ellis, 1980, "Fine Coal Cleaning in the 28x0 Fraction, A Technical Overview, "Mining Engineering, August, 1980, p. 1213-1237.
- Reay, D., and Ratcliff, G. A., "Removal of Fine Particles From Water By Dispersed Air Flotation: Effects of Bubble Size and Particle Size on Collection Efficiency," The Canadian Journal of Chemical Engineering, Vol. 53, 1975, p. 481-486.
- Roe, I. A., "Flotation of Liquids and Fine Particles From Liquids," Fine Particles Processing, Vol. 1, AIME, New York, 1980, p. 871-885.
- Sebba, F., "Microfoams - An Unexploited Colloid System," Journal of Colloid and Interface Science, Vol. 35, 1971, p. 643-646.
- Sebba, F., "Microgas Dispersions," U.S. Patent No. 3,900,420, 1975.
- Sebba, F., "Investigation of the Modes of Contaminant Capture in CGA (MGO) Foams," U.S. Department of Interior Report OWRT/RU-82/10, p. 11-22.
- Snoby, R. J., personal correspondence with Greg Halsey, November, 1986.
- Weber, M. E., and Paddock, D., "Interceptional and Gravitational Collision Efficiencies for Single Collectors at Intermediate Reynolds Numbers," Journal of Colloid and Interface Science, 94 (2), p. 328-335.
- Yoon, R. H., "Microbubble Flotation of Fine Coal," Final Report Prepared for United States Department of Energy, Report No. DOE/PC/30234-T3.
- Yoon, R. H., and Luttrell, G. H., 1986, "The Effect of Bubble Size on Fine Coal Flotation," Coal Preparation, Vol. 2, p. 179-192.
- Yoon, R. H., Luttrell, G. H., Adel, G. T., and Trigg, R. D., 1984, "Cleaning of Ultrafine Coal By Microbubble Flotation," Proceedings Pittsburgh Coal Conference, p. 881-896.
- Yoon, R. H., and Miller, K. J., "A Preliminary Investigation on the Application of Microgas Dispersion for Fine Coal Flotation," Report prepared for United States Department of Energy, July, 1980.

FIGURES

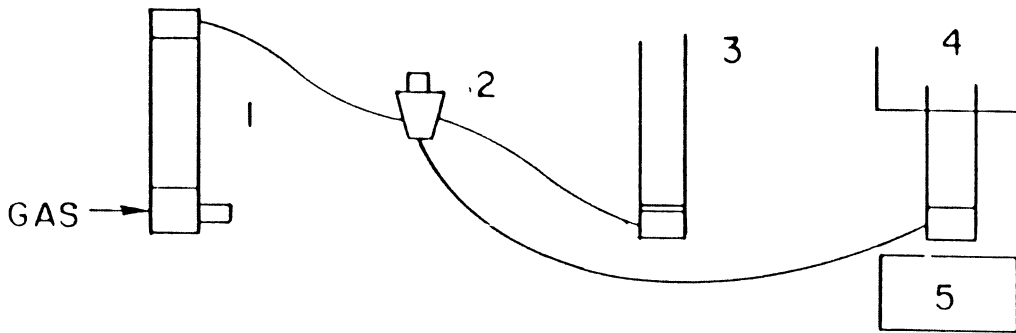

- 1 FLOW METER
- 2 3-WAY STOPCOCK
- 3 DUMMY CELL
- 4 FLOTATION CELL
- 5 MAGNETIC STIRRER

Figure 1. Microflotation apparatus.

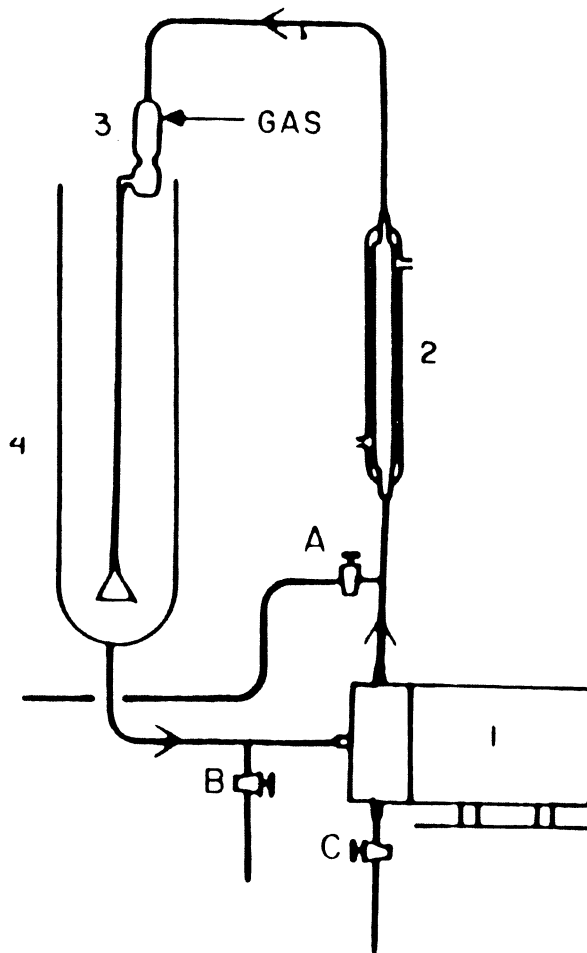

- 1 CENTRIFUGAL PUMP
- 2 HEAT EXCHANGER
- 3 GLASS ASPIRATOR
- 4 MICROBUBBLE RESERVOIR

Figure 2. Aspirator apparatus used to generate microbubbles.

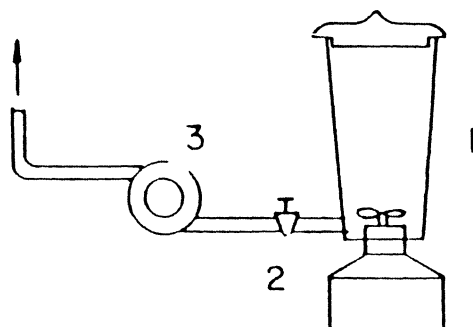

1 BLENDER

2 TWO-WAY VALVE

3 PERISTALTIC PUMP

Figure 3. Blender apparatus used to generate microbubbles.

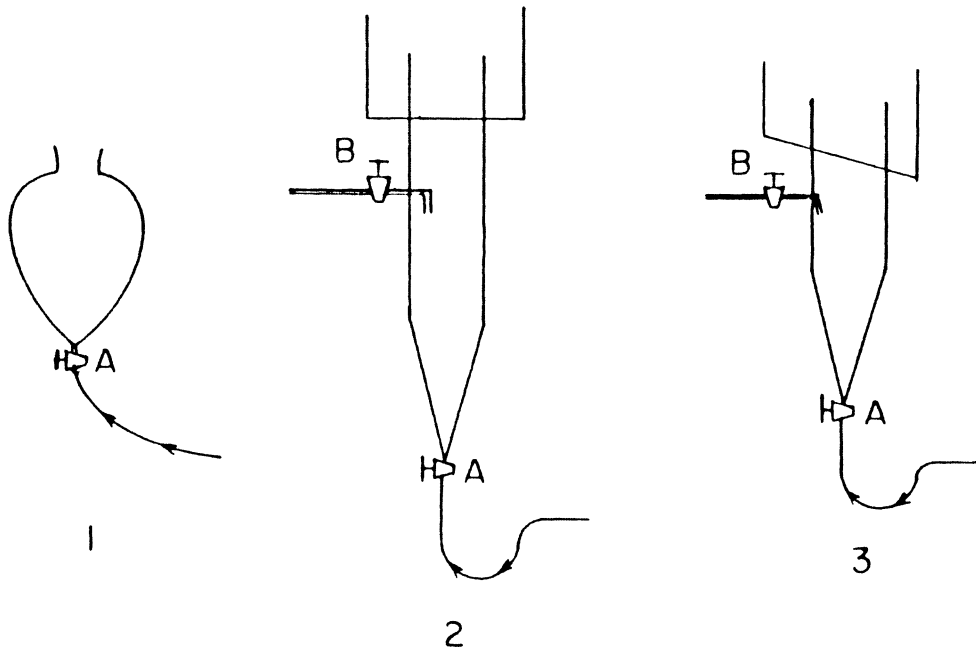

1 SEPARATORY FUNNEL

2 "FLOTAIRE" TYPE CELL

3 KINETICS CELL

A MICROBUBBLE INJECTION VALVE

B MAKE-UP WATER VALVE

Figure 4. Microbubble flotation cells.

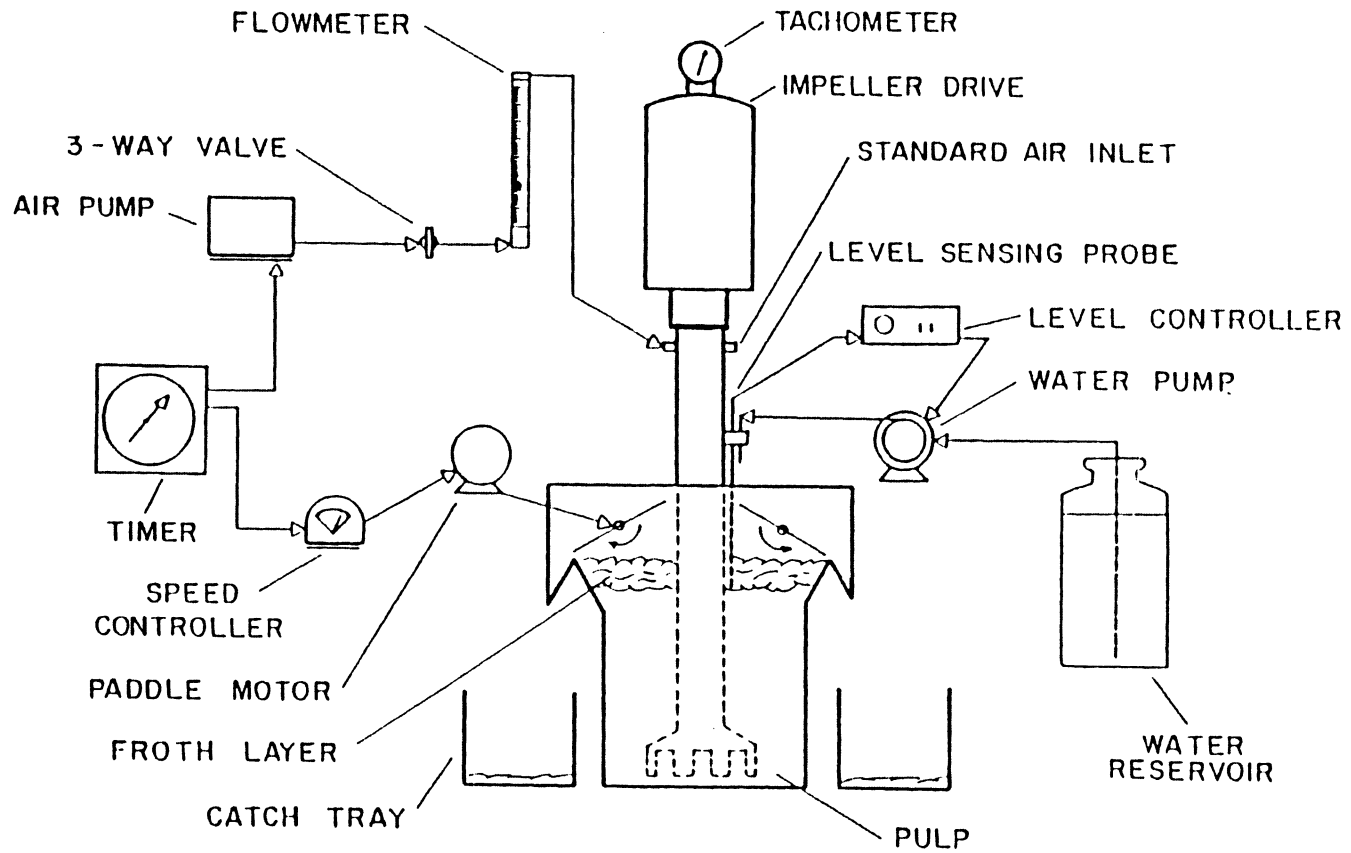

Figure 5. Automated conventional flotation apparatus.

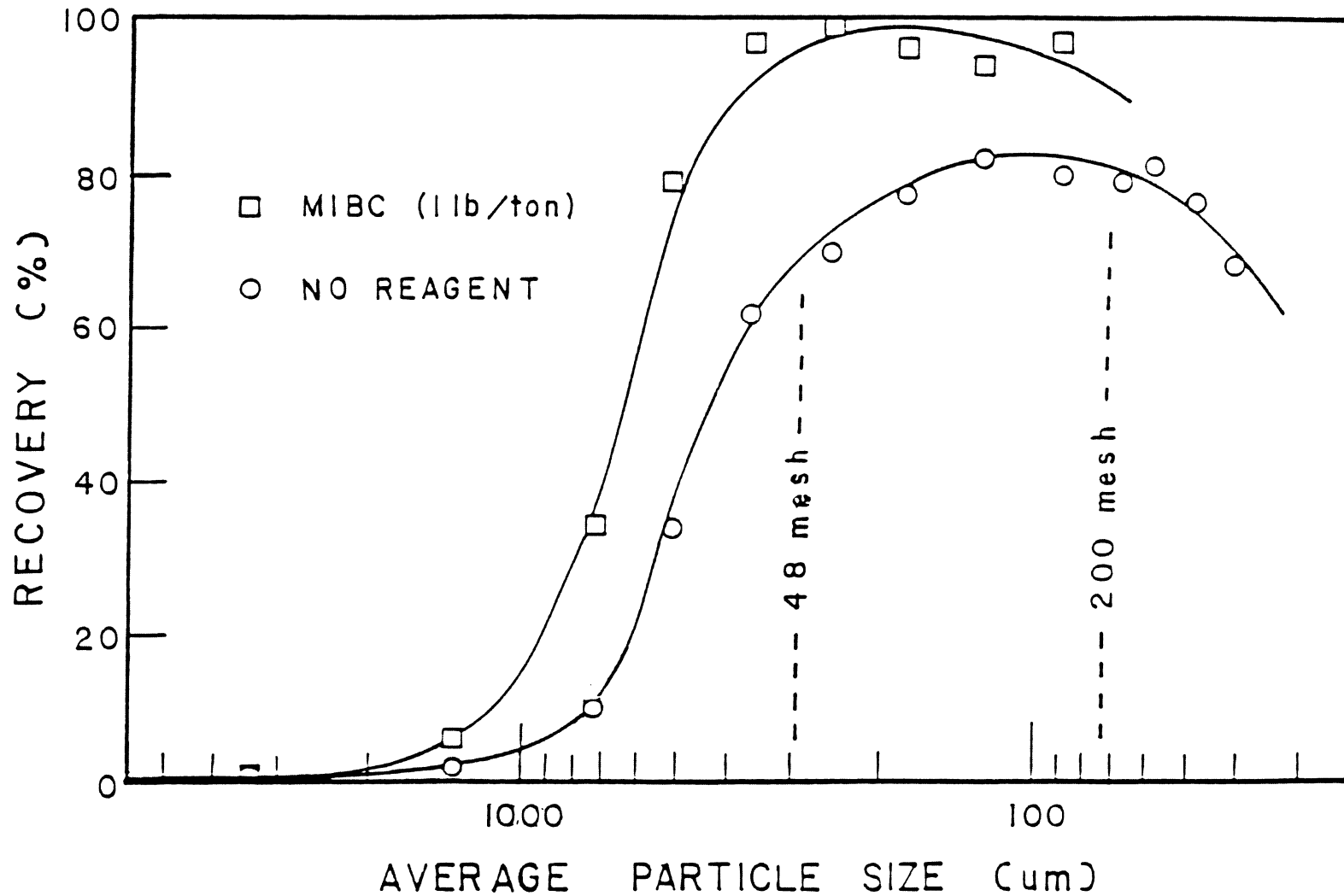

Figure 6. Floatability of various size fractions of Jawbone coal.

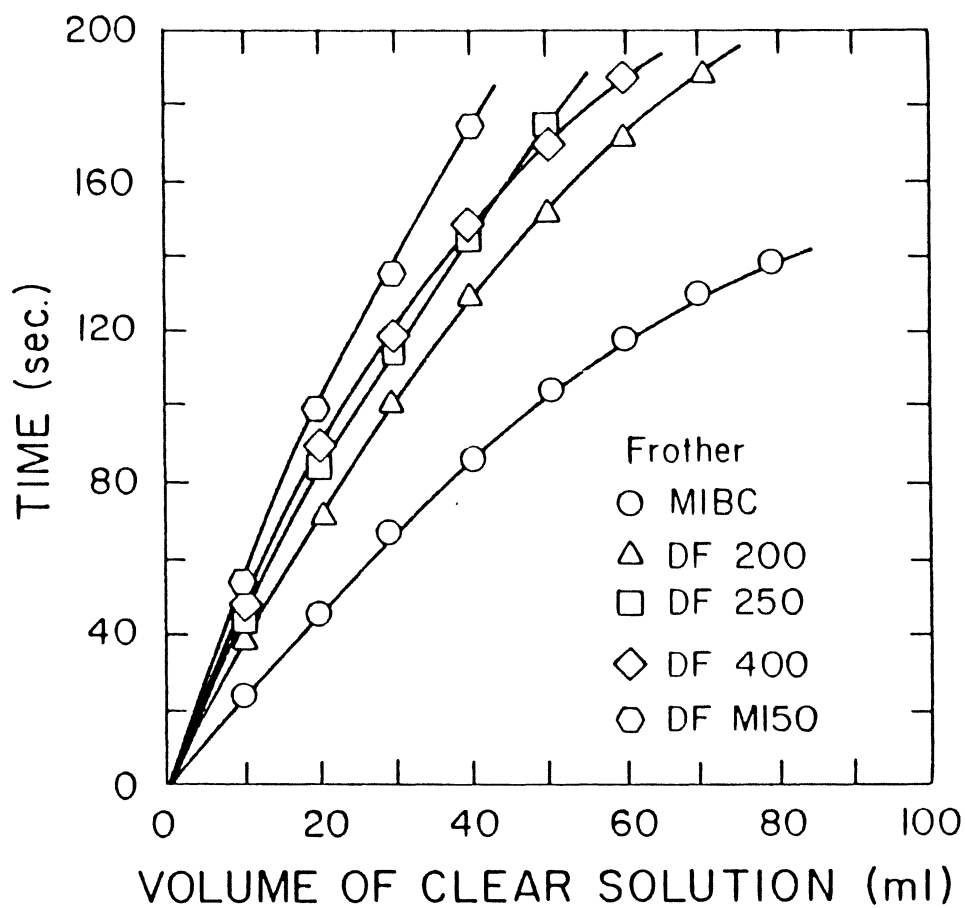

Figure 7. Stability of microbubbles generated by the aspirator technique using various frothers.

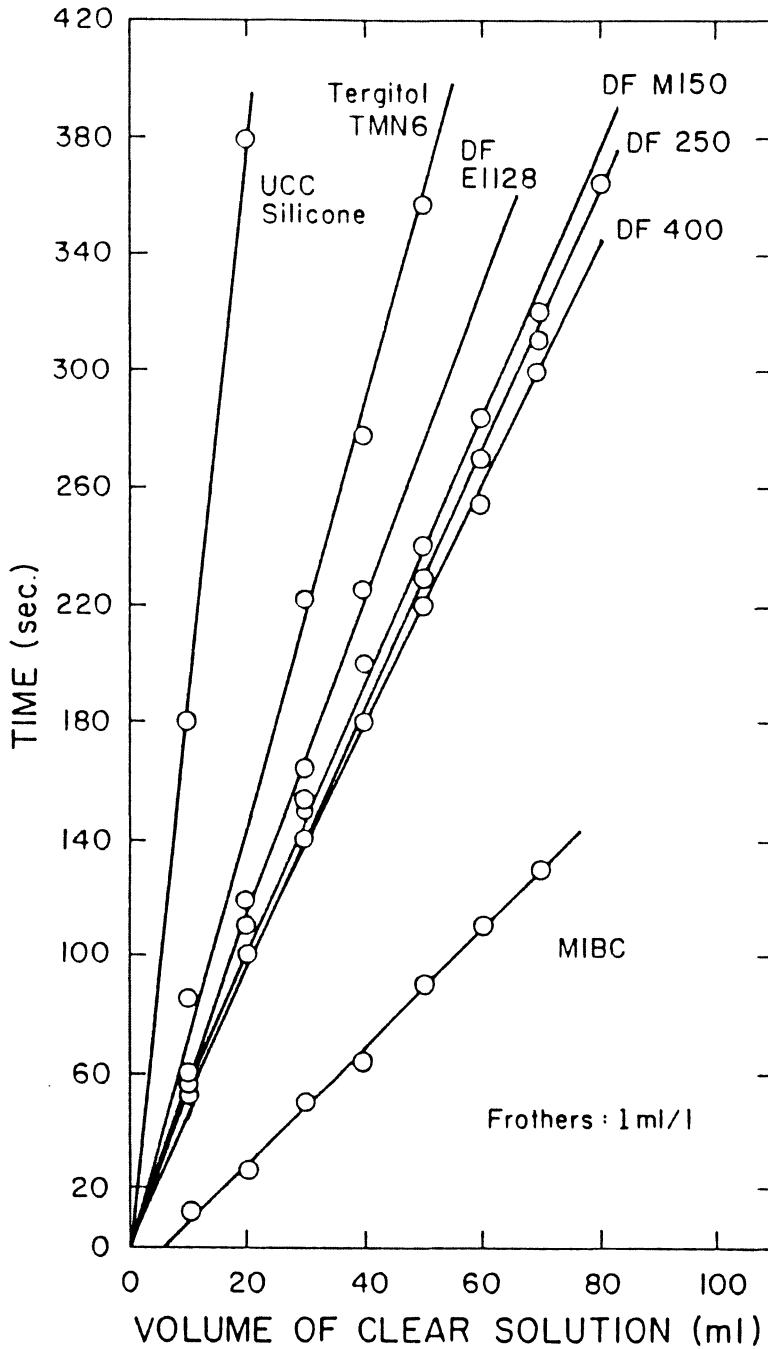

Figure 8. Stability of microbubbles generated by the blender technique using various frothers.

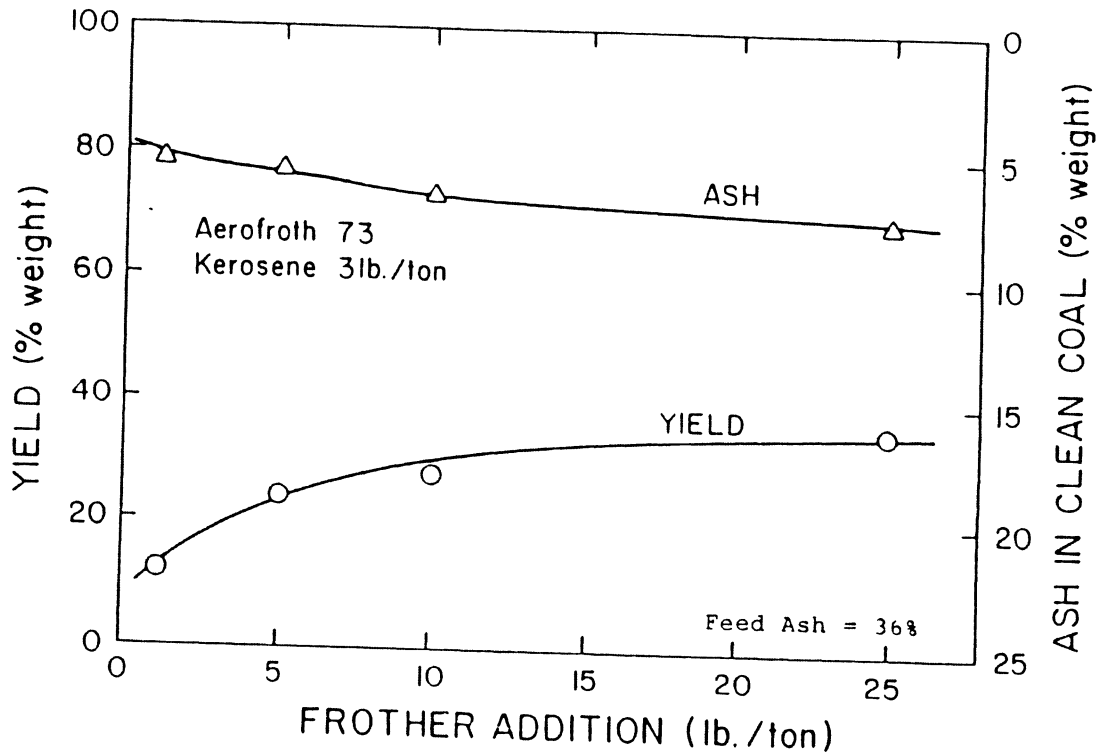

Figure 9. Results of flotation tests conducted on -100 mesh Eagle coal using 3 lb/ton of kerosene and microbubbles generated by the blender technique with varying amounts of Aerofroth 73.

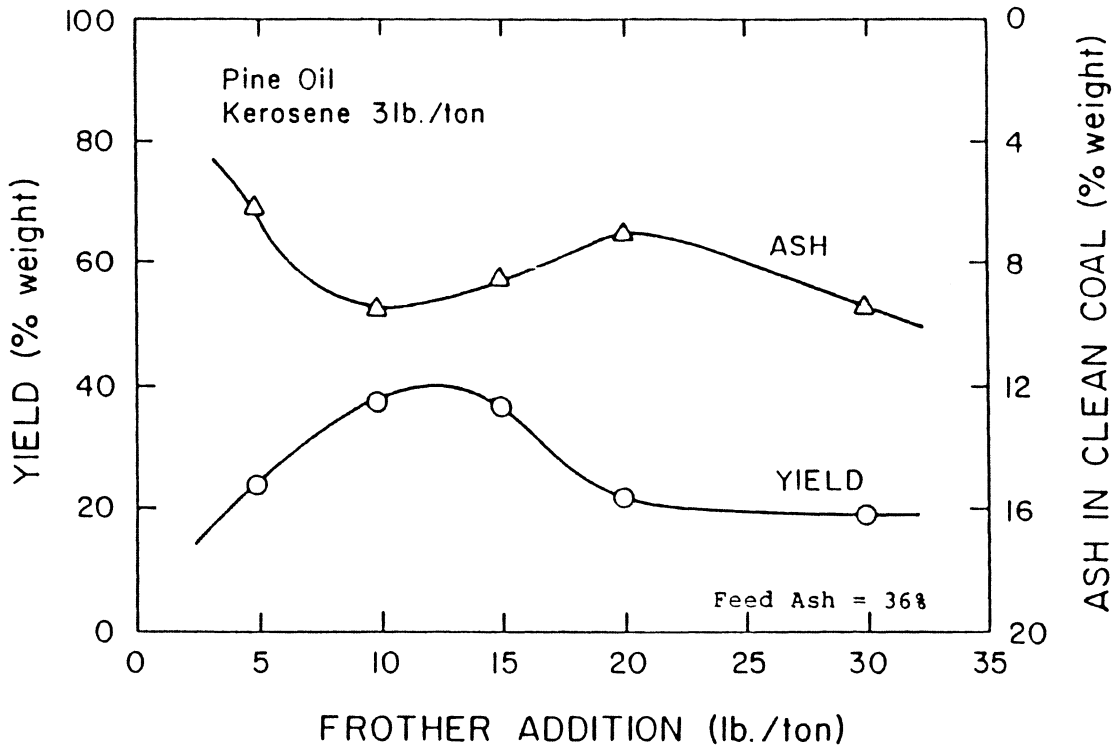

Figure 10. Results of flotation tests conducted on -100 mesh Eagle coal using 3 lb/ton of kerosene and microbubbles generated by the blender technique with varying amounts of pine oil.

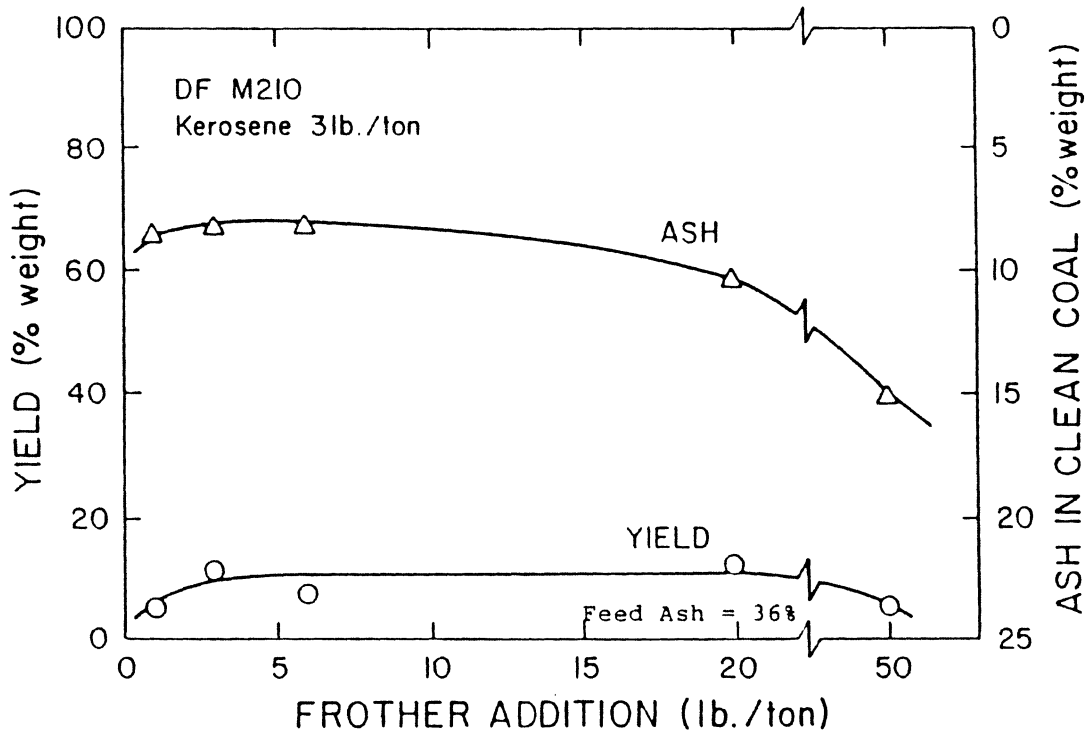

Figure 11. Results of flotation tests conducted on -100 mesh Eagle coal using 3 lb/ton of kerosene and microbubbles generated by the blender technique with varying amounts of Dowfroth M210.

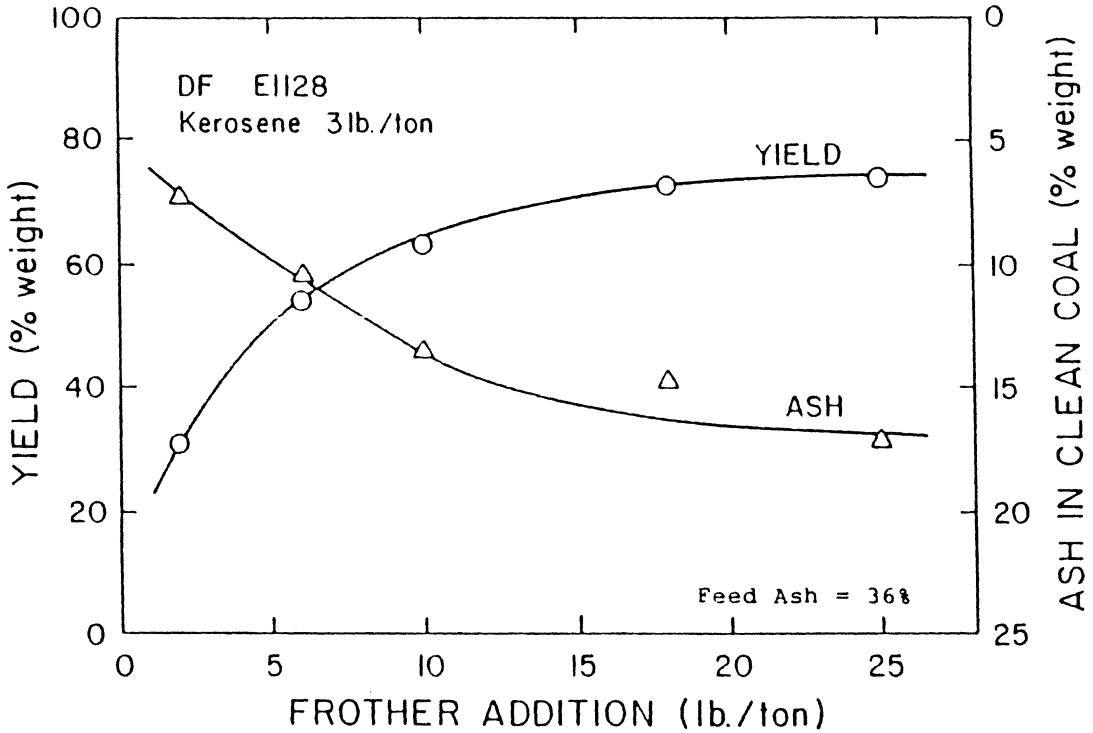

Figure 12. Results of flotation tests conducted on -100 mesh Eagle coal using 3 lb/ton of kerosene and microbubbles generated by the blender technique with varying amounts of Dowfroth E1128.

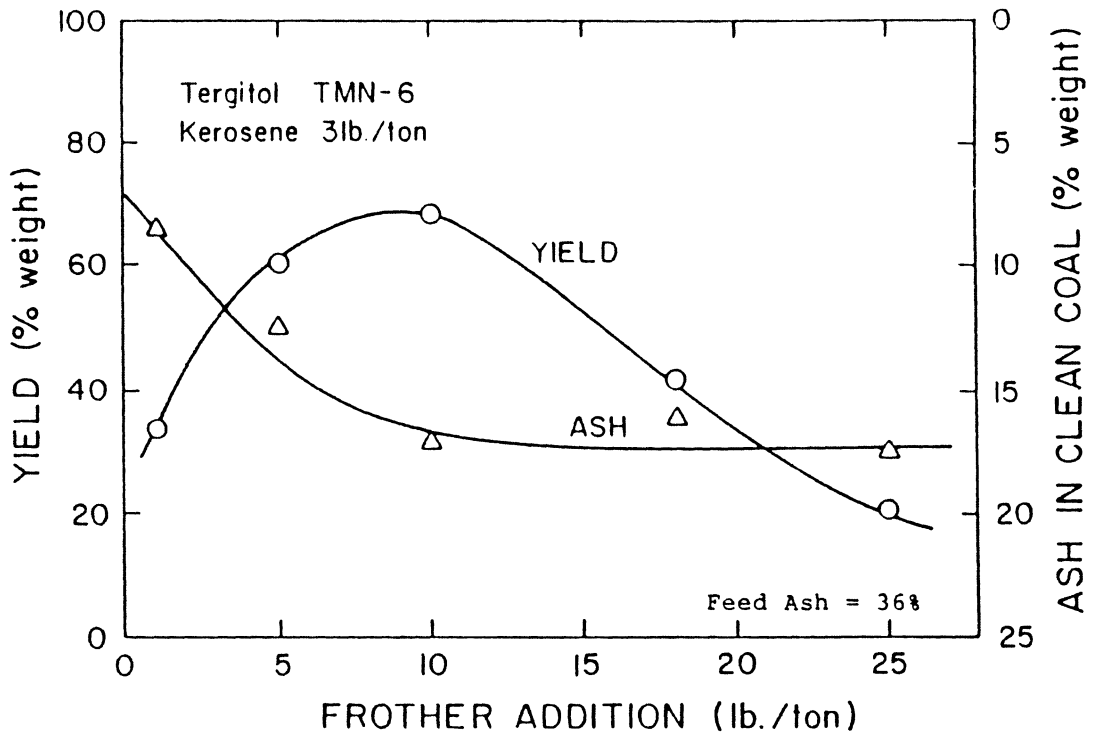

Figure 13. Results of flotation tests conducted on -100 mesh Eagle coal using 3 lb/ton of kerosene and microbubbles generated by the blender technique with varying amounts of Tergitol TMN-6.

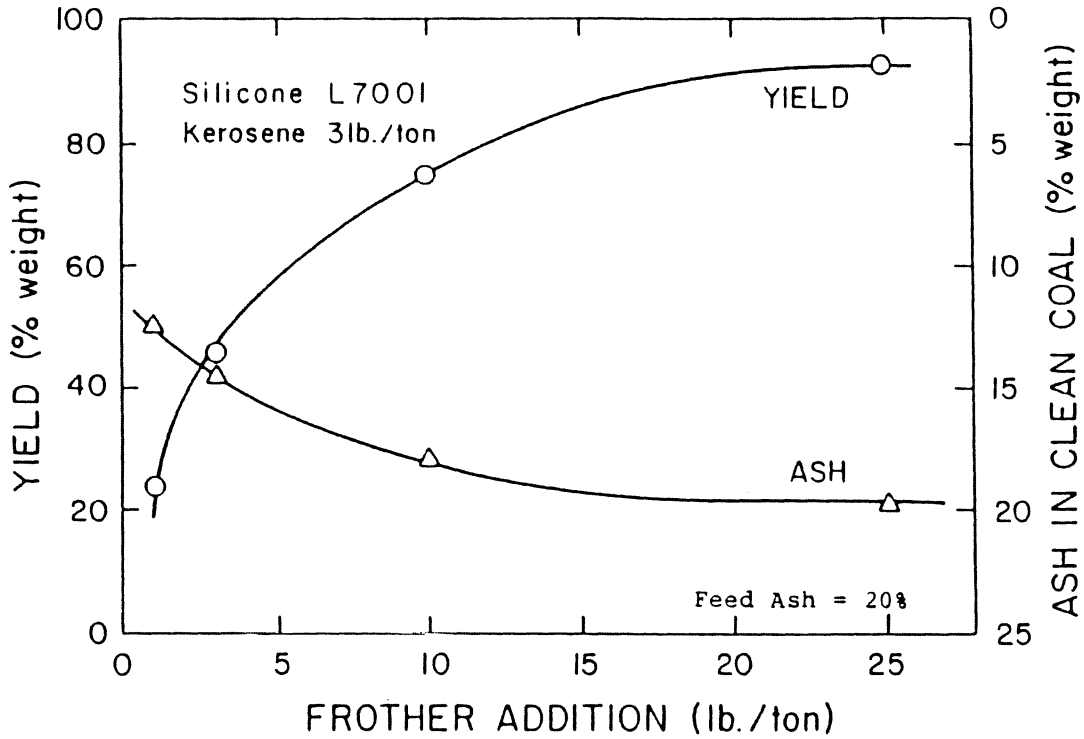

Figure 14. Results of flotation tests conducted on -100 mesh R & F coal using 3 lb/ton of kerosene and microbubbles generated by the blender technique with varying amounts of Silicone L7001.

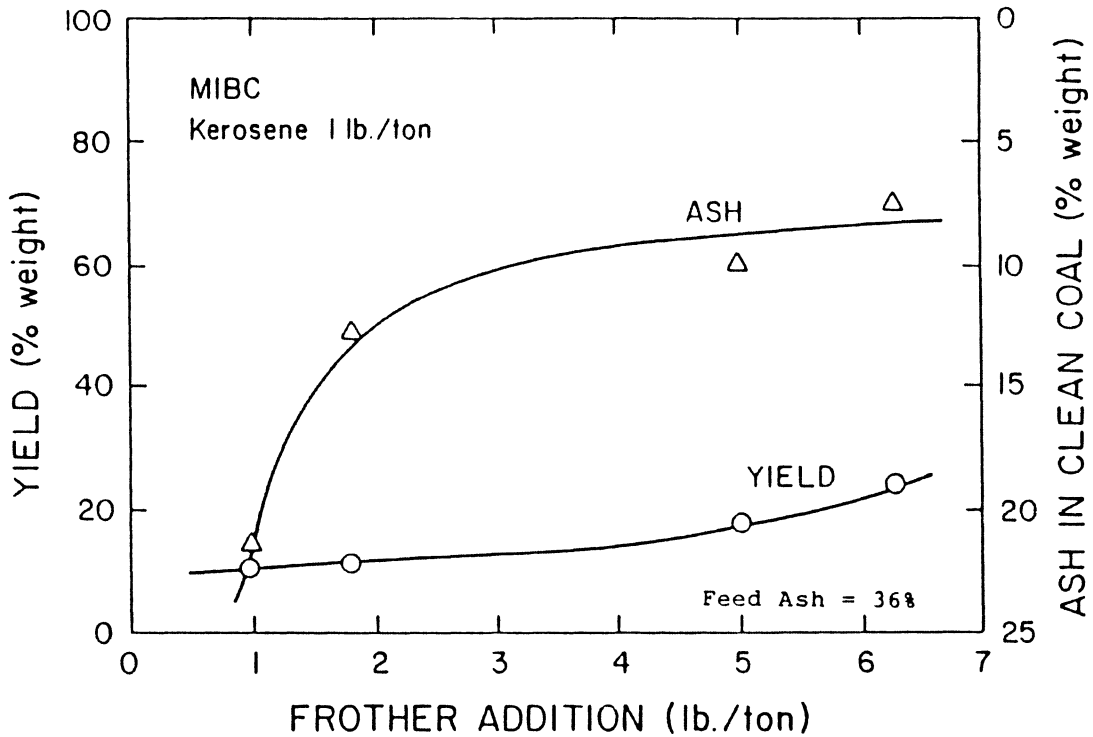

Figure 15. Results of flotation tests conducted on -100 mesh Eagle coal using 1 lb/ton of kerosene and microbubbles generated by the aspirator technique with varying amounts of MIBC.

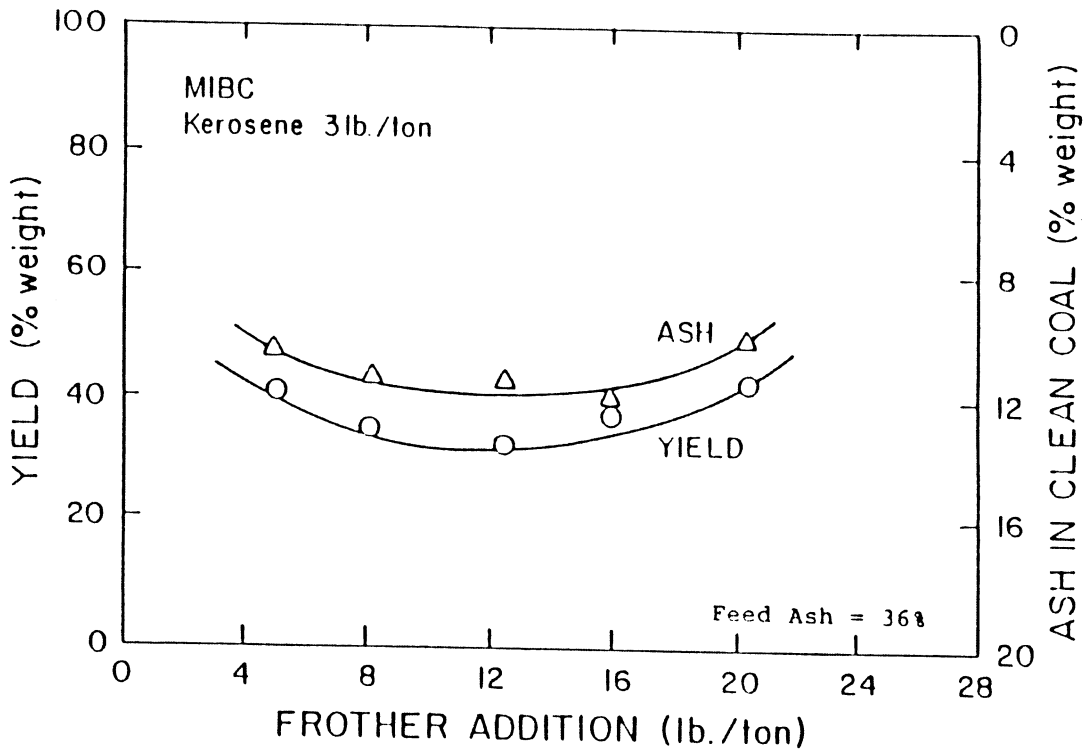

Figure 16. Results of flotation tests conducted on -100 mesh Eagle coal using 3 lb/ton of kerosene and microbubbles generated by the aspirator technique with varying amounts of MIBC.

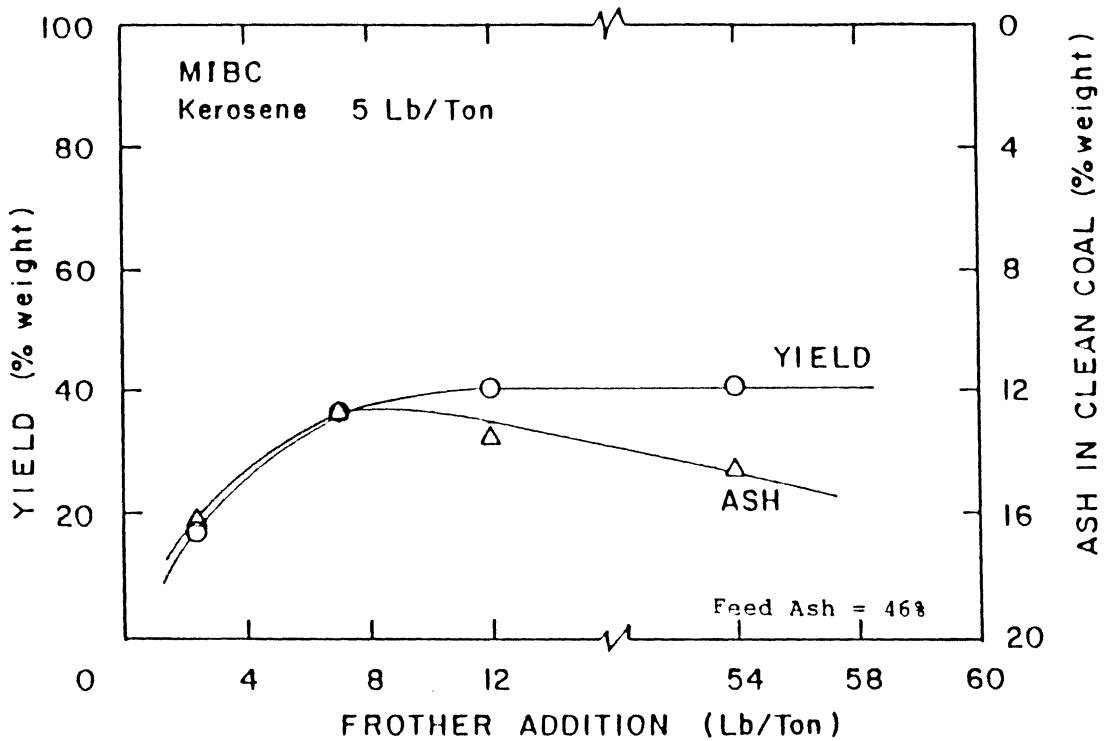

Figure 17. Results of flotation tests conducted on -400 mesh Taggart coal using 5 lb/ton of kerosene and microbubbles generated by the aspirator technique with varying amounts of MIBC.

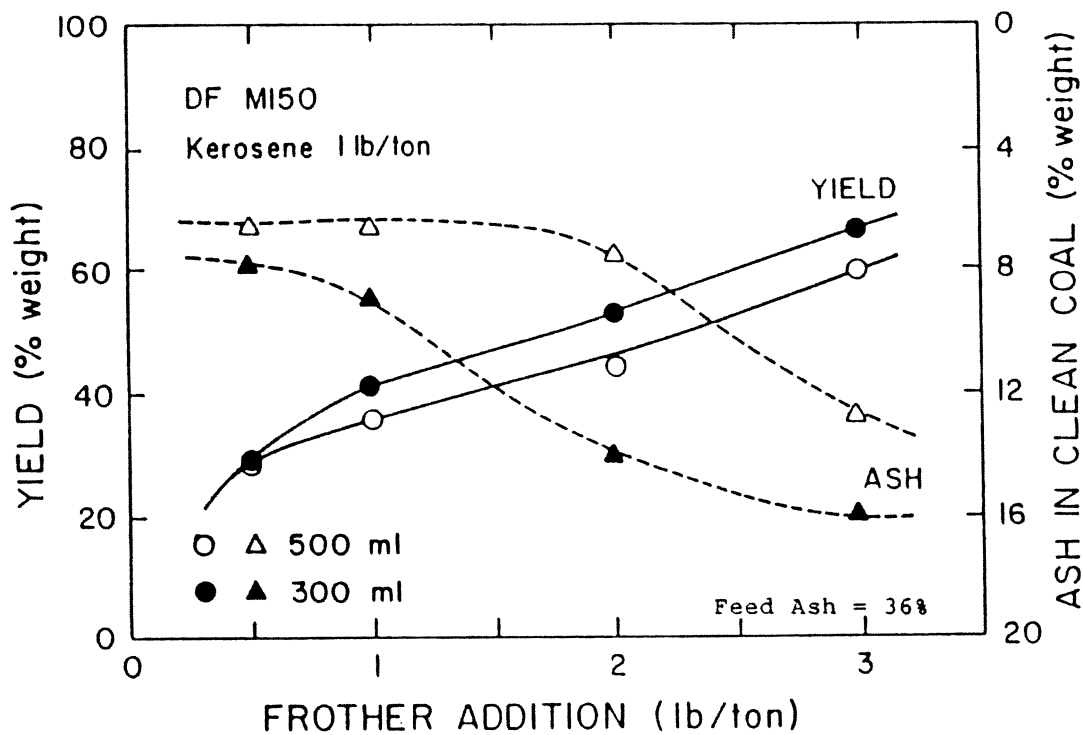

Figure 18. Results of flotation tests conducted on -100 mesh Eagle coal using 1 lb/ton of kerosene and microbubbles generated by the blender technique with varying amounts of Dowfroth M150. Different volumes of microbubbles were injected in each series.

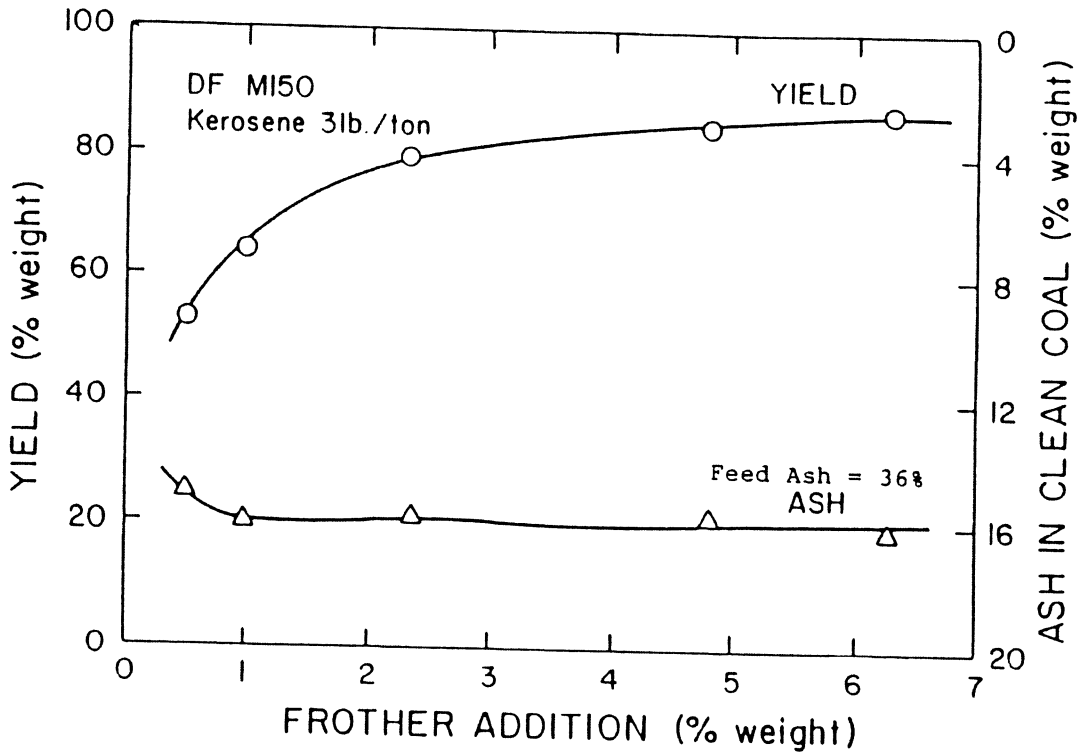

Figure 19. Results of flotation tests conducted on -100 mesh Eagle coal using 3 lb/ton of kerosene and microbubbles generated by the aspirator technique with varying amounts of Dowfroth M150. Different volumes of microbubbles were injected in each series.

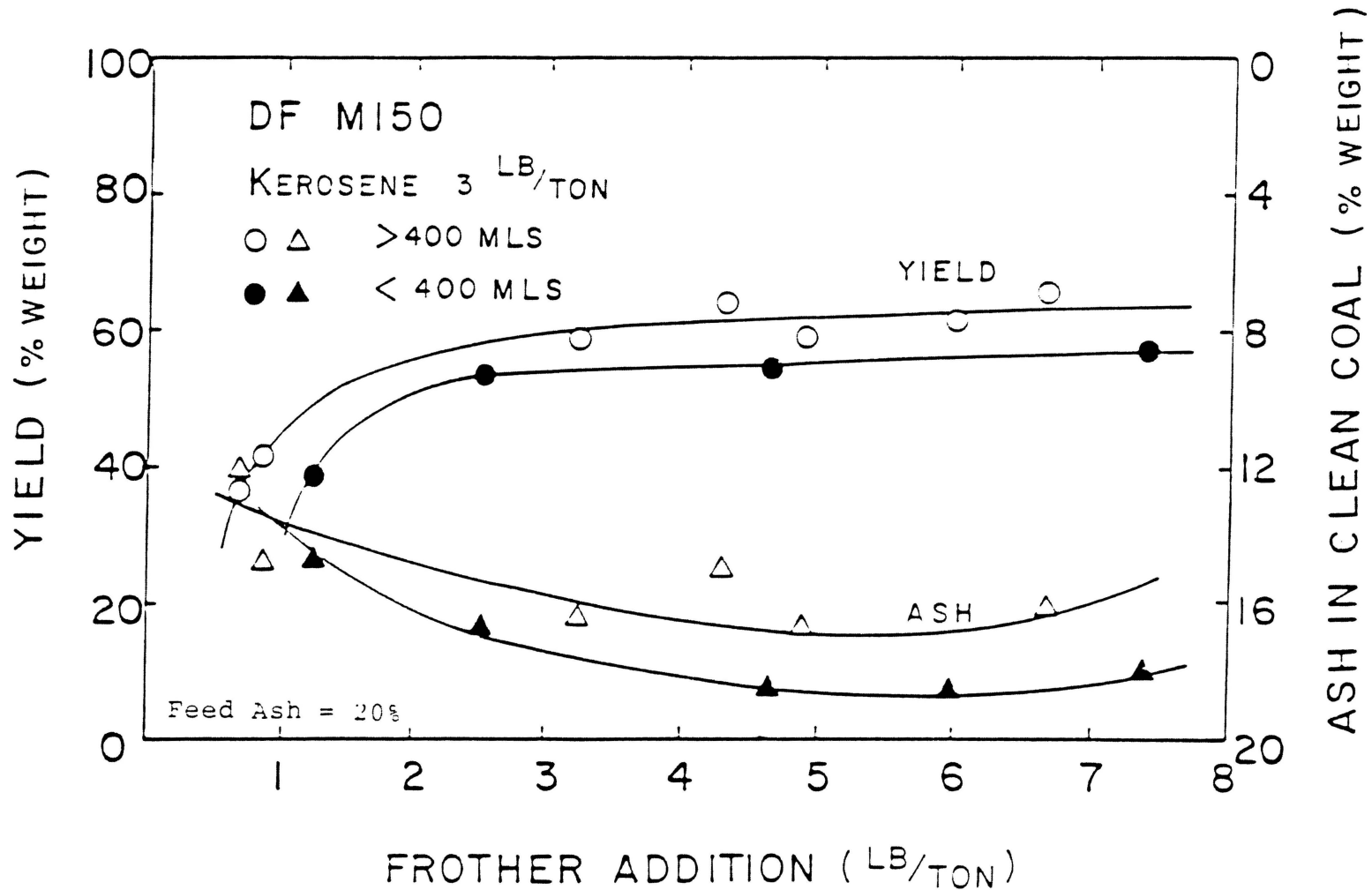

Figure 20. Results of flotation tests conducted on -100 mesh R & F coal using 3 lb/ton of kerosene and microbubbles generated by the aspirator technique with varying amounts of Dowfroth M150.

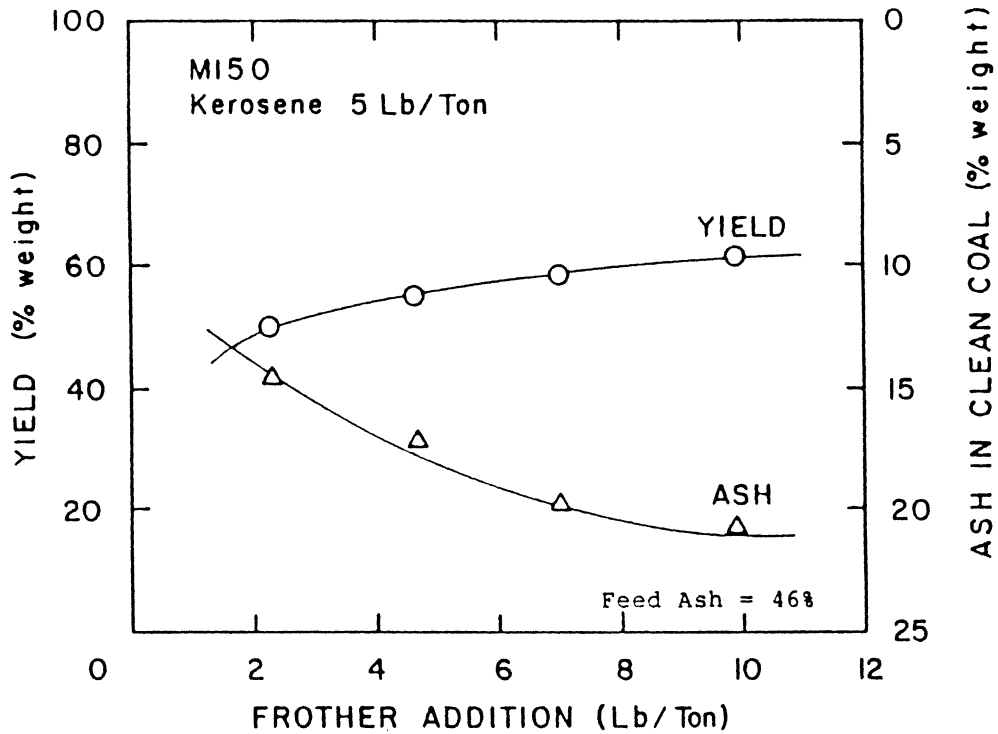

Figure 21. Results of flotation tests conducted on -400 mesh Taggart coal using 5 lb/ton of kerosene and microbubbles generated by the aspirator technique with varying amounts of Dowfroth M150.

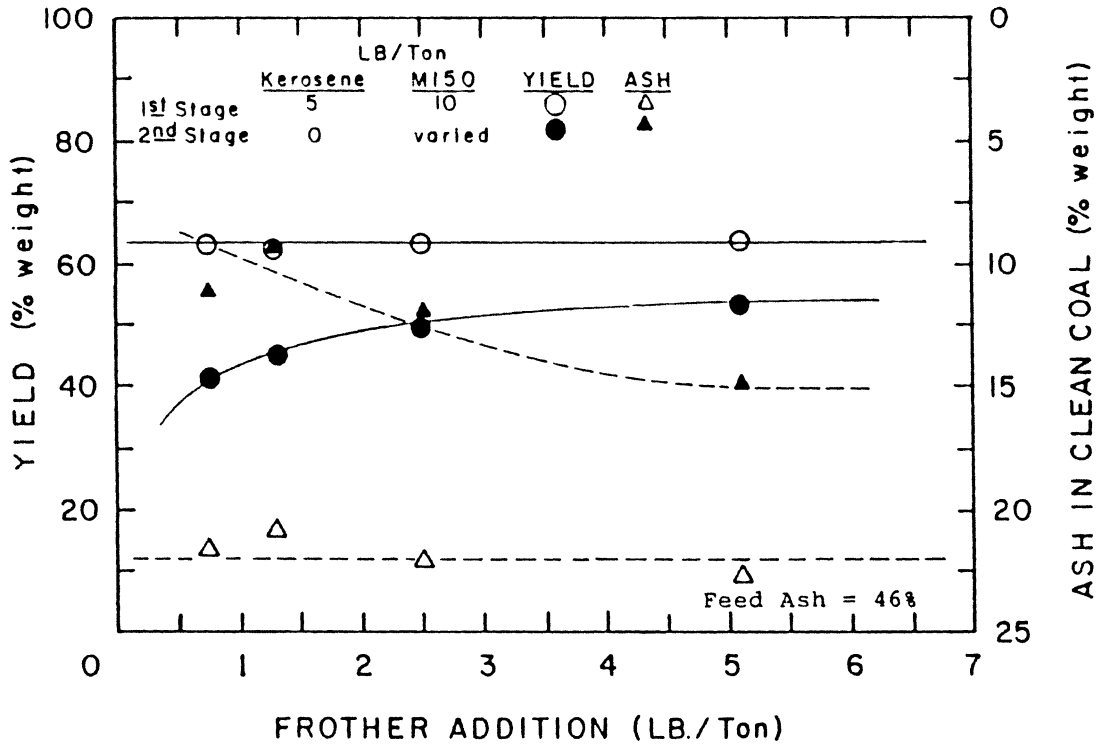

Figure 22. Results of two stage flotation tests conducted on -400 mesh Taggart coal using 5 lb/ton of kerosene and microbubbles generated by the aspirator technique with 10 lb/ton of Dowfroth M150 in the first stage and varying amounts of Dowfroth M150 in the second stage.

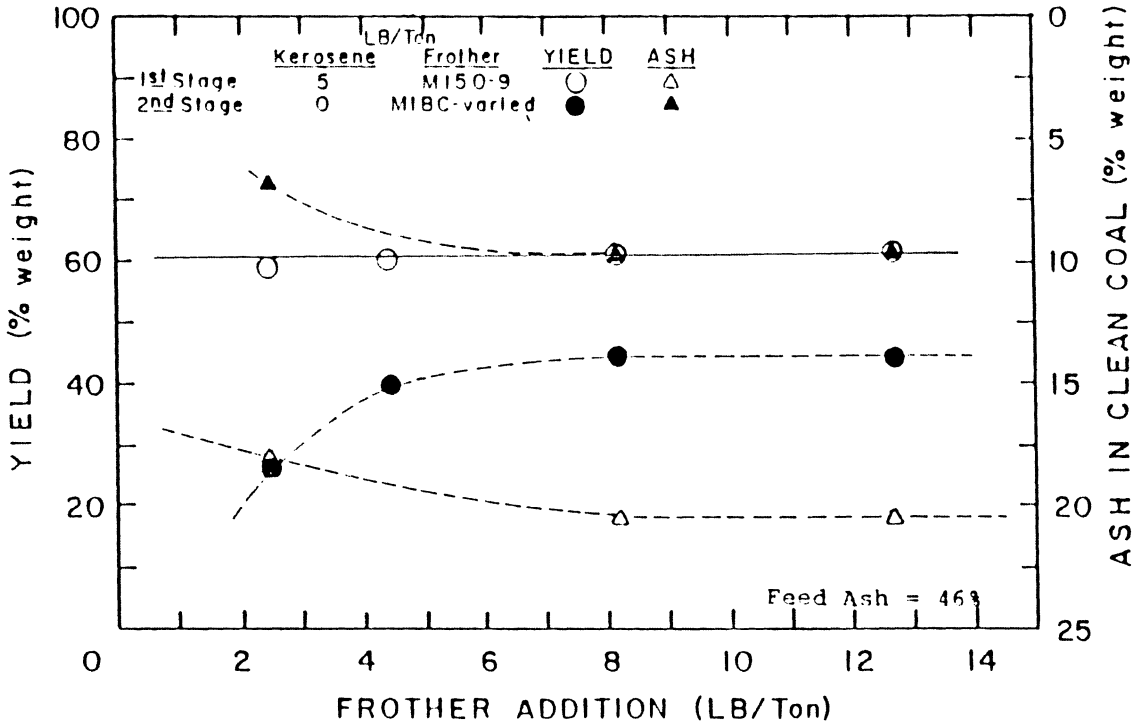

Figure 23. Results of two stage flotation tests conducted on -400 mesh Taggart coal using 5 lb/ton of kerosene and microbubbles generated by the aspirator technique with 10 lb/ton of Dowfroth M150 in the first stage and varying amounts of MIBC in the second stage.

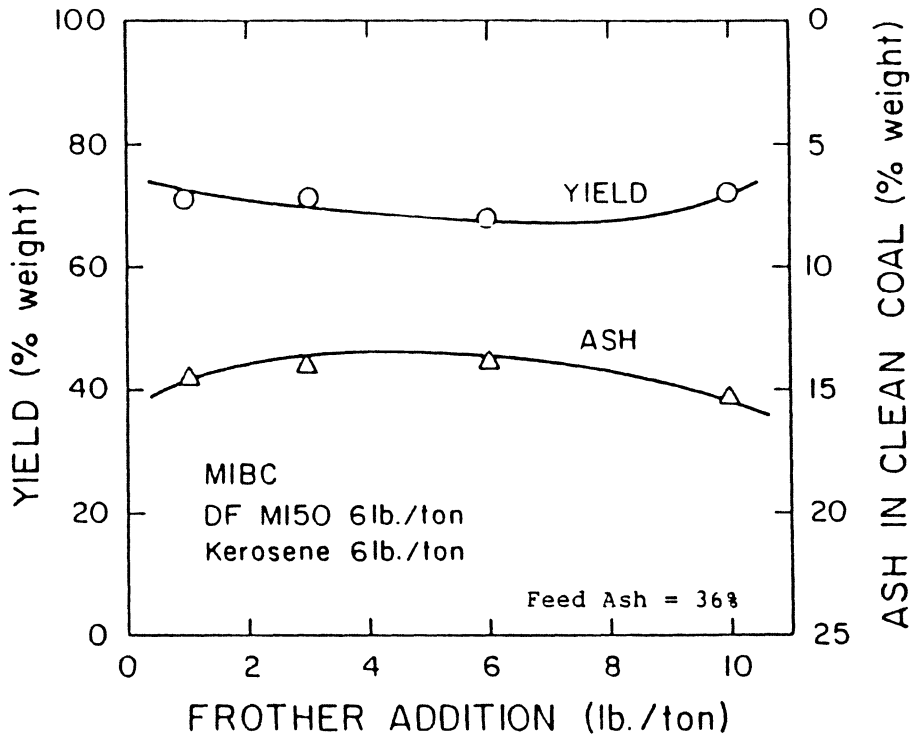

Figure 24. Results of flotation tests conducted on -100 mesh Eagle coal using 6 lb/ton of kerosene and microbubbles generated by the blender technique with 6 lb/ton of Dowfroth M150 and varying amounts of MIBC.

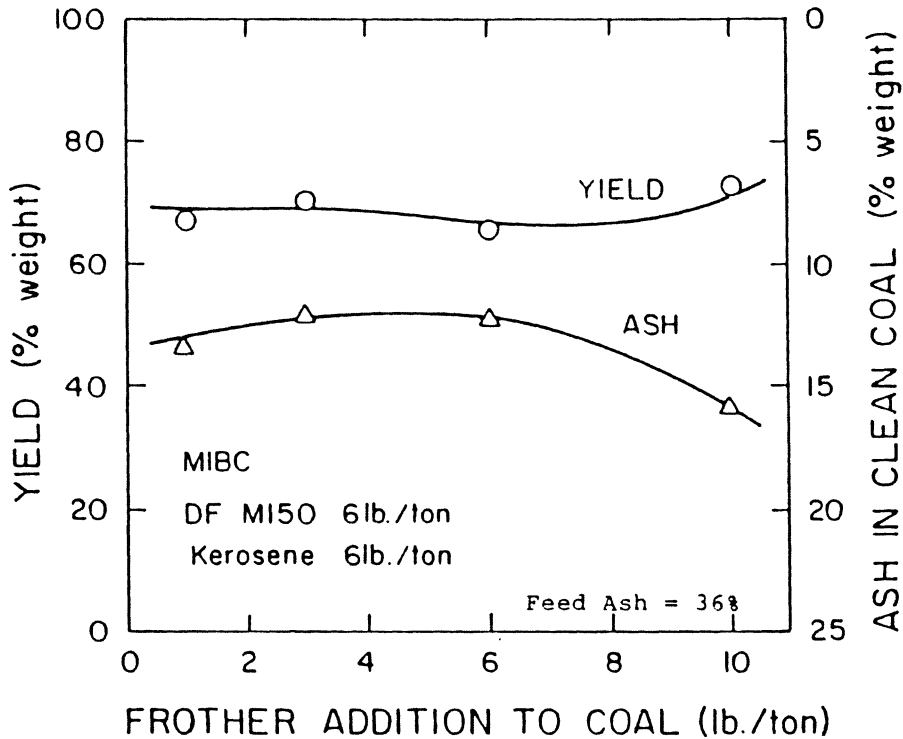

Figure 25. Results of flotation tests conducted on -100 mesh Eagle coal using 6 lb/ton of kerosene and microbubbles generated by the blender technique with 6 lb/ton of Dowfroth M150. Various amounts of MIBC were added to the coal during conditioning.

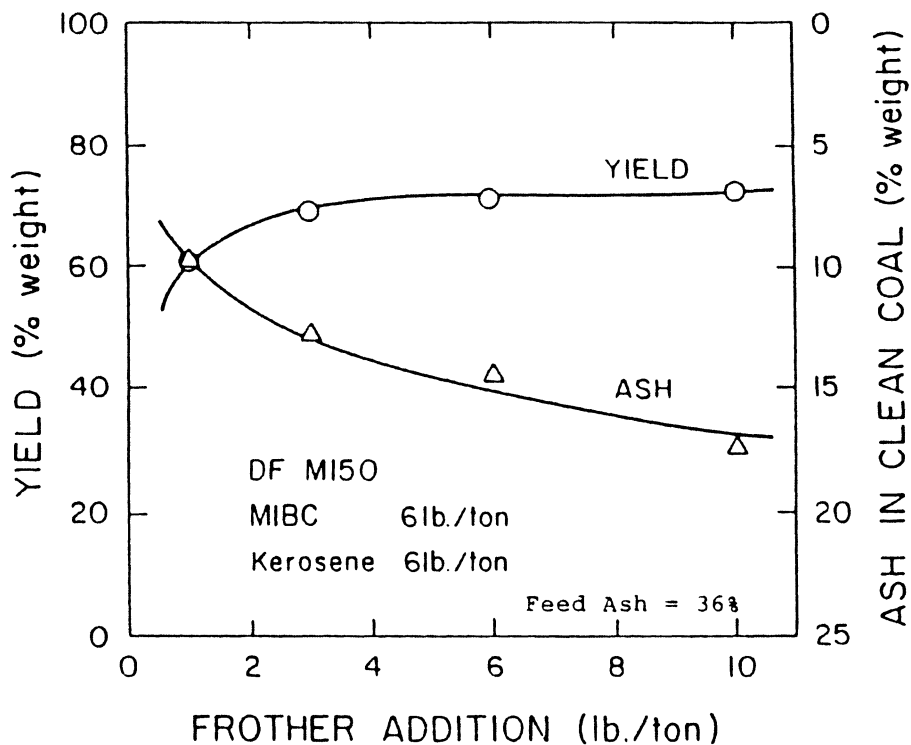

Figure 26. Results of flotation tests conducted on -100 mesh Eagle coal using 6 lb/ton of kerosene and microbubbles generated by the blender technique with 6 lb/ton of MIBC and varying amounts of Dowfroth M150.

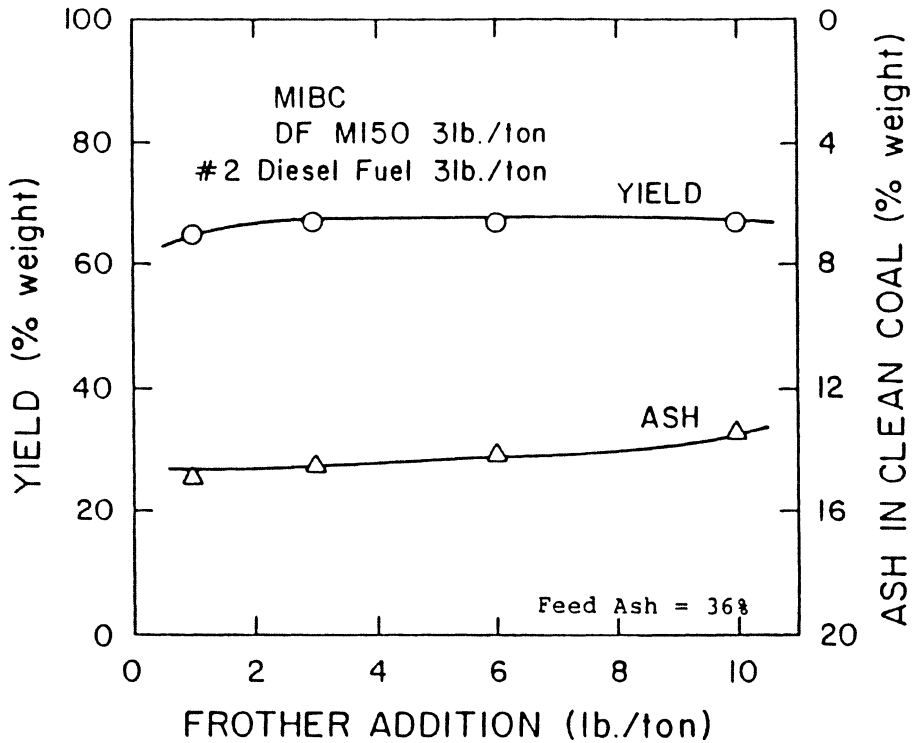

Figure 27. Results of flotation tests conducted on -100 mesh Eagle coal using 3 lb/ton of #2 diesel fuel and microbubbles generated by the blender technique with 3 lb/ton of Dowfroth M150 and varying amounts of MIBC.

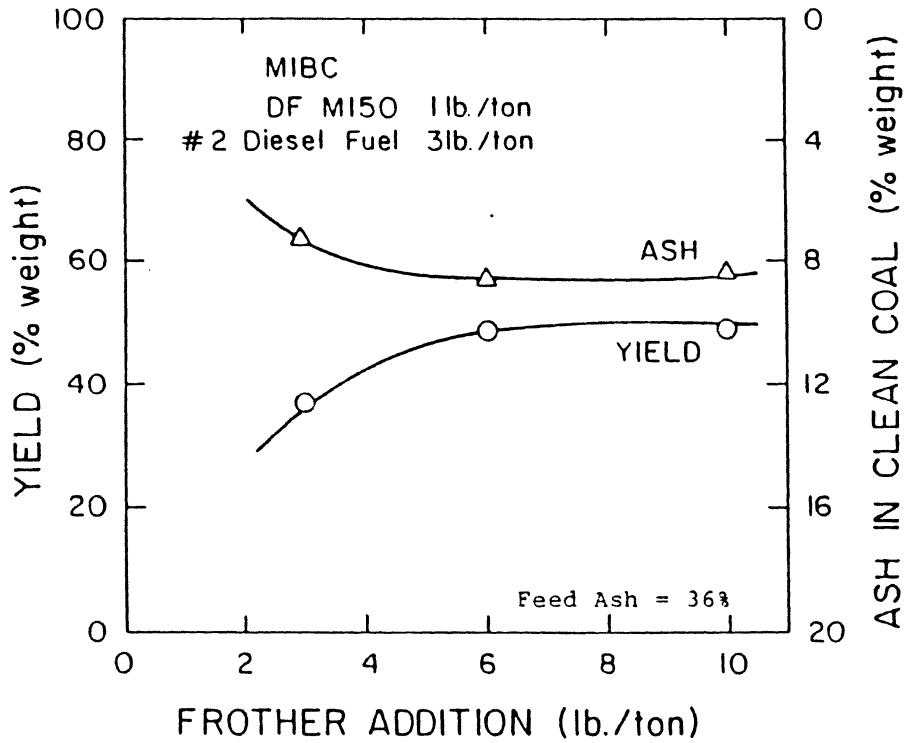

Figure 28. Results of flotation tests conducted on -100 mesh Eagle coal using 3 lb/ton of #2 diesel fuel and microbubbles generated by the blender technique with 1 lb/ton of Dowfroth M150 and varying amounts of MIBC.

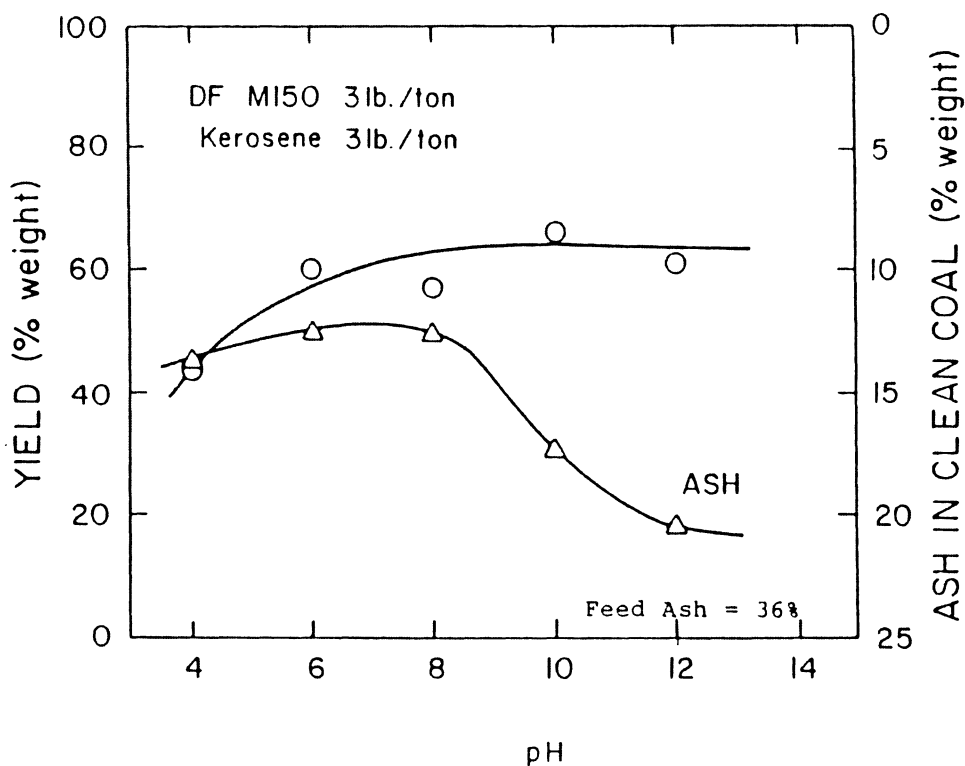

Figure 29. Results of flotation tests conducted on -100 mesh Eagle coal using 3 lb/ton of kerosene and microbubbles generated at varying pH by the blender technique with 3 lb/ton of Dowfroth M150.

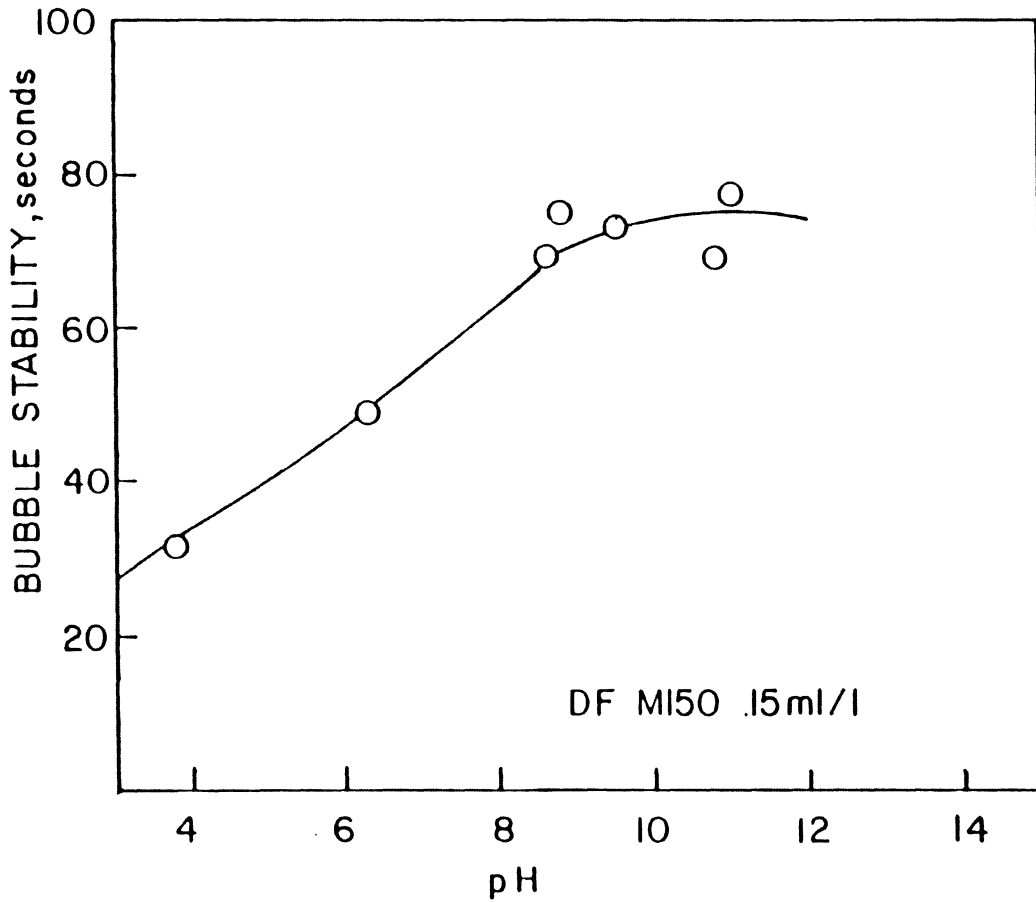

Figure 30. Stability of microbubbles generated by the blender technique using .15 ml/l of Dowfroth M150.

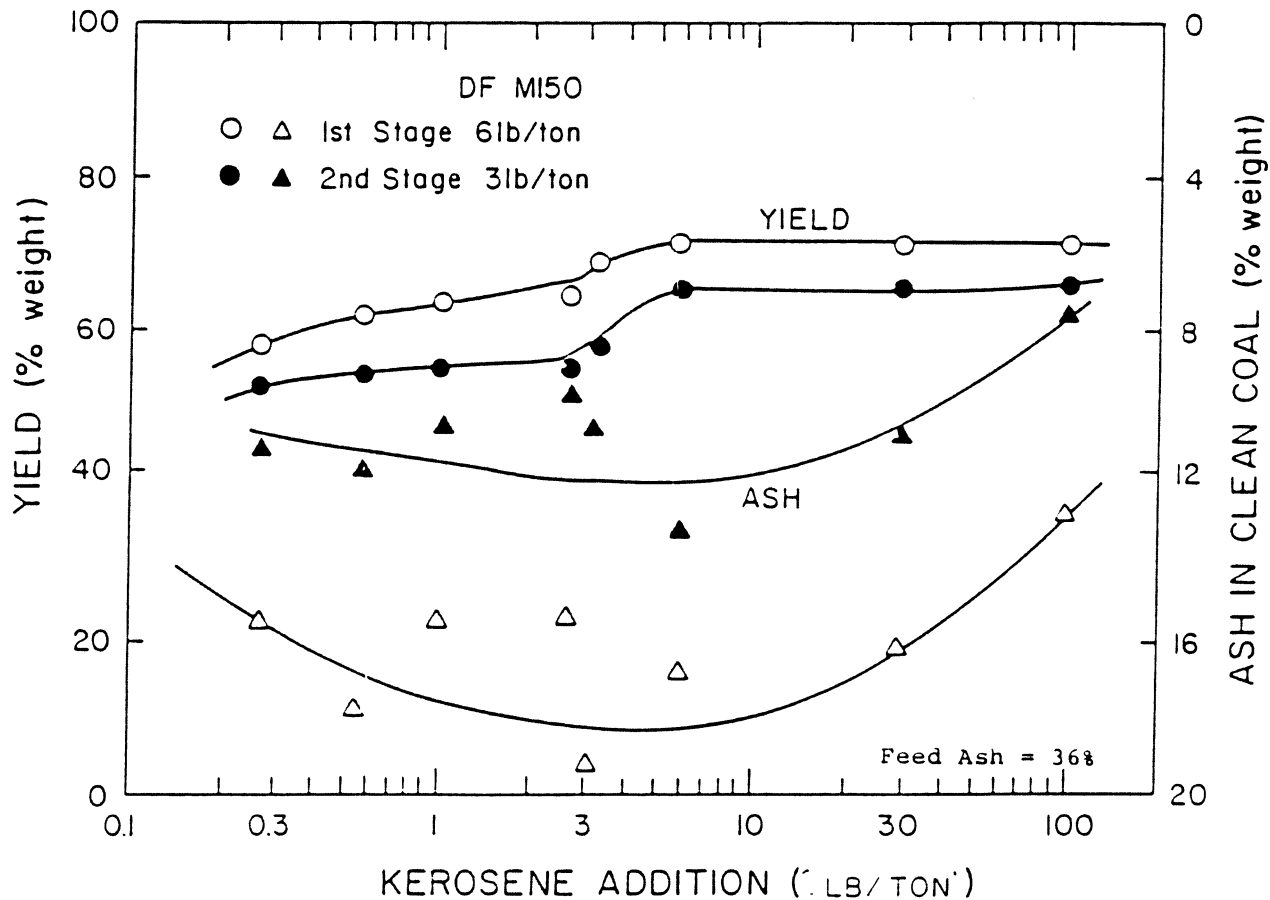

Figure 31. Results of two stage flotation tests conducted on -100 mesh Eagle coal using varying amounts of kerosene and microbubbles generated by the aspirator technique with 6 lb/ton of Dowfroth M150 in the first stage and 3 lb/ton of Dowfroth M150 in the second stage.

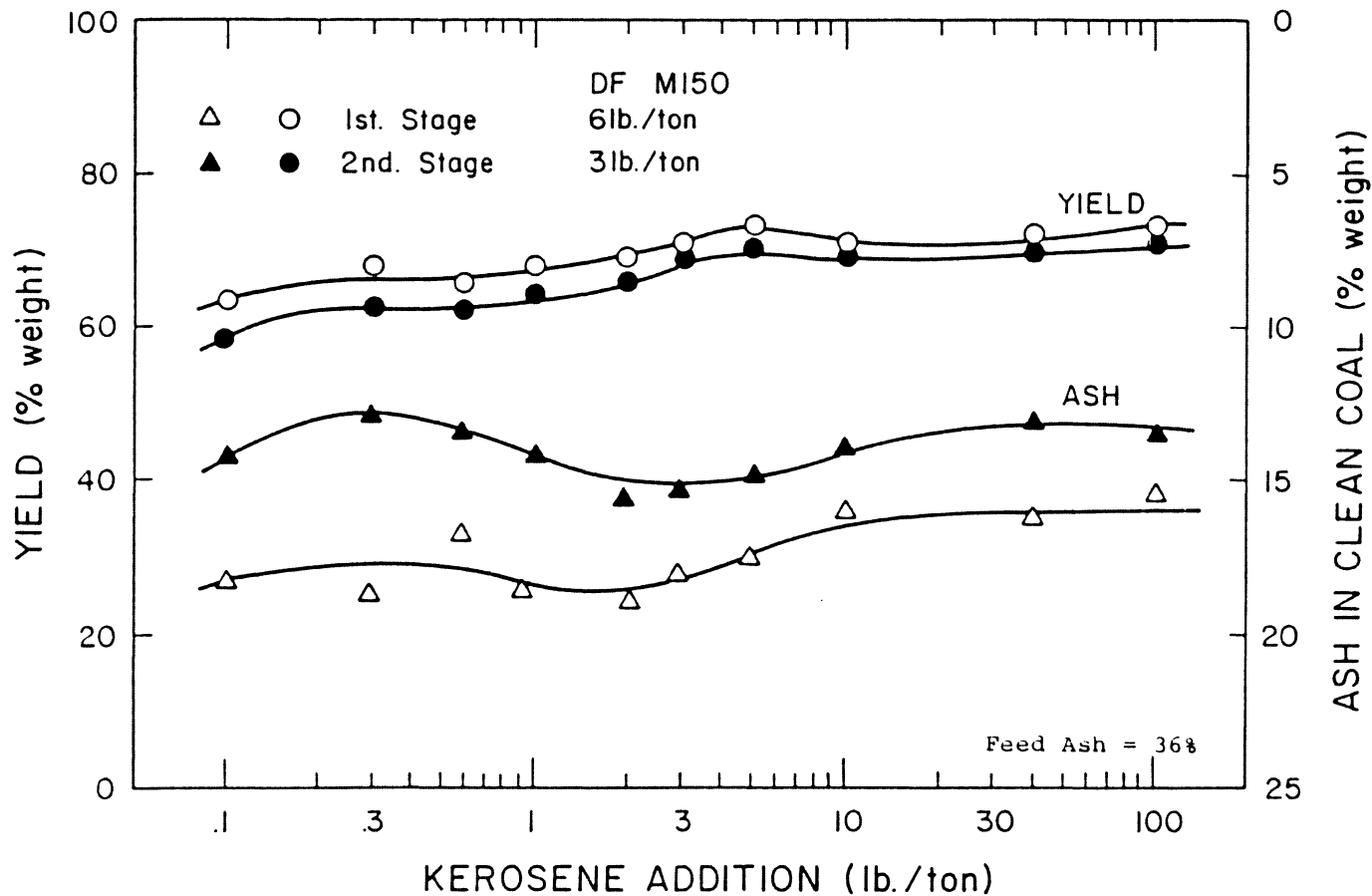

Figure 32. Results of two stage flotation tests conducted on -100 mesh Eagle coal using varying amounts of kerosene and microbubbles generated by the blender technique with 6 lb/ton of Dowfroth M150 in the first stage and 3 lb/ton of Dowfroth M150 in the second stage.

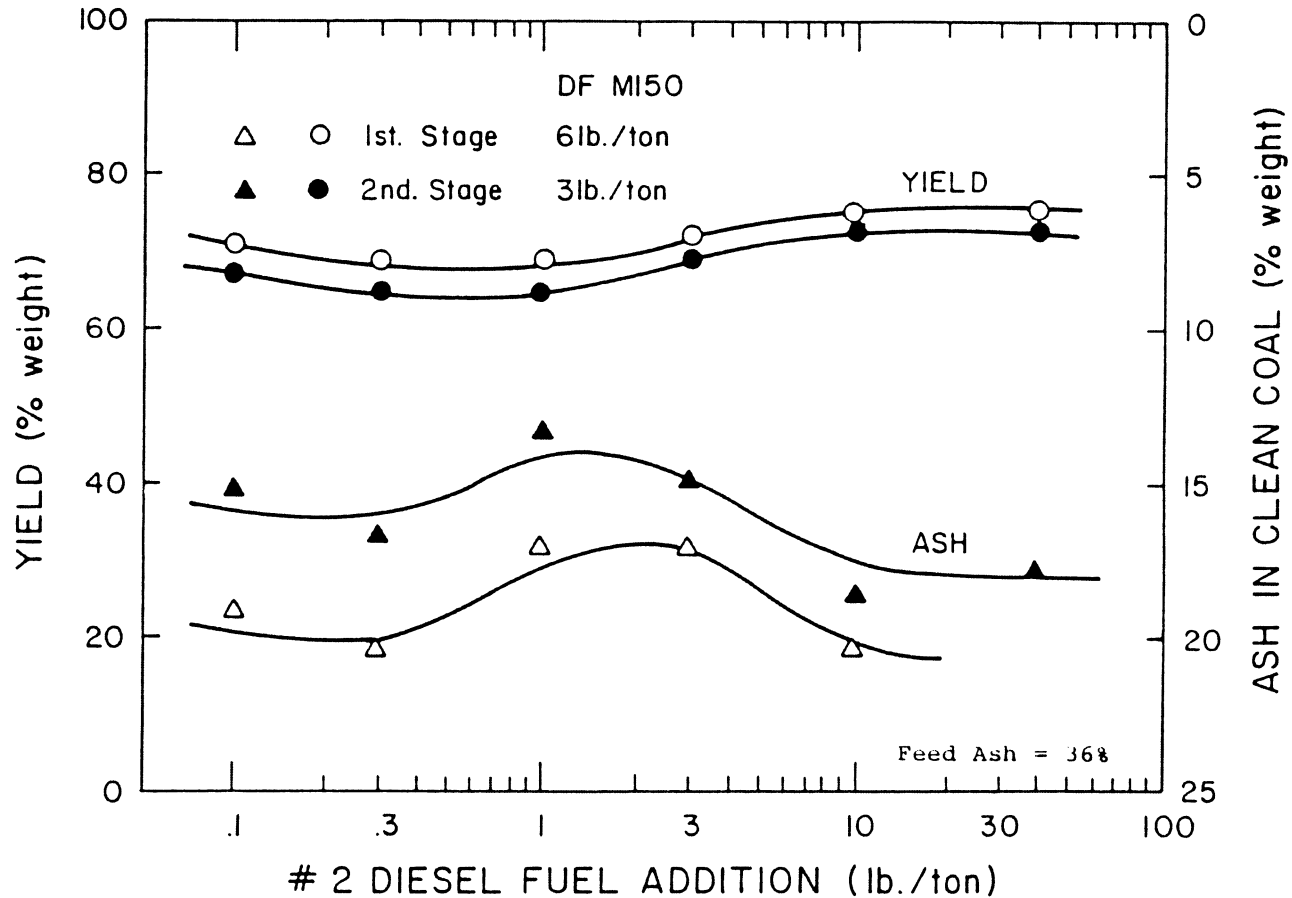

Figure 33. Results of two stage flotation tests conducted on -100 mesh Eagle coal using varying amounts of #2 diesel fuel and microbubbles generated by the blender technique with 6 lb/ton of Dowfroth M150 in the first stage and 3 lb/ton of Dowfroth M150 in the second stage.

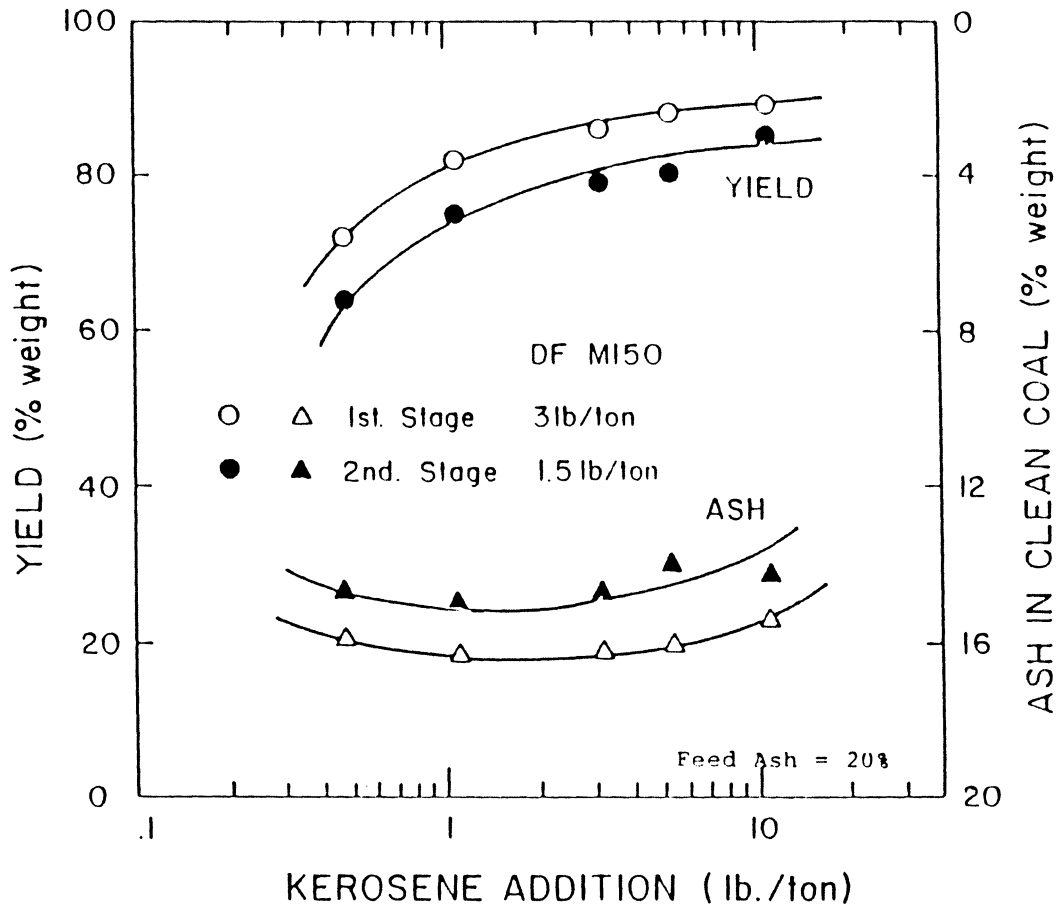

Figure 34. Results of two stage flotation tests conducted on -100 mesh R & F coal using varying amounts of kerosene and micro-bubbles generated by the aspirator technique with 6 lb/ton of Dowfroth M150 in the first stage and 3 lb/ton of Dowfroth M150 in the second stage.

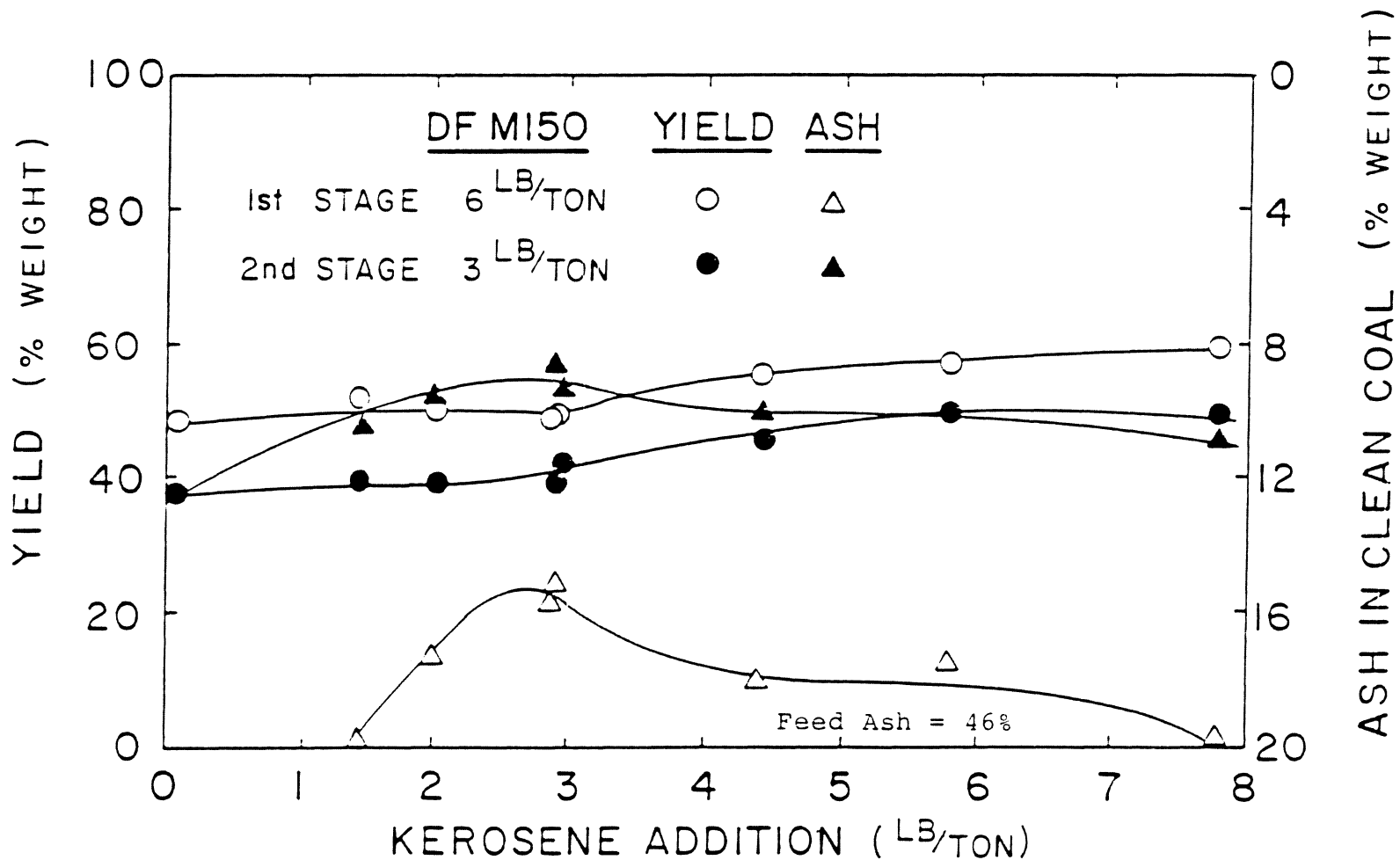

Figure 35. Results of two stage flotation tests conducted on -400 mesh Taggart coal using varying amounts of kerosene and micro-bubbles generated by the aspirator technique with 6 lb/ton of Dowfroth M150 in the first stage and 3 lb/ton of Dowfroth M150 in the second stage.

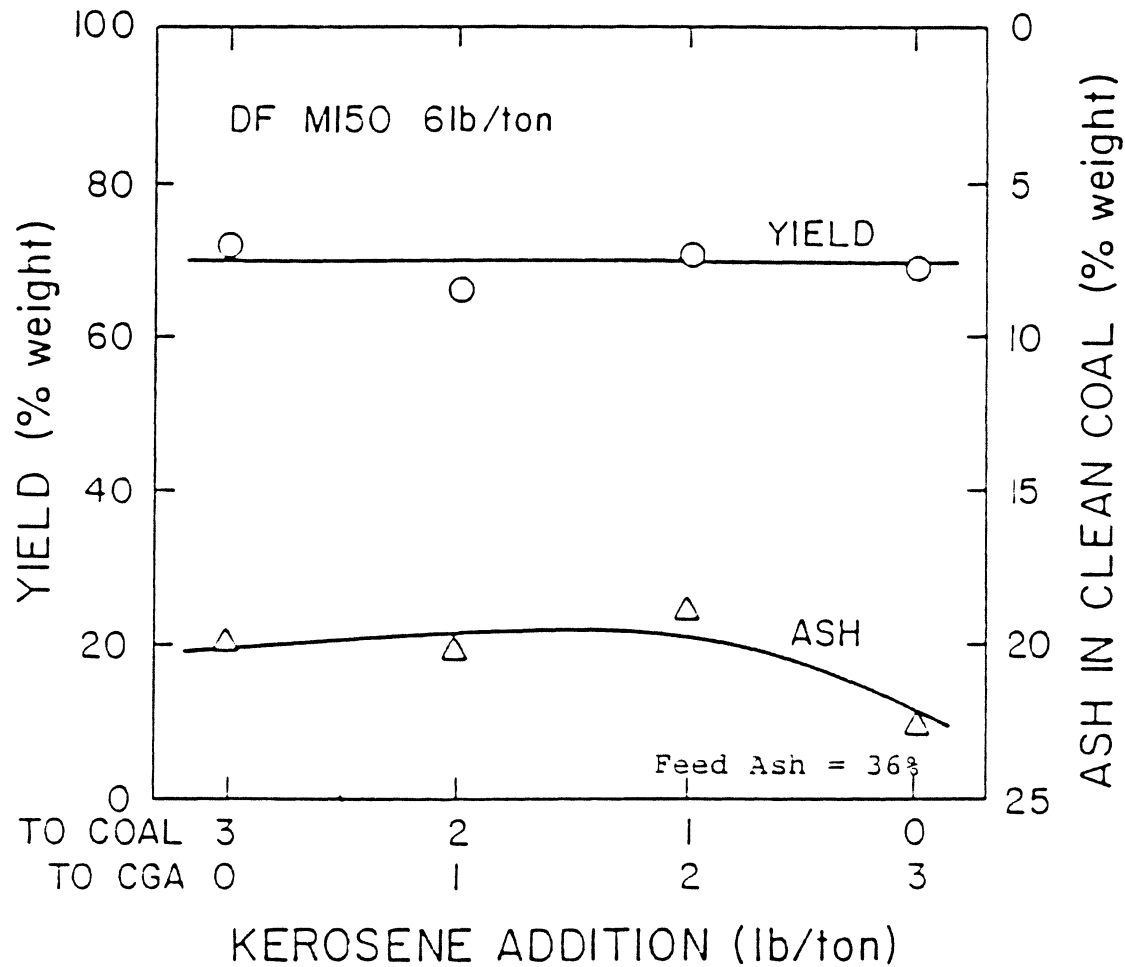

Figure 36. Results of flotation tests conducted on -100 mesh Eagle coal using 3 lb/ton of kerosene and microbubbles generated by the blender technique with 6 lb/ton of Dowfroth M150. Different portions of the kerosene were added directly to the microbubbles.

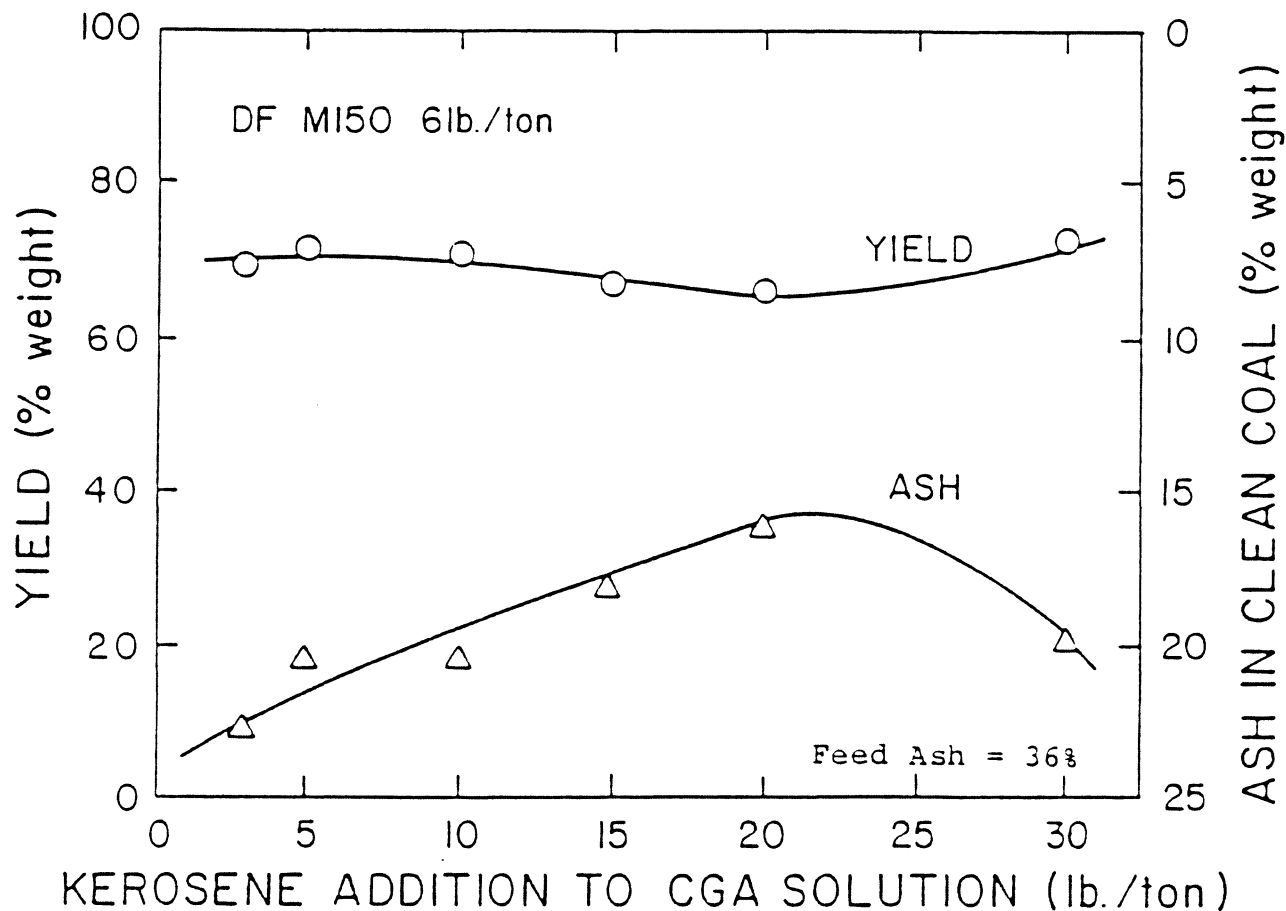

Figure 37. Results of flotation tests conducted on -100 mesh Eagle coal using varying amounts of kerosene and microbubbles generated by the blender technique with 6 lb/ton of Dowfroth M150. The kerosene was added directly to the microbubbles.

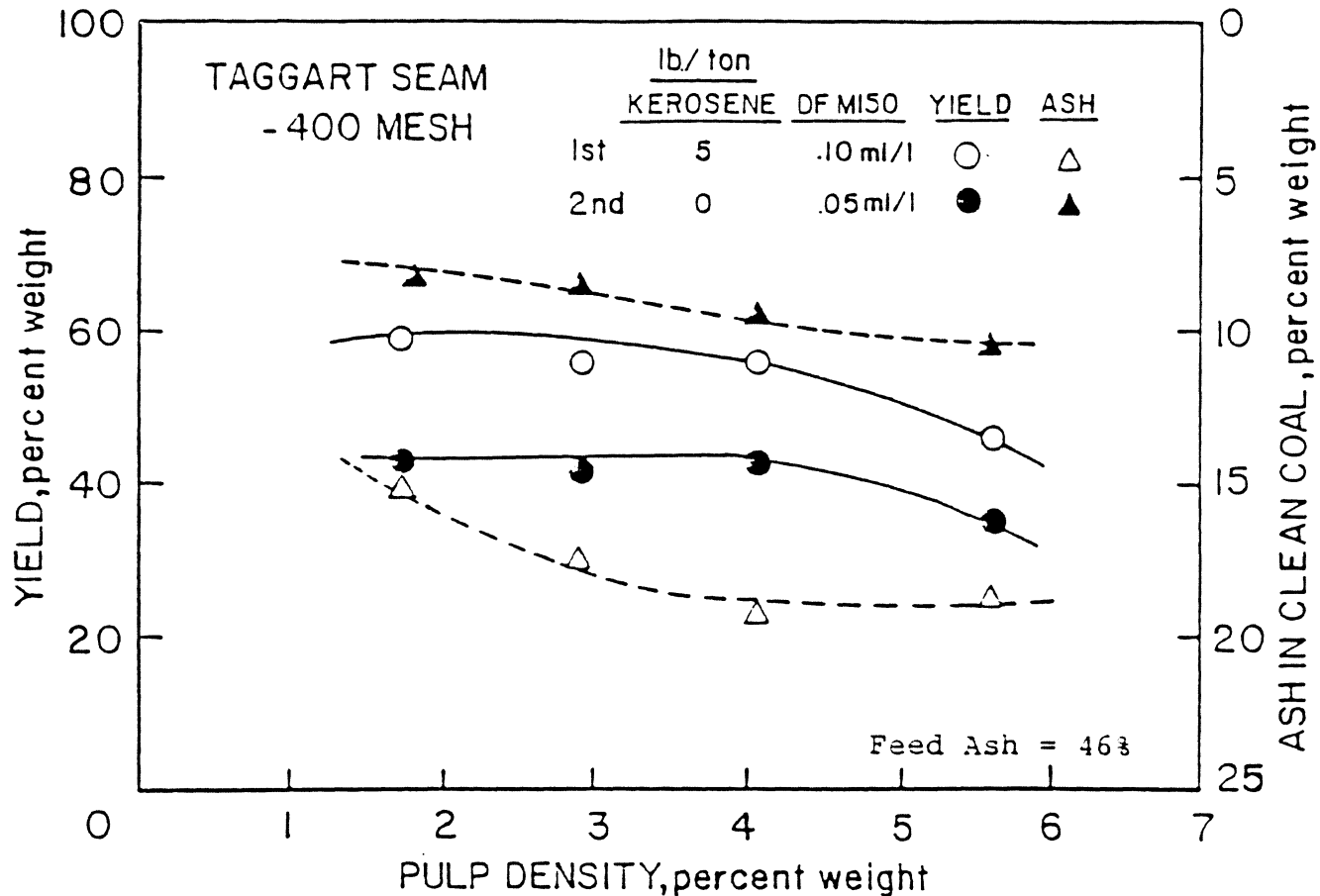

Figure 38. Results of two stage flotation tests conducted on -400 mesh Taggart coal using 5 lb/ton of kerosene and microbubbles generated by the aspirator technique with 0.10 ml/l of Dowiroth M150 in the first stage and 0.5 ml/l of Dowiroth M150 in the second stage. The pulp density (sample size) was varied in each test.

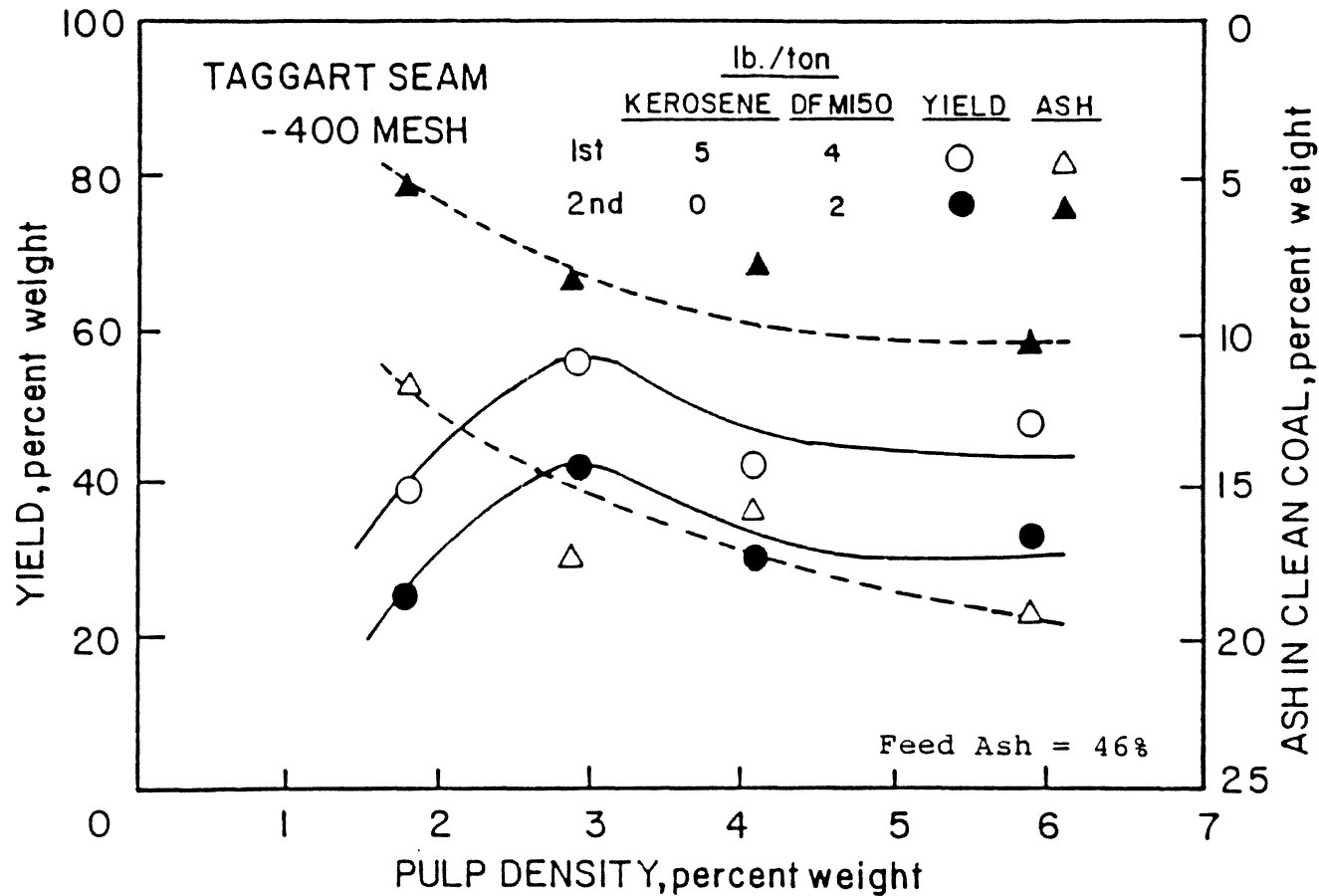

Figure 39. Results of two stage flotation tests conducted on -400 mesh Taggart coal using 5 lb/ton of Dowfroth M150 and microbubbles generated by the aspirator technique with 4 lb/ton of Dowfroth M150 in the first stage and 2 lb/ton of Dowfroth M150 in the second stage. The pulp density (Dowfroth M150 concentration) was varied in each test.

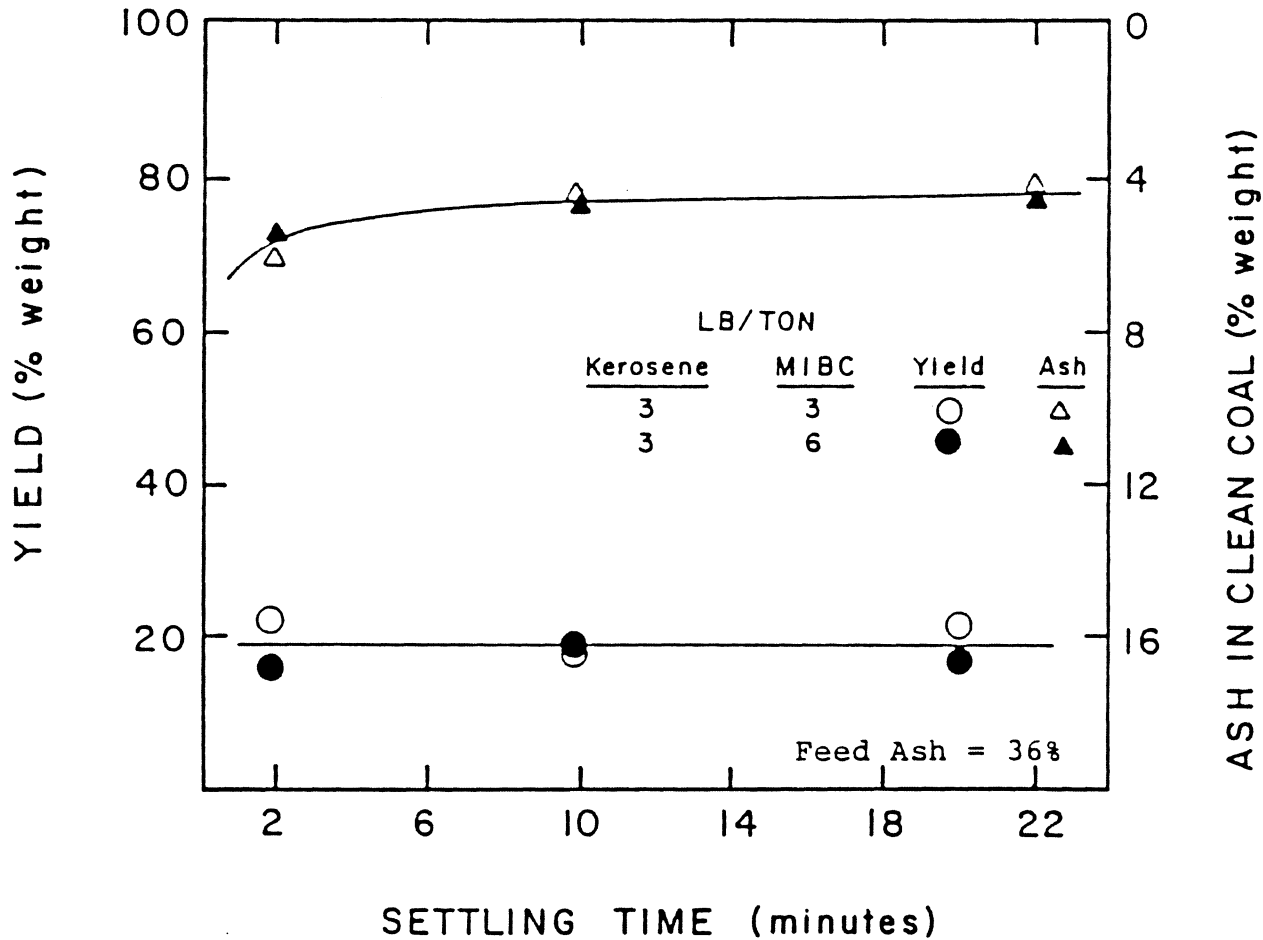

Figure 40. Results of flotation tests conducted on -100 mesh Eagle coal using 3 lb/ton of kerosene and microbubbles generated by the aspirator technique with 6 lb/ton of MIBC in one series and 3 lb/ton of MIBC in the other series. The amount of time allowed for the ash to settle was varied in each test.

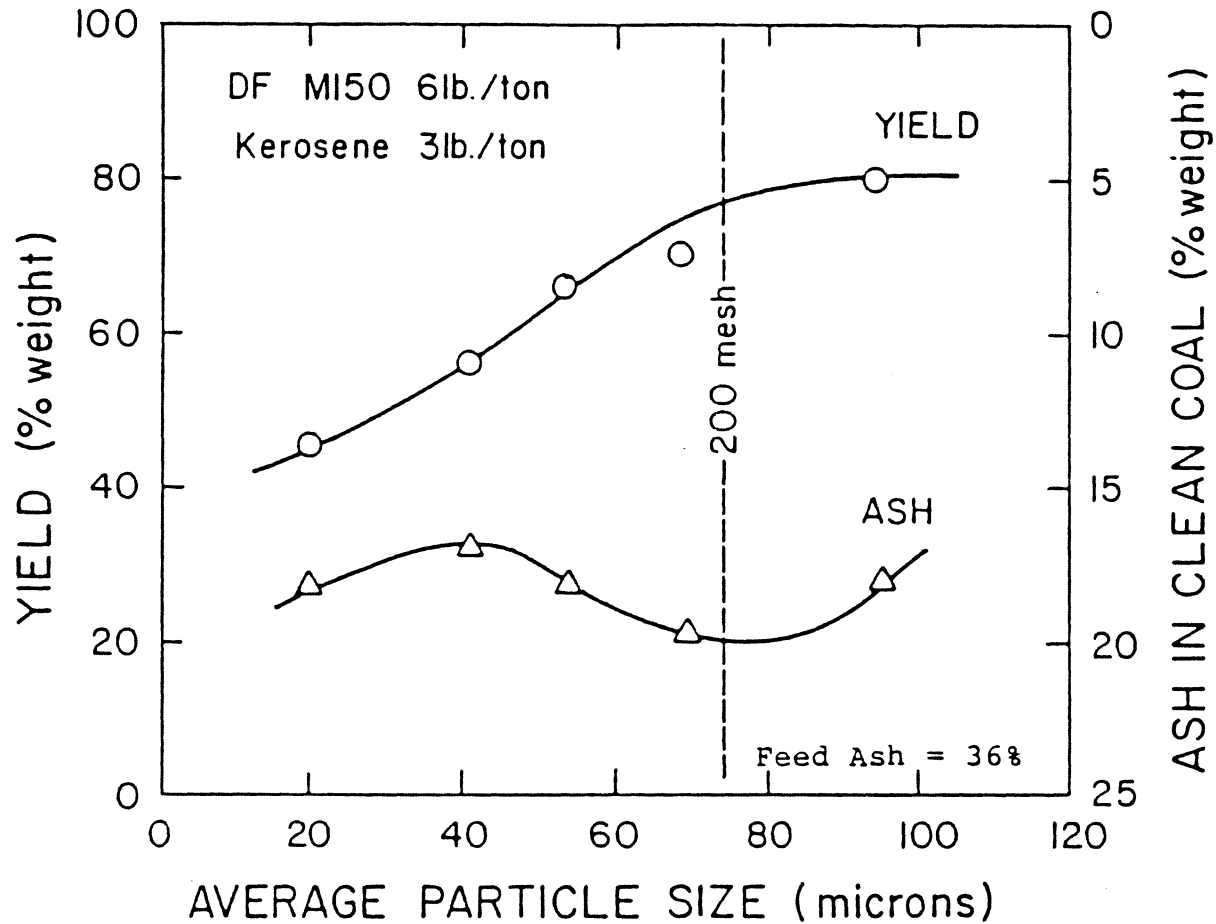

Figure 41. Results of flotation tests conducted on various size fractions of the Eagle coal using 3 lb/ton of kerosene and microbubbles generated by the aspirator technique with 6 lb/ton of Dowfroth M150.

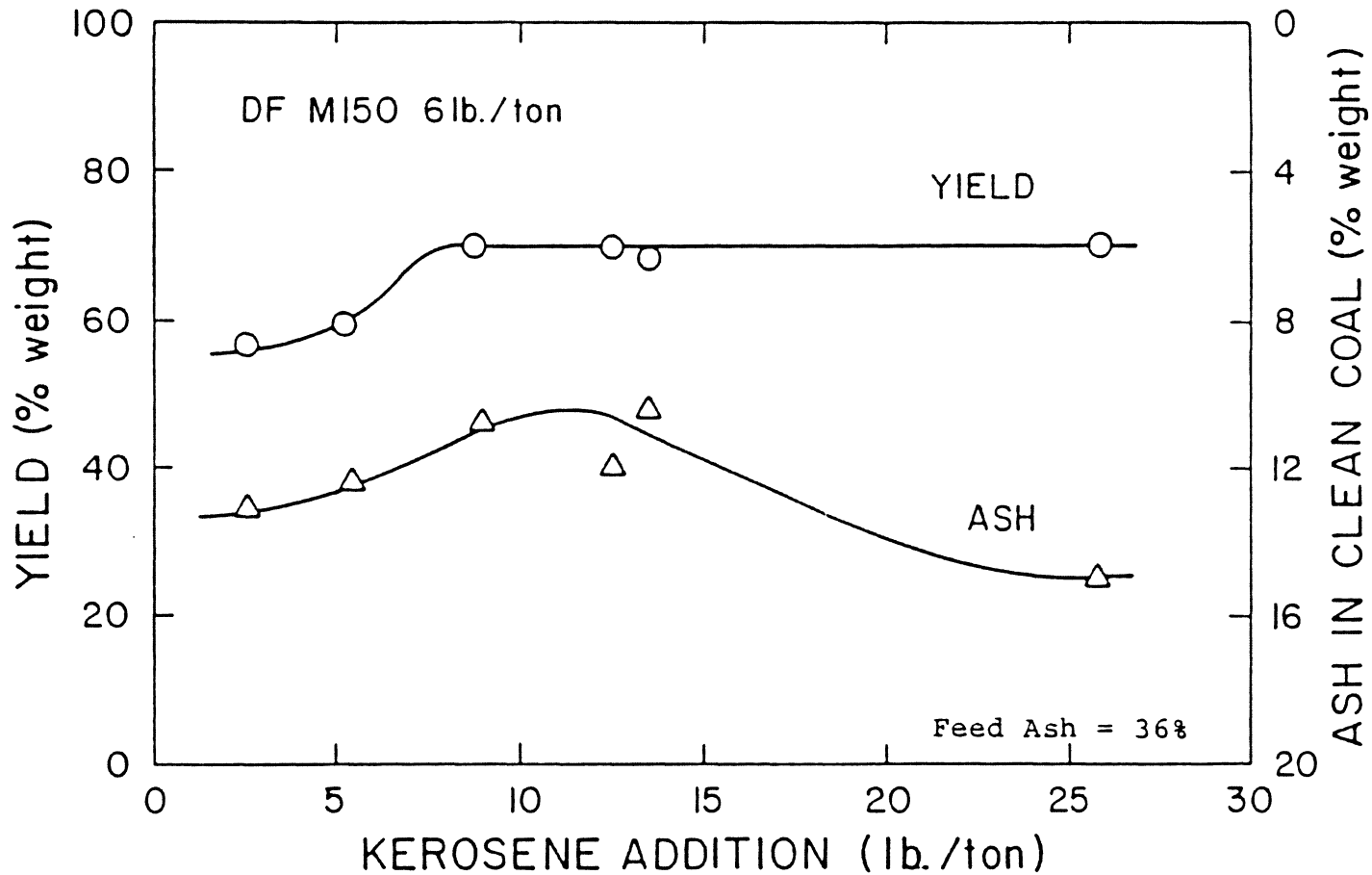

Figure 42. Results of flotation tests conducted on attrition ground Eagle coal using varying amounts of kerosene and microbubbles generated by the aspirator technique with 6 lb/ton of Dowfroth M150.

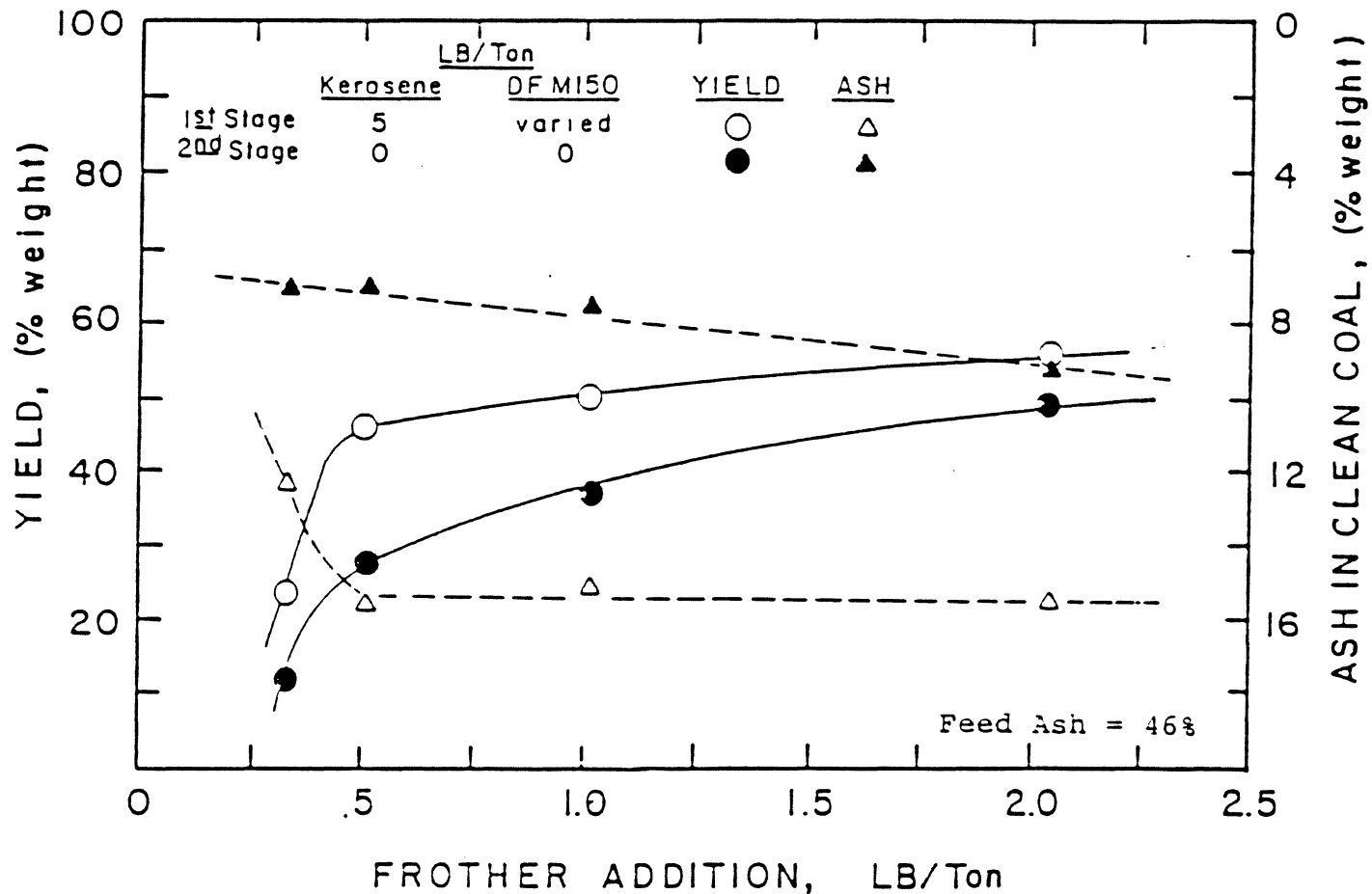

Figure 43. Results of conventional flotation tests conducted on -400 mesh Taggart coal using 5 lb/ton of kerosene and using varying amounts of Dowfroth M150 in the first stage.

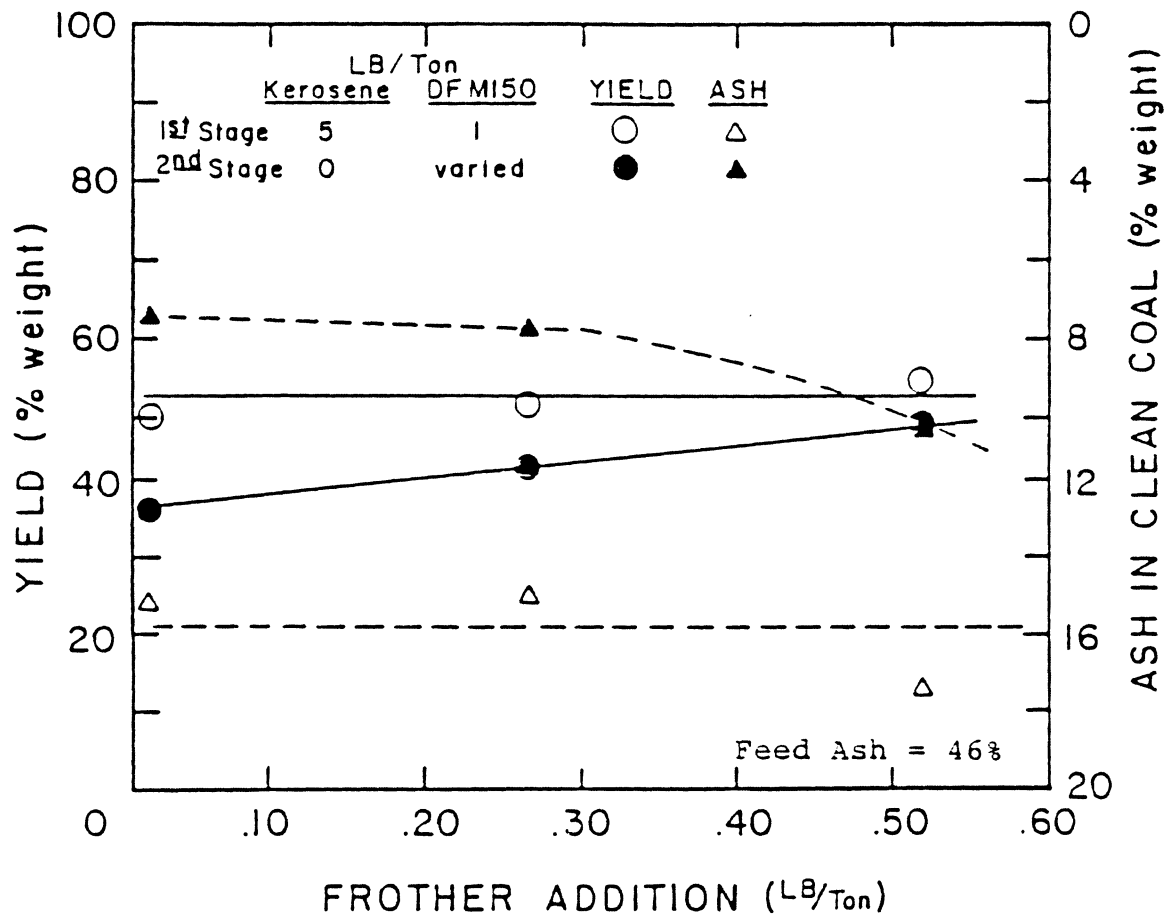

Figure 44. Results of conventional flotation tests conducted on -400 mesh Taggart coal using 5 lb/ton of kerosene and using 1 lb/ton of Dowfroth M150 in the first stage and varying amounts of Dowfroth M150 in the second stage.

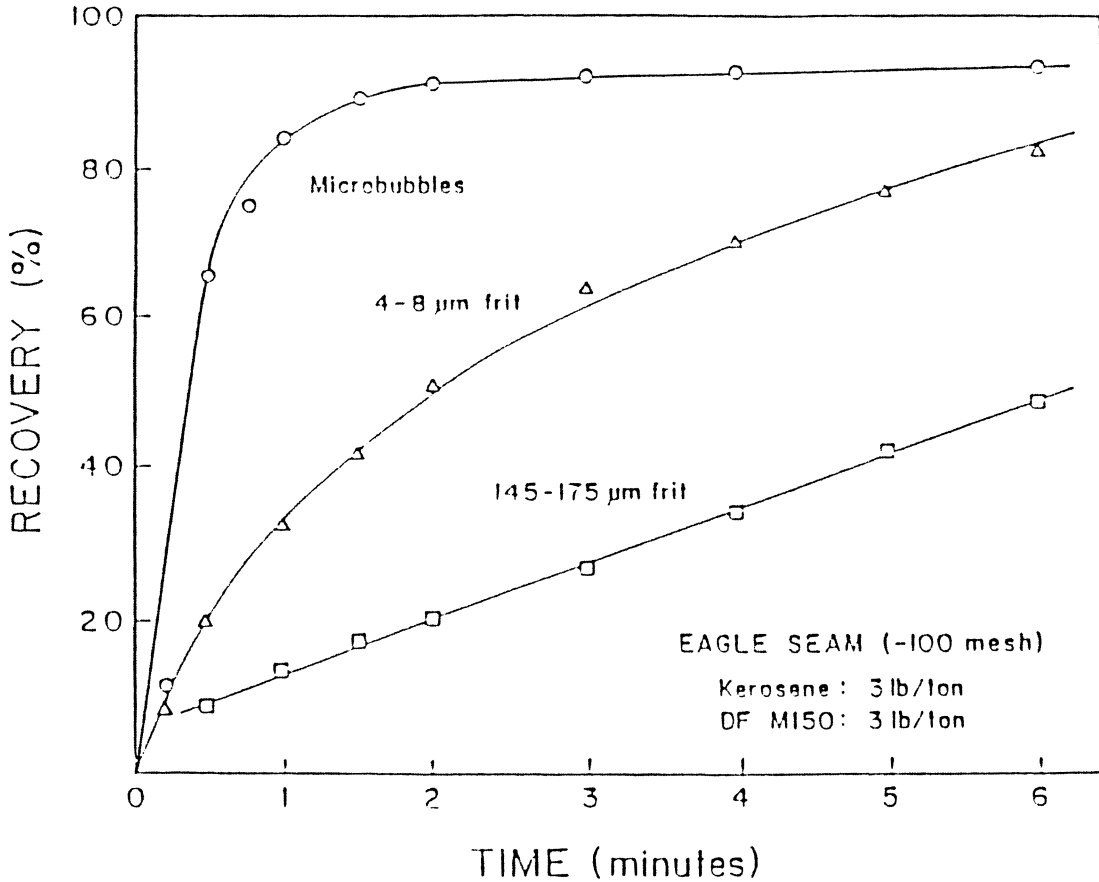

Figure 45. Recovery of coal as a function of time of flotation tests conducted on -100 mesh Eagle coal using 3 lb/ton of kerosene and bubbles generated with 3 lb/ton of Dowfroth M150. Microbubbles were generated using the aspirator technique and other bubbles were produced using frits having porosities of 4-8 microns and 145-175 microns respectively.

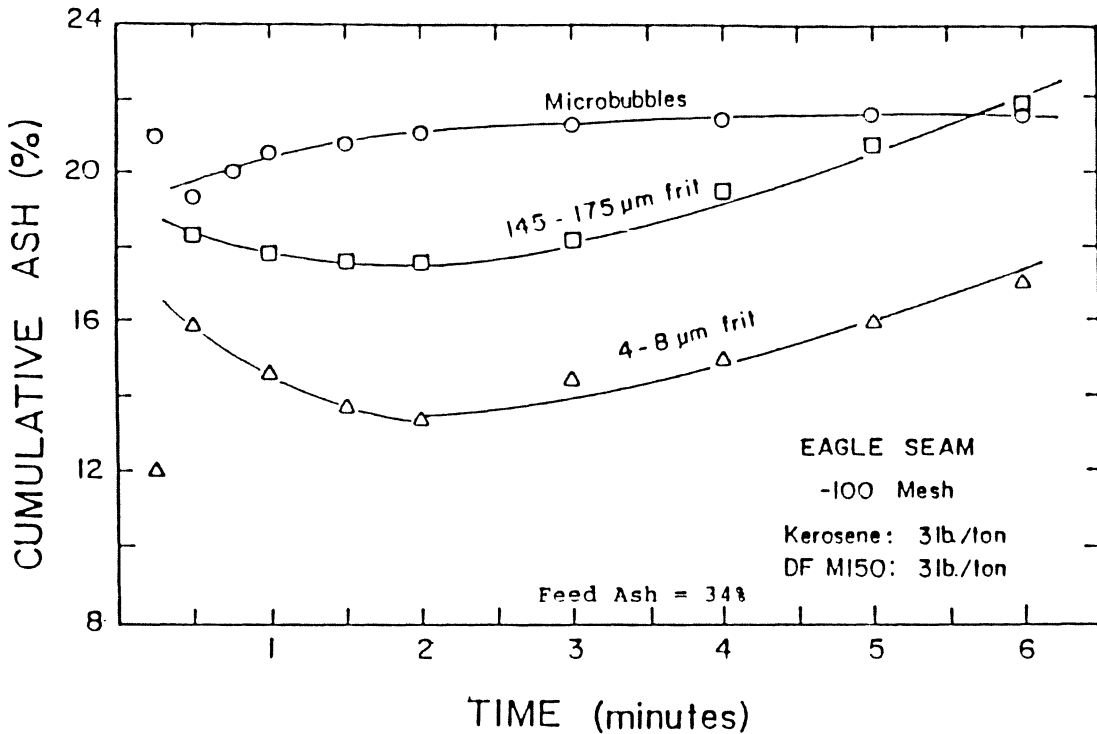

Figure 46. Cumulative ash of clean coal as a function of time of flotation tests conducted on -100 mesh Eagle coal using 3 lb/ton of kerosene and bubbles generated with 3 lb/ton of Dowfroth M150. Microbubbles were generated using the aspirator technique and other bubbles were produced using frits having porosities of 4-8 microns and 145-175 microns respectively.

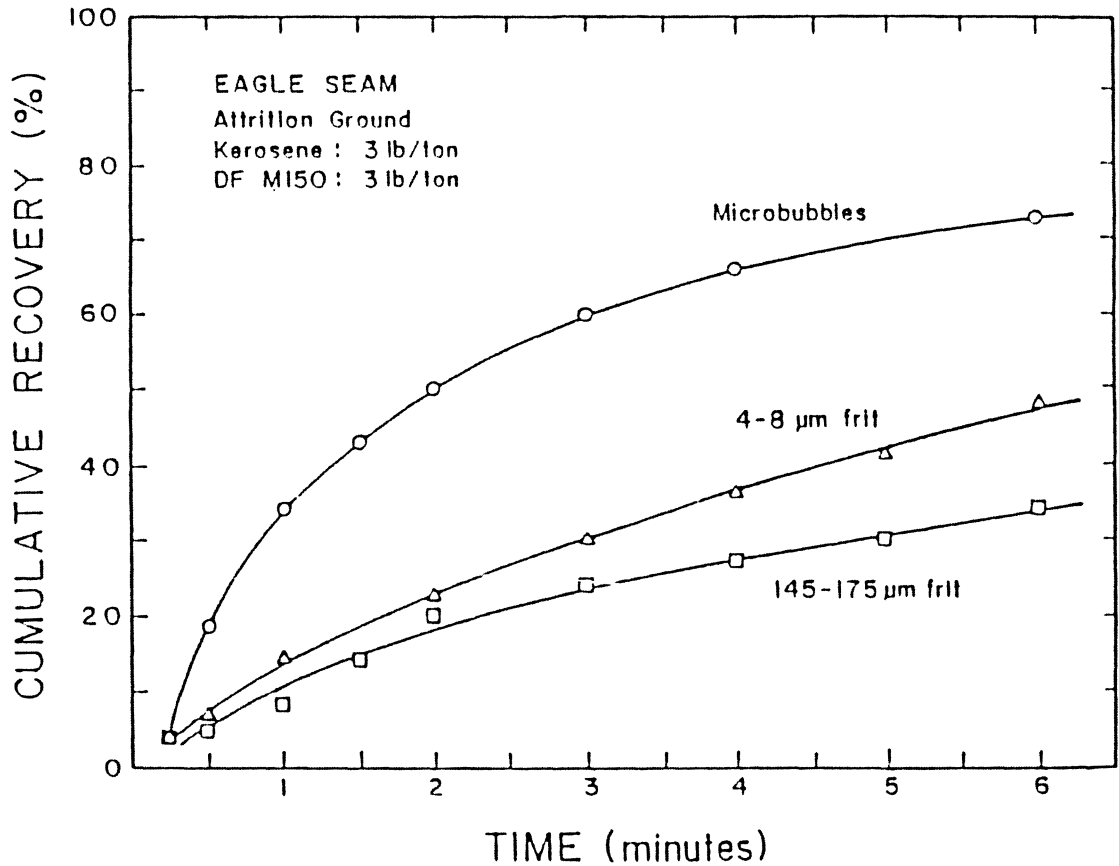

Figure 47. Recovery of coal as a function of time of flotation tests conducted on attrition ground Eagle coal using 3 lb/ton of kerosene and bubbles generated with 3 lb/ton of Dowfroth M150. Microbubbles were generated using the aspirator technique and other bubbles were produced using frits having porosities of 4-8 microns and 145-175 microns respectively.

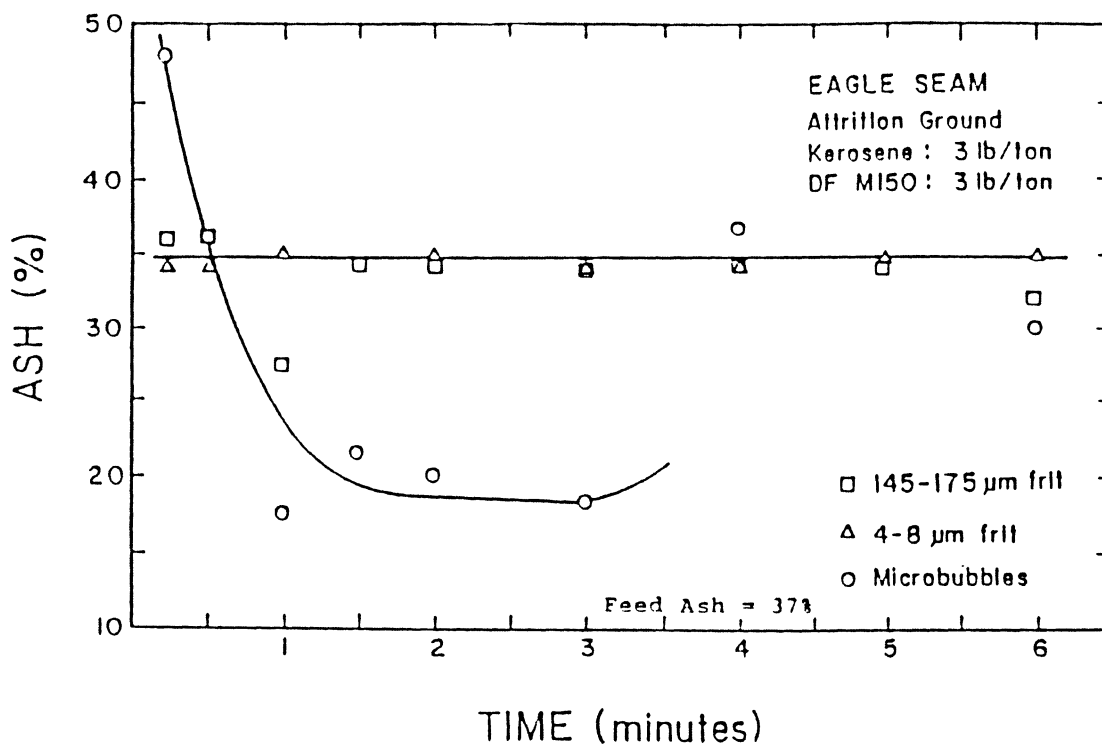

Figure 48. Incremental ash of clean coal as a function of time of flotation tests conducted on attrition ground Eagle coal using 3 lb/ton of kerosene and bubbles generated with 3 lb/ton of Dowfroth M150. Microbubbles were produced using frits having porosities of 4-8 microns and 145-175 microns respectively.

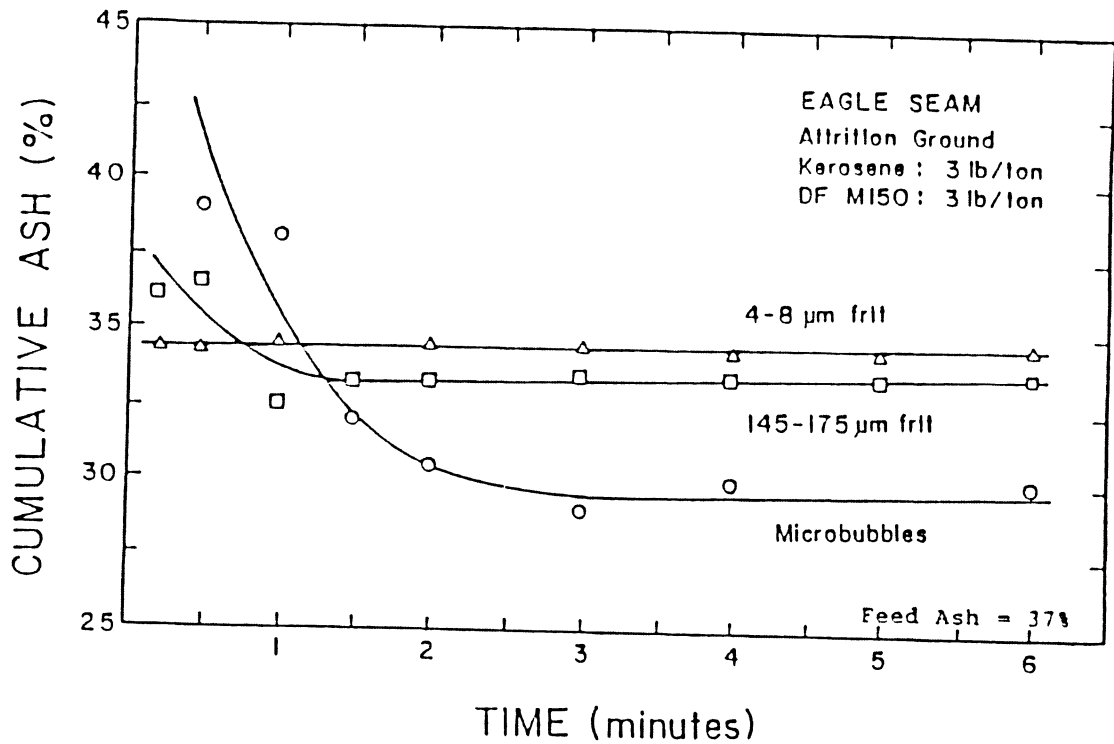

Figure 49. Cumulative ash of clean coal as a function of time of flotation tests conducted on attrition ground Eagle coal using 3 lb/ton of kerosene and bubbles generated with 3 lb/ton of Dowfroth M150. Microbubbles were generated using the aspirator technique and other bubbles were produced using frits having porosities of 4-8 microns and 145-175 microns respectively.

TABLES

TABLE I
Coal Samples

<u>Coal Seam (As received)</u>	<u>Preparation Plant</u>	<u>Ash Content</u>
Eagle (ROM)	Wellmore #7 & 8 Plants Big Rock, VA United Coal Co.	36%
Taggart (-10 mesh)	Bullit Plant Appalachia, VA Westmoreland Coal Co.	46%
Jawbone (ROM)	Moss #3 Plant Carbo, VA Clinchfield Coal Co.	24%
Meigs Creek #9 Pittsburgh #8 & Waynesburg #11 (ROM)	Rice Plant Cadiz, OH R & F Coal Co.	20%

TABLE II

Reagents

<u>Reagent</u>	<u>Source</u>
Aerofroth 73	American Cyanamid Company
Silicone L7001	Union Carbide Company
Tergitol TMN-6	Union Carbide Company
MIBC	Union Carbide Company
MIBC	Consolidation Coal Company
Pine Oil	Hercules Incorporated
Dowfroth 200	Dow Chemical Company
Dowfroth 250	Dow Chemical Company
Dowfroth 400	Dow Chemical Company
Dowfroth M150	Dow Chemical Company
Dowfroth M210	Dow Chemical Company
Dowfroth E1128	Dow Chemical Company
Kerosene	Gulf Oil Company
#2 Diesel Fuel	Consolidation Coal Company

TABLE III

Results of the Flotation Tests Conducted
on the -100 Mesh Eagle Coal

<u>Product</u>	Conventional		Microbubble (1)		Microbubble (2)	
	<u>Yield</u>	<u>Ash</u>	<u>Yield</u>	<u>Ash</u>	<u>Yield</u>	<u>Ash</u>
2nd stage	59.2	7.8	61.4	10.5	-	-
1st stage	65.6	13.3	70.8	16.2	49.4	8.6
Feed	100.0	36.4	100.0	36.3	100.0	35.7

Reagent (lb/ton)

Kerosene	3.1	2.9	2.7
1st stage M150	2.0	4.2	1.0 + 5.6 MIBC
2nd stage M150	0	1.9	-

TABLE IV

Results of the Flotation Tests Conducted
on the -100 Mesh R & F Coal

<u>Product</u>	<u>Conventional</u>		<u>Microbubble</u>	
	<u>Yield</u>	<u>Ash</u>	<u>Yield</u>	<u>Ash</u>
2nd stage	77.0	12.3	78.7	14.6
1st stage	81.4	13.4	86.1	16.2
Feed	100.0	19.7	100.0	20.5

Reagent (lb/ton)

Kerosene	3.1	3.2
1st stage M150	1.0	3.2
2nd stage M150	0	1.7

TABLE V

Results of the Flotation Tests Conducted
on the -400 Mesh Taggart Coal

<u>Product</u>	<u>Conventional</u>		<u>Microbubble</u>	
	<u>Yield</u>	<u>Ash</u>	<u>Yield</u>	<u>Ash</u>
2nd stage	43.5	7.8	49.0	8.2
1st stage	51.8	14.8	61.3	13.9
Feed	100.0	39.0	100.0	38.3

Reagent (lb/ton)

Kerosene	5.1	5.0
1st stage M150	1.0	4.6
2nd stage M150	0.3	2.3

TABLE VI

Results of the Flotation Tests Conducted
on the Attrition Ground Eagle Coal

<u>Product</u>	<u>Conventional</u>		<u>Microbubble</u>	
	<u>Yield</u>	<u>Ash</u>	<u>Yield</u>	<u>Ash</u>
2nd stage	51.9	21.8	-	-
1st stage	72.3	20.6	70.2	12.0
Feed	100.0	36.6	100.0	34.9

Reagent (lb/ton)

Kerosene	12.3	12.6
1st stage M150	1.0	6.8
2nd stage M150	0	-

TABLE VII

Summary of the Results of the
Conventional Versus Microbubble Flotation Tests

<u>Sample</u>	<u>Product</u>	<u>Conventional</u>		<u>Microbubble</u>	
		<u>Yield</u>	<u>Ash</u>	<u>Yield</u>	<u>Ash</u>
-100 Eagle	2nd stage	59.2	7.8	61.4	10.5
	1st stage	65.6	13.3	70.8	16.2
	Feed	100.0	36.4	100.0	36.3
-100 R & F	2nd stage	77.0	12.3	78.7	14.6
	1st stage	81.4	13.4	86.1	16.2
	Feed	100.0	19.7	100.0	20.5
-400 Taggart	2nd stage	43.5	7.8	49.0	8.2
	1st stage	51.8	14.8	61.3	13.9
	Feed	100.0	39.0	100.0	38.3
Attrition ground Eagle	2nd stage	51.9	21.8	-	-
	1st stage	72.3	20.6	70.2	12.0
	Feed	100.0	36.6	100.0	34.9

APPENDIX

Material Balance Sheets for
Kinetics Tests

TEST: 162
 SAMPLE: -100 EAGLE
 MICROBUBBLE GENERATOR: ASPIRATOR
 KEROSENE: 3.3 LB/TON
 FROTHER: M150 2.9 LB/TON
 FROTHER CONC: .082 ML/LITER
 FROTHER CONC IN CELL: .049 ML/LITER
 PULP DENSITY: 1.8%

TIME	WT%	ASH%	ASH DIST	C ASH DIST	COAL DIST	C COAL DIST
.25	10.4	20.9	6.4	6.4	12.5	12.5
.50	43.3	18.9	24.1	30.6	53.2	65.7
.75	8.7	24.7	6.3	36.9	9.9	75.5
1.00	7.5	22.1	4.9	41.8	8.9	84.4
1.50	4.4	28.4	3.7	45.4	4.7	89.2
2.00	1.9	36.5	2.0	47.5	1.8	91.0
3.00	.9	36.5	1.0	48.5	.9	91.9
4.00	.6	36.5	.6	49.1	.5	92.4
6.00	.2	36.5	.2	49.3	.2	92.6
TAIL	22.1	77.9	50.7	100.0	7.4	100.0
		33.9				

TEST: 163
 SAMPLE: -100 EAGLE
 FRIT POROSITY: 145-175 MML

KEROSENE: 3.2 LB/TON
 FROTHER: M150 3.5 LB/TON
 FROTHER CONC IN CELL: .034 ML/LITER
 PULP DENSITY: 1.9%

TIME	WT%	ASH%	ASH DIST	C ASH DIST	COAL DIST	C COAL DIST
.50	7.4	18.3	4.0	4.0	9.3	9.3
1.00	3.8	16.9	1.8	5.8	4.8	14.0
1.50	2.2	16.6	1.1	6.9	2.8	16.9
2.00	2.7	16.6	1.3	8.2	3.4	20.3
3.00	5.4	20.2	3.2	11.3	6.6	26.9
4.00	6.6	23.5	4.5	15.8	7.7	34.6
5.00	6.7	26.1	5.1	20.9	7.6	42.1
6.00	6.2	27.9	5.0	25.9	6.9	49.0
TAIL	59.0	43.3	74.1	100.0	51.0	100.0
		34.5				

TEST: 164
 SAMPLE: -100 EAGLE
 FRIT POROSITY: 4-8 MML

KEROSENE: 3.3 LB/TON
 FROTHER: M150 3.1 LB/TON
 FROTHER CONC IN CELL: .029 ML/LITER
 PULP DENSITY: 1.8%

TIME	WT%	ASH%	ASH DIST	C ASH DIST	COAL DIST	C COAL DIST
.25	6.6	12.0	2.3	2.3	8.8	8.8
.50	9.4	18.5	5.1	7.5	11.6	20.4
1.00	9.7	12.5	3.6	11.1	12.8	33.2
1.50	6.7	10.2	2.0	13.1	9.1	42.3
2.00	6.5	12.0	2.3	15.4	8.7	51.0
3.00	10.6	18.3	5.7	21.1	13.1	64.0
4.00	5.4	20.6	3.3	24.4	6.4	70.5
5.00	5.7	24.5	4.1	28.5	6.5	77.0
6.00	5.0	29.5	4.4	32.9	5.4	82.4
TAIL	34.3	66.0	67.1	100.0	17.6	100.0
		33.8				

TEST: 166

SAMPLE: ATT EAGLE

MICROBUBBLE GENERATOR: ASPIRATOR

KEROSENE: 2.5 LB/TON

FROTHER: M150 2.4 LB/TON

FROTHER CONC: .082 ML/LITER

FROTHER CONC IN CELL: .049 ML/LITER

PULP DENSITY: 2.4%

TIME	WT%	ASH%	ASH DIST	C ASH DIST	COAL DIST	C COAL DIST
.25	4.6	47.9	5.9	5.9	3.8	3.8
.50	14.5	36.4	14.2	20.0	14.7	18.5
.62	7.8	34.6	7.2	27.3	8.1	26.6
1.00	5.9	17.6	2.8	30.0	7.7	34.3
1.50	6.6	21.7	3.9	33.9	8.3	42.6
2.00	5.9	20.0	3.2	37.1	7.6	50.2
3.00	7.3	18.4	3.6	40.7	9.5	59.7
4.00	6.8	36.7	6.7	47.3	6.8	66.5
6.00	5.6	29.8	4.5	51.8	6.3	72.8
TAIL	35.0	51.3	48.2	100.0	27.2	100.0
		37.3				

TEST: 168
 SAMPLE: ATT EAGLE
 FRIT POROSITY: 4-8 MML

KEROSENE: 3.8 LB/TON
 FROTHER: M150 3.7 LB/TON
 FROTHER CONC IN CELL: .030 ML/LITER
 PULP DENSITY: 1.6%

TIME	WT%	ASH%	ASH DIST	C ASH DIST	COAL DIST	C COAL DIST
.25	3.4	34.0	3.1	3.1	3.6	3.6
.50	3.3	34.0	2.9	6.0	3.5	7.0
1.00	6.6	34.7	6.1	12.1	6.9	13.9
2.00	7.3	34.7	6.8	18.8	7.7	21.6
3.00	7.9	34.1	7.2	26.0	8.4	30.0
4.00	6.0	33.7	5.4	31.4	6.4	36.4
5.00	4.7	34.6	4.3	35.7	4.9	41.3
6.00	6.4	35.1	6.0	41.7	6.7	48.0
TAIL	54.4	40.4	58.3	100.0	52.0	100.0
		37.7				

TEST: 167
 SAMPLE: ATT EAGLE
 FRIT POROSITY: 145-175 MML

KEROSENE: 3.0 LB/TON
 FROTHER: M150 2.9 LB/TON
 FROTHER CONC IN CELL: .030 ML/LITER
 PULP DENSITY: 2.0%

TIME	WT%	ASH%	ASH DIST	C ASH DIST	COAL DIST	C COAL DIST
.25	3.3	36.2	3.2	3.2	3.4	3.4
.50	1.2	36.2	1.2	4.4	1.3	4.6
1.00	3.3	27.4	2.4	6.8	3.8	8.5
1.50	4.8	34.1	4.4	11.2	5.0	13.5
2.00	5.9	34.0	5.4	16.5	6.3	19.8
3.00	4.0	33.4	3.6	20.1	4.3	24.0
4.00	2.7	33.9	2.4	22.5	2.8	26.8
5.00	3.2	33.9	2.9	25.4	3.3	30.2
6.00	3.7	32.2	3.2	28.6	4.0	34.2
TAIL	67.9	39.4	71.4	100.0	65.8	100.0
		37.5				

The vita has been removed
from the scanned document