

Haarlemmer Houttuinen Housing  
Amsterdam, Netherlands  
Herman Hertzberger

Hertzberger creates a street atmosphere for pedestrians by layering the spaces for activity to occur. Within these layers of smaller spaces, he seizes every opportunity to articulate elements such as patio, step, and balcony.

The care in elevating the patio just one step above street level allows the resident to feel comfortable in having a distinct space of his own. The concrete block planters surrounding the patio support a sense of personal domain as well as provide an outlet for personal expression.

The articulation of the concrete pad that rises to meet the stair marks the beginning of threshold for the upper floor residents. It is an extension of the front door that waits at the top of the stair.

The balcony step is the meeting of stone pavers and a concrete slab. This single step calls attention not only to a separation of levels, but also to a separation of space. The blunt change of material as well as the canopy overhead create the sense of two outdoor rooms. The step also provides a place to sit when enjoying the outdoors.

The protrusion of the third story, floor-to-ceiling window forces a threshold into space. It breaks the facade allowing the resident not only to take in views which are straight ahead, but also up and down the street. Thus, the extruded window presents another level of privacy in the public realm.

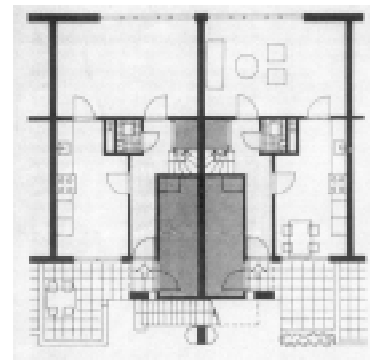

level one plan (29)

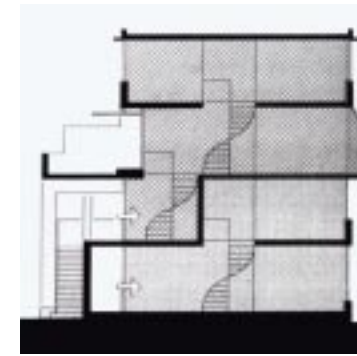

section through unit (30)

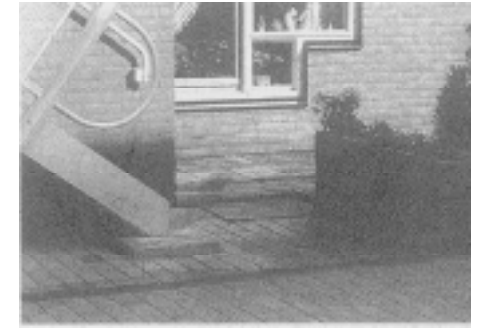

stair to upper level (31)

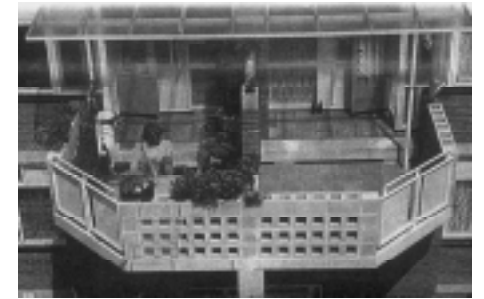

upper level balcony (32)

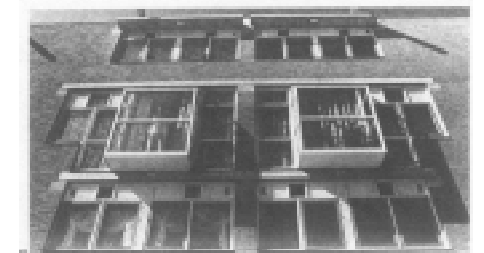

protruding windows on traffic side (33)



view down living street (34)

*"Just as important as the disposition of the residential units vis a vis each other is the fenestration, the placement of bay windows, balconies, terraces, landings, doorsteps, porches - whether they have the correct proportions and how they are spatially organized. It is always a question of finding the right balance to enable the residents to withdraw into privacy when they want to but also to seek contact with others."*

-- Herman Hertzberger

Multi-Story Housing  
Kassel, Germany  
Herman Hertzberger

The residents at Kassel cross many thresholds when entering their apartments: column, stair, seating, stair, front stoop. Hertzberger's use of multiple elements blur the zones of threshold to the point that the entire sequence of reaching the residence becomes a journey through communal living. Upon passing through the columns, one ascends three concrete steps which lead to a steel stairway. Halfway up the stairs is a semi-circular space filled with light. Various levels within this area provide places to sit, sleep, eat, read, and play. Hertzberger refers to it as a "communal space" because it is a continuation of the dwelling. From this point, the door of the residence is in sight. Once in front of the door, one finds that it isn't the front door, or is it? Each apartment has a second glass door which can be locked, thus an open space is acquired. This space can be seen as part of the stairs or an extension of the dwelling. Either way, it is a personal area that becomes a part of a larger, shared space that everyone can enjoy. The step that lies within the doors provides a seating area if the outer door is open or becomes a part of the dwelling floor if the outer door is closed.

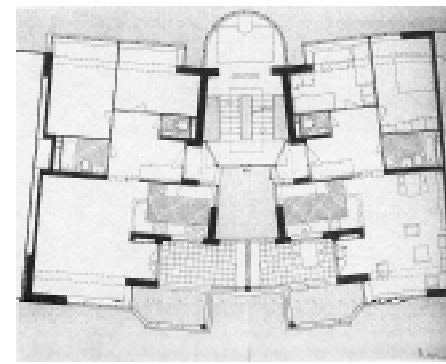

upper level plan (35)

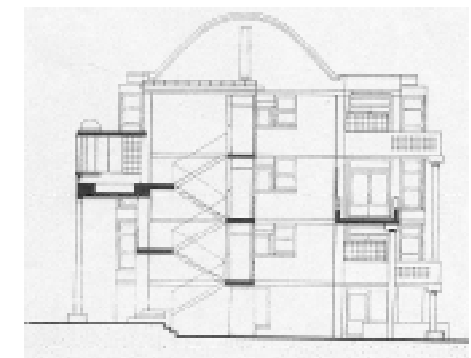

section through unit (36)



elevation (37)

*"The more responsibility users have for an area - and consequently the more influence they can exert on it - the more care and love they will be prepared to invest in it. And the more suitable the area is for their own specific uses the more they will appropriate it. Thus **users** become **inhabitants**."*  
-- Herman Hertzberger



seating area at stair landing (38)



double layered entry (39)

The Cannery Plaza  
San Francisco, California, USA  
Joseph Esherick & Associates

Previously functioning as the Del Monte Canning Warehouse, the Cannery now houses a variety of shops and restaurants. It is located near the touristy Fisherman's Wharf and remains successful as a destination, a resting place, and a path to the wharf.

The renovation gutted the interior and preserved the original brick walls. The quality of the brick retains the character of the canning warehouse and illustrates the ability for brick to take on different personalities, no matter what the demand. It is a friendly material that wants to be touched and enjoys showing off its age.

Within the street facades of this building the activity flourishes. A series of open-air paths form a maze that connects the stairs, escalators, and stores. In a sense, it is treated as a promenade.

At the other end of this building lies a plaza that serves as a transition in elevation. This plaza has many functions; it provides a place for a stage, coffee and snack carts, and seating. The space attracts many people since it offers views to the wharf and allows outdoor activity.



*during renovation, brick walls stabilized (note model of new building in lower right corner) (40)*



*brick wall during use as warehouse (41)*



*after renovation, shops and restaurants connected by network of open-air circulation (42)*



*main entrance of The Cannery today (43)*



*open-air plaza, view of stair to Beach St. (44)*



*open-air plaza, view through gate toward wharf (45)*

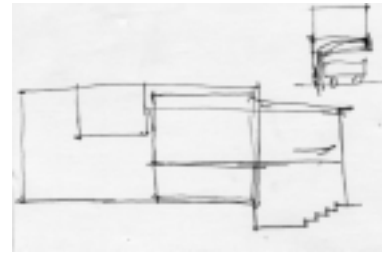

A

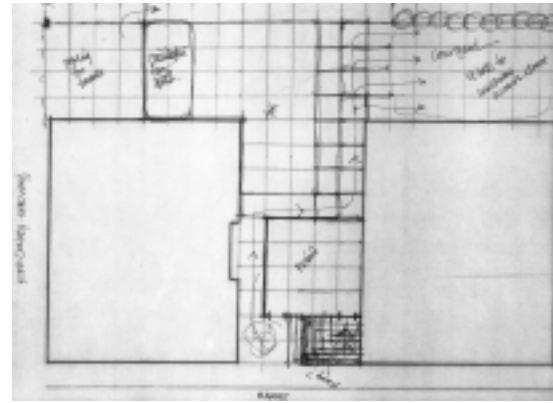

C

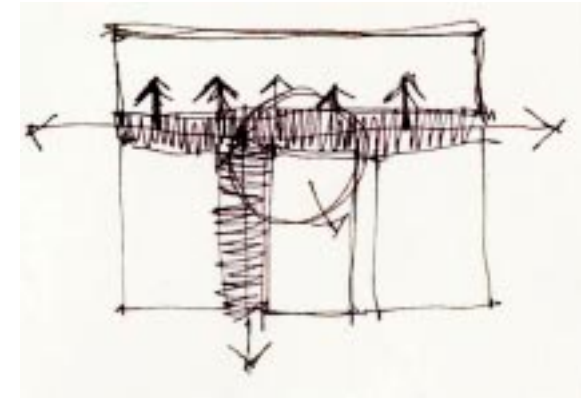

F

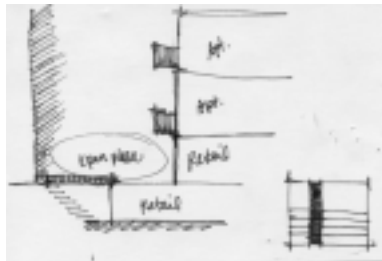

B

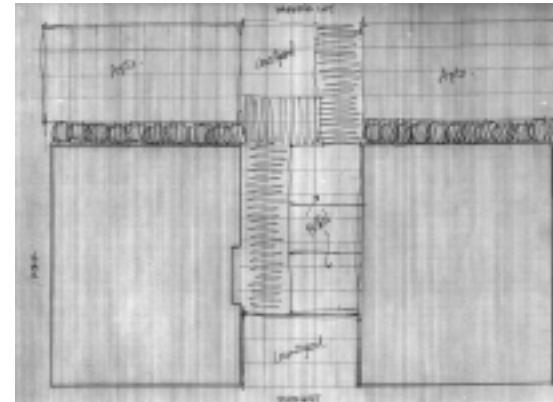

D

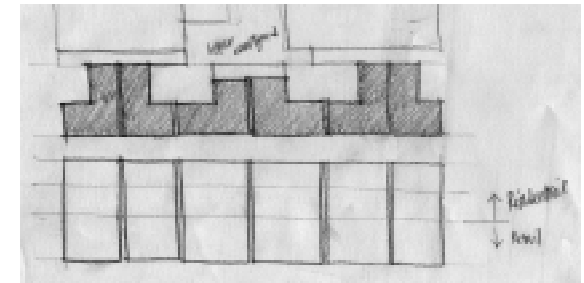

G

I started with diagrammatic plans of the site studying different configurations of residential spaces and retail spaces and their relation to the circulation through the site (C, D, & E). In doing this, I realized that the intersection of the paths would be a crucial area to solve (F).

The decision to cut into the site led to some sectional studies looking at spatial relationships (A & B). Creating a dynamic space for interaction between residents and shoppers became a focus.

Randomly choosing an “L” shape that provided positive spaces and negative spaces within a unit allowed some study into an organization of the elevation (G & H). Ordering the spaces for retail use and public/private residential use became a focus. Thoughts of how to access the units also became apparent in these sketches.

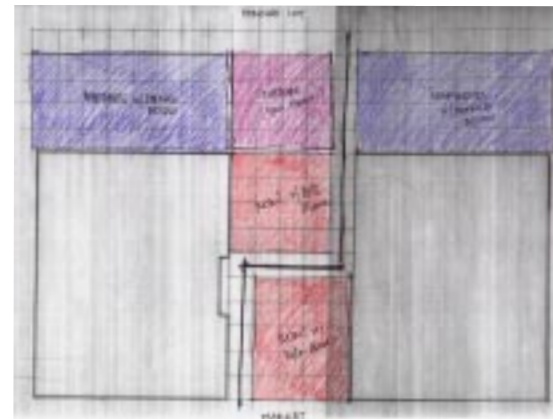

E

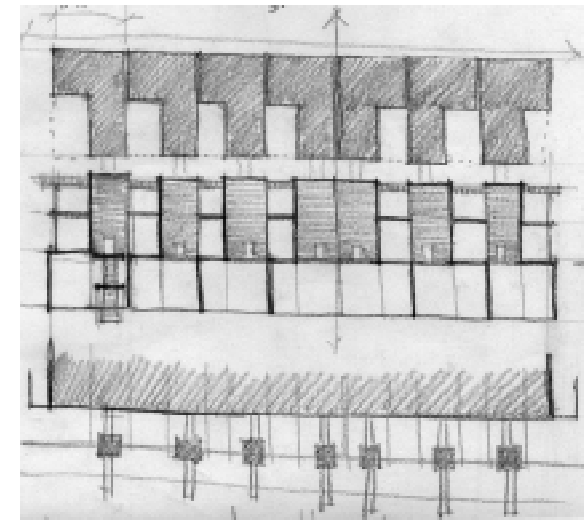

H

Early studies of the circulation through the front portion of the site. These models abstractly illustrate some of the options available to direct pedestrians through the site while still maintaining an openness to the balcony that occurs on the north side.

A narrow path in front of the balcony proves static.

Circulation Study 1



The path becomes wider; yet, remains static.

Circulation Study 2



A wider opening on Market Street draws pedestrians into the space and proves more dynamic.

Circulation Study 3

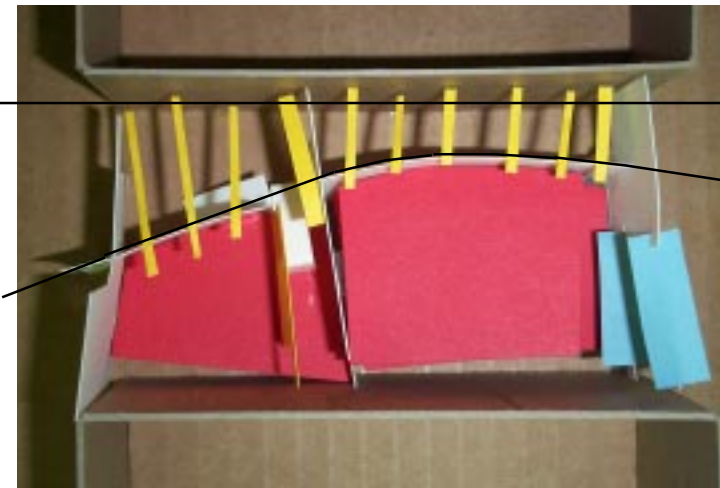

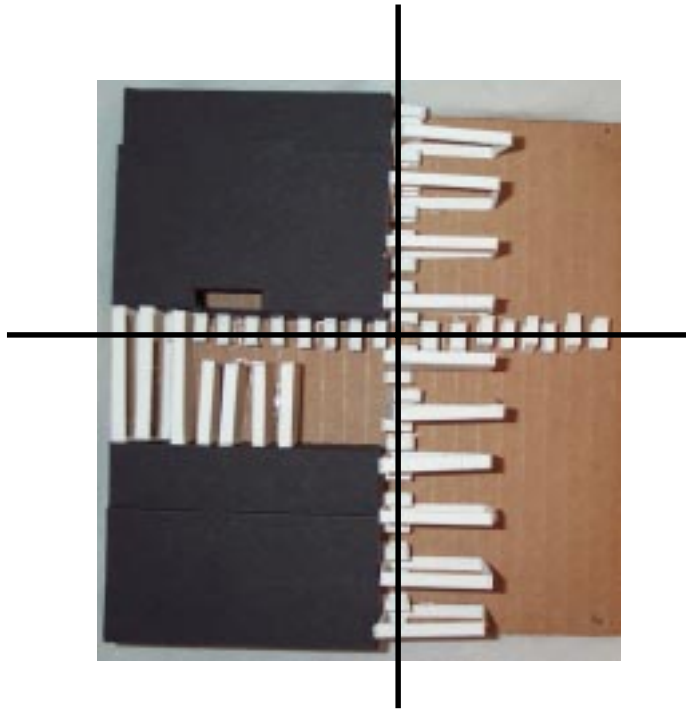

Further studies of circulation through the site influenced the final outcome of project..

The smaller elements represent pedestrian movement based on the observations of paths used in crossing the site. The axes created become the paths in the final project. The vertical path steps down 6 feet to access the retail level. The horizontal path turns into an implied path due to the change in elevation. The intersection of these axes is the elevator shaft that provides vertical circulation.

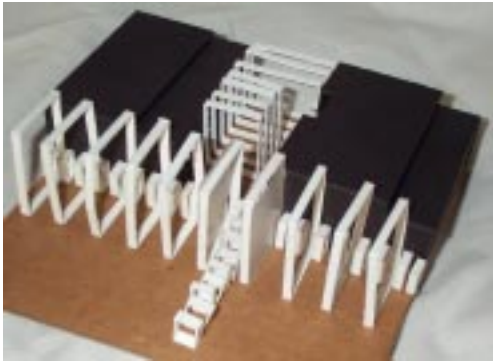

In studying the circulation on the site, a rhythm was established in the rear. The placement of "structure" creates a facade for the area in the rear.



The Market Street elevation was a study in completing the facade of the buildings. This model helped me understand that to create a facade does not mean to create a solid that fills a void. The completion of a wall can just be a wall.

A later study focused on the spatial relationships within the building.

The decision to recess the building 6 feet added a more dynamic quality to the space. It also permitted the two-story residential spaces above the retail spaces to remain within a practical height in relation to the adjacent buildings. A canopy is also introduced into the scheme. This is to provide protection to the shoppers on the first level as well to shelter a private rear space that will be provided for the residents.



The structural elements become brick load bearing walls. The choice to use this type of construction is a direct reference to the brick load bearing construction used in other buildings on Market Street, which is brick load bearing construction. The spaces for retail, residence, public, and private become more refined. The attached spaces to the base whole begin to take form: cat-walk, elevated entry, stair, canopy.



What is threshold? Is it the awareness of leaving one place and entering another? What defines this space? How does this space promote communal living and encourage interaction?

How does a building define the street edge - both physically and visually? How does it address the pedestrian and vehicle from varying distances?

How are layers of public and private addressed as one moves through a space? What is the flow of pedestrian movement? Does it continue existing paths or establish a new one?

These are some of the questions I explored in this project. Some of them remain unresolved; others are answered within the project itself.

I have provided space for residential living and retail. Within these units, I have allowed areas for public use and private use. By combining these two functions within one building, I want to encourage communal living between the variety of users of these spaces. Elements such as the public catwalk and plaza provide the stage for life to occur. These spaces encourage interaction, both visually and physically. They become places for afternoon lunches or Friday evening jazz concerts. The gradual stepping down of the plaza sets a leisurely pace for a relaxed atmosphere. The elevated public catwalk is accessed via stairs in the plaza. Being elevated, it offers a new perspective of the market area as well as allows the space 9 feet above it to be inhabited.



The 20 feet high, stainless steel and glass entry wall completes the Market Street facade. It establishes a threshold between the sidewalk and the plaza and serves as a portal to the social spaces within. The transparency of the wall permits pedestrians to see the plaza from the street and the street from the plaza; therefore, maintaining an awareness of where they are going and from where they have come. Tracks mounted to the main structure above and to the ground below allow for easy mobility of the movable doors on Market Street. During the day, they remain in an open locked position. At night, they close and lock to complete the wall.

Brick serves as the primary material in the project. It is an existing material on the site and relates to the other buildings on the street. The brick walls that separate each retail/living unit are load bearing walls that order the spaces in a linear fashion. Within the thickness of these walls occurs the circulation space in the living units. The concurrent construction of the wall and the stair allow the stair to engage the wall, thus allowing the wall to function as a support on one end while steel cables hung from above support the other end.

During the course of the project, other conceptual ideas became elements of importance within the unit. Although they are still in the early stages of development, their presence in the project adds to the individuality of the project. These elements are the trellis entry, the second floor balcony, the skylight, and the interior walls on the second floor.





An elevation of Market Street showing the relationship of the site to the adjacent buildings and to those across from it





Market Street

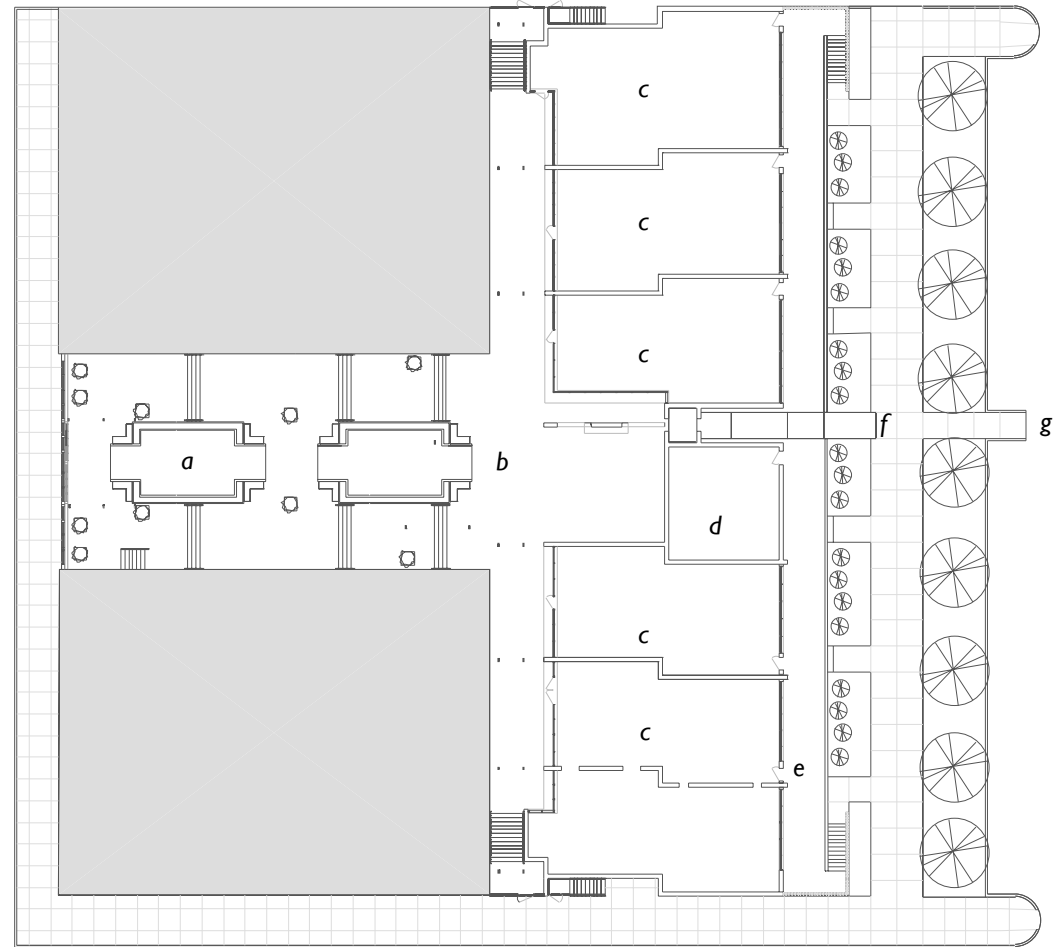

Street / Retail Level (6' below ground)

- a - open-air plaza
- b - retail entry
- c - retail space
- d - mechanical room
- e - service alley for retail
- f - residential entry
- g - parking

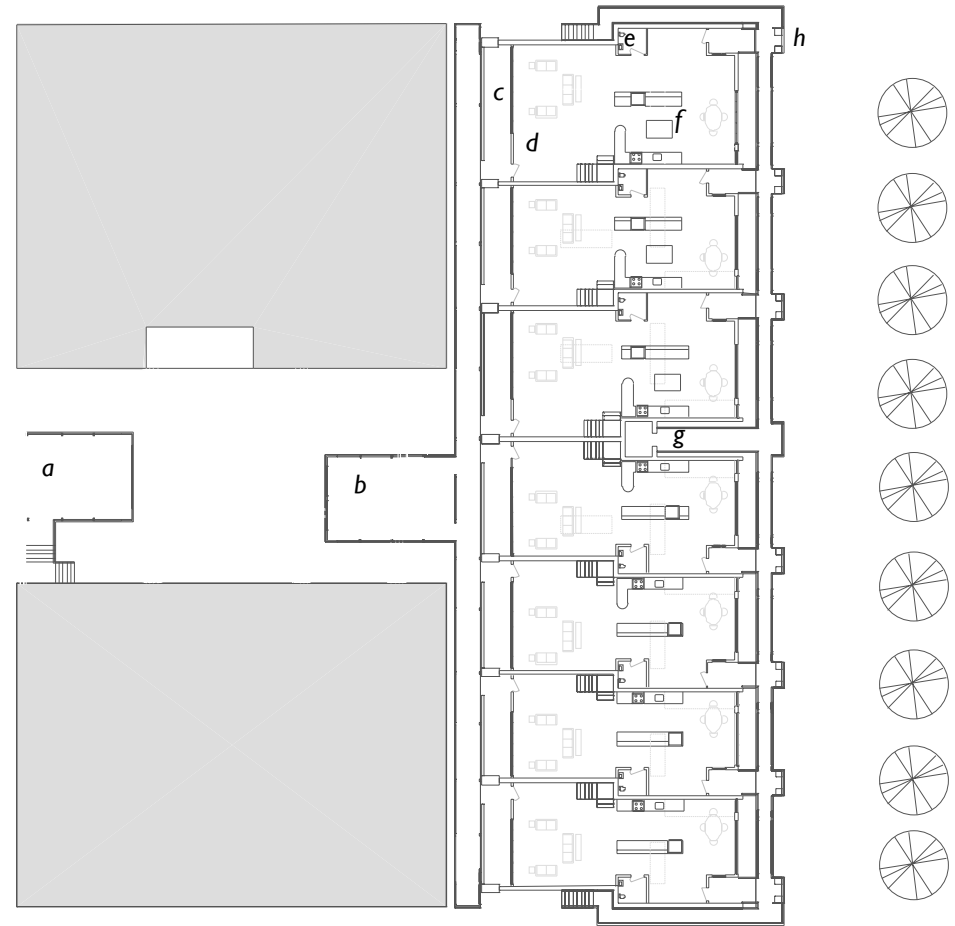

First Level - 9' above ground

- a - public catwalk
- b - private catwalk
- c - semi-private patio area
- d - living area
- e - half-bath
- f - kitchen / dining area
- g - elevator access
- h - trellis entry to unit



The layout of the space takes into consideration the different approaches for both residents and shoppers. The main entrance for the residents is from the east side while the shoppers enter mainly from the west.

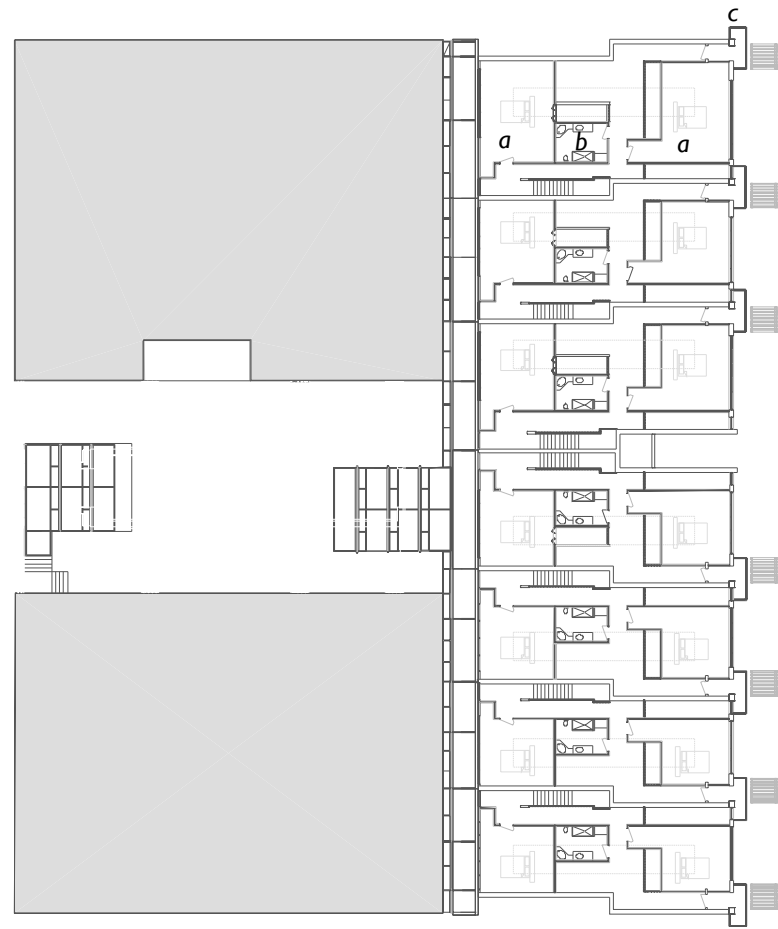

Second Level

- a - bedroom*
- b - bath*
- c - balcony*

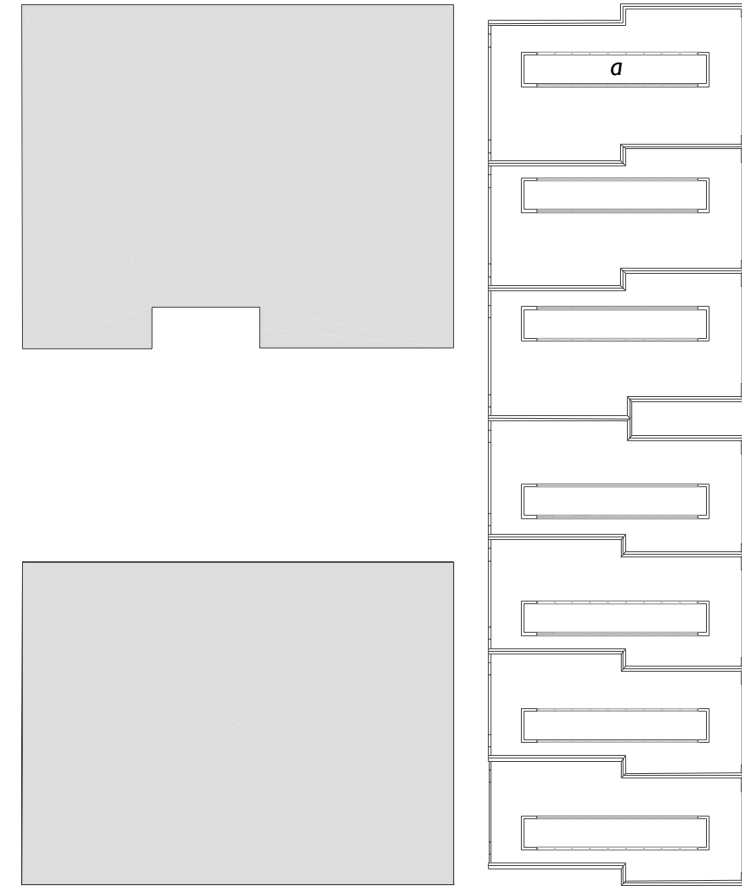

Roof Level

- a - skylight*

Roof Level

Townhouse Second Level

Townhouse Catwalk Level

Street / Retail Level

Retail entry (west)

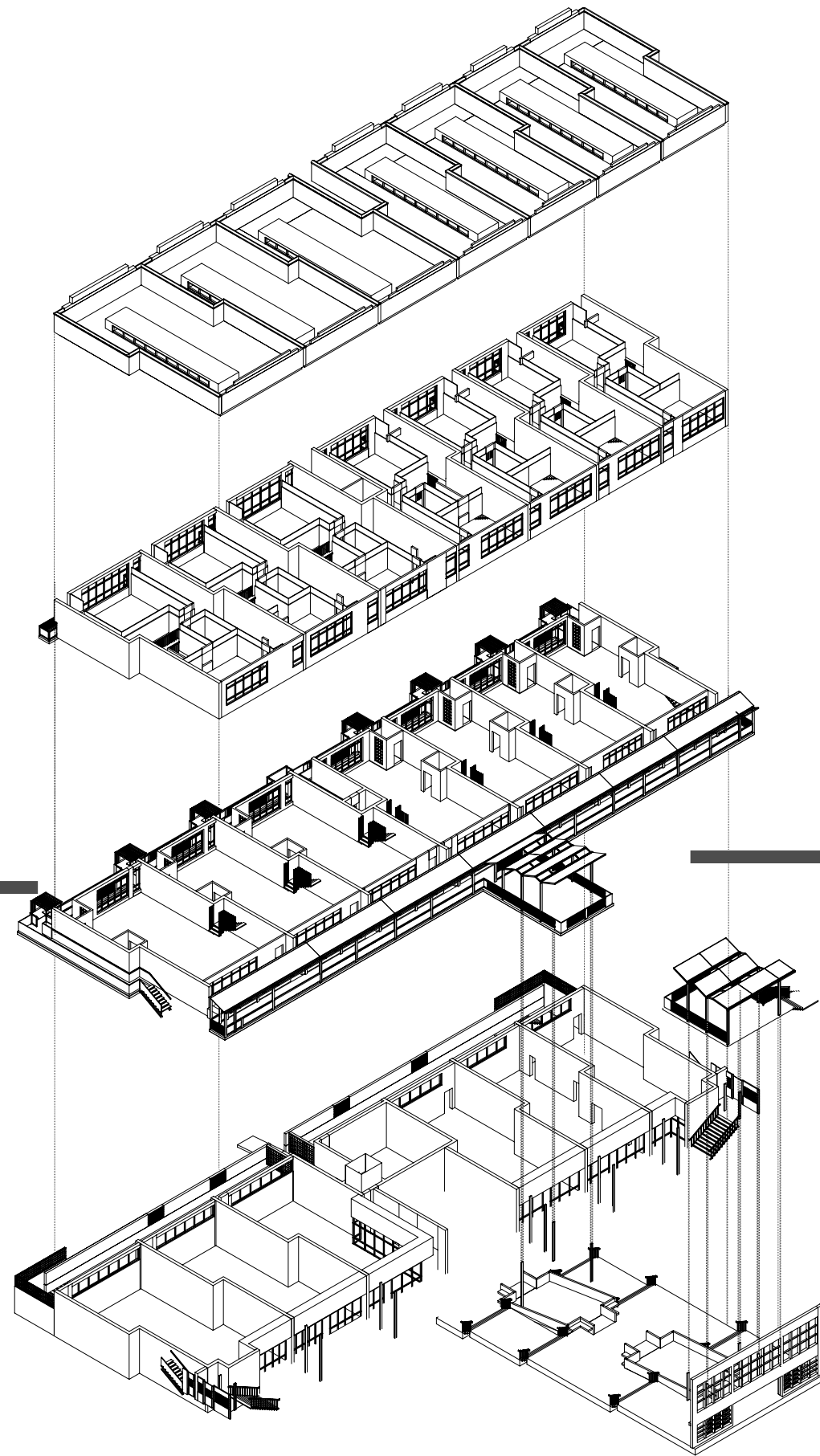

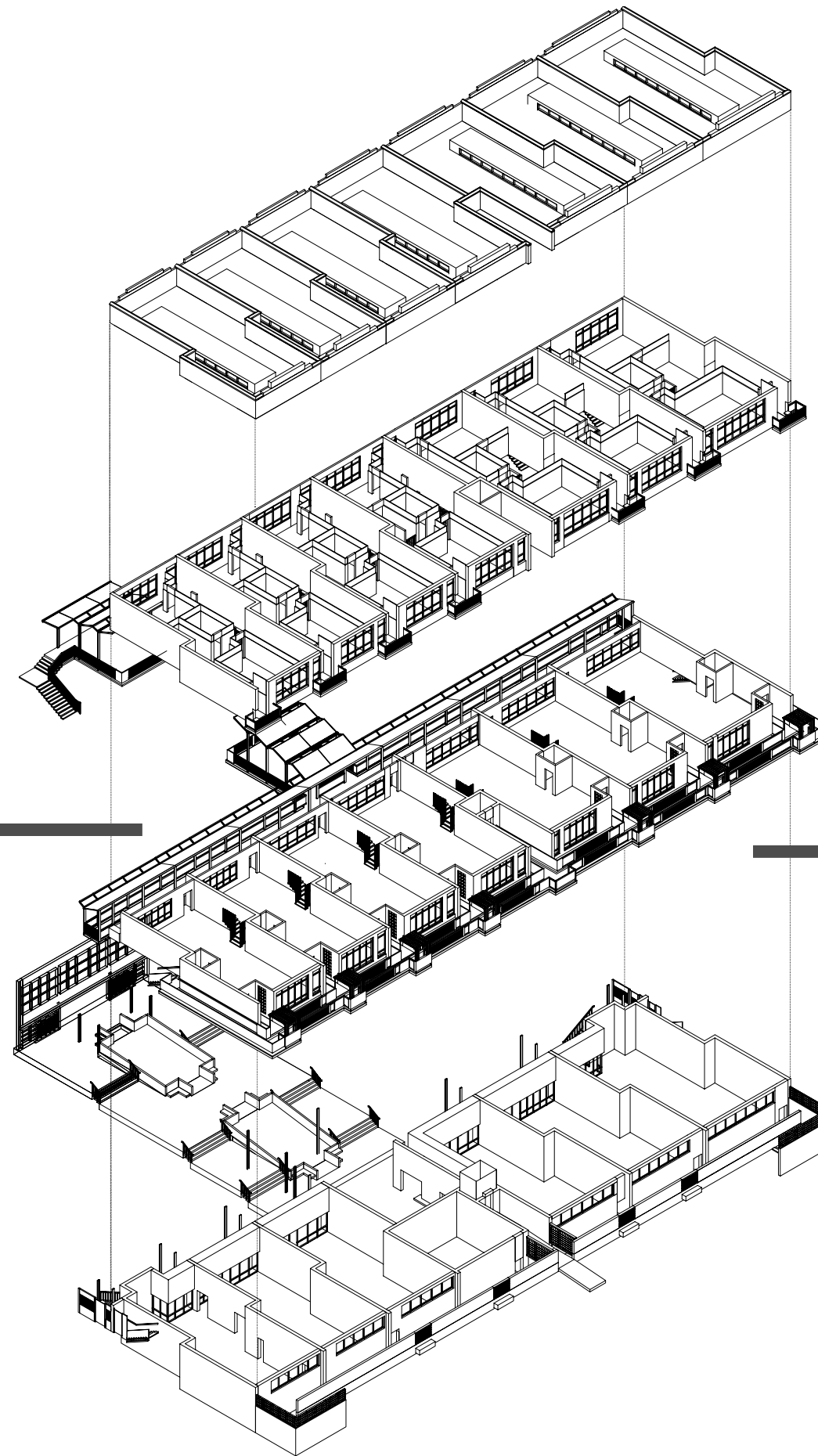

Roof Level

Townhouse Second Level

Townhouse Entry Level

Street / Retail Level

Residential entry (east)

Street / Retail Level (west)

- A - Entry Wall on Market Street
- B - Open-air Plaza
- C - Brick bearing wall
- D - Retail Space
- E - Mechanical Room
- F - Ramp to elevator
- G - Elevator shaft
- H - Stairs to Church Avenue
- K - Stairs to Kirk Avenue

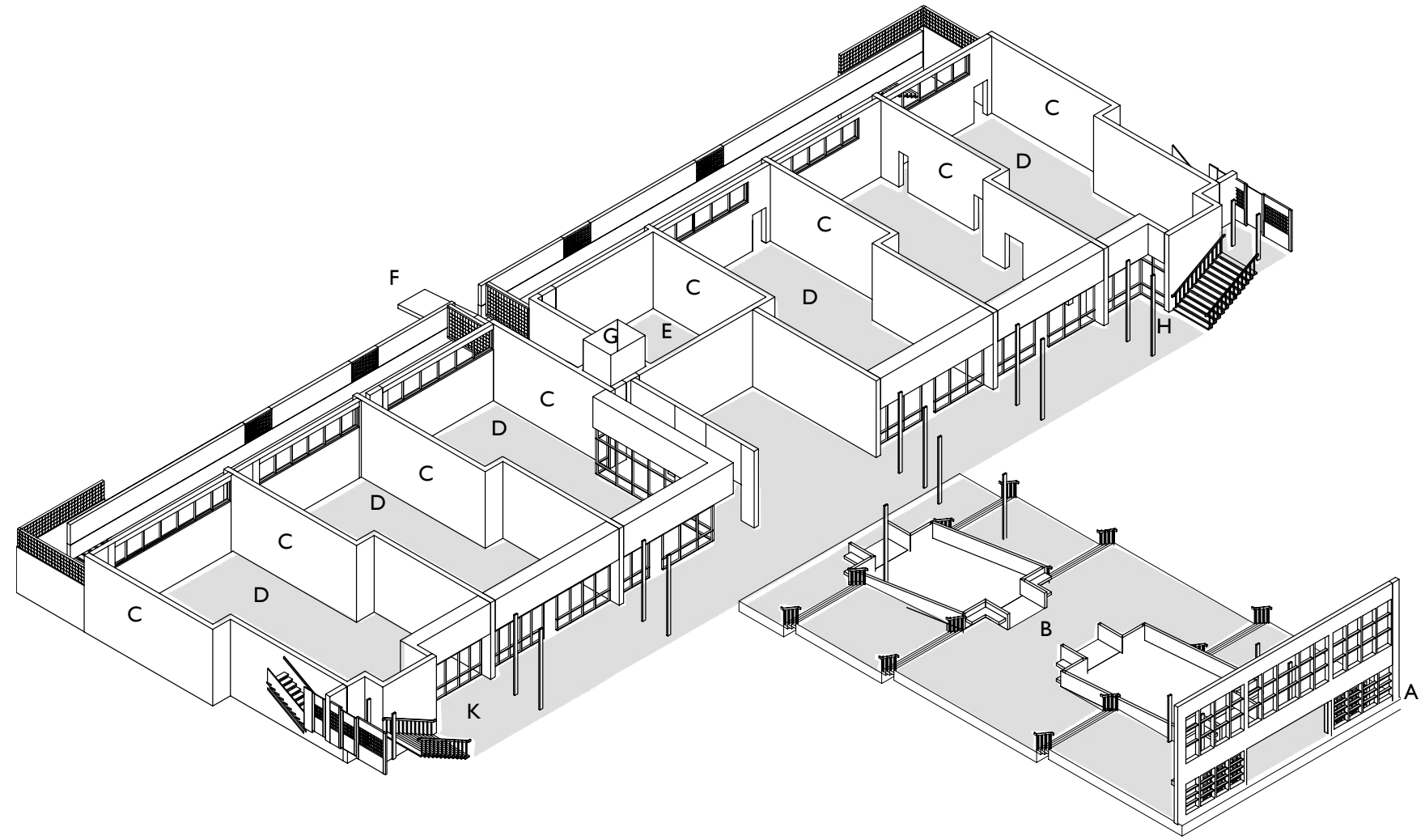

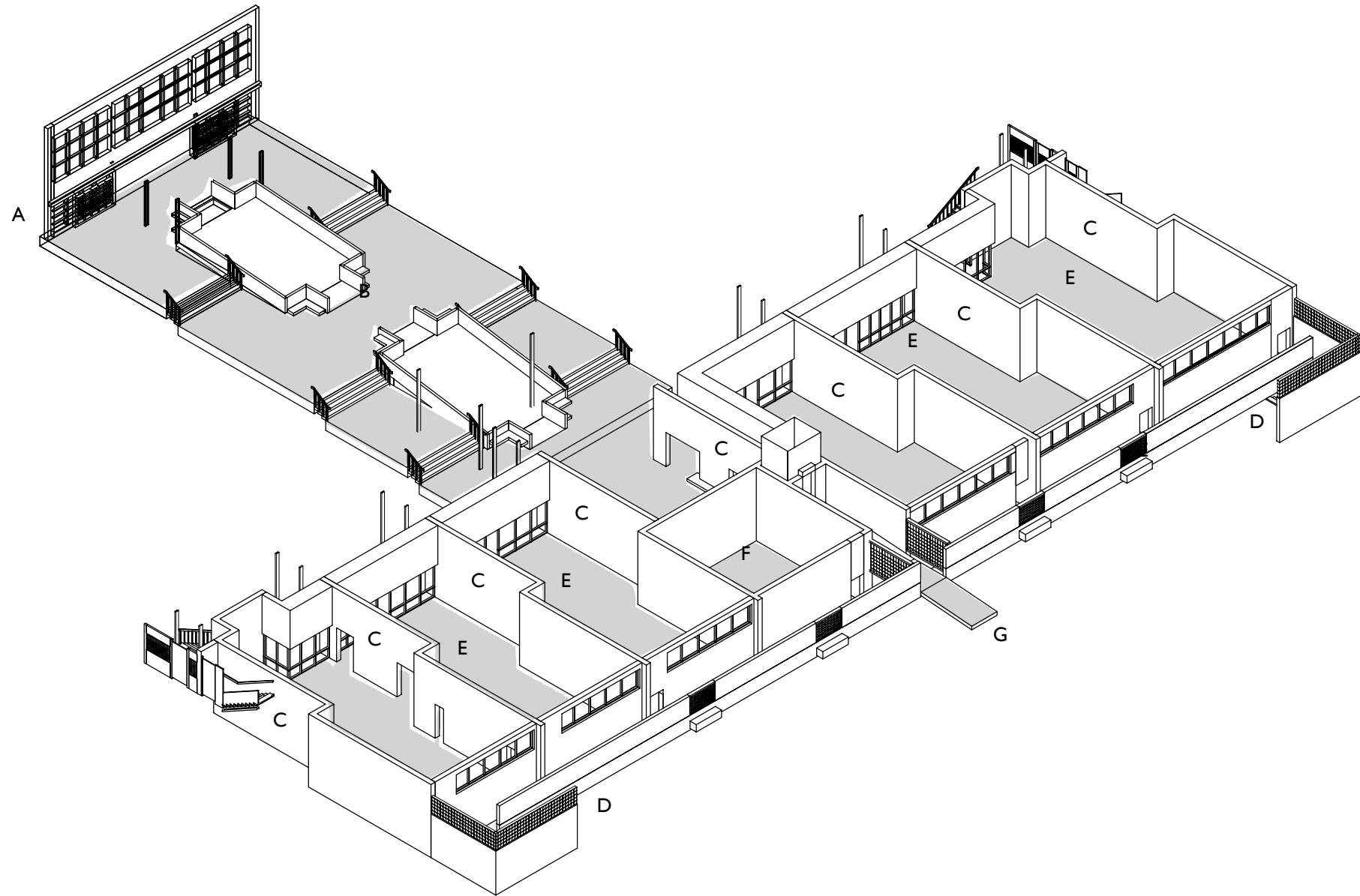

*Street / Retail Level (east)*

- A - Entry Wall on Market Street
- B - Open-air Plaza
- C - Brick bearing wall
- D - Stairs down to Service Alley
- E - Retail Space
- F - Mechanical Room
- G - Ramp to Elevator

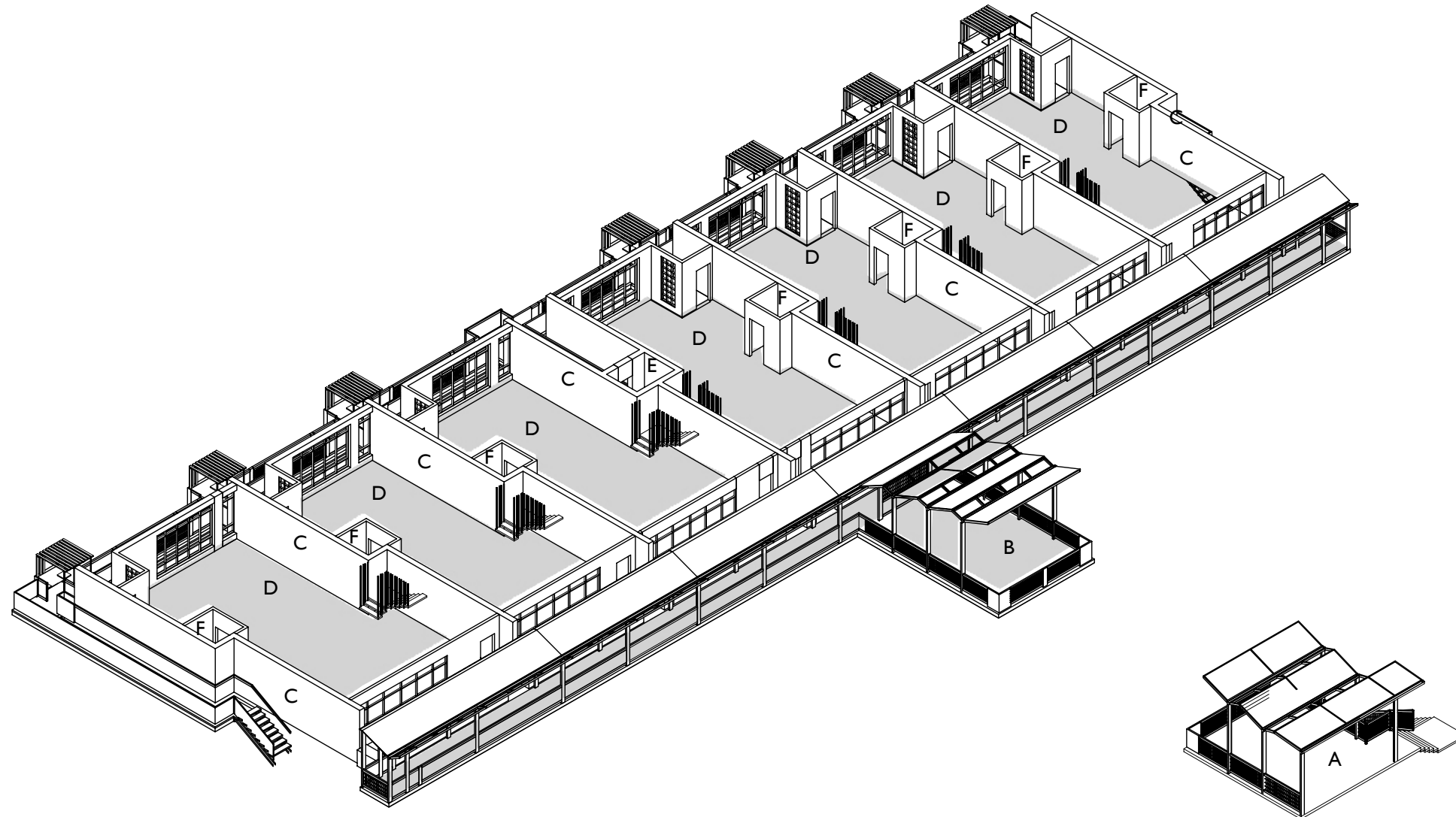

*Townhouse Entry Level (west)*

- A - Public Catwalk
- B - Private Catwalk
- C - Brick bearing wall
- D - Living / Dining / Kitchen
- E - Elevator shaft
- F - Half bath

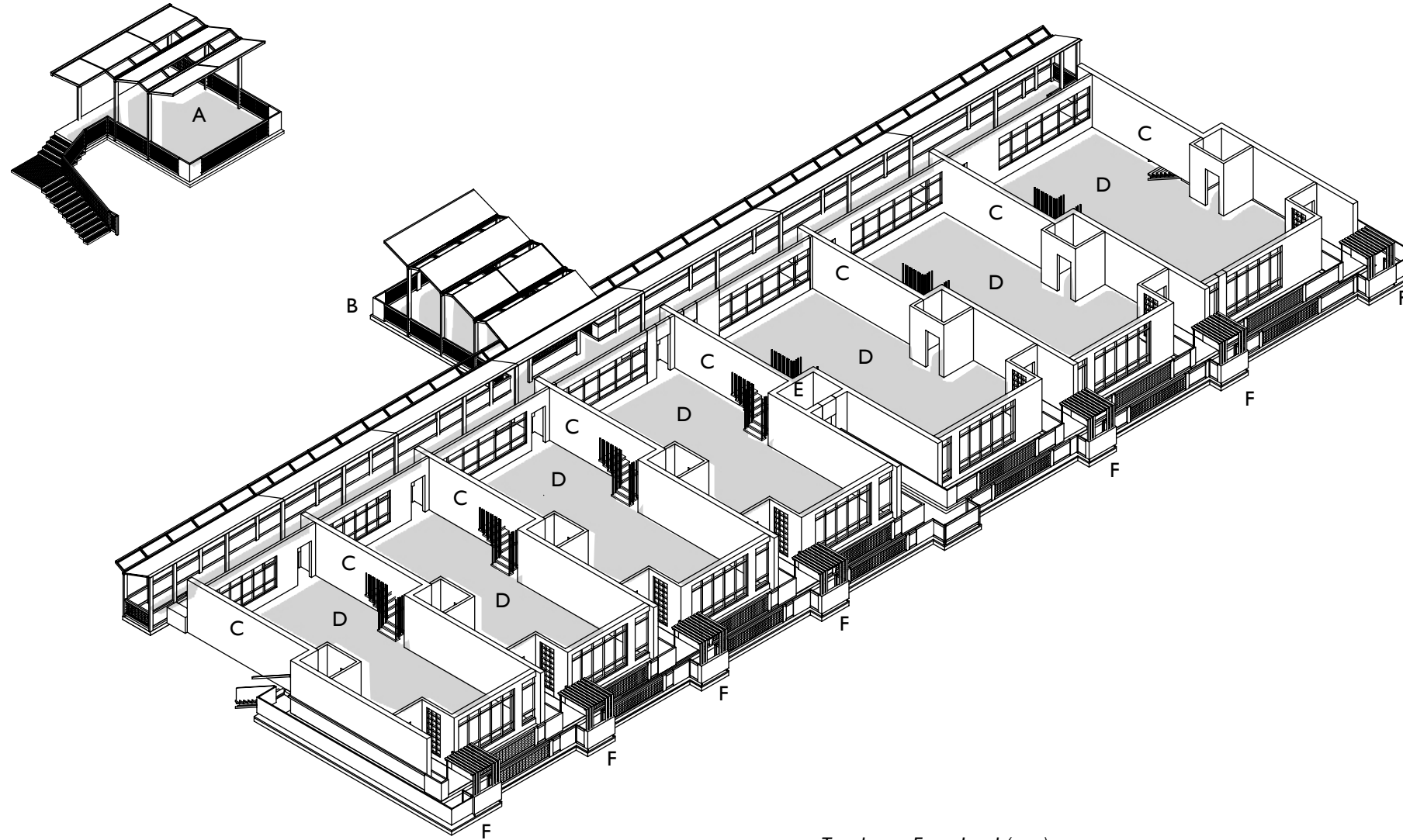

*Townhouse Entry Level (east)*

- A - Public Catwalk
- B - Private Catwalk
- C - Brick bearing wall
- D - Living / Dining / Kitchen
- E - Elevator shaft
- F - Trellis entry to unit



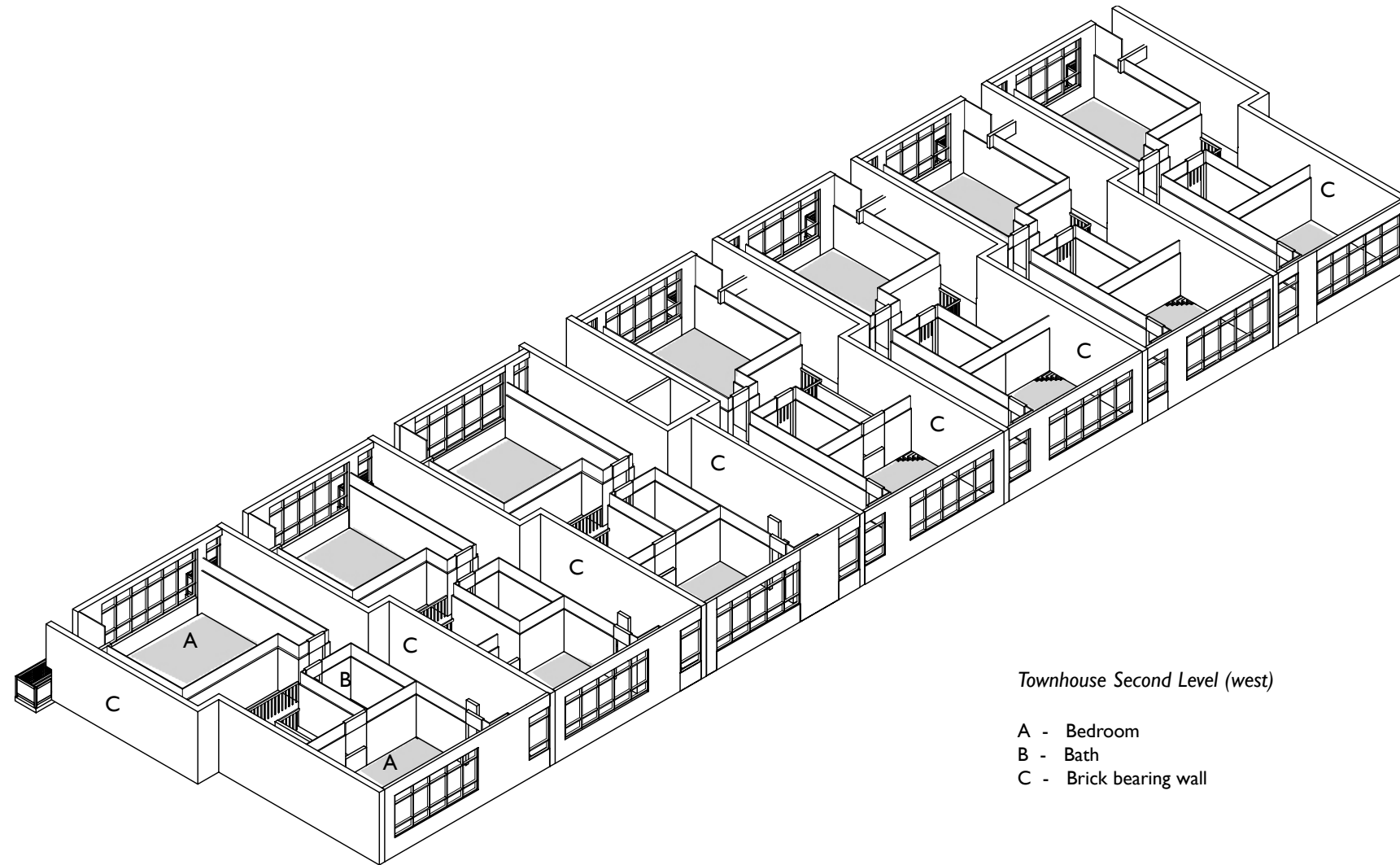

*Townhouse Second Level (west)*

- A - Bedroom
- B - Bath
- C - Brick bearing wall

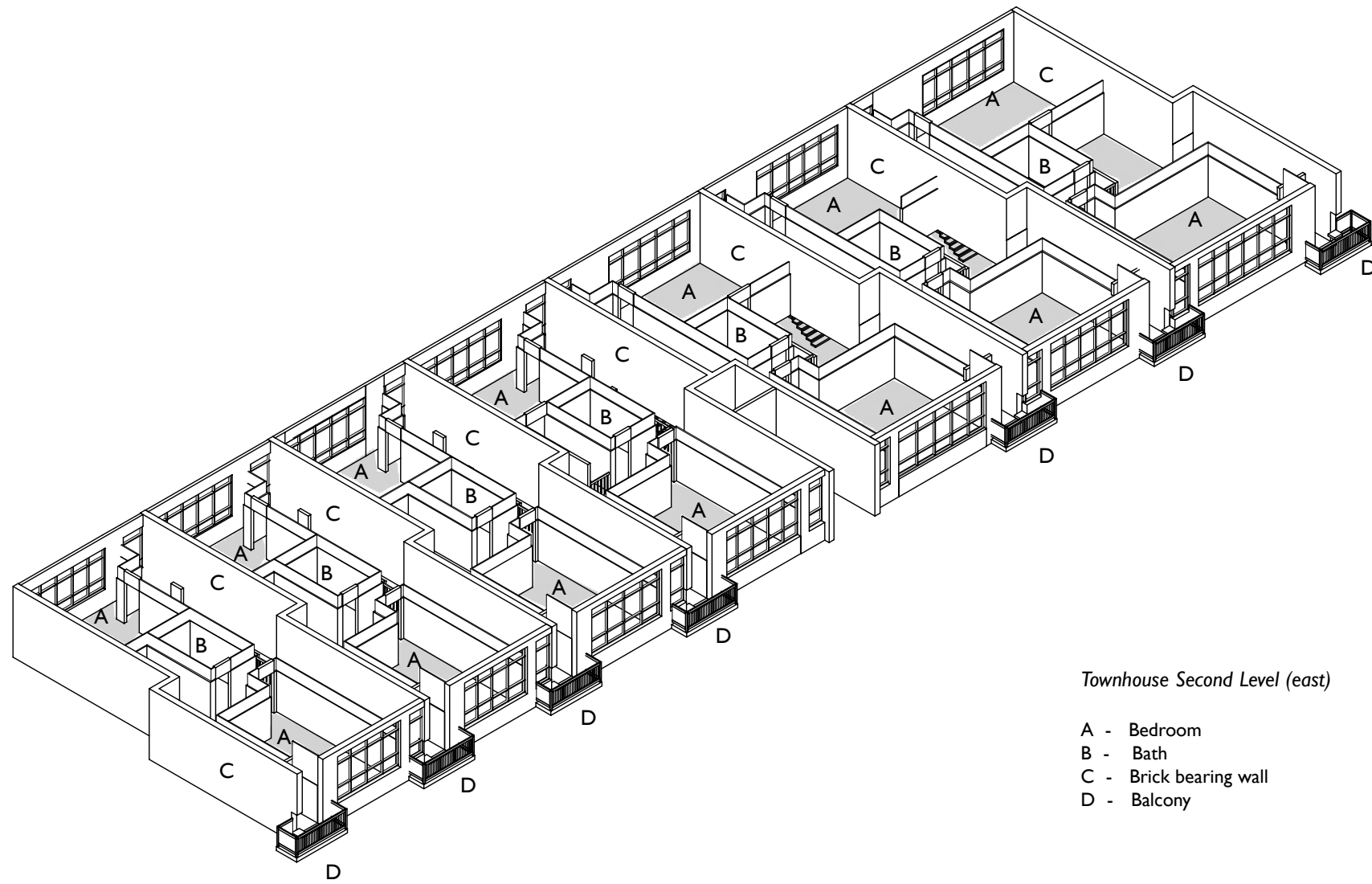

*Townhouse Second Level (east)*

- A - Bedroom
- B - Bath
- C - Brick bearing wall
- D - Balcony

- a - balcony with built-in seat/shelf*
- b - trellis entry to unit*
- c - service alley for retail space*
- d - load bearing brick wall*
- e - second level of unit containing private spaces*
- f - first level of unit containing public spaces*
- g - retail space*

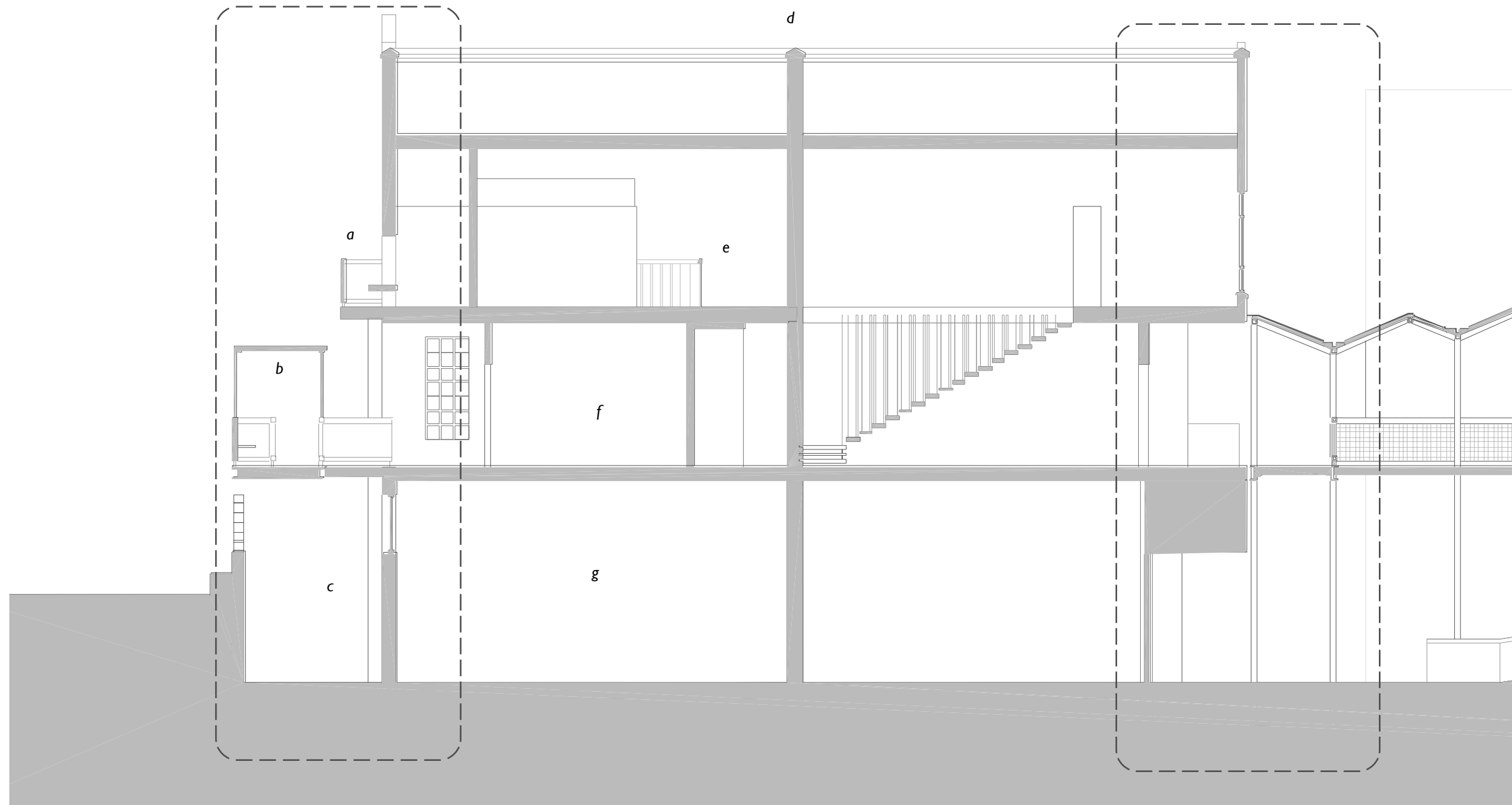

*transverse section through plaza / unit*

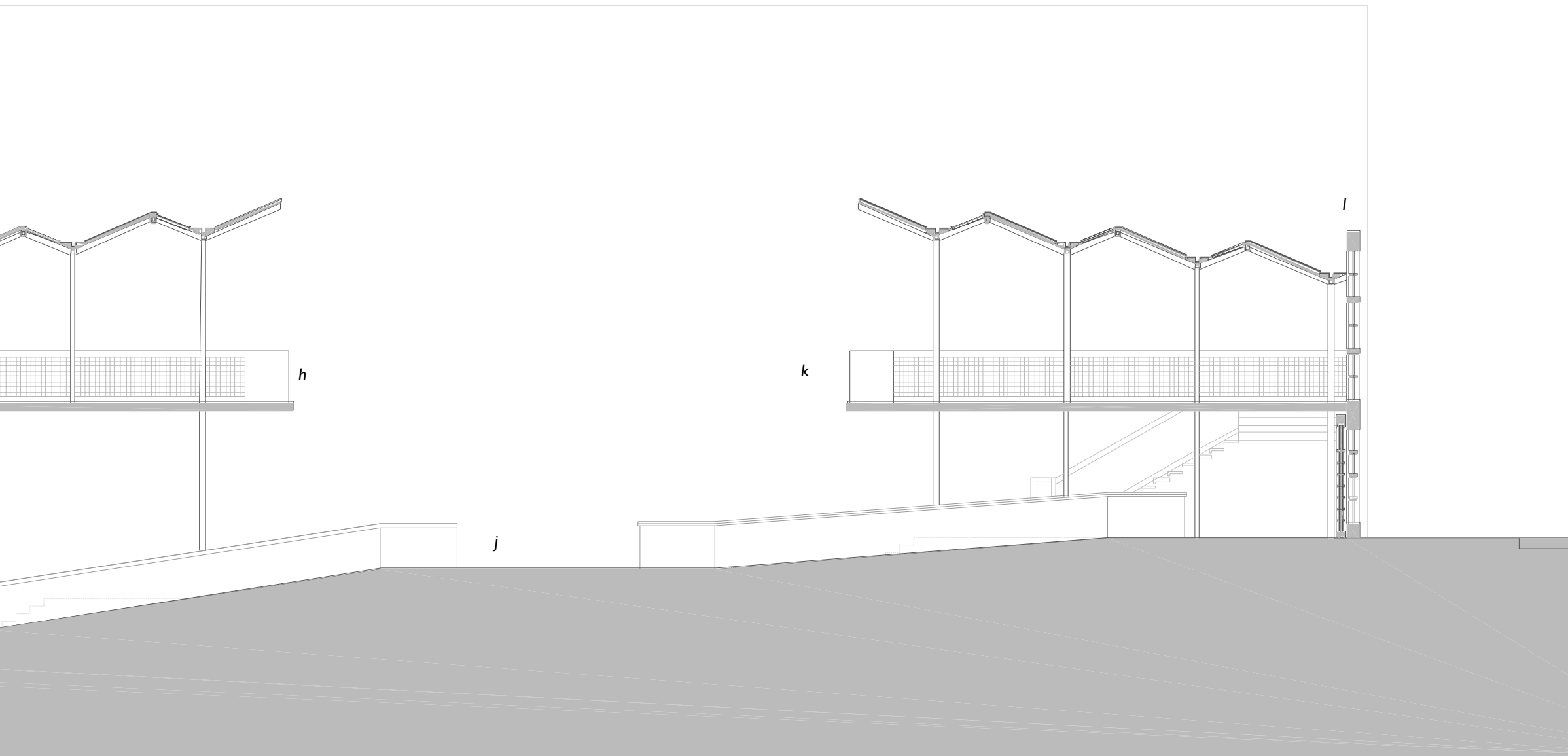

*h - private catwalk  
j - open-air plaza  
k - public catwalk  
l - entry wall from Market Street*

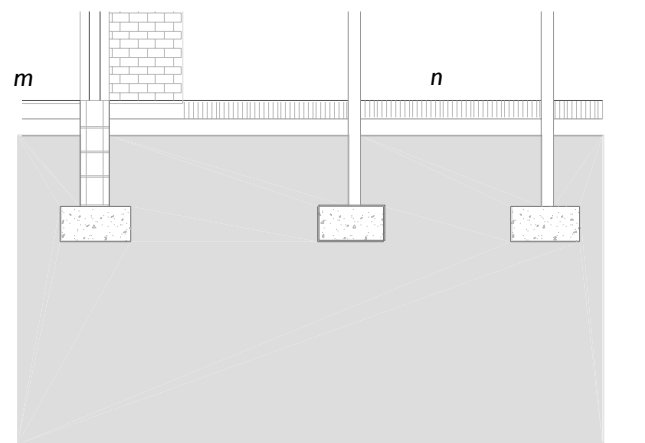
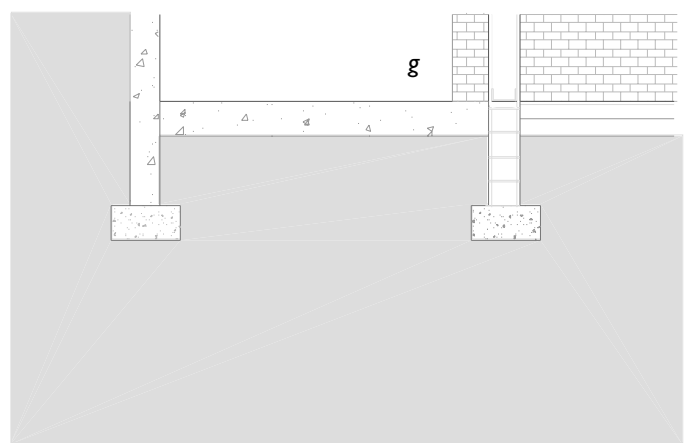
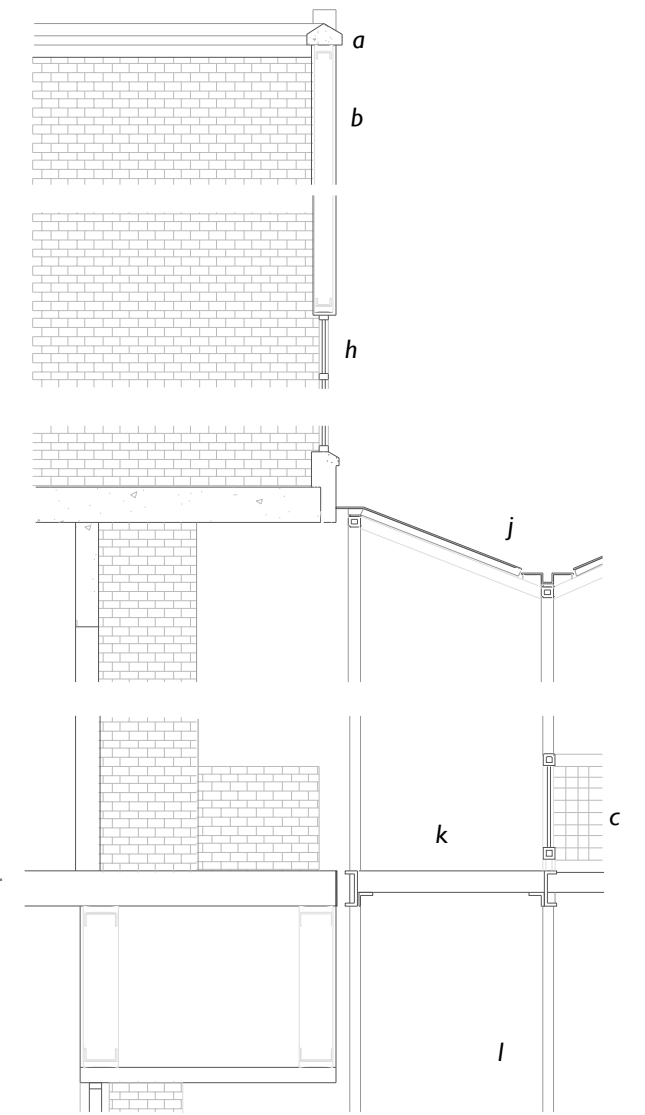
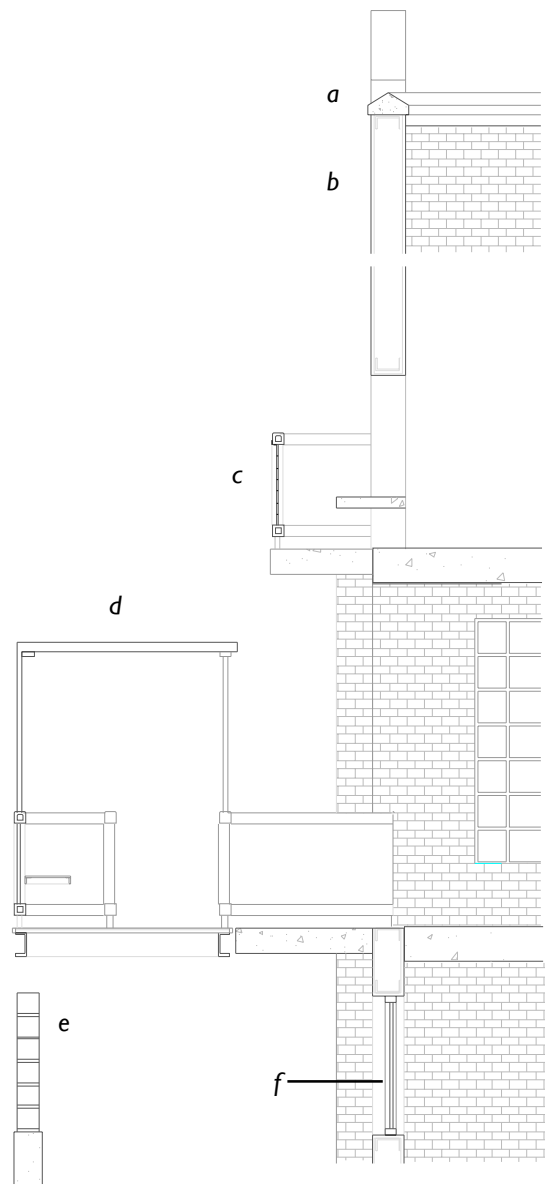

*a - precast concrete cap*  
*b - stucco finish on metal stud framing*  
*c - stainless steel tube railing, sandblasted finish, with 1/4" wire mesh inlay*  
*d - welded steel tubing, smooth finish*  
*e - 8" x 8" transparent glass block*  
*f - 5/8" insulated glass with reflective coating*  
*g - load bearing brick wall*

*h - 5/8" insulated glass with reflective coating, inwardly opening*  
*j - metal canopy over steel structure*  
*k - steel mesh floor*  
*l - steel support tubing / drains canopy to ground*  
*m - polished wood surface on retail interior*  
*n - brick surface on plaza*

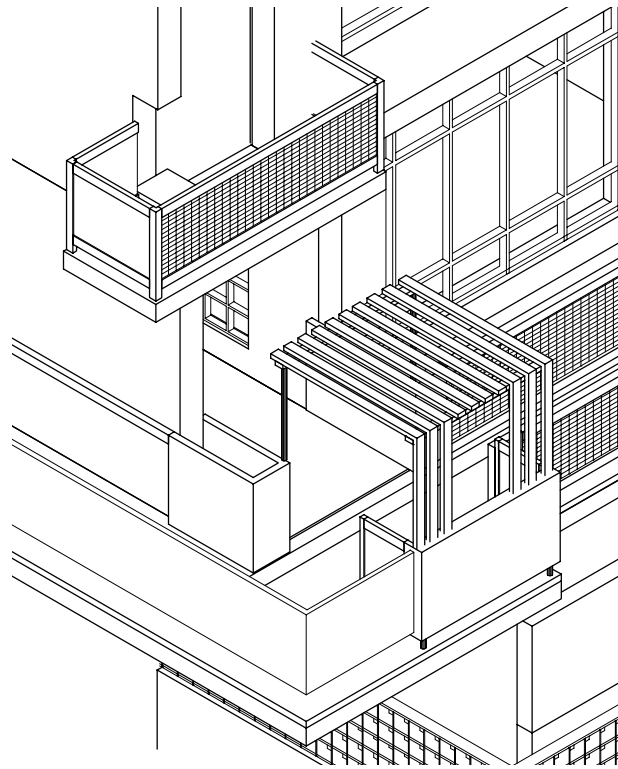

axonometric of trellis entry and second floor balcony

The *trellis entry* encloses a space that becomes an extension of the dwelling. Sandblasted and polished steel tubes wrap over in a gesture of protection. The construction allows for light to seep into the space or permits ivy to creep up and over the steel to create a more private seating area. The area becomes a place the resident can make his own.

The *second floor balcony* projects out over the entryway below. This exterior space is partially recessed; thus, offering some protection from the elements. It is an intimate space that allows for only one or two people. To make the best use of the space provided, a seat is built into the brick wall. The concrete slab offers a place to sit while watching the sunrise or reading a book.

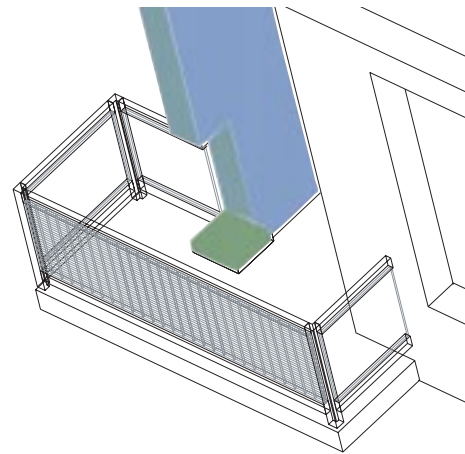

view of seating at balcony

With a limited amount of sunlight coming through the two exterior walls, allowing light to penetrate the depth of the dwelling becomes very important. The penetration of light occurs in two ways: 1. via the skylight that runs the depth of the dwelling and 2. holding the walls to 6 feet with 1 foot high sandblasted glass atop.

The *skylight* not only provides light to the second floor, but providing openings in the floor allows light to reach the first floor space as well. The sidewalls of the skylight casement drop down 3 feet to provide a place for light to rest and reflect.

The *interior walls of the second floor* do not come into contact with the ceiling. The stud wall is 6 feet with an additional one foot of translucent, sandblasted glass that sits in a slot in the wall. The lowered walls permits the light to disperse throughout the dwelling, but the extra foot of glass gives an additional sense of privacy to the rooms.

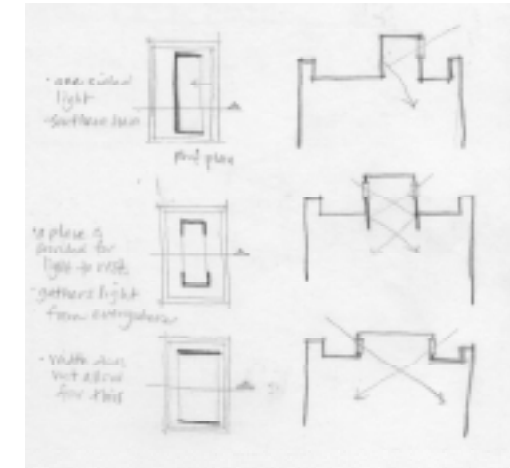

conceptual sketch of light reflection through skylight

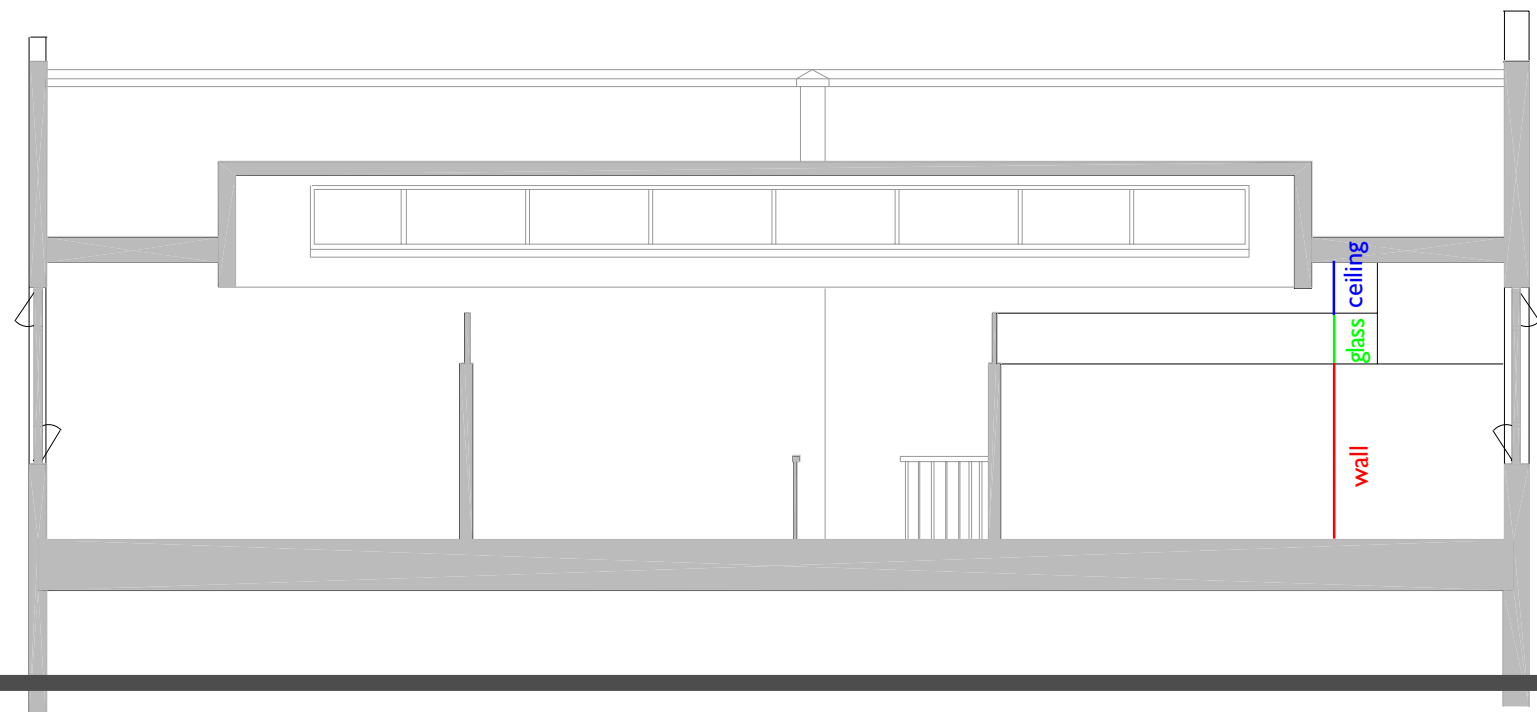

longitudinal section of second floor through skylight showing recessed wall height

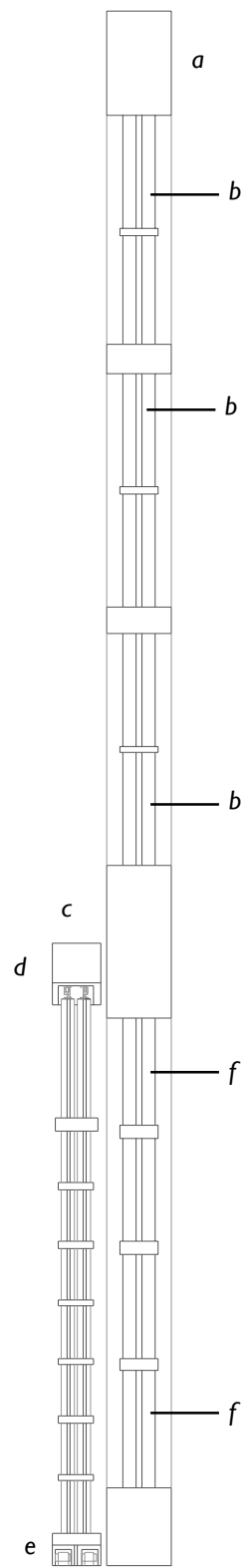

section through wall on Market Street

- a - stainless steel frame
- b - 5/8" insulated glass
- c - lockable moving wall
- d - overhead track attached to steel frame
- e - ground track attached to ground
- f - 1/4" double layer tempered glass

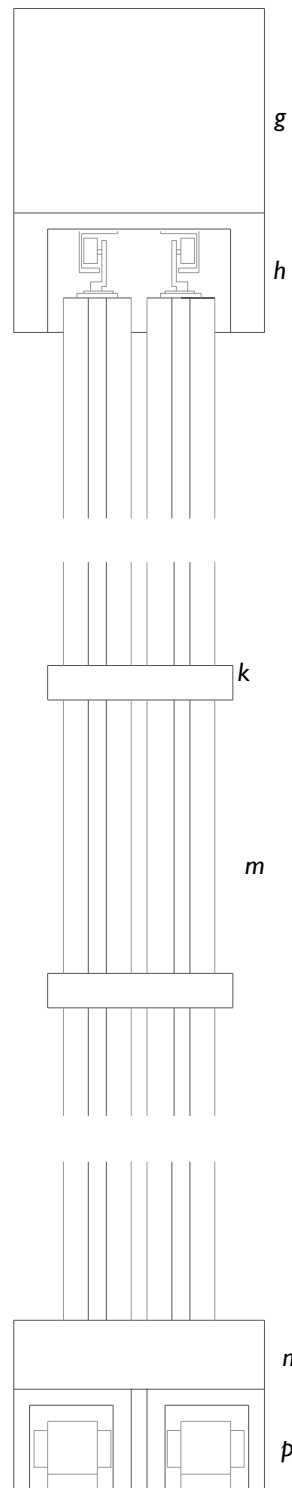

section through movable wall

- g - stainless steel frame
- h - rolling track nested in frame
- k - stainless steel frame
- m - 1/4" double layer tempered glass
- n - stainless steel frame
- p - rolling track nested in frame

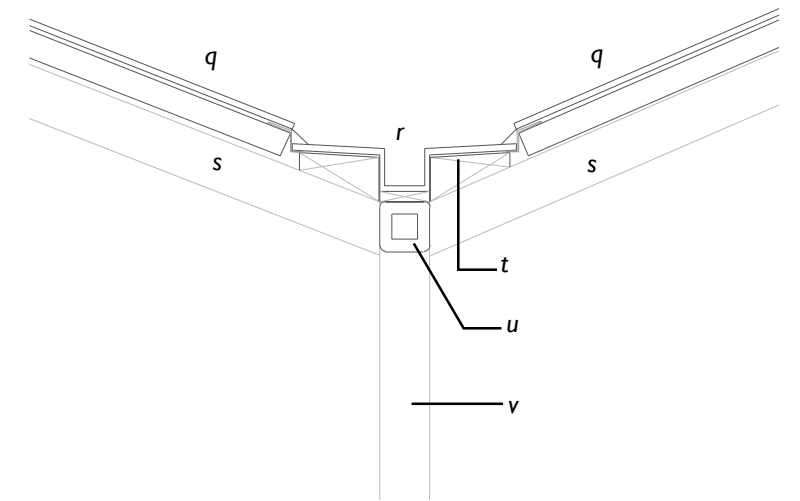

detail at canopy / canopy connection

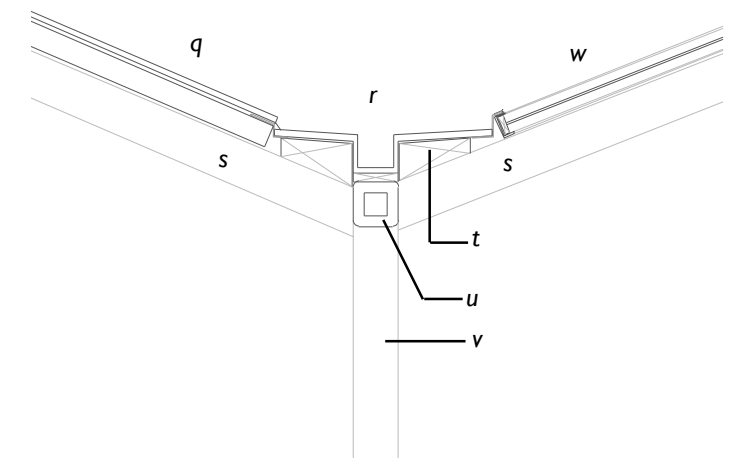

detail at canopy / glazing connection

- q - steel roof canopy
- r - gutter
- s - steel support
- t - pressure treated wood cant
- u - steel tubing support structure
- v - structural column / drainage to ground
- w - glazing in aluminum frame (set on pad to keep separate from steel)



“To me, the presence of certain buildings has something secret about it. They seem simply to be there. We do not pay any special attention to them. And yet it is virtually impossible to imagine the place where they stand without them. These buildings appear to be anchored firmly in the ground. They make the impression of being self-evident part of their surroundings and they seem to be saying: ‘I am as you see me and I belong here.’”  
--Peter Zumthor





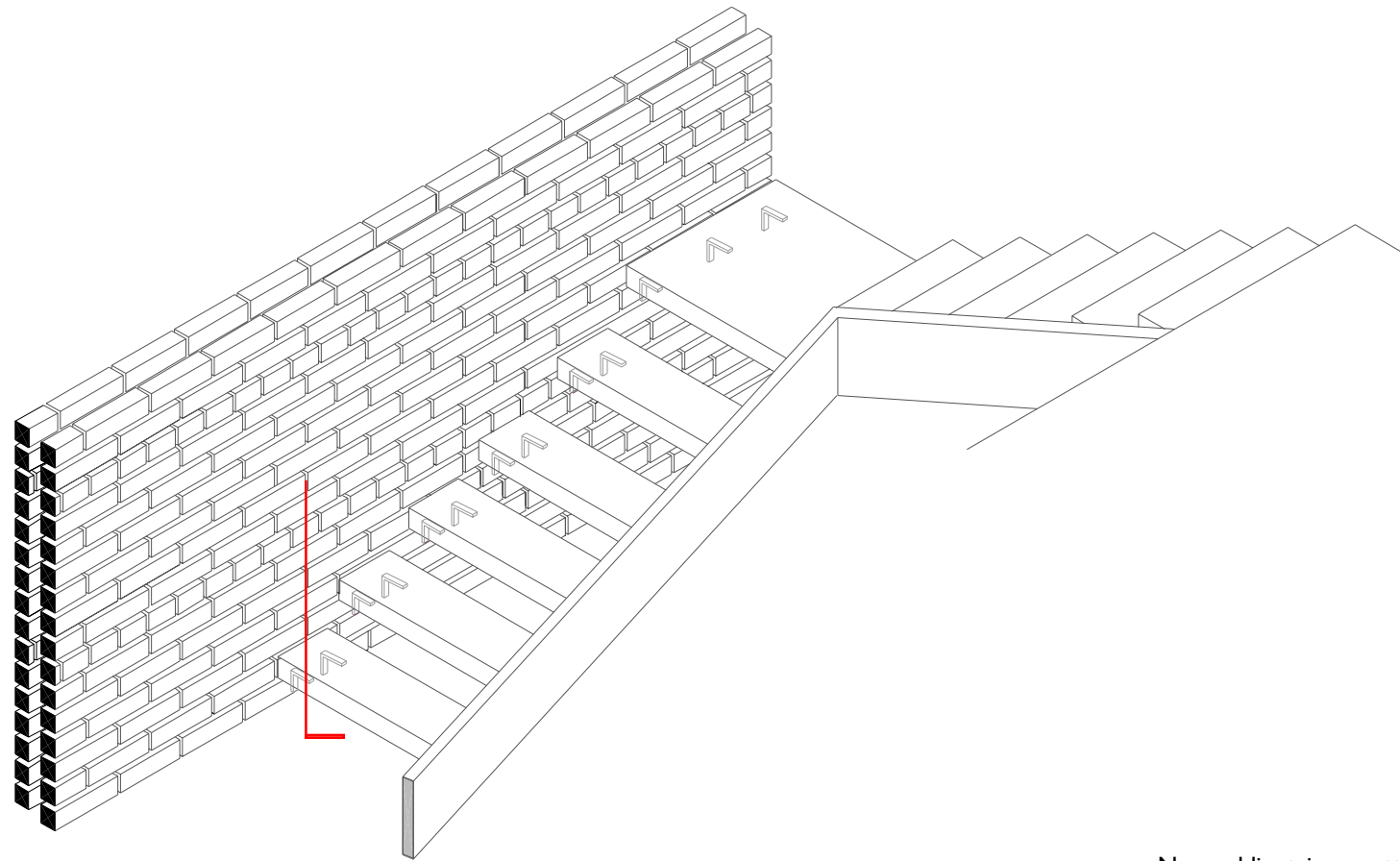

Existing wall / New exterior stair

New public stairs are attached to the existing brick wall with steel angle supports. The separation of the stair treads from the brick wall emphasizes the old and the new.

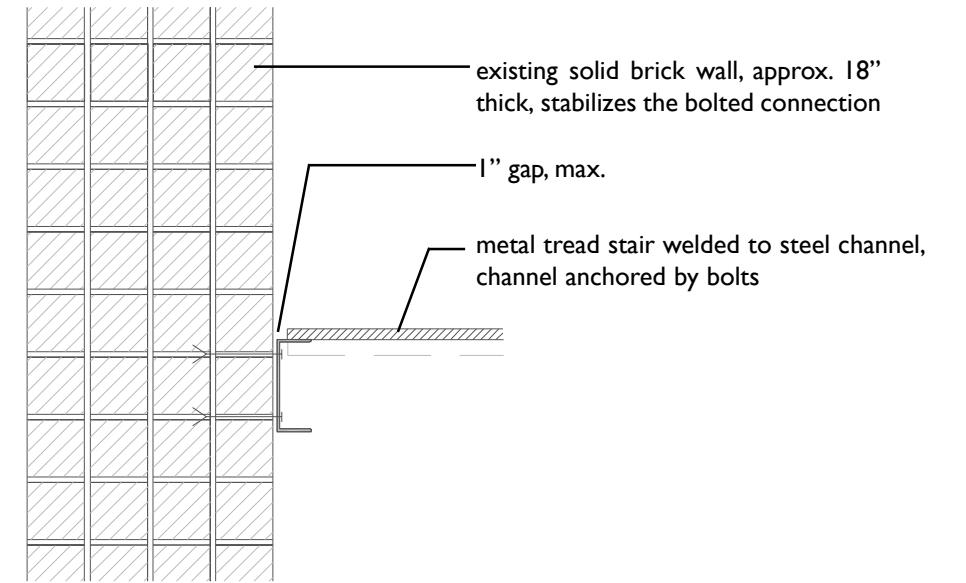

Section of existing wall and new stair.



I set out with the intention to create spaces for users and discovered that you cannot control peoples' actions. As an architect, the desire for control is difficult to resist. Nevertheless, the architect must let go and allow the space to be. If it is a well-designed space, then its use will become apparent to the user. If it is a great space, then its uses will be infinite. The architecture of the space defines the level of usability. To quote Mario Botta, "people truly inhabit a space when they are able to get their bearings in it."

The Market area needs new spaces to support urban life. My proposal provides spaces for people to use and make their own. The proposed structure communicates a renewed life to Market Street and takes the first step toward giving back to an area that has given so much in the past. The entry wall, the plaza, the brick walls, and the public and private catwalks; these four elements encompass this project as a place. The Market Street entry is a separation, a transition, and a threshold. It is a physical separation of the sidewalk and the plaza and provides a strong definition to the street edge. The visual transition it provides within the Market Street facade continues the scale of the pedestrian. It serves as a threshold into another space, thus allowing the pedestrian to be aware of his movement into the plaza. This wall also breaks the hackneyed definition of wall as it relates to a larger structure (e.g., a home, a retail space, etc.). It makes the statement that a wall can stand on its own without the need for other walls, columns, roof, or floor. It is a self-supporting element that needs nothing else.

Architecture is a product of its surroundings. It is a reflection of the history of the place and of the activities that occur in that place. It unites people and gives pride to a community.



All artwork and photographs by author unless otherwise noted.

4 - <http://www.maps.com/atlas/USA.html>

5 - <http://www.roanoke.com/market/vtour/marketsq1915fade.html>

6 - <http://www.roanoke.com/market/vtour/marketsq1936.html>

7 - City map provided by city of Roanoke.

29 - Herman Hertzberger, "Recent Works of Herman Hertzberger," *Architecture + Urbanism* Dec. 1983: 12(159).

30 - Herman Hertzberger, *Lessons for Students in Architecture* (Herman Hertzberger: Uitgeverij 010 Publishers. 1991) 52.

31 - Herman Hertzberger, "Recent Works of Herman Hertzberger," *Architecture + Urbanism* Dec. 1983: 12(159).

32 - Herman Hertzberger, "Recent Works of Herman Hertzberger," *Architecture + Urbanism* Dec. 1983: 12(159).

33 - Herman Hertzberger, "Recent Works of Herman Hertzberger," *Architecture + Urbanism* Dec. 1983: 12(159).

34 - Herman Hertzberger, "Recent Works of Herman Hertzberger," *Architecture + Urbanism* Dec. 1983: 12(159).

35 - Peter Buchanan, "Kassel Lesson: Housing, Kassel, West Germany," *Architectural Review* Oct. 1985: 178.

36 - "Hertzberger a Kassel," *Architecture d'aujourd'hui*, Feb. 1983: 225.

37 - Peter Buchanan, "Kassel Lesson: Housing, Kassel, West Germany," *Architectural Review* Oct. 1985: 178.

38 - Peter Buchanan, "Kassel Lesson: Housing, Kassel, West Germany," *Architectural Review* Oct. 1985: 178.

39 - Peter Buchanan, "Kassel Lesson: Housing, Kassel, West Germany," *Architectural Review* Oct. 1985: 178.

40 - "Old into New," *Architectural Review* Mar. 1969: 145.

41 - "Old into New," *Architectural Review* Mar. 1969: 145.

42 - "Old into New," *Architectural Review* Mar. 1969: 145.



Evelyn Luck Weddle  
b. October 15, 1973

*Master of Architecture*  
Virginia Polytechnic Institute and State University  
Blacksburg, Virginia  
August 2000

*Bachelor of Science in Architecture-Design*  
Clemson University  
Clemson, South Carolina  
December 1995