

URBAN HOUSING *in the* PARK

Thesis submitted to the Faculty of the
Virginia Polytechnic Institute and State
University in partial fulfillment of the
requirements for the degree of

Master of Architecture

Alexandria, Virginia

Susan Piedmont-Palladino, *Chair*

Paul Emmons

Mark McInturff

abstract

The vitality of the city is dependent upon the coexistence of old and new--buildings *and* people. A lot can be learned from past and present relationships among different generations and cultures; in the city this exchange is inevitable. The quality and arguably, *quantity*, of life are inextricably tied to both diversity and community. Human interaction, sense of belonging and dependence on others, make urban living desirable.

The built environment of the city, similarly, tolerates the vernacular and its deviations over time. The challenge for designers is the recognition of the impact one building can have. Just as no actions are neutral, no building exists without its particular, or its broader, context. This should not only be a source of inspiration--an opportunity for thoughtful, responsive design--but an imperative.

January 12, 2000

kristin i. o'connell

model view, looking south from Meridian Hill Park

INFLUENCES

physical

The project is situated at the base of Washington, D.C.'s first formal, European-inspired landscape endeavor, Meridian Hill Park, and along the northern edge of the Pierre L'Enfant city grid, first known as Boundary Street.

Along with its western neighbor, the Roosevelt Hotel—a fine example of the early 1900's apartment-hotel buildings that once graced the streets of Washington, it forms the southern facade of the park. Meridian Hill's upper terrace boasts perhaps the highest public vantage point in the city, with the Washington Monument a distinctive, though distant, focal point. Because of its location, this project is obligated not only to its own program, but to consider its role in a broader scheme—the experience of the city.

Other site considerations include an existing church, probably built around the same time as the Roosevelt, and its 1950's multi-purpose room addition. This appendage, cranked to parallel its diagonal street, New Hampshire Avenue, was deemed dispensable, at least replaceable, in this proposal.

There is a considerable change in grade—sixteen feet from north to south, on the site, though minuscule when compared to the drop within the park itself. This topography is unique to this junction of the city, and accounts for the dramatic views that are attainable from Meridian Hill, and from the upper floors of many proximate buildings.

The **park**, completed in 1930, was named for an unsuccessful campaign led by Thomas Jefferson, to establish Washington as the site of the official (zero) meridian—an arbitrary line from which time would be measured around the world. Though the honor was ultimately given to Greenwich, England, Washington still celebrates its meridian. The actual longitude line runs just west of 16th Street, and passes directly through the center of the White House.

Meridian Hill Park's central axis parallels that line, and its two ceremonial promenades converge on this site, making the first marks.



existing view, looking south from Meridian Hill Park

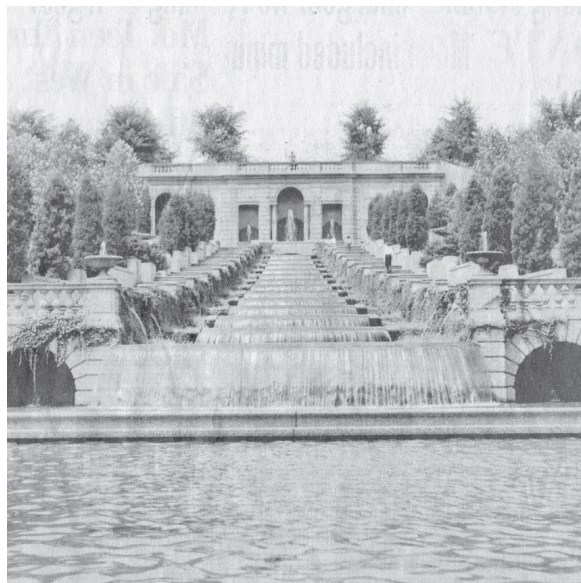

existing view, looking north toward Meridian Hill Park

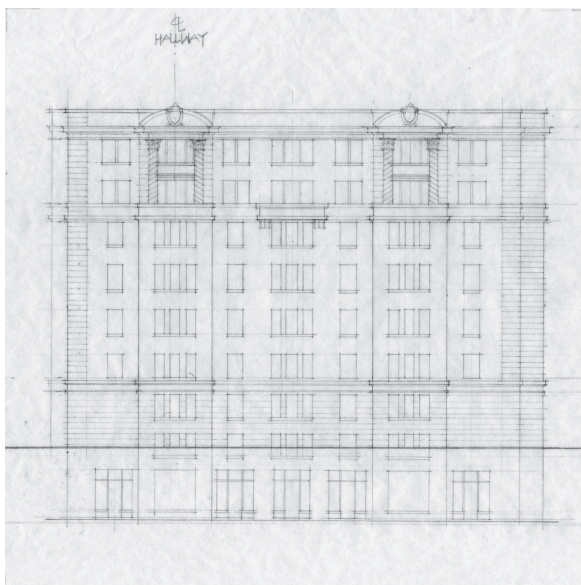

drawing of the Roosevelt Hotel, north elevation

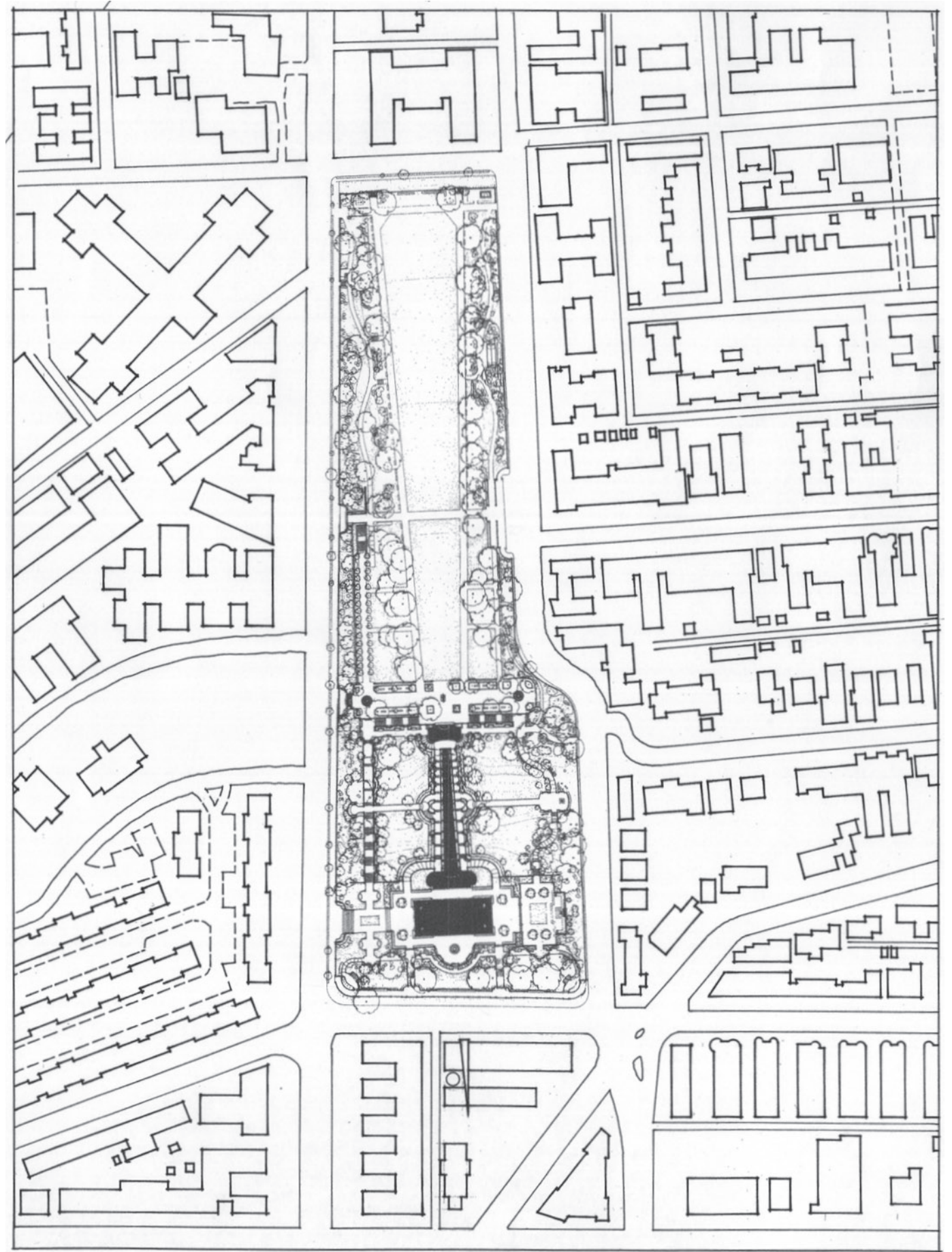

vicinity map

social

What we may have gained with modern technology and the advent of air conditioning, is often unfortunately at the expense of good, thoughtful building. This project attempts to reconsider the problem, in light of yesterday's and today's needs in **urban housing**—with emphasis on the needs of the elderly, the fastest growing segment of our population. Particularly important here, are those *needs* that may not yet have been identified as such, but are probably more meaningful than any other programmable elements.

Thus far, the response to the growing need for elderly housing has primarily been an “all-in-one” approach—a suburban complex, remotely located solely for economic gain. Undesirable for most urban residents and particularly for relatives and visitors, this trend ignores the role the community itself plays in the quality of life. Access to the city's amenities and its necessities should indeed be “easy,” just not necessarily in one building. Access to transportation makes most of the city immediately accessible—a new metro stop recently opened a few blocks from this site. Several hospitals and countless churches are nearby, as they always have been for the residents.

The proliferation of a new type of housing—apartment buildings—at the turn of the century provide the best model for the kind of housing that is now needed, nearly a hundred years later. Washington is filled with examples of successful multi-family housing, built at a time when it was necessary to legislate adequate light and air. The struggle to provide such was offset by the desire to maximize the efficiency, quality, and number of units. This resulted in an intense exploration of *perimeter*, the creation of light wells and courtyards, the provision of grand public spaces that answered a social need, as did the provision of “other uses” on the premises—the earliest and probably most important implementation of “mixed-use” development.

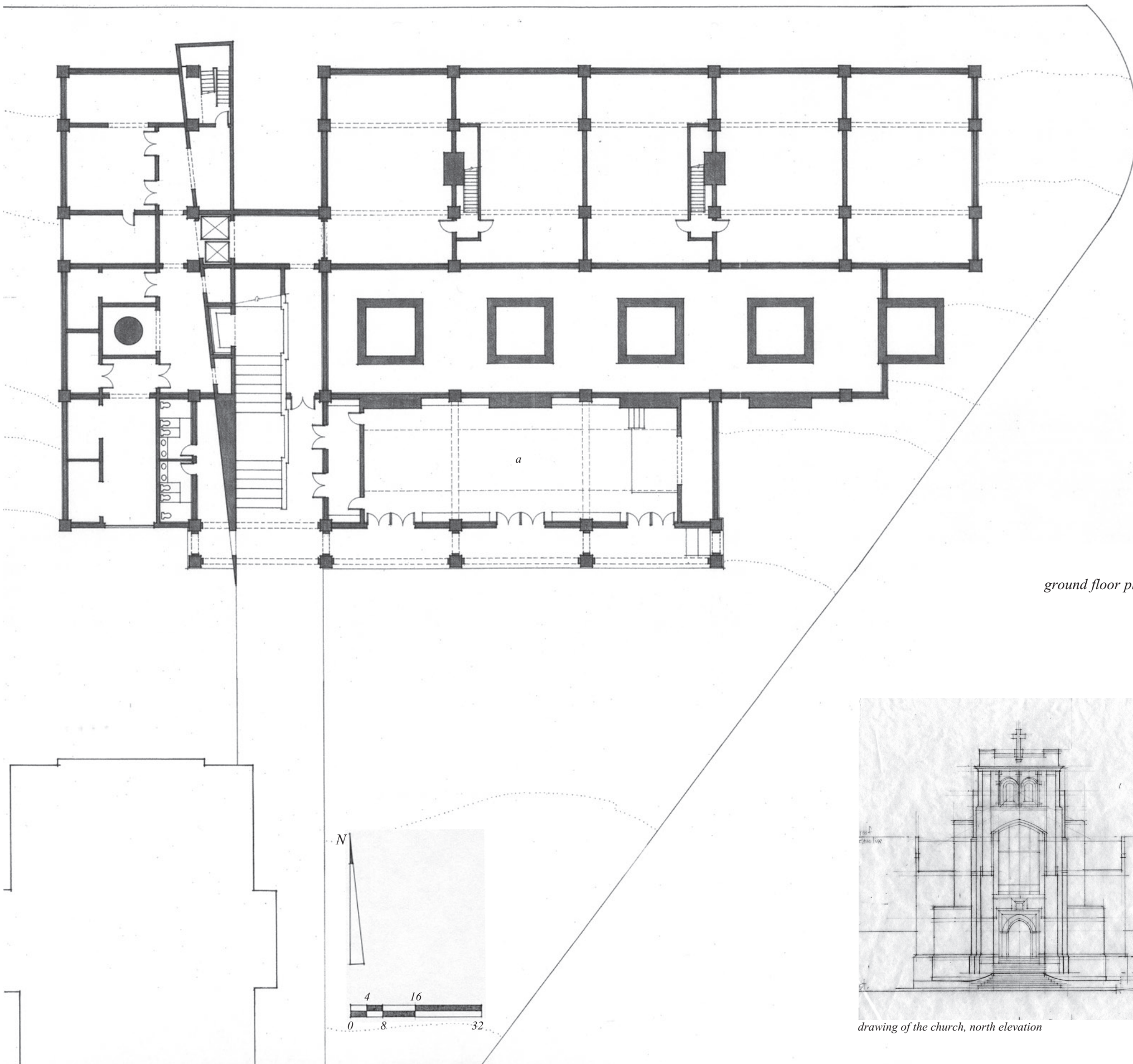

ground floor plan

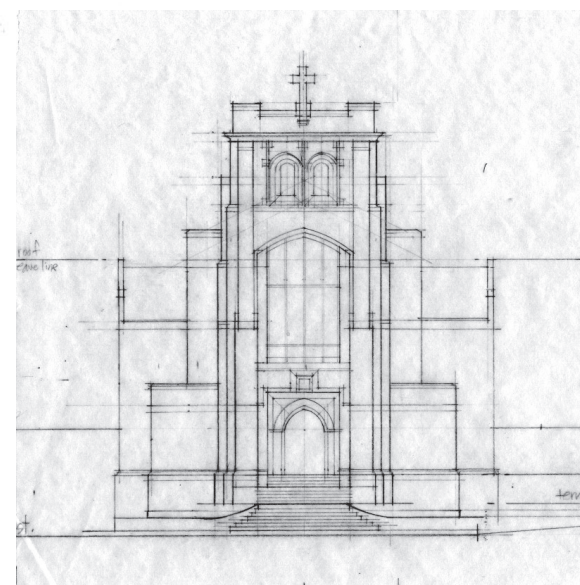

drawing of the church, north elevation

ORGANIZATION

spatial

The intangible markings inherent on the site are made concrete in the building.

They are literally extruded from the ground, and the resultant wedge becomes the anchor for the project.

Retaining the earth, the wedge allows the park's cascading stair to continue right through this site.

This zone that is created by the wedge, extends the promenade in the park that focuses on the Washington Monument, becoming the way to move through the building. An experiential datum on every floor, this path restores the stunning axial view to the Monument from the building's paramount terrace.

The rooms that are carved out of the earth are the most public, simply a continuation of the park sequence.

The spaces that are accessible from the street, by the pedestrian, invite the social interaction that is vital. Retail shops open from the sidewalk as well as from an "interior" arcade; the whole level is actually outside, an extension of the street. An auditorium, a place for community events, is just another terrace along the landscape stair and serves as a replacement of the old church's meeting room, which can also be entered from the churchyard loggia.

The wedge acts as a threshold for entry into the residential lobby and mediates access to the semi-public rooms—the library, fitness center and dining room.

These rooms are served by a grand circular stair that winds around the massive pier, which rises all the way up to the rooftop observatory. This pier, an independent foundation for the telescope, is both the graphic and functional counterpoint to the wedge.

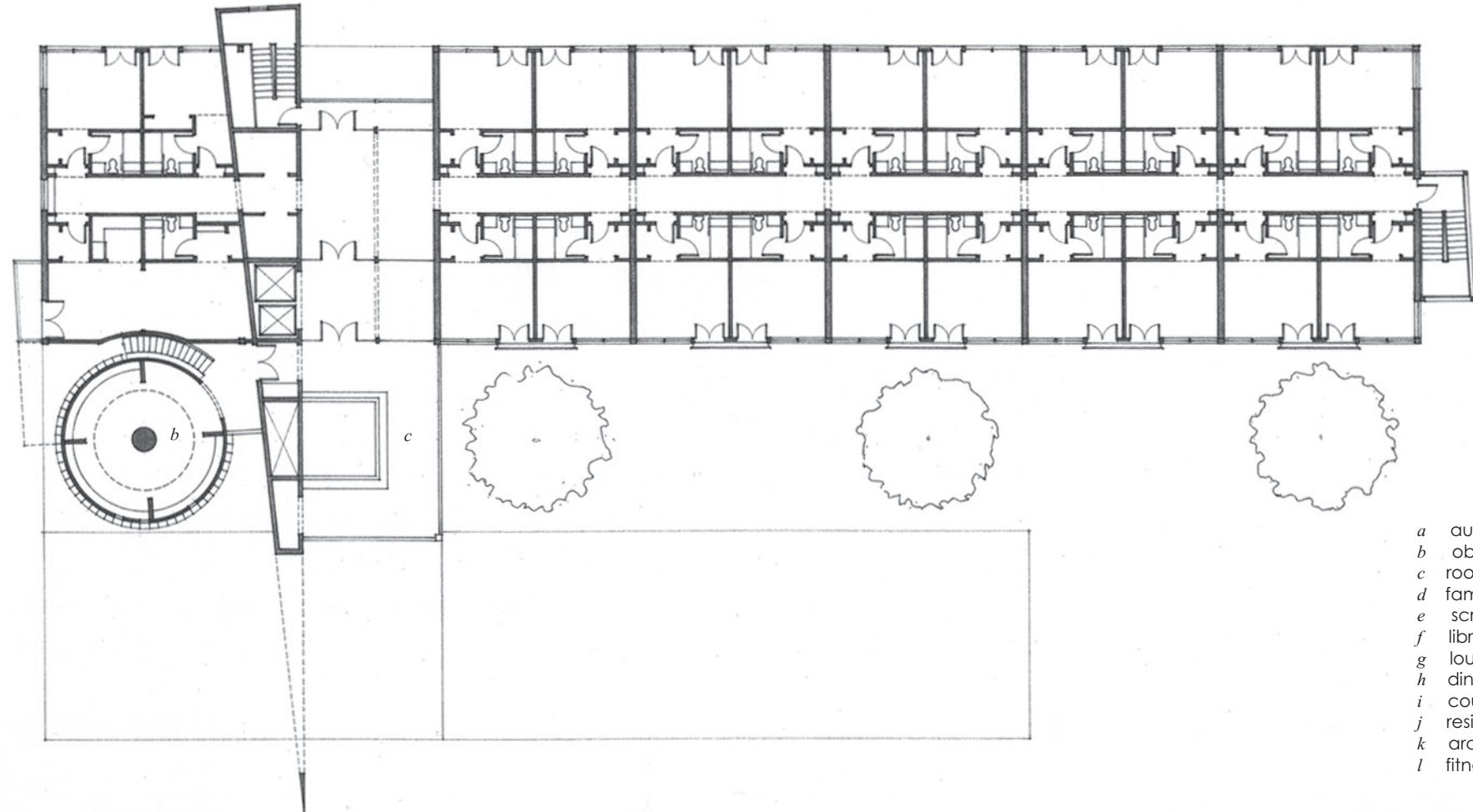

seventh floor plan

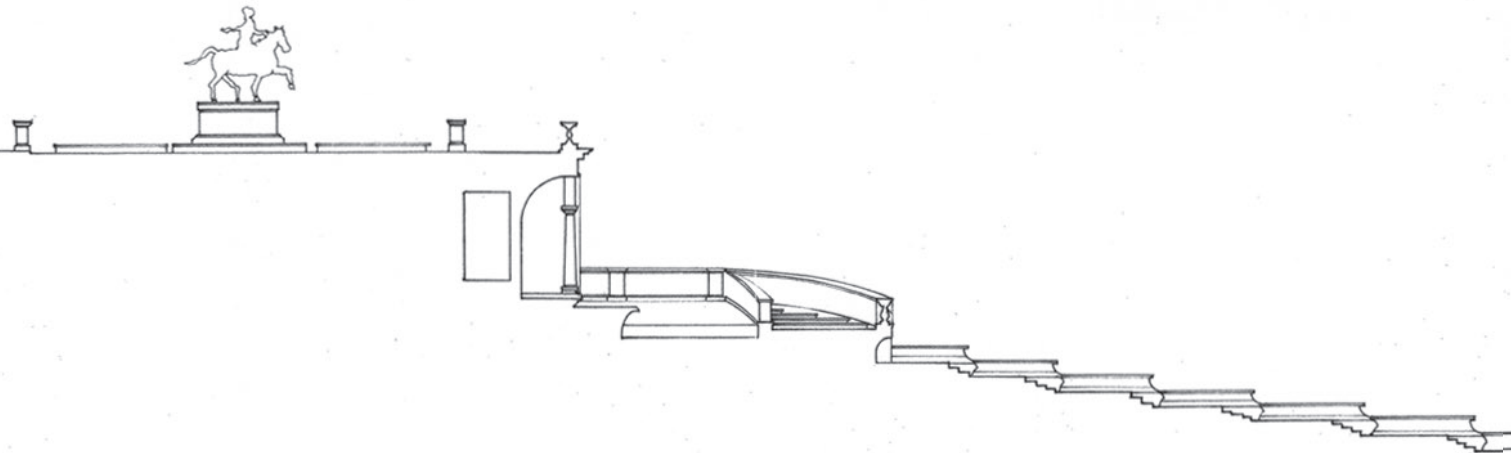

partial section through Meridian Hill Park

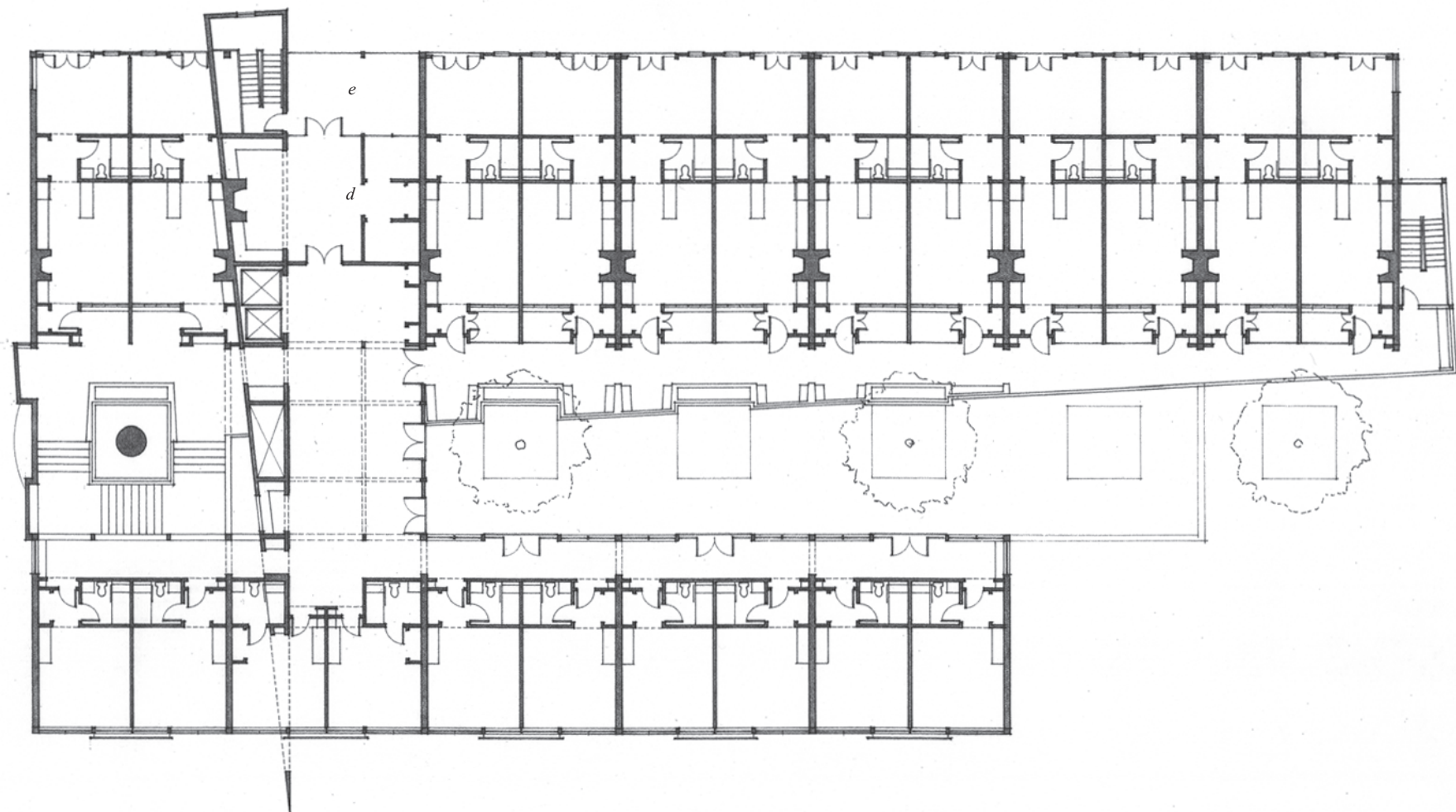

third floor plan

conceptual

While the spatial hierarchy and formal organization are primarily obligated to a logic of utility, the distribution of the program was incidentally influenced by an alternative rationale—a “hierarchy of needs.” Although it was not intended to be a *literal*, three-dimensional, translation of Maslow’s triangle,³ the building program, in section, does bear a compositional resemblance to the familiar psychology diagram.

Basically, the spaces that are associated with physical, or physiological needs, and those that relate to the individuals place in the community—social and belonging needs, are located on the lowest levels. They are “of the earth,” terrestrial rooms that satisfy the most essential of needs. A real and implied sense of security develops as one gets higher in the building, and the spaces become less accessible to non-residents.

Ultimately, though perhaps a bit whimsical, the highest attainable place in the building is the most spiritual, the observatory. It is the place where unobstructed, extremely focused, views are possible. Whether gazing upon stars, or the sites of Washington, it is a place of meditation and contemplation—on one’s own place in the city, and inevitably, one’s place in the universe. This final, celestial “room,” is the program equivalent to Maslow’s highest attainable level of being, self-actualization.



PLACES & SPACES

shared

The public rooms are designed to allow for an old-fashioned, but not forgotten, way of living, one that recognizes the importance of ritual and formality. The grand scale of the lobby and shopping **arcade** is balanced by the sitting niches and planting beds. Perhaps the retail space on the street level are filled with amenities particularly suited for the elderly residents—a beauty salon, drugstore and bank branch, a café on the corner—a chance to sit and have coffee or tea while waiting for a ride.

The residents' **lobby** is generous enough to allow for waiting—whether for the elevator, or your evening's companion to make an entrance from the grand stair. Still, it is an area that is protected by its separation from the bustle of the main building lobby. Places to linger are recessed within the wedge, made intimate by lowered ceilings and built-in benches.

Discreet access to the **fitness center** happens off of the stair's first landing—actually access is to the locker rooms, the gym itself is reached by via bridges that cross the lobby. The volume of the gymnasium is light-filled, with views of the grassy churchyard below. A lap pool spanning almost the entire length of the southern facade, passing through the wedge, creates the ground level loggia. Large french doors open the volume up to the outside in good weather, presumably when the pool is open, expanding the space. The upper-level observation deck brings access and abundant light to the **courtyard**.

Inspired by a grand tradition of hotel ballrooms and restaurants, the **dining room** is a monumental space that could easily contain the entire resident population. Despite its proportions, there are potentially smaller “rooms within the room.” Two walls with back-to-back fireplaces divide the overall space into smaller dining rooms, and may also be closed off for private parties and events. Alternating built-in window seats and french doors along the park and courtyard facades suggest zones for travel and seating.

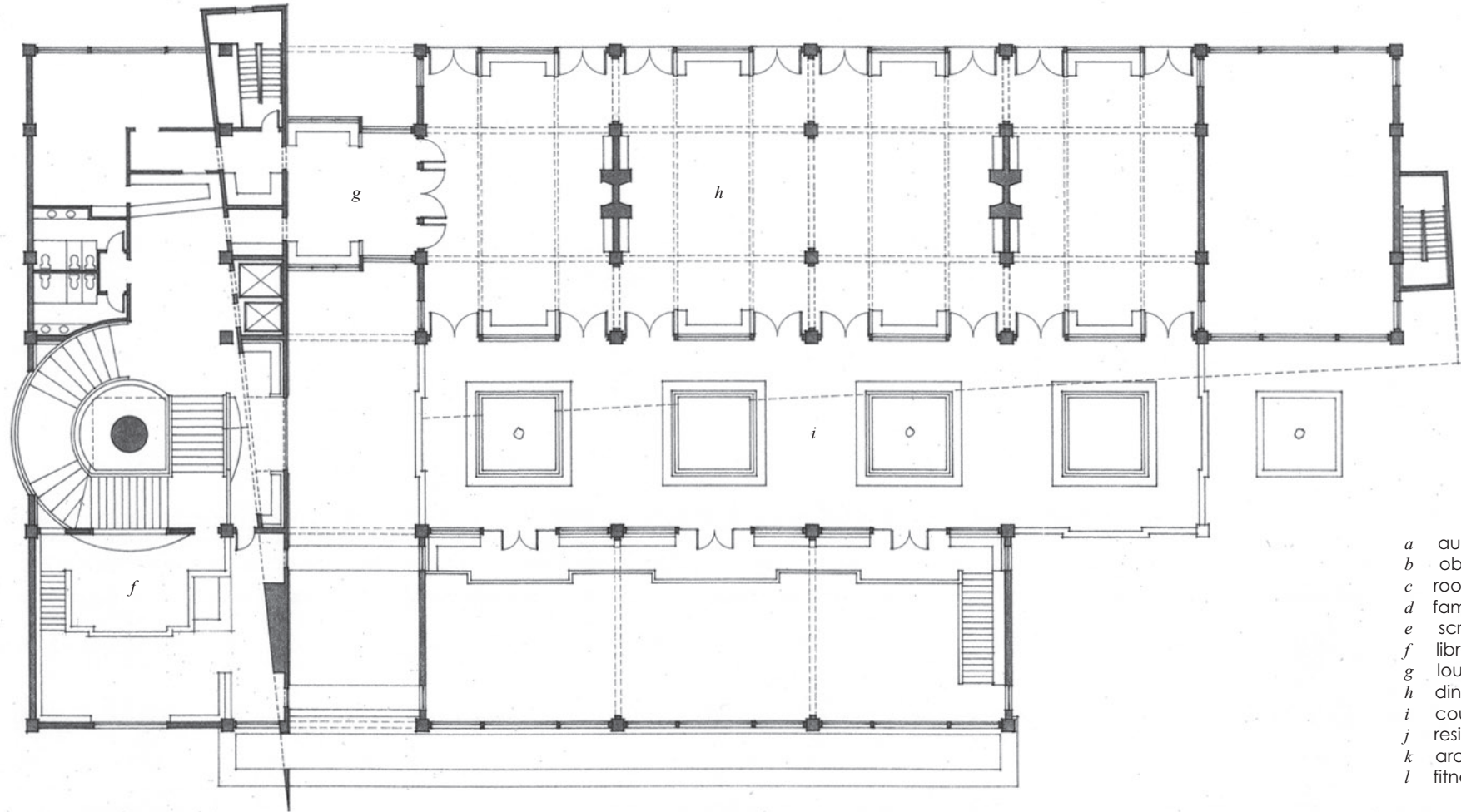

second floor plan

- a* auditorium
- b* observatory
- c* roof deck
- d* family room
- e* screened porch
- f* library
- g* lounge
- h* dining room
- i* courtyard
- j* residents' lobby
- k* arcade
- l* fitness center

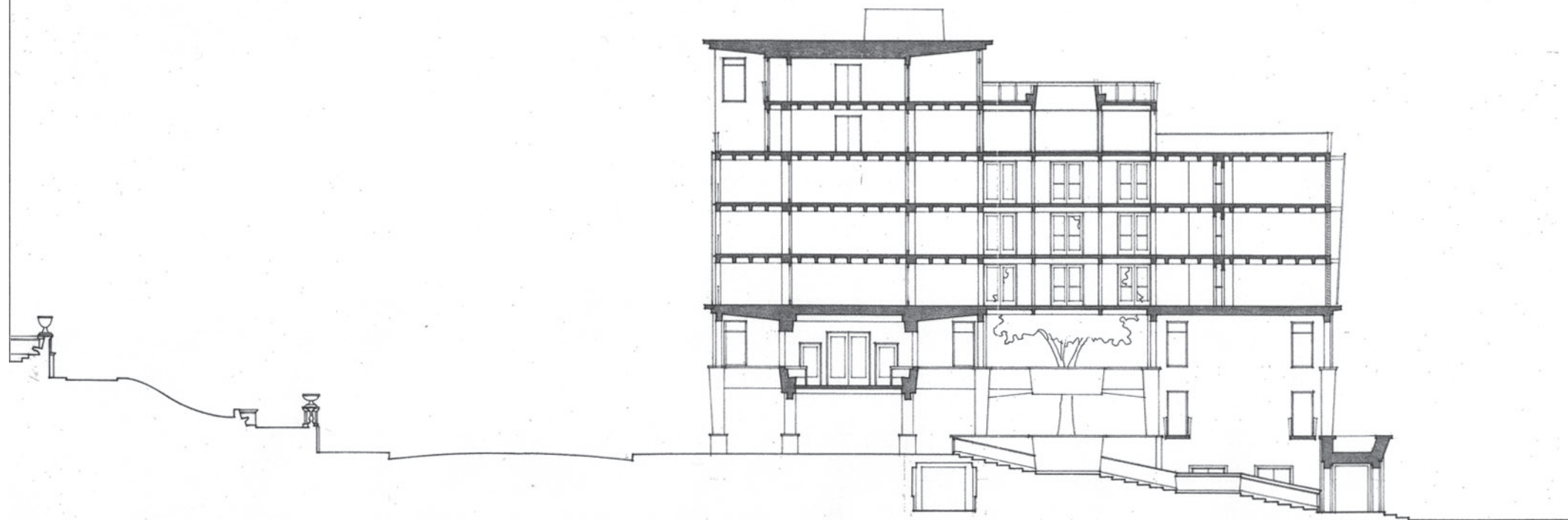

section through landscape stair

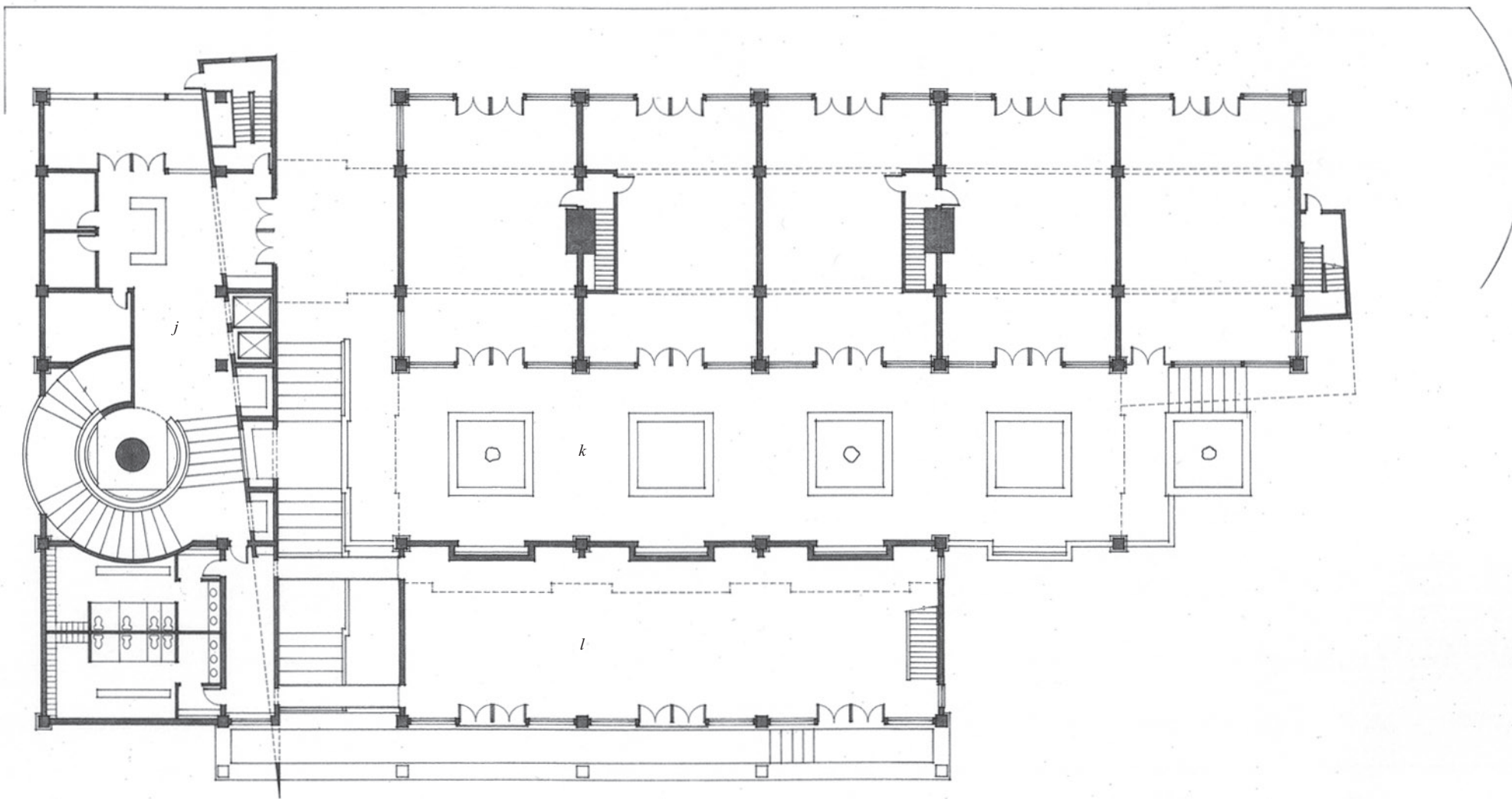

first floor plan

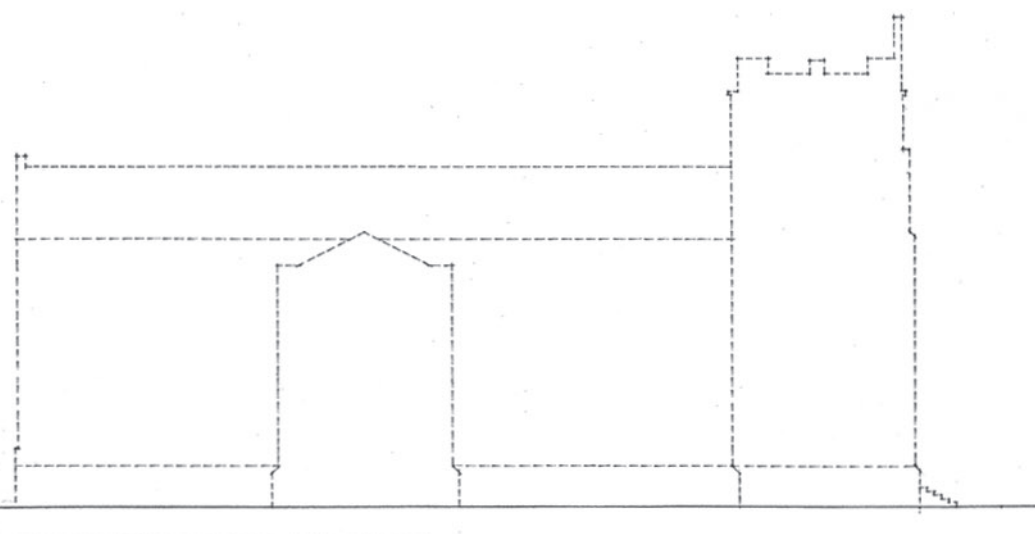

intimate

The circular stair becomes rectilinear when ascending from the second floor, its transformation signaling the transition into the most private, residential levels. Landings are frequent and generous—pauses that are accentuated by openings in the wedge, offering framed views of the courtyard. Some landings penetrate the envelope of the building on the east facade, allowing an occasional glimpse of the park. A more expeditious route, the elevator, is housed within the wedge.

The residents' **library** is secluded behind the wedge, overlooking the rear facade of the church. Entry from the main stair puts one at eye-level with the stained-glass rose window, an exclusive perspective. The sunny room is small and private, with a sense of separation created by two levels of bookshelves and "rest areas."

Family rooms give residents a place to come together, outside of their own units—to play bridge or listen to music. "Inglenooks"—fireplaces and lowered ceilings, within the wedge make for an intimate sitting area around the hearth.

Reached by first going "outside" and passing through the wedge once again, the **observatory** is on the seventh floor—the last residential level. Its circular "base" is enclosed entirely with windows, flooding the stairwell with light from above. The telescope room offers only select views of the city's monumental beacons, its primary focus on the expansion upward. The exterior stair culminates in a wrap-around observation deck that is precisely aligned with the park's highest terrace.

MATERIALS

solid

The use of **concrete** is both practical and expressive. The bay system and repetition of units lends itself to concrete construction. But the choice really comes from the properties of this modern material which allows a degree of malleability and continuity, responding to an old idea that design can and should be integral with structure. This concept is also inspired by the language of Meridian Hill Park, where the earliest use of exposed aggregate concrete occurs.

The structure becomes the raised “sidewalks” that parallel the building’s courtyard. Concrete “turns up” to enclose the walks, becoming alternately flower and planting beds, or intimate seating that overlooks the communal space. Each nook is slightly different, for its obedience to the grid system of the larger project, parting to make way for the trees. The floors on this public way are scored to suggest this grid and the same pattern takes itself into the individual apartments, picking up again deeper into the unit.

On the lower, terrestrial levels, the pattern is conveyed with **slate** pavers instead, an earthier walking surface for those “exterior” rooms. **Limestone** is used to wrap the concrete structure—columns on the first floors, that are more exposed on succeeding floors as the loads lessen. Panels are attached to the limited expanses of wall surface—the end walls and twelve-foot sections of the front facade, telegraphing the intermediate structure and lending some privacy from the street and park.

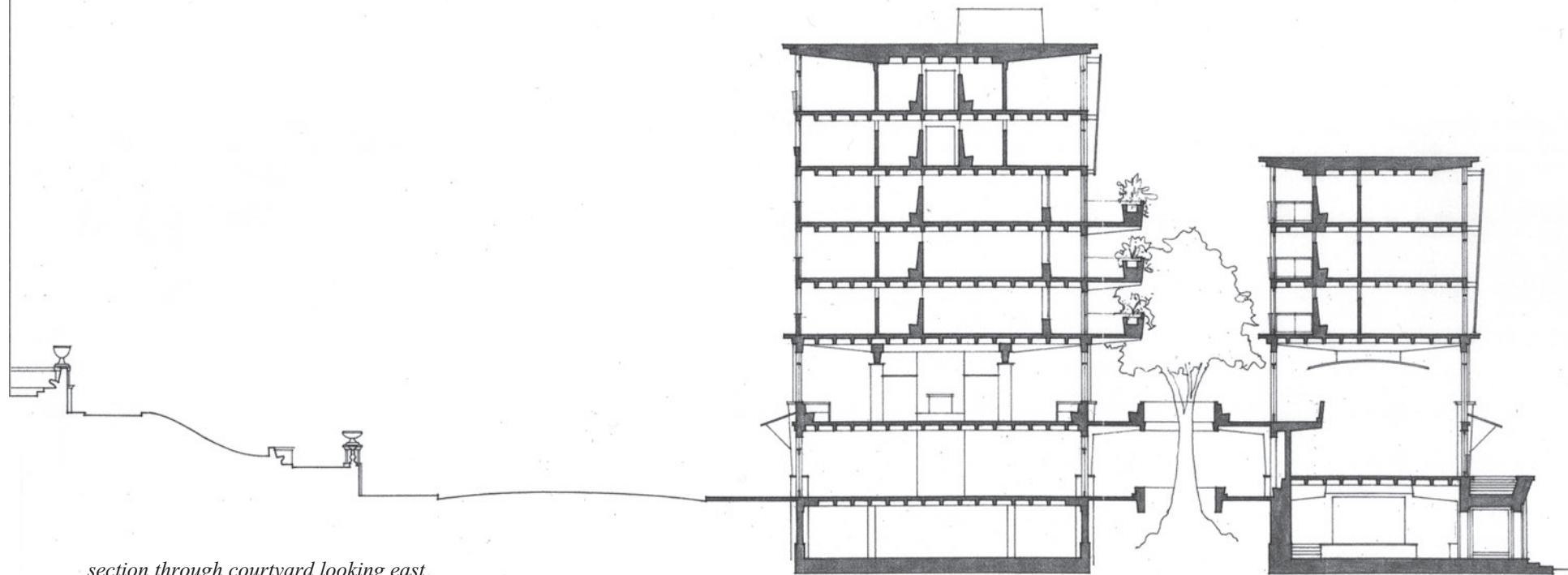
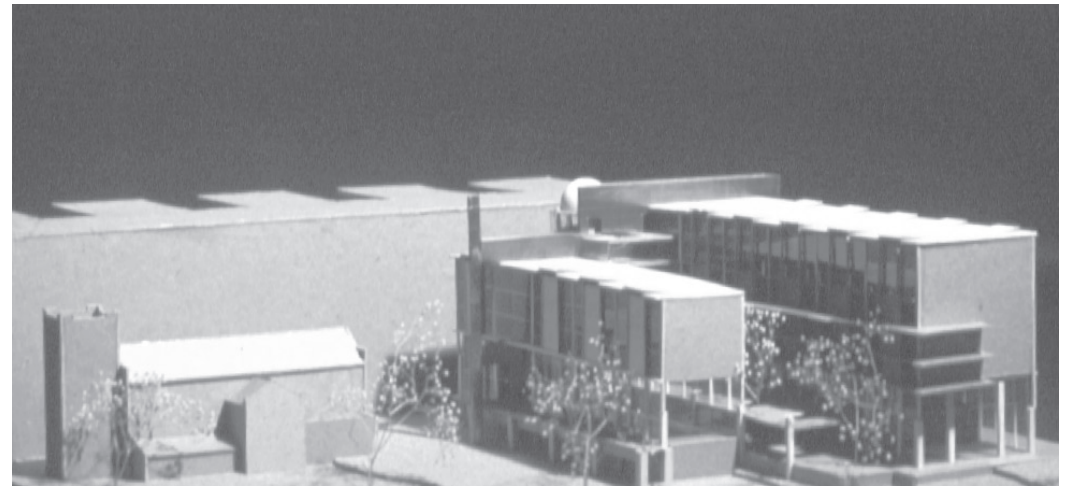
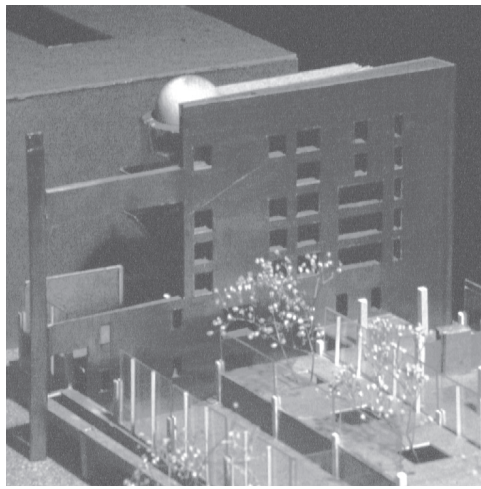

section through courtyard looking east.

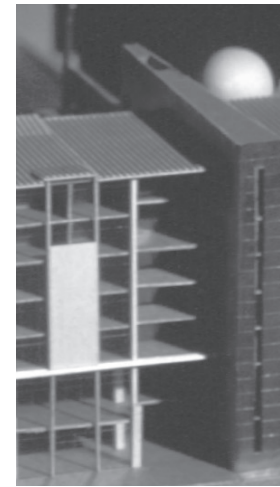
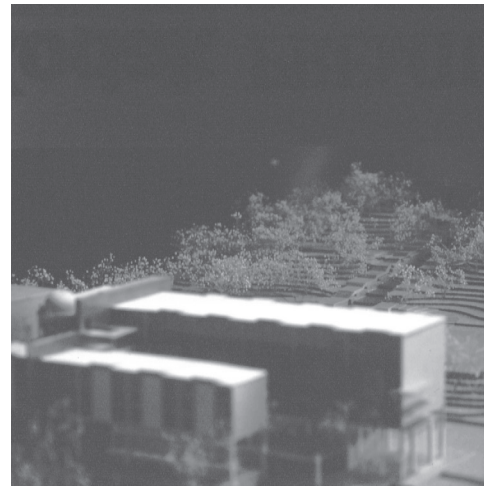
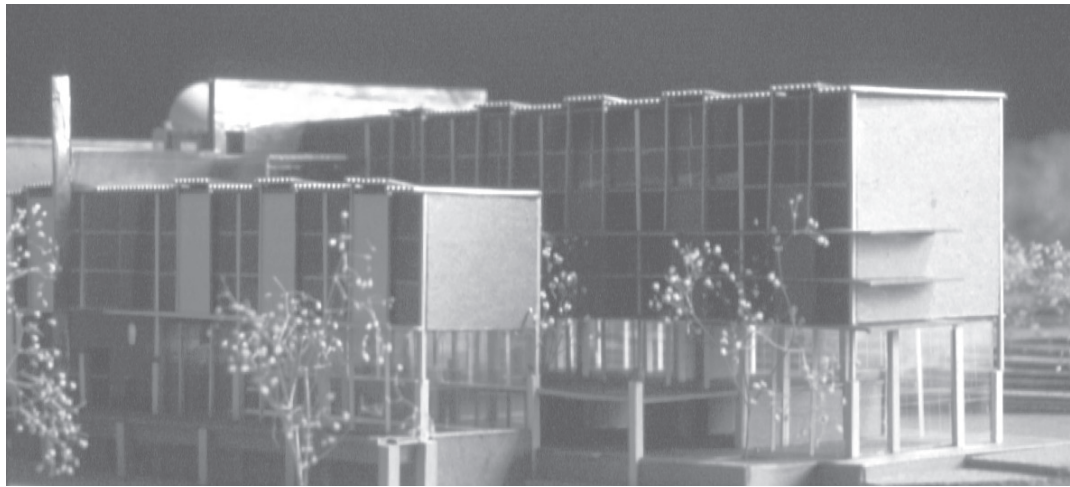

sublime

The surface of the triangular wedge is clad in **copper**, a traditional building material in Washington, one that is usually chosen for its longevity. The paneled metal lines both “street” facades—the front, which visually terminates the axial view from the center of the park’s upper terrace, and the entire face along the monument promenade. The tip of the wedge is a nearly 90-foot tall piece of solid cast copper.

The copper facade is both interior and exposed to the elements, allowing the metal to weather and change with time as a gesture to the residents, becoming more beautiful as it ages. This irregular surface becomes familiar in different places—an orientation device for residents as they swim laps beneath the afternoon shadow of the wedge, or sit in the shelter of the park-front porches.

Screens are used generously, though purposefully. The connection with the outdoors, and often by default, with neighbors, is essential to mental and physical well-being. The mere opening of a door is both an extension of living space and a gesture to the community.

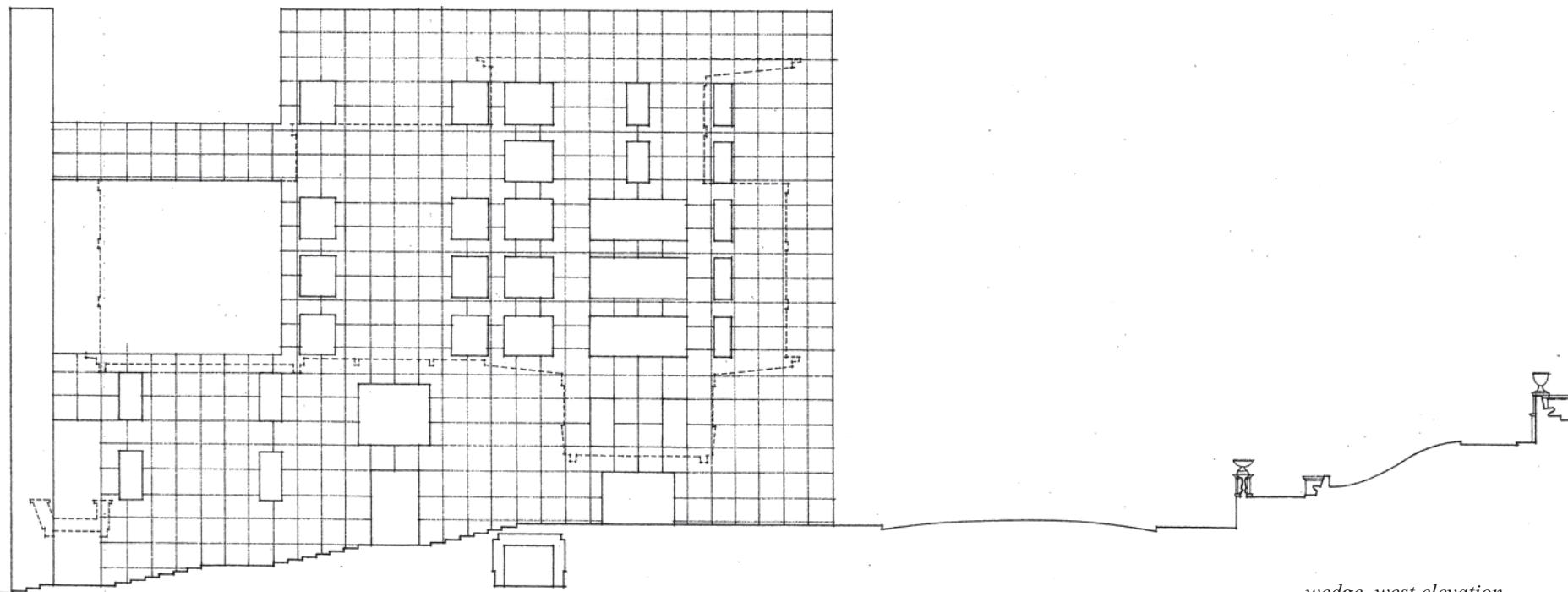

wedge, west elevation

LIVING

independent

The first three levels of residences are geared toward a more independent lifestyle, and the parkside units have exterior entrances. The sequence has the feeling of a sidewalk—a transition from public-to-private spaces much like a typical, urban rowhouse. The front entries, set back from the walkway, are individually lit, and have mailboxes, newspaper and trash bins. Small screened porches, semi-private exterior living space, admit light while acting as a buffer from the living room. The view of the courtyard from the porch is filtered by built-in balcony planters and seating—socially, the “front stoop.”

Inside, the foyer has a coat closet and access to the screen porch, to transition into the main living area. Fireplaces with built-in shelves help to separate the kitchen and eating area, as the spaces become increasingly private. Another transverse zone, consisting of closet and bathroom, is passed through before entering the bedroom. This most private of spaces faces Meridian Hill Park, and french doors open up the room to the outside. This screened “porch,” together with the screened front door, allows air to flow through the entire apartment in fair weather.

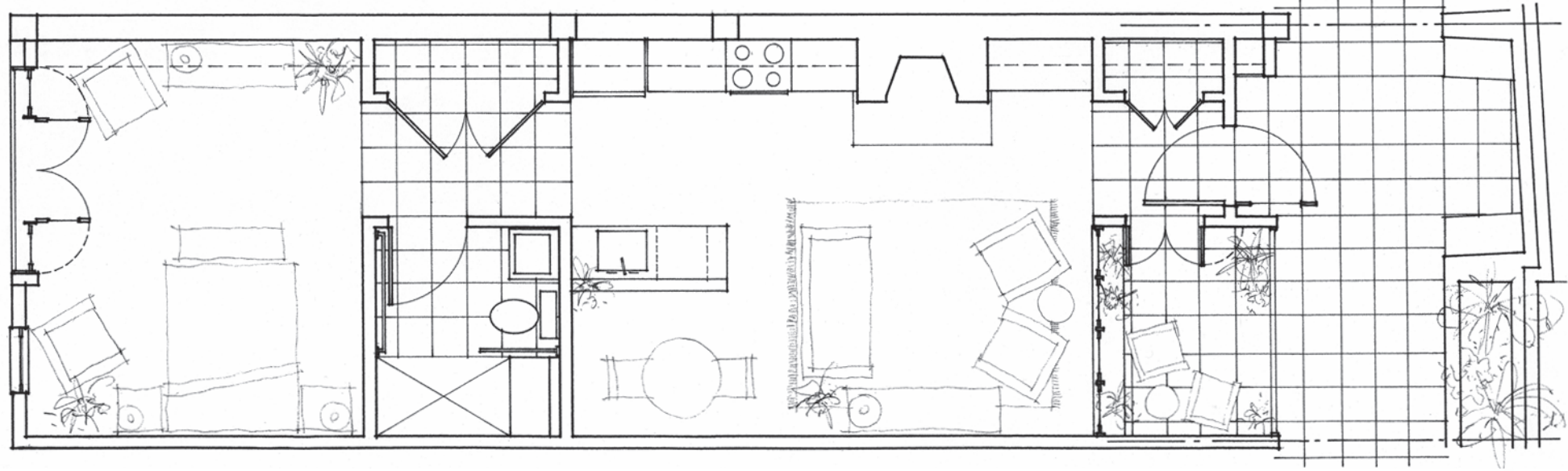

north elevation

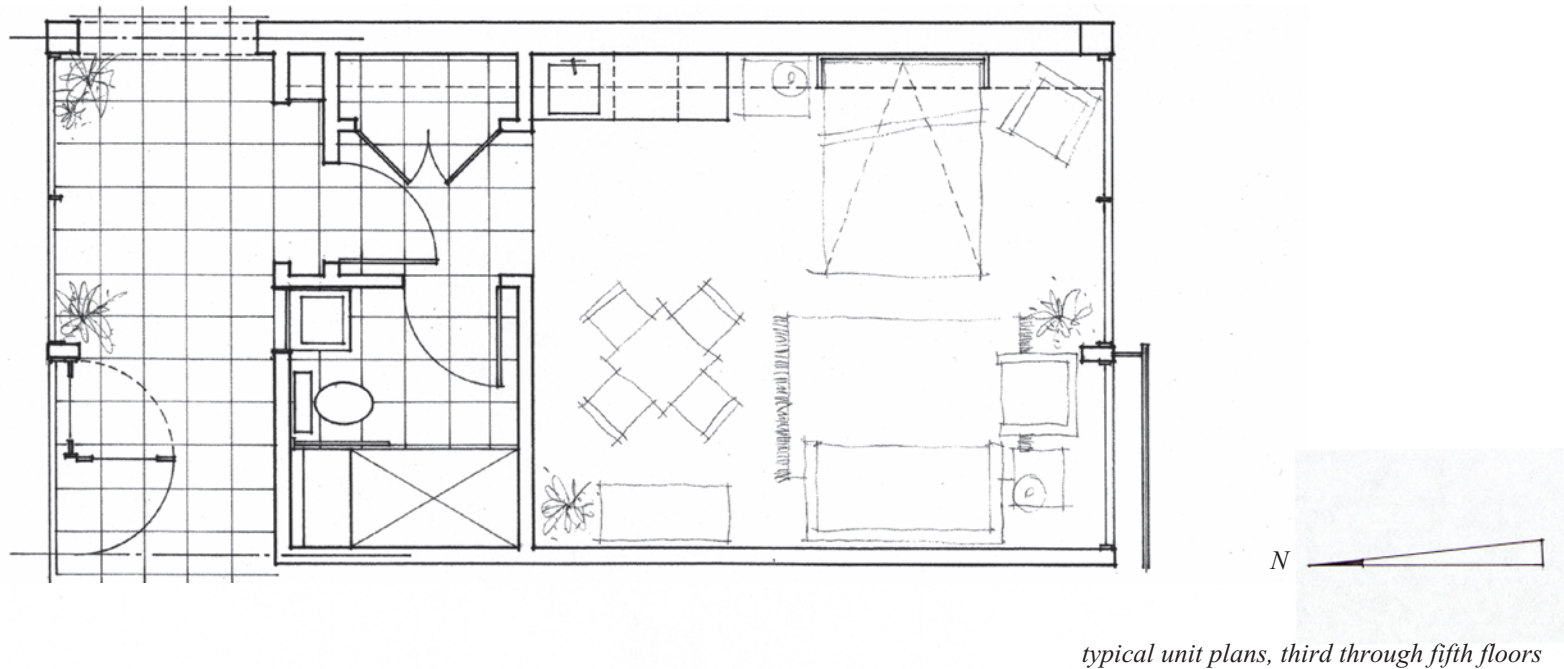

typical unit plans, third through fifth floors

assisted

The units that face the churchyard enclose the courtyard on its south side. These efficiencies are accessed from the semi-enclosed "hall"—with the french doors open, one could be walking in a tree house. The entry foyer and bath zone is combined in this type, removing the living area from the main circulation. A clear view out to the churchyard visually extends the space, while some privacy and solar protection is achieved with adjustable louvered panels.

Two final levels of residences are stacked above the independent living floors—double-loaded corridors with "studio" apartments. Intended for the residents who need the most assistance, or as guest rooms, they are the most enclosed for security and comfort's sake. They have the most expansive private views in the building of the park and city—perhaps the penultimate view.

As one ages, they must be allowed to remain a part of their community, their foundation. It is important to retain some of what is familiar, as one changes and grows, as the environment around them changes. While no one can be expected to stay in one place forever, their "place" in their environment should be considered. Although not much can be anticipated in the life of a building, what is important is the recognition and celebration of what life *might* be like in a building.

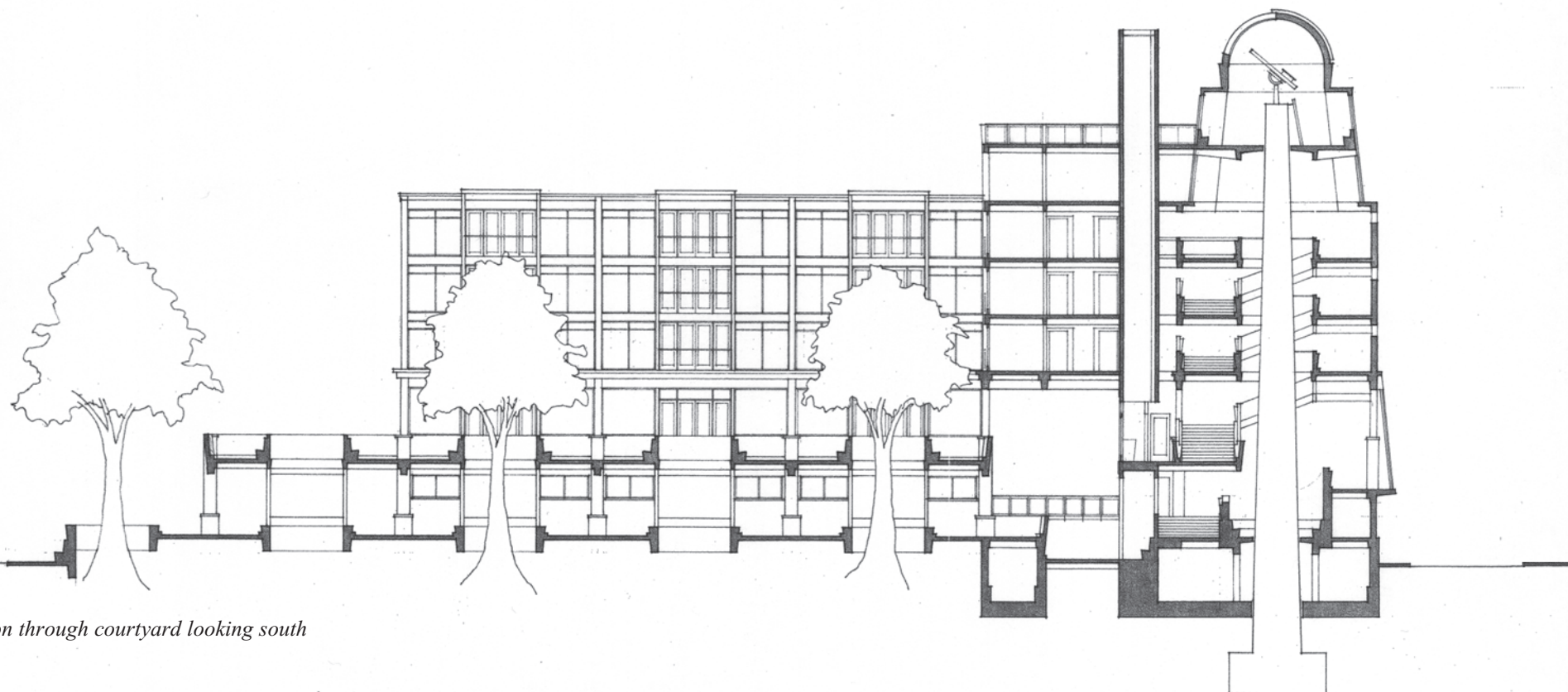

section through courtyard looking south

VITA

education

Master of Architecture

Virginia Polytechnic Institute &
State University/Washington-
Alexandria Architecture Consortium,
Alexandria, VA
1997-1999

Bachelor of Science

in Architecture, University of
Maryland, College Park, MD
1988-1999

experience

The Rkfects Studio, Inc

1010 King Street, Alexandria, VA
1999-present

Kristin L. O'Connell

22 Cornhill Street, Annapolis, MD
1995-1999

John J. Schwarz, Architect

47 State Circle, Annapolis, MD
1994-1997

Schwarz Purcell Architects

One State Circle, Annapolis, MD
1993

awards

Selected Project

ACSA/Wood Products Promotion
Council 1997-98 Student Design
Competition, Washington, DC
1998

Judge

American Horticultural Society
Youth Garden Design Competition,
Alexandria, VA
1998

WAAC Finalist

Virginia Society AIA Design
Competition, State of Virginia
1997

kristin l. o'connell

model view, looking toward Meridian Hill Park

1 Photo appeared in February 1, 1999 edition of *The Washington Post*

2 Drawing of Meridian Hill Park from HABS

3 Abraham H. Maslow, "*Hierarchy of Needs*"

acknowledgments

This book is dedicated to a several people who have devoted their lives, whether by profession or simply in practice, to the development of young architects. The first is my mentor, my friend, Jay Schwarz, whose life as an architect mirrored my image of one, and who gave me the confidence to pursue this degree. The teachers I was then fortunate enough to encounter, whose collective belief in this project was as real as it was to me—Mark McInturff, Paul Emmons, and, especially, Susan Piedmont-Palladino, whose collaboration and affirmation give me the confidence to pursue this profession.

The emotional and financial support of my family and friends, especially Mom, Dad, and Kevin, gave me the freedom to devote myself exclusively to this achievement. I cannot possibly thank you enough.