

Copyright by the Virginia Center for
Transportation Innovation and Research.
Thomas E. Cousins, Thomas M. Murray, and
Devin K. Harris. "Use of a Sandwich Plate
System in a Virginia Bridge," Virginia
Transportation Research Council 530 Edgemont
Road Charlottesville, VA 22903, Report No.
FHWA/VTRC 09-CR12, May 2009.

FINAL
CONTRACT REPORT
VTRC 09-CR12

USE OF A SANDWICH PLATE SYSTEM IN A VIRGINIA BRIDGE

THOMAS E. COUSINS, Ph.D., P.E.
Professor

THOMAS M. MURRAY, Ph.D., P.E.
Montague-Betts Professor of Structural Steel Design

DEVIN K. HARRIS
Graduate Research Assistant

Via Department of Civil and Environmental Engineering
Virginia Polytechnic Institute & State University



Standard Title Page - Report on Federally Funded Project

1. Report No.: FHWA/VTRC 09-CR12		2. Government Accession No.:		3. Recipient's Catalog No.:	
4. Title and Subtitle: Use of a Sandwich Plate System in a Virginia Bridge				5. Report Date: May 2009	
				6. Performing Organization Code:	
7. Author(s): Thomas E. Cousins, Thomas M. Murray, and Devin K. Harris				8. Performing Organization Report No.: VTRC 09-CR12	
9. Performing Organization and Address: Virginia Transportation Research Council 530 Edgemont Road Charlottesville, VA 22903				10. Work Unit No. (TRAIS):	
				11. Contract or Grant No.: 77920	
12. Sponsoring Agencies' Name and Address: Virginia Department of Transportation Federal Highway Administration 1401 E. Broad Street 400 North 8th Street, Room 750 Richmond, VA 23219 Richmond, VA 23219-4825				13. Type of Report and Period Covered: Final Contract	
				14. Sponsoring Agency Code:	
15. Supplementary Notes: This project was financed with federal grant funds through the FHWA's Innovative Bridge Research and Deployment Program at an estimated total project cost of \$262,547.					
16. Abstract: <p>The deterioration of the nation's civil infrastructure has prompted the investigation of numerous solutions to the problem. Some of these solutions have come in the form of innovative materials for new construction, whereas others have considered rehabilitation techniques for repairing existing infrastructure. A relatively new system that appears capable of encompassing both of these solution methodologies is the sandwich plate system (SPS), a composite bridge deck system that can be used in both new construction or for rehabilitation applications. SPS consists of steel face plates bonded to a rigid polyurethane core; a typical bridge application utilizes SPS primarily as a bridge deck acting compositely with conventional support girders. As a result of this technology being relatively new to the bridge market, design methods have yet to be established. This research aims to close this gap by investigating some of the key design issues considered to be limiting factors in implementation of SPS. The key issues that will be studied include lateral load distribution, dynamic load allowance, and deck design methodologies.</p> <p>With SPS being new to the market, there has been only one bridge application, limiting the investigations of in-service behavior. The Shenley Bridge, located near Quebec, Canada, was tested under live load conditions to determine in-service behavior with an emphasis on lateral load distribution and dynamic load allowance. Both static and dynamic testing was conducted. Results from the testing allowed for the determination of lateral load distribution factors and dynamic load allowance of an in-service SPS bridge. Results from this study suggest that the behavior of an SPS does differ somewhat from conventional systems, but the response can be accommodated with current AASHTO Load and Resistance Factor Design (LRFD) provisions as a result of their conservativeness.</p> <p>In addition to characterizing global response, a deck design approach was developed in this research project. In this approach, the SPS deck was represented as a plate structure, which allowed for the consideration of the key design limit states within the AASHTO LRFD specification. Based on the plate analyses, it was concluded that the design of SPS decks is stiffness-controlled as limited by the AASHTO LRFD specification deflection limits for lightweight metal decks. These limits allowed for the development of a method for sizing SPS decks to satisfy stiffness requirements.</p>					
17 Key Words: Steel sandwich panel, composite bridge decks			18. Distribution Statement: No restrictions. This document is available to the public through NTIS, Springfield, VA 22161.		
19. Security Classif. (of this report): Unclassified		20. Security Classif. (of this page): Unclassified		21. No. of Pages: 35	22. Price:

FINAL CONTRACT REPORT

USE OF A SANDWICH PLATE SYSTEM IN A VIRGINIA BRIDGE

**Thomas E. Cousins, Ph.D., P.E.
Professor**

**Thomas M. Murray, Ph.D., P.E.
Montague-Betts Professor of Structural Steel Design**

**Devin K. Harris
Graduate Research Assistant**

**Via Department of Civil and Environmental Engineering
Virginia Polytechnic Institute & State University**

Project Manager

Jose P. Gomez, Ph.D., P.E., Virginia Transportation Research Council

Contract Research Sponsored by
the Virginia Transportation Research Council
(A partnership of the Virginia Department of Transportation
and the University of Virginia since 1948)

In Cooperation with the U.S. Department of Transportation
Federal Highway Administration

Charlottesville, Virginia

May 2009
VTRC 09-CR12

DISCLAIMER

The project that is the subject of this report was done under contract for the Virginia Department of Transportation, Virginia Transportation Research Council. The contents of this report reflect the views of the authors, who are responsible for the facts and the accuracy of the data presented herein. The contents do not necessarily reflect the official views or policies of the Virginia Department of Transportation, the Commonwealth Transportation Board, or the Federal Highway Administration. This report does not constitute a standard, specification, or regulation. Any inclusion of manufacturer names, trade names, or trademarks is for identification purposes only and is not to be considered an endorsement.

Each contract report is peer reviewed and accepted for publication by Research Council staff with expertise in related technical areas. Final editing and proofreading of the report are performed by the contractor.

Copyright 2009 by the Commonwealth of Virginia.
All rights reserved.

ABSTRACT

The deterioration of the nation's civil infrastructure has prompted the investigation of numerous solutions to the problem. Some of these solutions have come in the form of innovative materials for new construction, whereas others have considered rehabilitation techniques for repairing existing infrastructure. A relatively new system that appears capable of encompassing both of these solution methodologies is the sandwich plate system (SPS), a composite bridge deck system that can be used in both new construction or for rehabilitation applications. SPS consists of steel face plates bonded to a rigid polyurethane core; a typical bridge application utilizes SPS primarily as a bridge deck acting compositely with conventional support girders. As a result of this technology being relatively new to the bridge market, design methods have yet to be established. This research aims to close this gap by investigating some of the key design issues considered to be limiting factors in implementation of SPS. The key issues that will be studied include lateral load distribution, dynamic load allowance, and deck design methodologies.

With SPS being new to the market, there has been only one bridge application, limiting the investigations of in-service behavior. The Shenley Bridge, located near Quebec, Canada, was tested under live load conditions to determine in-service behavior with an emphasis on lateral load distribution and dynamic load allowance. Both static and dynamic testing was conducted. Results from the testing allowed for the determination of lateral load distribution factors and dynamic load allowance of an in-service SPS bridge. Results from this study suggest that the behavior of an SPS does differ somewhat from conventional systems, but the response can be accommodated with current AASHTO Load and Resistance Factor Design (LRFD) provisions as a result of their conservativeness.

In addition to characterizing global response, a deck design approach was developed in this research project. In this approach, the SPS deck was represented as a plate structure, which allowed for the consideration of the key design limit states within the AASHTO LRFD specification. Based on the plate analyses, it was concluded that the design of SPS decks is stiffness-controlled as limited by the AASHTO LRFD specification deflection limits for lightweight metal decks. These limits allowed for the development of a method for sizing SPS decks to satisfy stiffness requirements.

FINAL CONTRACT REPORT

USE OF A SANDWICH PLATE SYSTEM IN A VIRGINIA BRIDGE

Thomas E. Cousins, Ph.D., P.E.
Professor

Thomas M. Murray, Ph.D., P.E.
Montague-Betts Professor of Structural Steel Design

Devin K. Harris
Graduate Research Assistant

Via Department of Civil and Environmental Engineering
Virginia Polytechnic Institute & State University

INTRODUCTION

During a time when the current bridge inventory is aging and traffic demands are on the rise, the need exists for the development of new bridge technologies to offset these changes. These new technologies must improve service life and speed of construction, lower cost, and provide reserve strength for additional traffic demands. These requirements are in line with the initiatives of the Federal Highway Administration to reduce the number of deficient bridges in the United States. One technology, that may meet these initiatives, is a bridge deck system called the sandwich plate system (SPS).

The SPS is an innovative bridge deck system that can be used for both new bridge construction and bridge rehabilitation applications. The SPS consists of steel plates bonded to a rigid polyurethane core as shown in Figure 1. The SPS deck is analogous to an I-beam when subjected to flexure with the steel plates acting as the flanges and the elastomer core as the web. The steel plates are designed to resist the loads resulting from flexure while the core resists the transverse shear. A typical bridge application utilizes SPS primarily as a bridge deck acting compositely with conventional support girders, but other applications have also been given consideration. An SPS bridge deck is typically constructed from a series of panel segments, matching the width of the bridge, connected together along the span of the bridge.



Figure 1. Sandwich Plate System

SPS is similar to a conventional orthotropic plate solution, but without the required intermediate stiffeners; the polyurethane core serves the same purpose as intermediate stiffeners by providing continuous support to the steel plates. Since the core is continuous the local buckling effect resulting from discretely spaced stiffeners is eliminated. Additionally, the lack of intermediate stiffeners eliminates the “hard spots” inherent to orthotropic decks resulting in a more continuous system. The versatility of SPS allows for implementation in a wide variety of bridge applications including new construction, deck replacement, and deck rehabilitation. The following sections provide more thorough descriptions of the SPS as it relates to bridge applications.

History of Sandwich Construction

The principles behind SPS are the same as for conventional sandwich construction, in which rigid face plates bound a softer, less stiff core. In conventional sandwich construction the face plates are primarily intended to resist in-plane and lateral loads while the core material resists transverse shear loads. The configuration of the face plates is fairly standard, but wide variations in the core structure allow sandwich panels to be tailored for specific applications (Figure 2). Stiffness in sandwich construction is proportional to the core stiffness and as a result variations in core material, core thickness, and geometric configuration allow for section optimization without a significant increase in weight. For design purposes, consideration of the cost/benefit should be employed in the selection of the core material and geometry (Vinson 1999). The behavior of sandwich composites is similar to that of laminated composites in that each layer maintains unique properties, but must function as part of a unit. For this reason the application of laminate theory has often been employed in the design of sandwich structures.

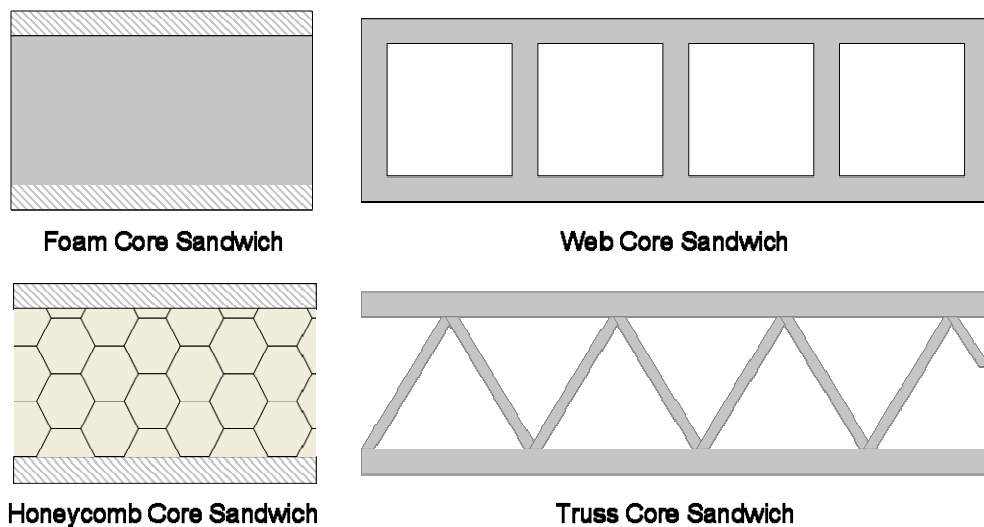

Figure 2. Representations of Sandwich Construction Configurations

When comparing the use of sandwich construction to an equivalent weight non-sandwich solution, considerable improvements in flexural stiffness and a reduction in flexural stress can be achieved with sandwich construction (Vinson 1999). The sandwich configuration increases the distance between the face plates, increasing the flexural stiffness and in turn reducing the normal

flexural stresses (Figure 3). This comparison is analogous to that between a rectangular beam section and an I-section of equal weight; the flanges of the I-section increase the moment of inertia in turn reducing the peak stress. These improvements allow for a sandwich structure to be tailored for a specific application by varying the core material, core thickness, face material, and face thickness.

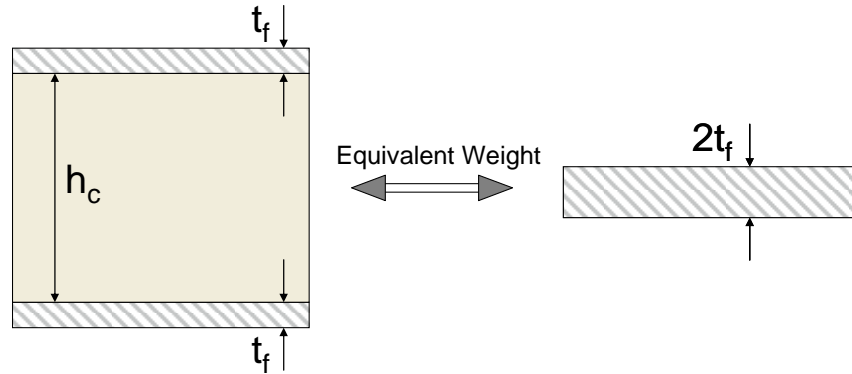

Figure 3. Comparison of Equivalent Weight Systems: Sandwich vs. Thin Plate

While SPS can likely be considered the first application of sandwich construction in a bridge application, the technology of sandwich construction dates back to the World War II era. A British World War II bomber, the Mosquito, is credited with being the first application of sandwich construction in the 1940s (Vinson 1999). The design of this aircraft revolutionized the aircraft industry and was later extended to missile and spacecraft structures including the Apollo Capsule (Davies 2001). Some of the notable benefits of conventional sandwich construction include: weight savings over conventional structures, resistance to local deformation, good rigidity, thermal and acoustical insulation, good fatigue resistance, and ease of mass production (Plantema 1966). These same characteristics are what make SPS an attractive solution for use in the bridge market.

History of the Sandwich Plate System

Intelligent Engineering (IE) developed and patented the SPS technology over a 10-year period in collaboration with Elastogran GmbH, an affiliate of BASF. The SPS was initially developed for use in the maritime industry as a deck replacement system for deteriorating ship decks. After a few years IE began to branch out into the civil engineering industry, specifically the bridge market. Current and potential SPS applications include ship repair, new-build ship components, maritime overlays, new bridge construction, bridge deck repair/rehabilitation, stadium risers, and building floor systems (Kennedy et al. 2006). While the maritime applications provide significant insight into the behavior of SPS, the focus herein will be related to the application of SPS in the bridge sector.

When compared to conventional bridge solutions such as reinforced concrete and orthotropic systems, SPS offers a number of advantages including: weight savings due to the light weight of the panels, speed of construction, impact resistance, and acoustic damping without sacrificing strength. The design of SPS panels can be tailored to specific applications by

varying the plate and core thicknesses. For new construction applications, the panels can be designed with support girders significantly smaller than a conventional solution. In rehabilitation applications, the SPS panels can be designed to work with the existing superstructure; this would typically result in additional capacity due to the reduction in dead load of the deck system.

As with other bridge deck systems, the SPS system does come with some disadvantages. On a Texas Department of Transportation bridge that is under construction the SPS bridge deck system used cost between \$70 and \$80 per square foot installed (Holt 2008). This price is significantly higher than that of a comparable reinforced concrete bridge deck system. Presently, due to the limited use of SPS panels in North America, each panel is custom made which increases the price and creates quality control issues. Also, there are no design standards for an SPS bridge deck system which makes each bridge a unique design experience.

In 2003 the Shenley Bridge was constructed in Saint-Martin, Québec, Canada, using an SPS deck (Figure 4). The Shenley Bridge has a span of 73.8 ft and a transverse width of 23.3 ft and was designed by IE with detailed finite element analyses, conforming to the Canadian Bridge Design Specification (CHBDC) (CSA 2000).

Construction of the bridge occurred over a 7-day period during November 2003 (see Figure 5). The construction began with the placing of the longitudinal plate girders on the abutments and connecting the lateral bracing diaphragms. With the girders in place, the SPS panels were placed and bolted to the girders and between panel joints sequentially along the span and then welded together at the panel seams. The final steps in the construction were attaching the guardrails and applying the wearing surface.

The composite bridge system was designed for the required ultimate, fatigue, and serviceability limit states required by the CHBDC. As part of the Ministry of Transportation of Québec accreditation process a series of validation tests were required for the SPS bridge system in accordance with CHBDC requirements. The purpose of these tests was to establish the ability of an SPS bridge structure to carry the anticipated truck loads, establish the behavior of SPS bridge, and provide field data to confirm the finite element analyses.

The Shenley Bridge is of primary interest for this research effort because at the time of project inception it was the only SPS bridge application in service. Additionally, it is the only new-build SPS bridge in service to date (IE 2007).

PURPOSE AND SCOPE

With SPS being relatively new to the bridge market, there has only been one new application. As a result, there is no standard in place for the design of bridges using SPS. This research effort investigated the global behavior of SPS bridges with a focus on critical design parameters such as lateral load distribution, dynamic load allowance, and deck design procedures. The results of this investigation are expected to aid in the development of design recommendations for the use of SPS bridges in the United States.



Figure 4. Shenley Bridge, Quebec, Canada



a) Deck panel installation



b) Underside connections

Figure 5. Shenley Bridge Construction

BRIDGE DESIGN OVERVIEW

The American Association of State Highway and Transportation Officials' (AASHTO) Load and Resistance Factor Design (LRFD) (AASHTO 2004) provides guidelines for the design of bridges subjected to load combinations that include the effects of as dead load, live load, earthquake, ice and collision. These load combinations allow for consideration of the limit states for strength, serviceability, extreme loading event, and fatigue. The following discussion considers only the live load scenario.

The live load for a bridge is considered to be a function of the number of design lanes, the bridge configuration and combinations of notional design trucks (Figure 6) and lane loads (Figure 7). For design purposes, the objective is to configure the loading to produce the greatest force effect on the static system and design for this effect. Due to the multi-dimensional nature of the bridge structure, final configuration of the loading is highly variable and not always simple to determine, often becoming an iterative or trial and error process. A number of approximate and refined methods of analysis exist that allow for simplification of this process. The most useful of these is the distribution factor method which accounts for transverse load distribution.

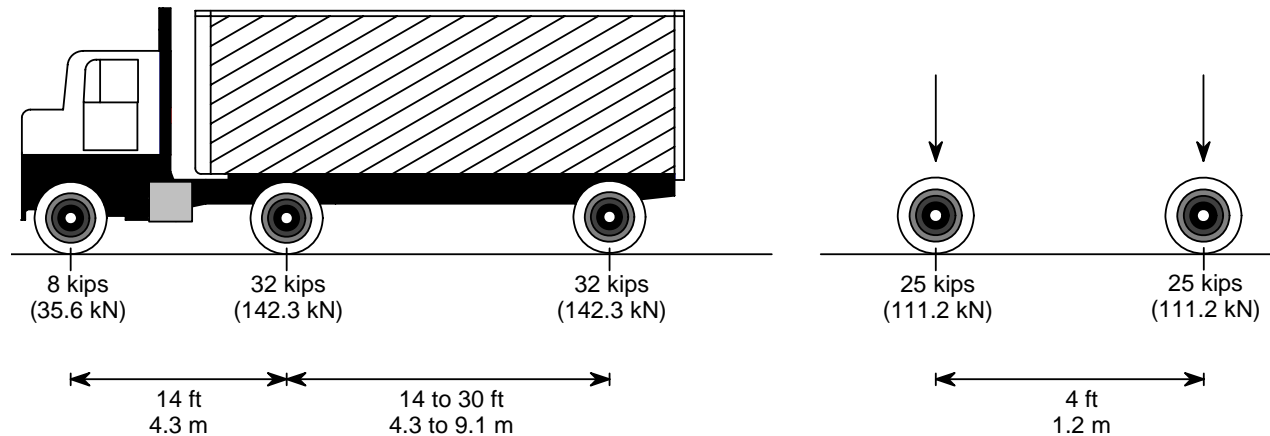

Figure 6. HS-20 and Tandem Design Trucks

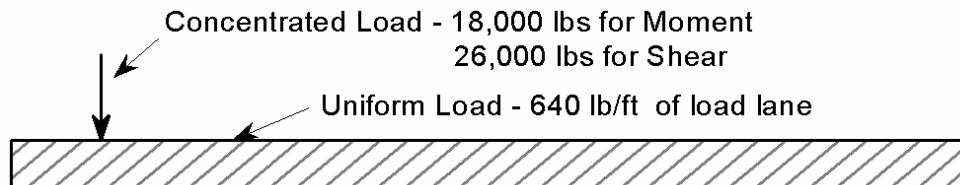

Figure 7. Design Lane Load

Live load in a bridge structure is by nature in motion and of considerable mass. The effect of this large mass in motion produces a dynamic effect on the bridge structures. This dynamic effect is considered additional to the static live load effect and can be significant. During design, this dynamic amplification of the static load must be considered as part of the design live load.

TEST PROGRAM

Field Test of the Shenley Bridge

The field testing of the Shenley Bridge was performed to assess the in-service behavior of an SPS bridge under live load conditions. This testing provided a means to measure transverse load distribution behavior for interior and exterior girders under single and multiple lane loaded conditions. In addition, this field test allowed for the investigation of the dynamic behavior of an SPS bridge subjected to moving truck loads. This section presents the background, results and findings from the field investigation of the Shenley Bridge performed in June 2005, after approximately 19 months in service. Further details of the field test of the Shenley Bridge can be found in Harris (2007).

Bridge Description

As previously mentioned, the Shenley Bridge (Figure 4) was constructed in Saint-Martin, Québec, Canada, during the fall of 2003 using an SPS deck as the bridge's riding surface. The Shenley Bridge has a span of 73.8 ft and a transverse width of 23.3 ft and was designed by IE with detailed finite element analyses, conforming to the Canadian Bridge Design Specification (CHBDC) (CSA 2000). Ten prefabricated SPS panels, eight full size (7.9 ft x 23.3 ft) panels and two scaled (5.4 ft x 23.3 ft) end panels, were used in the construction of the bridge (IE 2004). The panels were made composite with the three longitudinal support girders through slip critical bolts connecting the girder flanges to cold-formed angles welded to the SPS panels. Additionally, the panels were made continuous with slip-critical bolts on the underside between panels and transverse welds along the panel seams on the topside. A cross-section and a plan schematic of the bridge are presented in Figure 8 and Figure 9, respectively.

Instrumentation

The bridge was instrumented primarily for the investigation of transverse load distribution and dynamic load allowance. Displacements and strains were measured at midspan and near the supports on the extreme tension surface of the girders (Figures 10 and 11).

Displacements were measured using deflectometers attached to the bottom flange of the three girders with "C"-clamps, and in turn anchored in the creek bed below with wire attached to concrete-filled masonry blocks (Figure 12). The tips of the deflectometers were pre-deflected before loading allowing for a measurement of relative deflection, an increase in girder deflection resulting in a proportional decrease in tip deflection. The deflectometers were calibrated in the Virginia Tech Structures Laboratory to within 0.001 in prior to arrival on-site.

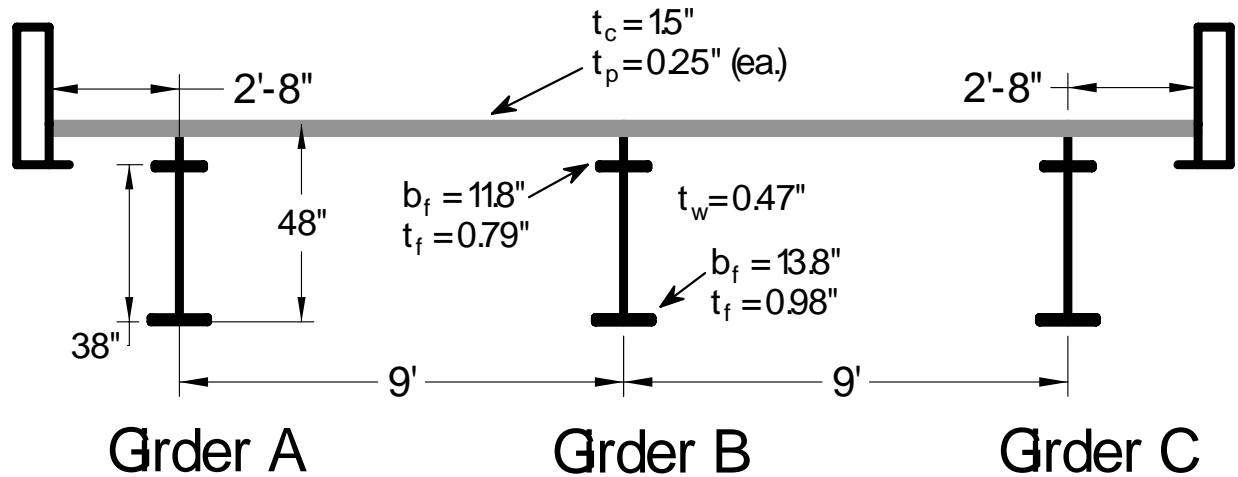

Figure 8. Shenley Bridge Cross-Section

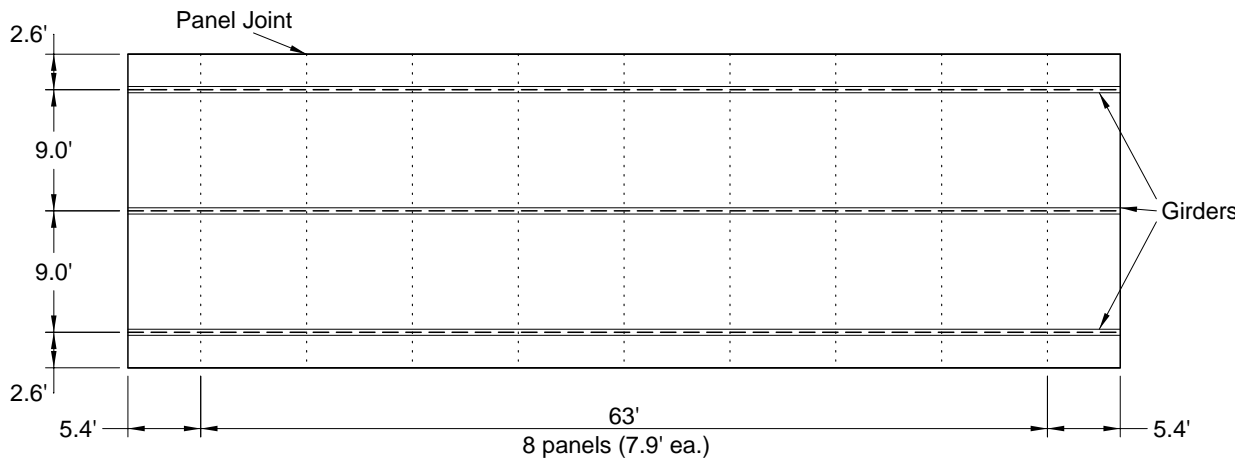

Figure 9. Shenley Bridge Plan View

Electrical resistance strain gauges were used during the testing. At the locations where the strain gauges were to be placed, the surfaces were ground down to remove scale and cleaned to provide a proper surface for mounting the gauges. Each of the gauges was mounted to the girder surface using a commercially available adhesive (Figure 13).

All of the data were collected using a portable data acquisition system (Figure 14). During testing the acquisition system was powered by battery to help minimize noise in the data.

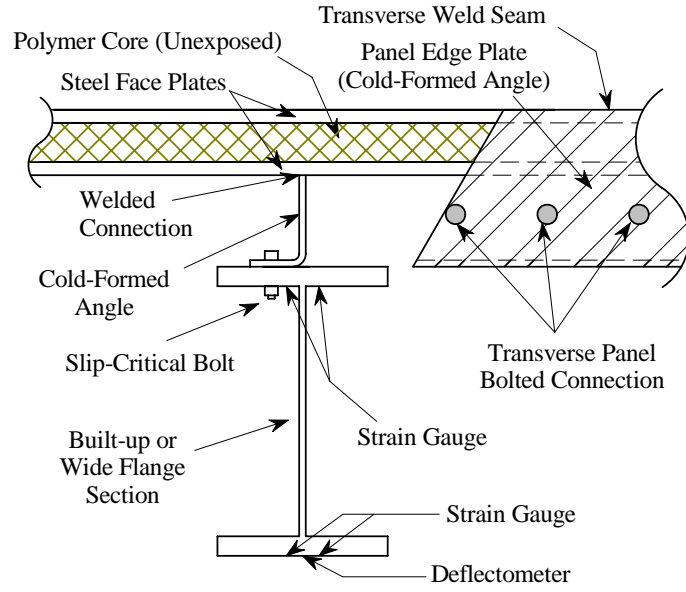

Figure 10. Representation of SPS Cross-Section with Instrumentation Layout (not to scale)

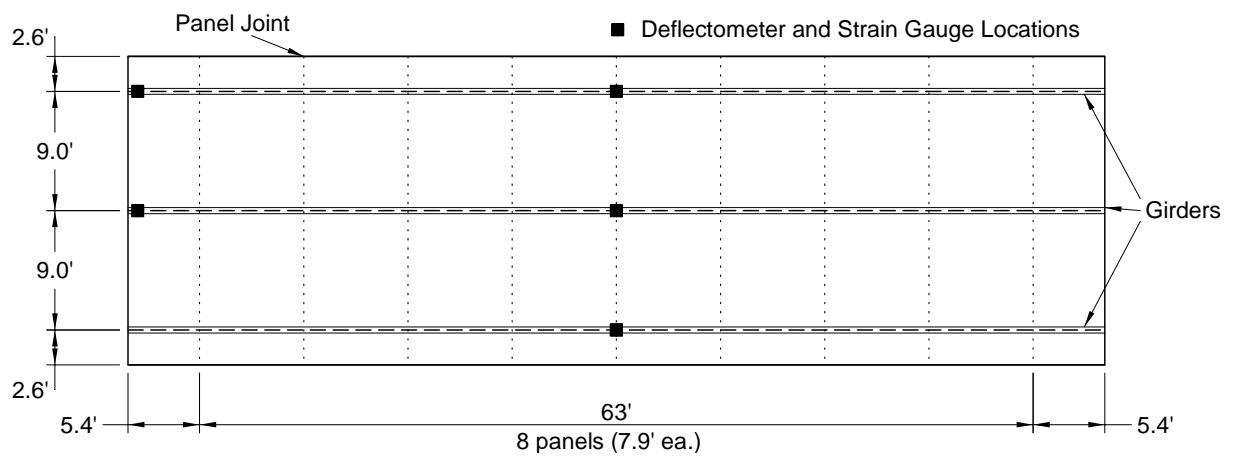

Figure 11. Elevation of Shenley Bridge with Instrumentation Locations

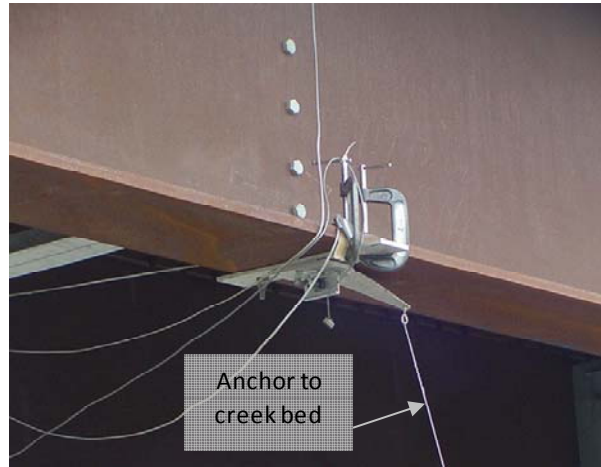

Figure 12. Deflectometer Mounted on Girder



Figure 13. Strain Gauge Mounted on Girder

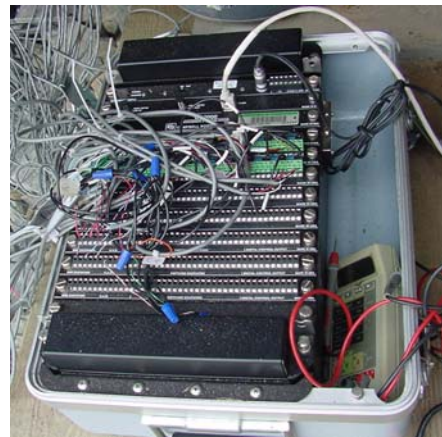

Figure 14. Data Acquisition System

Load Cases

The live load testing of the Shenley Bridge was performed using a three-axle dump truck (Figure 15) provided by the Ministry of Transportation of Quebec (MTQ). The testing included both quasi-static and dynamic testing of the bridge. A schematic of the loading scenarios is presented in Figure 16.

Four loading configurations were considered for the single truck configuration and two were considered for the paired truck configuration. These configurations were intended to produce the worst case loading scenarios for the interior and exterior girders. The two paired truck loading configurations were not actually performed, but employ superposition of the single truck configurations. This method was deemed acceptable in the absence of a second truck because the bridge remained in the elastic range throughout the testing. All of the quasi-static tests were performed at “crawl” speeds of 5 mph or less, to minimize dynamic amplification and allow the truck to follow lines marked on the bridge deck. Displacement and strain data were recorded at a rate of 20 Hz per channel to cover the entire spectrum of the truck crossings. For each load configuration a total of 5 repetitions for each crossing were performed.

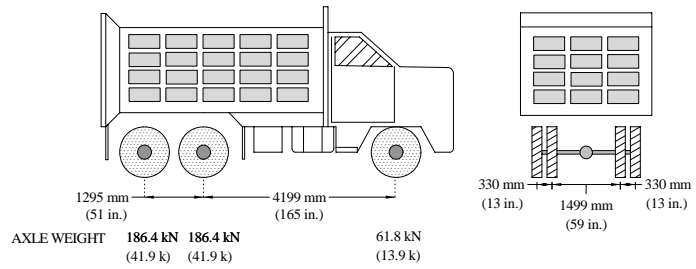
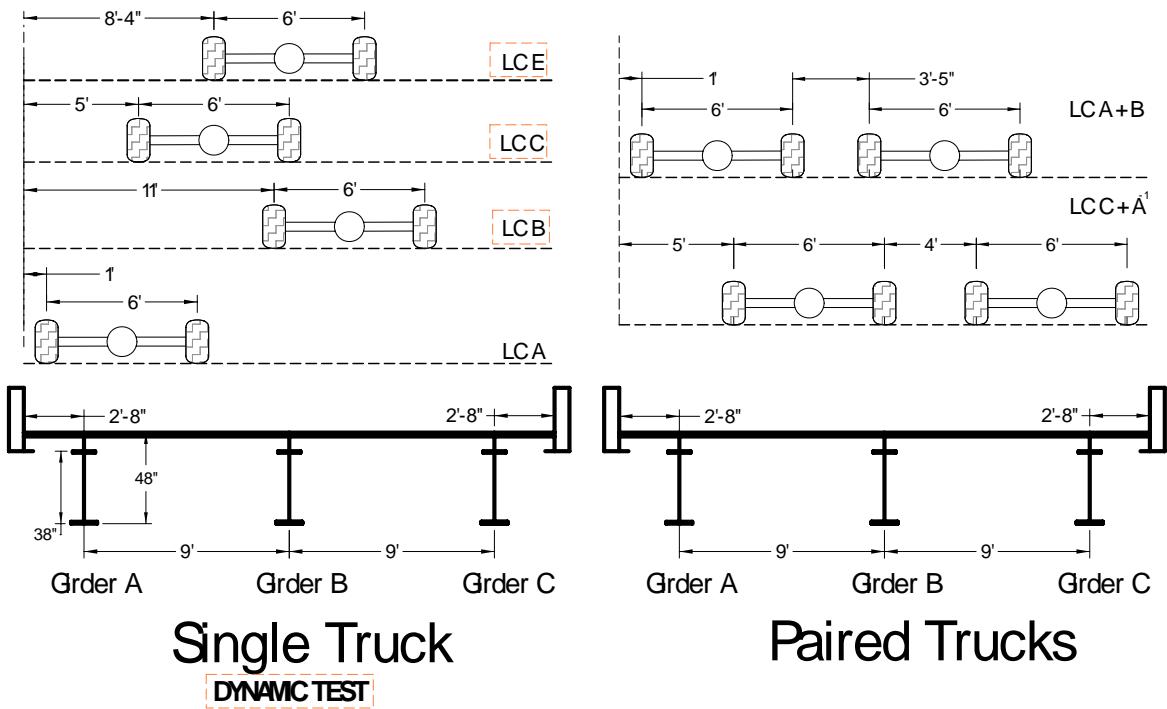

Figure 15. Three-Axle Dump Truck Used for Shenley Bridge Live Load Testing



Single Truck
Paired Trucks
DYNAMIC TEST

Figure 16. Loading Configurations for Shenley Bridge Live Load Tests

RESULTS AND DISCUSSION

Details of the results and discussions can be found in Harris (2007).

Transverse Load Distribution in SPS Bridges

The lateral load distribution behavior of a bridge is a critical component for an economical design. A 3D structure is reduced to a 2D structure as loads are assumed to be transmitted laterally from the bridge deck to the supporting members. The transmission of loads

is expected to be a function of the relative stiffness of the interacting deck and support members (Barker and Puckett 2007). While this methodology is a simplification from the true behavior, it has proven to be an effective method for the design of bridges.

Researchers have investigated lateral load distribution behavior using simplified methods, semi-analytical methods, rigorous analyses, and field testing with varying conclusions. Most researchers have concluded that the parameter with the greatest influence on lateral load distribution behavior is girder spacing, while other parameters such as span length, longitudinal girder stiffness, and deck thickness also contribute, but to a lesser extent. Other considerations such as secondary members have been shown to have an influence, but the degree of influence is much debated. This section presents the analysis of the lateral load distribution characteristics of SPS bridges through a series of live load tests.

Distribution Factor Method

To reduce the level of complexity bridges are often modeled as 2-D systems by using the beam-line method with distribution factors. The beam-line method is an approximate method of analysis that considers each beam separately subjected to a fraction of the original loading; separate consideration is often given to the response of moment and shear. Distribution factors are a representation of the amount of the total load that is transferred to a given girder from the deck. They can be determined from refined numerical or analytical analyses considering the relative stiffness of the bridge components or through simplified equations. The simplifying assumption that a bridge can be reduced to the analysis of a simple beam is a significant stretch from reality, but the use of this methodology has proven to be effective in the design of bridges for many years.

Lateral Load Distribution based on the AASHTO LRFD Specifications

The challenges observed with the simplified methodology in the AASHTO standard specification prompted a study from the National Cooperative Highway Research Program (NCHRP) to develop better methods for lateral load distribution. The research project consisted of three levels of analysis, with increasing accuracy and complexity between levels. The goal was to develop simple equations to predict lateral load distribution with improved accuracy over a wider range of applicability (Zokaie 1992). In the project, a parametric study of a large population of bridges in the United States was performed to determine the variables with the most influence on the lateral load distribution. The results indicated that the parameters with the most influence on lateral load distribution for slab-girder bridges are girder spacing, span length, longitudinal stiffness, and slab thickness. Girder spacing proved to be the most significant parameter. These key parameters were then incorporated in the development of simplified empirical equations for the prediction of lateral load distribution and were formulated statistically based on the relative contribution of the key parameters. The final results yielded different equations for shear, moment, interior girder, and exterior girders and also included corrections for skew. The recommendations from the study for lateral load distribution were incorporated in the AASHTO LRFD specification with slight adjustments. Representative equations for the lateral load distribution equations from the study and AASHTO LRFD are shown in Table 1 for a steel I-girder bridge supporting a concrete deck. It should be noted that

the equations already include multiple presence factors which account for the probability of trucks being present in adjacent lanes of multiple lane bridges.

As is evident in Table 1, the simplified formula for lateral load distribution has some limits. AASHTO states that these distribution factors are limited to bridges with fairly regular geometry, constant cross section consistent with those specified, four or more beams, parallel beams with approximately the same stiffness, roadway portion of cantilever overhang less than or equal to 3 ft., and a small plan curvature. Similar to the AASHTO Standard specification these equations are only considered valid for bridges within the ranges of applicability and a more refined analysis may be required for bridges outside these ranges. For bridges outside the range of applicability and exterior girders subjected to a single lane loading, the lever rule can be applied for determination of an upper bound on lateral load distribution. The lever rule is a simple static distribution method that assumes all interior supports are hinged, preventing the

Table 1. LRFD Lateral Load Distribution Factors for Concrete Deck on Steel Girders				
	Interior	Applicability	Exterior	Applicability
Moment	<i>One design lane loaded</i>			
	$g = 0.06 + \left(\frac{S}{14}\right)^{0.4} \left(\frac{S}{L}\right)^{0.3} \left(\frac{K_g}{12Lt_s^3}\right)^{0.1}$	$3.5 \leq S \leq 16.0$ $4.5 \leq t_s \leq 12.0$ $20 \leq L \leq 240$ $N_b \geq 4$ $10,000 \leq K_g \leq 7 \times 10^6$	Lever rule*	*does not include multiple presence factor
	<i>Two or more design lanes loaded</i>			
	$g = 0.075 + \left(\frac{S}{9.5}\right)^{0.6} \left(\frac{S}{L}\right)^{0.2} \left(\frac{K_g}{12Lt_s^3}\right)^{0.1}$	$3.5 \leq S \leq 16.0$ $4.5 \leq t_s \leq 12.0$ $20 \leq L \leq 240$ $N_b \geq 4$ $10,000 \leq K_g \leq 7 \times 10^6$	$g = e \cdot g_{interior}$ $e = 0.77 + \frac{d_e}{9.9}$	$-1.0 \leq d_e \leq 5.5$
Shear	<i>One design lane loaded</i>			
	$g = 0.36 + \frac{S}{25}$	$3.5 \leq S \leq 16.0$ $4.5 \leq t_s \leq 12.0$ $20 \leq L \leq 240$ $N_b \geq 4$	Lever rule*	*does not include multiple presence factor
	<i>Two or more design lanes loaded</i>			
	$g = 0.2 + \frac{S}{12} - \left(\frac{S}{35}\right)^{2.0}$	$3.5 \leq S \leq 16.0$ $4.5 \leq t_s \leq 12.0$ $20 \leq L \leq 240$ $N_b \geq 4$	$g = e \cdot g_{interior}$ $e = 0.6 + \frac{d_e}{10}$	$-1.0 \leq d_e \leq 5.5$

load from being transferred across an interior support (Figure 17). The solution yields reactions for the supporting beams which represent the fraction of the total load that goes into that support member. This methodology would be equivalent to a very flexible deck with a low degree of rotational restraint, none provided across interior members. It should also be noted that an additional provision exists for the exterior girder in a bridge with diaphragms or cross-bracing because their contribution was neglected in the development of the distribution factor equations (AASHTO 2004). The provision states that the distribution factor for moment and shear in an exterior girder shall not be less than that from assuming the cross-section deflects and rotates as a rigid cross-section.

When considering the key design aspects of slab-girder bridges, lateral load distribution is the means by which loads are transmitted to the girders. The majority of the provisions within AASHTO LRFD (AASHTO 2004) are tailored to the design of bridges with conventional materials such as reinforced concrete, prestressed concrete, steel and timber with none specifically devoted or inclusive of new materials such as SPS. This lack of inclusion is primarily the result of the limited usage of these types of materials and the relatively recent recognition of these materials as viable alternatives to the conventional materials.

While the current provisions within the AASHTO LRFD are not inclusive of these new materials, the primary concern that arises when considering these new deck systems is the apparent reduction in stiffness when compared to typical concrete decks. Typical concrete bridge deck designs are not often controlled by stiffness requirements as most designs typically adhere to minimum thickness requirements or are designed to satisfy strength requirements. These concrete deck thicknesses typically range from 6 to 8 in depending on the design methodology employed and regional practices. The main difference with SPS decks is that their designs are intended to minimize weight which is accomplished by making the deck as thin as practical. Based on the results from the deck design methodology, stiffness tends to control the

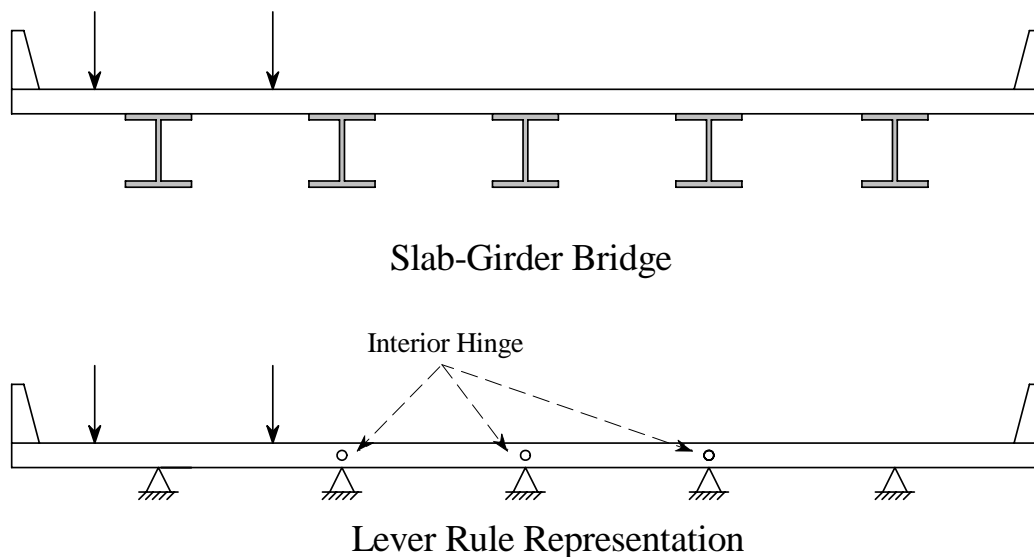

Figure 17. Lever Rule Representation of Slab-Girder Bridge

design of SPS bridge decks. This design approach results in decks that are adequate for strength, but considerably more flexible than their concrete counterpart. A comparison is presented in Table 2, demonstrating the relative difference in stiffness between a concrete deck and variations in SPS deck configurations, all comparisons are made to an 8-in-thick concrete section with an assumed compressive strength of 4 ksi, a typical design configuration for a slab-girder bridge in Virginia.

Results from the NCHRP 12-26 project (Zokaie 1992; Zokaie 2000) suggested that slab thickness influenced lateral load distribution, but to a lesser extent than some of the other parameters. It was demonstrated that an increase in slab thickness resulted in a decrease in lateral load distribution, but the analysis only considered reinforced concrete deck ranging in thickness from 6-9 in. As demonstrated in Table 2, the stiffness for an equivalent SPS deck would be significantly lower than concrete decks in this range of thicknesses. Based on the results of the NCHRP 12-26 project and this difference in stiffness, it would be expected that SPS bridge decks would exhibit different lateral load distribution characteristics than reinforced concrete decks. For these reasons the lateral load distribution behavior of SPS bridges warranted further investigation.

Table 2. SPS Deck Stiffness Relative to an 8-Inch Reinforced Concrete Deck Stiffness

SPS Plate Thickness (in)	SPS Core Thickness (in)	$E_{SPS}I$ (kip-in ²)*	$E_{R/C}I$ (kip-in ²)	Stiffness Ratio ($E_{SPS}/E_{R/C}$)
0.1875	1.85	137,000	1,846,000	7%
0.25	1.51	136,000	1,846,000	7%
0.375	1.05	136,000	1,846,000	7%
0.1875	2.39	219,000	1,846,000	12%
0.25	1.98	218,000	1,846,000	12%
0.375	1.44	218,000	1,846,000	12%
0.1875	2.84	302,000	1,846,000	16%
0.25	2.37	301,000	1,846,000	16%
0.375	1.76	301,000	1,846,000	16%
0.1875	3.22	384,000	1,846,000	21%
0.25	2.71	384,000	1,846,000	21%
0.375	2.04	384,000	1,846,000	21%
0.1875	3.57	466,000	1,846,000	25%
0.25	3.01	466,000	1,846,000	25%
0.375	2.28	464,000	1,846,000	25%

Lateral Load Distribution Factors

For a multiple girder bridge system, lateral load distribution represents the fraction of a force effect such as moment or shear that is resisted by a given girder. Researchers have utilized various techniques for the determination of lateral load distribution from field measurements, but the most widely accepted methods consider displacement and/or strain response in the determination. Displacements and strains are known to be directly related to the desired force

effect by derivatives of the equation of the elastic curve for a beam. The displacements and strains recorded during testing were primarily located at midspan and as a result would be related to the lateral load distribution for moment rather than shear. Determination of shear distribution factors would require measurement of the maximum shear strain response or end reactions, but that was beyond the scope of the field test objectives.

The method used in this research to calculate lateral load distribution or distribution factors (DF) is a ratio of the maximum displacement/strain response in a girder to the summation of the displacement/strain response in all girders (Eq. 1). This ratio is then multiplied by the number of trucks (N) used during testing to make the distribution factor on a per truck basis. This definition for distribution factor has been widely used by researchers conducting live-load tests (Stallings and Yoo 1993; Waldron et al. 2005).

$$DF_i = \frac{\Delta_{\max i}}{\sum_{i=1} \Delta_{\max i}} \cdot N_{trucks} = \frac{\epsilon_{\max i}}{\sum_{i=1} \epsilon_{\max i}} \cdot N_{trucks} \quad \text{Eq. 1}$$

Table 3 presents a summary of the calculated distribution factors for displacements and strains for each girder and all of the single truck loading configurations. The values presented represent the average for all of the repetitions in a given load case which results in a better representation of behavior than a single data point. Each of the truck crossings was evaluated to determine if data were recorded and if there were significant variations from the other crossings in the same loading configuration. Data that included these variations were either manually repaired or eliminated from consideration if the variations were substantial. The distribution factors are representative of the amount of loading that is transferred to a given girder from the deck; higher distribution factors indicating a more heavily loaded girder. With the truck factor (N) included the distribution factors represent the fraction of a single truck load resisted by a girder for a load configuration, the same basis as the distribution factors from the AASHTO LRFD specification.

Similarly, Table 4 presents the calculated distribution factors for the paired truck loading configurations. It is easily observed that the results for the paired truck configuration are larger than the single truck; this is expected because the presence of two trucks increases the load on the entire structure and in turn requires each of the girders to resist a higher percentage of a single truck weight.

Table 3. Summary of Lateral Load Distribution Factors for Single Truck Loading

Load Case	Girder A (exterior)		Girder B (interior)		Girder C (exterior)	
	Δ	ϵ	Δ	ϵ	Δ	ϵ
A	0.654	0.676	0.321	0.279	0.024	0.045
B	0.146	0.166	0.372	0.412	0.482	0.422
C	0.479	0.497	0.359	0.386	0.162	0.117
E	0.328	0.327	0.380	0.427	0.291	0.246

Table 4. Summary of Lateral Load Distribution Factors for Paired Truck Loading

Load Case	Girder A (exterior)		Girder B (interior)		Girder C (exterior)	
	Δ	ϵ	Δ	ϵ	Δ	ϵ
A + B	0.849	0.894	0.689	0.676	0.462	0.430
C + A ⁻¹	0.496	0.520	0.679	0.660	0.824	0.820

The live load testing yielded displacement and strain results for all three girders in the Shenley Bridge; these results are essential in determining the relative response of each girder, but not in the determination of the distribution that would be used in design. Design practice would utilize the worst case distribution factor based on girder location, with the possibility of different distribution factors for interior and exterior girders.

A comparison of the critical distribution factors to code provisions for interior and exterior girders as well as single and paired loadings is presented in Table 5. The code predictions presented are considering the deck to be concrete because no provisions exist for SPS decks within any of the specifications. A concrete deck is the most common system used in the United States and serves as a good baseline for comparison. The lever rule is also presented because code provisions allow it as an alternative method for bridges outside the range of applicability stipulated. It also serves as an upper bound since no lateral load distribution is permitted across interior girders which are assumed to be hinged. For completeness the distribution assuming an infinitely stiff deck is presented to highlight the lower bound. The distribution factors presented from the measured results represent the fraction of a single truck resisted by a girder. This allows for direct comparison between the code predictions and also between the single and two truck loading configurations.

The distribution factors from the field tests are all within the limits of the AASHTO LRFD code provisions. In all cases considered, the distribution factors approach that of the lever rule predictions more so than that of the equal distribution. This would indicate that the deck is fairly flexible, but not so much that no load is transferred across in interior girder.

While all of the trends tend to indicate that current provisions for lateral load distribution can be applied to SPS bridges, it should be noted that the live load test is only a single data point. Also of note is that the Shenley Bridge uses a three girder system with relatively high girder

Table 5. Critical Distribution Factors for Shenley Bridge vs. Code Provisions

	Girder	Load Case	Test Results		Predictions		
			Δ	ϵ	LRFD Spec	Lever Rule	Equal Dist.
One Truck	Ext.	A	0.654	0.676	0.849	0.849	0.333
	Int.	E	0.380	0.427	0.533	0.668	0.333
Two Trucks	Ext.	A+B	0.849	0.894	0.955	0.885	0.666
	Int.	A+B	0.689	0.676	0.901	0.819	0.666

spacing, both of which are not common in the state of Virginia and many other states. For these reasons it would be inappropriate to definitively state that current AASHTO provisions for a concrete deck on steel girders can be directly applied to SPS. Further study of lateral load distribution through field testing and finite element modeling is expected to yield more data to make this judgment.

Dynamic Load Allowance

The response of a bridge structure subjected to live load is primarily a function of the interaction of the deck and supporting girders with some influence from secondary members. When the live load is in motion, the response is significantly increased above that of the same static load. This increased response is referred to as dynamic amplification and is the result of a number of factors including the dynamic characteristics of the bridge, the roadway roughness, and the dynamic characteristics of the load or truck (Barker and Puckett 1997). These factors are a general categorization of the critical parameters of influence; research has shown the list of parameters to be much more extensive. A summary of these findings is presented here.

Design code provisions in the United States and Canada have adopted a simple approach to estimating dynamic amplification effects. These methods allow designers to quickly determine dynamic amplification without detailed knowledge of the bridge configuration. The simple methods do not account for the parameters that significantly influence dynamic amplification; these methods can also be overly conservative in some cases. The simplified methods for the AASHTO Standard specification, the AASHTO LRFD, and the CHBDC are summarized in Table 6. A predecessor of the CHBDC (CSA 1988) utilized an approach based on the fundamental frequency of the bridge as shown in Figure 18. The methods presented are on a percent basis and represent the additional load, above the static response, due to the dynamic amplification response as shown in Eq.2, where U_{L+I} represents the live load effect including dynamic amplification (i.e. shear or moment), U_L is the live load effect, and IM is the dynamic amplification represented as a fraction.

$$U_{L+I} = U_L(1 + IM) \quad \text{Eq. 2}$$

Table 6. Summary of Dynamic Load Allowance Specifications

Specification	Component	<i>IM</i>
AASHTO Standard	All components – all limit states	$\frac{50}{L+125} \cdot (100\%) \leq 30\%$
AASHTO LRFD	Deck joints – all limit states	75%
	All other components	
	Fatigue and fracture limit states	15%
	All other limit states	33%
CHBDC	Deck joint	50%
	Where only one axle of CL-W truck is used (except deck joints)	40%
	Where any two axles of CL-W truck, or axles 1,2, and 3, are used	30%
	Where three axles of CL-W truck, or axles 1,2, and 3, or more than three axles are used	25%

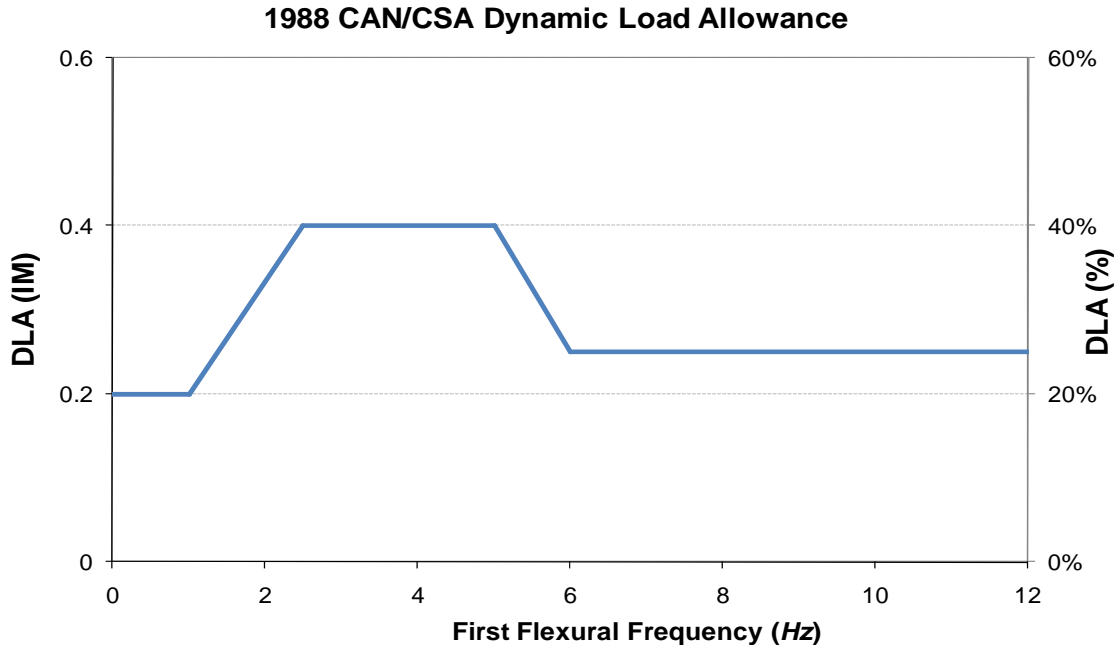

Figure 18. 1988 CAN/CSA DLA vs. Frequency

Dynamic Response of SPS Bridge

The dynamic response of bridge structures has been studied by many researchers, but none have developed methods for characterizing the response for bridge-vehicle interaction. The concern for SPS bridges is the dynamic response could be greater than a conventional system because of the system's lightweight.

Field Test of the Shenley Bridge

A description of the Shenley Bridge was presented previously. For this reason only a brief extension of the testing program will be highlighted as it pertains to the dynamic testing. The objective of the dynamic tests was to evaluate the dynamic response of the bridge subjected to moving loads. These tests were intended to demonstrate the dynamic amplification observed over that of static conditions.

The dynamic testing considered a single truck positioned in three configurations (Lanes B, C, and E)), one configuration was not considered for safety reasons due to the proximity to the guardrail (Lane A). A presentation of the load cases shown is illustrated in Figure 16. The dynamic tests were performed at speeds of about 50 mph to mimic the behavior of a truck traveling at the highest speed attainable in the approach roadway section. Displacement and strain data were recorded at a rate of 200 Hz per channel to cover the entire spectrum of the truck crossings. Similar to the quasi-static tests, a total of 5 repetitions for each crossing were performed.

Measured Results

The dynamic testing yielded a large volume of data similar to the quasi-static testing, which required interpretation and analysis. Each of the truck crossings was evaluated to determine if data were recorded and if there were significant variations from the other crossings in the same loading configuration. Similar to the quasi-static tests, data that included these variations were either manually repaired or eliminated from consideration if the variations were substantial. A typical displacement response from the dynamic testing is illustrated in Figure 19. The response for strain was similar, but exhibited significant noise in many cases and for that reason is not shown.

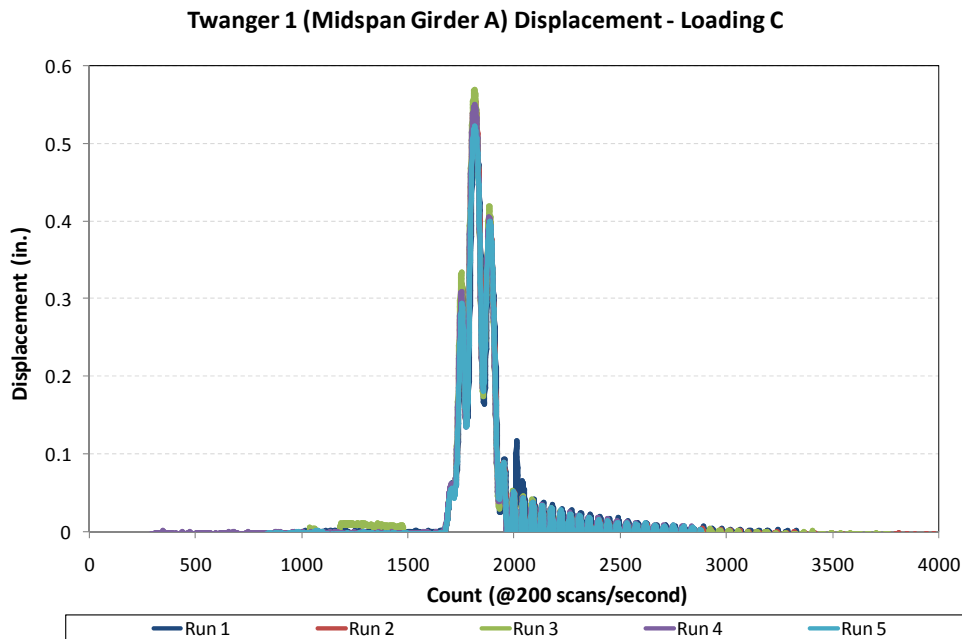

Figure 19. Typical Displacement Response for Dynamic Field Test of Shenley Bridge

Dynamic Load Allowance

From the live load test of the Shenley Bridge, the dynamic effects considered were the additional deflection or strain beyond the static response under the same loading. In Figure 20 recorded data from the Shenley Bridge live load tests show a static crossing and dynamic crossing super-imposed. The time scales for the two plots are different which allows for the superposition. The dynamic amplification can be clearly seen by comparing the peak displacements (0.32 in versus 0.48 in). In the determination of dynamic amplification or dynamic load allowance (*DLA*), displacement and strain data for the dynamic tests were compared with the data for the static test under the same load configuration. *DLA* is considered

Static vs. Dynamic Displacement Response - Interior Girder - LC E (Test 1)

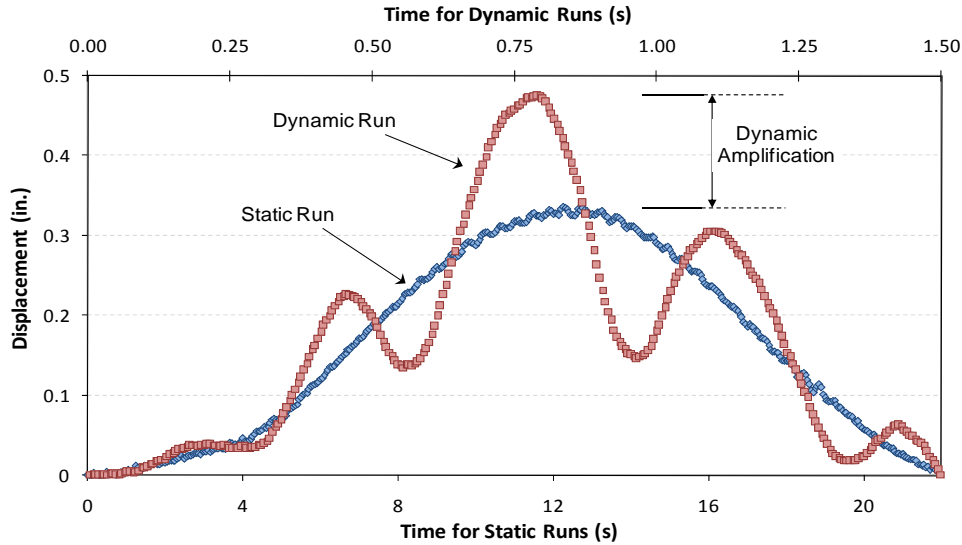

Figure 20. Comparison of Static to Dynamic Displacement Response

in this research to be the additional effect observed under dynamic loading conditions when compared to an equivalent static response and is determined as defined by Eq. 3.

$$DLA = \frac{R_{dynamic} - R_{static}}{R_{static}} = \frac{\Delta_{dynamic} - \Delta_{static}}{\Delta_{static}} = \frac{\epsilon_{dynamic} - \epsilon_{static}}{\epsilon_{static}} \quad \text{Eq. 3}$$

$R_{dynamic}$ and R_{static} are generic measured response functions from dynamic and static load tests. $\Delta_{dynamic}$ and Δ_{static} are the measured displacements and $\epsilon_{dynamic}$ and ϵ_{static} are the measured strains resulting from the dynamic and live load tests, respectively.

Comparisons of the dynamic load allowance results for the Shenley Bridge live load test are presented in Table 7 along with the AASHTO specified values. Similar to the method for lateral load distribution, a total of 5 repetitions for each crossing were performed. The dynamic load allowance values for the cases presented include a maximum and average value for both strain and deflection; the maximum DLA values utilize the minimum static response from all five repetitions and the average DLA values use the average of the static response for all of the static repetitions.

Each of the code predictions utilizes a blanket approach to determine the dynamic amplification and gives no consideration to the type of bridge. The AASHTO standard specification does take into consideration the bridge length which has been shown to be related to fundamental frequency, but still maintains an upper limit of 25% amplification. Two out of the three load cases considered result in conservative predictions when compared with the field measurements. For Load Case E all of the codes underestimate the amplification effects.

Table 7. Summary of Dynamic Load Allowance for Shenley Bridge

	Load Case B (Girder C)				Load Case C (Girder A)				Load Case E (Girder B)			
	Max		Avg		Max		Avg		Max		Avg	
	Δ	ϵ	Δ	ϵ	Δ	ϵ	Δ	ϵ	Δ	ϵ	Δ	ϵ
Avg (%)	12	6	10	6	26	24	25	22	44	34	42	32
Standard Deviation	3.7	3.5	3.7	3.5	5.3	8.4	5.2	8.2	19.7	18.6	19.4	18.4
LRFD	33											
Std. Spec	25											

The underestimation of the code predictions for Load Case E is more pronounced with the deflection than with the strain response. This trend is opposite of what was observed in the determination of distribution factors where the strain response was consistently higher. All five of the static tests for Load Case E resulted in similar deflection and strain values, but the dynamic tests displayed some inconsistencies between runs as shown in Table 8. The deflection and strain values for Runs 1, 3, and 5 are significantly larger than those for Runs 2 and 4, resulting in relatively large dynamic load allowance values for the odd cases. This difference in dynamic response is the primary cause of the large standard deviation for the dynamic load allowance for Load Case E, but the large values cannot be easily explained from the test data. The source of the relatively large dynamic load allowance values for runs 1, 3, and 5 are rather difficult to explain as a result of the numerous parameters of influence, but one likely source is inconsistencies in load positioning during testing. Another potential source of the additional amplification is due to bounce of the truck caused by expansion joints and the approaches. Other parameters often associated with dynamic amplification include roadway roughness and vehicle suspension response, but these were not quantified in the field testing and as a result cannot be evaluated. These discrepancies suggest that further investigation of dynamic load allowance is warranted.

Table 8. Summary of Variation in Dynamic Response for Load Case E

	$\Delta_{dynamic}$ (in)	DLA Max (%)	DLA Avg (%)	$\epsilon_{dynamic}$ ($\mu\epsilon$)	DLA Max (%)	DLA Avg (%)
Run 1	0.488	60%	58%	198	50%	48%
Run 2	0.377	24%	22%	151	15%	14%
Run 3	0.465	52%	50%	174	36%	35%
Run 4	0.374	23%	21%	150	14%	13%
Run 5	0.496	63%	61%	200	53%	51%
Average - All Runs	0.440	44%	42%	133.7	34%	32%
Average – Runs 1,3,5	0.483	58%	56%	148	47%	45%
Average – Runs 2,4	0.376	23%	22%	112	15%	13%

Vibration Characteristics of Shenley Bridge

The primary source of the dynamic amplification is often difficult to quantify mainly because of the large number of parameters involved. One parameter most often associated with

dynamic amplification is the fundamental frequency of the bridge (Paultre et al. 1992). Two separate vibration tests of the Shenley Bridge were performed. The first test was performed as part of the validation testing program prior to application of the wearing surface (IE 2004), whereas the second was performed concurrently with the live load testing program after 19 months in service (Murray 2005). The fundamental frequencies for the first and second test were 5.8 (November 2003) and 4.5 Hz (June 2005), respectively. These frequencies are well within the expected range of typical short-medium span highway bridges of this span length (Paultre et al. 1992). A comparison of the measured frequency is also within reasonable agreement with the simplified models as proposed by other researchers based on span length (Table 9) (Cantieni 1984; Chan and O'Connor 1990; Tilly 1986). The comparisons suggest that the dynamic behavior of SPS bridges may not be significantly different than that of typical slab girder bridges, but the limited comparative population does not allow for a definitive conclusion.

Table 9. Comparison of Frequency Predictions for Shenley Bridge

	Prediction Equation	Predicted Frequency (f)	Prediction/Measured (November 2003)	Prediction/Measured (June 2005)
Cantieni	$f = 95.4L^{-0.933}$	5.22	0.90	1.16
Tilly	$f = 82L^{-0.9}$	4.98	0.86	1.11
Chan and O'Connor	$f = 100/L$	4.44	0.77	0.99

Note: L in meters

Summary of the Dynamic Characteristics of SPS Bridges

This section presents the results of dynamic portion of the live load testing of the Shenley Bridge which included the determination of the dynamic load allowance. For one of the load cases the DLA was greater than the AASHTO code predictions, suggesting that the lightweight deck might have some influence on the dynamic characteristic of these types of bridges.

The results presented in this section can be considered a limited investigation of the dynamic characteristics of SPS because the investigations primarily focused on bridge behavior without significant consideration of the bridge-vehicle interaction. While the scope of the investigation is somewhat limited, the results of this investigation suggest that the dynamic behavior of SPS does not significantly vary from that of bridges constructed with more conventional materials. This is likely the result of the mass and stiffness of the girders controlling the dynamic response more so than the deck. These findings would suggest that the current provisions for dynamic load allowance within AASHTO LRFD can be applied to SPS bridges. A further investigation of the bridge-vehicle interaction response would provide additional insight into this finding, but is beyond the scope of this research.

SPS Deck Design Method

For the majority of bridges in North America, concrete is the material of choice for bridge decks. The use of concrete is primarily a function of cost considerations, ease of

construction, material availability and previous experience. Other deck systems include wood plank, orthotropic steel systems, and open/filled steel grid systems, but these systems are typically utilized for specific applications. In recent years there has also been a strong interest in the use of structural composite deck systems such as modular fiber-reinforced polymer (FRP) decks, but the majority of these decks have been utilized as one-time applications, typically as part of a validation program. The limited application of FRP bridge decks appears to be primarily a function of high initial material cost, limited design experience base and a lack of design provisions.

With the exception of composite decks, current provisions exist for all of the deck systems previously highlighted. While all of these systems represent viable alternatives to concrete, their use is typically application specific. Numerous commonalities exist between an SPS deck and these alternative deck systems, but the behavior of SPS cannot be directly accommodated by any of the current provisions. When comparing an SPS deck to these conventional systems, the form can be most closely compared to an orthotropic steel deck. An SPS bridge deck can be considered analogous to an orthotropic deck in that it utilizes metal face plates, but differs dramatically in that the main structural resistance of an SPS deck is derived from the face plates and core, whereas the orthotropic deck derives its resistance from the deck plate and discretely spaced stiffening elements acting together as a unit. The continuity of the core allows the SPS deck to maintain isotropic material properties. When compared to FRP deck systems, the polymer core material of SPS provides the common characteristics between the two. While there are some underlying similarities between these deck systems, the primary distinction lies in the isotropy of the SPS deck because most composite deck systems exhibit orthogonal mechanical properties.

AASHTO design provisions focus primarily on the design of concrete deck systems, but do provide recommendations for the design of steel and aluminum orthotropic decks. These orthotropic deck systems are likely the most similar to SPS because the deck is comprised of metal plates, but at the same time these systems are dramatically different in that the support for the metal plates in an orthotropic system is provided by a grid of structural members whereas the plates in SPS are supported by the polymer core (Figure 21).

AASHTO Deck Design Considerations

As a result of the multitude of bridge types, there is no single design method available for the design of bridge decks. The AASHTO design specifications (AASHTO 2004) allow for any method of analysis that satisfies the requirements of equilibrium and compatibility and also utilizes the stress-strain relationships for the material under investigation. AASHTO design specifications provide methods and guidelines for the design of typical deck types including reinforced concrete, wood, steel grid, steel orthotropic and aluminum orthotropic. This section presents a brief summary of the design methodologies recommended for the design of bridge deck systems.

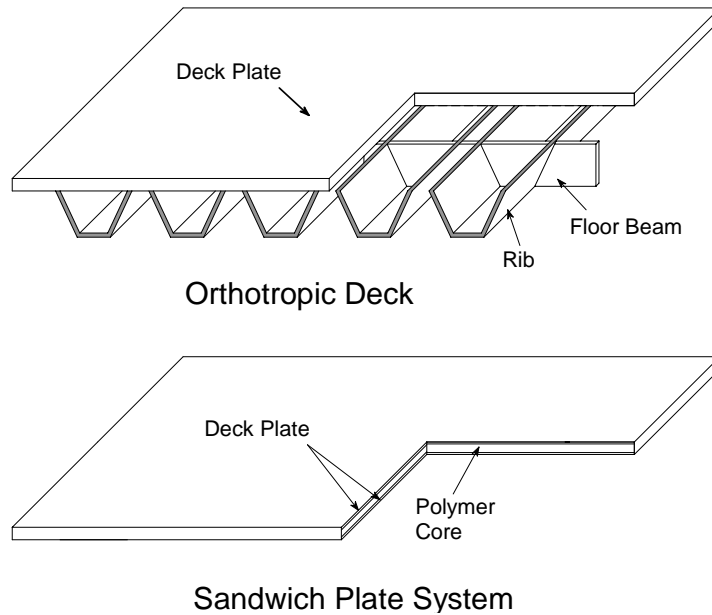

Figure 21. Comparison of Orthotropic and SPS Configurations

Decks in Slab-Girder Bridges

With slab-girder bridges representing the vast majority of bridges in the United States, the AASHTO design provisions provide more guidance for the design of this type of deck than for less common systems. The types of decks that fall into this category include cast-in-place reinforced concrete, precast/post-tensioned concrete, steel open grid, prefabricated glulam wood, stress laminated wood, and spike laminated wood decks. Design of these types of deck systems is typically accomplished utilizing one of three available methods including the linear elastic (equivalent strip) method, yield-line method, or the empirical method (Barker and Puckett 2007). Each of these methods is considered applicable to decks in slab-girder bridges, but the resulting deck designs vary significantly between the methods. The most commonly used of the three is the equivalent strip method and it is described in more detail here.

The equivalent strip method reduces the deck design down to that of a one-way slab section supported on rigid supports (Figure 22). The equivalent strip methodology allows for direct analysis of the local effect within the deck by eliminating the global effects resulting from the stringer deflection. This local effect within the deck can be attributed primarily to bending in the span direction as a result of wheel loads on the deck between supports (Barker and Puckett 2007).

Strip widths (Table 10) are typically a function of girder spacing or deck span and are intended to include the effects of flexure in the secondary direction and torsion (AASHTO 2004). The force effects are determined from the controlling load case by treating the slab section as a continuous beam over rigid supports. A design load per unit width is determined by distributing the determined force effect over the strip width, allowing for the section to be designed using conventional methods.

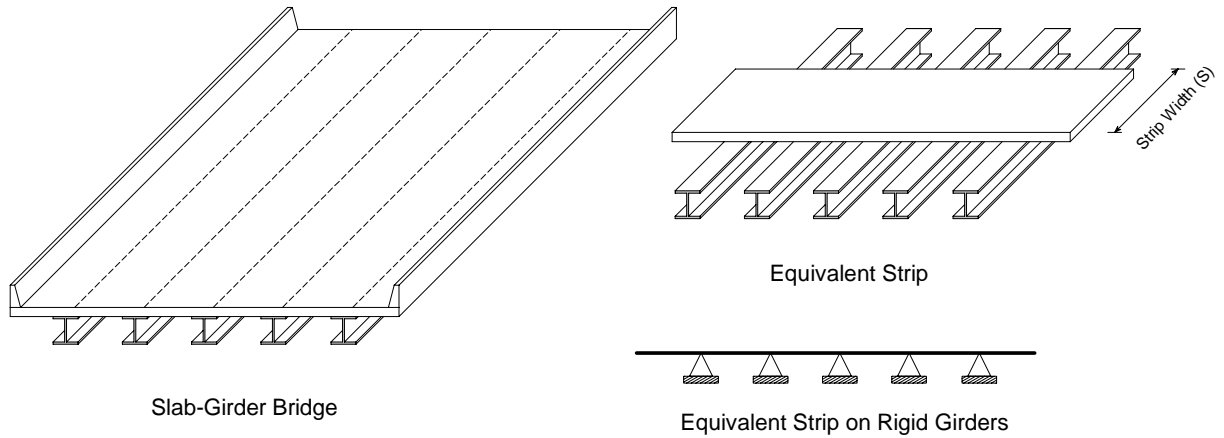

Figure 22. Equivalent Strip Representations

Table 10. Summary of Equivalent Strip Widths

Deck Type	Direction of Primary Strip Relative to Traffic	Width of Primary Strip (in)	
Cast-in-place concrete	Overhang	$45.0 + 10.0 \cdot X$	
	Either Parallel or Perpendicular	$M^+ : 26.0 + 6.6 \cdot S$ $M^- : 48.0 + 3.0 \cdot S$	
Cast-in-place with stay-in-place concrete formwork	Either Parallel or Perpendicular	$M^+ : 26.0 + 6.6 \cdot S$ $M^- : 48.0 + 3.0 \cdot S$	
Precast, post-tensioned concrete	Either Parallel or Perpendicular	$M^+ : 26.0 + 6.6 \cdot S$ $M^- : 48.0 + 3.0 \cdot S$	
Open grid steel	Main Bars	$1.25 \cdot P + 4.0 \cdot S_b$	
Prefabricated glulam	• Noninterconnected	Parallel	$2.0 \cdot h + 30.0$
		Perpendicular	$2.0 \cdot h + 40.0$
	• Interconnected	Parallel	$90.0 + 0.84 \cdot L$
		Perpendicular	$4.0 \cdot h + 30.0$
Stress-laminated	Parallel	$0.8 \cdot S + 108.0$	
	Perpendicular	$10.0 \cdot S + 24.0$	
Spike-laminated	• Continuous decks or interconnected panels	Parallel	$2.0 \cdot h + 30.0$
		Perpendicular	$4.0 \cdot h + 40.0$
	• Noninterconnected panels	Parallel	$2.0 \cdot h + 30.0$
		Perpendicular	$2.0 \cdot h + 40.0$

Proposed Design Method for SPS Decks

The current SPS bridges has relied heavily on finite element models for the deck design, however, the development of a practical design methodology is essential for more widespread acceptance of the technology. In developing the proposed design method all applicable AASHTO LRFD design limit states were considered (Strength I, Service II, and Fatigue). Based on these plate analyses (Harris 2007) it became evident that the controlling limit state for design was Service II with the deflection limit of $L/800$ imposed. Following is a proposed design method based on assuming deflection limits control for SPS bridge decks. This approach was first validated by comparison to experimental data from both field and laboratory testing and then extended to consider the design limit states within the AASHTO LRFD including serviceability, strength, and fatigue.

There are upper and lower bounds for the boundary conditions used for this method. The connection at the SPS deck girder interface can be assumed to be pinned or fixed. The results for the simple (pinned) support will be shown here because this results in the most conservative design. Sizing of the plate cross-section to satisfy the deflection control serviceability limit assuming simple supports will result in thicker face plates for a given total thickness compared to the fixed edge condition. These thicker faceplates will also reduce peak stresses within the deck regardless of the true boundary conditions. For all designs the deck plate thickness should not be less than $3/16$ in to ensure that fatigue of the base material does not occur during the life of the structure. A brief summary of the design procedure is outlined in the following steps.

1. Select girder spacing (as in typical design).
2. Determine the required flexural rigidity assuming simple support conditions.
3. Select plate and core thicknesses to achieve the required flexural rigidity (Note: ensure that plate thickness is not less than $3/16$ in.).

The sizing of the deck components is fairly straightforward, but for a given faceplate thickness requires the solution of a cubic polynomial. This analysis is simplified by solving the equation numerically or graphically in any available numerical software or calculator. To aid in the sizing of the deck a spreadsheet software program was developed that allows for the user to determine the required core material thickness by providing material properties, required flexural rigidity, and the desired face plate thickness. A design graph is presented in Figure 23. The design graph allows the user to select the girder spacing and face plate thickness and then calculates the required core thickness to satisfy the stiffness requirement.

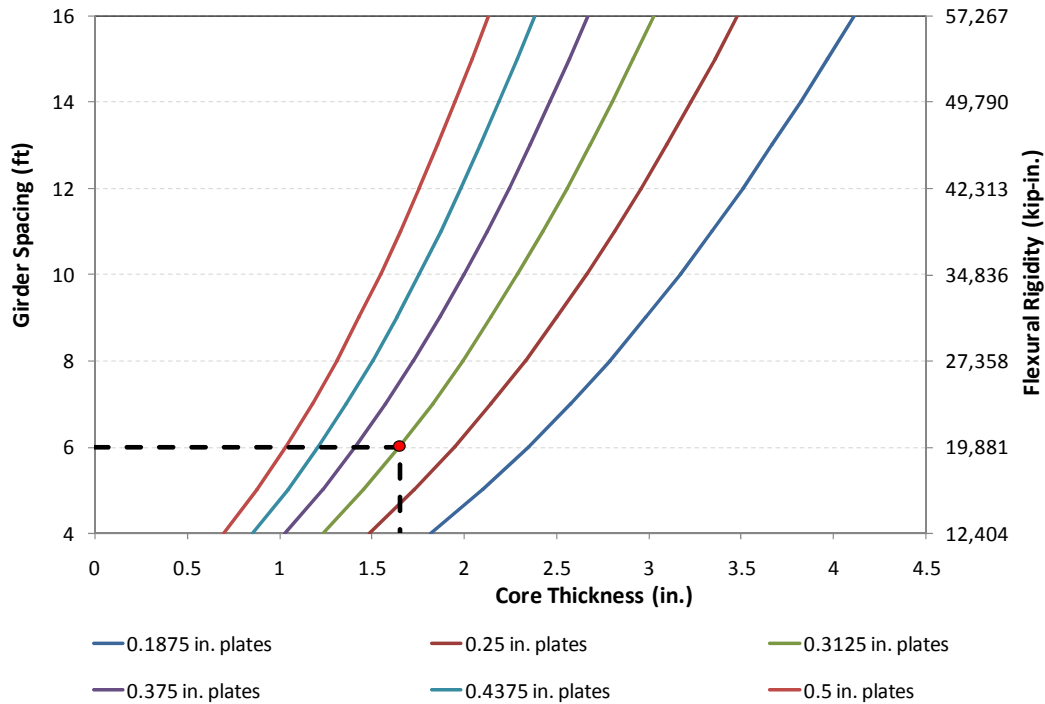

Figure 23. Required Core Thickness vs. Girder Spacing and Flexural Rigidity

CONCLUSIONS

Lateral Load Distribution Behavior of SPS

- The lateral load distribution characteristics of SPS bridges are not significantly different from that of reinforced concrete deck bridges:
 - The distribution factors for an equivalent concrete deck were lower than those of SPS bridges, but not to a significant degree.
 - The difference between a concrete deck bridge and SPS bridges is the deck stiffness which was shown to be of minimal significance on the lateral load distribution.
- The lateral load distribution behavior of SPS can be accounted for by using the current AASHTO LRFD provisions for concrete decks supported by steel girders.

Dynamic Load Allowance of SPS

- The field testing of the Shenley Bridge demonstrated that the measured dynamic load allowance values were reasonably accommodated by the AASHTO LRFD provisions, with the exception of one load case. The exact cause of the divergence for this one load case could

not be determined, but it is believed that cause was related to approach settlement, roadway roughness and load positioning during the testing.

- Current provisions for dynamic load allowance with AASHTO LRFD can be extended to SPS bridges.

Deck Design Procedure

- Considering the AASHTO LRFD limit states, the design of SPS deck is controlled by stiffness. The flexural rigidity can be related directly to the girder spacing to satisfy the deflection limits.
- The stress criteria for the serviceability and strength limit state should not control (when including typical dead and live loads).
- The stress range due to the AASHTO fatigue design loading was shown not to control for steel face plate thicknesses greater than 1/8 in.

RECOMMENDATIONS

In considering the design of SPS bridges versus that of a conventional bridge such as a steel girder bridge with a reinforced concrete deck, the following recommendations are made:

1. VDOT's Structure & Bridge Division should consider the AASHTO LRFD provisions for transverse load distribution for a reinforced concrete deck on steel girders when designing a bridge structure with an SPS deck.
2. VDOT's Structure & Bridge Division should consider AASHTO LRFD provisions for dynamic load allowance when designing a bridge structure with an SPS deck.
3. VDOT's Structure & Bridge Division should consider using the deflection-based design methodology presented in this report to size face plates and the core. The designer should select a face plate thickness of at least 3/16 in to ensure that the fatigue limit state does not control the design of the base metal. For plate thicknesses less than 1/8 in, a refined analysis may be required.
4. The Virginia Transportation Research Council should consider further laboratory investigations of the shear capacity of SPS. Measurement of the shear strength of SPS cross-sections would allow for the determination of the boundary for a shear-critical configuration, ensuring that shear failures will not control the design.
5. VDOT's Structure & Bridge Division should consider careful inspection of the steel-polymer interface prior to acceptance of an SPS deck. Loss of bond between the polymer core and face plates results in stress concentrations in the face plates and

potential fatigue issues. This is primarily a quality control issue and should be able to be prevented by a rigorous inspection program.

BENEFITS AND IMPLEMENTATION PROSPECTS

The SPS is an innovative bridge deck system that can be used for both new bridge construction and bridge rehabilitation applications. It shows great promise to meet the FHWA's initiatives to reduce the number of deficient bridges in the U.S. by improving service life and speed of construction, thus lowering initial costs, and provide reserve strength for additional traffic demands.

The procedures developed from the analytical investigations were shown to yield conservative designs, but additional field investigations of the lateral load distribution characteristics, dynamic load allowance, vibration characteristics, and deck response of in-service SPS bridges would provide further validation of the analyses and allow for additional refinement. Of special importance is testing of bridges with more than three girders. Additional live load testing would allow for the consideration of additional parameters, specific to SPS bridges, which may influence lateral load distribution and dynamic characteristics. The testing would also allow for an assessment of the influence of temperature, roadway surface profile, support conditions, vehicle speed, and vehicle characteristics on the dynamic behavior of SPS bridges. It would also provide additional validation of the deck response when subjected to static and dynamic truck loads.

ACKNOWLEDGMENTS

The authors thank VDOT for providing funding for this project as part of the Innovative Bridge Research and Deployment Program sponsored by the FHWA. Garry Lovins, Bristol District Structure and Bridge Engineer; his assistants, Chris Blevins and Teresa Gothard; and Michael Brown and Jose Gomez of the Virginia Transportation Research Council are acknowledged for their involvement in securing funding for this project.

REFERENCES

American Association of State Highway and Transportation Officials. (2004). *AASHTO LRFD bridge design specifications*. Washington, DC.

Barker, R. M., and Puckett, J. A. (1997). *Design of highway bridges: based on AASHTO LRFD bridge design specifications*. John Wiley, Washington, DC.

- Barker, R. M., and Puckett, J. A. (2007). *Design of highway bridges: An LRFD Approach*. John Wiley and Sons, Inc., Washington, DC.
- Canadian Standards Association. (1988). *Design of Highway Bridges CAN/CSA-S6-88*. CSA International, Toronto, Ontario.
- Canadian Standards Association. (2000). *Canadian Highway Bridge Design Code CAN/CSA-S6-00*. CSA International, Toronto, Ontario.
- Cantieni, R. (1984). Dynamic Load Testing of Highway Bridges. *Second Bridge Engineering Conference*, Minneapolis, MN, 141-148.
- Chan, T.H.T., and O'Connor, C. (1990). Vehicle Model for Highway Bridge Impact. *Journal of Structural Engineering*, 116(7), 1772-1793.
- Davies, J. M. (2001). *Lightweight sandwich construction*. Blackwell Science, Malden, MA.
- Harris, D. K. (2007). *Lateral Load Distribution and Deck Design Recommendations for the Sandwich Plate System (SPS) in Bridge Applications*. Doctoral Dissertation, Virginia Tech, Blacksburg.
- Holt, John M. (2008). Personal communication. July 29, 2008.
- Intelligent Engineering (IE). (2007). SPS: The Sandwich Plate System: Civil Engineering. http://www.ie-sps.com/civil_engineering.html. Accessed October 31, 2007.
- Intelligent Engineering Limited (IE). (2004). Shenley Bridge Static and Dynamic Load Test Results.
- Kennedy, S. J., Kennedy, D. J. L., Dorton, R. A., Wright, D. G., and Vincent, R. B. A true innovation: Steel plates with a structural elastomer core. *Proceedings of the 5th International Conference on Composite Construction in Steel and Concrete V Composite Construction in Steel and Concrete V - Proceedings of the 5th International Conference*, 114-126.
- Murray, T. M. (2005). Shenley Bridge Vibration Measurements. Technical Report to Intelligent Engineering, Virginia Polytechnic Institute and State University, Blacksburg.
- Paultre, P., Chaallal, O., and Proux, J. (1992). Bridge Dynamics and Dynamic Amplification Factors: A Review of Analytical and Experimental Findings. *Canadian Journal of Civil Engineering* 19, 260-278.

Plantema, F. J. (1966). *Sandwich construction; the bending and buckling of sandwich beams, plates, and shells*. Wiley, New York.

Stallings, J. M., and Yoo, C. H. (1993). Tests and Ratings of Short-Span Steel Bridges. *Journal of Structural Engineering*, 119(7), 2150-2168.

Tilly, G.P. (1986). *Dynamic Behavior of Concrete Structures: Report of the RILEM 65 MDB Committee*. Elsevier, New York.

Vinson, J. R. (1999). *The behavior of sandwich structures of isotropic and composite materials*, Technomic Pub. Co., Lancaster, PA.

Waldron, C. J., Cousins, T. E., Nassar, A. J., and Gomez, J. P. (2005). Demonstration of Use of High-Performance Lightweight Concrete in Bridge Superstructure in Virginia. *Journal of Performance of Constructed Facilities*, 19(2), 146-154.

Zokaie, T. (1992). Distribution of wheel loads on highway bridges. NCHRP, Research Results Digest, 1-31.

Zokaie, T. (2000). AASHTO-LRFD live load distribution specifications. *Journal of Bridge Engineering*, 5(2), 131-138.