

**Quantitative Analysis of Antioxidants from High Density Polyethylene (HDPE)
by off-line Supercritical Fluid Extraction Coupled High Performance Liquid
Chromatography**

Angela M. Pinto

Thesis submitted to the Faculty of the Virginia Polytechnic Institute and
State University in partial fulfillment of the requirements for the degree of

**Master of Science
in
Chemistry**

Larry T. Taylor, Chair

Thomas C. Ward

James Glanville

James F. Wolfe

August 25, 1997

Blacksburg, Virginia

Keywords: Supercritical, Extraction, High Density Polyethylene (HDPE), Ethanox[®] 330,
Ethanox[®] 398, SFE, HPLC, Mass Spectrometry, Direct-Inlet Probe (DIP)

Copyright 1997, Angela M. Pinto

Quantitative Analysis of Antioxidants from High Density Polyethylene (HDPE) by off-line Supercritical Fluid Extraction Coupled High Performance Liquid Chromatography

Angela M. Pinto

(ABSTRACT)

Plastics are widely used and they vary in their applicability, ranging from automobile parts, components for houses and buildings, and packaging for everything from food to electronic parts. The diverse applications of plastics, such as polystyrene, polyolefins and polyester, are credited to the incorporation of additives. Additives improve the performance of these and other polymer resins. Without the incorporation of such additives, for example Ethanox[®] 330, some plastics would degrade during processing or over time. To ensure that the specified amount of an additive or combination of additives are incorporated into a polymer after the extrusion process, a rapid and accurate analytical method is required. Quantitation of additive(s) in the polymer is necessary, since the additive(s) may degrade and the amount of additive(s) can influence the physical nature of the polymer. Conventional extraction techniques for polymer additive(s), such as, Soxhlet or dissolution / precipitation are labor intensive, time consuming, expensive, and the optimal recovery is significantly less than 90 percent. In addition, a large amount of solvent, such as toluene or decalin, must be eliminated in order to concentrate the sample prior to chromatographic separation.

Supercritical Fluid Extraction (SFE) has been employed as an alternative polymer preparation technique. SFE is a favorable means for various analytical sample preparation applications, credited to its short extraction times. This research employs SFE for the extraction of the antioxidant Ethanox[®] 330 from high density polyethylene (HDPE) followed by HPLC/UV analysis. The effects of temperature, modifier type, and modifier concentration were investigated. Once the optimal extraction conditions were determined, the extraction efficiency

of Ethanox[®] 330 as a single additive and in the presence of co-additives from HDPE were investigated. Recoveries of greater than 90% were obtained for Ethanox[®] 330 when a secondary antioxidant was present in the HDPE.

Acknowledgments

The author would like to thank those people who gave their support, friendship and prayers. Special thanks to Dr. Larry T. Taylor, my advisor, for his constant guidance, support, encouragement and confidence. Secondly, to everyone in the Taylor Group who gave me their time and friendship. Especially, Dr. Michael Combs, Lori McDaniel and Shelley Porter. Thirdly, to my committee members for their time and guidance. Fourth, Albemarle Corp. (Baton Rouge, LA.) for their financial support, the supply of the standards and prepared HDPE samples. Fifthly, to the following staff members at Virginia Tech; Kim Harich (MS Instrumentation), Dr. John Seiler (Forestry Dept.), Fred Blair (Machine Shop), Jim Coulter (Electronic Shop) and Kezia Spicer (Chemistry Dept.). Sixthly, to both of my parents, Leonilde and Jose Pinto for their love, support and reassurance. Also, to those family members and friends that were simply there when I needed them to be. Seventhly, to my Lord Jesus Christ. And to all those other people not mentioned above specifically; thank you.

Table of Contents

	Page
Abstract	ii
Acknowledgements	iv
List of Figures	vi
List of Tables	ix
I. Introduction	1
A. Additives in Polymers	1
B. Supercritical Fluid Extraction	9
C. Analysis of Additives in Polymers	14
II. Quantitative Analysis of Ethanox[®] 330 in High Density Polyethylene	18
A. Introduction	18
B. Experimental	18
C. Results and Discussion	20
D. Conclusion	43
III. Mass Spectrometric Determination of Degradate Peak	44
A. Introduction	44
B. Experimental	44
C. Results and Discussion	45
D. Conclusion	56
References	57
Vita	59

List of Figures

Figure	Description	Page
1	Chemical structures of hindered phenols.	3
2	Mechanism of action of hindered phenols.	4
3	Chemical structures of phosphites.	7
4	Mechanism of action of phosphites.	8
5	Basic components of an off-line analytical supercritical fluid extractor.	12
6	Main effects plot for five extraction variables.	21
7	DSC of a milled HDPE sample containing 1000ppm Ethanox [®] 330.	24
8	HPLC of an Ethanox [®] 330 polymer extract (20 μ L injection).	28
9	HPLC of an aged or fresh 1000ppm standard methanol solution of Ethanox [®] 330 (20 μ L injection).	29
10	Effect of temperature which has been spiked on sand.	30

11	HPLC of an Ethanox [®] 330 polymer extract (20µL injection).	31
12	HPLC of a residue of extracted sample containing 1000ppm Ethanox [®] 330/ 1000ppm Ethanox [®] 398/ 500ppm DHT trapped within the oligomers.	34
13	HPLC of an extracted polymer sample containing 500ppm Ethanox [®] 330/ 1000ppm Irgafos [®] 168/ 500ppm CaSt.	36
14	HPLC of an extracted polymer sample containing 500ppm Ethanox [®] 330/ 1000ppm Irgafos [®] 168/ 100ppm Irganox [®] 1076/ 2% CaCO ₃ .	37
15	HPLC of extracted polymer sample not heated and heated prior to LC analysis.	41
16	LSIMS+ of Ethanox [®] 330 in a glycerol matrix.	47
17	EI+ of Ethanox [®] 330.	48
18	CI+ of Ethanox [®] 330.	50
19	CI+ of degradate fraction.	51
20	CI+ of degradate fraction with the subtraction of the molecular ion of m/z 509.	52
21	CI+ of a HDPE extract containing Ethanox [®] 330 and the degraded species.	53

22	Formula calculations for the number of rings and double bonds.	54
23	Chemical structure of the possible degradate.	55

List of Tables

Table	Description	Page
I	Examples of commercially available hindered phenols and hindered amines used as primary antioxidants.	2
II	Examples of commercially available phosphites and thiocompounds used as secondary antioxidants.	6
III	Critical parameters of common fluids used for SFE.	10
IV	Extraction and analysis techniques for polymer samples.	15
V	The data for five extraction variables.	22
VI	Percent recoveries of Ethanox [®] 330 from HDPE at 100ppm additive.	25
VII	Percent recovery of Ethanox [®] 330 from HDPE at different additive levels.	26
VIII	HDPE sample composition and additive level.	33
IX	Total recovery of Ethanox [®] 330 from HDPE polymer samples.	35
X	HDPE sample composition and additive level.	39
XI	Recovery of Ethanox [®] 330 from HDPE polymer samples.	40

XII	Comparision of recovery of Ethanox [®] 330 from HDPE polymer samples in the presence of Irgafos [®] 168 with and without acid scavenger.	42
-----	--	----

Chapter I

Introduction

Additives in Polymers

Polymers would not be able to perform such diverse functions without the aid of additives. Without the incorporation of additives, some polymers would degrade, oxidize, cross-link, discolor, lose molecular weight or become brittle over time due to air oxidation, heat, radiation, metal or chemical exposure. Polymers, such as polyethylene are very susceptible to air oxidation without the direct assistance of additives. Additives, as a whole, improve the performance and stability of most polymer resins. The manner in which an additive(s) works depends on the class of additive. There are numerous commercially available additives; the following are some of the major classes of additives: antioxidants (primary and secondary), flame retardants, acid scavengers, and nucleating agents.

Antioxidants are employed to retard the degradation of polymers due to air oxidation. Free radicals are initiated by reactions within the polymer brought-on by heat, ultraviolet radiation, mechanical shear or metallic impurities (1). These free radicals are extremely reactive and can propagate more free radicals.

There are two basic types of antioxidants: primary and secondary. Primary antioxidants are defined as additives that intercept and stabilize free radicals by donating an active hydrogen atom, gaining their name “radical scavengers” (1). Primary antioxidants perform well without the presence of other additives in their intended application. Hindered phenols and hindered aromatic amines represent two main types of primary antioxidants. **Table I** lists a few examples of commercially available hindered phenols and hindered amines and some of their structures are shown in **Figure 1** (1). The mechanisms of action for hindered phenols and amines are different.

Typically, hindered phenols are the most commonly used type of primary antioxidant. The specific mechanism for hindered phenols is shown in **Figure 2** (1). Hindered phenols donate their phenolic hydrogen to the generated radical thus stabilizing the polyalkane. In the process of stabilizing the alkyl free radical, the hindered phenol itself becomes a radical known

Table I. Examples of commercially available hindered phenols and hindered amines used as primary antioxidants. (Taken from Ref. 1)

Hindered Phenols

Trade name	Manufacture	Molecular weight	No. of phenolics	Key to structures
BHT	Various	220	1	a
Irganox [®] 1076	Ciba-Geigy	531	1	b
Irganox [®] 1010	Ciba-Geigy	1178	4	c
Irganox [®] 3114	Ciba-Geigy	784	3	d
Ethinox [®] 330	Albemarle Corp.	775	3	e
Topanol [®] CA	Zeneca	545	3	f
GA-80	Sumitomo	741	2	g

Hindered Amines

Trade name	Manufacture	Type	Molecular weight
Tinuvin [®] 770	CIBA	Monomeric	481
LA-57	Asahi Denka	Monomeric	326
Chimassorb [®] 994	CIBA	Polymeric	>2500
Cyasorb [®] 3346	Cytex	Polymeric	1600
Cyasorb [®] UV-500	Cytex	Monomeric	522
Uvasorb [®] HA-88	3-V Chemical Corp.	Polymeric	3000

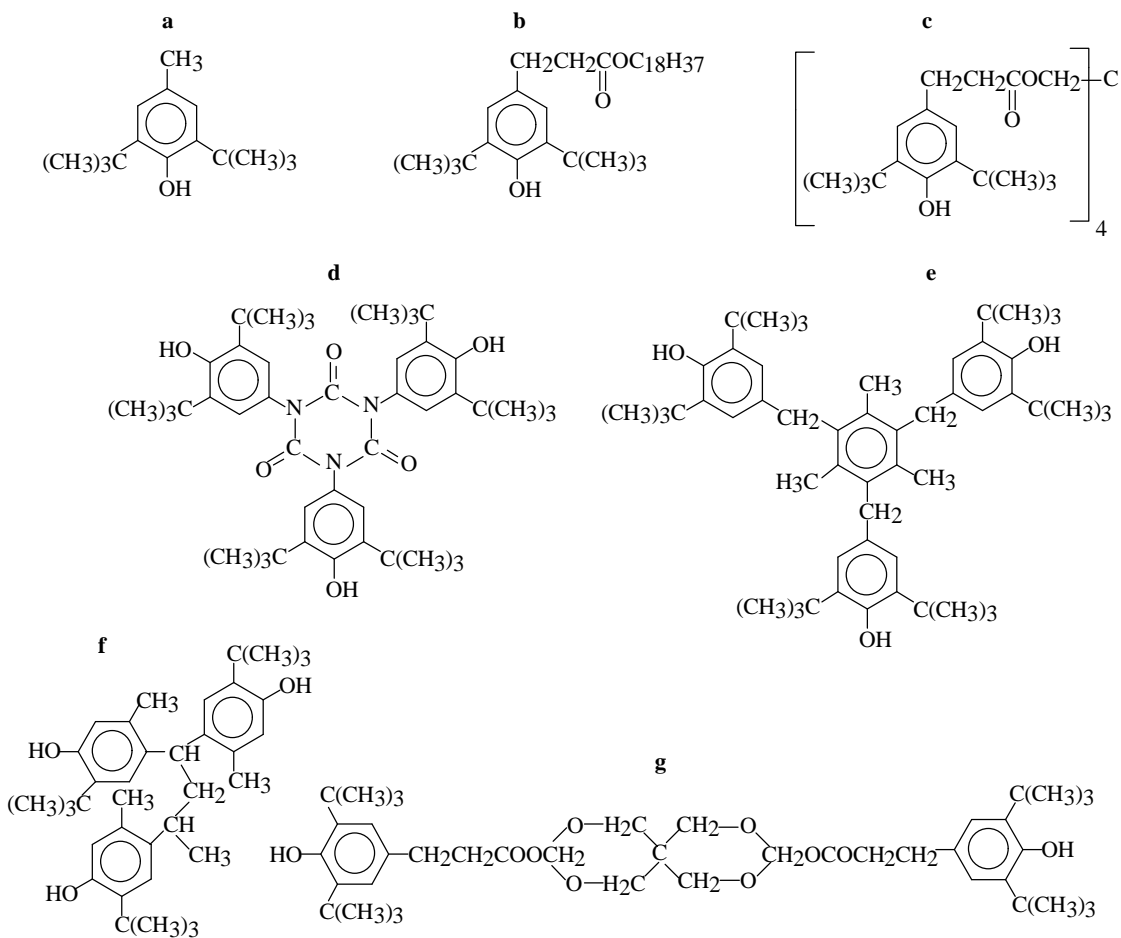
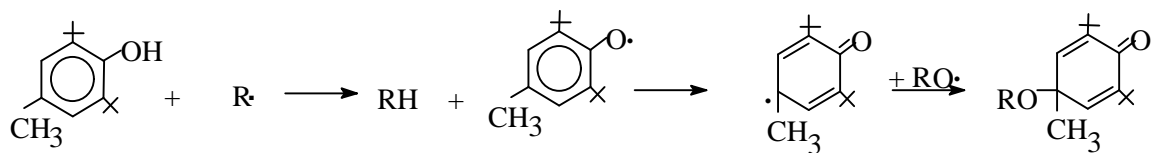

Figure 1. Chemical structures of hindered phenols. See **Table I** for identification.



$\text{R}\cdot$ = alkyl radical

RH = polyalkane

$\text{RO}\cdot$ = alkoxy radical

Figure 2. Mechanism of action of hindered phenols.

(Taken from Ref. 1)

as a hindered phenoxy (1). This radical will then form a quinone-like structure. There is a wide selection of hindered phenols commercially available, for example Ethanox[®] 330, Irganox[®] 1010 and Irganox[®] 1076. **Figure 1** illustrates their structures. In general, the molecular weight of the molecule will be related to the temperature stability of the molecule (1). For example, Ethanox[®] 330 has a molecular weight of 775 as compared with Irganox[®] 1076 that has a molecular weight of 531. Ethanox[®] 330 would have a higher thermal stability than Irganox[®] 1076. From the structures, we observe that Ethanox[®] 330 also contains three hindered phenolic sites whereas Irganox[®] 1076 contains one hindered phenolic site. In theory, Ethanox[®] 330 can stabilize three more radicals.

Secondary antioxidants prevent the further formation of free radicals by decomposing unstable hydroperoxides prior to their homolytic cleavage. Instead, the unstable hydroperoxide forms a stable product. Consequently, earning the name “peroxide decomposers” (1). A second function of secondary antioxidants is that they may also regenerate the primary antioxidant (2). The two main types of secondary antioxidants are phosphites and thioesters. These both function in the same manner. **Table II** lists a few examples of commercially available phosphites and thioesters and some of their structures are shown in **Figure 3** (1). Secondary antioxidants perform better with the incorporation of a primary antioxidant. However, not every type of primary antioxidant can be incorporated with any type of secondary antioxidant. Secondary antioxidants work well with the correct combination of primary antioxidant. Phosphites are the most commonly used type of secondary antioxidant. The specific antioxidant mechanism for phosphites is shown in **Figure 4** (1). Ethanox[®] 398 and Irgafos[®] 168 are two examples of commercially available phosphites.

There are also other types of additives that are incorporated within polymers, such as acid scavengers. An acid scavenger is a necessary additive due to catalyst residues. Normally the amount of acid residues are in low quantity; however, as a precaution, neutralization of acid residues are necessary to prevent corrosion of the processing equipment (1). Acid scavengers include calcium stearate and dihydro talcite.

Several types of additives may be used in a single polymer resin. For example, both

Table II. Examples of commercially available phosphites and thiocompounds used as secondary antioxidants. (Taken from Ref. 1)

Phosphites

Trade name	Manufacture	Type	Molecular weight	Key to structures
Weston [®] 399	General Electric	Aromatic	688	-
Ultranox [®] 618	General Electric	Aliphatic	732	-
Ultranox [®] 626	General Electric	Aromatic	604	-
Irgafos [®] 168	CIBA	Aromatic	647	h
Ethanox [®] 398	Albemarle Corp.	Fluoro	487	i

Thio compounds

Trade name	Manufacture	Type	Molecular weight
DSTDP	Various	Thioester	683
DLTDP	Various	Thioester	514
SE-10	Hoechst Celanese	Disulfide	571

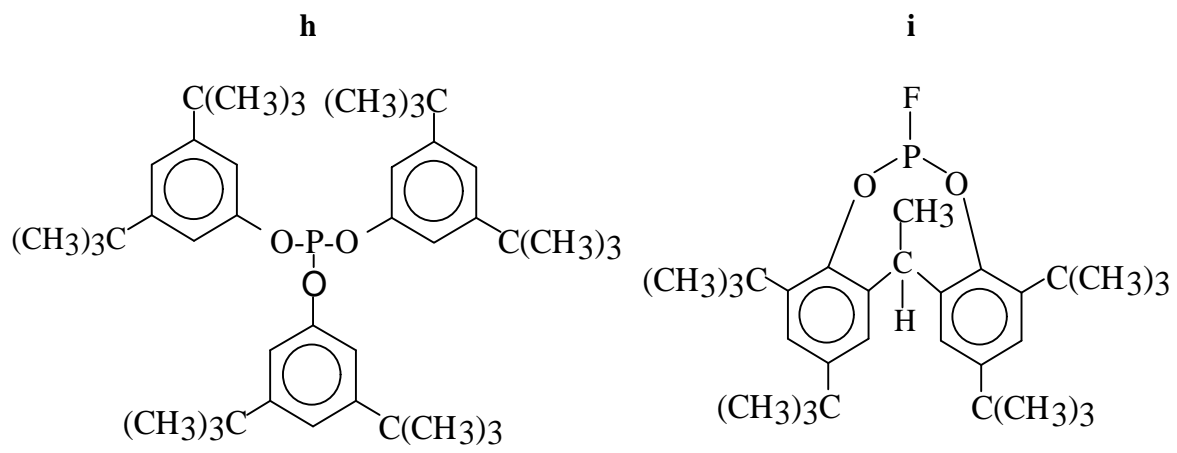
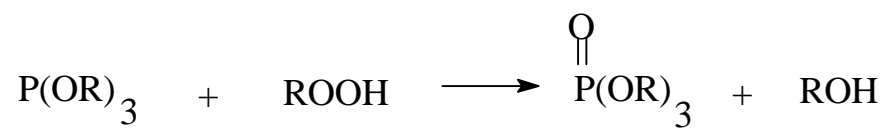

Figure 3. Chemical structures of phosphites. See **Table II** for identification.



ROOH = hydroperoxide

ROH = alcohol

Figure 4. Mechanism of action of phosphites.

(Taken from Ref. 3)

primary and secondary antioxidants, antistats, blowing agents, catalyst, flame retardants, impact modifier, UV stabilizer and lubricant may all be added into a high density polyethylene resin. Polymers are big business and in order to maintain their performance, additives are incorporated. Since the incorporation of additives is a must, the commercial need for polymer additives is in demand. As more and more companies are getting involved with the manufacturing of additives, the variety of additives is widely expanding. The race is on to manufacture additives with diverse applicability. For example, automobile bumpers last twice as long when made from polymer resin with certain additives than without (2).

Supercritical Fluid Extraction

Supercritical Fluid Extraction (SFE) avoids many of the problems encountered with other sample preparative methods. The use of supercritical fluids is recognized as a favorable alternative to using large amounts of solvents. The most common type of extracting fluid is carbon dioxide, which is inexpensive, noncombustible and easy to dispose of (4).

We can define a supercritical fluid as any substance that is above its critical temperature (T_c) and critical pressure (P_c) (5). The critical temperature is the highest temperature at which a gas can be converted to a liquid by an increase in pressure. Whereas, the critical pressure is the highest pressure at which a liquid can be converted to a traditional gas by an increase in the liquid temperature (5). For example, carbon dioxide has a T_c of 31.0°C and a P_c of 72.9bar.

Table III lists the T_c and P_c of some of the commonly used fluids for SFE (in order of increasing critical temperature) (5). Fluids in this region have properties intermediate between those of a liquid and those of a gas. More specifically, a supercritical fluid has a diffusivity and viscosity close to that of a gas, but a density closer to that of a liquid. They also possess low viscosity. They allow for better penetration of the matrix to reach the analyte due to their near zero surface tension. The gas-liquid like properties that supercritical fluids have made them ideal for the extraction of many matrices, allowing better, safer, faster and more efficient penetration of the matrix to remove and transport analyte(s) from the matrix and the bulk fluid to the collection trap.

Table III. Critical parameters of common fluids used for SFE.

(Taken from Ref. 5)

Gas	T _c (°C)	P _c (bar)
Xenon	16.6	57.6
Trifluoromethane	25.9	46.9
Chlorotrifluoromethane	29.0	38.7
Carbon dioxide	31.0	72.9
Dinitrogen monoxide	36.5	71.7
Sulfur hexafluoride	45.5	37.1
Chlorodifluoromethane	96.4	48.5
Propane	96.8	42.4
Ammonia	132.4	111.3
Trichlorofluoromethane	198.0	43.5
Water	374.0	217.7

Since we are discussing the background of SFE, it would be appropriate to define some commonly employed terms. There are many terms regarding SFE and it is not possible in this thesis to cover every term regarding SFE. However, we can go into some detail in this section to clarify the terms that will be used quite frequently. For instance, static and dynamic extractions are important terms. A supercritical fluid extraction can be performed by using either a static or dynamic mode or coupled together. In a static extraction, a fixed amount of supercritical fluid interacts with the analyte and matrix (5). In other words, the sample is allowed to “soak” in the extracting fluid for a set time (4). The most commonly employed example of a static extraction is of a tea bag and cup of water. When making a cup of tea, the soluble materials transfer from the tea bag (leaves) to the water.

In a dynamic extraction, a fresh supply of supercritical fluid is continuously passed over and through the sample matrix. Typically, a dynamic extraction can be more exhaustive than a static extraction (5). The most familiar example of a dynamic extraction is a coffee maker. The dynamic extraction allows the supercritical fluid to pass through and over the matrix to allow a second chance to remove the analyte from the matrix to the bulk fluid where it is then carried to the collection trap.

In comparison to a dynamic extraction, a static extraction is much shorter and employs less supercritical fluid or modified fluid. During a dynamic extraction, large amounts of supercritical fluid or modified fluid are used. More fluids are used depending on the length of dynamic extraction time.

The definition of a supercritical fluid extraction would not be complete without discussion of the hardware. As shown in **Figure 5**, the basic components of an off-line analytical supercritical fluid extractor consists of (a) supply of CO₂ or some other potential fluid, (b) gas compressor or pump, (c) heated zone or oven, (d) extraction vessel or thimble, (e) outlet restrictor or valve, and (f) collection trap. The pure CO₂ is stored in a high pressure aluminum gas cylinder with a dip tube that extends close to the bottom into the liquified gas layer. Most cylinders are available either with or without helium head pressure (2,000psi). The purity of the

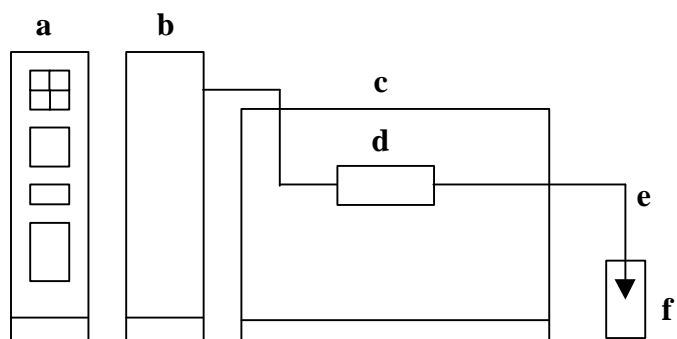

Figure 5. Basic components of an off-line analytical supercritical fluid extractor.

(a) controller, (b) pump, (c) oven, (d) extraction vessel, (e) restrictor, and (f) collection vial. (Taken from Ref. 7)

fluid employed should be as high as possible.

There are two types of pumps currently available for SFE: reciprocating piston and syringe. Both offer certain advantages and possess certain disadvantages. Both deliver CO₂ in the liquid state (5,6,7,8). For this work, a piston pump was employed, since it provides a constant fluid supply. However, the pump head and fluid transfer lines must be cooled. To do this it is necessary to employ a carbon dioxide (SFE/SFC grade) cylinder without helium headspace for extractions and a cryo cylinder for cooling. Since we used a modifier, it was necessary to employ a piston pump, since changing modified fluids is easier and less problematic with a piston pump than a syringe pump. A syringe pump requires cleaning before introducing another fluid (5). Typically, if one will be using modified fluid, one needs to use a piston pump.

In order to bring the fluid to the specified density and temperature, the extraction vessel must be heated. Any type of oven is satisfactory. However, a specific and reliable electronic system is required to control the temperature in the system during extraction.

The extraction vessel must be able to withstand high pressures between 5,000 to 10,000psi. It is usually constructed from stainless steel, which is chemically inert and durable. Finger-tight fittings are used to cap the ends. The extraction vessel sizes vary ranging in volume from 0.1 to 50mL (5). The size requirement depends on the SFE instrument design. For example, extractions performed in this study employ a Hewlett Packard 7680T extractor that requires 7mL extraction vessels.

A restrictor is employed to regulate the flow and back pressure. Both fixed and variable restrictors are currently employed. A fixed restrictor allows greater fluid density to be achieved. Unfortunately, plugging of the fixed restrictor may occur. A variable restrictor offers adjustable flow. The Hewlett Packard 7680T extractor design employed in this study uses a variable restrictor.

Collection or accumulation devices are required to hold the extractables. Most collection traps may be either an inert solid or active solid packing material. Inert solid material consists of glass beads or stainless steel beads. An active solid material may be a C₁₈ stationary phase, for example. Once the analyte(s) are trapped, they may be rinsed with an appropriate solvent from

the trap to either empty glass vials or a tandem liquid trap, such as the one used in this work.

Analysis of Additives in Polymers

In order to ensure the specified amount of an additive or the combination of additives have been incorporated into a polymer following extrusion, a rapid and accurate analytical method is required. Furthermore, quantification of additive(s) in the polymer is necessary for quality assurance, since the additive(s) may degrade and subsequently the amount of additive(s) can influence the physical nature of the polymer (2). **Table IV** lists the various extraction and analysis techniques employed for additives in polymer samples.

Conventional extraction techniques for polymer additive(s), such as, Soxhlet and dissolution / precipitation are laborious, time consuming, and expensive. The optimal recovery is usually significantly less than 90%. During Soxhlet extraction, thermal decomposition of certain volatile additive(s) may result from heating organic solvent to temperatures as high as 110 °C. In addition, a large amount of organic solvent, such as toluene or decalin, must be eliminated in order to concentrate the sample prior to chromatographic separation and analysis.

Dilettato et al. (9) employed Soxhlet extraction for the removal of various additives from polyethylene and polypropylene. In this case, the length of an average extraction of polyethylene was 15 hours using 250mL of chloroform. Several additional steps were required following extraction, such as filtration of the liquid extract under vacuum through a 0.22µm filter and evaporation of the excess organic solvent.

Dissolution / precipitation extraction minimizes the chance of additive decomposition since there is no heated solvent. Monteiro et al. (10) used sonication in a cold solvent bath to extract certain additives from polyolefins. The minimum extraction time in the ultra sonic bath was 30-45 minutes depending on the additive and polymer. Although, they were able to minimize the extraction time, subsequent steps were still needed to filter and to remove the large amount of solvent. Sonication in a cold solvent bath to extract additives from high density polyethylene was also used by Yagoubi et al. (11). The process required milling the pellets before sonication. In other studies, Schabron et al. (12) extracted BHT, Irganox[®] 1076 and

Table IV. Extraction and analysis techniques for additives in polymer samples.

Extraction/Analysis technique	Polymer sample	Reference number
on-line SFE/SFC	polyethylene	15, 16
on-line SFE/SFC	LDPE ^a	20
off-line SFE/GC	HDPE ^b	3
off-line SFE/GC-MS	LDPE, UHMWPE ^c	17
Soxhlet/GC	polypropylene	21
Soxhlet/GC	polyolefins	22
Soxhlet/HPLC	polyolefins, polyethylene	23, 24, 25
Soxhlet/SFC	polyethylene	9
sonication/HPLC	polyolefins	10
sonication/HPLC	HDPE	11
dissolution/precipitation/IR	HDPE	13
dissolution/precipitation/HPLC	polyethylene	12

^a Low density polyethylene

^b High density polyethylene

^c Ultra-high molecular weight polyethylene

Irganox[®] 1010 from polyethylene pellets by first dissolution in decalin at 110 °C followed by exclusive precipitation of the polymer on cooling. Esperidiao et al. (13) also isolated the additives from the polymer by precipitating HDPE from decalin by gradual temperature changes while stirring the solution. In all these cases, the quantity of solvent was relatively large. Filtering the extract solution through a PTFE membrane was also required prior to chromatographic analysis.

Supercritical fluid extraction (SFE) has recently become a favored means of analytical sample preparation for various applications. Carbon dioxide is the most popular supercritical fluid for SFE, due to its environmental safety, mild critical parameters, and cost. Supercritical fluids possess unique properties which make them functional as both an extraction solvent and a mobile phase in chromatographic analysis. Most SFE applications with 100% CO₂, however, are limited to relatively nonpolar analytes. In order to extract polar compounds, a small amount of a polar material such as methanol, is often required as a co-solvent to CO₂. The role of a modifier in the extraction of polymer additive(s) is generally considered to either swell the polymer and/or to improve the solvent strength of the CO₂.

The need for faster extractions of polymeric material is usually considered secondary, compared to the primary interest of gaining better extractability of the additive(s). The expectation of SFE is, however, not only to provide faster but more efficient extraction. Ashraf-Khorassani et al. (14) have employed on-line SFE/SFC to extract and analyze for polystyrene additives. They found that higher extraction efficiencies of *N,N*-ethyl bis(stearamide) (EBS) could be obtained at elevated temperatures (150 °C). Thus, a 15min. extraction time was found to be optimal for high percent recovery of EBS from milled polystyrene.

In general, the time required for extraction varies depending on the additive, its concentration within the polymer and the surface area of the polymer sample. Even the cases of large molecular weight additives, such as, Irganox[®] 1076 and Irganox[®] 1010, SFE required significantly less time than any other conventional extraction technique. Lou et al. (15) studied the extraction of Irganox[®] 1010, Irganox[®] 1076 and Irgafos[®] 168 from polyethylene by on-line SFE/SFC. After discovering the optimal flow rate, density, and pressure, they also found that increasing the extraction temperature improved the recovery efficiency. The maximum extraction

temperature, however, had to remain below the melting point of the polymer to avoid plugging the restrictor from carry-over of the melted polymer. On-line SFE/SFC was used by Tikuisis et al. (16) to quantitatively determine the antioxidant content of high density polyethylene. Their results showed an average recovery of greater than 97% of all antioxidant additives. The total analysis time for each sample was less than 90 minutes.

It has also been shown in a number of publications that similar results with polymer additives can be obtained by off-line SFE in conjunction with either HPLC or GC (17-19). Braybrook et al. (17), for example, investigated the use of off-line SFE for polyethylene additives with GC analysis for use as a potential standard test protocol for various polymer matrices. It has also been demonstrated by Engelhardt et al. (18) that off-line SFE with HPLC shows equivalent benefits for the analysis of environmental samples as well as polymeric materials.

The work presented in this thesis employs SFE for the removal of the antioxidant Ethanox[®] 330 from high density polyethylene followed by HPLC/UV analysis. Spiking experiments onto sand were performed as the first part of our study, in order to determine the effect of temperature and modifier type upon extraction and trapping efficiency of Ethanox[®] 330. The second part of our study involved determination of the extraction efficiency of Ethanox[®] 330 from HDPE in the absence of other additives using previously determined optimum extraction conditions. The third part of our study concerned the determination of the extraction efficiency of Ethanox[®] 330 from HDPE in the presence of co-additives. The main objective of this study was to obtain high recoveries of Ethanox[®] 330 from HDPE at various doping levels.

Chapter II

Quantitative Analysis of Ethanox[®] 330 in High Density Polyethylene

Introduction

Supercritical fluid extraction was employed as an alternative polymer sample preparation technique prior to the HPLC assay of the additive Ethanox[®] 330 from high density polyethylene. The effects of temperature, extraction time, sample size, modifier type, and modifier concentration were investigated. The main objective of this study was to obtain high recoveries of Ethanox[®] 330 at various doping levels from HDPE samples with and without the presence of co-additives.

Experimental

Calibration. The amount of Ethanox[®] 330 additive extracted from the HDPE polymer was determined via high performance liquid chromatography using an external calibration curve that was constructed using four concentrations of Ethanox[®] 330 standard (Albemarle Corp., Baton Rouge, La.). A 1000ppm stock solution of the antioxidant Ethanox[®] 330 in spectrograde 95:5 (v/v) methanol:tetrahydrofuran was initially prepared. The chromatographic standards ranged in concentration from 50 to 1000ppm which covered the expected concentration levels of Ethanox[®] 330 additive in the polymer.

Spiking Study. An 100 μ L aliquot of the 1000ppm Ethanox[®] 330 stock solution was spiked onto Ottawa sand which was contained in a 7mL extraction vessel. The spike matrix was then subjected to the identical extraction and chromatographic parameters as the polymer samples.

Extraction. The HDPE samples for extraction were obtained from Albemarle Corp. (Baton Rouge, La.). The various concentration levels of Ethanox[®] 330 were incorporated into the HDPE during extrusion in their laboratory. Prior to extraction, the HDPE pellets were ground with a Wiley Mill, obtained from the Forestry Department at Virginia Tech, at room temperature in order to increase particle surface area. Since loss of additive(s) may occur due to thermal decomposition during the milling process, the chamber was cooled by blowing air inside the

chamber between samples. In addition, only a few pellets were ground at a time. Each of the samples were ground to the same mesh size every time. Sharp cutting blades were also used to minimize the heat produced in the steel chamber (10).

Extractions were performed on a Hewlett Packard 7680T extractor. A 7 mL extraction vessel was filled with 1.0g of ground HDPE sample. Ottawa sand (Fischer Scientific, Fair Lawn, N.J.) was used to fill approximately 80% of the remaining vessel volume for all extractions. It was necessary to leave a small percentage of dead volume in the extraction vessel due to expansion of the polymer during extraction. A liquid phase tandem trap was initially used along with an octadecylsilica solid phase trap as a precaution to ensure high trapping efficiency. The liquid tandem trap was filled with 5mL of methanol. In the final analysis, however, the secondary liquid trap was not needed. Carbon dioxide (SFE/SFC grade) without helium headspace was obtained from Air Products and Chemicals Co. (Allentown, Pa.). The optimum extraction conditions were:

Extraction Fluid:	CO ₂
Flow Rate:	1.0mL/min. liquid
Modifier:	20% (v/v) MeCl ₂ added in-line to CO ₂
Pressure:	350bar
Chamber Temp.:	110°C
Nozzle Extraction Temp.:	55 °C
Nozzle Rinsing Temp.:	30 °C
Static Time:	20min.
Dynamic Time:	50min.
Trap:	Octadecylsilica solid phase + 5mL of liquid MeOH
Solid Phase Trap Extraction Temp.:	80 °C
Solid Phase Trap Rinsing Temp.:	30 °C
Trap Rinse Solvent:	MeCl ₂
Trap Rinse Volume:	5.4mL (3 x 1.8mL)

Chromatographic Analysis. A Hewlett Packard Series 1050 HPLC was used for all extract analysis. The mobile phase consisted of 90:5:5 (v/v/v) acetonitrile:methanol:tetrahydrofuran. A 20 μ L injection volume of the combined solid phase trap rinse solvent and liquid methanol trap after reduction in volume to 1.0mL was introduced. The flow rate was set at 1.0 mL/min. The column was an ODS Hypersil (150 x 4.6mm, 5 μ m dp) with a C₁₈ (Varian, Sunnyvale, Ca.) guard column. It was necessary to employ the use of a guard column in order to retain for longer periods of time the performance of the separation column. UV detection at 280 nm was used for all analyses. Other wavelengths, such as, 220 nm could have also been employed, but quantification of the additive was more difficult at 220 nm, because of strong absorption from interfering low molecular weight oligomers.

Results and Discussion

Ethanox[®] 330 Extraction

The main objective of this study was to obtain high recoveries of Ethanox[®] 330 at different levels from HDPE employing supercritical fluid extraction. For the optimization of the SFE method, the influence of various experimental parameters, such as static and dynamic time, sample size, modifier percentage and rinse solvent, were determined on a 100ppm Ethanox[®] 330 doped HDPE sample. **Figure 6** illustrates the results of varying these experimental parameters in a plot form using a Minitab program called the Main Effects Plot. The Main Effects Plot is designed to test multiple factors. The points in the plot are the means at the various levels of each factor. For example, from the data in **Table V** for the effect of changing sample size had on the percent recovery. The data point at 78% is the mean of all the runs of a 1.0g sample size and the data point at 79% is the mean of all the runs of a 0.1g sample size. The dashed line or called the reference line is drawn through the plot representing the grand mean of 78.5% of all the runs. These plots indicate that there is no significant difference in the recovery of Ethanox[®] 330 when varying either the sample size, rinse solvent, or dynamic time. However, there is a significant difference in the recovery of Ethanox[®] 330 when varying the static time and modifier concentration. There is also a statistical difference in percent recovery when employing a static

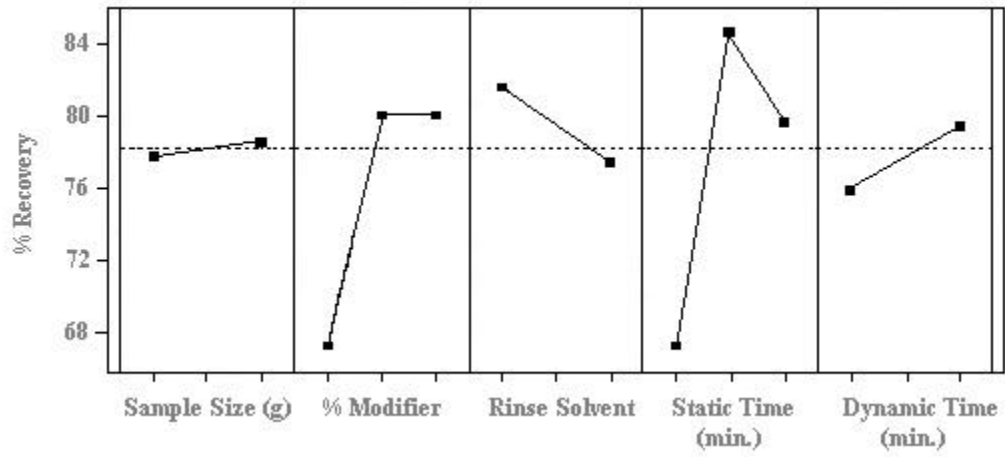

Figure 6. Main effects plot for five extraction variables.

Table V. The data for five extraction variables.

% Recovery	Sample Size (grams)	% Modifier	Rinse Solvent	Static Time (min.)	Dynamic Time (min.)
68.4	0.1	10	1 ^a	10	45
65.2	0.1	10	1	10	45
68	0.1	10	1	10	45
77.6	0.1	15	1	20	50
84.3	0.1	15	1	20	50
78.2	0.1	15	1	20	50
74.2	0.1	20	1	20	50
86.0	0.1	20	1	20	50
80.0	0.1	20	1	20	50
86.2	0.1	20	1	15	45
83.0	0.1	20	1	15	45
74.8	0.1	20	1	20	45
85.2	0.1	20	1	20	45
79.2	1.0	20	1	20	50
85.5	1.0	20	1	20	50
62.2	1.0	20	1	20	50
78.6	1.0	20	0 ^b	20	50
85.2	1.0	20	0	20	50
81.0	1.0	20	0	20	50

^a Methanol

^b 90:5:5 (v/v/v) Acetonitrile:Methanol:THF

time of 10min. versus either 15 or 20min. However, there is no statistical difference between 15 and 20min. static time. As shown in **Figure 6**, there is an increase in percent recovery when using larger amounts of methanol modifier. There is a statistical difference between 10% versus either 15 or 20% methanol modifier. However, there is no statistical difference between 15 and 20% modifier. In all cases, the highest percent recovery for 100ppm Ethanox[®] 330 doped HDPE sample was 85% recovery.

Because Ethanox[®] 330 exhibited at least ten times higher solubility in methylene chloride than in methanol, methylene chloride was used as the CO₂ modifier (e.g. 10-20% (v/v)) in hopes of increasing the percent recovery. For a successful polymer additive extraction, the temperature must be above the polymer T_g and below the polymer T_m. An appropriate solvent may also be required to swell or expand the polymer if CO₂ is unable to swell the polymer. The T_g of HDPE is sub-ambient and we determined the melting point of the polymer with additive to be near 130°C (**Figure 7**). The optimal extraction temperature was therefore initially deemed to be 110°C. Any higher would not be feasible since the HDPE would melt and plug the extraction vessel. **Table VI** shows that methylene chloride just as was the case for methanol proved to be a better modifier at 15% and 20% (v/v) than at 10% (v/v) since recoveries averaged only 67.2% with the latter. Replicate HDPE samples at 100, 500, and 1000ppm doped levels of Ethanox[®] 330 were next extracted with 20% CH₂Cl₂ and analyzed. The best recovery of Ethanox[®] 330 from all three HDPE samples was approximately 80% regardless of additive level (**Table VII**). Our failure to achieve 100% recovery of Ethanox[®] 330 from the polymer matrix at all additive levels with methylene chloride at temperatures above the T_g of HDPE was puzzling. Similar results were obtained with 20% methanol-modified CO₂.

Given maximum recoveries of only 80% for each of the three HDPE sample, we decided to take a closer look at Ethanox[®] 330 extraction in the absence of the polymer. It should be noted that liquid chromatography with detection at 280 nm of the neat additive standard suggested less than 1% impurities were present; therefore, an impurity in the Ethanox[®] 330 could not account for the relatively low percent recovery from HDPE.

Numerous extraction experiments were performed on Ethanox[®] 330 spiked on Ottawa

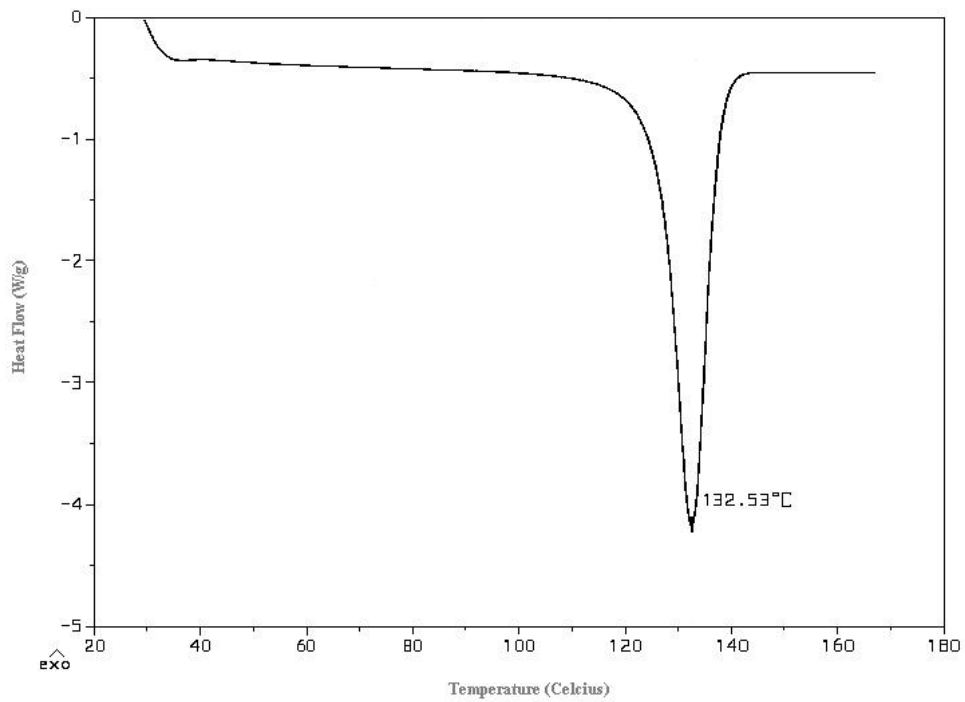

Figure 7. DSC of a milled HDPE sample containing 1000ppm Ethanox[®] 330.

Table VI. Percent recoveries of Ethanox[®] 330 from HDPE at 100ppm additive.*

Modifier level (v/v)	10%	15%	20%
Recovery (%)	67.2	82.9	79.7
STD. Dev.	1.7	8.6	6.9
RSD	2.6	10.4	8.7
Replicates	3	3	8

* Extracted with methylene chloride-modified CO₂; 350bar; Sample Size, 0.1g; Extraction Time, 70min.; Rinse Solvent, 90:5:5 (v/v/v) MeCN:MeOH:THF.

Table VII. Percent recovery of Ethanox[®] 330 from HDPE at different additive levels.

Sample number	Additive level (ppm)	% Recovery (RSD)*
1	100	81.6 (4.1)
2	500	83.0 (1.1)
3	1000	84.0 (6.1)

(n=3)

Extracted with 20% methylene chloride-modified CO₂; 350bar; Sample Size, 1.0g; Extraction Time, 70min.; Rinse Solvent, 90:5:5 (v/v/v) MeCN:MeOH:THF.

* relative standard deviation

sand to determine optimum conditions for the additive exclusive of the polymer. When the extraction chamber temperature was 110°C with either 20% methanol- or methylene chloride-modified CO₂, we noticed the appearance in our extract of a second HPLC peak at a retention time of eleven minutes in addition to Ethanox[®] 330 at eight minutes (**Figure 8**). **Figure 9** shows that the second peak was not present in the HPLC trace of either aged or fresh Ethanox[®] 330 standard dissolved in methanol. Therefore, the second peak was believed to not be due to oxidation of the standard solution prior to the spiking experiments. To confirm that the second peak was also not due to extracted impurities from the Ottawa sand, an extraction of sand by itself was performed at an extraction chamber temperature of 110 °C with 20% methylene chloride-modified CO₂. In this case the second unknown peak did not appear in the extract HPLC trace. As the extraction chamber temperature was decreased from 110°C to 80 °C, the percent recovery of Ethanox[®] 330 from sand increased (**Figure 10**). At an extraction chamber temperature of 80°C, for example, 103% recovery of Ethanox[®] 330 was achieved with 20% methanol and 101% with 20% methylene chloride. For the set of experiments at 80 °C, the unknown peak was absent from the HPLC trace (**Figure 11**), which implied that the degradation was promoted at a higher temperature and was not dependent on the presence of the polymer.

Having discovered that 80°C was the optimal extraction chamber temperature for extraction of the additive from an inert matrix, these conditions were then applied to HDPE containing Ethanox[®] 330. Unfortunately, only 10% of the additive was recovered from the polymer at a chamber temperature of 80°C. Next, a 95°C chamber temperature was investigated. In this case, 70% of the additive was recovered. From our initial studies at 110°C, we obtained only 80-85% because some decomposition of the Ethanox[®] 330 was believed to occur at 110°C. It is interesting to note that the degradate created during SFE constitutes approximately 15% of the total chromatographic peak area, and our SFE recoveries are low by 15-20%. Recall also that **Table VII** shows approximately 80% recoveries are found regardless of the doping level at 110°C and the degradate peak is found in each extract chromatogram.

Attempts were made to identify the degradate compound, as discussed in Chapter IV. The major conclusion, therefore, drawn from the study at this point is that at temperatures that

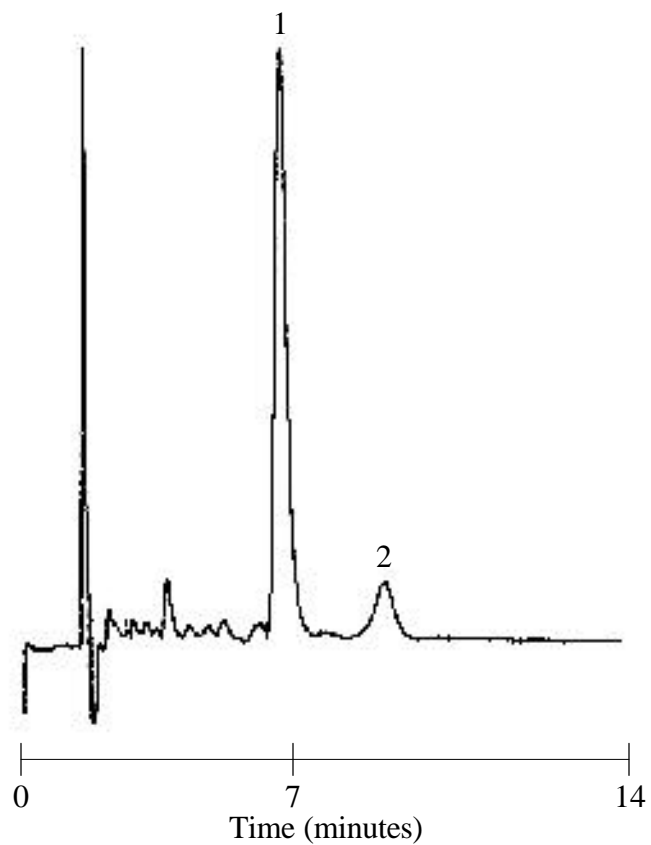

Figure 8. HPLC of an Ethanox[®] 330 polymer extract (20 μ L injection). (1) Ethanox[®] 330, and (2) degradate. Extracted with either 20% methylene chloride or 20% methanol at Chamber Temperature, 110 °C; 350bar; Extraction Time, 70min.; UV Detection, 280 nm; Rinse Solvent, 90:5:5 (v/v/v) MeCN:MeOH:THF.

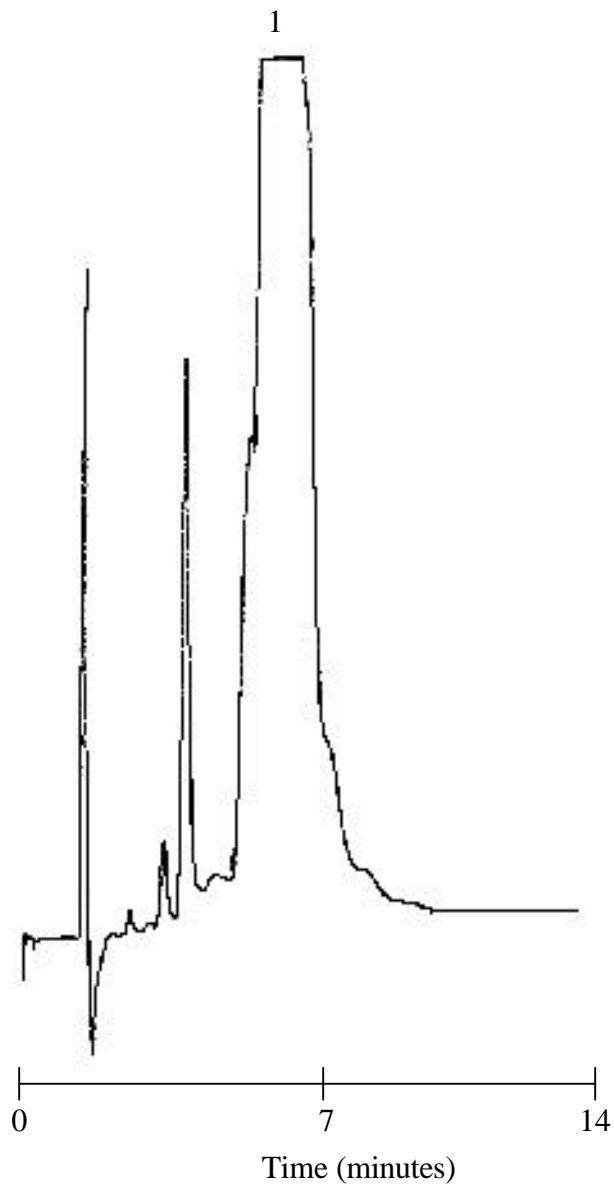

Figure 9. HPLC of an aged or fresh 1000ppm standard methanol solution of Ethanox[®] 330 (20 μ L injection). (1) Ethanox[®] 330. Mobile phase, 90:5:5 (v/v/v) MeCN:MeOH:THF; flow rate, 1.0mL/min.; Column, 4.6 x 150mm, 5 μ m dp ODS Hypersil; Guard Column, C₁₈; UV Detection, 280 nm.

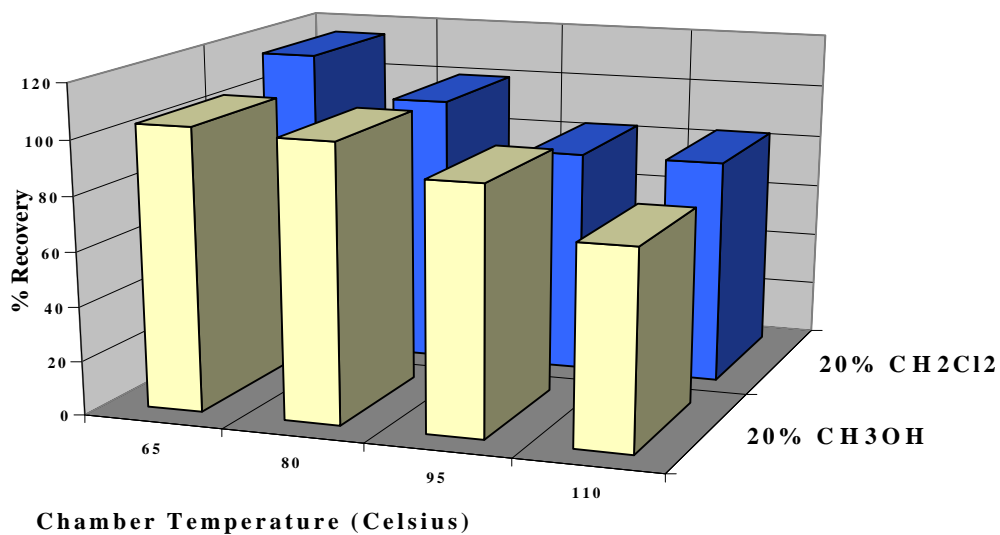

Figure 10. Effect of temperature which has been spiked on sand. Extracted with either 20% methylene chloride or 20% methanol; 350bar; Extraction Time, 70min.; Rinse Solvent, 90:5:5 (v/v/v) MeCN:MeOH:THF.

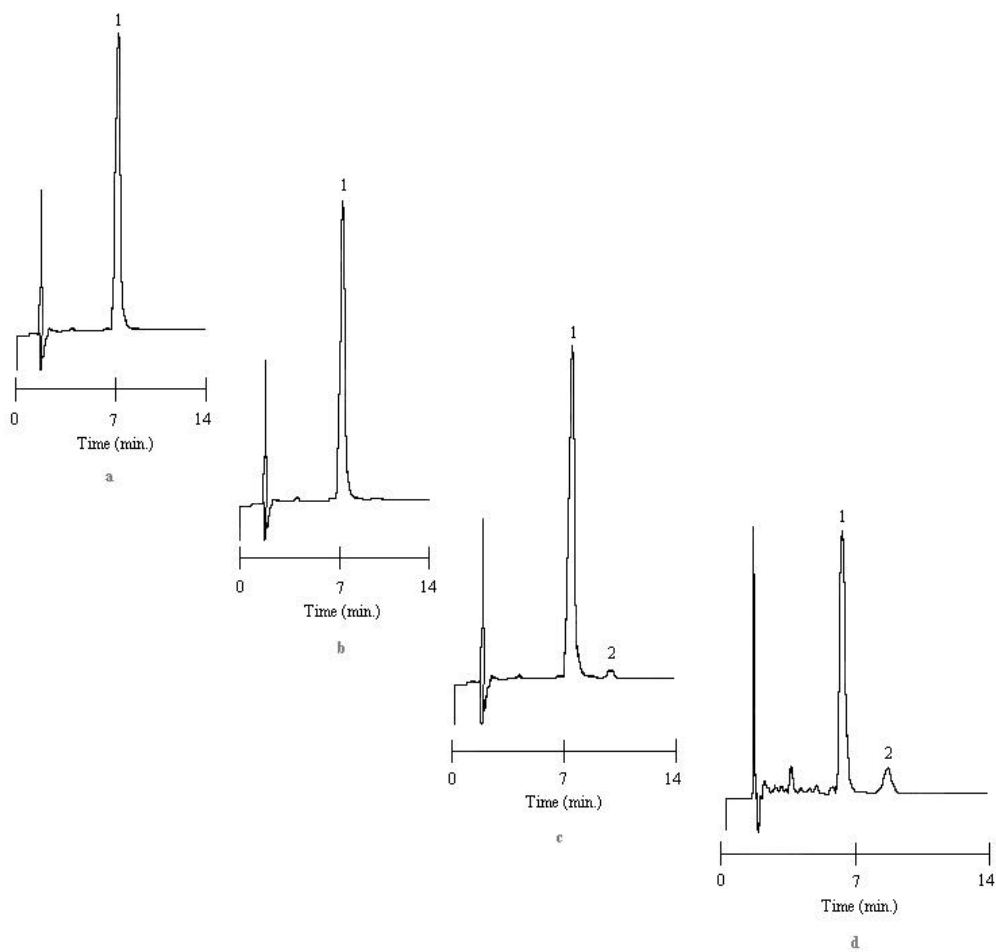

Figure 11. HPLC of an Ethanox[®] 330 polymer extract (20 μ L injection). (1) Ethanox[®] 330, and (2) degradate. (a) Chamber Temperature at 65°C, (b) Chamber Temperature at 80°C, (c) Chamber Temperature at 95°C and (d) Chamber Temperature at 110°C. Extracted with 20% methylene chloride; 350bar; Extraction Time, 70min.; UV Detection, 280 nm; Rinse Solvent, 90:5:5 (v/v/v) MeCN:MeOH:THF.

are sufficient to quantitatively extract Ethanox[®] 330 from HDPE, some decomposition of Ethanox[®] 330 ensues.

Ethanox[®] 330 Extraction in the Presence of Co-Additives

The next phase of our study involved the determination of the extraction efficiency of Ethanox[®] 330 from HDPE samples containing various levels of Ethanox[®] 330 in the presence of other co-additives, such as, other primary and secondary antioxidants. **Table VIII** lists the composition and additive level of HDPE samples studied. During the process of extracting these particular HDPE samples, we noticed that the variable restrictor was plugging-up with oligomers. In the process of cleaning the oligomers from the variable restrictor by numerous rinses with the extraction rinse solvent [90:5:5 (v/v/v) Acetonitrile:Methanol:THF] and analyzing the collected oligomer rinse sample by HPLC/UV, the oligomer rinse solution surprisingly was found to contain a significant amount of the analytes (**Figure 12**). It appeared that the oligomer was not only a co-extractant but that the trapped polymer on the nozzle occluded a significant portion of the analytes. In order to rinse the restrictor and trap more efficiently and in turn to free the analyte from the extracted polymer, methylene chloride in which the oligomers were very soluble was chosen as the effective rinse solvent. Extraction recoveries improved from 60-70% to near 100% in going to methylene chloride as the rinse solvent.

The polymer samples listed in **Table VIII** were then extracted in triplicate using the revised optimum SFE extraction technique. Recoveries are tabulated in **Table IX**. Recoveries greater than 90% were found regardless of the sample. A number of co-additives were also extracted in our study (**Figures 13-14**), however, they did not co-elute with Ethanox[®] 330. Furthermore, the co-additive combinations appeared to preserve the integrity of Ethanox[®] 330 under the SFE extraction conditions since no significant degradate peak appeared in the extract HPLC.

We were interested to determine which co-additive in particular or if the combination of co-additives were responsible for the high recoveries of Ethanox[®] 330. As shown in **Table IX**, a HDPE sample containing 500ppm of Ethanox[®] 330/1000ppm of Irgafos[®] 168/500ppm of calcium stearate gave a 95.0(6.2) percent recovery of Ethanox[®] 330: while, a 1000ppm of

Table VIII. HDPE sample composition and additive level.

Sample number	Sample
4	500ppm Ethanox [®] 330/ 1000ppm Irgafos [®] 168/ 500ppm CaSt ^a
5	1000ppm Ethanox [®] 330/ 1000ppm Irgafos [®] 168/ 500ppm CaSt
6	500ppm Ethanox [®] 330/ 1000ppm Ethanox [®] 398/ 500ppm DHT ^b
7	1000ppm Ethanox [®] 330/ 1000ppm Ethanox [®] 398/ 500ppm DHT
8	500ppm Ethanox [®] 330/ 100ppm Irganox [®] 1076/ 1000ppm Irgafos [®] 168/ 2% CaCO ₃
9	1000ppm Ethanox [®] 330/ 100ppm Irganox [®] 1076/ 1000ppm Irgafos [®] 168/ 2% CaCO ₃

^a calcium stearate

^b dihydro talcite

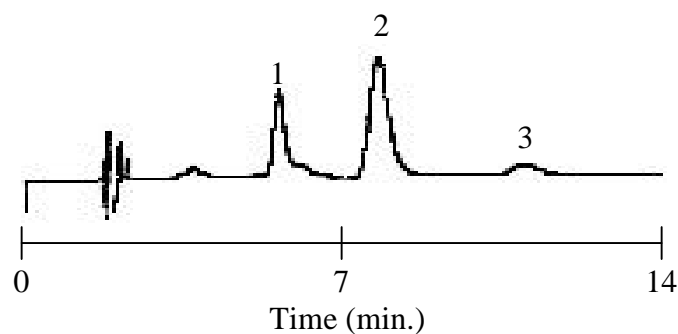

Figure 12. HPLC of a residue of extracted sample containing 1000ppm Ethanox[®] 330/ 1000ppm Ethanox[®] 398/ 500ppm DHT trapped within the oligomers. (1) Ethanox[®] 398, (2) Ethanox[®] 330, and (3) degradate (20 μ L injection). Extracted with 20% methylene chloride at Chamber Temperature, 110°C; 350bar; Extraction Time, 70min.; UV Detection, 280 nm; Rinsed from the Trap with (11mL Rinse Volume); Rinse Solvent, 90:5:5(v/v/v) MeCN:MeOH:THF.

Table IX. Total recovery of Ethanox[®] 330 from HDPE polymer samples.

Sample number	Additive level (ppm)	% Recovery (RSD)*
4	500	95.0 (6.2)
5	1000	94.0 (4.6)
6	500	95.0 (3.6)
7	1000	93.0 (4.5)
8	500	98.5 (2.2)
9	1000	103.1 (4.2)

(n =3)

Extracted with 20% methylene chloride-modified CO₂; 350bar; Sample Size, 1.0g;

Extraction Time, 70min.; Rinse Solvent, methylene chloride.

* relative standard deviation

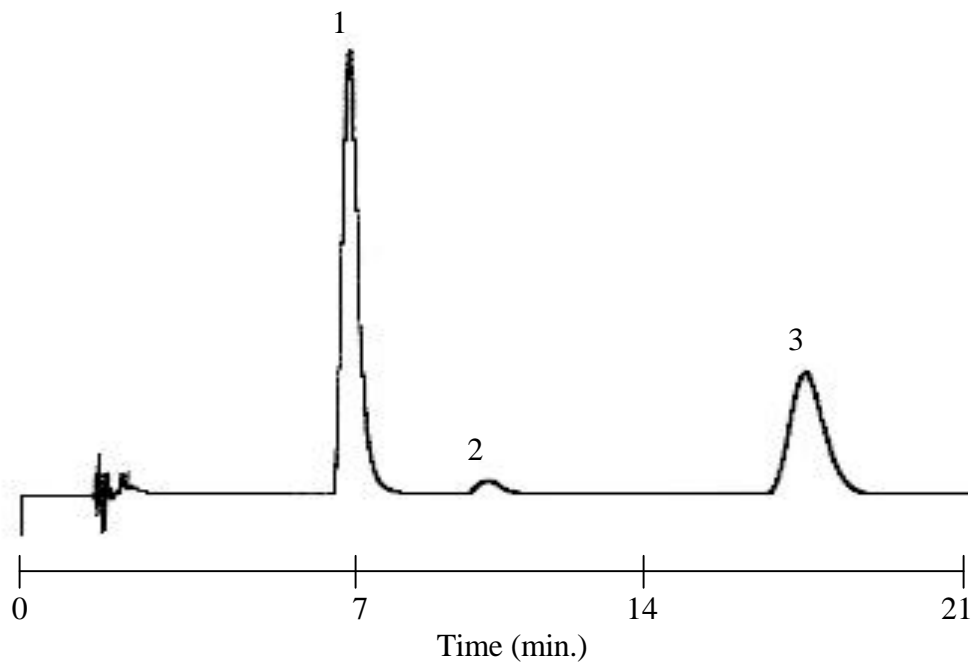

Figure 13. HPLC of an extracted polymer sample containing 500ppm Ethanox[®] 330/ 1000ppm Irgafos[®] 168/ 500ppm CaSt. (1) Ethanox[®] 330, (2) degradate, and (3) Irgafos[®] 168 (20 μ L injection). Extracted with 20% methylene chloride at Chamber Temperature, 110°C; 350bar; Extraction Time, 70min.; UV Detection, 280 nm; Rinse Solvent, 90:5:5 (v/v/v) MeCN:MeOH:THF.

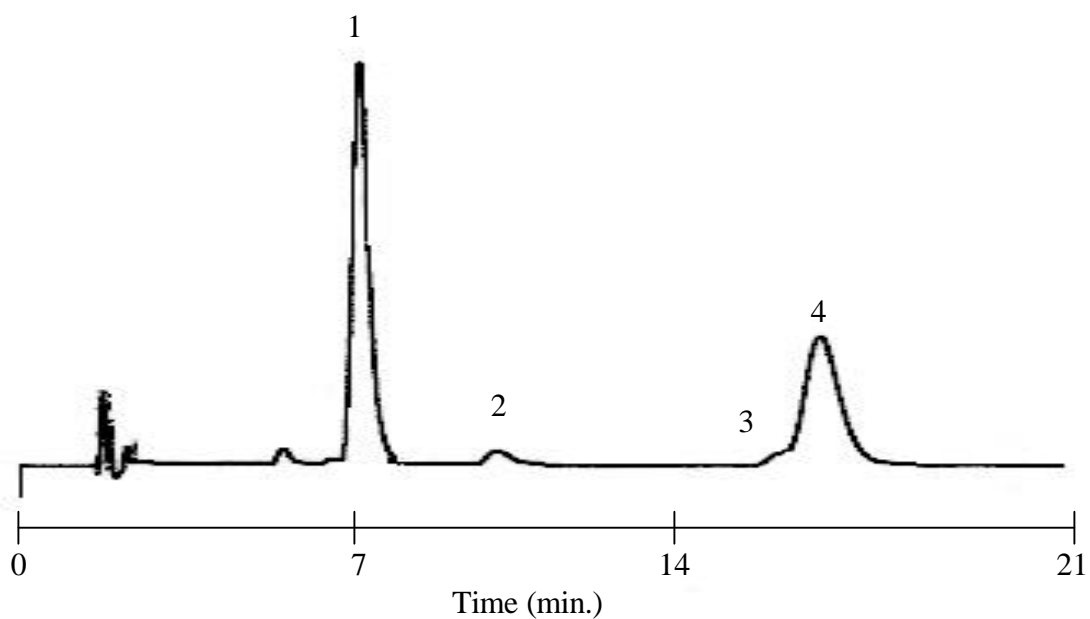

Figure 14. HPLC of an extracted polymer sample containing 500ppm Ethanox[®] 330/ 1000ppm Irgafos[®] 168/ 100ppm Irganox[®] 1076/ 2% CaCO₃. (1) Ethanox[®] 330, (2) degradate, (3) Irganox[®] 1076, and (4) Irgafos[®] 168 (20μL injection). Extracted with 20% methylene chloride at Chamber Temperature, 110°C; 350bar; Extraction Time, 70min.; UV Detection, 280 nm; Rinse Solvent, methylene chloride.

Ethanox[®] 330/1000ppm of Irgafos[®] 168/500ppm of calcium stearate gave a 94.0(4.6) percent recovery of Ethanox[®] 330. A series of HDPE samples containing various doped levels of Ethanox[®] 330 and only Irgafos[®] 168 were studied as shown in **Table X**. By eliminating the calcium stearate, we should be able to determine if the secondary antioxidant by itself or the combination of secondary antioxidant and acid scavenger lead to the high recoveries of Ethanox[®] 330. Employing the same optimum SFE extraction conditions, the average percent recovery of Ethanox[®] 330 was surprisingly 70% for these samples shown in **Table X**. This time we found that extracted oligomers precipitated from the rinse solution and occluded a significant portion of the analyte with these specific samples a greater amount of oligomer was extracted. The use of a methylene chloride rinse require its removal prior to HPLC analysis. This solvent exchange was performed by gently blowing nitrogen over the rinse solution to eliminate most of the methylene chloride. Due to the cooling afforded by the evaporating solvent, the oligomers precipitated out of solution. While this step was carried-out with all other samples that had been recovered with methylene chloride, in the case of the samples being discussed here, a greater amount of oligomers seemed to have been extracted and subsequently precipitated. As shown in **Figure 15a**, HPLC analysis of the polymer extract solution with ambient injection represented only 56.0% recovery of Ethanox[®] 330. Heating the polymer extract solution caused the oligomers to dissolve. As shown in **Figure 15b**, HPLC analysis of that same solution but now the temperature of the injection was near 50°C which gave rise to 95.0% recovery of Ethanox[®] 330. This observation provided valuable insight into treatment of extraction solutions prior to assay. The polymer samples listed in **Table X** were then extracted in triplicate using the optimum SFE extraction technique and heating (50°C) the diluted extract prior to LC analysis. Recoveries greater than 90% were found regardless of the ratio of Ethanox[®] 330 to Irgafos[®] 168 additive level (ppm) as shown in **Table XI**. The high recoveries achieved appear to be due to the presence of the secondary antioxidant Irgafos[®] 168 only. **Table XII**, shows the recoveries obtained previously with the acid scavenger and presently without the acid scavenger for comparing the performance of Irgafos[®] 168. Samples were unavailable to test the efficiency of Ethanox[®] 398 and Irganox[®] 1076. No doubt Ethanox[®] 398 is just as effective as Irgafos[®] 168

Table X. HDPE sample composition and additive level.

Sample number	Sample
10	100ppm Ethanox [®] 330/ 300ppm Irgafos [®] 168
11	500ppm Ethanox [®] 330/ 1000ppm Irgafos [®] 168
12	1000ppm Ethanox [®] 330/ 1000ppm Irgafos [®] 168

Table XI. Recovery of Ethanox[®] 330 from HDPE polymer samples.

Sample number	Additive level (ppm)	% Recovery (RSD)*
10	100	97.3 (1.6)
11	500	93.0 (9.8)
12	1000	95.0 (3.7)

(n=3)

Extracted with 20% methylene chloride-modified CO₂; 350bar; Sample Size, 1.0g;

Extraction Time, 70min.; Rinse Solvent, methylene chloride.

* relative standard deviation

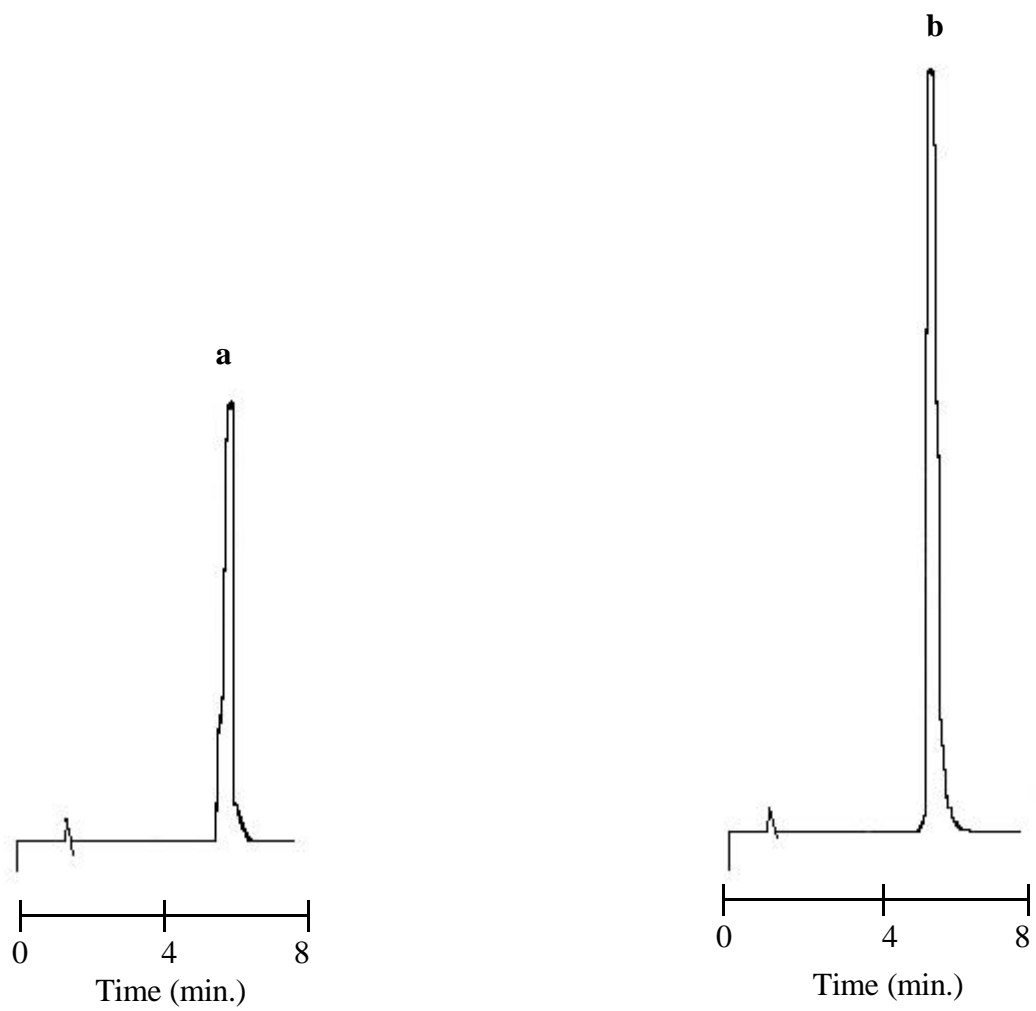

Figure 15. HPLC of extracted polymer sample. (a) injection at room temperature, and (b) injection at 50°C. Extracted with 20% methylene chloride-modified CO₂; 350bar; Extraction Time, 70min.; Rinse Solvent, methylene chloride.

Table XII. Comparison of recovery of Ethanox[®] 330 from HDPE polymer samples in the presence of Irgafos[®] 168 with and without acid scavenger.

Sample number	Additive level (ppm)	% Recovery (RSD)*
No acid scavenger	500	95.0 (6.2)
acid scavenger	500	93.0 (9.8)
No acid scavenger	1000	94.0 (4.6)
acid scavenger	1000	95.0 (3.7)

(n=3)

Extracted with 20% methylene chloride-modified CO₂; 350bar; Sample Size, 1.0g;

Extraction Time, 70min.; Rinse Solvent, methylene chloride.

* relative standard deviation

since samples 6-7 did not contain Irgafos[®] 168, yet, recoveries of Ethanox[®] 330 were quantitative.

Conclusion

In conclusion, a low extraction chamber temperature is needed to ensure the stability of Ethanox[®] 330 and a high extraction chamber temperature is required to achieve high extraction efficiency. Therefore, the optimal extraction efficiency of Ethanox[®] 330 was approximately 80% regardless of the additive concentration at 110°C. After discovering the optimal extraction temperature, rinsing the Octadecylsilica solid phase trap with methylene chloride improved the recovery efficiency. A high recovery of greater than 90% can be achieved in all cases when Ethanox[®] 330 is in the presence of a secondary antioxidant. We also determined that even greater recoveries of Ethanox[®] 330 can be achieved when in the presence of more than one secondary antioxidant. The secondary antioxidants appear to improve the thermal stability of Ethanox[®] 330.

Chapter III

Mass Spectrometric Determination of Degradate Peak

Introduction

We were interested to learn the identification of the degraded species that was observed in the HPLC trace of the Ethanox[®] 330 extract in the absence of other antioxidants. Initially, we attempted to perform liquid chromatography-mass spectrometry (LC-MS) with electrospray ionization and atmospheric-pressure chemical ionization, but this technique was quickly abandoned because of poor sensitivity. In order to obtain the desired information, HPLC fractions of the degradate peak were next obtained and subjected to mass spectral analysis by direct insertion probe analysis. This chapter will describe our efforts in this regard.

Experimental

The inlet system employed was a direct-inlet probe (DIP). The capillary reservoir at the end of the probe holds the sample. The sample can be in either solid or liquid form. The samples analyzed were in acetonitrile solution. In order to concentrate the sample, we applied a few microliters at a time onto the probe and then evaporated the solvent by heating the tip of the probe. Once the sample had been concentrated and a few more microliters were placed in the capillary, the probe was inserted into the mass spectrometer. The probe tip, when inserted, is located close to the ionization chamber. The tip of the probe was heated from 20°C to 400°C at a ramp rate of 50°C/min in order to vaporize the sample. The temperature was held at 400°C for 5 minutes. Mass spectrometric determinations were obtained in single quadrupole mode on a Fisons VG Quattro Mass Spectrometer (Manchester, U.K.). The optimum mass spectrometer parameters were:

Electron Energy:	100eVolts
Ionization Mode:	Chemical Ionization
Reagent Gas:	methane
Emission Current:	503MicroAmps

Repeller:	12Volts
Lens 1:	170Volts
Lens 2:	15Volts
Lens 3:	154Volts
Lens 4:	262Volts
Source Temp.:	200°C
Scan Time:	4.10sec
Ion Energy:	-3.4Volts
Ion Energy Ramp:	0Volts
LM Resolution:	11.9
HM Resolution:	12.1
Entrance Filter:	30.1Volts
Lens 5:	198Volts
Lens 6:	-1Volts
First Multiplier:	622Volts
Second Multiplier:	not applicable

Results and Discussion

The first attempted analysis of the materials giving rise to the degradate peak and Ethanox[®] 330 peak was by on-line liquid chromatography-mass spectrometry (LC-MS). Both atmospheric-pressure chemical ionization (APCI) and electrospray ionization (ESI) were employed. In both techniques, insufficient information was obtained, since our HPLC fractions were believed to be low in concentration.

In an effort to overcome the obstacle of low concentration of fractions, a direct-inlet probe (DIP) system was employed. There are two advantages offered by using DIP for samples in low concentration. For one, the direct-inlet approach allows the entire sample to be placed close enough to the ionization chamber such that sufficient sample vapor enters the ionization chamber upon heating (26,27). This minimizes the distance that the sample vapors must travel to

reach the ionization chamber. Secondly, we can concentrate the sample on the probe tip. Low concentration samples are thus not a limitation with DIP. Unlike in LC-MS or GC-MS where a portion of the sample maybe lost in the tubing before it reaches the mass spectrometer, the entire sample enters the mass spectrometer in DIP. This technique is often called a batch-inlet system, since the mass spectrometer is exposed to all the components of the sample simultaneously. As the probe is ramped up in temperature, the components are first separated by their volatility prior to mass spectral analysis. Basically, at this point we are boiling the components off the probe.

Liquid secondary-ion mass spectrometry (LSIMS), electron-impact ionization (EI), and chemical ionization (CI) were next employed. We initially analyzed the mass spectrum of a standard solution of Ethanox[®] 330 in order to determine the optimum ionization technique for DIP analysis. When we employed LSIMS, adducts apparently formed possibly between the analyte and the glycerol matrix or sodium, which is present on the glass. As shown in **Figure 16a**, the ions of m/z 483, 546, 575, 638, and 778 are various possible unknown adducts. We did not observe an ion at m/z 775, which is the molecular weight for Ethanox[®] 330. We were unable to avoid the apparent formation of adducts, since a matrix is required by LSIMS to “hold” the analyte during ionization. Adduct formation is known to occur when the high-energy bombarding particles used to excite the analyte also cause nuclear excitation of some matrix molecules (27). As shown in **Figure 16b**, the ions of m/z 461, 553, 645, 738, and 829 are known to be due to the glycerol matrix, since we ran a blank of the glycerol and saw these peaks. Since the data for a standard were not interpretable, we reasoned that when analyzing an unknown analyte, such as the degradate, distinguishing between analyte and adduct fragmentation would be difficult. Electron-impact ionization (EI) was next attempted on Ethanox[®] 330. As shown in **Figure 17**, we can observe the molecular ion at m/z 775 for Ethanox[®] 330 and the base peak at m/z 219. Fragmentation was much more easily interpreted with EI data than with LSIMS. Fragmentation under EI conditions yields structural information, however, CI is used mostly for molecular mass information (27). It was felt that EI used alone would not supply enough molecular mass information to determine the degradate.

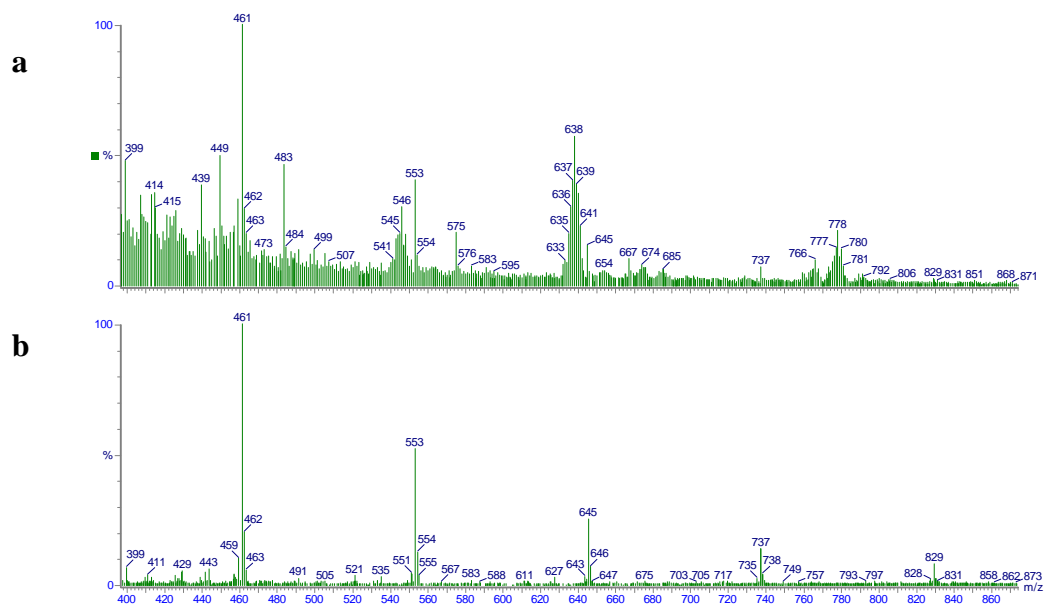

Figure 16. LSIMS+ of Ethanox[®] 330 in a glycerol matrix. (a) Ethanox[®] 330 in glycerol, and (b) glycerol blank. Ion Beam, cesium; Matrix, glycerol; Voltage, 20KV; Temperature, ambient.

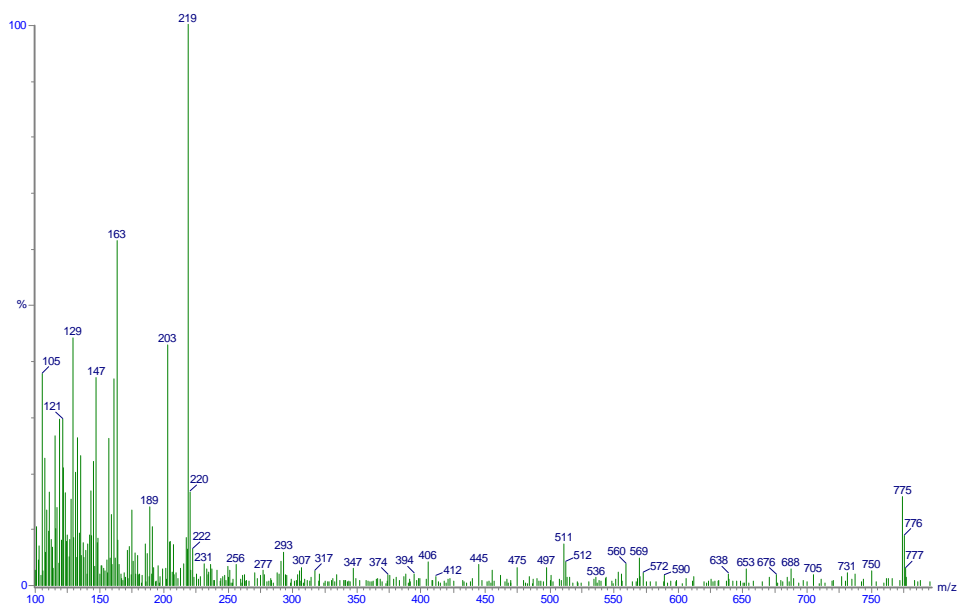

Figure 17. EI+ of Ethanox[®] 330. Electron Energy, 70eVolts; Emission Current, 200MicroAmps; Source Temp., 200°C; Scan Time, 4.10sec.

Chemical ionization (CI) provided the most molecular weight information for Ethanox[®] 330 as shown in **Figure 18**. We can clearly observe the molecular ion of m/z 775 for Ethanox[®] 330 and the fragmentation ions of m/z 570, 556, 512, and 219, which were present but not shown in **Figure 18**.

Based on this preliminary study, we analyzed the eluent giving rise to the degradate peak, as shown in **Figure 19**. We observed two major ions of m/z 556 and 509. At this point, we were unsure which ion represented the molecular ion of the degradate. In order to obtain more information on one ion at a time, we performed a background subtraction of the ion at m/z 509 (**Figure 20**). We were left with the ion of m/z 556. Since the ion of m/z 556 can be envisioned to be a fragment of Ethanox[®] 330 and m/z 509 is not a reasonable fragment of Ethanox[®] 330, it is then possible to assume at this point that if Ethanox[®] 330 does in fact degrade it would be more logical that the degradate component would have a molecular ion shared with Ethanox[®] 330.

Next, we analyzed a whole HDPE extract containing the degradate and Ethanox[®] 330 by scanning for the masses of m/z 509, 556, and 775 observed previously. As shown in **Figure 21**, we observed the presence of three separate components as the temperature was ramped up. Remember, components in this experiment are separated by volatility. We concluded from the data the presence of three separate components, since ions at m/z 509, 556, and 775 appeared at different temperatures. As shown in **Figure 21**, there is the presence of two separate components with the same molecular ion or molecular weight of m/z 556. The first ion at m/z 556 appears at 2.3min. and it is separated from the second ion at m/z 556 which occurs at 2.7min. The second ion at m/z 556 at 2.7min. is apparently a fragmentation of the molecular ion of m/z 775, which is Ethanox[®] 330. The ion at m/z 219 (base peak), which is not shown in **Figure 21**, is also a fragment of Ethanox[®] 330. Employing an equation taken from Watson (26, 27), we can calculate the number of rings and double bonds for the species at m/z 219 (base peak) and 556 (**Figure 22**). **Figure 23**, illustrates possible chemical structure from the number of rings and double bonds calculated for the molecular ions of m/z 219 and 556. Attempts were made to determine the chemical structure of the ion at m/z 509, however, the component of m/z 509 was not related to Ethanox[®] 330. The chemical structure of m/z 509 is currently unknown. However the

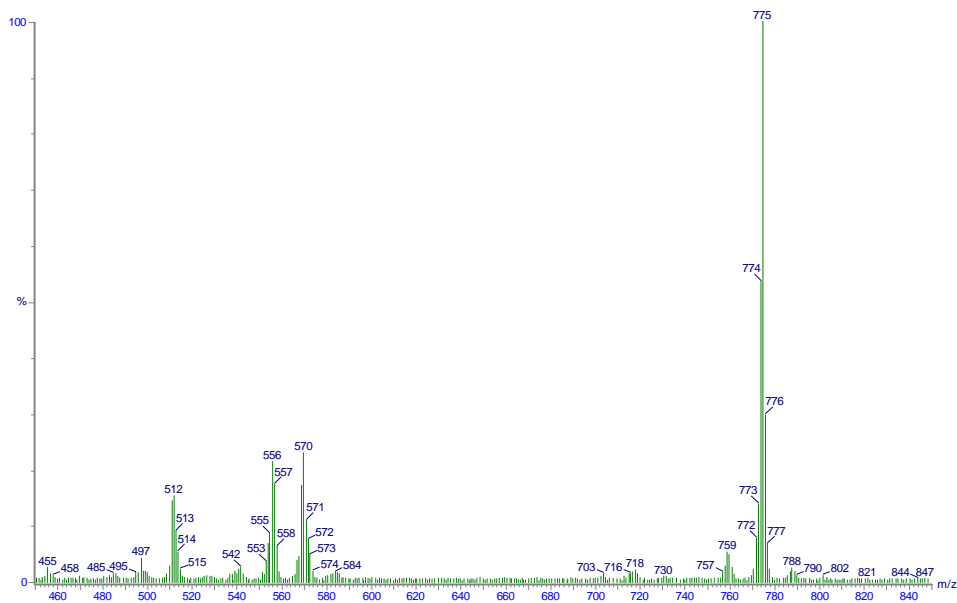

Figure 18. CI+ of Ethanox[®] 330. Electron Energy, 100eVolts; Reagent Gas, methane; Emission Current, 503MicroAmps; Source Temp., 200°C; Scan Time, 4.10sec; Probe Temp., 20°C to 400°C; Ramp Rate, 50°C/min.

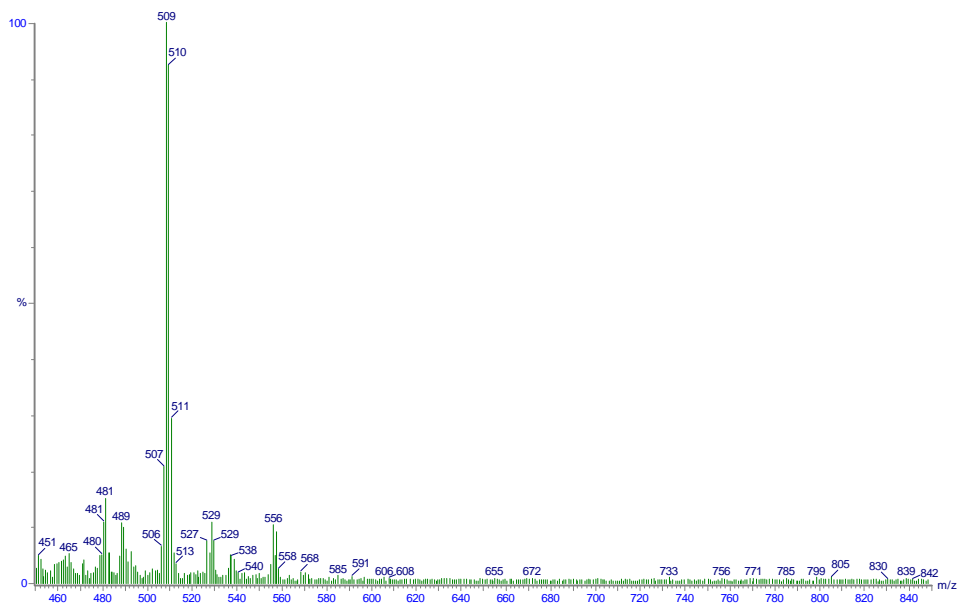

Figure 19. CI+ of degradate fraction. Electron Energy, 100eVolts; Reagent Gas, methane; Emission Current, 503MicroAmps; Source Temp., 200°C; Scan Time, 4.10sec; Probe Temp., 20°C to 400°C; Ramp Rate, 50°C/min.

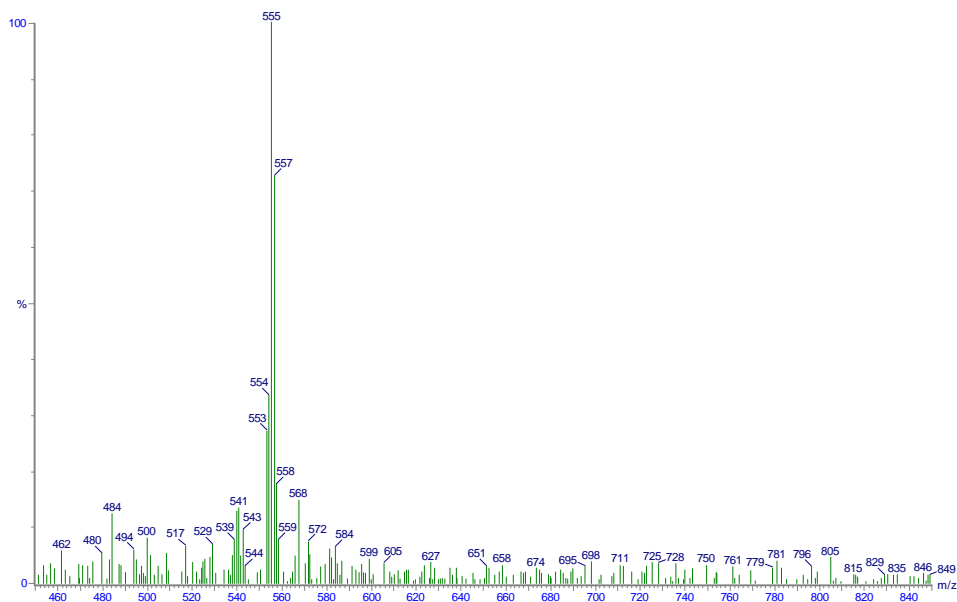

Figure 20. CI+ of degradate fraction with the subtraction of the molecular ion of m/z 509. Electron Energy, 100eVolts; Reagent Gas, methane; Emission Current, 503MicroAmps; Source Temp., 200°C; Scan Time, 4.10sec; Probe Temp., 20°C to 400°C; Ramp Rate, 50°C/min.

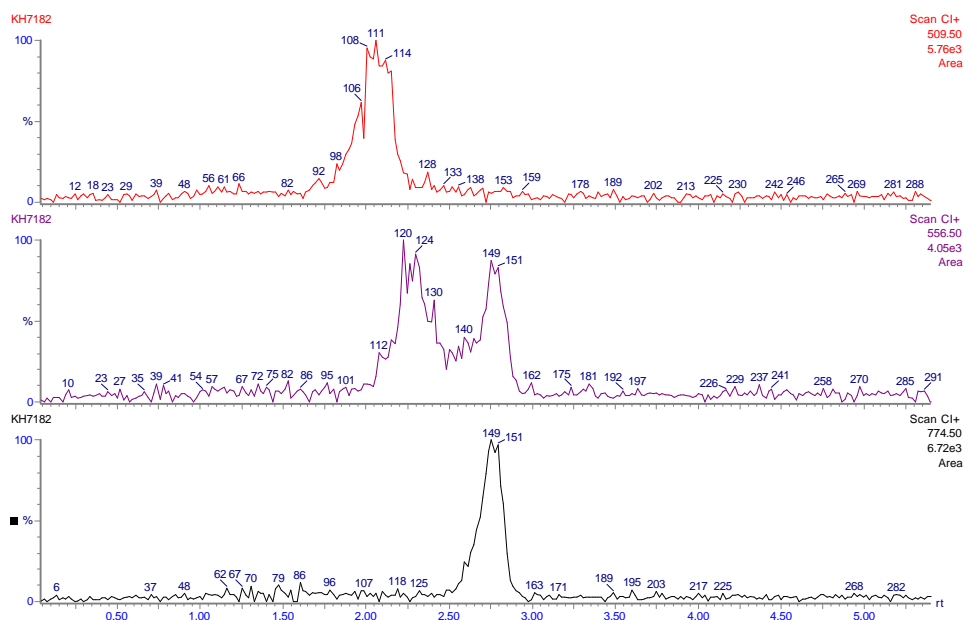
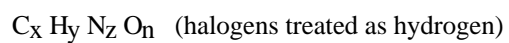

Figure 21. CI+ of a HDPE extract containing EthanoX[®] 330 and the degraded species. Electron Energy, 100eVolts; Reagent Gas, methane; Emission Current, 503MicroAmps; Source Temp., 200°C; Scan Time, 4.10sec; Probe Temp., 20°C to 400°C; Ramp Rate, 50°C/min.

Formula for calculation of # of rings and double bonds:



$$R + db = x - y/2 + z/2 + 1$$

m/z 556

$$C_{39}H_{56}O_2 \quad R + db = 39 - 56/2 + 1$$

$$= 12$$

x = 39 9 double bonds
y = 56 3 rings
z = 0

Could be the structure:

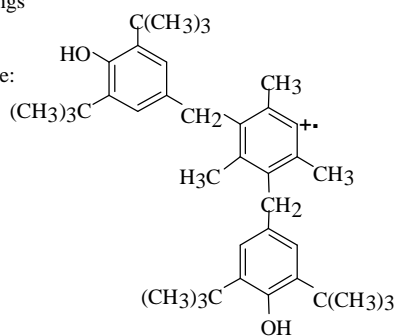

m/z 219

$$C_{15}H_{23}O \quad R + db = 15 - 23/2 + 1$$

$$= 4.5 \text{ (round off - low)}$$

x = 15 3 double bonds
y = 23 1 ring
z = 0

Could be the structure:

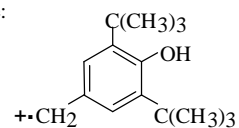
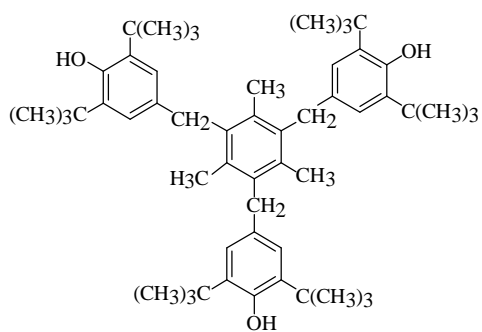

Figure 22. Formula calculations for the number of rings and double bonds.

Molecular Ion:

Ethanox 330

mw = 775



Fragment:

m/z 556

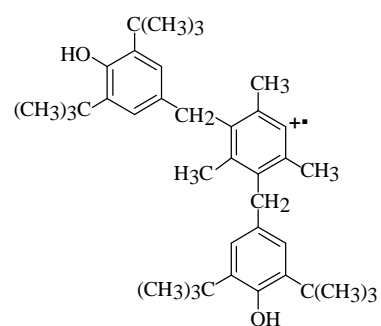

Fragment:

m/z 219

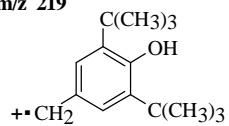

Figure 23. Chemical structure of the possible degradate.

ions of m/z 556 and 219 are related to Ethanox[®] 330.

Conclusion

It appears that we have possibly identified the chemical structure of the degraded species (**Figure 23**) and determined its molecular weight to be 556. The exact reason for the cleavage of one phenolic group from Ethanox[®] 330 is unknown.

References

1. Becker, R.F.; L.P.J. Burton and S.E. Amos, Polypropylene Handbook. Ed. by Edward P. Moore, Jr. Montell U.S.A., Inc. 1996.
2. Ainsworth, S.J., *C & EN*. August 1992, 34-55.
3. Elmore, R.H. and J.L. Hedrick, Hewlett Packard Application Note 228-281, June 1994.
4. Hewlett Packard Manual, Nov. 1990.
5. Taylor, L.T. Supercritical Fluid Extraction. John Wiley & Sons, Inc. 1996.
6. Taylor, L.T. Introduction to Supercritical Fluid Extraction. R&D Magazine, 1995.
7. Hedrick, J.L.; L.J. Mulcahey and L.T. Taylor, *Mikrochimica Acta*. 1992, **108**, 115-132.
8. Lynch, T.P., Supercritical Fluid Extraction. ed. by E.R. Adhlard. Elsevier Science B.V., 1995.
9. Dilettato, D.; P.J. Arpino, K. Nguyen and A. Bruchet, *J. High Resol. Chrom.* 1991, **14**, 335-342.
10. Monteiro, M.G. and V.F. Matos, *Int. GPC Symp.* '87. 1987, 437-446.
11. Yagoubi, N.; A. Baillet, C. Murana and D. Baylocq-Ferrier, *Chromatographia*. 1993, **35**, 455-458.
12. Schabron, J.F. and L.E. Fenska, *Anal. Chem.* 1980, **52**, 1411-1415.
13. Esperidiao, M.C.A. and F. Galembeck, *Eur. Polym. J.* 1993, **29**, 993-997.
14. Ashraf-Khorassani, M.; D.S. Boyer and J.M. Levy, *J. Chromatogr. Sc.* 1991, **29**, 517-521.
15. Lou, X.W.; H.G. Janssen and C.A. Cramers, *J. Microcol. Sep.* 1995, **7**, 303-317.
16. Tikuisis, T. and M. Cossar, *Antec'93*. 1993, 270-276.
17. Braybrook, J.H. and G.A. Mackay, *Polym. Intern.* 1992, **27**, 157-164.
18. Engelhardt, H.; J. Zapp and P. Kolla, *Chromatographia*. 1991, **32**, 527-537.
19. Clifford, A.; K. Bartle and S. Zhu, *Anal. Proc. Anal. Comm.* 1995, **32**, 227-230.
20. Ashraf-Khorassani, M. and J.M. Levy, *J. High Resol. Chrom.* 1990, **13**, 742-747.
21. Hayashi, H. and S. Matsuzawa, *J. Appl. Polym. Sc.* 1986, **31**, 1709-1719.
22. di Pasquale, G.; L. Giambelli, A. Soffientini and R. Paiella, *J. High Resol. Chrom. & Chrom.*

- Comm.* 1985, **8**, 618-622.
23. Schabron, J.F., *J. Liq. Chrom.* 1982, **7**, 1269-1276.
 24. Lichtenthaler, R.G. and F. Ranfelt, *J. Chrom.* 1978, **149**, 553-560.
 25. Haney, M.A. and W.A. Dark, *J. Chrom. Sc.* 1980, **18**, 655-659.
 26. Watson, T.J. Introduction to Mass Spectrometry. 2nd ed. New York: Raven Press, 1985.
 27. Watson, T.J. Introduction to Mass Spectrometry. 3rd ed. New York: Lippincott-Raven, 1997.

Vita

The author, Angela Marie Moniz Pinto was born to Mr. and Mrs. Jose Pinto on June 22, 1971 in Newark, New Jersey as a first generation American citizen. Leonilde and Jose Pinto were born in Portugal. Angela attended High School at Mother Seton Regional in Clark, New Jersey, and attended College at Fairleigh Dickinson University in Madison, New Jersey, where she earned her Bachelors of Science in Chemistry in May of 1995. Following graduation, she moved to Blacksburg, Virginia to attend graduate school at Virginia Tech in the hopes of earning a Master of Science degree in Analytical Chemistry. The author will remain in Virginia Tech upon receiving her M.S. degree to earn her Doctorate in Analytical Chemistry, under the advisement of Dr. Larry T. Taylor.