

Technique for Repeatable Hyperosmotic Blood-Brain Barrier
Disruption in the Dog

by

Britt Wayne Culver

Thesis submitted to the Faculty of the Virginia Polytechnic Institute and
State University in partial fulfillment to the requirements for the degree of

Master of Science
In
Veterinary Clinical Science

Karen Inzana, Chair
Gregory Troy
Jeryl Jones
Bernard Jortner

June 16, 1997
Blacksburg, Virginia

Keywords: Neurology, Veterinary Medicine, Interventional Radiology,
Computed Tomography,
Copyright 1997, Britt Wayne Culver

Technique for Repeatable Hyperosmotic Blood-Brain Barrier Disruption in the Dog

Britt Wayne Culver

Abstract

Reversible hyperosmotic blood-brain barrier disruption (BBBD) has been used in pharmaceutical research as well as human medicine to enhance drug delivery across the blood-brain barrier. However a technique for repeatable BBBD in the canine has not been described. This study describes a repeatable technique for BBBD in the dog and evaluates the clinical and morphological effects of BBBD.

Using fluoroscopic guidance, an arterial catheter was directed into the internal carotid artery via the femoral artery in ten dogs. BBBD was achieved in 5 dogs using 25% mannitol while 5 control dogs received only saline. Following recovery, dogs were monitored for clinical signs before a second, non-survival procedure was performed 2-3 weeks later. BBBD was estimated using CT densitometry as well as Evan's blue staining on post-mortem exam. Histopathological evaluation of the brain was performed on all dogs.

Seven dogs completed the study. Two treatment dogs were lost after the first infusion with deteriorating neurologic function attributed to CNS edema and increased intracranial pressure. One control dog was lost due to vessel wall damage during catheterization. The remaining dogs exhibited only transient neurologic, ocular, and vasculature injury. Successful BBBD was demonstrated in all treatment dogs as evidenced by CT and Evan's blue staining. Histopathological evaluation revealed multifocal areas of infarction in all dogs indicating refinement of the technique is needed.

This study shows that repeatable disruption the BBB in the dog is possible and opens the way for further investigations of BBBD using the dog as a model.

This work was funded by a grant from the Virginia Veterinary Medicine Association.

Dedication

I dedicate this work to my family.

To my parents whose love and support have been the driving force behind all my endeavors. They held me high when I succeeded, and picked me up when I fell. Their devotion to their children gave my brother and me the self-confidence needed to achieve all we desired. A more nurturing environment could not have been possible. Thank You Mom and Dad.

To my wife and best friend who has been at my side constantly during my veterinary education. She has shared in all my joys and sorrows and is truly my other half. I love you Brenda.

Finally, to my new son Barron. He has supplied me with a new set of priorities and has given me more happiness than I thought possible. Barron's life has become my greatest undertaking. I love you son.

Acknowledgments

I would like to thank the following people for all of their hard work and support during this project.

Dr. Karen Inzana was the driving force behind my project. She gave me the idea for the project and helped me every step of the way. All the hard work she put into the project is much appreciated. I could not have asked for a better graduate advisor or committee chairman.

Dr. Greg Troy as my resident advisor helped me juggle all my duties and responsibilities. He kept things moving forward at all times. I am a better person for having worked with him both as a scientific investigator as well as a veterinarian.

Dr. Jeryl Jones put in long hours during my project. Without her devotion and expertise the project would not have been possible.

Dr. Bernard Jortner made time in a very hectic schedule to help me with all the pathological evaluations. He patiently taught me the basics of neuropathology.

Dr. Robert Kroll donated his time and expertise to teach me the technique. He flew across the country to help with the pilot study and was always available for consultation. Without his help, this project would not have been possible.

Dr. Brenda Culver put in as many hours as I did in carrying out this project. She supplied not only technical support but also helped in the design of the project.

Susie Ayers was the technical expert behind all of the diagnostic imaging. She came in early every morning to keep things running smoothly.

Megan Irby and Rachel Bethard are the best laboratory technicians I have seen. They kept the project organized and were always two steps ahead of me. They will be missed in this college.

Table of Contents

Chapter 1: The Blood-Brain Barrier: Clinical Implications

Abstract	1
Introduction	2
History	2
Structure and function	2
Transport	4
Glucose Transport	5
Amino Acid Transport	5
Peptide Transport	6
Disorders of the Blood-Brain Barrier	6
Getting Past the Barrier	8
Routes and Methods of Administration	9
Non-Pharmaceutical Methods	9
Tailored and Carrier Drugs	9
Mechanical Disruption	10
Conclusion	11

Chapter 2: Repeatable Hyperosmotic Blood-Brain Barrier Disruption in The Dog: Technique and Complications

Abstract	12
Introduction	13
Methods and Materials	14
Animals	14
Experimental Design	14
Anesthesia	14
Catheterization Technique	15
Disruption	15
CT Evaluation	17
Survival Study	18
Non-Survival Study	18
Results	18
Catheterization Technique	18
Complications of Catheterization	19
Complications of the Infusion	20
CT Densitometric Data	22
Evan's Blue Score	24
Discussion	24

Chapter 3: Histopathological Changes in the Dog Brain After Repeat Hyperosmotic Blood-Brain Barrier Disruption

Abstract - - - - -	27
Introduction - - - - -	28
Methods and Materials - - - - -	29
Animals- - - - -	29
Experimental Design - - - - -	29
Quantification of Disruption - - - - -	29
Histopathological Evaluation - - - - -	30
Results - - - - -	30
Catheterization - - - - -	30
Evan’s Blue Staining - - - - -	30
Gross Lesions - - - - -	32
Histopathological Findings - - - - -	32
Discussion - - - - -	35

Chapter 4: Future Directions

Refining the Technique - - - - -	38
Clinical Use of BBBD - - - - -	38
Other BBB Disruption Strategies - - - - -	39
Conclusion	
References - - - - -	41
Vita - - - - -	52

Figures and Tables

Chapter 1

Table 1-1	Comparison of blood-brain barrier and systemic endothelial cells	3
Figure 1-1	Anatomical basis of blood-brain barrier	3
Table 1-2	Disorders that disrupt the blood-brain barrier	7
Table 1-3	Methods of circumventing the blood-brain barrier	8

Chapter 2

Figure 2-1	Seldinger Technique	16
Figure 2-2	Angiogram of circle of Willis	16
Figure 2-3	Regions of interest CT images	17
Table 2-1	Procedural complications	19
Table 2-2	Neurologic side-effects of BBBB	21
Table 2-3	Visual findings	21
Table 2-4	CT density values	22
Table 2-5	Evan's blue scoring	24

Chapter 3

Table 3-1	Gross lesions	31
Figure 3-1	Evan's blue staining	31
Figure 3-2	Hemorrhage and necrosis of rostral caudate nucleus	32
Figure 3-3	Acute subarachnoid hemorrhage at thalamic nuclei	32
Table 3-2	Histopathological Findings	33
Figure 3-4	Acute hemorrhagic necrosis of caudate nucleus	33
Figure 3-5	Chronic hemorrhagic necrosis of caudate nucleus	34
Figure 3-6	Acute necrosis of the corticomedullary junction	34
Figure 3-7	Chronic necrosis of the corticomedullary junction	35

Chapter 1: The Blood-Brain Barrier: Clinical Implications

ABSTRACT

The interstitium of the brain is separated from its blood supply by a barrier referred to as the blood brain-barrier (BBB). The BBB is formed primarily by brain capillary endothelial cells, which are fused together by tight junctions and surrounded by a basement membrane and astrocytic foot processes. This cellular barrier prevents the diffusion of certain types of molecules into or out of the brain parenchyma. A variety of disorders can result in loss of integrity of the BBB. Malfunction of the BBB may lead to such conditions as cerebral edema as well as allow penetration of pathogens and neurotoxic substances into the central nervous system. A clear understanding of the pathogenesis of these disorders is crucial to their treatment. While the BBB prevents diffusion of toxic substances into the brain, it also prevents entry of therapeutic agents required in treating intracranial diseases. Different drug delivery methods have been studied in an effort to achieve adequate intracranial drug concentrations. All of these methods have advantages and disadvantages. This chapter discusses some of the more promising of these methods and future direction in the treatment of intracranial disease.

INTRODUCTION

Homeostatic control of the neuronal environment is essential for optimal brain function and can only be achieved by strict regulation of the passage of substances between peripheral circulation and the brain. Environmental changes in extracellular ion concentration, neurotransmitters, growth factors, and other chemicals can cause dementia, stupor, coma, and death. The blood-brain barrier (BBB) is a cellular barrier that forms an envelope around the brain parenchyma, and limits entry of potentially toxic substances in the systemic circulation while maintaining homeostatic control of the brain's internal environment. While protective in nature, the BBB also hampers the ability to deliver drugs necessary to treat a number of intracranial diseases. This paper reviews the concept of the BBB, diseases that result in its malfunction, and strategies used in the treatment of intracranial disease.

HISTORY

The concept of a BBB arose at the turn of the century with the observation that certain vital dyes, when injected intravenously, stained all body organs except the brain. It was originally thought that the brain had lower affinity for these dyes than other organs. However, this explanation proved incorrect as these same dyes, when injected into the subarachnoidal space, readily stained the brain parenchyma without entering the blood stream. Further support for a BBB came with the discovery that certain compounds, such as bile acids, were not neurotoxic when injected intravenously but caused seizures and coma when injected directly into the brain. It was postulated that the BBB was a function of endothelial cells. This hypothesis was not well accepted until the advent of the electron microscope. Subsequent studies using the electron microscope and traceable proteins, such as horseradish peroxidase, revealed that the BBB was indeed formed from the endothelium of brain capillaries [1-3]. Subsequent studies have better defined and revealed ways to clinically manipulate the BBB.

STRUCTURE AND FUNCTION

Some important differences exist between the ultrastructure of brain blood vessels and systemic blood vessels (Table 1-1) [4-6]. In the brain, endothelial cell membranes are fused into tight junctions, forming continuous, uninterrupted tubes with no gaps or channels (Figure 1-1). These endothelial tight junctions are the anatomical site of the BBB and the limiting factor that prevents passage of most chemical substances [7-9].

Table 1-1 Comparison of Blood-Brain Barrier and Systemic Endothelial Cells		
<u>Property</u>	<u>BBB endothelium</u>	<u>Systemic endothelium</u>
Tight junctions	Yes	No
Fenestrae	Few	Abundant
Electrical resistance	High	Low
Perivascular space	Small	Large
Mitochondrial concentration	High	Low
Astrocytic envelopment	Yes	No
Specific enzyme systems (e.g. monoamine oxidase; alkaline phosphatase)	Yes	No
Glucose transport (GLUT 1)	Yes	No
Specific protein receptors (e.g. transferrin; insulin)	Yes	No

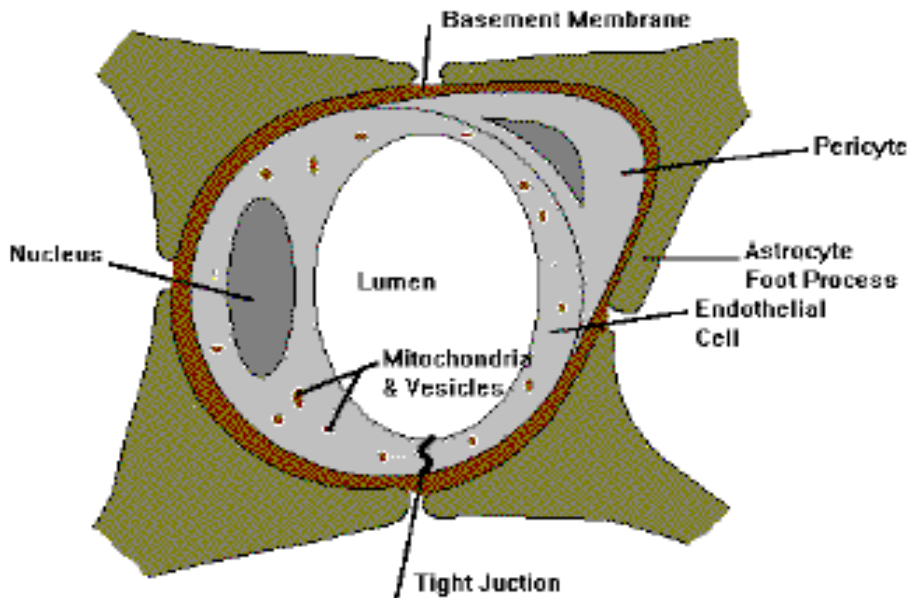

Figure 1-1: Anatomical basis of the blood-brain barrier. Note the tight junction and envelopment of the vessel by astrocytic foot processes

Tight junctions are not the only unique feature of brain capillaries. Brain capillaries lack fenestrae present in other systemic capillaries. Brain capillary endothelial cells also have a higher concentration of mitochondria than endothelial cells in other tissues. This difference is attributable to a higher metabolic requirement of the BBB endothelium to maintain ion differentials between blood plasma and brain extracellular fluid, and to maintain the unique characteristics of the brain capillaries [3]. Surrounding the brain endothelium, is a non-fibrous, collagenous, basement membrane that is surrounded by astrocytic foot processes. Although the exact function of astrocytes is still being debated, current evidence suggest they primarily serve supportive and regulatory roles to induce and maintain the formation of endothelial tight junctions. Astrocytes also provide a means of communication between neurons and capillaries that allows for regulation of local perfusion and capillary permeability [5, 10-13]. Pericytes are another group of cells that are located in close proximity to the BBB vessel and are thought to play a role as mediators of vasoconstriction.

Certain areas of the brain lack a BBB. These areas include the choroid plexus, posterior pituitary, and the circumventricular organs (area postrema, median eminence, pituitary neural lobe, pineal gland, subcommissural organ, and the subfornical organ). Blood vessels in these regions have fenestrations similar to systemic capillaries and are involved in either the production and filtration of cerebrospinal fluid (CSF) or neuroendocrine functions of the body. To function normally they rely on passage of molecules to and from blood plasma. These regions of the brain are also surrounded by specialized ependymal cells called tanycytes. Tanycytes are coupled by tight junctions and prevent diffusion of molecules from the circumventricular organs into the brain extracellular fluid and CSF [3, 6]. The BBB and the blood-cerebrospinal fluid barrier are often mistakenly thought to be equivalent. Because of the tanycyte barrier, CSF and brain interstitial fluid are not in equilibrium. The content of brain interstitium is determined by the presence of the BBB and the content of CSF is a function of the choroid plexus. Moreover, the BBB has a 5000-fold greater surface area than the blood-CSF barrier. The difference between brain interstitium and CSF can be appreciated by the use of fiber dialysis studies, which show that the makeup of the brain interstitium is markedly different than that of the CSF [14].

TRANSPORT

Although the brain's endothelial cells create an efficient barrier, nutrients can still be transported into the brain and waste products can be secreted. The ability of a substance to cross the BBB is dependent upon its affinity for four classes of molecules; plasma water, plasma proteins, membrane lipids, and membrane proteins (receptors and carriers). The greater the affinity of a substance for the membrane components, either lipids or proteins, the greater the ability of that substance to cross the BBB. For example, substances such as ethanol and barbiturates, with a higher affinity for lipid membranes

than plasma water, readily cross the BBB. Substances such as glucose have a high affinity for plasma water and would not be expected to cross the BBB. To circumvent this problem, specific membrane transport systems exist that increase BBB penetration. These transport systems include both carrier-mediated and receptor-mediated pathways. Many transport systems have been described for a variety of lipid-insoluble metabolic substrates such as hormones, neuropeptides, vitamins, and minerals. Several excellent reviews of BBB transport systems have been written [2, 4, 11, 14-17]. It is beyond the scope of this paper to discuss all transport systems in detail, but several transport systems that have direct clinical importance in veterinary medicine will be described.

GLUCOSE TRANSPORT

The first BBB transport system described was a glucose transporter (GLUT 1). GLUT 1 is a saturable, stereospecific, insulin-independent, carrier-mediated transport system similar to that present in red blood cells [2, 3, 14]. Large amounts of D-glucose from the blood can be transported across the BBB, but because of stereospecificity of the system, biologically inactive L-glucose does not cross the BBB. The half saturation coefficient of D-glucose transport is approximately the same as the normal plasma concentration of glucose. Evidence suggests that during times of hyperglycemia, down-regulation of glucose transport proteins occurs, while hypoglycemia results in an up-regulation of transport proteins. Therefore, during times of hypoglycemia or hyperglycemia the transport of D-glucose into the brain becomes more or less efficient, respectively. This phenomena may be important in the treatment of diabetes mellitus. Rapid correction of blood glucose in the severely affected diabetic may lead to relative brain hypoglycemia because of down-regulation of BBB glucose carrier proteins. Similarly, animals born to diabetic mothers may also have down-regulation of BBB glucose carrier proteins and thus exhibit neurological signs of hypoglycemia while blood glucose levels are normal. This phenomenon of up- and down-regulation may explain why animals with chronic hypoglycemia, for example, insulinoma patients, may not show signs of hypoglycemia at subnormal blood glucose levels [18-20].

AMINO ACID TRANSPORT

Different carrier-mediated transport systems exist in the brain for different classes of amino acids. Amino acids are grouped into four groups; large neutral amino acids, small neutral amino acids, basic amino acids and acidic amino acids. Large neutral amino acids, comprised of branch chained and aromatic amino acids, are required for production of neurotransmitters and proteins. Alteration in amino acid transport across the BBB may be important in the pathogenesis of such conditions as hepatic encephalopathy [21, 22]. Although the precise pathogenesis of hepatic encephalopathy is unknown, at least part is due to a disturbance in the integrity of the BBB. Patients with hepatic encephalopathy exhibit an increased BBB transport of neutral amino acids and a decreased transport of basic amino acids into the brain. This alteration in transport directly affects the levels of amino acid neurotransmitters such as glycine, aspartate and

glutamate. Furthermore, increased concentration of aromatic amino acids leads to the formation of neuroactive substances such as serotonin and tryptamine [23].

PEPTIDE TRANSPORT

Certain peptides such as insulin, insulin-like growth factors, and transferrin, appear to cross the BBB by means of receptor-mediated endocytosis and exocytosis [24-26]. Insulin is thought to play a role in many different brain functions [14]. Insulin may play a part in the development of cerebral edema, which is observed in diabetic ketoacidotic patients treated with this drug, by mediating the production of idiogenic osmoles. When hyperglycemia is corrected by peritoneal dialysis, brain and blood osmolarity fall at the same rate and cerebral edema is not seen. However, when hyperglycemia is rapidly corrected with insulin therapy, the decrease in brain osmolarity falls behind that of blood, and cerebral edema occurs [27].

DISORDERS OF THE BLOOD-BRAIN BARRIER

A number of diseases and pathologic conditions may result in a breakdown of the BBB (Table 1-2). Brain tumors decrease the integrity of the BBB by destruction of the glial sheath and /or endothelial cells, or by altering the communication between astrocytic foot processes and endothelial cells [28, 29]. Local disruption of the BBB leads to extravasation of fluid into the brain and tumor-associated edema. Tumor-associated edema is a major determinant of morbidity and mortality among patients with intracranial tumors [30]. Compromise of the BBB allows visualization of this disruption by diagnostic imaging modalities such as contrast-enhanced computed tomography (CT) scans. For a long time brain tumors were thought to lead to total disruption of the BBB but we now know this to be false [31-35].

The concept of a blood-tumor barrier has been introduced [36] and is widely accepted, although there is disagreement as to the extent of how this barrier functions. Well-differentiated primary brain tumors exhibit a very tight barrier and may not be enhanced on CT scans after administration of contrast agents. Poorly differentiated tumors and metastatic tumors enhance more readily on CT scans. Well-differentiated tumors are able to communicate with the BBB endothelium in such a way as to maintain the integrity of the barrier [14]. Variability in the integrity of the BBB is not only observed between different types of tumors but among different tumors of the same type and in different locations within the same tumor. Frequently, the proliferating edge of a tumor has an intact barrier. Thus, a tumor may be larger than predicted based on contrast-enhanced imaging. Presence of a blood-tumor barrier allows few hydrophilic drugs to achieve adequate concentrations within the tumor. Furthermore, brain tumors may have decreased blood flow and thus lipophilic chemotherapeutic drugs may actually achieve higher concentrations within normal brain tissue than in the tumor [36].

Table 1-2
Disorders That Disrupt The Blood-Brain Barrier

<u><i>Infectious</i></u>	<u><i>Inflammatory /Idiopathic</i></u>
Canine distemper virus	Granulomatous meningoencephalomyelitis
Canine herpes virus	Steroid responsive meningitis
Infectious canine hepatitis	Polyarteritis - beagle pain syndrome
Feline infectious peritonitis	Pug dog encephalitis / meningitis
Feline immunodeficiency virus	Eosinophilic meningoencephalitis
Rickettsial infections	Pyogranulomatous meningoencephalomyelitis
Bacterial meningitis	Allergic encephalomyelitis
Toxoplasmosis	<u><i>Mechanical Injury</i></u>
Neosporosis	Trauma
Encephalitozoonosis	Hemorrhage
Systemic mycotic infections	Infarction / Thromboemboli
Protothecosis	X-radiation
Trypanosomiasis	<u><i>Toxic</i></u>
<u><i>Neoplasia</i></u>	Lead intoxication
Primary brain tumors	Thiamine deficiency
Metastatic tumors	Carbon monoxide poisoning
<u><i>Systemic disorders</i></u>	
Diabetes mellitus	
Hypertension	

Many infectious and inflammatory diseases of the brain lead to compromise of the integrity of the BBB. These disorders all exhibit a similar pathophysiology. The initial insult to the endothelial cells of the BBB leads to inflammation and breakdown of the endothelial barrier. Pathogens, neurotoxic substances, and leukocytes that gain entrance into the brain from inflammation result in vasogenic and cytotoxic brain edema [37-39]. Bacterial meningitis is a good example to illustrate the pathogenesis of the inflammatory insult to the BBB. Bacterial invasion of the CSF and meninges leads to inflammation and production of cytokines, such as interleukin 1 and tumor necrosis factor alpha. These cytokines mediate additional damage to the BBB endothelium by recruitment of leukocytes that result in cytotoxic edema production. Various mediators of the inflammatory response are released into the CSF and result in formation of vasogenic edema and inappropriate secretion of antidiuretic hormone. Intracranial pressure increases as a result of cytotoxic and vasogenic edema, increased blood volume, and increased viscosity of the CSF. Increased CNS pressure in turn leads to decreased cerebral perfusion pressure and hypoxemia. Vasculitis, thromboembolic disease, and altered autoregulation of cerebral blood flow may result in ischemic insults, with the end result being irreversible neuronal damage [40-43].

Mechanical type insults to the BBB can also result in its destruction. Acute and chronic hypertension have been shown to lead to alteration of the BBB. Although the exact pathogenesis behind increased BBB permeability with hypertension is unknown, it probably results from disruption of tight junctions (intercellular passage) and increased intracellular transport mechanisms [44-47]. Ischemic anoxia from thromboemboli, anoxic anoxia from respiratory arrest, or histotoxic anoxia from toxins such as cyanide or carbon monoxide, may lead to disruption of the BBB. The magnitude of BBB disruption that follows an ischemic insult is largely dependent upon the nature and chronicity of the insult itself. Doses of X-radiation, close to those of the therapeutic range, have been shown to cause disruption of the BBB as well as increase the degree of disruption from other insults such as hypertension [48-50]. Subtle alterations in the permeability of the BBB have also been seen following exposure to electromagnetic radiation created in magnetic resonance imaging. The clinical importance of this finding however, is unknown [51, 52].

GETTING PAST THE BARRIER

The previous sections of this paper illustrate the important role of the BBB in protecting the brain and allowing normal function. While protective in function, the BBB also hampers the ability to deliver pharmaceuticals necessary to treat a number of intracranial diseases. Methods designed to improve drug delivery to the brain are listed in Table 1-3 and are described below.

Table 1-3	
Methods of Circumventing the Blood-Brain Barrier	
<u>Routes and methods of administration</u>	<u>Tailored and carrier drugs</u>
High dose	Increased lipid solubility
Intrathecal	Lipophilic carrier agents (liposomes)
Intraventricular	Cationization
Intra-arterial (carotid artery)	Glycosylation
<u>Non-pharmaceutical methods</u>	Receptor-mediated transport
Surgery	<u>Mechanical Disruption</u>
Radiation therapy	BBB disruption
	- Osmotic
	- Pharmacological
	- Biochemical
	Hypertension

ROUTES AND METHODS OF ADMINISTRATION

One method of increasing delivery of some drugs across the BBB is to increase the systemic dose of the particular drug [53, 54]. Increasing the systemic dose of numerous drugs will usually increase drug concentration in the CNS. However, this is not a practical approach to use for drugs that have a narrow margin of safety. For example, with chemotherapeutic agents unacceptable systemic side-effects are seen before effective intracranial drug concentrations can be achieved.

Strategies that change the route of drug administration also have been used to improve therapeutic effectiveness. Intra-arterial injection of drugs into either the carotid or vertebral artery is beneficial in delivering a larger proportion of a drug dose into the brain vasculature [55]. This technique is used in current studies with human brain tumor patients [56-58]. However, one disadvantage to this technique is that many drugs used to treat intracranial diseases must first be metabolized into an active form in the liver and, thus would not have therapeutic actions if taken up during the first pass through the brain. Furthermore, intra-arterial administration of a drug does not change the drug's intrinsic ability to cross the BBB and does not insure adequate CNS delivery. Another route for drug delivery is intrathecal or intraventricular administration [59, 60]. It is unlikely however, that therapeutic drug concentrations can be achieved more than a few millimeters away from the ependymal surface due to the barrier formed by the neuropil [61]. As discussed previously, the BBB is not equal to the brain-CSF barrier and drug concentrations in one area is not necessarily in equilibrium with the other. Furthermore, the CSF is a highly aqueous environment and the brain parenchyma is lipid in nature. This makes delivery of drugs by this route inefficient. Hydrophilic drugs tend to stay in the CSF and are cleared via arachnoid villi, while lipophilic drugs are difficult to formulate for this type of administration [62].

NON-PHARMACEUTICAL METHODS

Other strategies that attempt to circumvent the BBB involve treatment modalities that do not depend upon the clinician's ability to get drugs across the BBB. Radiation therapy is a popular treatment modality for brain tumors in both veterinary and human medicine [63-68]. Although beneficial effects of radiation therapy have been observed, a number of disadvantages are present [69-71]. Radiation therapy may lead to necrosis of normal brain tissue resulting in both acute and chronic side-effects. Also, specialized equipment and cost of radiation therapy preclude its use in most clinical veterinary settings. Surgery is another strategy that does not depend upon the integrity of the BBB. Unfortunately, many brain tumors are inoperable due to their location or their diffuse, multifocal nature. Furthermore when used as a single modality, there is a high tumor recurrence rate and low survival rate following surgery [72].

TAILORED AND CARRIER DRUGS

Newer strategies have evaluated changes to the chemical nature of a drug, or coupling drugs with carrier agents in an attempt to facilitate their movement across the

BBB. The ability of a drug to penetrate the BBB can be enhanced by altering its lipid solubility. For example, the esterification of chlorambucil to chlorambucil-tertiary butyl ester greatly enhances BBB penetration [73]. A drug can also be linked to a lipid soluble carrier such as hydroxypropylchitosan to increase BBB penetration. Experimental work with this carrier system has demonstrated its validity for the transport of drugs such as dopamine, gamma-aminobutyric acid (GABA), and luteinizing hormone (LH) [74]. Many different lipophilic carrier compounds have been identified and used to increase brain drug delivery. For example, various anti-viral agents, including ganciclovir, zidovudine, and azidothymidine (AZT), have been linked to lipophilic carrier compounds to increase their BBB penetration [75-79]. By entrapping a drug within liposomes it may be possible to increase BBB penetration. The brain uptake of a variety of agents has been experimentally increased by the use of liposome carriers. Liposomes have been investigated as carriers for citicoline and for super-oxide dismutase in the treatment of cerebral ischemia [3, 80]. Dimethyl sulfoxide (DMSO) has been extensively investigated as a vehicle to enhance BBB penetration of drugs [81-88], but it appears that DMSO is not a reliable way to gain access across the BBB.

Cationization or glycosylation of proteins may increase cellular uptake and thus enhance BBB penetration [89-91]. By interacting electrostatically with anionic charges on the luminal side of BBB endothelial cells, cationized proteins trigger absorptive-mediated transcytosis through the BBB [92, 93]. Both cationized protein tracers and cationized monoclonal antibodies have been shown to have enhanced cerebral uptake by absorptive-mediated transcytosis and represents a future strategy for drug delivery to the brain. Research has also been conducted using receptor-mediated transport through the BBB. By linking a drug with a peptide that is transported across the BBB such as insulin or transferrin, it may be possible to achieve adequate intracranial drug levels [16, 94]. Recently the use of transferrin receptor antibodies have been studied as a viable transport vehicle for such drugs as vasoactive intestinal peptide, nerve growth factor, and various opioid peptides [95, 96]. Use of drug tailoring and carrier drugs is an exciting field and holds great promise. At present, this methodology is in its infancy and few drugs are currently available for clinical use.

MECHANICAL DISRUPTION

Another strategy to improve therapeutic effectiveness of drugs is the temporary disruption of the BBB. Temporary disruption of the BBB can be achieved using pharmacological, biochemical, or physical methods. Pharmacological strategies for BBB disruption include intra-arterial infusion of drugs that interact physically with the endothelium and enhance vascular permeability such as etoposide, melphalan or protamine [92, 97]. Biochemical strategies include the intracarotid infusion of vasoactive substances such as leukotrienes [98-100] or bradykinin [101, 102]. Both of these strategies are in their infancy and their clinical usefulness has yet to be determined.

Hyperosmotic agents such as urea or mannitol can temporally disrupt the BBB by shrinking endothelial cells and opening tight junctions, allowing passage of therapeutic agents [103-108]. Hyperosmotic blood-brain barrier disruption (BBBD) is a threshold event dependent upon both duration of infusion and osmolality. If infusion duration or osmolality are inadequate disruption does not occur. However if either of these variables are excessive irreversible damage occurs [105, 107, 109, 110]. Disruption is unilateral, intracarotid infusion results in BBBD of the ipsilateral cerebral cortex [111] where as infusion into the vertebral artery results in ipsilateral BBBD of the posterior fossa [112]. Physiologic changes such as cardiac output and blood gas values as maybe seen with anesthesia have a profound effect on BBBD [113]. These structural and physiological changes secondary to hyperosmotic BBBD have been studied [114-118] but more information is needed.

Hyperosmotic BBBD has been refined and demonstrated in a number of species including the rat, dog, and non-human primate [109, 119, 120]. Various animal studies using rodents, dogs, and non-human primates have shown hyperosmotic BBBD to be a viable technique for delivering of chemotherapeutic drugs [121-127], enzymes [120], and viral and viral sized particles [128-131].

Neuwelt was the first to describe the use of hyperosmotic BBB disruption as a means of delivering chemotherapeutic agents to treat human patients with intracranial tumors [132]. Since that time other investigators have also reported using the technique with good results. Hyperosmotic BBB disruption has been used in the treatment of primary CNS lymphoma, astrocytomas, glioma, germinoma, primitive neuroectodermal tumors, and metastatic systemic tumors. [57, 58, 132-139]. Presently, a suitable clinical technique has not been described in the dog and therefore clinical studies in veterinary medicine have not been possible. We have recently concluded a project designed to evaluate repeated hyperosmotic BBB disruption in dogs. [140]. A similar repeatable technique for disruption of the caudal fossa BBB in the dog has been described at another institution [112, 141].

CONCLUSION

Although vital to the normal function of the brain, the blood-brain barrier presents some difficult challenges to the clinician. Various disorders can cause disruption of the blood-brain barrier. A solid understanding of the structure and physiology of the BBB is important in the treatment of these disorders. Many strategies have been used in attempts to circumvent the barrier in treatment of intracranial disorders. To date, no clinical strategy has been totally effective or without risks. The newest and most promising techniques involve the chemical tailoring of drugs and the use of hyperosmotic disruption to open the barrier.

Chapter 2: Repeatable Hyperosmotic Blood-Brain Barrier Disruption in The Dog: Technique and Complications

ABSTRACT

Reversible hyperosmotic blood-brain barrier disruption (BBBD) has been used in pharmaceutical research as well as human medicine to enhance drug delivery across the blood brain barrier. A technique for repeatable BBBD in the canine has not been described. This study describes a repeatable technique for BBBD in the dog and evaluates the clinical effects of BBBD.

Using fluoroscopic guidance, an arterial catheter was directed into the internal carotid artery via the femoral artery in ten dogs. BBBD was achieved in 5 dogs using intracarotid mannitol. Five control dogs received only saline. Following recovery, dogs were monitored for clinical signs before a second, non-survival procedure was performed 2-3 weeks later. BBBD was estimated using computed tomographic (CT) densitometry values as well as Evan's blue staining on post-mortem examination.

Seven dogs completed the entire study. Two treatment dogs were lost after the first infusion because of deteriorating neurologic function attributed to CNS edema and increased intracranial pressure. One control dog was lost due to vessel wall damage during catheterization. The remaining dogs exhibited only transient neurologic, ocular and vasculature injury. Successful BBBD was demonstrated in all treatment dogs indicating that it is possible to repeatably disrupt the BBB in the dog, opening the way for further investigation.

INTRODUCTION

The brain interstitium is separated from its blood supply by a barrier commonly referred to as the blood-brain barrier (BBB). Much work has been done defining the mechanisms behind the BBB and many excellent review articles have been written [3, 4, 142-145]. The BBB is formed primarily by brain capillary endothelial cells fused together by intercellular tight-junctions. Together with a thick basement membrane surrounded by astrocytic foot processes, this cellular barrier prevents the free diffusion of circulating molecules into the brain parenchyma. The barrier maintains tight homeostatic control of the brain's internal environment as well as prevents the entrance of toxins and pathogens into the brain. While protective in nature, the BBB also hampers the ability to deliver drugs necessary to treat a number of intracranial diseases.

Infusion of hyperosmotic agents into the internal carotid artery has been shown to transiently and reversibly disrupt the BBB by shrinking endothelial cells and opening tight junctions. [103, 104, 108, 146]. Various animal studies using rodents, dogs, and non-human primates have shown hyperosmotic blood-brain barrier disruption (BBBD) to be a viable technique for delivering of chemotherapeutic drugs [121-125], enzymes [120], and viral and viral sized particles [128-131]. The medical literature contains many clinical studies evaluating the efficacy and associated morbidity of BBBD used in the treatment of metastatic and primary CNS tumors, in man, with many encouraging results [57, 58, 134-137, 147, 148].

Because of its size, the dog has proven to be a useful model for BBBD allowing for repeated clinical and CSF evaluations as well as diagnostic imaging with computed tomography (CT) and magnetic resonance imaging (MRI). In a series of canine studies, Neuwelt and others have shown that the use of hyperosmotic BBBD is a viable means of increasing drug delivery to the brain. These studies have defined ways of quantifying the degree of BBBD with vital dyes and diagnostic imaging [111, 112, 126, 127, 149-153]. Current methodologies used in most of the canine studies, call for direct internal carotid artery catheterization to introduce the hyperosmotic agent. While this method is effective for single BBBD studies, inability to consistently cannulate this vessel multiple times as would be necessary in therapeutic trials limits its clinical usefulness. Human clinical studies make use of a catheter system introduced into the internal carotid artery via a peripheral artery such as the femoral artery.

The purpose of this study was to design a repeatable technique for hyperosmotic BBBD in the dog. Establishment of such a technique would not only provide a useful model to explore the safety and efficacy of newer innovative treatment protocols such as immunotherapy for brain tumors, and enzyme replacement therapy for metabolic brain disease. It also allow veterinary clinical trials to be undertaken to expand our ability to treat a wide number of intracranial diseases.

METHODS AND MATERIALS

ANIMALS

Ten young adult, mixed breed, male dogs weighing between 19 and 34 kg were studied. All animals were housed and maintained according to guidelines set forth by the University Animal Use and Care Committee. Dogs were determined to be healthy based on physical, ophthalmologic and neurological examination. Complete blood cell count, serum biochemical profile, urinalysis, fecal flotation, and Knott's test were performed on each animal and normal results were a prerequisite to inclusion in the study. At least one week prior to the first catheterization procedure, all dogs were anesthetized with thiopental induction and maintained on isoflurane for contrast enhanced CT evaluation to ensure there was no sub-clinical pathology present as well as supply baseline data.

EXPERIMENTAL DESIGN

Dogs were divided into two groups by ranking them according to weight and alternately assigning them to group 1 (treatment group) or group 2 (control group). To ensure groups were of similar weight, mean weights were compared using ranked sum test ($p=0.706$). Both groups were treated identically with the exception of the carotid infusion solutions. Group 1 dogs received intracarotid mannitol infusions and group 2 dogs received isotonic saline.

ANESTHESIA

All procedures were performed under general anesthesia. Animals were induced with thiopental, intubated and maintained on isoflurane. To maintain constant pO_2/pCO_2 concentrations, animals were mechanically ventilated (Ohmeda™ ventilator*) and arterial blood gases were maintained at a pCO_2 of 25 to 35 mm Hg and a pO_2 of >550 mm Hg. Heart rate, blood pressure, and rectal temperature were also monitored. Heart rate was maintained above 100 bpm by atropine administration (0.002 mg/kg I.V.) and mean arterial pressure was maintained above 100 cm H_2O using phenylephrine (0.03mg/kg I.V.) as necessary. To evaluate the effect physiological factors may have on BBBD, heart rate, respiratory rate, blood pressure, rectal temperature, blood gas and urine output were recorded at each of five time periods. Time periods included time of induction, just prior to intracarotid infusion, immediately following intracarotid infusion, after administration of radiographic contrast, and at the conclusion of general anesthesia. To induce diuresis, furosemide (2 mg/kg I.V.) was administered immediately prior to intracarotid infusion.

* Ohmeda 7000 ventilator, Ohmeda, A Division of the BOC Group Inc., Madison WI 53070

CATHETERIZATION TECHNIQUE

Animals were positioned in dorsal recumbancy and the internal carotid artery catheterized via femoral artery using the Seldinger technique [154] (Figure 2-1). A sterile surgical field was prepared in the inguinal region, over the right femoral artery. An 18 gauge, 7.0 Fr. percutaneous entry needle[†] was placed through a small stab incision into the femoral artery and a flexible glide wire[‡] was feed through the needle into the artery. The entry needle was removed and an angiographic catheter[§] was introduced over the glide wire into the femoral artery. Two types of guide wires (a straight, flexible tip Bentson guide wire and a hydrophobic 45° angle tip guide wire) and two different catheters (a Norman catheter and an Imager™ torque catheter) were used. Glide wires and catheters were chosen based on ease of manipulation into the desired vessels as well as availability of equipment. A rotating hemostatic valve^{**} was attached to the catheter to facilitate flushing with heparinized saline (10 units/ml). Under fluoroscopic guidance^{††}, the catheter and glide wire were advanced into the descending aorta, past the brachycephalic trunk, and into the aortic arch. The catheter was rotated 180° and withdrawn until the catheter entered the brachycephalic trunk. The catheter was then advanced cranially until it entered the common carotid artery and then the internal carotid artery. Positioning of the catheter was confirmed with digital subtraction angiography using 1.5 ml of iopamidol diluted 1:1 with normal saline (0.9% NaCl) and injected at 1.5-2 ml/sec. Mild reflux of contrast around the catheter during the angiogram was used to confirm an adequate flow rate sufficient to replace the normal blood flow through the circle of Willis (Figure 2-2).

DISRUPTION

Two disruption procedures were performed in each dog. The initial side chosen for disruption was based on ease of catheterization. However, the second procedure was always performed on the same side. Dogs in group 1 received mannitol (25%) warmed to 37°C and filtered through a 0.20 µm milipore filter. Group 2 dogs received an intracarotid infusion of 0.9% NaCl warmed to 37°C. Using an infusion pump^{‡‡}, the infusate was delivered at a constant rate of 1.7 ml/sec for 30 seconds. To ensure accuracy in flow rates, the volume of solution infused over 30 seconds was recorded and exact flow rate was

[†] Cook, A Cook Group Company, PO Box 489, Bloomington, IN 47402

[‡] TFE Coated Bentson Wire Guide, 0.035 inch diameter, 145 cm length
Cook, A Cook Group Company, PO Box 489, Bloomington, IN 47402
Angled, hydrophobic Glidewire™, 0.035 inch diameter, 150 cm length
Medi-tech, Boston Scientific Corporation, 480 Pleasant Street, Watertown, MA 02172

[§] Imager™ Torque Catheter, 5 French, 100 cm length: Bern/Berenstein shape
Medi-tech, Boston Scientific Corporation, 480 Pleasant Street, Watertown, MA 02172
Norman Angiographic Catheter, High-Flo™ torque control angle, 5.5 french, 100 cm
Cook, A Cook Group Company, PO Box 489, Bloomington, IN 47402

^{**} Target Therapeutics, 47201 Lakeview Blvd., Fremont, CA 94538

^{††} Picker elite fluroscope, Picker International, 595 Miner Road, Highland Heights, Ohio 44143

^{‡‡} Uropump™, Model 17711, Life-Tech™, Inc., PO Box 36211, Houston TX 77236

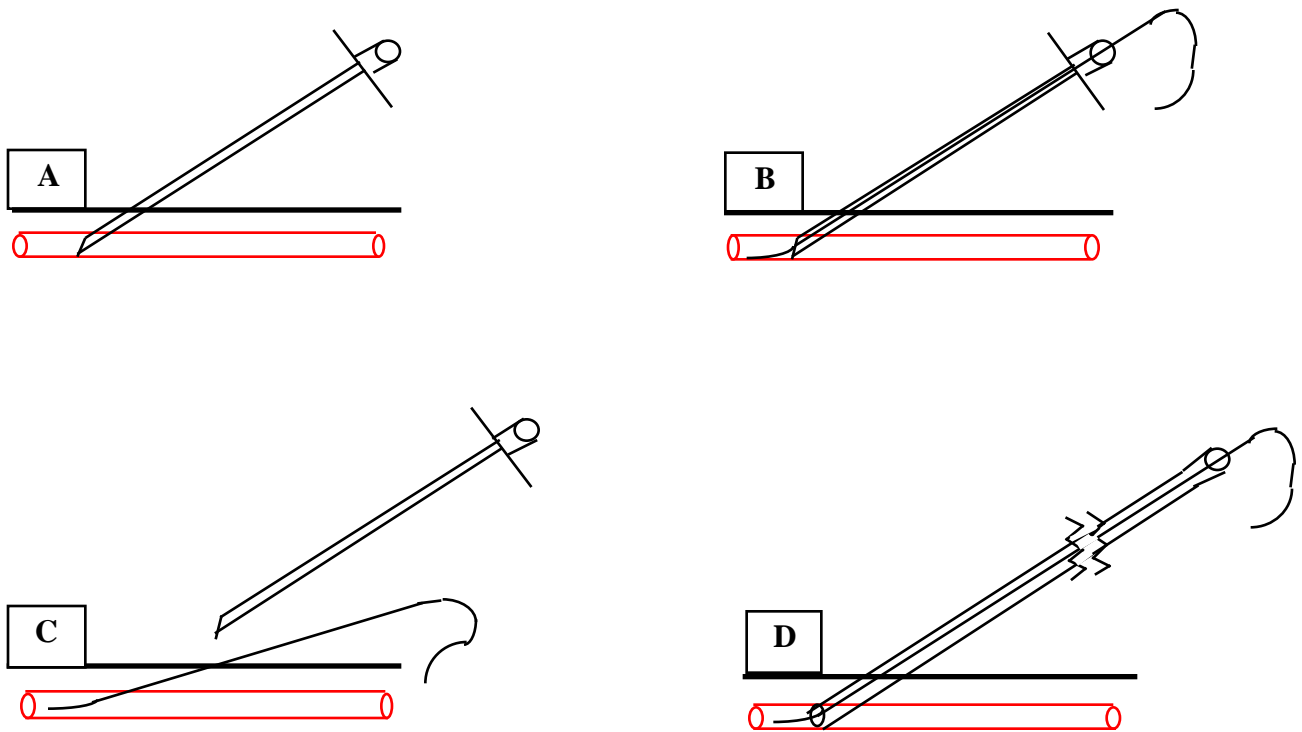

Figure 2-1: Seldinger Technique of percutaneous catheterization of the femoral artery. A) percutaneous entry into artery using an introduction needle, B) feeding guide wire through introduction needle and into artery, C) removal of introduction needle, D) feeding catheter over guide wire and into artery.

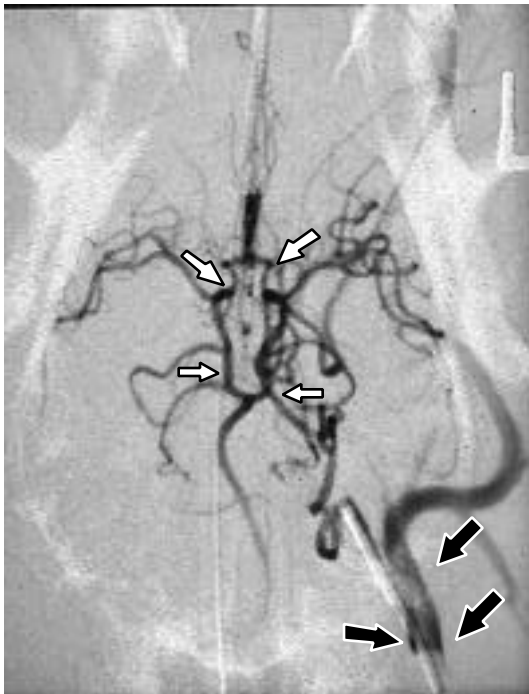
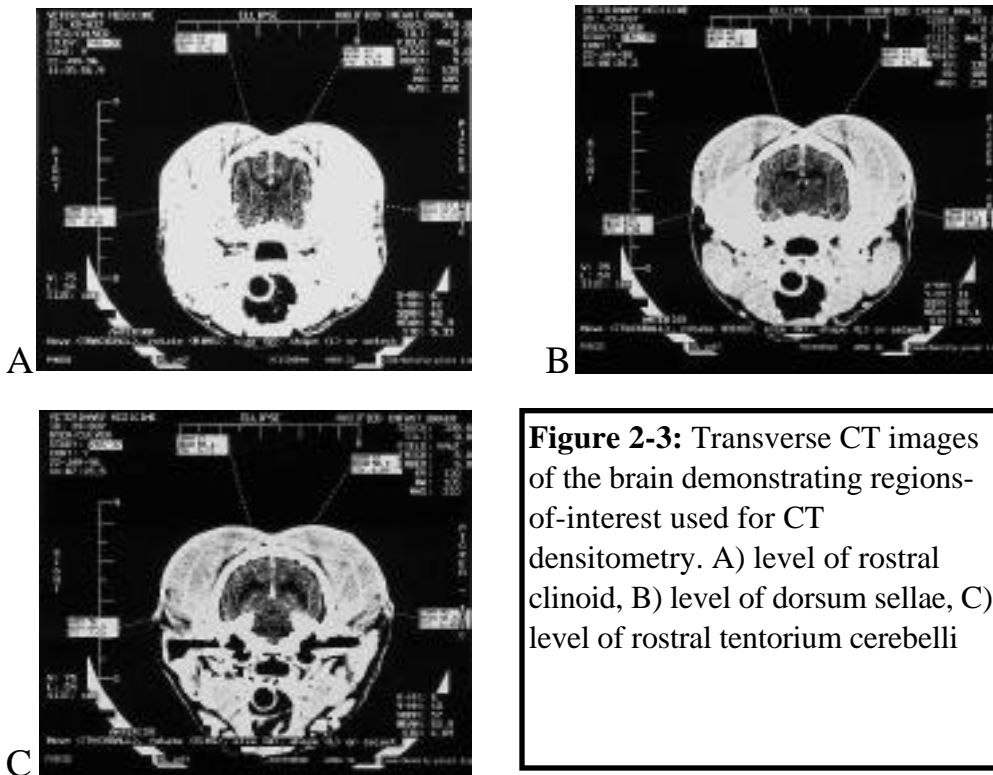

Figure 2-2: Digital subtraction angiogram demonstrating the catheter position used for intracarotid infusion. Correct catheter placement is indicated by opacification of the circle of Willis (white arrows). Correct flow rate is indicated by contrast reflux into the lingual artery (black arrows)

calculated for each dog. Following intracarotid infusion, a second angiogram was performed as before, to ensure the catheter had remained in position during the procedure.

CT EVALUATION

Immediately following each disruption procedure, CT densitometry of the brain was performed using a fourth generation scanner^{§§} and iopamidol enhancement. Iopamidol was infused at 5 ml/kg over 5 minutes beginning 1 minute after intra-carotid infusion. Post contrast CT images were acquired in a transverse plane using a 5-mm slice thickness, 5 mm slice interval, 240 mm field of view, 130 kilovoltage peak, and 105 milliamperage. Densitometric values were obtained from four predetermined locations (left lateral, right lateral, left dorsal, and right dorsal quadrants) in each of three pre-selected slice levels (rostral clinoid, dorsum sellae, and tentorium cerebelli) (Figure 2-3). These slice levels were chosen in order to obtain a representative sampling of the cranial, middle, and caudal cerebral arterial distributions. All CT density values were obtained by a board certified veterinary radiologist who was unaware of dog grouping. Density values were determined using an elliptical region of interest placed on the display and the CT computer's software for relative density calculation. Computed tomographic density values were compared by group using analysis of variables (ANOVA) for repeated measures. Significance was determined using a P value of <0.05.



^{§§} Picker I.Q./T., Picker International, 595 Miner Road, Highland Heights, Ohio 44143

SURVIVAL STUDY

All animals were monitored continuously during recovery and for a minimum of 2 hours following full recovery for signs of side effects. Any animal exhibiting adverse side effects was either treated as deemed appropriate by the investigators or humanely euthanized if the signs were considered severe enough to adversely interfere with the animals quality of life. One dog was treated with methylprednisolone sodium succinate (Solu-Medrol®) for apparent cerebral edema. One dog was euthanized because of severity of clinical signs and one animal died of apparent brain herniation before full anesthetic recovery. A complete neurological exam was performed within 12 hours following full recovery by an investigator blinded to the dogs grouping. Neurological examinations were performed daily until the animal was considered normal.

NON-SURVIVAL STUDY

To establish repeatability of the catheterization technique, 2 to 3 weeks following the first procedure, all surviving dogs underwent a second disruption procedure identical to the first. Fifteen minutes prior to the second and final disruption, 3 ml/kg of 2% Evan's blue dye was administered IV to provide a visual marker to evaluate BBB. Following final CT evaluation, all animals were humanely euthanized and complete post-mortem evaluations performed. All brains were photographed and the degree of Evan's blue staining was graded on a scale of 0-3 as previously described [109]. A score of 0 was assigned if there was no stain uptake, a score of 1 assigned to light staining of the surface and cortical layers, a score of 2 assigned to darker, diffuse cortical staining and light staining of the white matter, and a score of 3 assigned if there was deep blue staining of gray and white matters. Evan's blue scores were statistically evaluated using a two sample T test. Significance was determined using a P value of < 0.05. Brains were preserved in formalin for histopathological evaluation.

RESULTS

CATHETERIZATION TECHNIQUE

The project was successfully completed in 7/10 dogs (4 control and 3 treatment dogs). One control dog was lost from the study after two failed catheterization attempts. One treatment dog died of brain herniation before full recovery from anesthesia following the first infusion. Another treatment dog was euthanized 24 hours after the first procedure for deteriorating neurologic signs suggestive of CNS edema. Successful catheterization of the internal carotid artery was achieved in 16 of 18 attempts (Table 2-1).

Table 2-1 Procedural Complications			
Complication	Occurrences	Number of Procedures	Percentage of Occurrence (%)
Unsuccessful catheterization of internal carotid	2	18	11.1
Rupture of femoral artery	1	18	5.6
Hematoma of common carotid artery	1	18	5.6
Unsuccessful percutaneous entry	1	18	5.6
Thrombosis of internal carotid artery	1	18	5.6
Clinical signs associated with femoral artery hematoma	2	10	20.0

Total time of the catheterization procedure ranged from 1 hour 6 minutes to 14 minutes with an average procedure time of 41 minutes. The average time of the first nine procedures was 50 minutes whereas the next nine procedures averaged only 27 minutes.

Six procedures were performed using an Imager™ Torque Catheter and twelve procedures using a Norman Angiographic Catheter. Successful catheterization was achieved with both catheters and there was little subjective difference between the two. The use of an angled glide wire greatly facilitated the introduction of the catheter into the internal carotid artery. A straight Bentson wire was used in five procedures. In 4 of the 5 of these procedures the wire was changed to an angled one in order to guide the catheter into the internal carotid artery.

In only two dogs was percutaneous catheter placement in the right femoral artery impossible. One dog required artery isolation using a minimally invasive, cut down procedure and subsequent ligation of the artery. In the second case, hematoma formation during the initial percutaneous arterial puncture necessitated use of the opposite femoral artery.

COMPLICATIONS OF CATHETERIZATION

Complications directly related to the catheterization technique consisted of subcutaneous hematoma occurrence at the site of catheter introduction in all dogs (Table 1). Adverse clinical signs consisting of distal limb edema and / or lameness was only observed in two of the dogs. All subcutaneous hematomas resolved by the time of the second infusion procedure.

In the single control dog lost from the study, two catheterization attempts were unsuccessful. In the first attempt, hematoma of the common carotid prevented catheter placement into the internal carotid artery. During the second attempt two weeks later, the femoral artery was penetrated at the level of the iliac artery, allowing intra-abdominal catheter placement. The procedure was terminated and the dog was humanely euthanized.

Thrombosis of the internal carotid artery was detected at the time of the second procedure in one treatment dog. It was not possible to determine whether the thrombosis occurred secondary to previous trauma during the initial catheterization or if it occurred secondary to the initial intracarotid infusion. The opposite internal carotid artery was catheterized and BBBD was performed on the contralateral side.

COMPLICATIONS OF THE INFUSION

During recovery all but one dog exhibited clinical signs of pain and were treated with butorphenol (0.5 mg/kg subcutaneously). This dose was effective in eliminating signs of discomfort in all dogs.

Following the first BBBD procedure one treatment dog recovered from the initial infusion, but during the subsequent 24 hours, deteriorating neurological signs necessitated euthanasia. Post-mortem evaluation revealed edema of the cerebral hemisphere ipsilateral to the infusion. Another treatment dog showed similar deterioration of neurologic signs 24 hours following the initial infusion. Aggressive therapy with methylprednisolone sodium succinate (Solu-Medrol®) (30 mg/kg IV) twice 6 hours apart and mannitol (1 gm/kg IV, once) resulted in full clinical recovery within 24 hours. One treatment dog showed signs of increased CNS pressure and died before recovery from anesthesia. Post-mortem evaluation revealed cerebral edema and subsequent brain herniation. Because this animal did not awaken from anesthesia it was not included in the neurological side-effects data below.

Neurologic deficits consisting of head deviation ipsilateral to the side of infusion was seen in 2/4 control dogs and 3/4 treatment dogs (including the dog that recovered from anesthesia above) (Table 2-2). All but one of the control dogs also circled to the side of the infusion and had postural reaction deficits on the side opposite intracarotid artery infusion. Neurological deficits were transient in all dogs and resolved within 96 hours of the initial infusion. Neurological deficits tended to be more severe and take longer to resolve in the treatment group.

Visual field deficits as a consequence of perfusion of the internal carotid artery was observed in 7 of 8 dogs (Table 2-3). In all seven dogs, the eye ipsilateral to the infusion had visual deficits, incomplete to absent direct pupillary light reflexes (PLR), and variable degrees of anterior uveitis. Electroretinograms (ERG) performed on two of the

Table 2-2 Neurologic Side effects of BBBD			
	Control Group (n=4)*	Treatment Group (n=4)**	All Dogs (n=8)
Head tilt ipsilateral to infusion	2	3	5
Circling ipsilateral to infusion	1	3	4
Hemiparesis contralateral to infusion	1	3	4
Brain herniation	0	1**	1
Euthanasia due to neurologic deterioration	0	1	1

* One dog in the control group was not successfully catheterized during either procedure and was not included in the neurological side-effects data

** One dog in the treatment group did not recover from anesthesia following the first BBBD and thus was not included in the neurological side-effects data

Table 2-3 Visual Findings							
		Eye Ipsilateral To Infusion			Contralateral Eye		
Dog	Group	Vision	PLR*	ERG**	Vision	PLR	ERG
1	Control	diminished	incomplete	-	normal	normal	-
2	Control	normal	normal	normal	normal	normal	normal
3	Control	diminished	incomplete	-	blind	slow	-
4	Control	blind	absent	-	blind	normal	-
5	Treatment	diminished	incomplete	-	blind	slow	-
6	Treatment	blind	absent	flat	blind	normal	normal
7	Treatment	blind	absent	flat	blind	normal	decreased
8	Treatment	blind	absent	-	blind	normal	-

* PLR - Pupillary Light Reflex

** ERG - Electroretinogram

treatment dogs, failed to elicit any retinal activity. Histopathological evaluation performed on these same two dogs following the final disruption revealed atrophy of the ventral inner retina and retinal pigmented epithelium consistent with ischemic or hypoxic injury of 2-4 weeks duration. Histopathological evaluation of the one treatment dog with normal vision following the first disruption revealed no significant abnormalities.

Visual field deficits in the eye contralateral to the infusion occurred in 6 of 8 dogs. Pupillary light reflexes were normal to slow in all six of these dogs. Two of the treatment dogs had ERG performed. One of the dogs had reduced amplitude indicating reduced retinal function, while the second dog's ERG was normal. Histopathological evaluation of these eyes following final infusion did not reveal any significant abnormalities.

Visual deficits were transient, lasting 2-10 days. All dog's with abnormal ERG findings following the first infusion had normal ERG findings prior to the second procedure. Vision was considered normal in all other dogs prior to the second BBBD based on ophthalmologic examination and the ability to negotiate a maze in a darkened room.

CT DENSITOMETRIC DATA

Using analysis of variables (ANOVA) for repeated measures and a p value ≤ 0.05 there was no significant difference found between quadrants or slice levels measured for each group. Therefore means and standard deviations given represent pooled data within groups (Table 2-4).

There was no significant difference in the baseline values between or within groups of dogs, indicating no underlying pathology was present in any animal. In the control group, the baseline mean CT densities of the two hemispheres was 49.26 (± 4.02), and 48.91 (± 3.81) ($p = 0.767$). In the treatment group, the baseline mean CT densities of the 2 hemispheres was 49.14 (± 2.92) and 49.30 (± 3.42) ($p = 0.850$). Pooling values from both sides of the brain, mean baseline CT densities were 49.08 (± 3.89) for the control group and 49.22 (± 3.16) for the treatment group ($p = 0.835$).

Table 2-4			
CT Density Values (Hounsfield Units)			
		Control group	Treatment group
Baseline	Treated side	49.26 (± 4.02)	49.14 (± 2.92)
	Opposite side	48.91 (± 3.81)	49.30 (± 3.42)
	Both sides	49.08 (± 3.89)	49.22 (± 3.16)
First Disruption	Treated side	50.68 (± 5.87)	61.31 (± 7.78)
	Opposite side	51.05 (± 5.05)	54.80 (± 8.53)
	Both sides	50.86 (± 5.45)	58.06 (± 8.73)
Second disruption	Treated side	48.72 (± 4.41)	63.63 (± 10.00)
	Opposite side	49.37 (± 4.55)	58.11 (± 9.16)
	Both sides	49.04 (± 4.44)	60.87 (± 9.86)

Density values given in mean \pm standard deviation

Comparing values obtained from the perfused hemisphere, statistically significant differences in CT densities were detected between treatment and control dogs after both the first and second intracarotid infusion. Mean CT densities of the perfused hemisphere after the first infusion was 50.68 (± 5.87) for the control group and, 61.31 (± 7.78) for the treatment group ($p = 0.0007$). Mean CT densities of the perfused hemisphere after the second infusion was 48.72 (± 4.41) for the control group and, 63.63 (± 10.00) for the treatment group ($p = 0.0001$).

Comparing values obtained from the non-perfused hemisphere, the treatment group had higher CT densities after both the first and second infusions, however this difference was only statistically significant following the second infusion. Mean CT densities of the non-perfused hemisphere after the first infusion was 51.05 (± 5.05) for the control group and, 54.80 (± 8.53) for the treatment group ($p = 0.0624$). Mean CT densities of the non-perfused hemisphere after the second infusion was 49.37 (± 4.55) for the control group and, 58.1 (± 9.16) for the treatment group ($p = 0.0011$).

Comparing CT densities for right and left sides, in the control group, there were no statistical differences in any of the three CT studies. In the control group, mean baseline CT densities were 49.26 (± 4.02) on the treated side, and 48.91 (± 3.81) on the non-treated side ($p = 0.767$). After the first infusion, mean CT densities were 50.68 (± 5.87) on the treated side and, 51.05 (± 5.05) on the non-treated side ($p = 0.813$). After the second infusion, the mean CT densities were 48.72 (± 4.41) on the treated side and, 49.37 (± 4.55) on the non-treated side ($p = 0.618$). In the treatment group, the perfused side had higher CT densities than the non-perfused side. However, due to small sample size this difference was only statistically significant following the first infusion. For the treatment group, the mean baseline CT densities were 49.14 (± 2.92) on the treated side, and 49.30 (± 3.42) on the non-treated side ($p = 0.850$). After the first infusion, the mean densitometric value were 61.31 (± 7.78) on the treated side and, 54.80 (± 8.53) on the non-treated side ($p = 0.0031$). After the second infusion, the mean CT densities were 63.63 (± 10.00) on the treated side and, 58.11 (± 9.16) on the non-treated side ($p = 0.93$).

Comparing values from the first and second infusions, the second infusion did not result in significantly higher values than the first infusion in either group. In the control group mean CT densities of the perfused side was 50.68 (± 5.87) following the first infusion, and 48.72 (± 4.41) following the second infusion ($p = 0.198$). For the treatment group, the mean densitometric value of the perfused side was 61.31 (± 7.78) following the first infusion, and 63.63 (± 10.00) following the second infusion ($p = 0.373$).

Table 2-5 Evan's Blue Scoring		
Evan's Blue Score	Control Group (n=4)	Treatment Group (n=3)
"0"	3	0
"1"	1	0
"2"	0	2
"3"	0	1

See text for scoring scheme

EVAN'S BLUE SCORE

A second BBBD procedure was completed in 7 of the 10 dogs (4 control dogs and 3 treatment dogs). Three of the control dogs had an Evan's blue score of 0 and one control dog was given a score of 1 (Table 2-5). One treatment dog was given a score of 3 and the remaining two dogs were given a score of 2. Evan's blue scores for the treatment group were significantly higher than the control group ($p=0.004$).

DISCUSSION

The purpose of this paper was to identify a repeatable technique for hyperosmotic blood-brain barrier disruption in the dog. Using fluoroscopic guidance, it was possible to direct a catheter from the femoral artery to the internal carotid artery in 16 of 18 attempts. Furthermore, the same internal carotid artery was successfully recatheterized 2-3 weeks later in 7 of 8 attempts.

Complications from the catheterization technique were rare. Self-resolving hematoma formation at the site of catheter introduction was the most common complication. One control dog developed a hematoma at the common carotid artery during the first catheterization attempt, and rupture of the femoral artery occurred during the second attempt. It is not clear why a single animal experienced both of these complications. The possibility of a vascular disease resulting in abnormally friable vessels can not be excluded.

Thrombosis of the internal carotid artery was seen in one dog during the second catheterization attempt. It is not known if this occurred secondary to damage from the first catheterization or if the vessel was damaged at the time of the first infusion. The infusion pump used in this study was a roller pump and created a pulsatile flow. This pulsatile flow could have increased the amount of vessel wall damage, predisposing to thrombosis formation. Other studies have described the use of a non-pulsatile pumps (Harvard apparatus infusion pump or Medrad mark V arterial injector) which would avoid this problem [112, 155]. Alternatively, many of the catheters used in this study were sterilized and reused because of economic constraints. After repeated use, burrs

developed on the tips of some catheters which could have increased this complication rate.

Neurologic side effects seen in this study were more common than previously described [57, 109, 112, 134, 151, 156]. Head tilt and circling to the side of infusion with postural reaction deficits on the opposite side were clinical signs observed in both treatment and control animals. Lateralization of neurologic signs, together with the self-resolving nature of the deficits, suggest that intracarotid infusion created brain edema. Since clinical deficits were present in both treatment and control groups, mannitol alone can not explain the observed side-effects. Instead, either the catheterization technique or the infusion technique including the rate or pulsatile nature of the infusion must be implicated. Cerebral edema is a recognized complication of BBBB and excessive infusion rates is one of the variables known to exacerbate this complication [157]. Previous studies indicated that flow rates of 1.5 ml/sec for 30 seconds are optimal in the dog [149, 150]. In the present study, similar flow rates were attempted. However after measuring the volume of solution infused, the flow rate was calculated to be 1.7 ml/sec. Minimal side-effects were seen in the first two experimental animals, therefore this rate was maintained for the sake of consistency. Unfortunately this may have contributed to increased morbidity seen in this study.

Human patients undergoing BBBB are routinely treated for edema with systemic administration of steroids and mannitol [147]. Deteriorating neurologic signs were successively reversed in one treatment dog using these agents. We speculate that one or both of the other treatment dogs lost in this study may have survived if treatment had been initiated. Furthermore, neurologic deficits observed may have been minimized with routine post-disruption treatment regimes.

Bilateral visual deficits following BBBB was an unexpected complication. Deficits in the eyes ipsilateral to intracarotid infusion had clinical signs compatible with a primary ocular lesion including uveitis, absent to incomplete PLRs and no ERG activity in the two dogs tested. Histopathological evaluation of two of these dogs confirmed the diagnosis of ocular blindness. Ocular lesions resulting from disruption of the blood-aqueous barrier and/or blood-retinal barrier are documented complications of hyperosmotic BBBB [57, 147, 158, 159] and we speculate that a similar mechanism resulted in temporary visual deficits in the ipsilateral eye in this study. However, blindness in the eye contralateral to infusion has not, to our knowledge, been reported. All of the treatment dogs and half of the control dogs in this study demonstrated visual deficits with intact PLRs and no clinical or histopathological evidence of ocular lesions in the eye contralateral to intracarotid infusion. These finding together with normal or minimal changes in ERGs supports the diagnosis of blindness secondary to forebrain injury. It is estimated that at least 75% of the optic nerve fibers cross in the optic chiasm in the dog [160]. Therefore, visual deficits in the contralateral eye may represent another manifestation of cerebral edema.

Both the use of physiologic markers such as Evan's blue dye and diagnostic imaging modalities such as enhanced computed tomography have been shown to correlate well with the degree of BBBD and drug delivery [111, 149]. Using these markers, successful repeat BBBD was achieved in this study. Based on densitometric values, treatment animals had significantly greater enhancement than the control group after both infusions. It is interesting to note that repeat BBBD does not appear to increase the degree of disruption as there was no significant difference between CT densities following the first or second infusion in either group.

Although CT enhancement was significantly greater on the side ipsilateral to the infusion, evidence of disruption was noted in the opposite side as well. CT densities of the contralateral side were significantly greater than baseline values in the treatment group after the first infusion and were greater than the control group after both the first and second infusions. However, due to small sample size this difference between groups was only significant following the second infusion. Hyperosmotic BBBD is primarily an unilateral event in that intracarotid infusion results in BBBD of the ipsilateral cerebral cortex. However, disruption may be seen in the contralateral hemisphere especially in the area of anterior cerebral artery distribution where the dilution of blood from the opposite side of the circle of Willis is minimal [111]. In the current study, the degree of disruption on the side of the brain contralateral to the infusion may have been enhanced by excessive infusion flow rates. We speculate that the flow rate used in this study was high enough to counteract the dilutional effect from the opposite side of the circle of Willis and thus disrupt the cerebral hemisphere contralateral to the infusion.

In summary, repeatable hyperosmotic BBBD is possible in the dog. More work is needed to define a safe yet effective mannitol flow rate as well as standardize post disruption monitoring and therapy to minimize neurological complications. Refinement of this technique would be useful not only for improved delivery of chemotherapeutic agents in patients with brain tumors, but would also allow for further investigation of new therapies employing genetically engineered retroviruses and monoclonal antibodies. While more work is needed before this technique is clinically applicable, this paper clearly establishes the feasibility of repeat BBBD in the dog.

Chapter 3: Histopathological changes in the dog brain after repeat hyperosmotic blood-brain barrier disruption

ABSTRACT

Reversible hyperosmotic blood-brain barrier disruption (BBBD) is a reported method of enhancing drug delivery across the blood brain barrier. A technique for repeatable BBBD in the canine has recently been described. The purpose of this study was to examine the histopathological structural changes associated with this technique.

Ten dogs were randomly assigned to treatment or control groups. A catheter was percutaneously introduced into the femoral artery and advanced with fluoroscopic guidance into the internal carotid artery. Treatment dogs received intracarotid 25% mannitol (1.7 ml/sec for 30 sec) and control dogs received 0.9% saline at the same rate. Following BBBD, contrast enhanced computed tomographic (CT) scans were performed on all dogs. Dogs were recovered following the first procedure and were monitored for clinical signs related to BBBD for 2-3 weeks. A second, non survival procedure was performed as before with the addition of Evan's blue dye administered 15 minutes prior to BBBD. The degree of BBBD was estimated using Evan's blue staining with a grading scale of 0-3. Brains were harvested immediately following the second procedure, and examined with light microscopy using hematoxylin and eosin, Perl's iron, Masson's trichrome and glial fibrillary acidic protein immunocytochemical staining.

All dogs in this study had gross and microscopic brain lesions related to BBBD. The most common lesions observed were multifocal regions of necrosis consistent with infarction in the caudate nucleus as well as corticomedullary regions of the temporal and parietal lobes. All lesions were located on the side of the brain ipsilateral to intracarotid infusion. Although lesions were seen in both treatment and control groups, they were more numerous and severe in the treatment group.

We speculate that the lesions were secondary to an excessive intracarotid infusion rate leading to damage of BBB endothelium and resulting damage to the brain's interstitium.

INTRODUCTION

The brain interstitium is separated from its blood supply by a barrier commonly referred to as the blood-brain barrier (BBB). Anatomically, the BBB is formed by brain capillary endothelial cells fused together by intercellular tight-junctions. Together with a thick basement membrane surrounded by astrocytic foot processes, this cellular barrier prevents free diffusion of circulating molecules into the brain parenchyma [5]. The barrier maintains tight homeostatic control of the brain's internal environment as well as prevents the entrance of toxins and pathogens into the brain [3, 143]. While protective in nature, the BBB also hampers the ability to deliver drugs necessary to treat a number of intracranial diseases.

Hyperosmotic blood-brain barrier disruption (BBBD) is an established method of enhancing drug delivery to the brain [161]. Intracarotid infusion of hyperosmotic agents reversibly disrupt the BBB by shrinking endothelial cells and opening tight junctions, allowing passage of therapeutic agents [103, 104, 108, 146]. Although there are many reports on the clinical side-effects and morbidity of hyperosmotic BBBD [109, 112, 117, 118, 125, 126, 134, 152, 156, 158, 159, 162, 163], there have been few studies designed to examine the histopathological changes secondary to hyperosmotic BBBD [114-116, 146].

The methods used in most previous canine studies call for direct intracarotid artery catheterization to introduce the hyperosmotic agent [111, 127, 149-153]. While effective for single BBBD studies, inability to consistently re-cannulate this vessel multiple times limits its clinical usefulness. We recently described a technique of repeatable BBBD in the dog using fluoroscopic guidance to place a percutaneous transfemoral catheter system into the internal carotid artery. The clinical consequences of repeat BBBD were reported in a previous paper[140].

The purpose of this study was to examine the morphologic effects of a technique for repeatable hyperosmotic BBBD in the dog

METHODS AND MATERIALS

ANIMALS

Ten young adult, mixed breed, male dogs weighing between 19 and 34 kg were studied. All animals were housed and maintained according to guidelines set forth by the University Animal Use and Care Committee. Dogs were determined to be healthy based on physical, ophthalmologic and neurological examinations. Complete blood cell count, serum biochemical profile, urinalysis, fecal flotation, and Knott's test for microfilaria were performed on each animal and normal results were a prerequisite to inclusion in the study. At least one week prior to the first catheterization procedure, all dogs were anesthetized with thiopental induction and maintained on isoflurane for contrast enhanced CT evaluation of the brain to ensure no sub-clinical pathology was present.

EXPERIMENTAL DESIGN

Dogs were divided into two groups by ranking them according to weight and alternately assigning them to group 1 (treatment group) or group 2 (control group). Both groups were treated identically with the exception of carotid infusion solutions. Group 1 dogs received intracarotid mannitol infusions and group 2 dogs received isotonic saline. Two infusion procedures were performed in each dog. Dogs were recovered following the first procedure and were monitored for adverse side-effects. A second non-survival procedure followed in 14 - 21 days. Details of the procedure have been previously described [140]. Briefly, a percutaneous transfemoral catheter system was introduced into the internal carotid artery using fluoroscopic guidance and digital subtraction angiography. Both disruption procedures were performed on the same side for each dog. Dogs in group 1 received mannitol (25%) warmed to 37°C and filtered through a 0.20 µm milipore filter. Group 2 dogs received an intracarotid infusion of 0.9% NaCl warmed to 37°C. Using an infusion pump^{***}, the infusate was delivered at a constant rate of 1.7 ml/sec for 30 seconds.

QUANTIFICATION OF DISRUPTION

Brain CT scans were obtained immediately following both disruption procedures using a fourth generation scanner^{†††} and iopamidol enhancement. Scans were acquired in a transverse plane using a 5 mm thickness, 5 mm slice interval, 240 mm field of view, 130 kilovoltage peak, and 105 milliamperge. Infused versus non-infused hemispheres were compared using CT densitometry [140]. Fifteen minutes prior to the second and final disruption, 3 ml/kg of 2% Evan's blue dye was administered intravenously (IV) to provide a visual marker to evaluate BBBD.

^{***} Uropump™, Model 17711, Life-Tech™, Inc., PO Box 36211, Houston TX 77236

^{†††} Picker I.Q./T., Picker International, 595 Miner Road, Highland Heights, Ohio 44143

Following the final procedure, all animals were humanely euthanized by overdose of pentobarbital solution and complete necropsy evaluations performed. All brains were photographed and the degree of Evan's blue staining was graded on a scale of 0-3 as previously described [109]. A score of 0 was assigned if there was no stain uptake, a score of 1 assigned to light staining of the surface and cortical layers, a score of 2 assigned to darker, diffuse cortical staining and light staining of the white matter, and a score of 3 assigned if there was deep blue staining of gray and white matter.

HISTOPATHOLOGICAL EVALUATION

Brains were immersion fixed in 10% neutral buffered formalin and sectioned one week later. Five millimeter coronal slices were grossly evaluated and any abnormal areas as well as sections from the frontal lobe and parietal-temporal lobe were routinely embedded in Surgiplast® paraffin medium. Eight μ m thick hematoxylin and eosin stained sections were prepared and evaluated by light microscopy. Selected areas were also processed for Masson's Trichrome and Perl's iron staining, as well as for glial fibrillary acidic protein (GFAP) immunocytochemistry.

The frontal lobe sections were selected to represent areas supplied by the rostral and middle cerebral arteries and included the rostral caudate nucleus, body of the fornix, and white matter of the corona radiata. The parietal-temporal lobe section included areas supplied by the middle and caudal cerebral artery and contained the posterior commissure and hippocampus.

RESULTS

CATHETERIZATION

Catheterization of the internal carotid artery was successful in four control dogs and all five treatment dogs. However, only 3 of 5 of the treatment dogs survived the first procedure. Two dogs had deteriorating neurologic signs that resulted in death or necessitated euthanasia within an hour and 36 hours after the first disruption respectively.

Of the seven dogs that survived the first procedure, all showed varying degrees of neurologic impairment for the first 12-48 hours after recovery. Neurologic signs included head tilt and circling towards the side of infusion, postural reaction deficits on the side opposite infusion, and visual deficits. While clinical signs were present in both groups, subjectively they were more pronounced in the treatment group.

EVAN'S BLUE STAINING

Three control dogs were given an Evan's blue score of 0 and one control dog was given a score of 1 for staining of the frontal lobe on the side ipsilateral to the infusion

Table 3-1 Gross Lesions						
Dog	Evan's Blue Score ⁽³⁾	Subarachnoid hemorrhage	Hemorrhagic necrosis of the caudate nucleus	Necrosis in area of pyriform lobe and hippocampus	Swelling of cerebral cortex (edema)	coning of cerebellum
Control #1	1	+	-	-	-	-
Control #2	0	-	+	-	-	-
Control #3	0	-	+	-	-	-
Control #4	0	+	-	-	-	-
Treatment #1	3	+	-	-	-	-
Treatment #2	2	-	+	-	-	-
Treatment #3	2	+	+	+	-	-
Treatment #4 ⁽¹⁾	N/A	-	+	+	+	-
Treatment #5 ⁽²⁾	N/A	-	-	-	+	+

⁽¹⁾ Treatment dog #4 was euthanized 36 hours following first disruption for deteriorating neurologic signs secondary to apparent CNS edema.

⁽²⁾ Treatment dog #5 died of apparent brain herniation following first disruption procedure.

⁽³⁾ Graded on a scale of 0-3, see materials and methods

(Table 3-1). One treatment dog was given a score of 3 and the other two treatment dogs, a score of 2. Evan's blue staining tended to be most intense in the area of anterior cerebral artery distribution followed by the area of middle cerebral arterial distribution on the side ipsilateral to the infusion (Figure 3-1). None of the control dogs had evidence of Evan's blue staining of the contralateral hemisphere, while all treatment dogs had blue staining of the contralateral frontal lobe. The stain uptake on the side opposite infusion was less intense than the uptake on the side of infusion in all dogs.

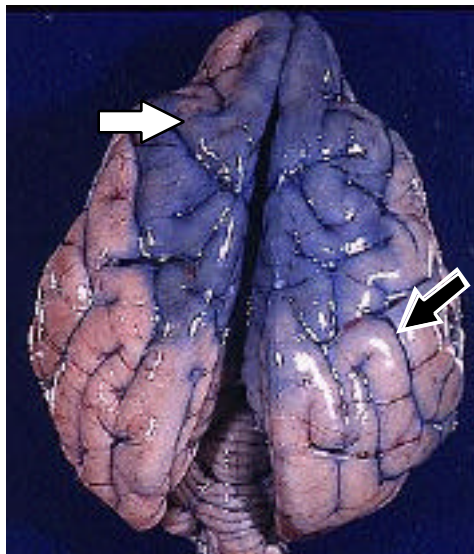

Figure 3-1: Evan's blue staining of a treatment dog. The arterial distribution of anterior cerebral artery (white arrow) and middle cerebral artery (black arrow) can be seen.

GROSS LESIONS

Gross lesions are outlined in Table 3-1. In dogs that died after the first procedure, edema and swelling of the cerebral hemisphere ipsilateral to intracarotid infusion was noted. Coning of the cerebellar vermis suggesting herniation through the foramen magnum was present in the dog that died within an hour of the procedure.

In the remaining dogs that underwent a second procedure, subarachnoid hemorrhage ranging from 5-10 mm was noted at the base of the brain stem in 2 of 4 control dogs and 1 of 3 treatment dogs. In addition, a small area of hemorrhage and necrosis was grossly apparent at the level of the rostral caudate nucleus ipsilateral to intracarotid infusion in 2 of 4 control dogs and 3 of 3 treatment dogs (Figure 3-2). Two additional, 3-4 mm necrotic regions were present in the ipsilateral pyriform lobe and hippocampus in one treatment dog.

HISTOPATHOLOGICAL FINDINGS

Histopathological findings are outlined in Table 3-2. Focal subarachnoid hemorrhage at the base of the brainstem at the level of the hippocampus was seen both grossly and microscopically in 2 of 4 control dogs and 2 of 5 treatment dogs (Figure 3-3). However, the most profound lesions were noted in the rostral caudate nucleus and corticomedullary junction on the side ipsilateral to intracarotid infusion.

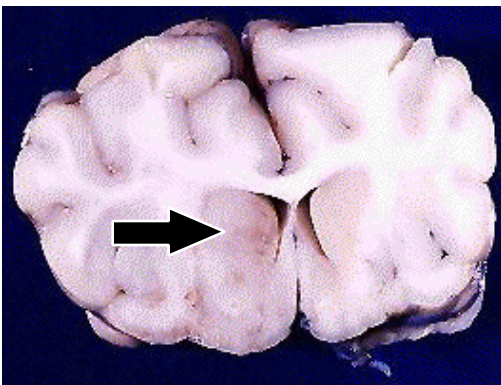

Figure 3-2: Hemorrhage and necrosis at the level of the rostral caudate nucleus on the side of the brain ipsilateral to intracarotid infusion

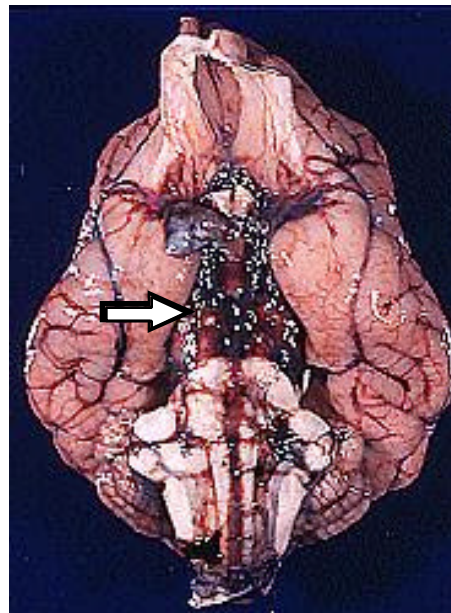

Figure 3-3: Acute subarachnoid hemorrhage at level of thalamic nuclei and hippocampus (arrow).

**Table 3-2
Histopathological Findings**

Dog	Subarachnoid hemorrhage	Hemorrhagic necrosis of the caudate nucleus	Corticomedullary necrosis	Misc.
Control #1	+	-	-	
Control #2	-	+	+	lymphocytic meningitis ⁽³⁾
Control #3	-	+	-	
Control #4	+	-	+	
Treatment #1	+	+	+	
Treatment #2	-	+	+	
Treatment #3	+	+	+	
Treatment #4 ⁽¹⁾	-	+	+	
Treatment #5 ⁽²⁾	-	-	-	

⁽¹⁾ Treatment dog #4 was euthanized 36 hours following first disruption for deteriorating neurologic signs secondary to apparent CNS edema.

⁽²⁾ Treatment dog #5 died of apparent brain herniation following first disruption procedure.

⁽³⁾ Consistent with granulomatous meningoencephalitis

Extensive but focal areas of hemorrhagic necrosis of the rostral caudate was present in 2 of 4 control dogs and all of the treatment dogs except the one that died within an hour of the first procedure. The lesions appeared more chronic in the dogs that received two infusions than in the dog that died within 36 hours of the first infusion. In this animal, lesions were characterized by acidophilic neuronal necrosis and associated neutrophilic infiltration (Figures 3-4 a & b). Little astrocytic hypertrophy was noted in this lesion. Older lesions contained abundant gitter cells, erythrophagocytosis, astrocytosis, hypertrophic endothelium, and vacuolization likely representing edema in the surrounding white matter (Figures 3-5 a & b).

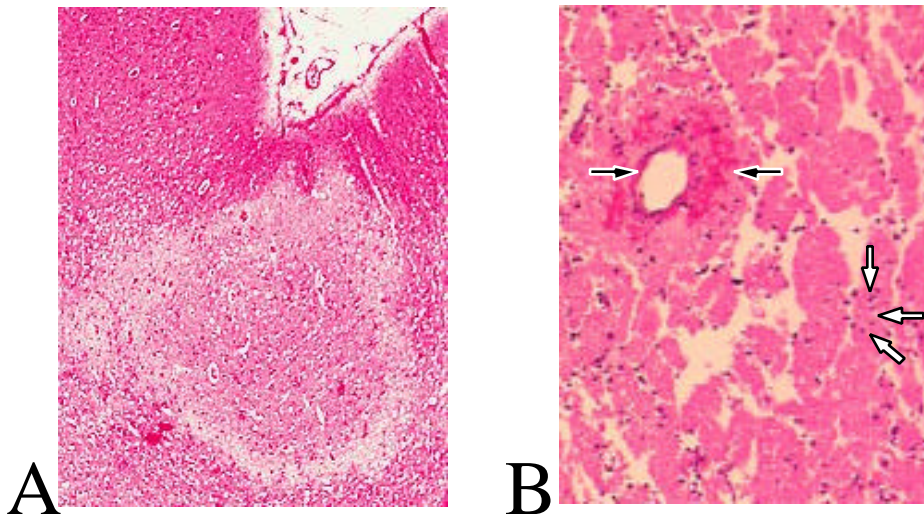

Figure 3-4: Acute hemorrhagic necrosis of caudate nucleus. A) H&E stain at 4x magnification showing pale “penumbral zone” B) 20x magnification of same lesion note neutrophilic infiltration (arrow).

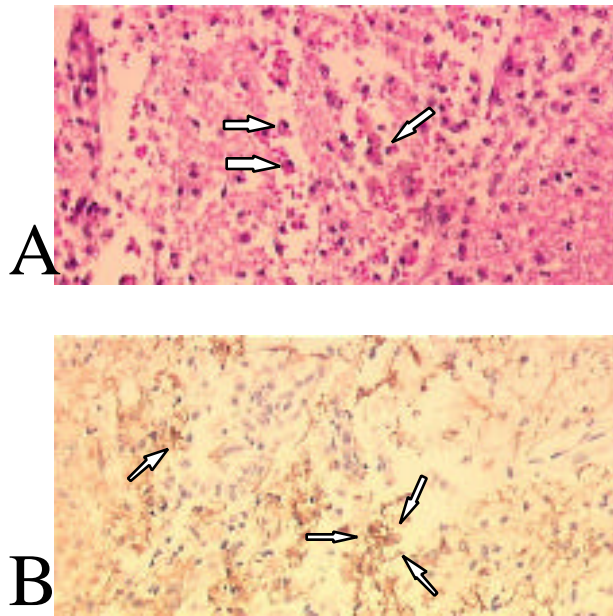

Figure 3-5: Chronic hemorrhagic necrosis of caudate nucleus. A) H&E stain depicting gitter cells (arrows) within an area of hemorrhagic necrosis. B) GFAP stain showing hypertrophic astrocytes (arrows) surrounding the same area of necrosis.

Multifocal areas of necrosis at the corticomedullary junction were seen in the parietal and temporal lobes in 2 of 4 control dogs and 4 of 5 treatment dogs. Differences in chronicity of these lesions were also apparent. As with the caudate nucleus lesion, the treatment dog that died within 36 hours of the first infusion had circumscribed pale areas of necrotic neurons with variable degrees of neutrophilic infiltration and surrounded by areas of vacuolization and edema were apparent (Figures 3-6 a & b). In the double procedure animals there were older lesions in the deep cortical zones, which contained abundant gitter cells, marked astrocytosis, swollen axons, and edema of the surrounding white matter with little or no hemorrhage (Figures 3-7 a & b).

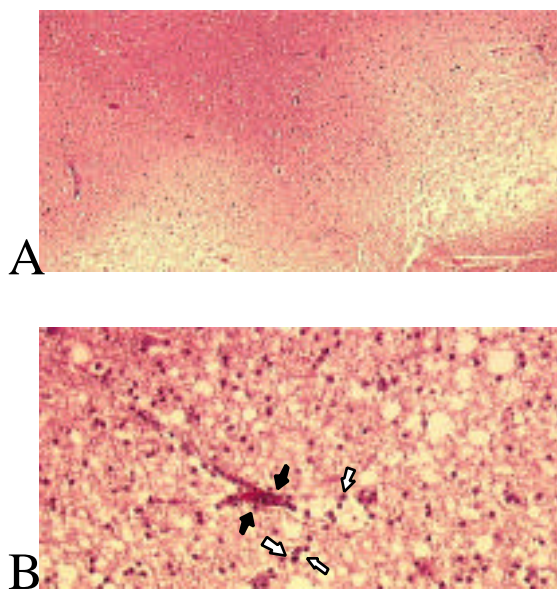

Figure 3-6: Acute necrosis of the corticomedullary junction. A) H&E stain showing pale penumbral zones surrounding area of necrosis. B) Neutrophilic inflammation (white arrows) and hemorrhage (black arrow).

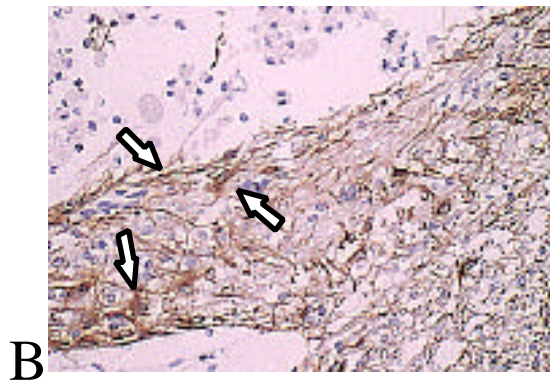
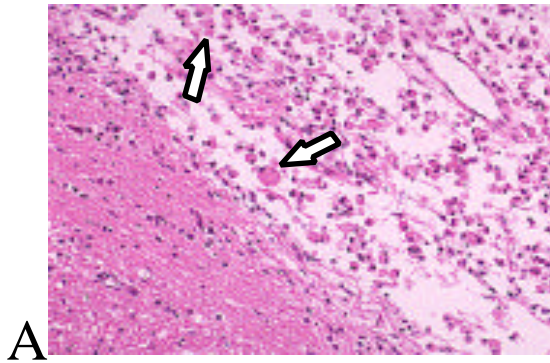

Figure 3-7: Chronic necrosis of the corticomedullary junction. A) H&E stain showing gitter cells (arrows) in an area of necrosis. B) GFAP stain showing marked astrocytosis surrounding cavitory necrosis

Although, many of lesions appeared hemorrhagic, no iron-staining hemosiderin was detected with Perl's iron suggesting that the hemorrhage seen was acute, possibly occurring at the time of final disruption. Collagen deposition did not appear to be a prominent feature of the lesions in trichrome stained sections.

Lymphocytic meningitis consistent with granulomatous meningoencephalitis was seen in one of the control animals, was believed to be an incidental finding and not a procedural complication.

DISCUSSION

The purpose of this paper was to examine the histopathological effects of repeat hyperosmotic BBBD in the dog. All dogs in this study had multifocal areas of ischemic necrosis in the head of the caudate nucleus and the corticomedullary junction of the temporal and parietal lobes on the side of the brain ipsilateral to intracarotid infusion. Because of smaller arterial diameter, lower arterial blood flow and, the presence of boundaries between major arterial territories or "watershed zones", the cerebral corticomedullary junction is particularly susceptible to ischemic injury. Furthermore, selective areas of the brain including the basal ganglion and the ganglionic layer of the cerebral cortex (neuronal laminae V) show selective vulnerability to ischemic injury due to both morphologic and metabolic cellular differences in these areas [164-166].

Temporal evolution of lesions following brain ischemia has been well documented [164, 167]. Histopathological changes following brain ischemia may not be evident for 12-24 hours. This is consistent with the absence of lesions seen in the dog that died one hour after the procedure. Lesions in the dog euthanized 36 hours after the first infusion consisted of well circumscribed pale areas consistent with penumbral zones surrounding neuronal necrosis and neutrophilic infiltration. Lesions in the remainder of dogs euthanized after a second infusion, 2-3 weeks after the first, were characterized by cavitory necrosis containing gitter cells, reactive blood vessels, and surrounding astrocytic proliferation. Therefore, both the morphologic description as well as the evolution of lesions was consistent with multifocal infarction of the brain.

These lesions may be attributable to several different factors related to intracarotid artery infusion. First, infusion of non-filtered hyperosmotic solutions predisposes to embolic brain injury by deposition of particulate matter in cerebral vessels [168]. Furthermore, introduction of air bubbles or blood clots arising from the catheterization technique could contribute to embolization [116]. Interruption of normal blood flow during the procedure could directly contribute to anoxia. Additionally, vascular distention and endothelial cell damage caused by excessive infusion rates could precipitate reflex vasospasm of cerebral vasculature [45, 169-171]. Arterial spasm and vasoconstriction may be exacerbated by non-ionic radiographic contrast media, especially when if the BBB has been disrupted [172]. Finally, hyperosmotic BBBD may lead to extravasation of serum proteins such as fibronectin and fibrinogen leading to both direct damage of blood vessel walls and enhancement of the inflammatory reaction by the mediation of cell-to-cell interactions as well as production of free radicals and cytotoxins [116, 164].

Similar lesions were present in both control and treatment dogs. Therefore, neither the infusion solution nor the consequences of hyperosmotic BBBD can fully explain the lesions. Instead, procedural complications must be at fault. The optimum flow rate for BBBD has been determined to be the rate needed to visibly blanch the cerebral blood vessels. Using this guideline, flow rates of 1.5 ml/sec were found to be optimal in the dog [149, 150]. In the present study, similar flow rates were attempted but after measuring the volume of solution infused, the flow rate was calculated to be 1.7 ml/sec. Excessive flow rates may have caused arterial hypertension and damage to the endothelial cell lining the cerebral vessels. Additionally, extravasation of serum proteins may have lead to fibrinoid necrosis by direct damage of arterial smooth muscle and mediation of inflammatory cell-to-cell interactions. Finally, the use of non-ionic contrast agents to quantify the efficacy of disruption immediately after the procedure may have further contributed to cerebral ischemia.

Although both groups had evidence of cerebral injury, lesions were more dramatic in the treatment group indicating that hyperosmotic solutions worsened the severity of lesions. Hyperosmotic agents commonly cause cerebral edema which may have worsened

the extravasation of serum proteins and other mediators of inflammation into blood-vessel walls and the brain's interstitium. Alternatively, several physiologic and metabolic alterations have been associated with hyperosmotic solutions including elevations in the uptake and metabolism of glucose, increased cerebral oxygen consumption, changes in local cerebral blood flow, and induction of heat shock proteins [117, 118, 163, 173]. It is possible that alterations in the metabolism of cerebral endothelial cells worsened the pre-existing infarctions.

Few studies have carefully examined the morphologic changes associated with hyperosmotic BBBB. Two previous studies, one in the rat [168] and a second brief report in non-human primates [174], found no significant brain changes following hyperosmotic BBBB. Both of these studies examined more acute lesions after just single BBBB. In a series of reports using immunohistochemical staining techniques and electron microscopy, Salahuddin et al. found lesions morphologically similar to those observed in this study. They speculated that arterial hypertension was the primary pathogenesis of the lesions. Furthermore, they postulated that extravasation of serum proteins into blood vessels and surrounding brain tissue worsened the lesions [114-116]. A better understanding of the underlying pathogenesis of the structural changes seen following hyperosmotic BBBB, is clearly needed before procedural modifications can be implemented to decrease the morbidity of this procedure.

Chapter 4: Future Directions

REFINING THE TECHNIQUE

This project successfully showed that repeat hyperosmotic blood-brain barrier disruption (BBBD) in the dog is possible. Refinement of the technique is necessary to decrease clinical and histopathological side-effects before being used in a clinical setting.

Complications of the catheterization technique were rare and when observed, tended to be self-resolving. The catheterization technique described is a safe and effective way of repeatedly catheterizing the intracarotid artery.

In preceding chapters we speculated that both the excessive rate and the pulsatile nature of the carotid infusion contributed to a high morbidity associated with the technique. To better define the margin of safety of this procedure, the morbidity and efficacy of BBBD at a wide range of infusion rates needs further study. Furthermore, comparing use of roller pumps and injector pumps that deliver a non-pulsatile flow would be beneficial.

A number of physiological parameters such as cerebral blood flow, cerebral metabolic rate, cardiac output, and arterial pCO₂ may effect the degree of BBBD. Few studies have evaluated the effects different physiological parameters have on BBBD [113, 119, 127, 175]. The role each of these variables has on BBBD needs further investigation.

CLINICAL USE OF BBBD

BBBD is currently being used to enhance delivery of chemotherapeutic agents for treatment of brain tumors in humans. A national BBBD program exists and is currently carrying out clinical trials using 3 different chemotherapy protocols to treat a variety of primary and metastatic brain tumors [175]. Results of these trials have shown impressive results [57, 134-137, 147, 148]. Without a repeatable technique of BBBD in the dog, similar clinical trials have not been possible in veterinary medicine. However, a few studies have explored the toxicity of various chemotherapeutic agents delivered with BBBD in the dog [126, 127, 151, 152]. These studies together with the current technique of repeatable BBBD opens the way for veterinary clinical studies.

Besides enhancing delivery of traditional chemotherapeutic agents, BBBD offers promise in improving the efficacy of novel therapies. One such novel therapy is the use of monoclonal antibodies (mAb) as targeting agents for both diagnostic and therapeutic molecules. Using neutralizing antibodies to measles, Hicks et al. showed BBBD can

enhance delivery of antibodies into the brain [176]. This enhanced delivery of mAb to the brain, together with recent advancements in the field of immunology make the use of mAb therapy a real possibility.

Many tumor types express unique, tumor associated differentiation antigens to which mAb can be developed. Superparamagnetic iron oxide particles can be conjugated to tumor-specific mAb. Delivery of mAb-iron oxide complex to a tumor would allow for selective binding of iron oxide to the tumor and make histologically-specific diagnoses with MRI [177]. In addition to the use of mAb as diagnostic tools, tumor-specific mAb conjugated with chemotherapeutic drugs or protein toxins offer promise as a novel tumor therapy [178, 179]. Another use of mAb technology links tumor-specific mAb to enzymes. After delivering the mAb-enzyme complex to the tumor, a pro-drug is systemically administered which is converted to a cytotoxic compound within the tumor by the mAb-enzyme complex [180]. Other potential therapeutic uses of mAb technology include, the use of anti-drug mAb to decrease systemic toxicity of chemotherapeutic agents. Following BBBD and delivery of chemotherapeutic agents to the brain, anti-drug mAb can be systemically delivered to bind potentially toxic chemotherapeutic drugs and thus decrease systemic side-effects [181]. Finally, molecularly imprinted polymers or “plastic antibodies” are being studied to function as mAb as in the above described scenarios [182]. Use of plastic antibodies offers the advantage of avoiding potential immunological side-effects seen with use of traditional monoclonal antibodies.

Another potential use of BBBD is delivery of genetic material to the brain. BBBD can enhance CNS penetration of viruses and viral sized particles allowing viral vectors for gene transfer to be delivered to the brain [128, 129, 131, 183]. Recent advances in molecular biology have made gene therapy for the treatment of malignancy as well as neurodegenerative metabolic disorders a realistic goal.

The use of mAb and genetic material to treat CNS disorders are exciting fields now in their infancy. The inability to efficiently deliver mAb and viral vectors to the CNS has been the limiting factor for their use. Blood-brain barrier disruption offers great potential as a tool to deliver these therapeutic agents to the brain. However, further work is required to turn these treatment modalities into useful clinical tools.

OTHER BBB DISRUPTION STRATEGIES

Although intracarotid infusion of hyperosmotic agents is the most studied BBB disruption strategy, other techniques to temporarily disrupt the BBB have been explored. The small margin of safety of hyperosmotic BBBD justifies the further investigation of other BBBD techniques.

Recent studies have explored biochemical methods of BBBD including intracarotid infusion of vasoactive substances such as histamine [184], leukotrienes [98-100] or bradykinin [101, 102]. At low concentrations, the permeabilizing effects of many of these vasoactive substances are highly tumor specific [98, 184, 185]. This offers a potential advantage over hyperosmotic BBBD which indiscriminately increases the permeability of the entire cerebral vasculature. More work is required to better define vasoactive BBBD as well as directly compare vasoactive BBBD to hyperosmotic BBBD.

Less studied methods of BBB disruption include the pharmacological strategy of intra-arterial infusion of drugs that interact physically with the endothelium and enhance vascular permeability such as etoposide, melphalan or protamine [92, 97]. Investigation of pharmacological BBBD is in its infancy and much is left to be learned regarding the mechanism of action and efficacy of these agents.

CONCLUSION

Hyperosmotic BBBD is a proven method of enhancing delivery of therapeutic as well as diagnostic agents to the brain. To improve its use as a clinical tool, more work is needed to better define the physiological and technical variables that affect BBBD. As novel treatment strategies such as monoclonal antibodies and gene therapy are designed, the use of hyperosmotic BBBD to enhance their CNS delivery will need to be studied as well. Finally, as more is learned about the use of vasoactive and pharmacological agents to disrupt the BBB, it will be necessary to directly compare their use with hyperosmotic BBBD in order to develop the safest and most efficient means of disrupting the barrier.

References

1. Davson H: History of the blood-brain barrier concept. In: Neuwelt, ed. Implications of the Blood-Brain Barrier and Its Manipulation, Basic Science Aspects, vol 1. New York: Plenum Press, 1989; 27-52.
2. Goldstein GW, Betz AL: The Blood-Brain Barrier. *Sci Am* 1986; 255(3): 74-83.
3. Johansson BB: The physiology of the blood-brain barrier. *Adv Exp Med Biol* 1990; 274: 25-39.
4. Davson H, Segal MB: Physiology of The CSF and Blood-Brain Barriers. New York: CRC Press, 1995.
5. Brightman MW: The anatomic basis of the blood-brain barrier. In: Neuwelt EA, ed. Implications of the Blood-Brain Barrier and its Manipulation, vol 1. New York: Plenum Publishing Corporation, 1989; 53-83.
6. Rowland LP, Fink ME, Rubin L: Cerebrospinal Fluid: Blood-Brain Barrier, Brain Edema, and Hydrocephalus. In: Kandel ER, Schwartz JH, Jessell TM, eds. Principles of Neuro Science, 3rd ed. Norwalk, Conn: Appleton & Lange, 1991; 1050-1060.
7. Brightman MW, Reese TS: Junctions between intimately apposed cell membranes in the vertebrate brain. *J Cell Biol* 1969; 40: 648-677.
8. Reese TS, Karnovsky MJ: Fine structural localization of a blood-brain barrier to exogenous peroxidase. *J Cell Biol* 1967; 34: 207-217.
9. Reese TS, Feder N, Brightman MW: Electron Microscopic Study of the Blood-Brain and Blood-Cerebrospinal Fluid Barriers with Microperoxidase. *Am Assoc Neuropath* 1970: 137-138.
10. Stewart PA: Developing nervous tissue induces formation of blood-brain barrier characteristics in invading endothelial cells: a study using quail-chick transplantation chimeras. *Dev Biol* 1981; 84: 183-192.
11. Bradbury MWB: The Concept of a Blood-Brain Barrier. . New York: J. Wiley and Sons, 1979.
12. Janzer RC, Raff MC: Astrocytes induce blood-brain barrier properties in endothelial cells. *Nature* 1987; 325: 253-257.
13. Deli MA, Joo F: Cultured vascular endothelial cells of the brain. *Keio J Med* 1996; 45(3): 183-98; discussion 198-9.
14. Pardridge WM, Oldendorf WH, Cancilla P, Frank HJL: Blood-brain barrier: interface between internal medicine and the brain. *Ann Intern Med* 1986; 105: 82-95.
15. Oldendorf WH: The Blood Brain Barrier. In: Lajtha A, ed. Handbook of Neurochemistry, vol 7. New York: Plenum Press, 1984; 485-499.
16. Pardridge WM: Plasma protein-mediated transport of steroid and thyroid hormones. *Am J Physiol* 1987; 252: E157-E164.
17. Rapoport SI: Blood-brain barrier in physiology and medicine. New York: Raven Press, 1976.
18. McCall AL, Millington WR, Wurtman RJ: Metabolic fuel and amino acid transport into the brain in experimental diabetes mellitus. *Proc Natl Acad Sci* 1982; 79: 5406-5410.

19. McCall AL, Chick W, Ruderman N: Chronic hypoglycemia increases brain glucose transport and glucose metabolism by cerebral microvessels [Abstract]. *Diabetes* 1983; 32: 25A.
20. Maher F, Vannucci SJ, Simpson IA: Glucose transporter proteins in brain. *FASEB J* 1994; 8(13): 1003-11.
21. Maddison JE: Hepatic encephalopathy, current concepts of the pathogenesis. *J Vet Intern Med* 1992; 6(6): 341-353.
22. Tyler JW: Hepatoencephalopathy. part II. pathophysiology and treatment. *Compend Contin Educ Pract Vet* 1990; 12(9): 1260-1270.
23. James JH, Escourrou J, Fisher JE: Blood-brain neutral amino acid transport activity is increased after portacaval anastomosis. *Science* 1978; 200: 1395-1397.
24. Frank HJ, Pardridge WM, Morris WL, Rosenfield RG, Cho TB: Binding and internalization of insulin and insulin-like growth factors by isolated brain microvessels. *Diabetes* 1986; 35: 654-661.
25. Pardridge WM, Eisenberg J, Yang J: Human blood-brain barrier insulin receptor. *J Neurochem* 1985; 44: 1771-1778.
26. Banks WA, Kastin AJ: Exchange of peptides between the circulation and the nervous system: role of the blood-brain barrier. In: Porter JC, Jezova D, eds. *Circulating Regulatory Factors and Neuroendocrine Function*. New York: Plenum Publishing Corporation, 1990; 59-69.
27. Guisado R, Ariefe AI: Neurologic manifestations of diabetic comas: correlation with biochemical alterations in the brain. *Metabolism* 1975; 24: 665-679.
28. Bagley RS: Pathophysiologic sequelae of central nervous system tumors. 12th ACVIM Forum, San Francisco, CA, 1994.
29. Johnson GC: Genesis and pathology of tumors of the nervous system. *Semin Vet Med Surg (Small Anim)* 1990; 5(4): 210-222.
30. Farrell CL, Risau W: Normal and abnormal development of the blood-brain barrier. *Microsc Res Tech* 1994; 27(6): 495-506.
31. Greig NH, Jones HB, Cavanagh JB: Blood-brain barrier integrity and host responses in experimental metastatic brain tumors. *Clin Exp Metastasis* 1983; 1: 229-302.
32. Hasegawa H, Ushio Y, Hayakawa T: Changes of the blood-brain barrier in experimental metastatic brain tumors. *J Neurosurg* 1983; 59: 304-309.
33. Levin VA, Freeman-Dove M, Landahl HD: Permeability characteristics of brain adjacent to tumors in rats. *Arch Neurol*. 1975; 32: 785-787.
34. Donelli MG, Zucchetti M, D'Incalci M: Do anticancer agents reach the tumor target in the human brain? *Cancer Chemother Pharmacol* 1992; 30(4): 251-60.
35. Neuwelt EA, Barnett PA, Bigner DD, Frenkel EP: Effects of adrenal cortical steroids and osmotic blood-brain barrier opening on methotrexate delivery to gliomas in the rodent: the factor of the blood-brain barrier. *Proc Natl Acad Sci U S A* 1982; 79(14): 4420-3.
36. Krzanowski JJ: Blood-brain barrier and treatment of central nervous system tumors. *J Florida M.A.* 1992; 79(10): 707-710.

37. Wisniewski HM, Lossinsky AS: Structural and functional aspects of the interaction of inflammatory cells with the blood-brain barrier in experimental brain inflammation. *Brain Pathol* 1991; 1: 89-96.
38. Lo WD, Wolny AC, Timan C, Shin D, Hinkle GH: Blood-brain barrier permeability and the brain extracellular space in acute cerebral inflammation. *J Neurol Sci* 1993; 118: 188-193.
39. Chaturvedi UC, Dhawan R, Khanna M, Mathur A: Breakdown of the blood-brain barrier during dengue virus infection of mice. *J Gen Virol* 1991; 72: 859-866.
40. Tuomanen E: Breaching the blood-brain barrier. *Sci Am* 1993; 268(2): 80-4.
41. Saez-Llorens X, McCracken G, Jr.: Mediators of meningitis: therapeutic implications. *Hosp Pract (Off Ed)* 1991; 26(1): 68-77.
42. Temesvari P, Abraham CS, Speer CP, Kovacs J, Megyeri P: Escherichia coli 0111 B4 lipopolysaccharide given intracisternally induces blood-brain barrier opening during experimental neonatal meningitis in piglets. *Pediatr Res* 1993; 34(2): 182-6.
43. Rosenberg GA, Estrada E, Kelley RO, Kornfeld M: Bacterial collagenase disrupts extracellular matrix and opens blood-brain barrier in rat. *Neurosci Lett* 1993; 160(1): 117-9.
44. Tang J, Xu Z, Douglas FL, Rakhit A, Melethil S: Increased blood-brain barrier permeability of amino acids in chronic hypertension. *Life Sci* 1993; 53: 417-420.
45. Whisson CC, Wilson AJ, Evill CA, Sage MR: The effect of intracarotid nonionic contrast media on the blood-brain barrier in acute hypertension. *Am J Neuroradiol* 1994; 15(1): 95-100.
46. Horton JC, Hedley-Whyte T: Protein movement across the blood-brain barrier in hypovolemia. *Brain Res* 1979; 169: 610-614.
47. Sander D, Klingelhofer J: Circadian blood pressure patterns in four cases with hemodynamic brain infarction and prolonged blood-brain barrier disturbance. *Clin Neurol Neurosurg* 1993; 95(3): 221-9.
48. Bloomstrand C, Johansson B, Rosengren B: Blood-brain barrier lesions in acute hypertension in rabbits after unilateral X-ray exposure of brain. *Acta Neuropathol.* 1975; 31: 97-102.
49. Caveness WF, Carsten AL, Roizin L, Schade JP: Pathogenesis of x-irradiation effects in the monkey cerebral cortex. *Brain Res* 1968; 7: 1-117.
50. Nakagaki H, Brunhart G, Kemper TL, Caveness WF: Monkey brain damage from radiation in the therapeutic range. *J Neurosurg* 1976; 44: 3-11.
51. Prato FS, Wills JM, Frappier RH, et al.: Blood-brain barrier permeability in rats is altered by exposure to magnetic fields associated with magnetic resonance imaging at 1.5 T. *Microsc Res Tech* 1994; 27: 528-534.
52. Salford LG, Brun A, Stureson K, Eberhardt JL, Persson BRR: Permeability of the blood-brain barrier induced by 915 MHz electromagnetic radiation, continuous wave and modulated at 8, 16, 50, and 200Hz. *Microsc Res Tech* 1994; 27: 535-542.
53. Allen JC, Helson L: High-dose cyclophosphamide chemotherapy for recurrent CNS tumors in children. *J Neurosurg* 1981; 55: 749-756.

54. Balis FM, Savitch JL, Bleyer WA, Reaman GH, Poplack DG: Remission induction of meningeal leukemia with high-dose intravenous methotrexate. *J Clin Oncol* 1985; 3: 485-490.
55. Gallo JM, Varkonyi P, Hassan EE, Groothuis DR: Targeting anticancer drugs to the brain: II. Physiological pharmacokinetic model of oxantrazole following intraarterial administration to rat glioma-2 (RG-2) bearing rats. *J Pharmacokinet Biopharm* 1993; 21(5): 575-92.
56. Ichimura K, Ohno K, Aoyagi M, Tamaki M, Suzuki R, Hirakawa K: Capillary permeability in experimental rat glioma and effects of intracarotid CDDP administration on tumor drug delivery. *J Neurooncol* 1993; 16(3): 211-5.
57. Fauchon F, Chiras J, Poisson M, et al.: Intra-arterial chemotherapy by cisplatin and cytarabine after temporary disruption of the blood-brain barrier for the treatment of malignant gliomas in adults. *J Neuroradiol* 1986; 13(3): 151-62.
58. Hill SA, Neuwelt EA: Intra-arterial chemotherapy following blood-brain barrier disruption in a patient with malignant glioma. *J Neurosci Nurs* 1982; 14(2): 94-7.
59. Shapiro WR, Young DF, Mehta BM: Methotrexate: distribution in cerebrospinal fluid after intravenous, ventricular and lumbar injections. *N Engl J Med* 1975; 293(4): 161-166.
60. Miller KT, Wilkinson DS: Pharmacokinetics of methotrexate in the cerebrospinal fluid after intracerebroventricular administration in patients with meningeal carcinomatosis and altered cerebrospinal fluid flow dynamics. *Ther Drug Monit* 1989; 11: 11-16.
61. Kimelberg HK, Kung D, Watson RE, Bourke RS: Direct administration of methotrexate into the central nervous system of primates. *J Neurosurg* 1978; 48: 883-894.
62. Brewster ME: Noninvasive drug delivery to the brain. *Neurobiol Aging* 1989; 10(5): 638-9.
63. Williams JA, Roman-Goldstein S, Crossen JR, D'Agostino A, Dahlborg SA, Neuwelt EA: Preirradiation osmotic blood-brain barrier disruption plus combination chemotherapy in gliomas: quantitation of tumor response to assess chemosensitivity. *Adv Exp Med Biol* 1993; 331: 273-84.
64. Parker AJ: Treatment of brain tumors and encephalitis in the dog and cat. *Prog Vet Med* 1991; 1(2): 133-135.
65. Steinberg HS: Treatment of intracranial neoplasms of dogs and cats. 13th Annual Kal Kan Symposium, 1989, 1989.
66. Braund KG: Neoplasia of the Nervous System. *Compend Contin Educ Pract Vet* 1984; 6(8): 717-722.
67. Ott RJ, Brada M, Flower MA, Babich JW, Cherry SR, Deehan BJ: Measurements of blood-brain barrier permeability in patients undergoing radiotherapy and chemotherapy for primary cerebral lymphoma. *Eur J Cancer* 1991; 27(11): 1356-61.
68. Evans SM, Dayrell-Hart B, Powlis W, Christy G, VanWinkle T: Radiation therapy of canine brain masses. *J Vet Intern Med* 1993; 7(4): 216-219.
69. Crossen JR, Garwood D, Glatstein E, Neuwelt EA: Neurobehavioal sequelae of cranial irradiation in adults: a review of radiation-induced encephalopathy. *J Clin Oncol* 1994; 12(3): 627-642.

- 70.** Duffner PK, Horowitz ME, Kirscher JP, et al.: Postoperative chemotherapy and delayed radiation in children less than three years of age with malignant brain tumors. *N Engl J Med* 1993; 328(24): 1725-1731.
- 71.** Paoletti P: Therapeutic strategy for central nervous system tumors: present status, criticism and potential. *J Neurosurg Sci* 1984; 28(2): 51-60.
- 72.** Heidner GL, Kornegay JN, Page RL, Dodge RK, Thrall DE: Analysis of survival in a retrospective study of 86 dogs with brain tumors. *J Vet Intern Med* 1991; 4(4): 219-226.
- 73.** Genka S, Deutsch J, Shetty UH, et al.: Development of lipophilic anticancer agents for the treatment of brain tumors by the esterification of water-soluble chlorambucil. *Clin Exp Metastasis* 1993; 11(2): 131-40.
- 74.** Greer M: Carrier drugs: Presidential address American Academy of Neurology, 1987. *Neurology* 1988; 38: 628-632.
- 75.** Brewster M, Anderson WR, Bodor N: Brain, blood, and cerebrospinal fluid distribution of a zidovudine chemical delivery system in rabbits. *J Pharm Sci* 1991; 80: 843-846.
- 76.** Bhagrath M, Sidewell RW, Czako K, et al.: Synthesis characterization and antiviral activity of a series of ribavirin chemical delivery systems: 5' and carboxamide derivatives. *Antiviral Chem Chemother* 1991; 2: 265-286.
- 77.** Little RJ, Bailey D, Brewster K, et al.: Brain-enhanced delivery of azidothymidine (AZT). *J Biopharm Sci* 1990; 1: 1-18.
- 78.** Brewster ME, Raghavan K, Pop E, Bodor N: Enhanced delivery of ganciclovir to the brain through the use of redox targeting. *Antimicrob Agents Chemother* 1994; 38(4): 817-23.
- 79.** Brewster ME, Anderson WR, Helton DO, Bodor N, Pop E: Dose-dependent brain delivery of zidovudine through the use of a zidovudine chemical delivery system. *Pharm Res* 1995; 12(5): 796-8.
- 80.** Fresta M, Puglisi G, Di Giacomo C, Russo A: Liposomes as in-vivo carriers for citicoline: effects on rat cerebral post-ischaemic reperfusion. *J Pharm Pharmacol* 1994; 46(12): 974-81.
- 81.** Greig NH, Sweeney DJ, Rapoport SI: Inability of dimethyl sulfoxide to increase brain uptake of water-soluble compounds: implications to chemotherapy for brain tumors. *Cancer Treat Rep* 1985; 69(3): 305-12.
- 82.** Green SL, Mayhew IG, Brown MP, Gronwall RR, Montieth G: Concentrations of trimethoprim and sulfamethoxazole in cerebrospinal fluid and serum in mares with and without a dimethyl sulfoxide pretreatment. *Can J Vet Res* 1990; 54(215-222).
- 83.** Iwen PC, Miller NG: Enhancement of ketoconazole penetration across the blood-brain barrier in mice by dimethyl sulfoxide. *Antimicrob Agents Chemother* 1986; 30(4): 617-618.
- 84.** Neuwelt EA, Barnett P, Barranger J, McCormick C, Pagel MI: Inability of dimethyl sulfoxide and 5-fluorouracil to open the blood-brain barrier. *Neurosurgery* 1983; 12(1): 29-34.

- 85.** Egorin MJ, Kaplan RS, Salzman M, Aisner J, Colvin M: Cyclophosphamide plasma and cerebrospinal fluid kinetics with and without dimethyl sulfoxide. *Clin Pharmacol Ther* 1982; 32(1): 122-128.
- 86.** Keane DM, Gray I, Panuska JA: Ineffectiveness of dimethyl sulfoxide in altering the permeability of the blood-brain barrier. *Cryobiology* 1977; 14: 592-597.
- 87.** Brink JJ, Stein DG: Pemoline levels in brain: enhancement by dimethyl sulfoxide. *Science* 1967; 158: 1479-1480.
- 88.** Broadwell RD, Salzman M, Kaplan RS: Morphological effect of dimethyl sulfoxide on the blood-brain barrier. *Science* 1981; 217: 164-165.
- 89.** Westergren I, Johansson BB: Altering the blood-brain barrier in the rat by intracarotid infusion of polycations: a comparison between protamine, poly-L-lysine and poly-L-arginine. *Acta Physiol Scand* 1993; 149(1): 99-104.
- 90.** Kang YS, Saito Y, Pardridge WM: Pharmacokinetics of [3H]biotin bound to different avidin analogues. *J Drug Target* 1995; 3(2): 159-65.
- 91.** Kang YS, Pardridge WM: Brain delivery of biotin bound to a conjugate of neutral avidin and cationized human albumin. *Pharm Res* 1994; 11(9): 1257-64.
- 92.** Pardridge WM: New approaches to drug delivery through the blood-brain barrier. *Trends Biotechnol* 1994; 12(6): 239-45.
- 93.** Abbott NJ, Romero IA: Transporting therapeutics across the blood-brain barrier. *Mol Med Today* 1996; 2(3): 106-13.
- 94.** Pardridge WM, Kumagai AK, Eisenberg JB: Chimeric peptides as a vehicle for peptide pharmaceutical delivery through the blood-brain barrier. *Biochem Biophys Res Commun* 1987; 146: 307-313.
- 95.** Bickel U, Pardridge WM: Vector-mediated delivery of opioid peptides to the brain. *NIDA Res Monogr* 1995; 154: 28-46.
- 96.** Friden PM: Receptor-mediated transport of therapeutics across the blood-brain barrier. *Neurosurgery* 1994; 35(2): 294-8; discussion 298.
- 97.** Gennuso R, Spigelman MK, Chinol M, et al.: Effect of blood-brain barrier and blood tumor barrier modification on central nervous system liposomal uptake. *Cancer Invest* 1993; 11(2): 118-128.
- 98.** Chio CC, Baba T, Black KL: Selective blood-tumor barrier disruption by leukotrienes. *J Neurosurg* 1992; 77: 407-410.
- 99.** Black KL, King WA, Ikezaki K: Selective opening of the blood-brain barrier by intracarotid infusion of leukotriene C₄. *J Neurosurg* 1990; 72: 912-916.
- 100.** Baba T, Black KL, Ikezaki K, Chen K, Becker DP: Intracarotid infusion of leukotriene C₄ selectively increases blood-brain barrier permeability after focal ischemia in rats. *J Cereb Blood Flow Metab* 1991; 11: 638-643.
- 101.** Black KL: Imaging and drug delivery to tumor-infiltrated brain. *Clin Neurosurg* 1994; 41: 563-72.
- 102.** Inamura T, Black KL: Bradykinin selectively opens blood-tumor barrier in experimental brain tumors. *J Cereb Blood Flow Metab* 1994; 14(5): 862-70.

- 103.** Rapoport SI: Effect of concentrated solutions on the blood-brain barrier. *Am J Physiol* 1970; 219(1): 270-274.
- 104.** Rapoport SI, Hori M, Klatzo I: Testing of a hypothesis for the osmotic opening of the blood-brain barrier. *Am J Physiol* 1972; 223(2): 323-331.
- 105.** Rapoport SI, Fredericks WR, Ohno K, Pettigrew KD: Quantitative aspects of reversible osmotic opening of the blood-brain barrier. *Am J Physiol* 1980; 238: R421-431.
- 106.** Rapoport SI: Osmotic opening of the blood-brain barrier. *Ann Neurol* 1988; 24(5): 677-84.
- 107.** Chiueh CC, Sun CL, Kopin IJ, Fredericks WR, Rapoport SI: Entry of (³H)norepinephrine, (¹²⁵I)albumin, and Evans blue from blood into brain following unilateral osmotic opening of the blood-brain barrier. *Brain Res* 1978; 145: 291-301.
- 108.** Dorovini-Zis K, Sato M, Goping G, Rapoport SI, Brightman M: Ionic lanthanum passage across cerebral endothelium exposed to hyperosmotic arabinose. *Acta Neuropathol (Berl)* 1983; 60: 49-60.
- 109.** Rapoport SI, Matthews K, Thompson HK, Pettigrew KD: Osmotic opening of the blood-brain barrier in the rhesus monkey without measurable brain edema. *Brain Res* 1977; 136: 23-29.
- 110.** Hardebo JE: A time study in rat on the opening and reclosure of the blood-brain barrier after hypertensive or hypertonic insult. *Exp Neurol* 1980; 70: 155-166.
- 111.** Neuwelt EA, Maravilla KR, Frenkel EP: Use of enhanced computerized tomography to evaluate osmotic blood-brain barrier disruption. *Neurosurgery* 1980; 6: 49-56.
- 112.** Neuwelt EA, Glasberg M, Diehl J, Frenkel EP, Barnett P: Osmotic blood-brain barrier disruption in the posterior fossa of the dog. *J Neurosurg* 1981; 55: 742-748.
- 113.** Gumerlock MK, Neuwelt EA: The effects of anesthesia on osmotic blood-brain barrier disruption. *Neurosurgery* 1990; 26(2): 268-77.
- 114.** Salahuddin TS, Johansson BB, Kalimo H, Olsson Y: Structural changes in the rat brain after carotid infusions of hyperosmolar solutions. An electron microscopic study. *Acta Neuropathol (Berl)* 1988; 77(1): 5-13.
- 115.** Salahuddin TS, Johansson BB, Kalimo H, Olsson Y: Structural changes in the rat brain after carotid infusion of hyperosmolar solutions: a light microscopic and immunohistochemical study. *Neuropathol Appl Neurobiol* 1988; 14(6): 467-482.
- 116.** Salahuddin TS, Kalimo H, Johansson BB, Olsson Y: Observations of exudation of fibronectin, fibrinogen and albumin in the rat brain after carotid infusion of hyperosmolar solutions. An immunohistochemical study in the rat indicating long lasting changes in the brain microenvironment and multifocal nerve cell injuries. *Acta Neuropathol (Berl)* 1988; 76(1): 1-10.
- 117.** Richmon JD, Fukuda K, Sharp FR, Noble LJ: Induction of HSP-70 after hyperosmotic opening of the blood-brain barrier in the rat. *Neurosci Lett* 1995; 202(1-2): 1-4.
- 118.** Chi OZ, Wei HM, Lu X, Weiss HR: Increased blood-brain permeability with hyperosmolar mannitol increases cerebral O₂ consumption and O₂ supply/consumption heterogeneity. *J Cereb Blood Flow Metab* 1996; 16(2): 327-33.

- 119.** Neuwelt EA, Kroll RA: Osmotic blood-brain modification: increasing delivery of diagnostic and therapeutic agents to the brain, Vol. 21. New York: Academic Press, 1994 Methods in Neurosciences.
- 120.** Neuwelt EA, Barranger JA, Pagel MA, Quirk JM, Brady RO, Frenkel EP: Delivery of hexosaminidase across the blood-brain barrier in rats. *Neurology* 1984; 34: 1012-1019.
- 121.** Ohno K, Fredericks WR, Rapoport SI: Osmotic opening of the blood-brain barrier to methotrexate in the rat. *Surg Neurol* 1979; 12: 323-328.
- 122.** Nakagawa H, Groothuis D, Blasberg RG: The effect of graded hypertonic intracarotid infusions on drug delivery to experimental RG-2 gliomas. *Neurology* 1984; 34(12): 1571-81.
- 123.** Neuwelt EA, Frenkel EP, D'Agostino AN, Carney DN, Minna JD: Growth of human lung tumor in the brain of the nude rat as a model to evaluate antitumor agent delivery across the blood-brain barrier. *Cancer Research* 1985; 45: 2827-2833.
- 124.** Cosolo W, Christophidis N: Blood-brain barrier disruption and methotrexate in the treatment of a readily transplantable intracerebral osteogenic sarcoma of rats. *Cancer Res* 1987; 47(23): 6225-8.
- 125.** Roman-Goldstein SM, Barnett PA, McCormick CI, et al.: Effects of Gd-DTPA after osmotic BBB disruption in a rodent model: toxicity and MR findings. *J Comput Assisted Tomogr* 1994; 18(5): 731-6.
- 126.** Kroll RA, O'Brien DP, Gumerlock MK, Lattimer LC, Johnson GC: Osmotic opening of the blood-brain barrier to anti-tumor agents. *J Vet Intern Med* 1992; 6(2): 117.
- 127.** Neuwelt EA, Frenkel EP, Rapoport SI, Barnett P: Effect of osmotic blood-brain barrier disruption on methotrexate pharmacokinetics in the dog. *Neurosurgery* 1980; 7(1): 36-43.
- 128.** Neuwelt EA, Pagel MA, Dix RD: Delivery of ultraviolet-inactivated ³⁵S-herpesvirus across an osmotically modified blood brain barrier. 1991.
- 129.** Neuwelt EA, Weissleder R, Nilaver G, et al.: Delivery of virus-sized iron oxide particles to rodent CNS neurons. *Neurosurgery* 1994; 34(4): 777-84.
- 130.** Doran SE, Ren XD, Betz AL, et al.: Gene expression from recombinant viral vectors in the central nervous system after blood-brain barrier disruption. *Neurosurgery* 1995; 36(5): 965-70.
- 131.** Muldoon LL, Nilaver G, Kroll RA, et al.: Comparison of intracerebral inoculation and osmotic blood-brain barrier disruption for delivery of adenovirus, herpesvirus, and iron oxide particles to normal rat brain. *Am J Pathol* 1995; 147(6): 1840-51.
- 132.** Neuwelt EA, Diehl JT, Vu LH, Hill SA, Michael AJ, Frenkel EP: Monitoring of methotrexate delivery in patients with brain tumors after osmotic blood-brain barrier disruption. *Ann Intern Med* 1981; 94(1): 449-454.
- 133.** Markowsky SJ, Zimmerman CL, Tholl D, Soria I, Castillo R: Methotrexate disposition following disruption of the blood-brain barrier. *Ther Drug Monit* 1991; 13(1): 24-31.
- 134.** Neuwelt EA, Goldman DL, Dahlborg SA, et al.: Primary CNS lymphoma treated with osmotic blood-brain barrier disruption: prolonged survival and preservation of cognitive function. *J Clin Oncol* 1991; 9(9): 1580-1590.

- 135.** Neuwelt EA, Howieson J, Frenkel EP, et al.: Therapeutic efficacy of multiagent chemotherapy with drug delivery enhancement by blood-brain barrier modification in glioblastoma. *Neurosurgery* 1986; 19(4): 573-82.
- 136.** Miyagami M, Tsubokawa T, Tazoe M, Kagawa Y: Intra-arterial ACNU chemotherapy employing 20% mannitol osmotic blood-brain barrier disruption for malignant brain tumors. *Neurol Med Chir Tokyo* 1990; 30(8): 582-90.
- 137.** Neuwelt EA, Williams PC, Mickey BE, Frenkel EP, Henner WD: Therapeutic dilemma of disseminated CNS germinoma and the potential of increased platinum-based chemotherapy delivery with osmotic blood-brain barrier disruption. *Pediatr Neurosurg* 1994; 21(1): 16-22.
- 138.** Neuwelt EA, Balaban E, Diehl J: Successful treatment of primary central nervous system lymphomas with chemotherapy after osmotic blood-brain barrier opening. *Neurosurgery* 1983; 12: 662-671.
- 139.** Singh A, Belshe BD, Gumerlock MK: Radionuclide assessment of blood-brain barrier disruption performed for chemotherapy of high grade malignant brain gliomas. *Int J Radiat Appl Instrum Part B* 1991; 18(6): 641-5.
- 140.** Culver BW, Inzana K, Jones J, Troy G, Kroll R, Culver BJ: Repeatable hyperosmotic blood-brain barrier disruption in the dog: technique and complications [Masters]. Virginia Polytechnic Institute and State University; 1997.
- 141.** Kroll R: Personal communication. , 1996.
- 142.** Friedemann U: Blood-Brain Barrier. *Physiol Rev* 1942; 22(2): 125-144.
- 143.** Goldstein GW: Blood-brain barrier in toxic encephalopathies. *Neurobiol Aging* 1994; 15(2): 237-8.
- 144.** Bradbury MWB: The Blood-Brain Barrier: Transport across the Cerebral Endothelium. *Circ Res* 1985; 57(2): 213-222.
- 145.** Selmaj K: Pathophysiology of the blood-brain barrier. *Springer Semin Immunopathol* 1996; 18(1): 57-73.
- 146.** Brightman MW, Hori M, Rapoport SI, Reese TS, Westergaard E: Osmotic Opening of Tight Junctions in Cerebral Endothelium. *J Comp Neurol* 1973; 152: 317-326.
- 147.** Bonstelle CT, Kori SH, Reikate H: Intracarotid chemotherapy of glioblastoma after induced blood-brain barrier disruption. *AJNA. Am J Neuroradiol* 1983; 4(3): 810-2.
- 148.** Neuwelt EA, Hill SA, Frenkel EP: Osmotic blood-brain barrier modification and combination chemotherapy: concurrent tumor regression in areas of barrier opening and progression in brain regions distant to barrier opening. *Neurosurgery* 1984; 15(3): 362-6.
- 149.** Neuwelt EA: Osmotic blood-brain barrier disruption: computerized tomographic monitoring of chemotherapeutic agent delivery. *J Clin Invest* 1979; 64: 684-688.
- 150.** Neuwelt EA, Diehl JT, Hill SA, Maravilla KR: The use of enhanced computerized tomographic cisternography in the evaluation of patients with malignant glioma for immunotherapy. *Neurosurgery* 1979; 5(5): 576-582.
- 151.** Neuwelt EA, Pagel M, Barnett P, Glassberg M, Frenkel EP: Pharmacology and toxicity of intracarotid adriamycin administration following osmotic blood-brain barrier modification. *Cancer Res* 1981; 41: 4466-4470.

- 152.** Neuwelt EA, Glasberg M, Frenkel E, Barnett BS: Neurotoxicity of chemotherapeutic agents after blood-brain modification: neuropathological studies. *Ann Neurol* 1983; 14(3): 316-323.
- 153.** Runge VM, Price AC, Wehr CJ, Atkinson JB, Tweedle MF: Contrast enhanced MRI: evaluation of a canine model of osmotic blood-brain barrier disruption. *Invest Radiol* 1985; 20: 830-844.
- 154.** Seldinger SI: Catheter replacement of the needle in percutaneous arteriography. *Acta Radiol* 1953; 39: 368-376.
- 155.** Neuwelt EA, Specht HD, Howieson J, et al.: Osmotic blood-brain barrier modification: clinical documentation by enhanced CT scanning and/or radionuclide brain scanning. *AJR Am J Roentgenol* 1983; 141(4): 829-35.
- 156.** Roman-Goldstein S, Mitchell P, Crossen JR, Williams PC, Tindall A, Neuwelt EA: MR and cognitive testing of patients undergoing osmotic blood-brain barrier disruption with intraarterial chemotherapy. *AJNR Am J Neuroradiol* 1995; 16(3): 543-53.
- 157.** Neuwelt EA, Barnett PA: Implications of the blood-brain barrier and its manipulation, Vol. 2. New York: Plenum, 1989. Neuwelt EA, ed.
- 158.** Okisaka S, Kuwabara T, Rapoport SI: Selective destruction of the pigmented epithelium in the ciliary body of the eye. *Science* 1974; 184: 1298-1299.
- 159.** Millay RH, Klein ML, Shults WT, Dahlborg SA, Neuwelt EA: Maculopathy associated with combination chemotherapy and osmotic opening of the blood-brain barrier. *Am J Ophthalmol* 1986; 102(5): 626-32.
- 160.** De Lahunta A: Veterinary neuroanatomy and clinical neurology, 2 ed. Philadelphia: W. B. Saunders, 1983.
- 161.** Neuwelt EA: Therapeutic potential for blood-brain barrier modification in malignant brain tumor. *Prog Exp Tumor Res* 1984; 28: 51-66.
- 162.** Gumerlock MK, York D, Durkis D: Visual evoked responses as a monitor of intracranial pressure during hyperosmolar blood-brain barrier disruption. *Acta Neurochir Suppl (Wien)* 1994; 60: 132-5.
- 163.** Hardebo JE, Nilsson B: Hemodynamic Changes in Brain Caused by Local Infusion of Hyperosmolar Solutions, In Particular Relation to Blood-Brain Barrier Opening. *Brain Res* 1980; 181: 49-59.
- 164.** Kalimo H, Kaste M, Haltia M: Vascular disease. In: Graham DI, Lantos PL, eds. *Greenfield's neuropathology*, 6 ed. London: Arnold, 1997.
- 165.** Garcia JH: Pathophysiology of ischemic injury to the brain. In: Nelson JS, Parisi JE, Schochet SS, eds. *Principles and practice of neuropathology*, 3 ed. St. Louis: Mosby, 1995; 459-469.
- 166.** Summers BA, Cummings JF, de Lahunta A: *Veterinary Neuropathology*, 1 ed. St. Louis: Mosby, 1995.
- 167.** Petito CK: Cerebrovascular disease. In: Nelson JS, Parisi JE, Schochet SS, eds. *Principles and practice of neuropathology*. St. Louis: Mosby, 1994; 436-458.
- 168.** Tomiwa K, Hazama F, Mikawa H: Reversible osmotic opening of the blood-brain barrier. prevention of tissue damage with filtration of the perfusate. *Acta Pathologica* 1982; 32: 427-435.

- 169.** Westergaard E: The blood-brain barrier to horseradish peroxidase under normal and experimental conditions. *Acta Neuropathol* 1977; 39: 181-187.
- 170.** Brightman MW, Klatzo I, Olsson Y, Reese TS: The Blood-Brain Barrier to Proteins under Normal and Pathological Conditions. *J Neurol Sci* 1970; 10: 215-239.
- 171.** Nagy Z, Mathieson G, Hunter I: Opening of Tight Junctions in Cerebral Endothelium: Effect of Pressure-Pulse induced acute hypertension. *J Comp Neurol* 1979; 185: 579-586.
- 172.** Torvik A, Walday P: Neurotoxicity of water-soluble contrast media. *Acta Radiol Suppl* 1995; 399: 221-9.
- 173.** Pappius HM, Savaki HE, Fieschi C, Rapoport SI, Solokoff L: Osmotic opening of the blood-brain barrier and local cerebral glucose utilization. *Ann Neurol* 1979; 5: 211-219.
- 174.** Rapoport SI, Bachman DS, Thompson HK: Chronic effects of osmotic opening of the blood-brain barrier in the monkey. *Science* 1972; 176: 1243-1244.
- 175.** Kroll RA, Neuwelt EA: Opening the blood-brain barrier. *J Neurosurg* 1997; in press.
- 176.** Hicks JT, Abrecht P, Rapoport SI: Entry of neutralizing antibody to measles into brain and cerebrospinal fluid of immunized monkeys after osmotic opening of the blood-brain barrier. *Exp Neurology* 1976; 53: 768-779.
- 177.** Remsen LG, McCormick CI, Roman-Goldstein S, et al.: MR of carcinoma-specific monoclonal antibody conjugated to monocrySTALLINE iron oxide nanoparticles: the potential for noninvasive diagnosis. *AJNR Am J Neuroradiol* 1996; 17: 411-418.
- 178.** Trail PA, Willner D, Lasch SJ, et al.: Cure of xenografted human carcinomas by BR96-doxorubicin immunoconjugates. *Science* 1993; 261: 212-215.
- 179.** Youle RJ: Immunotoxins for central nervous system malignancy. *Semin Cancer Biol* 1996; 7(2): 65-70.
- 180.** Kerr DE, Schreiber GJ, Vruthula VM, et al.: Regressions and cures of melanoma xenografts following treatment with monoclonal antibody B-lactamase conjugates in combination with anticancer prodrugs. *Cancer Res* 1995; 55: 3558-3563.
- 181.** Kroll RA, Pagel MA, Langone JJ, Neuwelt EA: Differential permeability of the blood-tumor barrier in intracerebral tumor-bearing rats: anti-drug antibody to achieve systemic drug rescue. *Therap Immunol* 1994; 1: 333-341.
- 182.** Mosbach K, Ramstrom O: The emerging technique of molecular imprinting and its future impact of biotechnology. *Biotechnology* 1996; 14: 163-170.
- 183.** Dorn Rd, Spickard JH, Griebenow ML: The effects of ionizing radiation and dexamethasone on the blood-brain-barrier and blood-tumor-barrier: implications for boron neutron capture therapy of brain tumors. *Strahlenther Onkol* 1989; 165(2-3): 219-21.
- 184.** Inamura T, Nomura T, Ikezaki K, Fukui M, Pollinger G, Black KL: Intracarotid histamine infusion increases blood tumor permeability in RG2 glioma. *Neurol Res* 1994; 16: 125-128.
- 185.** Nomura T, Inamura T, Black KL: Intracarotid infusion of bradykinin selectively increases blood-tumor permeability in 9L and C6 brain tumors. *Brain Res* 1994; 659: 62-66.

Vita

Britt Wayne Culver was born and raised in Laramie Wyoming where he attended Laramie High School and the University of Wyoming. Following his undergraduate work he received his Doctorate of Veterinary Medicine from Colorado State University in 1993. During veterinary school he met his wife Brenda. After veterinary school, Britt and Brenda went on to complete one year internships in small animal medicine and surgery at Purdue University. Following his internship Britt has been at Virginia-Maryland Regional College of Veterinary Medicine as a graduate student while completing a three year residency in small animal internal medicine. Following completion of his residency and masters program, Britt will finish his requirements for board certification in the American College of Veterinary Internal Medicine. Britt and his wife, plan to move to Helena Montana with their son, Barron, and open a referral veterinary hospital.