



LuckyPaws

Corey Salmon, Ramya Nandigam, Swathi Nagaraja, Tao Zeng, Shraddha Shinde

Introduction

LuckyPaws is a comprehensive web application for animal care, pet adoption, lost & found pets, and services that brings the animal-loving community together.

Why LuckyPaws?

- There's a gap in the current market for an application with features like pet adoption, pet rescue, reporting a missing pet, and pet gathering event scheduling **under one single platform.**
- Our solution, LuckyPaws, provides all of these features and more in a one-stop-shop for all the things pets need.

Primary Features & Target Users

- We provide the following features:
 - Pet Adoption Services
 - Pet Rescue Services
 - Search for Pets
 - Report Lost/Found Pet
 - Pet Gathering Event Scheduling
- for the following target users:
 - People who want to adopt a pet or put their pet up for adoption
 - People who are searching for their missing pets
 - People who found a missing pet
 - People with pets who want to connect with the pet owner community and share lessons learned

Tech Stack, IDEs and Tools

Front-End	Vue.js
Back-End	Java Spring Boot
DataBase	MySQL
IDEs & Tools Used	IntelliJ, Postman

Application Architecture

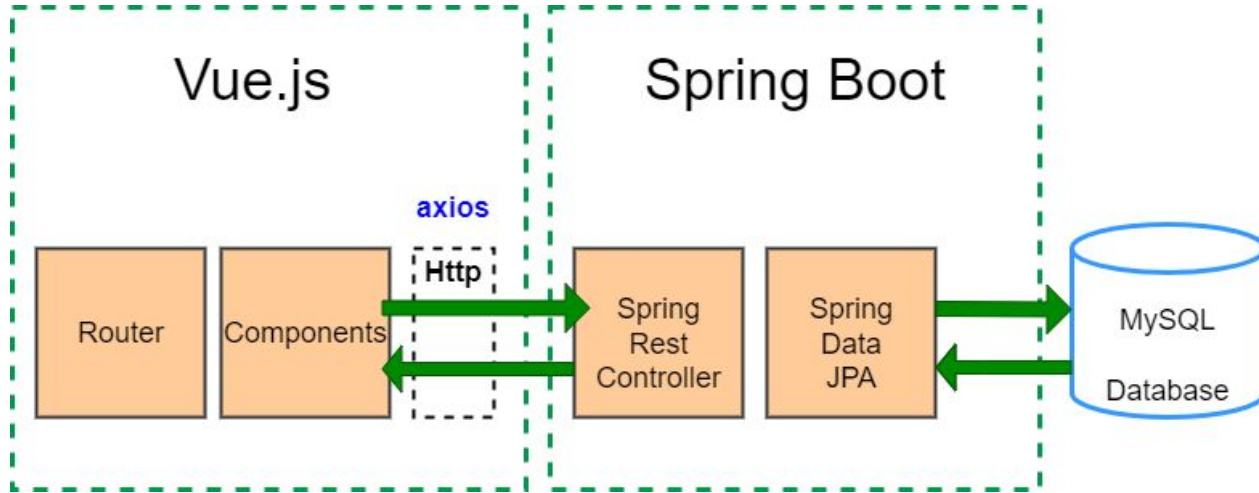

DataBase Design

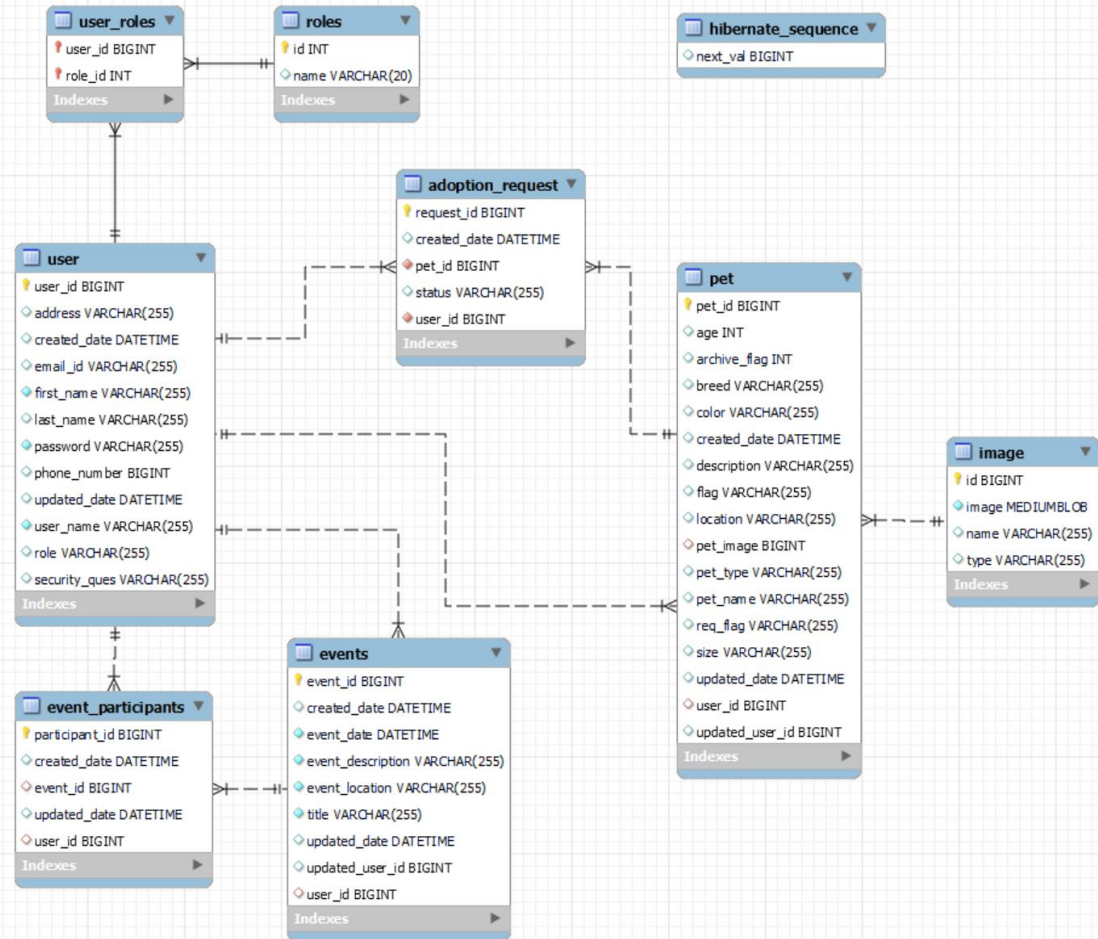

Service API (Restful API)

```
@PostMapping("/auth/signin")  
@PostMapping("/auth/signup")
```

```
@GetMapping("/users")  
@GetMapping("/user/{id}")  
@PutMapping("/user/{id}")  
@DeleteMapping("/user/{id}")
```

```
@GetMapping("/events")  
@GetMapping("/events/{id}")  
@PostMapping("/events")  
@PutMapping("/event/{id}")  
@DeleteMapping("/event/{id}")  
@PostMapping("/events/eventPartici  
pant")
```

```
@PostMapping("/image")  
@GetMapping(path = {"/image/ID/{id}"})  
@GetMapping(path = {"/image/name/{name}"})
```

```
@GetMapping("/pets")  
@GetMapping("/pets/type/{type}")  
@GetMapping("/pets/breed/{breed}")  
@GetMapping("/pets/flag/{flag}")  
@GetMapping("/pet/{id}")  
@GetMapping("/pets/search/{searchParam}")  
@GetMapping("/pets/request/{user_id}")  
@RequestMapping(path = "/pets", method = POST, consumes =  
{ MediaType.MULTIPART_FORM_DATA_VALUE })
```

Cloud Deployment

<https://luckypaws.discovery.cs.vt.edu/>

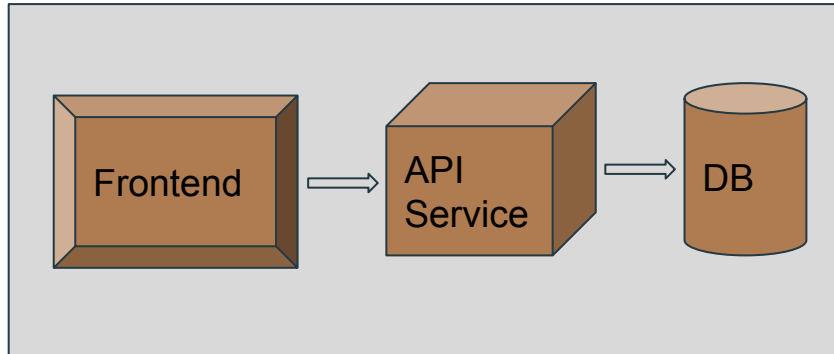

Tried Deployment Strategy

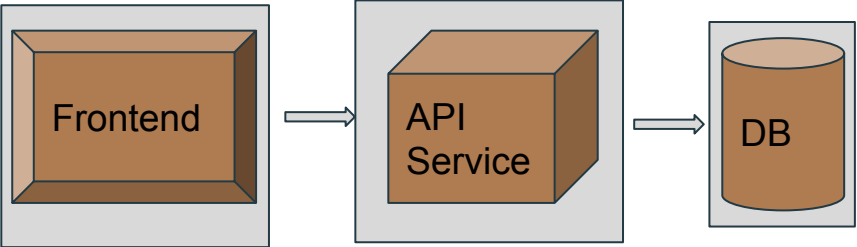
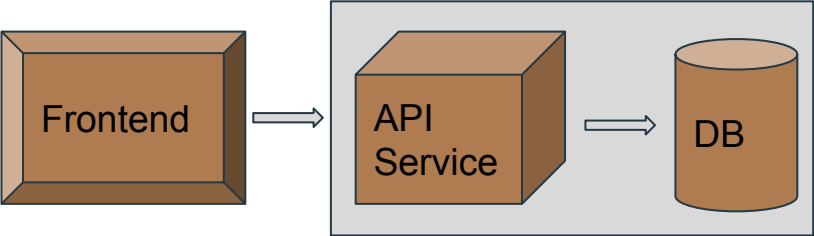
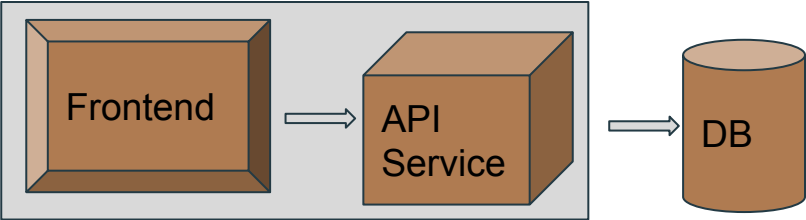

Difficulties Encountered

- **Implementing Session management in the application:**

Addressed by doing some research on similar implementation and applying in our application.

- **Unstable Cloud service:**

Discussed with Prof. and resolved the issue with the help of IT Tech staff.

Demonstration

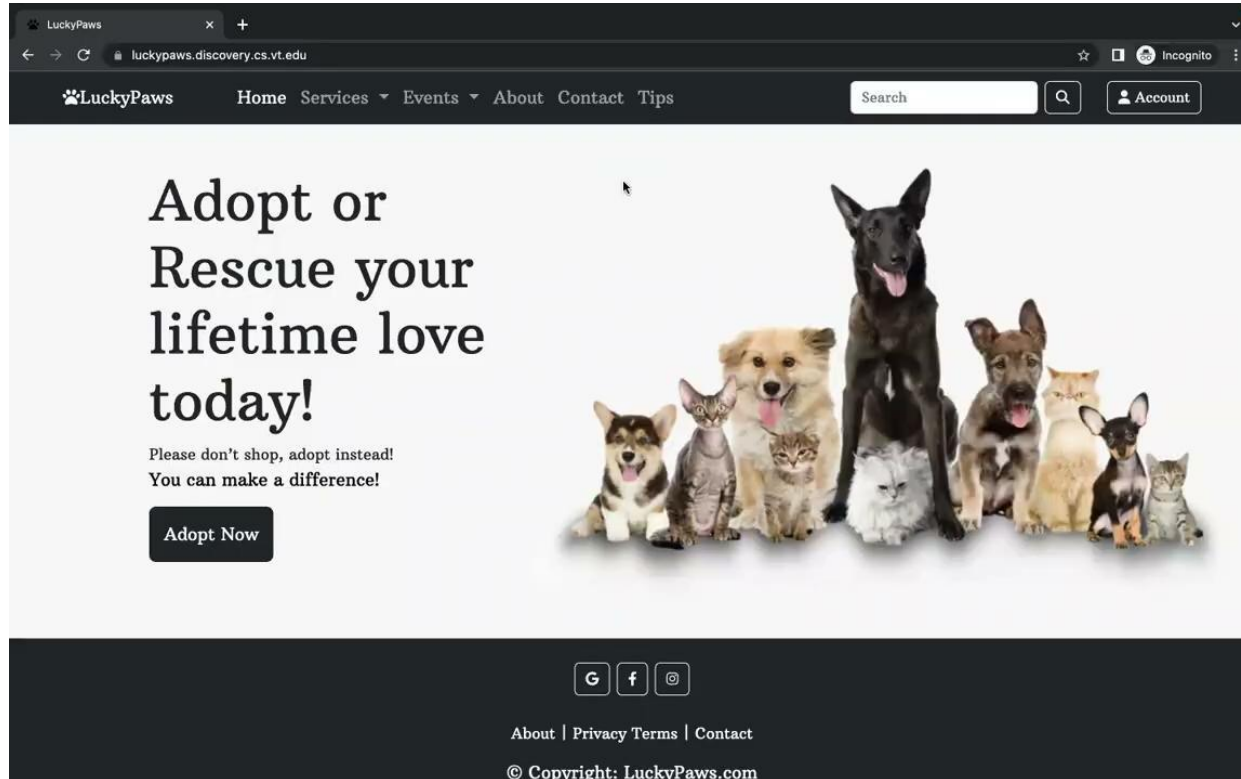

The screenshot shows a web browser window with the URL `luckypaws.discovery.cs.vt.edu`. The website header includes the logo "LuckyPaws" and navigation links: "Home", "Services", "Events", "About", "Contact", and "Tips". There is a search bar and an "Account" link. The main content area features the text "Adopt or Rescue your lifetime love today!" and a sub-message: "Please don't shop, adopt instead! You can make a difference!". A prominent "Adopt Now" button is located below the text. To the right of the text is a group of various dogs and cats. The footer contains social media icons for Google+, Facebook, and Instagram, along with links for "About", "Privacy Terms", and "Contact", and a copyright notice: "© Copyright: LuckyPaws.com".

LuckyPaws Home Services Events About Contact Tips Search Account

Adopt or Rescue your lifetime love today!

Please don't shop, adopt instead!
You can make a difference!

[Adopt Now](#)

[G](#) [f](#) [@](#)

[About](#) | [Privacy Terms](#) | [Contact](#)

© Copyright: LuckyPaws.com

Search Functionality

LuckyPaws Home Services ▾ Events ▾ About Contact Tips dog Account

Search Results

Request ID	Pet Type	Created by	Created date	Pet Breed	Request Type
35	Dog	Shraddha	December 4, 2022	Labrador	Adoption
37	Dog	Shraddha	December 4, 2022	Lab	Adoption
38	Dog	Shraddha	December 4, 2022		Found

[G](#) [f](#) [@](#)

[About](#) | [Privacy Terms](#) | [Contact](#)

© Copyright: LuckyPaws.com

User Profile Page

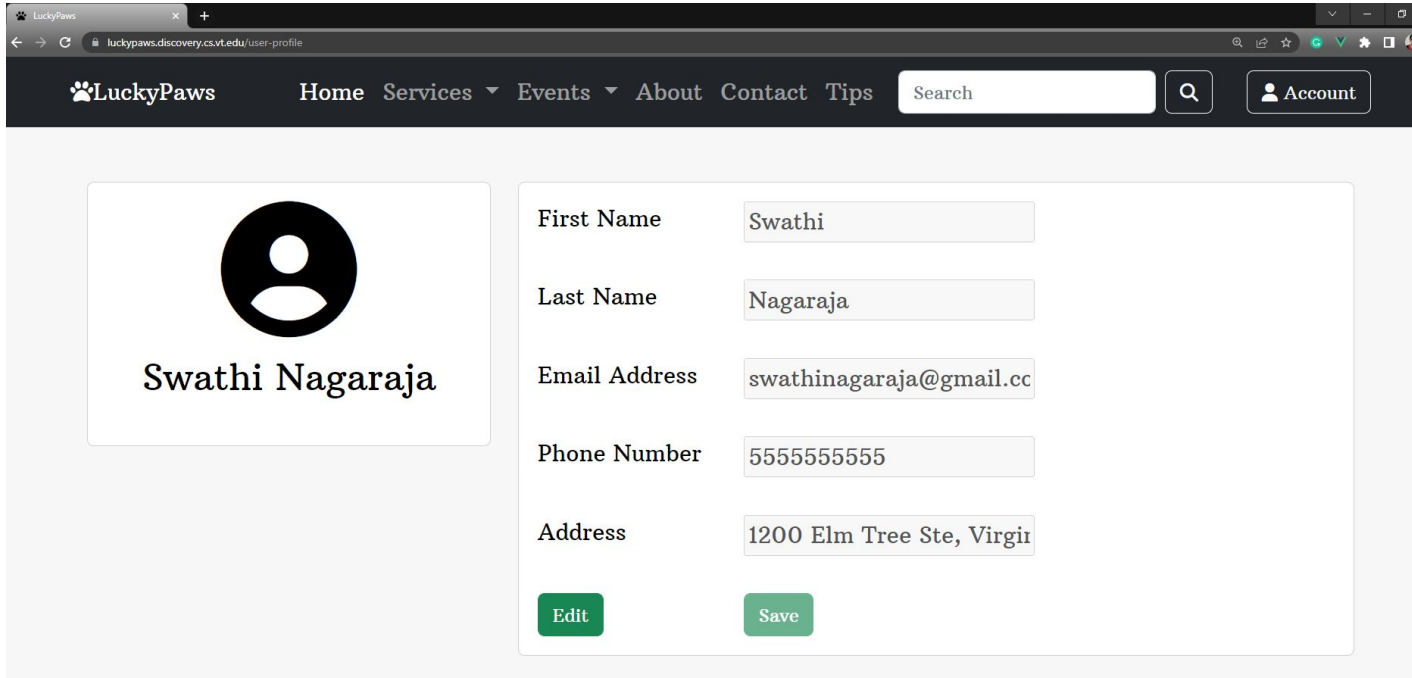

The screenshot shows a web browser window with the URL `luckypaws.discovery.cs.vt.edu/user-profile`. The page header includes the LuckyPaws logo and navigation links: Home, Services, Events, About, Contact, and Tips. A search bar and an Account button are also present. The main content area displays a user profile for Swathi Nagaraja. The profile includes a placeholder for a profile picture and the name Swathi Nagaraja. To the right, there is a form with the following fields:

First Name	Swathi
Last Name	Nagaraja
Email Address	swathinagaraja@gmail.cc
Phone Number	5555555555
Address	1200 Elm Tree Ste, Virgiri

At the bottom of the form, there are two green buttons: "Edit" and "Save".

Reset Password Functionality

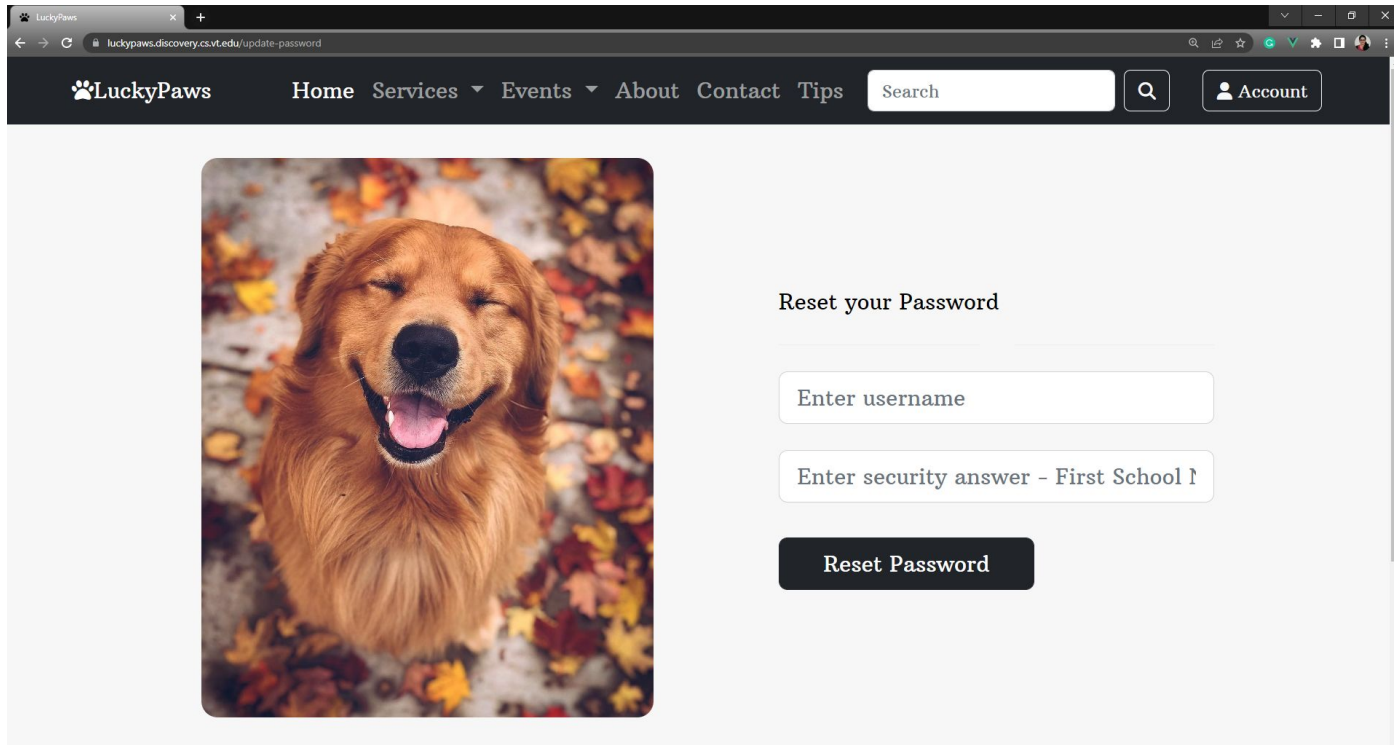

The screenshot shows a web browser window with the URL `luckypaws.discovery.cs.vt.edu/update-password`. The website header includes the "LuckyPaws" logo, navigation links for "Home", "Services", "Events", "About", "Contact", and "Tips", a search bar, and an "Account" button. The main content area features a large image of a golden retriever on the left and a "Reset your Password" form on the right. The form consists of two input fields: "Enter username" and "Enter security answer - First School", followed by a "Reset Password" button.

LuckyPaws Home Services ▾ Events ▾ About Contact Tips Search Account



Reset your Password

Enter username

Enter security answer - First School ↓

Reset Password

Lessons Learned & Reflections

Lessons Learned :

- Team communication is vital
- Check in often / Progress report
- Get feedback from team members
- Get tasks completed early
- Give enough time for Testing phase

Potential Scope for Improvement :

- Collaborate with NGOs for Pet rescue
- Notify the user via email regarding Pet Adoption request approval

Q & A