

a study of placemaking

# RED WALL

Sarah McInerney

Thesis submitted to the faculty of Virginia  
Polytechnic Institute and State University in  
partial fulfillment of the requirements for the  
degree of

Master of Architecture

---

Michael O'Brien

---

William Brown

---

William Galloway

January 2006

---

dedication

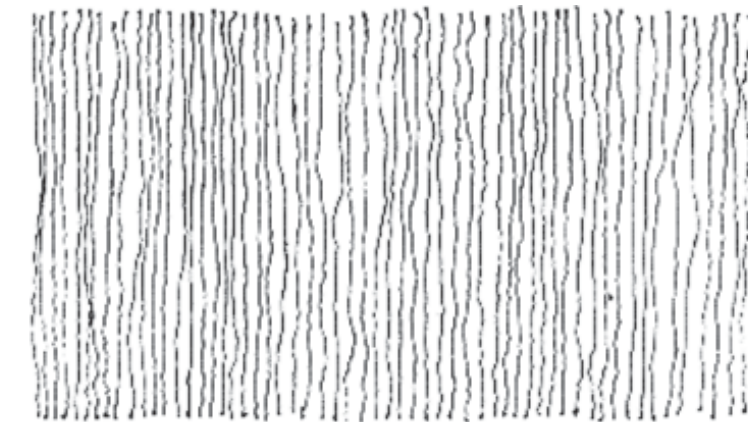

in memory of

phillip anthony cosco

the chats.  
the knowledge.  
the drawings.  
the architecture.  
the coffee.  
the italian.  
the lectures.  
the sketches.  
the lunches.  
the books.  
the dedication.  
the respect.  
the pinups.  
the buildings.  
the thesis.  
the **friendship.**

i will never forget.

mac

**i would like to thank everyone who has supported me through this process.**

my committee; **mike, bill, bill**. for being ever so patient and understanding.

**hans, camden**. thank you for your advice.

my family; **mom, dad, jo**. thank you for all of your support, love, and mostly patience.

my friends; **bjd, phil, todd, bacha, yofis, andrea**. this experience has been an incredible life lesson. i miss you all.

and **therese**. thank you. your friendship is invaluable.

**most important**, my daughter; **ryan**. i couldn't have done it better (or quicker) without you.

in which the details can be explored thoroughly with an understanding of construction through experience, detail, and context. *a small house...*

<b>dedication</b>	2
<b>acknowledgments</b>	4
<b>abstract</b>	6
<b>the elements</b>	
the site	12
the red wall	16
the sun wall	32
the wind wall	40
three volumes	46
<b>the house</b>	
an entrance	54
a place to eat	58
a porch	60
a place to live	64
the bridge	68
a place to rest	70
a private place	74
the yard	76
<b>conclusion</b>	78
<b>vita</b>	80



## the site



What once was the suburbs of the City of Richmond is now downtown. As the state of Oregon was to Virginia, **Oregon Hill** received its name because it was perceived as being far from city center. This *tight knit community* lies just south of Virginia Commonwealth University. The Robert E. Lee Bridge and Hollywood Cemetery bordering on the East and West, respectively. The James River defines the southern edge.

Oregon Hill is a historical neighborhood that many nonprofit organizations protect. Save Oregon Hill Organization (SOHO), has protected Oregon Hill from large corporations that have attempted to encroach and to destroy the integrity of the community. In addition, Oregon Hill Housing Improvement Council (OHHIC) has been restoring the community, building new homes that look like the original buildings. Of the **1000 original houses**, 478 remain intact.

*“Oregon Hill is one of the best examples of an intact working-class Victorian (1837-1901) neighborhood in the United States.... The majority worked at the Tredegar Iron Works, or as carpenters, masons and other tradesmen or laborers. Most houses were built between 1860 and 1900”*

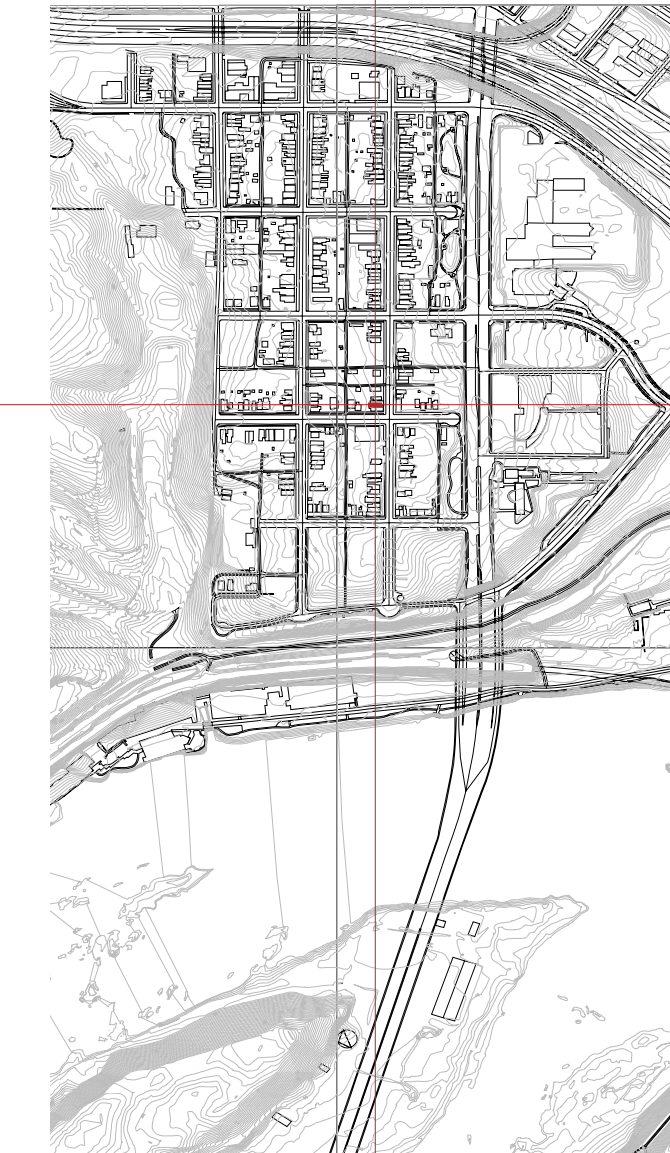



Oregon Hill is a network of one-way streets. To a newcomer, this network creates an intimidating obstacle. Pine Street runs one-way north. **522 Pine Street** faces east stretching 21'-0" wide and extending 90'-0" back sloping away from the house 4'-0". There is no alley; the site backs onto another property. Two original single-family houses flank the site; these houses have few windows facing into the site.

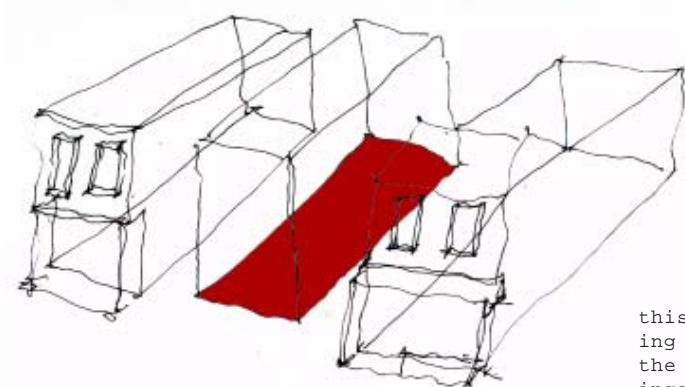

this sketch allowed an understanding of the spatial relationships of the site and the adjacent buildings.

The sidewalks in **Oregon Hill** are red brick in herringbone pattern, uneven due to the natural interruption of tree roots. These interruptions make walking a challenge.

Most of the original houses in Oregon Hill are constructed of light wood framing with brick foundations and clad with wood. A typical site is 20' x 90'. The sense of ownership is evident: yards are defined by a gate or wall and are well kept. Defined entry paths lead to the porch and the front door. Careful observations of humble elements informed the decisions made in this thesis.







# RED WALL

16|

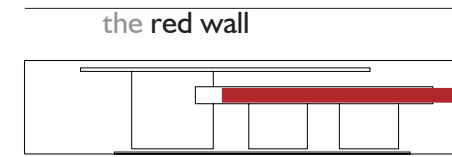

The color red (tuscan red) differentiates significant elements in my project. I came to realize that there was a red wall to be found in the project. Beyond the literal, these walls became symbolic of an event unique to the project. The walls led to discovery. What did it mean to be a red wall? What is the event of a small house?

The red has to have a presence in the house, inside and out: allowing the wall to make an impact on the house, from the interior and exterior, simultaneously.

It is to be a directional element – whether by north, south, east, west, or by being able to know your location within the building.

Touch it, walk through it. Experience the wall on many levels.

Depend on it structurally, mechanically – taking advantage of the interiors of a hollow wall.

Take from the wall, and give it back – additions, or subtractions physically to the wall.

|17

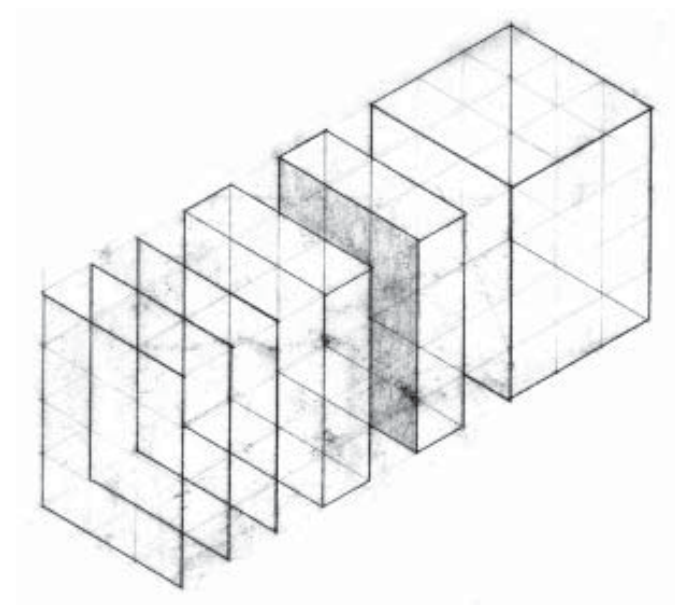

**Volume sketches** allow the ability to view spatial relationships. An early sketch, geometrically differentiating the site, turned into a typical volume sketch. This sketch was questioned early in the project as to what it was. These sketches are *beginings*.

Thoughts.

Ink on a blank page.

red wall and a volume sketch of the site lead to the ideal.

I realized late into this project that these sketches appeared throughout my sketchbook. These sketches served as studies in three-dimensional proportion.

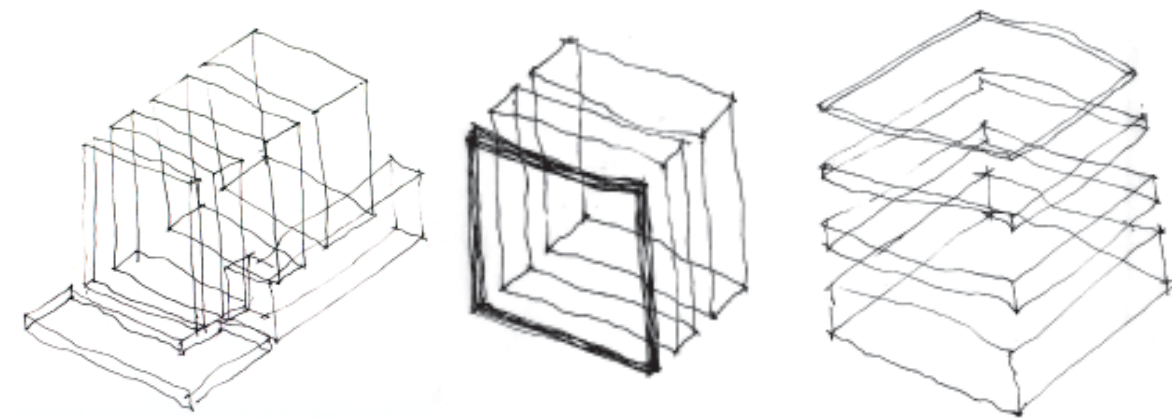

Combining the volume sketch and an additional volume, that becomes the red wall. This shows the intended relationship between the volumes and red wall.

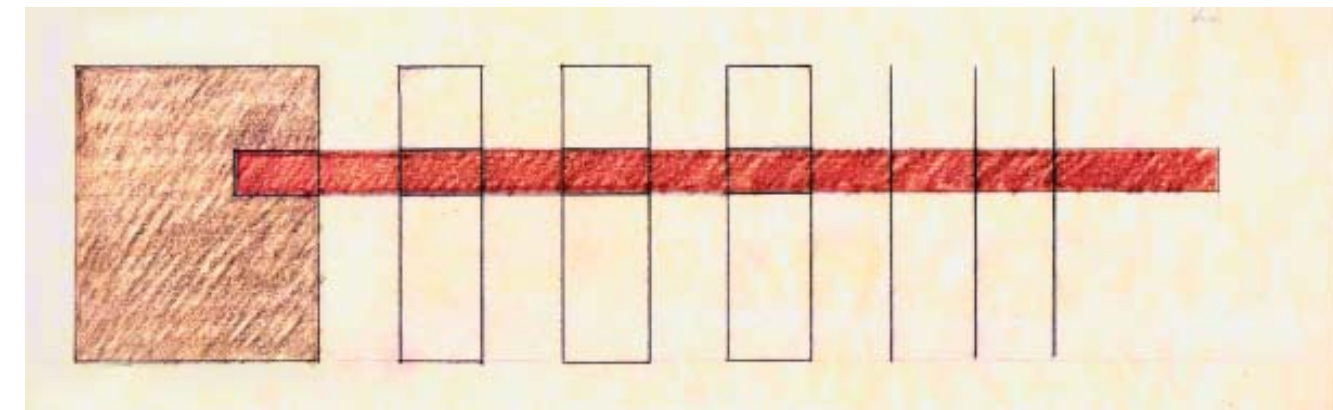

a diagram of a combination of red wall and volume sketches.

**ideal.**

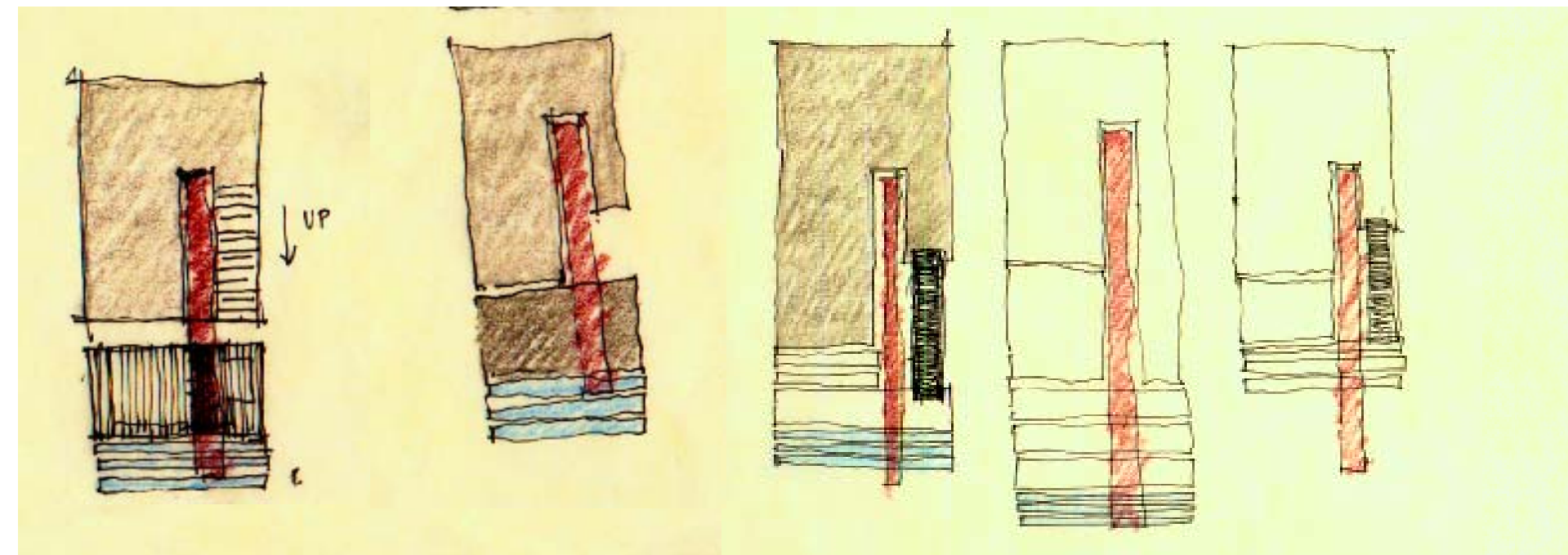

sketches incorporating the program into the ideal sketch.

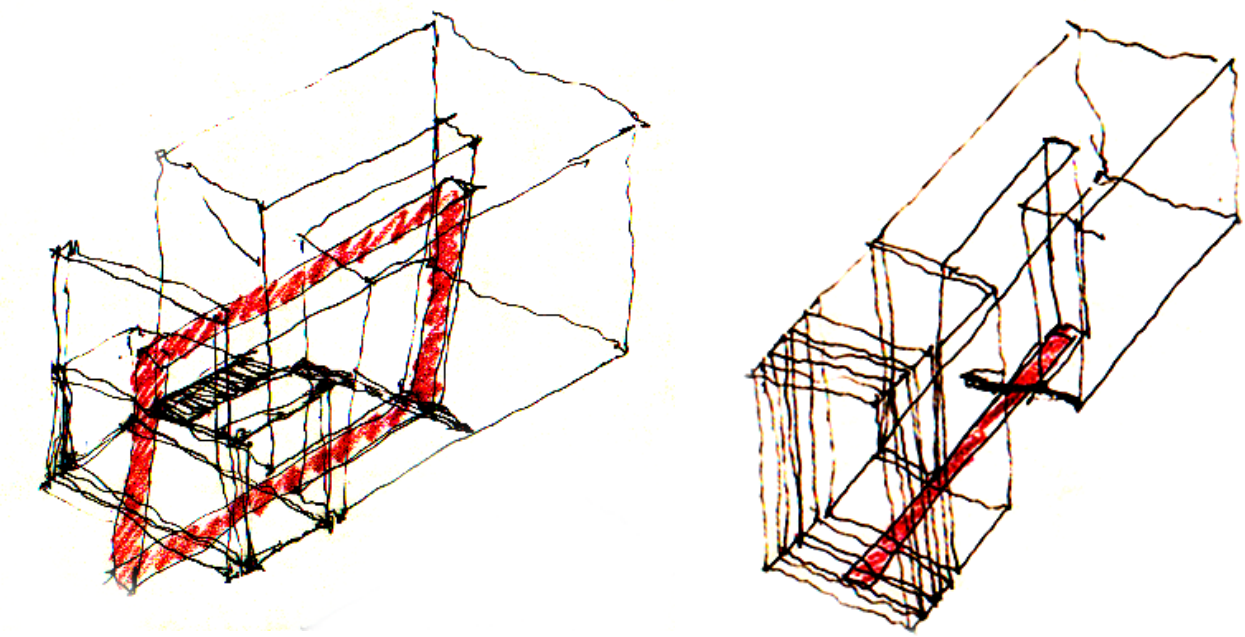

The **red wall** is brick. Brick, not because it is or can be red.

The red wall extends beyond the house; therefore, it is inside, outside, above and below and requires a material that could do all these things.

Exploration of alternative construction for the red wall included studs with brick veneer, CMU with brick veneer, and solid brick wall. This led to the decision to use **reinforced concrete masonry construction**. Since a reinforced concrete masonry wall is poured four courses at a time, it offers the flexibility of openings, rotations, and corbelling.

The bricks play an important role in the wall. There is a great flexibility in how the bricks are laid as formwork, compared to a traditional solid brick wall. The bricks rely on the concrete and the concrete relies on the bricks; the bricks do not rely on each other since the concrete bonds them together.

The wall can also accommodate wiring, plumbing, and mechanical chases.

The red wall is the core of the house.

exploration of a joist connection at the second floor.

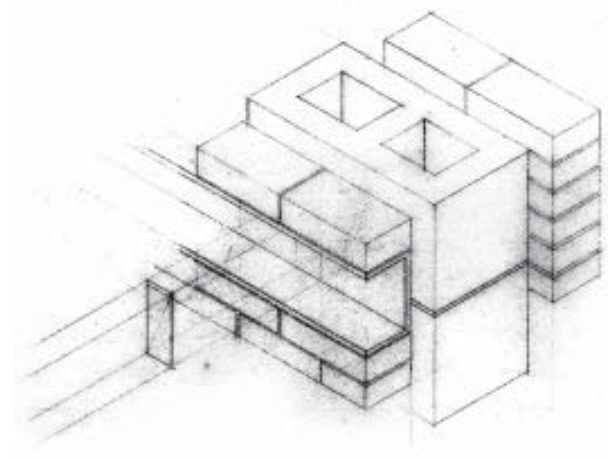

exploration of brick construction through drawings illustrates the required thickness of the wall when using concrete masonry units.

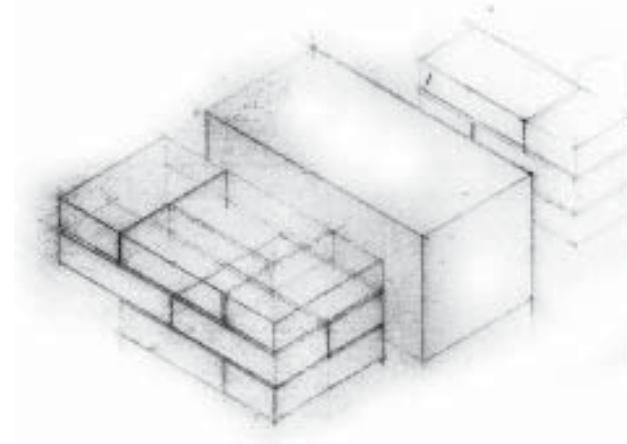

study of a brick corner condition at the cut-out.

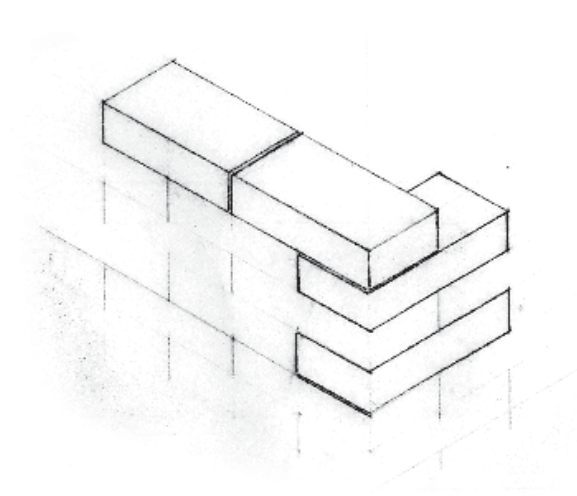

experimenting with brick through drawings.

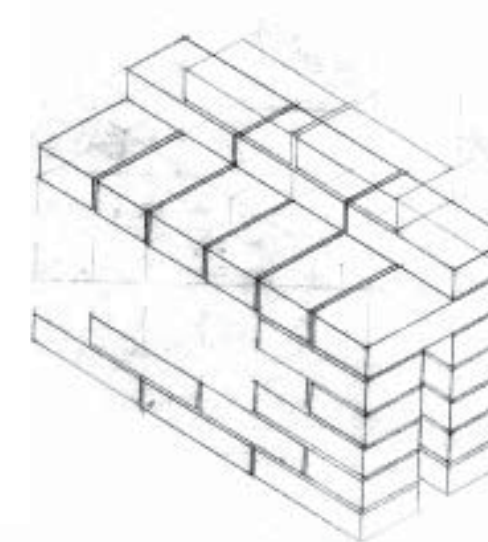



Each opening in the wall posed the question: What are the **lintels**? It was important to be true to the materials and construction in all situations in the house. Therefore, a concealed lintel, was not desired. Nor was a pre-cast concrete lintel. Considering the trades that are on the site constructing the house thus far, it seemed that allowing the site cast concrete core to become the lintels was the most rational.

For **six courses**, directly above the opening, the bricks are removed from the reinforced concrete masonry wall process and replaced with plywood formwork; allowing the concrete to come to the face of the red wall. This provides a ledge on which the bricks above can rest.

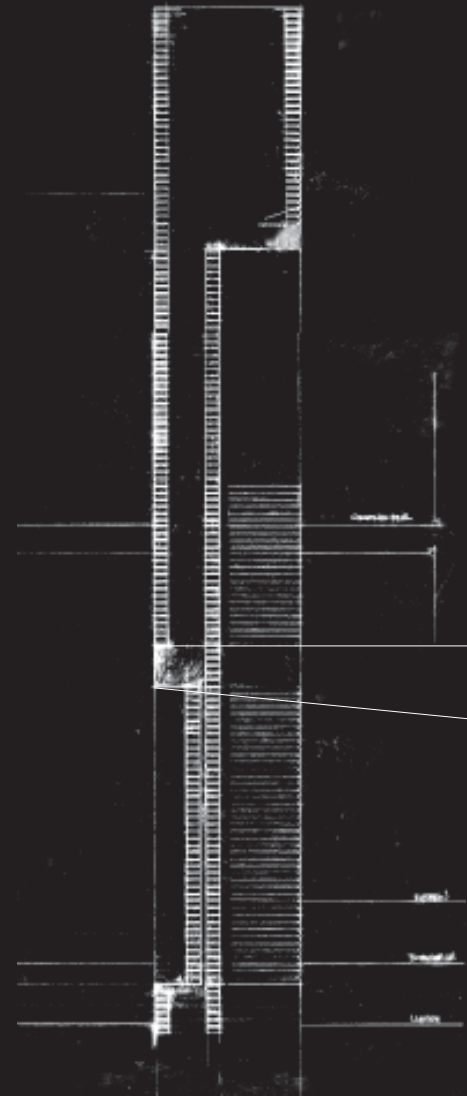

section through red wall: exploring the relationship between the concrete and the brick.

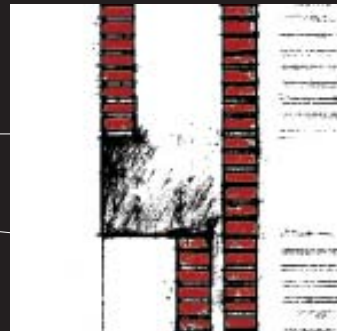

detail: concrete emerges from the wall to create a ledge for the bricks above.

lintel studies in relation to the rotation of the red wall show how the concrete will carry the bricks above.

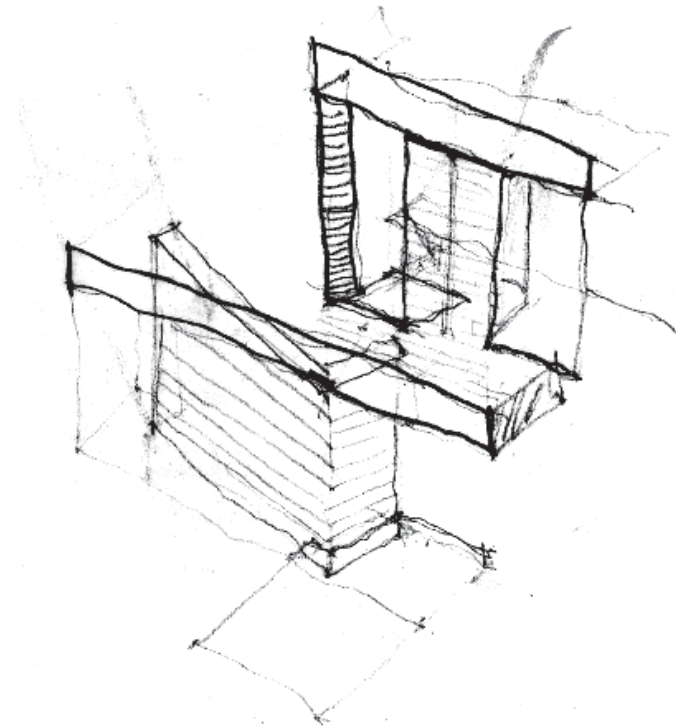

the relationship between the lintel and rotated wall in the living area.

detail of how the bricks above are held by the concrete lintel at the rotation on the north side of the red wall at the top of the stairs.

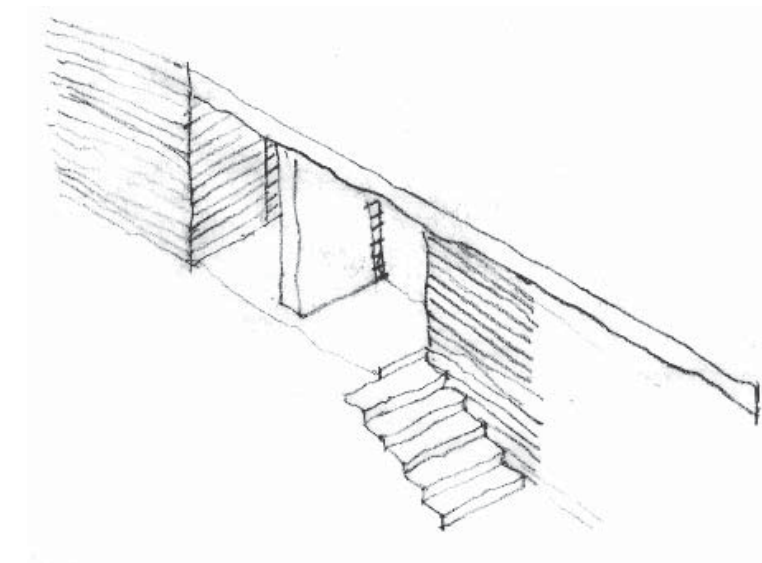

red wall, north side section:  
illustrates needed locations of lintels,  
openings, floors, and stairs on the red  
wall.

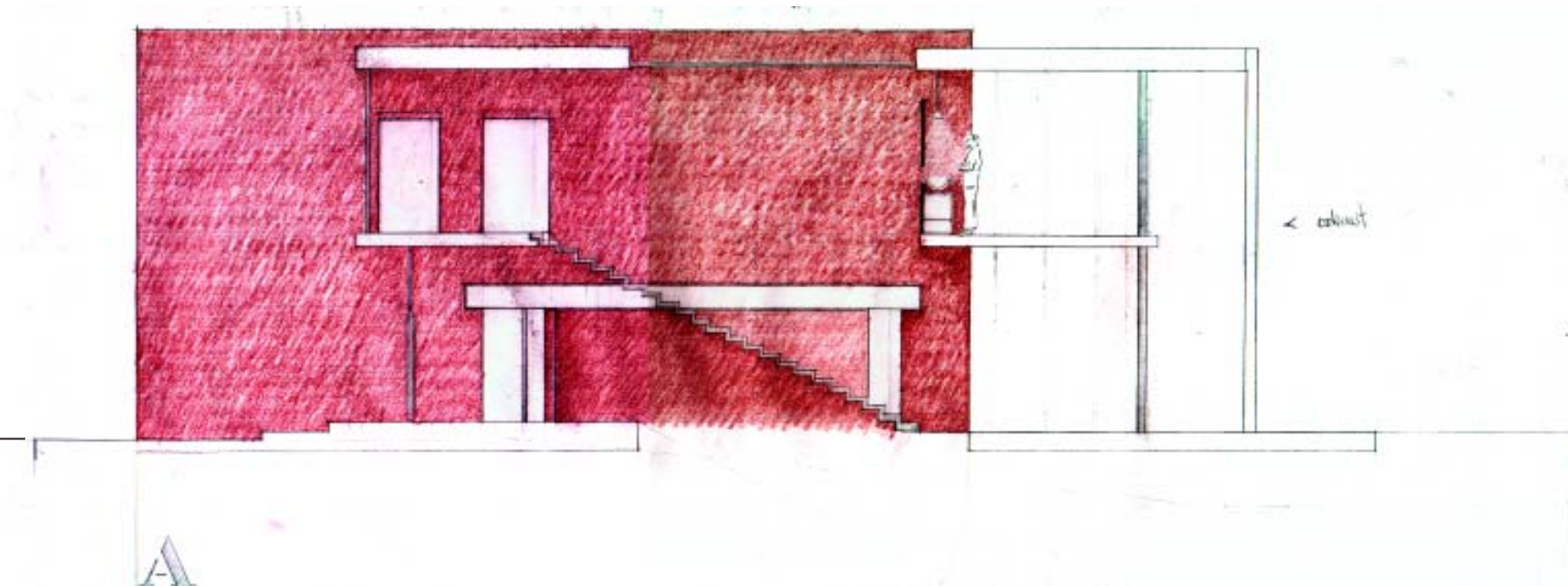

At several locations on the north side of the red wall, decisions were made to cut or push back the red wall; creating places that allow the red wall to be **interactive and experienced**, while responding to the needs of the house. At these conditions, there are two choices: to fill with brick or expose the concrete. At times, the wall is an extension of the furniture and filled with brick. At other times the wall is experienced and understood by exposing the concrete and brick sections.

south of red wall  
subtractions from the red wall

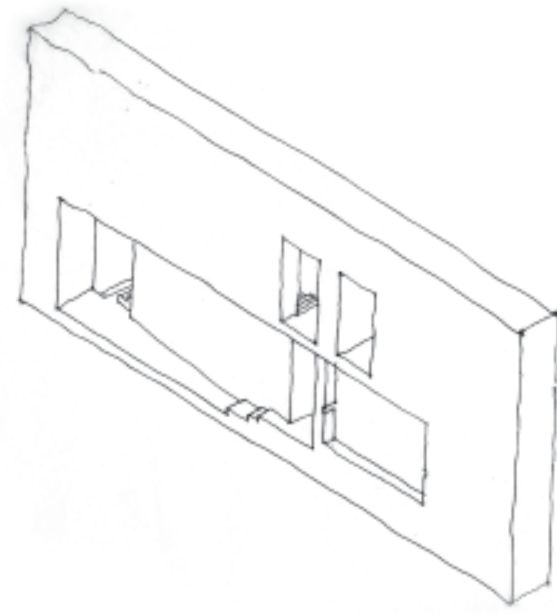

north of red wall  
addition of stair

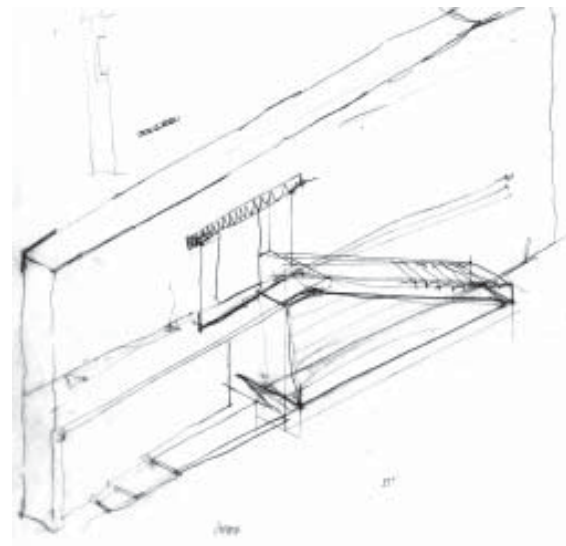

sketch study:  
relationship of the rotated stair to the red wall.

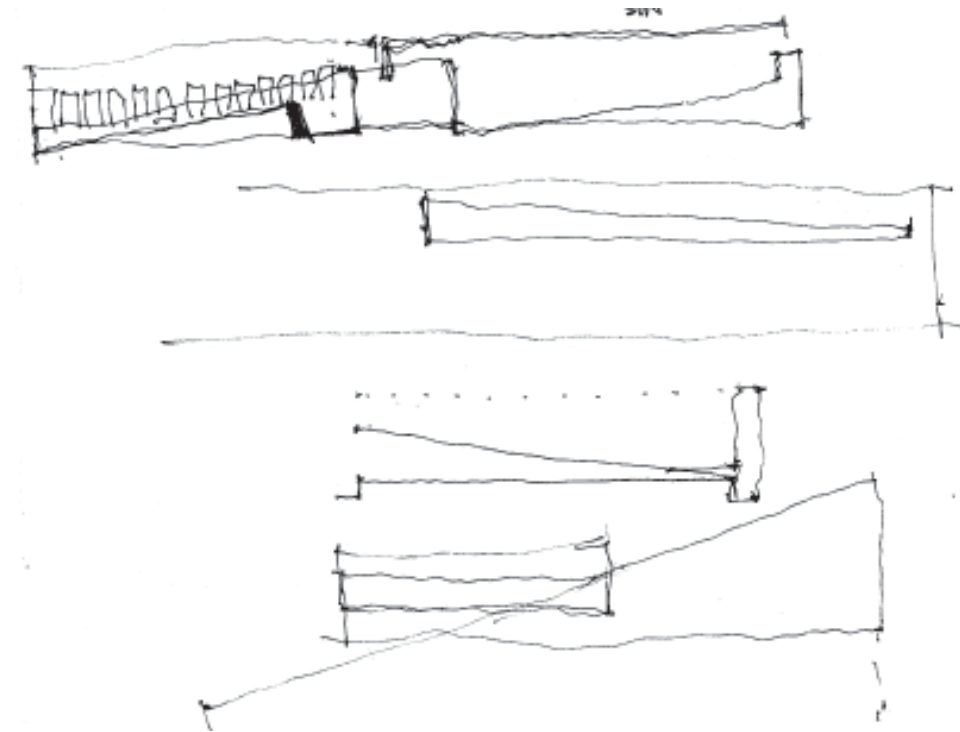

The **stair** was located early in the project. Directly adjacent the red wall seemed a reasonable location; taking up the least amount of space on the site. Early sketches rotate a portion of the red wall a few degrees. This rotation creates opportunities for the stair to connect to the red wall. This rotation and connection create potential for the red wall.

stair detail: introducing a second material, wood or steel, to the brick wall stair allowed for the stair to rotate slightly from the red wall. Once rotated, the stairs become wood or steel.

a corbelled brick recess makes a place for a countertop.

Alternative joist connections to the red wall. CMU limited the red wall's thickness, which lead to a concrete brick wall.

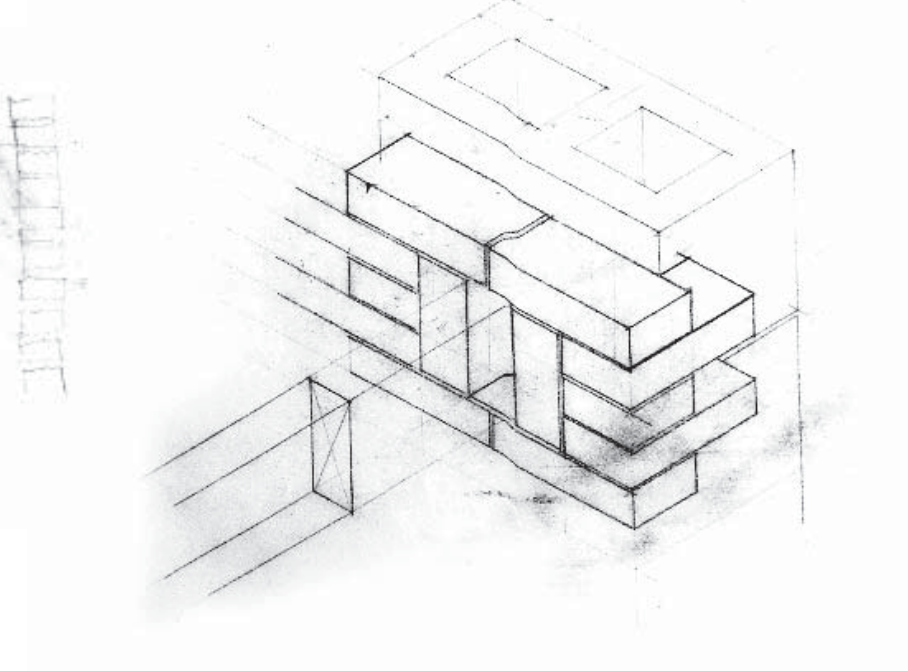
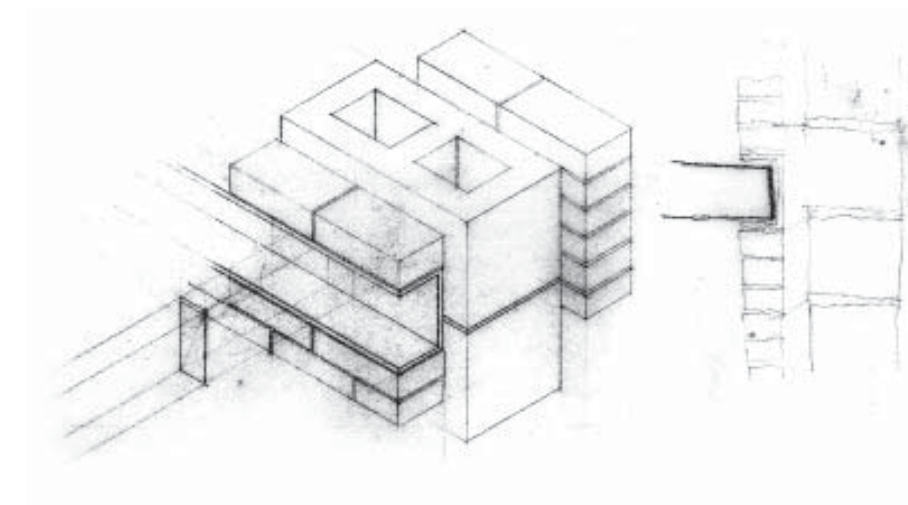
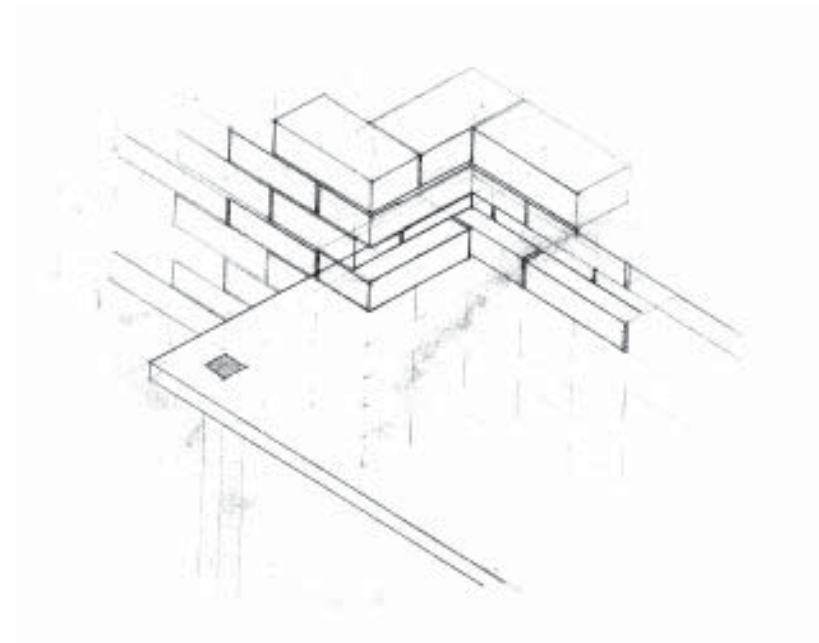
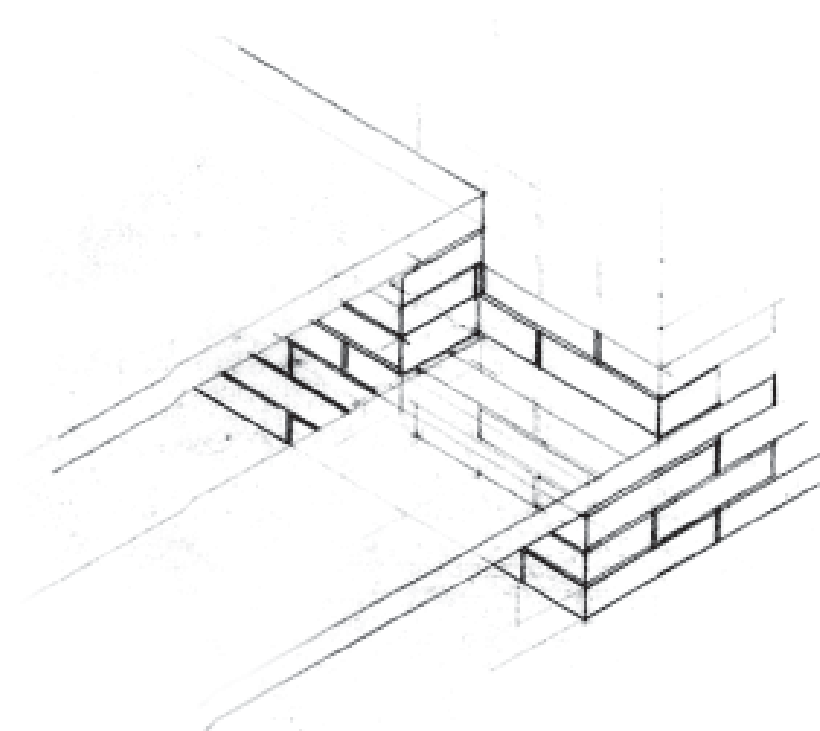



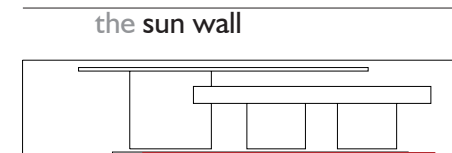

The house faces due east. The long sides of the house face north and south which raises a concern for **ventilation, privacy and lighting**. Studying the site and its climate conditions through programs such as, *Climate Consultant* was crucial to respond to the natural elements of the site.

The house stands approximately 4'-0" from the neighboring houses, on both sides, providing minimal view in these directions. Essentials for a sun wall are simple. It is important to allow for natural ventilation, requiring operable windows. It is necessary to provide adequate privacy, perhaps with an opaque or translucent wall. In addition, the wall needs to provide appropriate lighting without thermal heat gain.

In contrast to the red wall, the sun wall is a curtain wall. This allows the columns to be independent elements in the hierarchy of the components in the house, articulating the columns as structure and the curtain wall as enclosure.

Exploration of the sun as an aluminum-framed curtain wall with panels: **translucent, transparent and opaque**, as well as, operable and inoperable. Mullions were repeated at a maximum spacing of 3'-0", in addition, mullions were placed adjacent to each column.

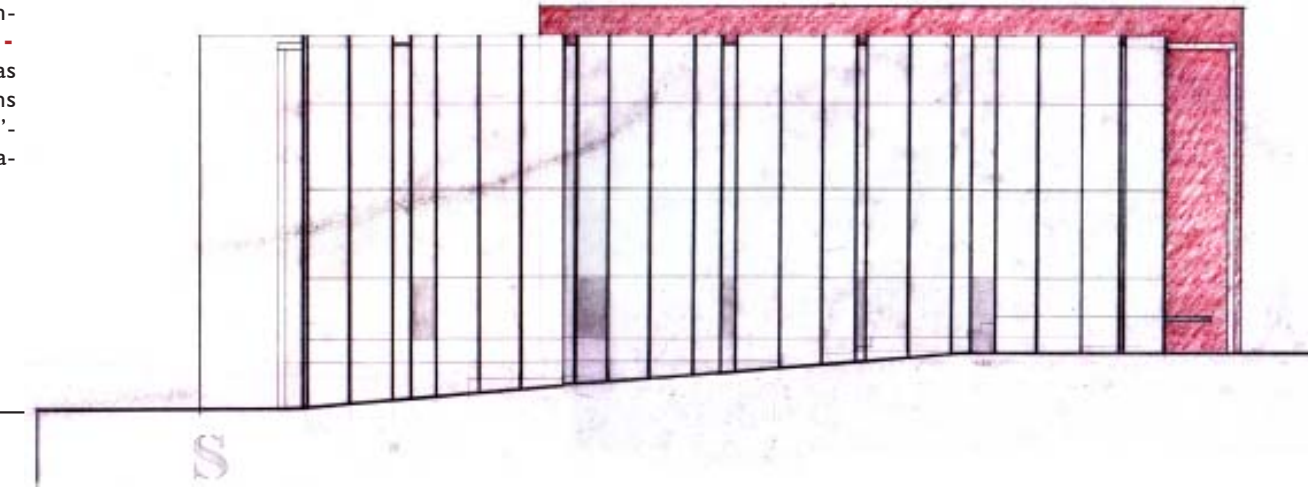

The mullion spacing on this version seemed too arbitrary, furthermore, the 3'-0" grid did not respond to any of the elements on the interior of the house. The only element that responds to the house is the mullions that are adjacent to the columns. Since the repetition did not flow with the spaces inside, it made the placement of the operable or opaque windows fall in nonsensical positions.

Contrasting the transparent wall, exploration of an **opaque wall** developed. Small areas of glass could allow the light in and accentuate the interior spaces. While the red wall is primarily a horizontal element, the sun wall desired verticality. Wood siding being hung vertically, posed a moisture penetration problem. Moreover, the span of 22'-0" required the wood to stretch the distance without obvious breaks.

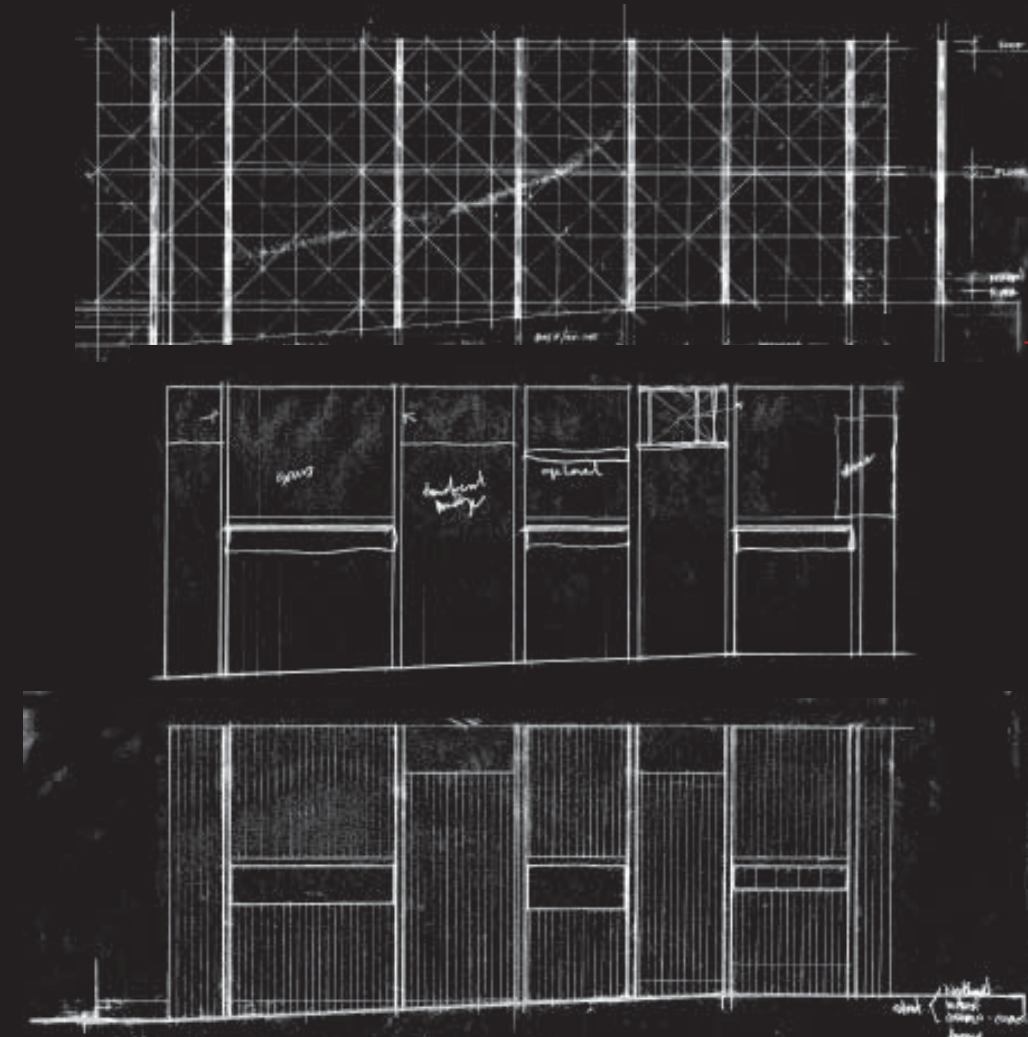

sketch details of proposed south wall.

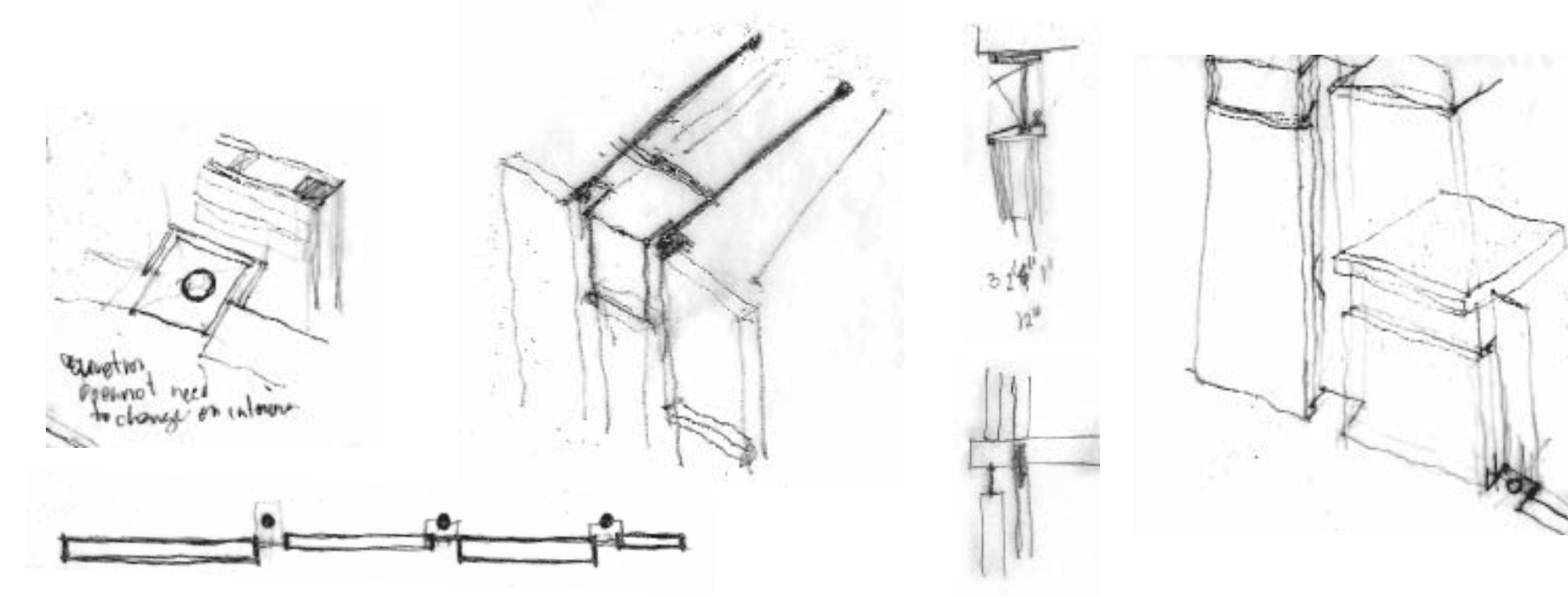

Going back to the basics, the criteria for the wall: **view, privacy needs, and ventilation**. A Kalwall wall system will be used. Kalwall is a thin (2 3/4 " thick) translucent insulated wall system. This serves well to be a curtain wall not acting as anything but enclosure. It allows the structure to stand at a further distance from the wall because of the wall's thinness.

The curtain wall is able to span the 22'-0" vertically as well as provide generous amounts of diffused light, while maintaining privacy from neighboring houses. To further accentuate the structure, the Kalwall stops and breaks at the columns allowing for an operable window. These windows are 8" wide, repeat vertically, and span the height of the house, stopping 1'-0" below of the top of the kalwall. This breaks the wall vertically and lights the column as well as adds natural ventilation through the house.



The **kalwall** connects at three points: the roof, the base and the mid-point at the second floor. The latter connection needed particular attention, as it reinforces the integrity of the space. After much exploration; 8" steel plates, welded vertically on the columns extend out into the concrete. The top of the steel plate is flush with the finished flooring at all connections. The column then accepts the load from the floor. In addition, the kalwall transfers its load at the connection between the wall and floor to the floor, transferring further to the column. An angle bracket mounted at the face of the concrete floor connects to the frame of the kalwall at two points, thus supporting the wall. The 1'-0" by 2'-0" aluminum bracing grid that runs through the Kalwall makes this connection sufficient support against deflection.

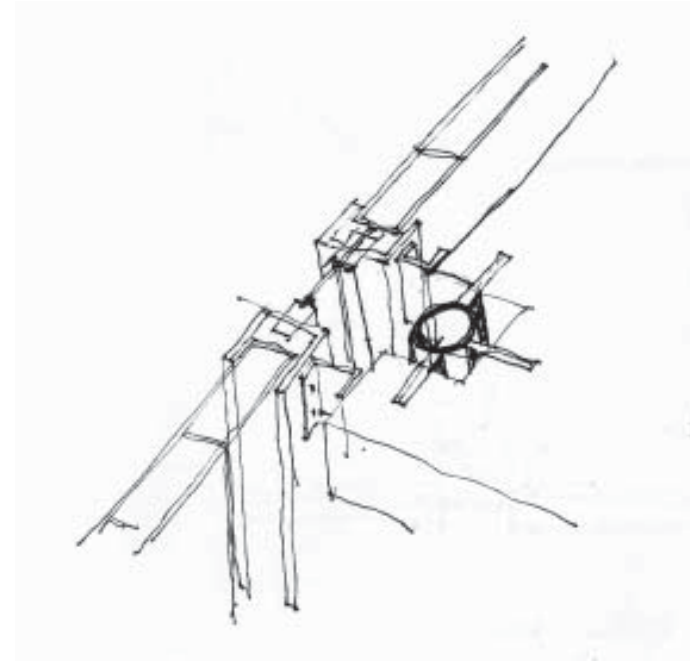

detail drawings at column connection:  
studying placement of window openings and connections to kalwall

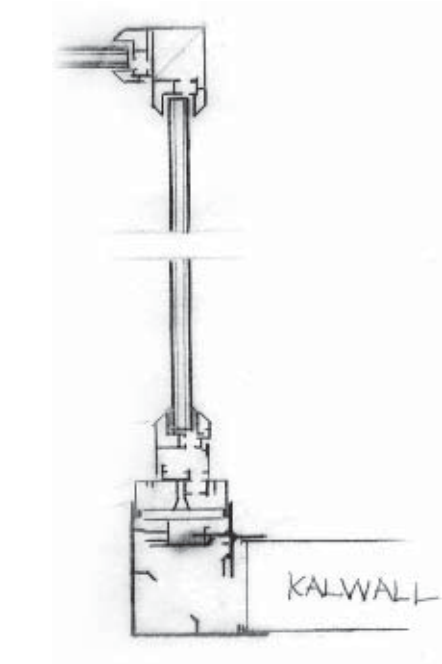
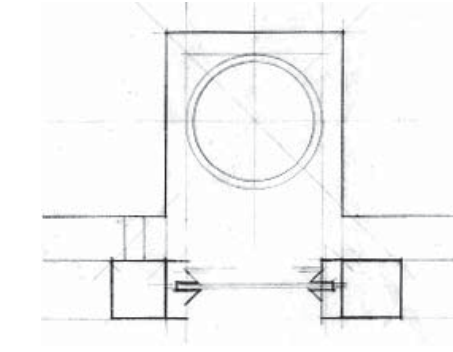
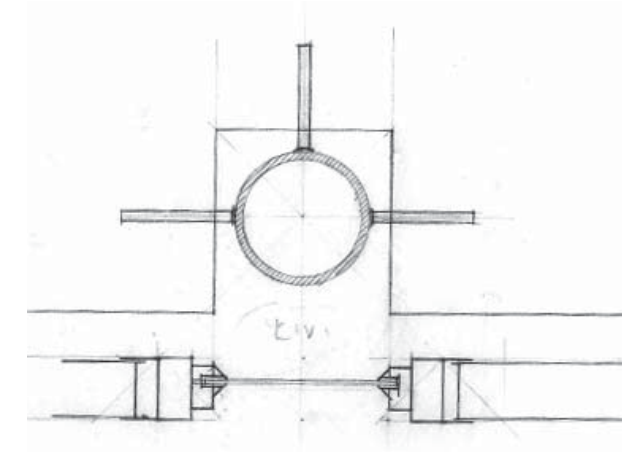

typical corner connection between  
kalwall and a window

## the wind wall

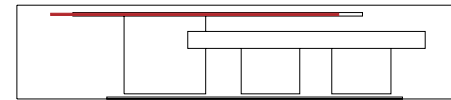

The wind in Richmond, Virginia comes from the northeast in the summer months and north in the winter months. A study model taken to the wind tunnel, helped explore the possibilities of the site in relation to the wind.

Results from the **wind tunnel** revealed that the wind speed would accelerate between the buildings and bypass the entrance. These discoveries lead to the decision to push the wind wall back from the street allowing the red wall to direct the breeze into the house.

wind tunnel studies.

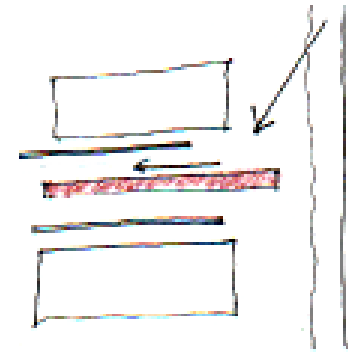

rotated the wind wall to catches the wind.

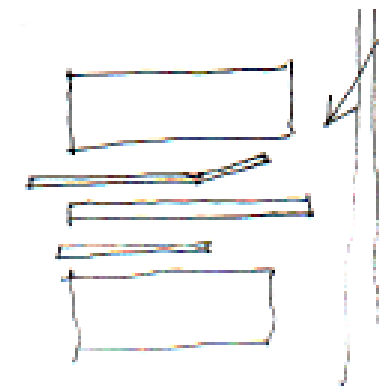

bushes are added to direct the wind into the house.

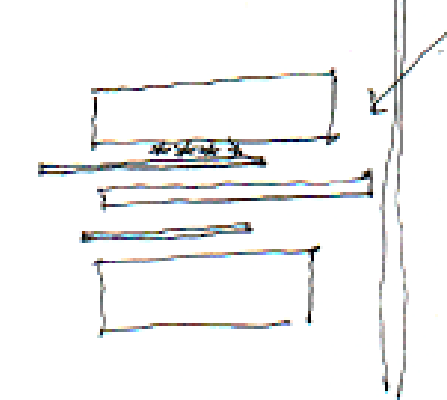

sketch showing results from wind tunnel. the wind accelerates past the wind wall.

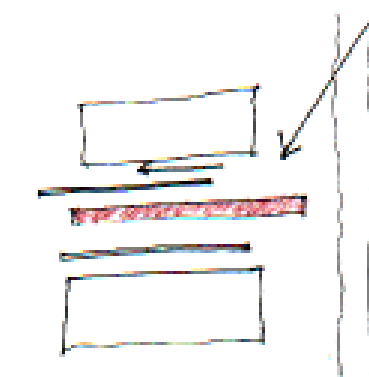



The north wall is a simple wall made of poured concrete, using plywood formwork. Placement of concrete joints and ties are the only ornamental markings on the wall. However, the rotated stair is echoed on the exterior by allowing the north wall to rotate with it. At this point where the stairs meet, the wall is changed to **frosted glass** panels. The change of material differentiates the wall allow a brief glimpse of the interior, without compromising privacy. This portion of the wall brings light into the stairwell, which otherwise would be darker, dimly lit.

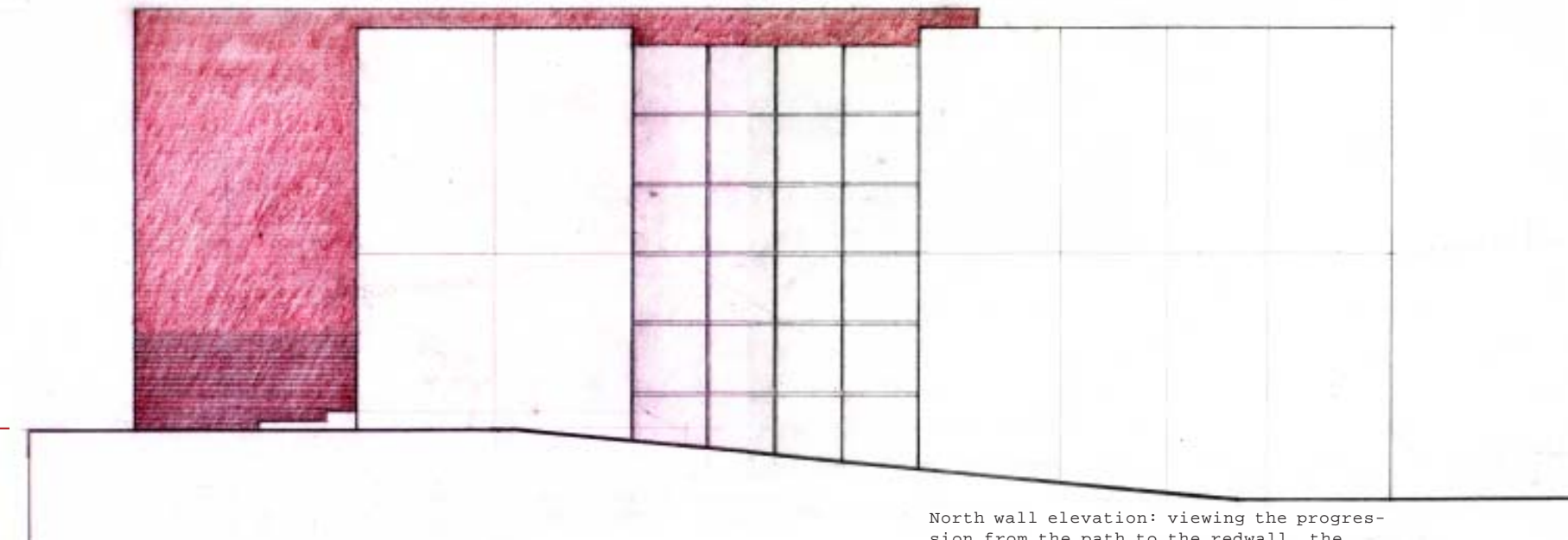

North wall elevation: viewing the progression from the path to the redwall, the north wall, the rotated portion the north wall, as glass panels, back again, finishing at the yard.

The north wall acts as a substructure to the red wall at points by making a direct **connection** between both walls. Adding a small piece of blocking to the formwork creates a reveal making a shadow to diminish the natural inconsistencies of the concrete at the sequential pours.

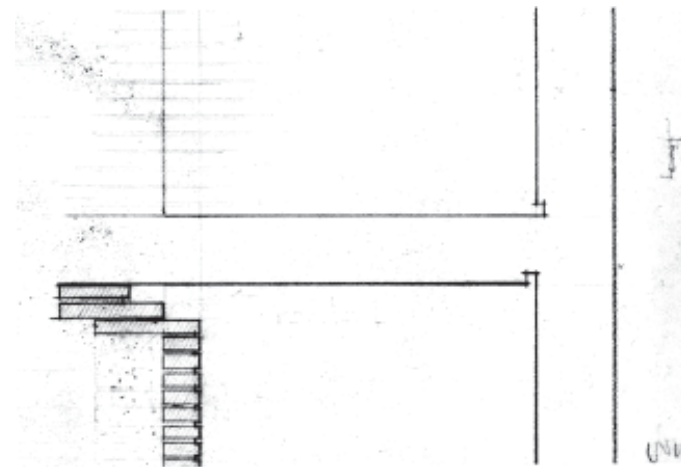
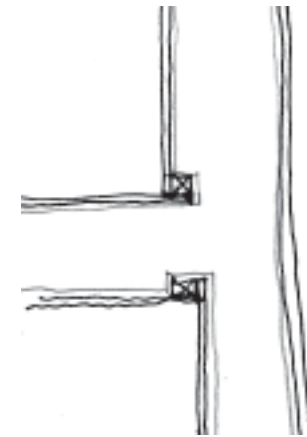

*“If we were to train ourselves to draw as we build, from the bottom up...stopping our pencil to make a mark at the joints of pouring or erecting, ornament would grow out of our love for the expression of method.”*

*Louis Kahn*



## three volumes



The **volumes** are an alternative to extruding a second floor. The volumes allow the red wall to be viewed and experienced at the full height at different places in the house. Furthermore, these volumes allow cutouts and subtraction from the red wall, extending a greater experience with the red wall.

Formwork allows the concrete from the red wall to make the floors of the volumes. Corbelling at the red wall accepts these floors. (The bricks step three bricks into the red wall). This detail shadows the imperfections of the concrete pour and provides a control joint for the concrete.

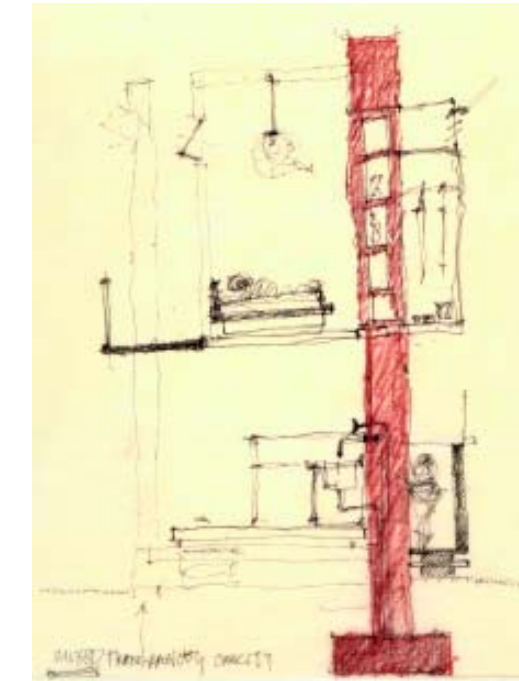
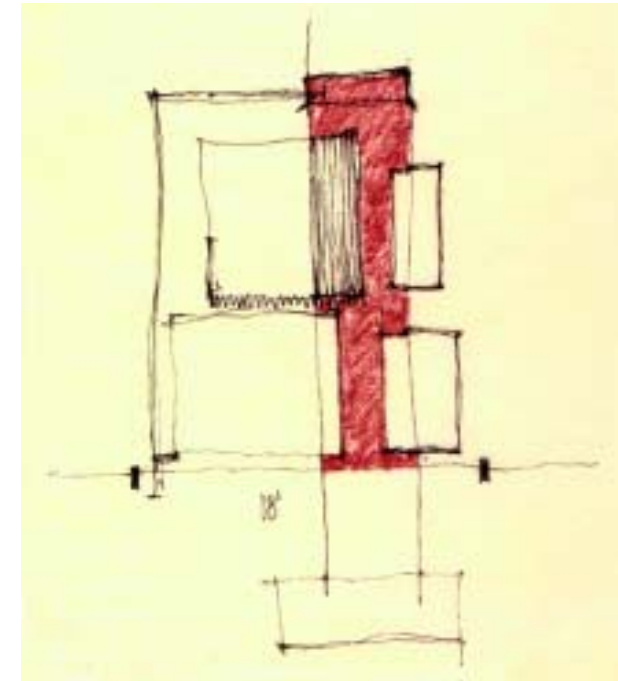
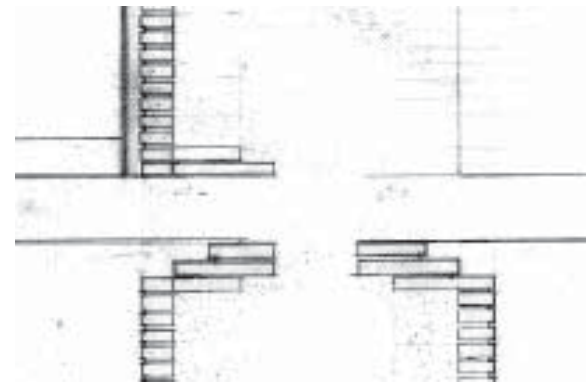



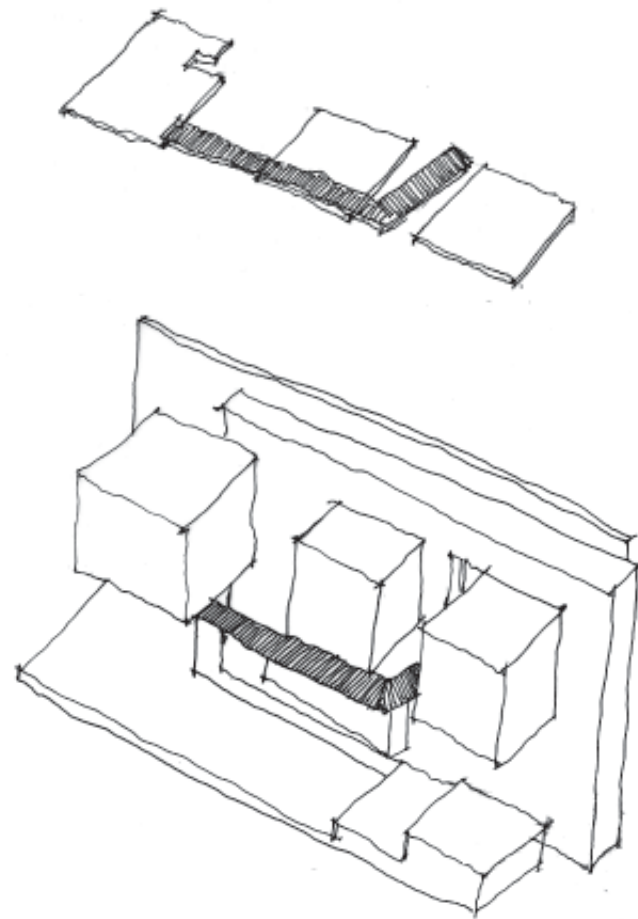

As discussed in the sun wall chapter, the sun wall does not support the floors. They connect to the columns. Three steel plates cast into the concrete are welded to the column supporting the concrete floors. The floors support the sun wall with an angle connection at the floor.

The front bedroom, the bathroom, and the rear bedroom make up the volumes.

The bathroom is the only volume with a ceiling. Interior dimension is 8'-0", creating an intimate and private space.

Further discussion of these details will occur in each chapter.

The partitions that complete the volumes are of standard stud construction with drywall. The partitions are a piece of furniture that bolt to the concrete floors. Initially, I wanted to connect the partitions to the red wall, but found it unnecessary if the partitions are self supported pieces of furniture.

The drywall does not touch the concrete. On the interior of the rooms the drywall is lifted 4" from the finished floor, making a place for electrical outlets.

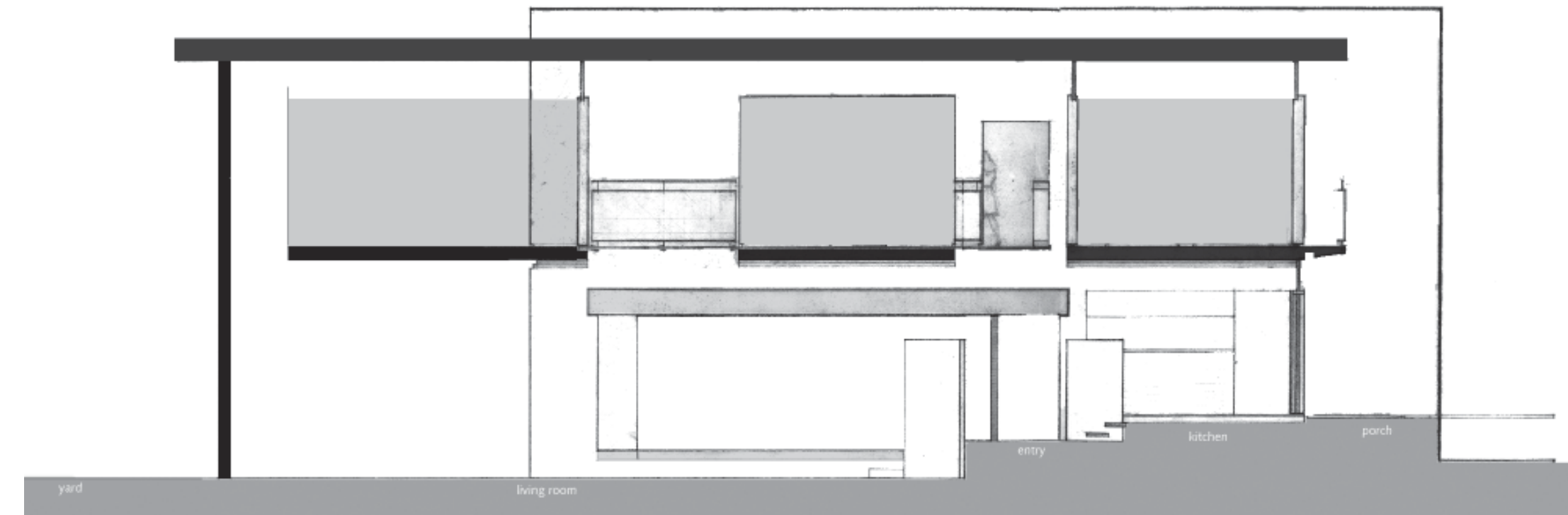



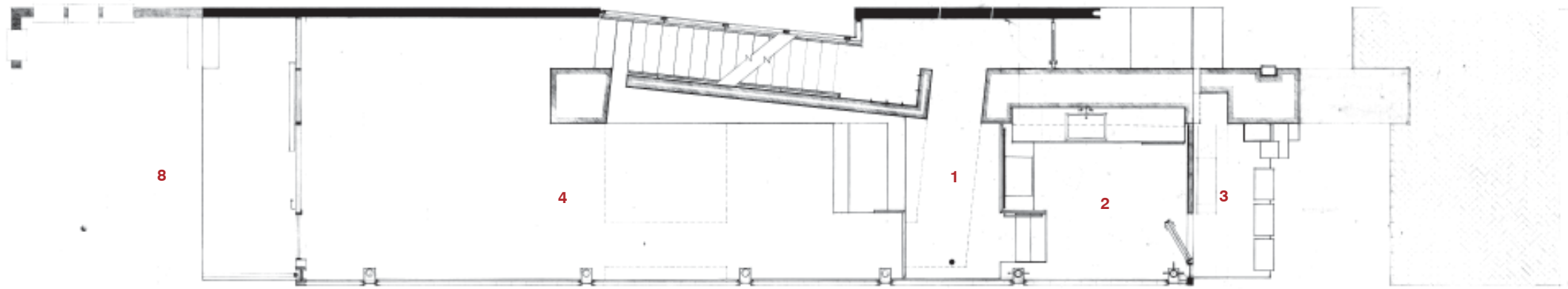

- 1 | an entrance
- 2 | a place to eat
- 3 | a porch
- 4 | a place to live
- 5 | a place to rest
- 6 | the bridge
- 7 | a private place
- 8 | the yard

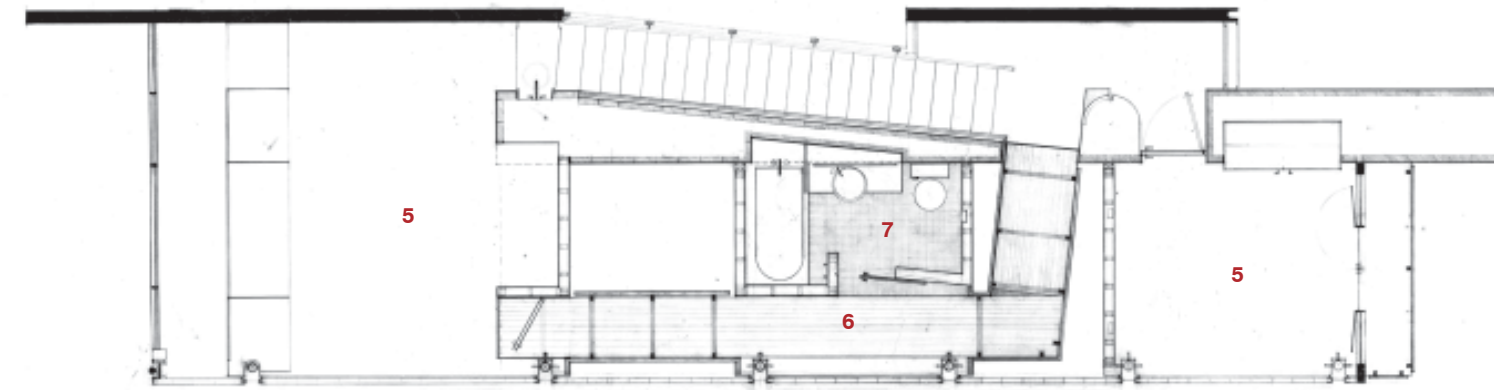

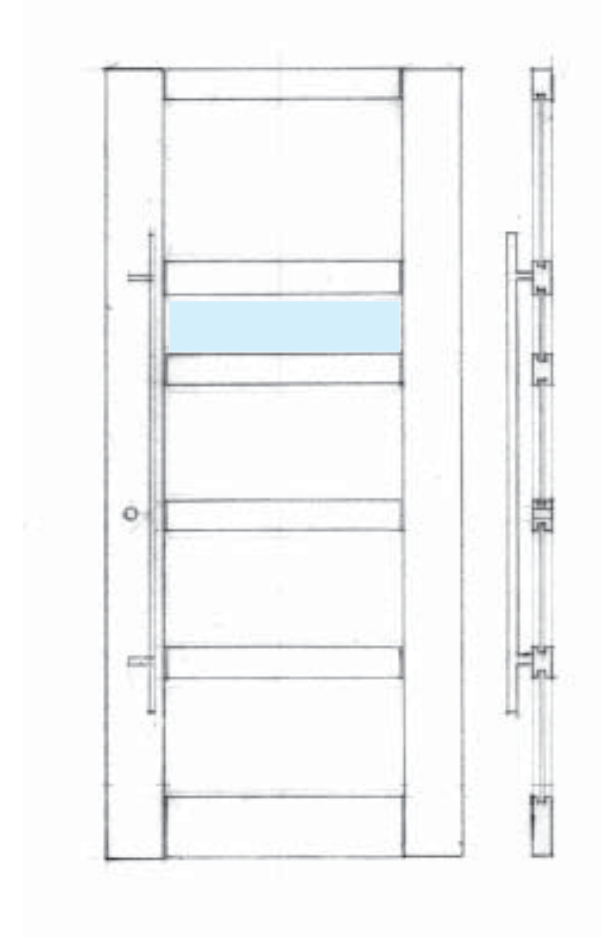
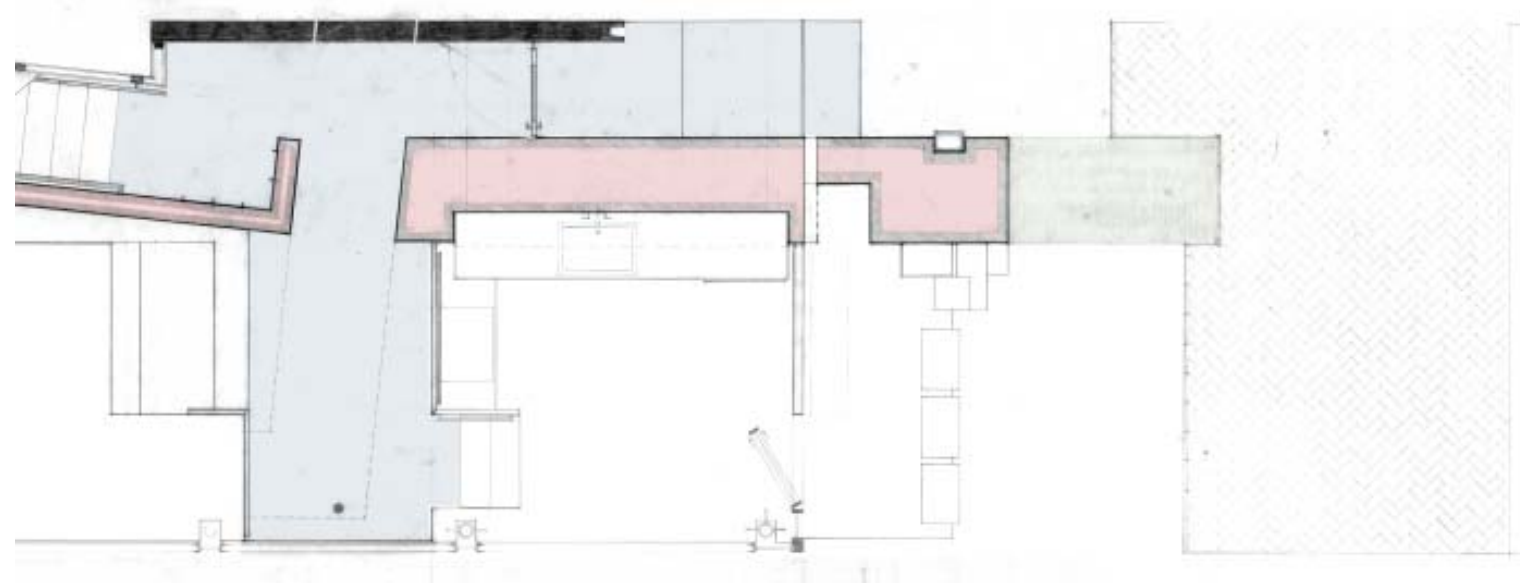

The entrance is most important. It is the place where one first engages the building, specifically the door handle. The frosted glass paneled maple door provides privacy at the same time as lighting the entrance corridor. The door handle that spans vertically is made of solid aluminum.

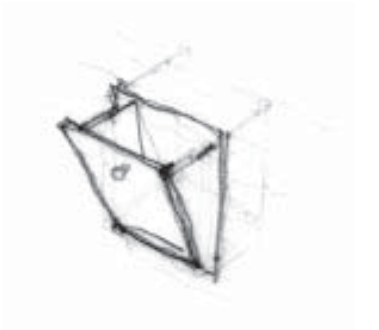

A maple mailbox inserted in the red wall as a piece of furniture.

The stone path from the brick sidewalk to the front is 12'-0". Gradually climbing three poured concrete steps, up with varying tread depths and 6" risers. The intention is to slow down the energy from the street.

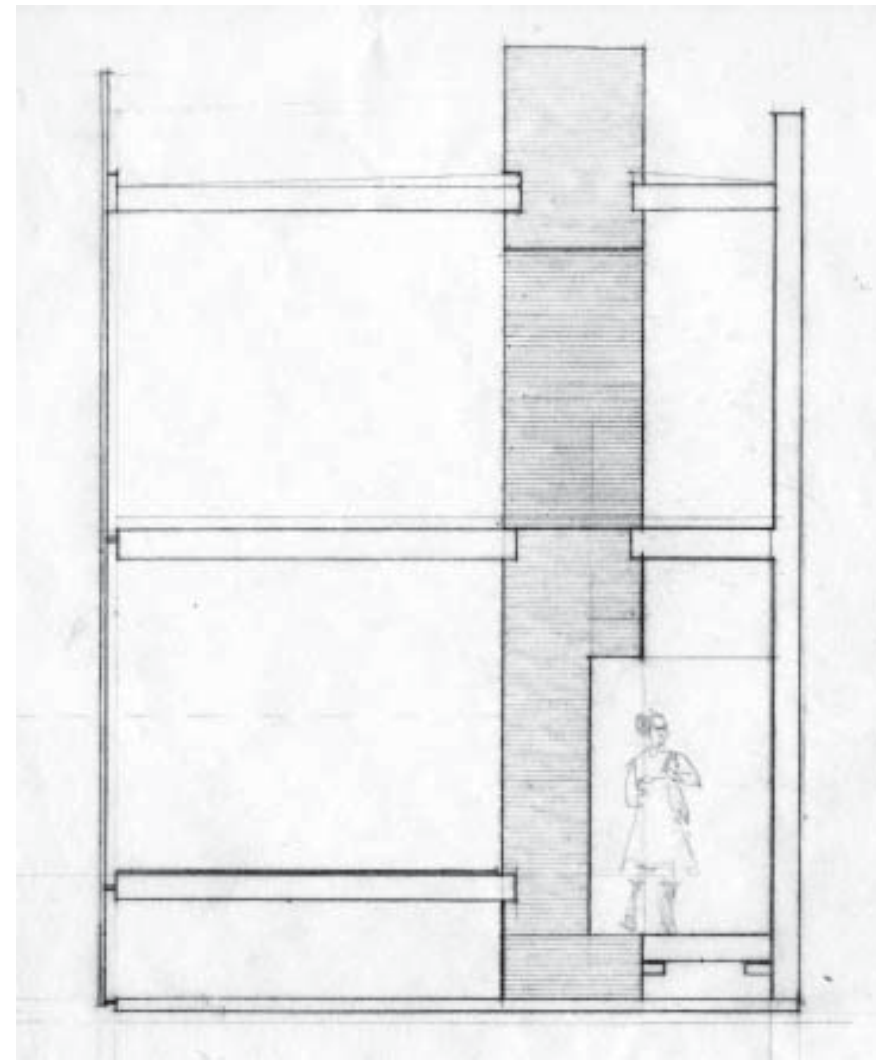

The north wall and the red wall continue into the house into a narrow corridor space. The ceiling height is 8'-0". Here another opportunity to gather oneself is provided before passing through the 3'-0" by 6'-8" opening in the red wall to the entry level. Recessed lighting and HVAC systems will occupy the 1' -0" plenum space above the ceiling.

Straight ahead is the entrance to the basement. Although the rotated wall directs the flow into the entry level, behind the wing wall, towards the basement, is a place for jackets, bags and shoes. In addition, it is a place for communication of messages, such as mail or notes.

The entry level is a mediator between the living area, the kitchen and furthermore the entrance. The entry level opens vertically and horizontally. The ceiling height is 9'-6" to the bridge above and 20'-0" to uppermost ceiling height, elongating the small space vertically. The space also opens horizontally presenting the main living level and all the elements in its entirety.

Light in this space comes primarily from the kalwall system southfacing. The insulated translucent wall system extends the length of the south wall.

The 6'-0" wide stair that leads to the main living area has varying treads that can be used as seating, to provide for the gradual exiting process that I know my family has.

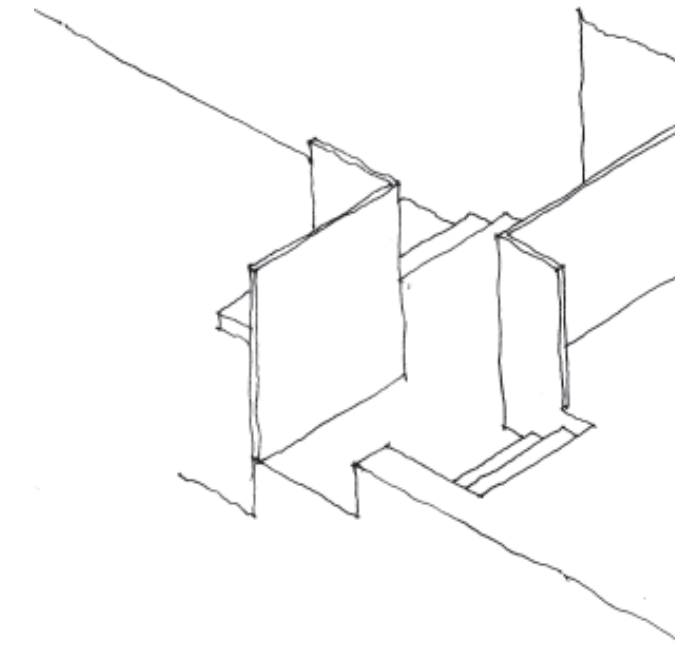

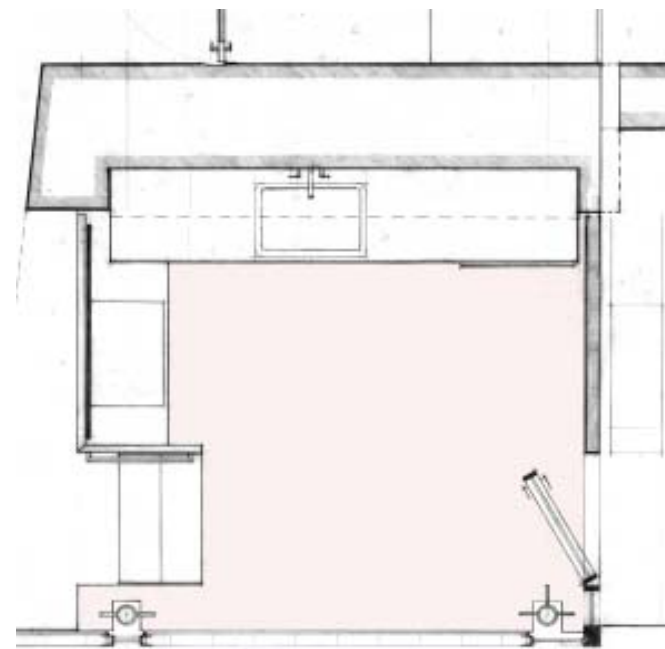

Kitchens are one of the most used spaces in a house and can be the messiest room in the house. Placing the kitchen on the main path of circulation would not allow the kitchen to operate efficiently. It is an important attribute for a kitchen to be open at times and closed at others.

A laminated wood partition wall separates the kitchen level and entry level, it is 4'-0" on the kitchen level and 5'-6" on the entry level, allowing for privacy in the kitchen when on the entry-level side. However, conversation and interaction between levels is possible.

The kitchen is a small intimate space. The ceiling height is 8'-0". A subtraction in the red wall allows for the built-in cabinet and the sink area, and is the source for the plumbing and electric conduits. The appliances line up on the red wall. The down vent stovetop with oven faces the living area but connects to the red wall under the cabinets.



Three steps, leading up to the kitchen level, are out of sight from the entry level giving the opportunity to invite or not invite guests to the kitchen.

Materials are an essential quality in the kitchen. The wood floors have been constructed from seven-layer birch plywood that have been cut into 3/4" slices and laminated on its side to create a very thin stripe pattern for the floor.



The importance of a porch in Oregon hill is significant. While visiting the site, I observed that every house has a porch. It is important for the kitchen to connect to the porch at the front of the house facing Pine Street. However, it was also important for the **entrance to be separate** from the kitchen.

The intention of the porch is to become an extension of the kitchen. Creating two separate entrances; one through the house and one through the kitchen is not an acceptable solution. The porch needs to allow accessibility to passersbys but not be used as an entrance. It is critical to have *one* entrance that does not pass through the kitchen.



porches in oregon hill, va

I considered many options for the porch. First option, is to add a secondary stair that would eventually become the main entrance out of convenience; secondly, no stairs at all, which would cut off access and not allow anyone to access the porch without going through the house. The chosen strategy was to construct three poured concrete blocks that connect with the red wall as steps with 1'-0" risers leading to the porch level. This allows access to the porch but would not be the most comfortable route and discourages the porch as an entrance while making the steps a special moment.

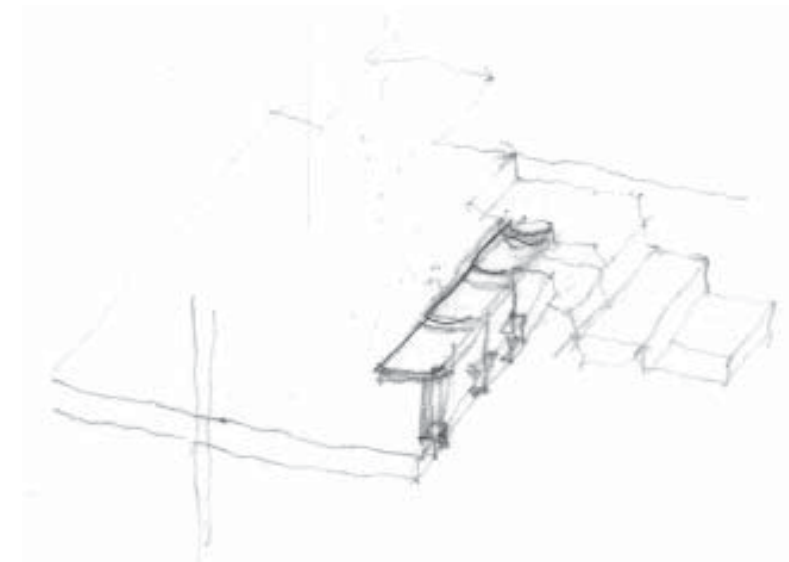
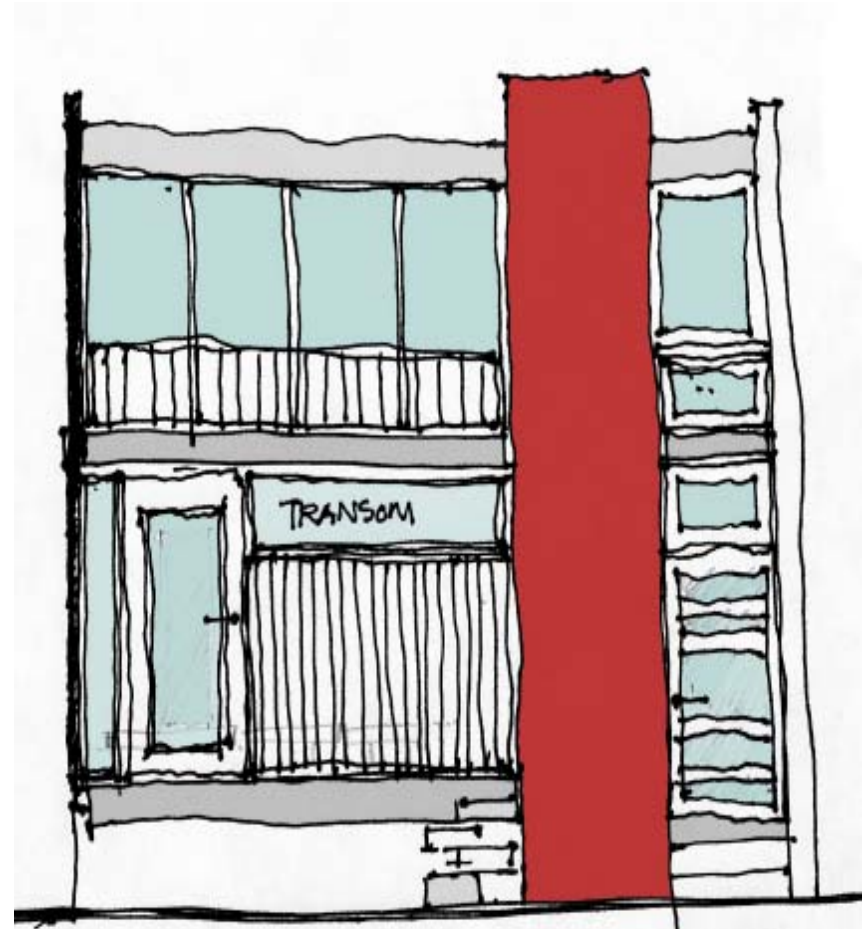

The red wall has a storage space for outdoor plumbing, electrical outlets and furniture with direct access to the porch.

The porch is 3 feet off the ground. Adding a railing to prevent anyone from falling off became a concern. Alternatively, adding three individual places to sit protects people from falling and encourages use of the porch.

The sun wall continues past the interior of the house, adding privacy from neighboring house and extending the kitchen to the exterior.



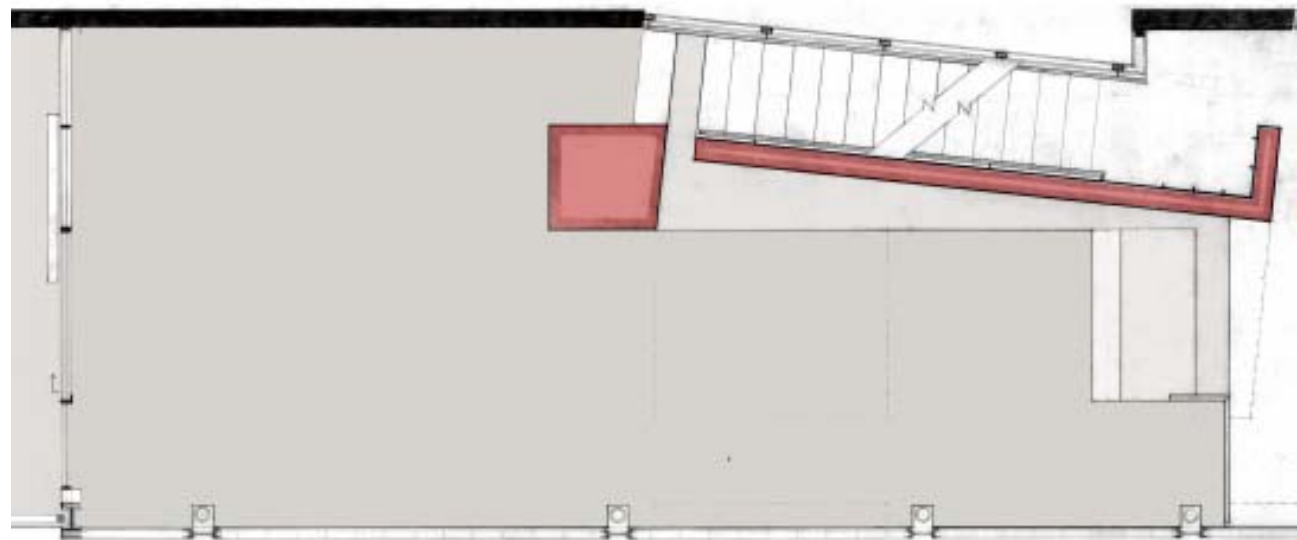

A living room should be just that, a place to live. This space is open. The living area is the full height of the house that encloses three 'floating' volumes. This allows for better ventilation throughout the space and makes the narrow space feel larger, by increasing the verticality of the space. To maximize the space, the room changes height as you step down from the entrance level making the ceiling height 11'-0" below the volumes and 20'-0" in the spaces between the volumes.



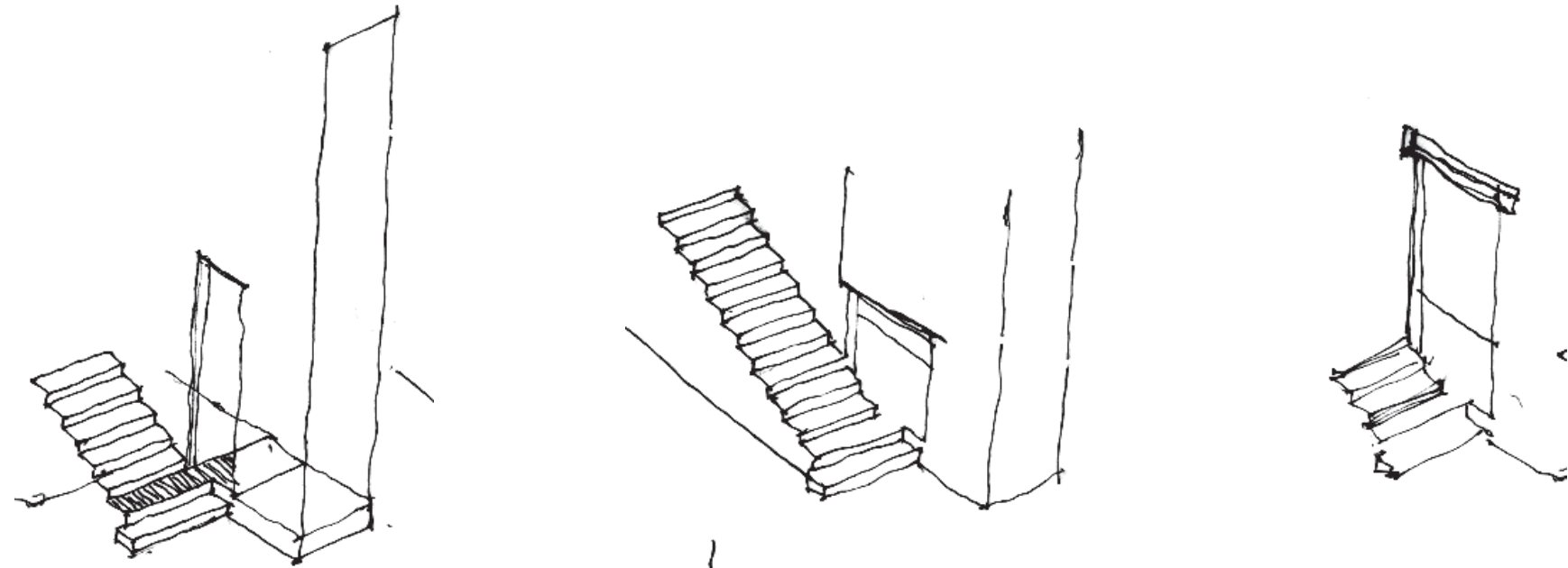

*The rotation in the red wall is directional in two ways; leads to the living area, and is a way in letting one know where they are.*

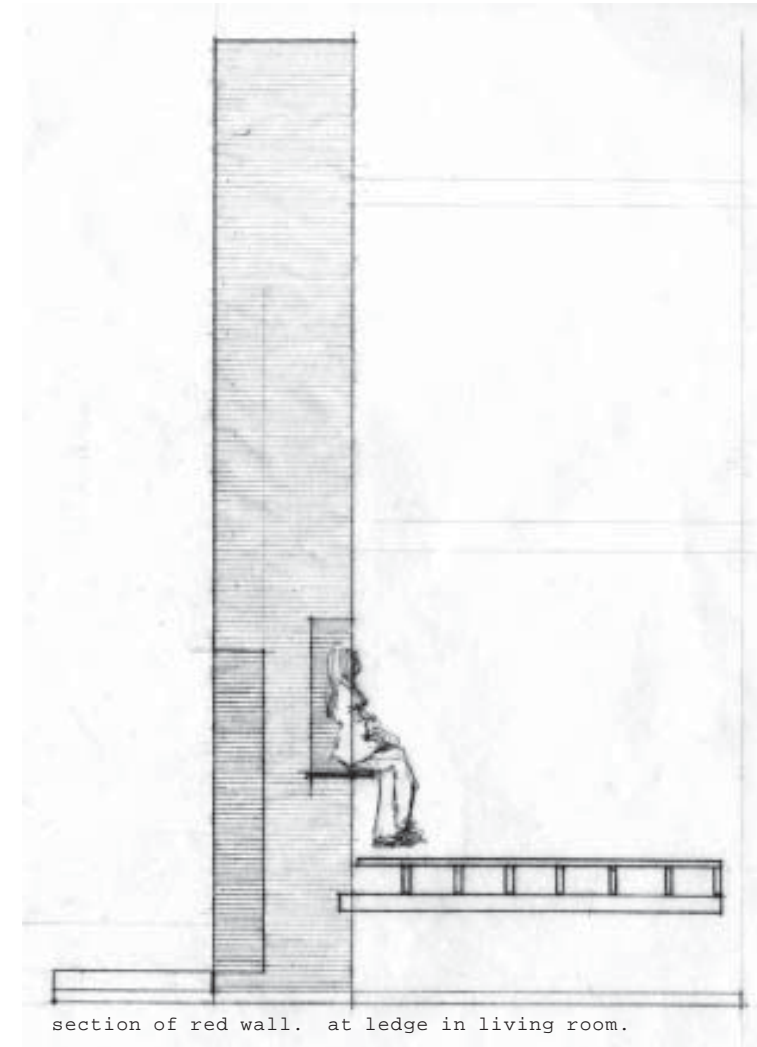

section of red wall. at ledge in living room.

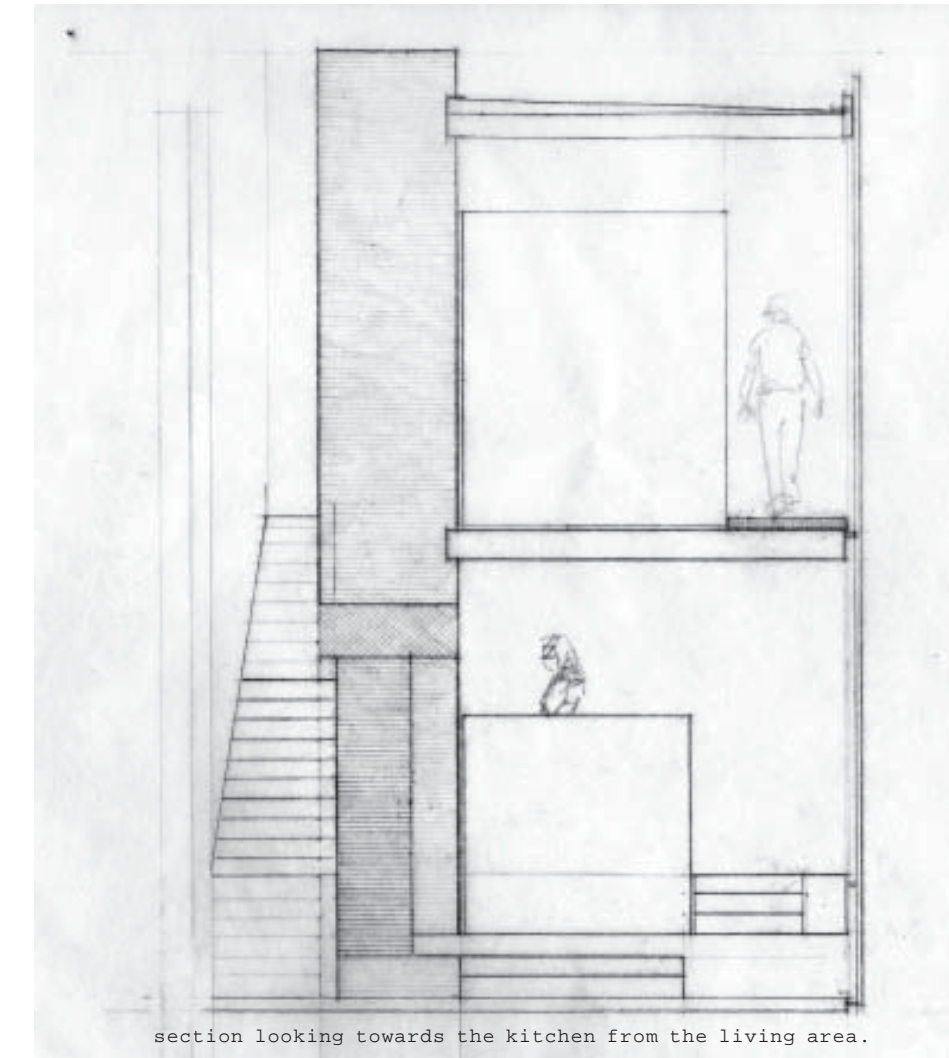

section looking towards the kitchen from the living area.

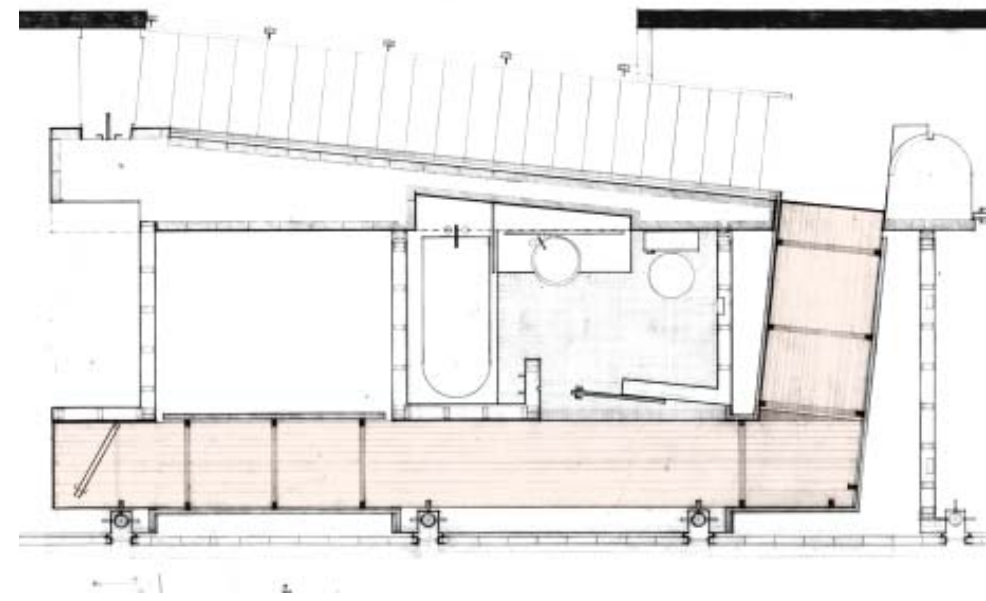

As a result of the three volumes a bridge is created for access to each volume. Thus, creating an open 'corridor' in lieu of a closed corridor. In addition, the bridge allows the light and air to flow to the living area below; and ultimately creating varying ceiling heights.

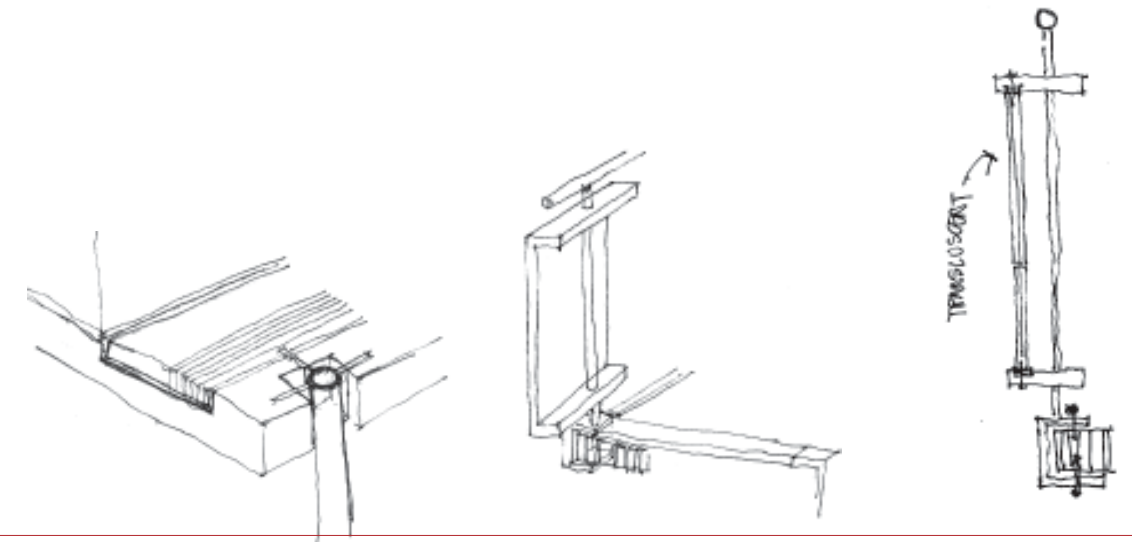

The bridge is made of a series of wood laid vertically for maximum strength. Steel rods are threaded through to add additional support to the wood bridge.

The railing is connected to the bridge with steel.

The railing is composed of many parts. The compression post holds the 1 x 6 at the top of the bottom, which secures the translucent glass panel in place. The handrail is painted steel pipe.

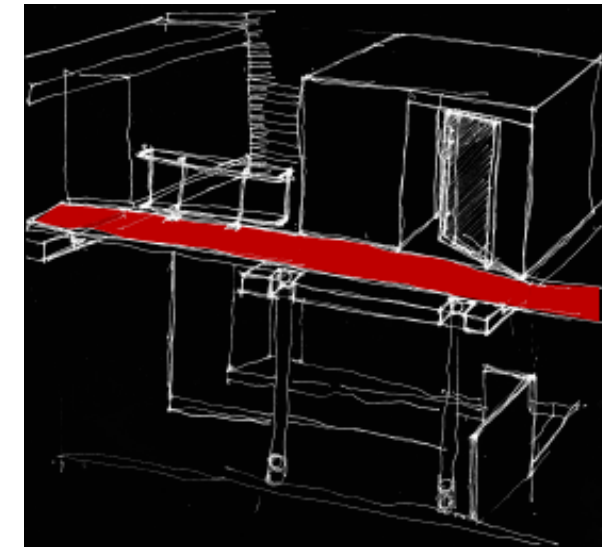

The bridge provides a visual connection between the living area and second floor.



a place to rest

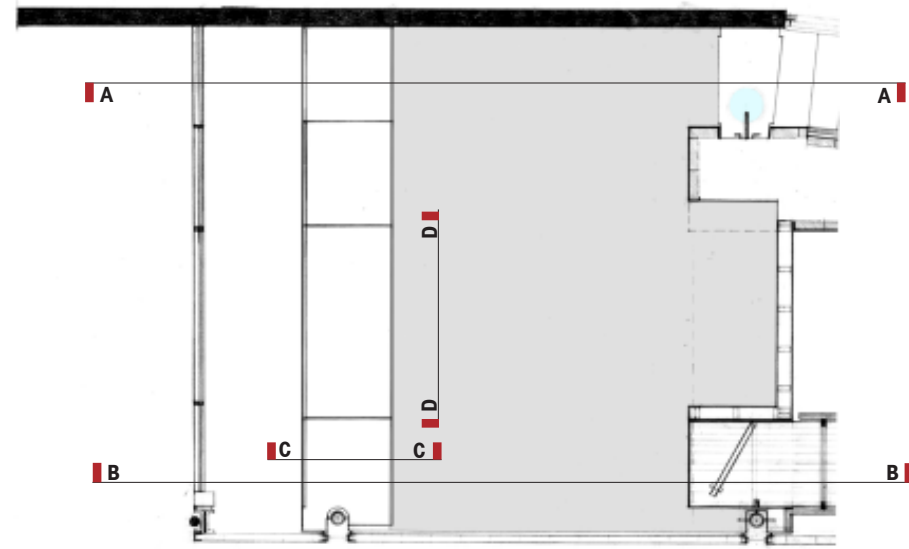

There are 2 bedrooms in the house. The rear bedroom is the primary room, and the front room, the secondary.

At the end of the bridge is the entrance to the rear bedroom. The sun wall is exposed. The red wall ends in this room. There is a cut out that delaminates the brick which exposes the concrete construction inside; this allows room for the bed. The western most part of the room is the glass wall that is in the living room. It extends up to the ceiling of the house. The floor of the room, stops 3'-0" short of the glass wall giving the sense that the room is larger. The cabinets provide hanging space, drawers and doors; this cabinet also acts as the guardrail.

The windows are operable from this floor, through a pulley system next to the north wall.

In addition, there is a built in vanity over the stairs. A mirror is suspended between the red wall and the north wall, which also allows for natural flow of air to pass through.

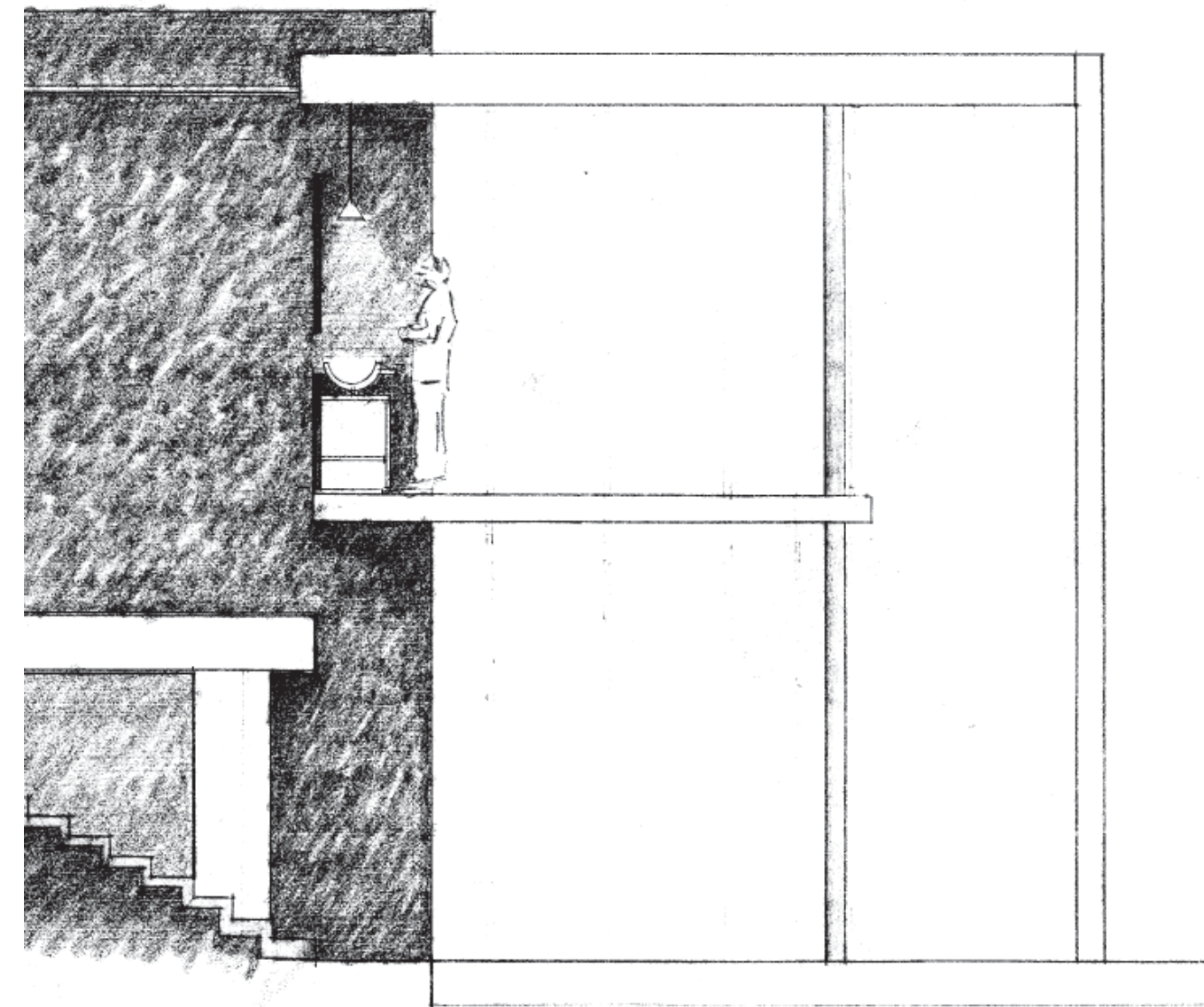

A - A  
section looking south at the north side of the  
red wall.

The floor is poured concrete supported by the red wall, the wind wall and the column.

B - B  
section looking north to the south side of the  
red wall.

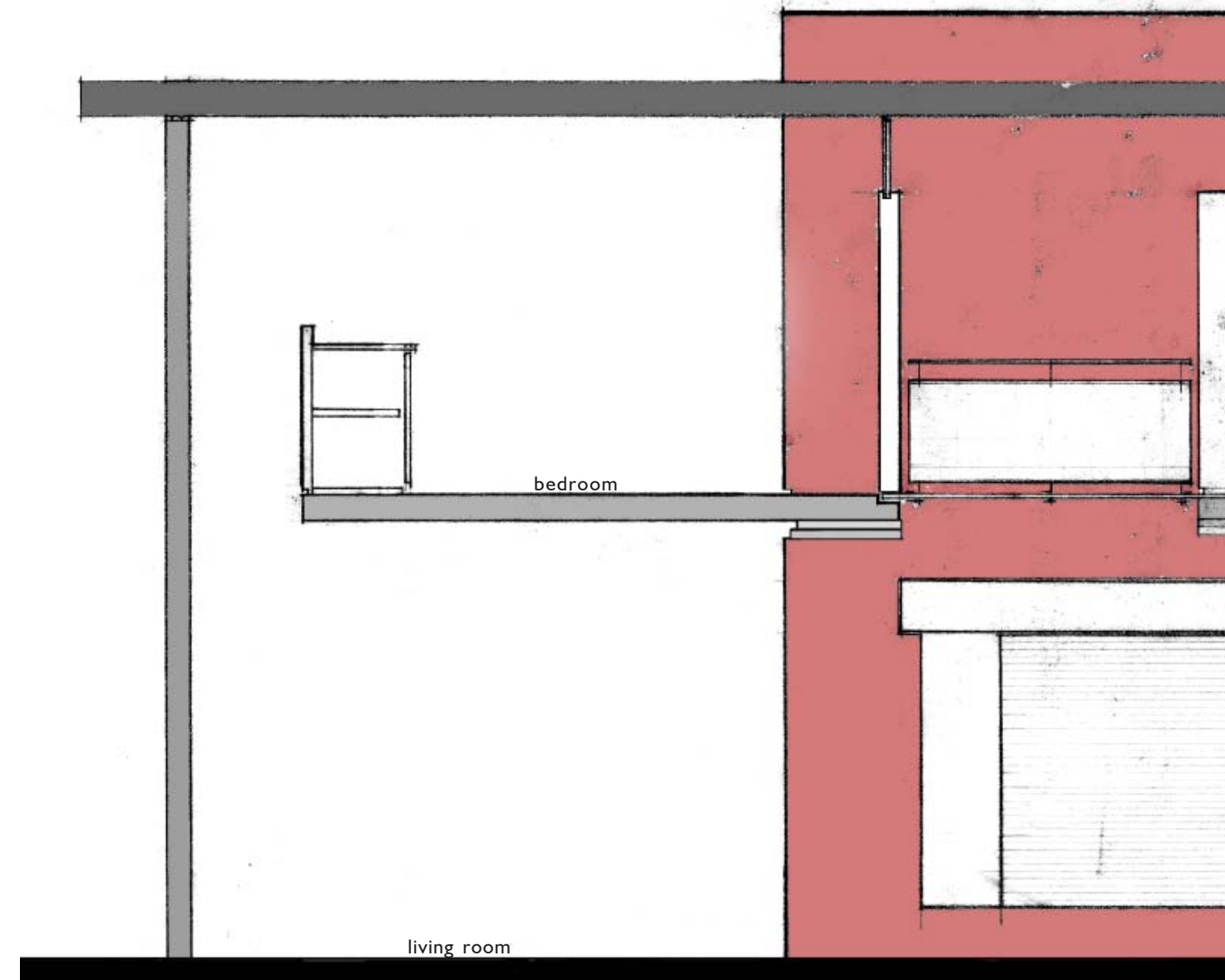

72| This drawing illustrates the relationship between the  
bedroom and the living room.

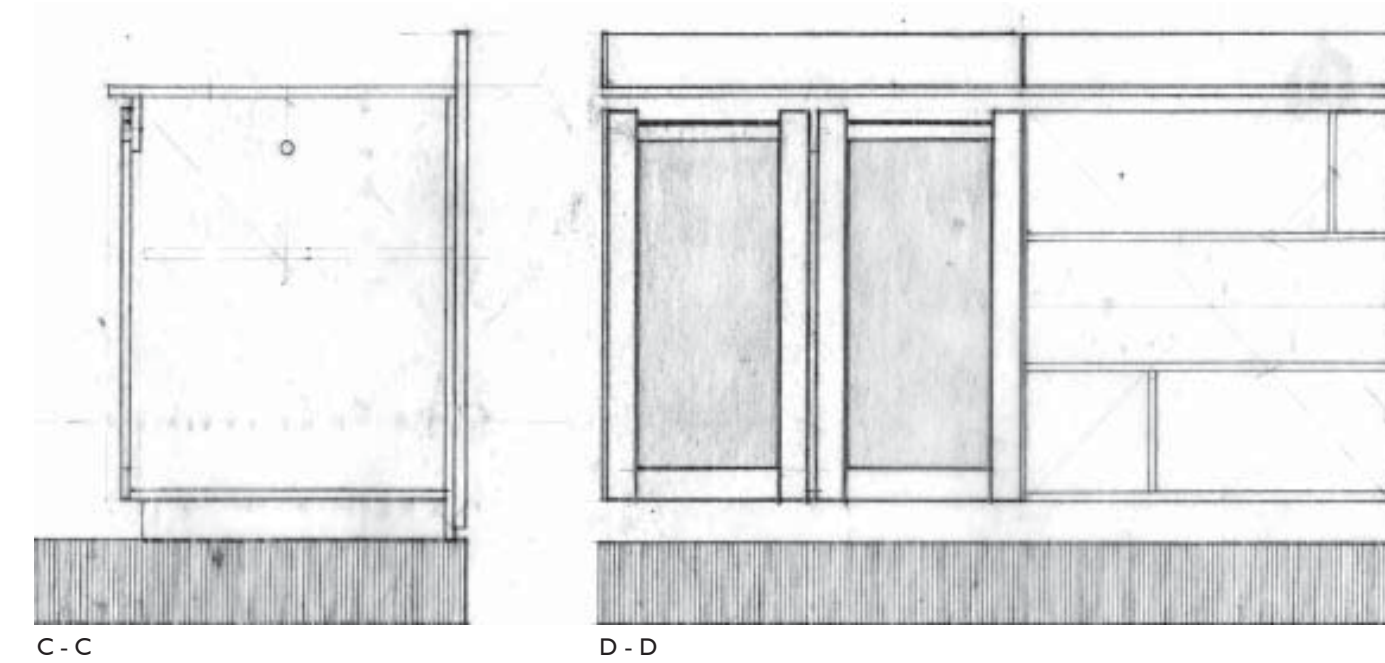

The storage cabinets provide a barrier to below, al-  
lowing light to come in from the yard and a view of  
the back yard. Giving the feeling that the room is  
larger, the ceiling continues to the exterior wall.

73

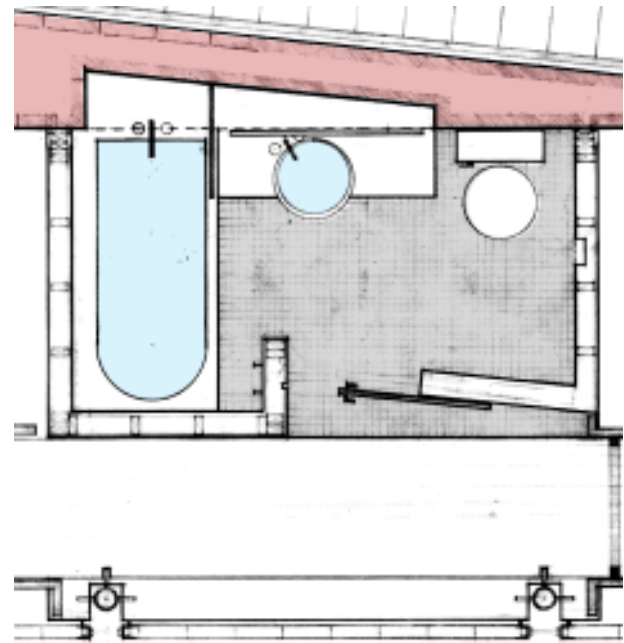

The center volume is the bathroom.

A simple, intimate space. This room has a low ceiling. The red wall is an integral part of the space. A subtraction is made to provide space for a pivoting mirror and shelving behind.

A glass partition cuts through the shelving and the shelving becomes part of the shower. The floor, and the tub and shower are 1 x 1 glass tile.

The bathroom door is on a slider to provide minimal intrusion to the bathroom and bridge and maximize both spaces.

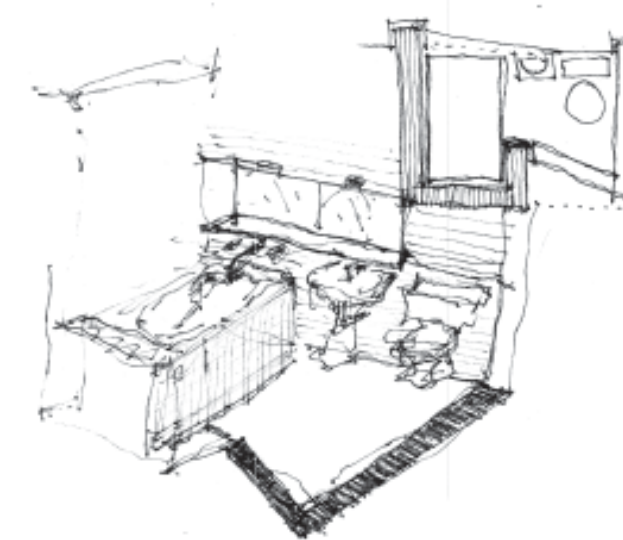

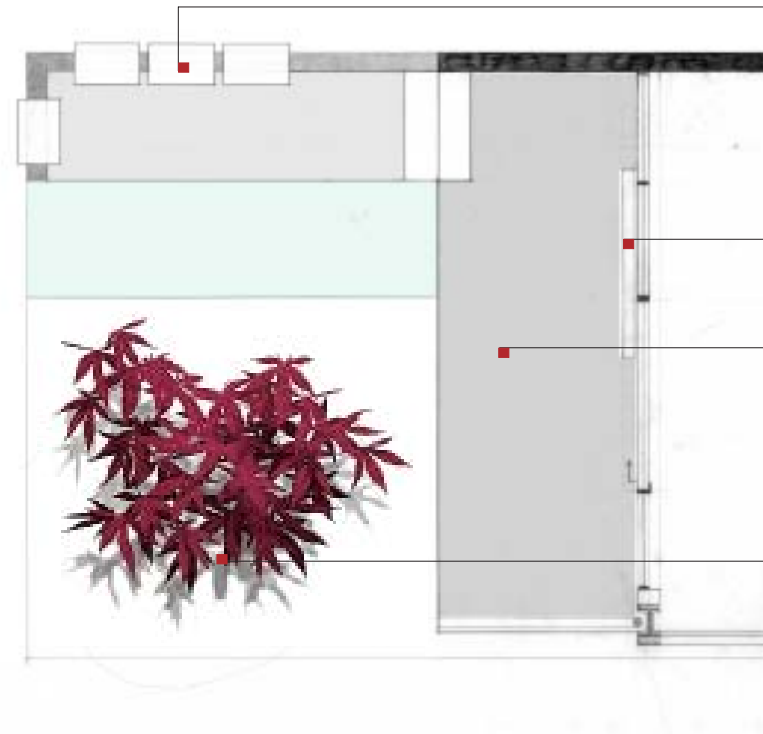

the north wall ends and lowers, providing a place for seating

the door slides wide open to extend the living room to accommodate many people, or swings open for one.

the living room floor continues beyond the door to the backyard, 20" above ground level, and becomes a shaded place to sit.

a japanese maple tree sits in the center of the space providing shading and additional privacy

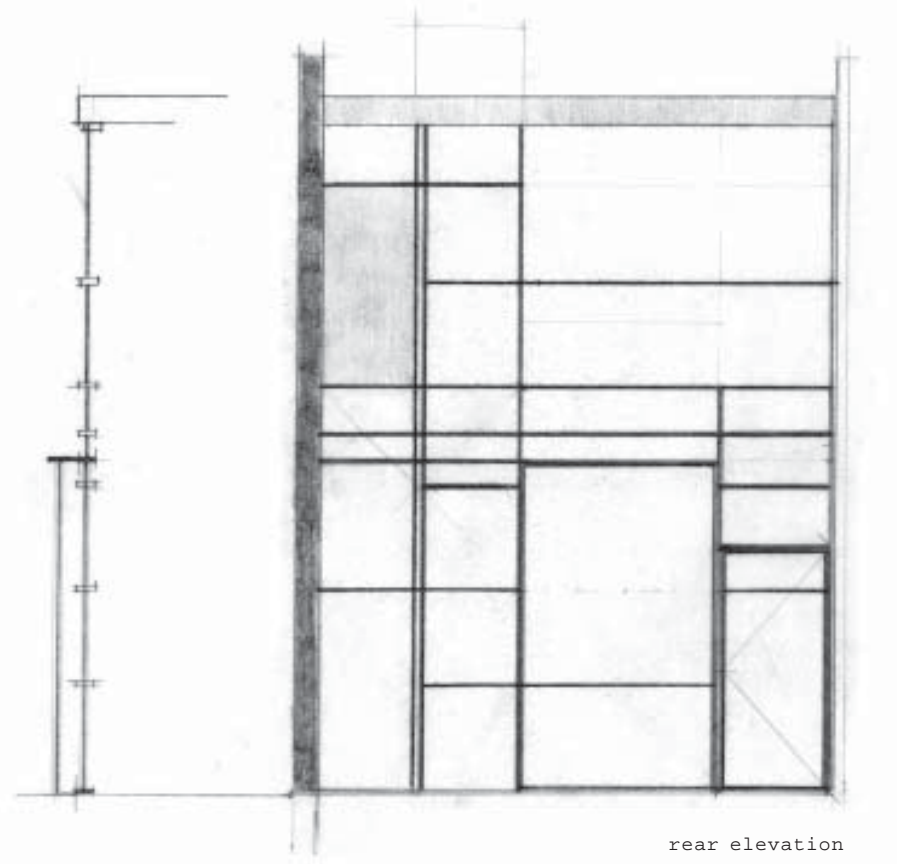

rear elevation



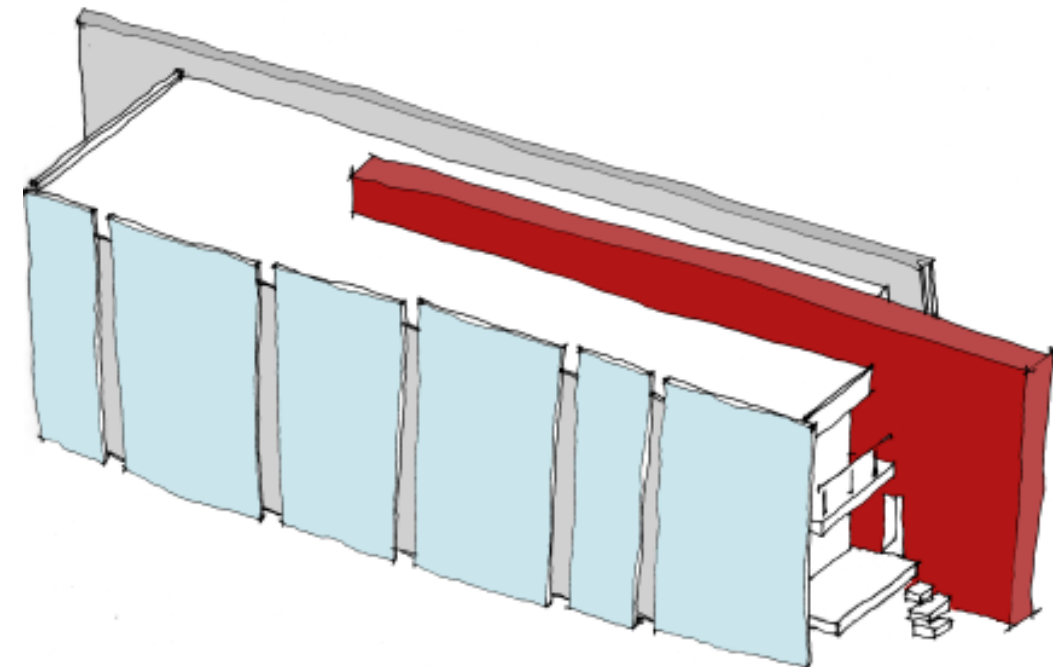

Understanding *house* (a building or shelter where one lives), specifically, understanding how one lives in it. This house is designed with a series of places that work together creating an awareness or **experience** of the flow through the house; how one enters the house with bag of groceries, opens the door to a visitor, or moves from place to place. Simple elements such as stairs that are tucked away, or a handrail that continues through the red wall are gestures to direct one through the house. This, implying that a place may be private and require an invitation, or public and simply inviting through design.

The deliberate **details** between dissimilar materials set up a hierarchy between the elements in the house. This is expressed in the connections between the red wall and the southwall. The volumes are enhanced by not allowing the walls or floors to outwardly touch the southwall, creating a closed room in lieu of a volume. The connection detail permits the column to stand free from the southwall while supporting the volume floors, and the southwall is supported delicately with a channel to the volume floor. Furthermore the volume floors are received by corbeled brick in the red wall. Equally important are the details between the places in the house; through open, large, or hidden stairs, the varying ceiling heights, or handrails which enhance the experience of the house.

The precedents of the neighborhood; scale, proportion, and materials are opportunities suggested by a historical **context**. Observing and understanding routine movement on a daily basis in the neighborhood and being aware of how people use their houses from street parking, to the use and wear of the sidewalk, through the entrance and on to the porch provided guidance for this house.

We perceive things because they are in contrast with something else. Our perception of the red wall as we walk along the path to the entrance, contrast our experience of the red wall when we walk through it. We also would recognize the hierarchy of the brick wall when it corbels back to accept the concrete floor; contrasting in color, textures, and shape. The house as a whole contrasts that of its neighbor, by sharing the concepts of house, but the composition of those concepts creates the architectural event.

As I work through current projects I continue to locate the red wall in my projects. I find that drawings are mere ideas that need to be tested through construction, and even through construction, it continues to be tested through the evolution of time.

This is simply the beginning of the experiences of architecture.



**sarah anne mcinerney**

02 October 1974

Canada

2006|*Master of Architecture*Virginia Polytechnic Institute & State University  
Blacksburg, VA2003-present|*Intern Architect*Walter Parks Architect  
Richmond, VA1998|*Bachelor of Fine Arts - Interior Design*Virginia Commonwealth University  
Richmond, VA1997|*Europe Study Abroad Travel Program*Virginia Polytechnic Institute & State University  
Riva San Vitale, Switzerland

---

credits

quotes

Oregon Hill Home Improvement Council, Inc. "Oregon Hill Celebrates," *The Spring Street Initiative*, 28 January 2000

Khan, Louis, quoted by V. Scully. "Louis Kahn" New York, Braziller, 1962

images

all photos and sketches by author.