

Constraints on R-parity violating couplings from CERN LEP and SLAC SLD hadronic observables

Oleg Lebedev*, Will Loinaz†, and Tatsu Takeuchi‡

*Institute for Particle Physics and Astrophysics, Physics Department, Virginia Tech, Blacksburg,
VA 24061*

(Revised January 15, 2000)

Abstract

We analyze the one loop corrections to hadronic Z decays in an R-parity violating extension to the Minimal Supersymmetric Standard Model (MSSM). Performing a global fit to all the hadronic observables at the Z -peak, we obtain stringent constraints on the R-violating coupling constants λ' and λ'' . The presence of these couplings worsens the agreement with the data relative to the Standard Model. The strongest constraints come from the b asymmetry parameters A_b and $A_{\text{FB}}(b)$. From a *classical* statistical analysis we find that the couplings λ'_{i31} , λ'_{i32} , and λ''_{321} are ruled out at the 1σ level, and that λ'_{i33} and λ''_{33i} are ruled out at the 2σ level. We also obtain Bayesian confidence limits for the R-violating couplings.

12.60.Jv, 12.15.Lk, 13.38.Dg

Typeset using REVTeX

*electronic address: lebedev@quasar.phys.vt.edu

†electronic address: loinaz@alumni.princeton.edu

‡electronic address: takeuchi@vt.edu

I. INTRODUCTION

R-parity conservation is often assumed in supersymmetric model building in order to prevent a host of phenomenological complications such as fast proton decay. This also serves to make the lightest supersymmetric particle (LSP) stable and thus provide a dark matter candidate. However, R-parity conservation is not a *necessary* condition for avoiding many of these problems. For example, the imposition of other discrete symmetries, such as conservation of either baryon number or lepton number, may be adequate to provide phenomenologically acceptable models. (For recent reviews, see Ref. [1].) Furthermore, the evidence for neutrino mass recently observed at Super-Kamiokande [2] lends improved motivation to consider R-parity violating extensions to the minimal supersymmetric standard model (MSSM). Therefore, one is led to question just how much R-parity violation can be introduced without conflict with current experimental data. In this paper, we study the radiative corrections from R-parity violating extensions of the MSSM to the electroweak observables in hadronic Z decays, namely the ratios of hadronic partial widths and the parity violating asymmetries. Experimental data from LEP and SLD place stringent limits on the size of these corrections, thereby constraining the possible strengths of the R-violating interactions.

We focus on the effects of the R-parity violating superpotential and neglect possible effects from the corresponding soft-breaking terms [3]. This simplification allows us to rotate away the bilinear terms [4]. In this case, the R-parity violating superpotential has the following form:

$$W_{\mathcal{R}} = \frac{1}{2}\lambda_{ijk}\hat{L}_i\hat{L}_j\hat{E}_k + \lambda'_{ijk}\hat{L}_i\hat{Q}_j\hat{D}_k + \frac{1}{2}\lambda''_{ijk}\hat{U}_i\hat{D}_j\hat{D}_k, \quad (1.1)$$

where \hat{L}_i , \hat{E}_i , \hat{Q}_i , \hat{U}_i , and \hat{D}_i are the MSSM superfields defined in the usual fashion [5], and the subscripts $i, j, k = 1, 2, 3$ are the generation indices. These interactions can give potentially sizeable radiative corrections to the hadronic observables depending on the size of the coupling constants λ , λ' , and λ'' . The λ couplings are already tightly constrained to be $O(10^{-2})$ or less, and their effect on the Z -peak observables is negligible [6].¹ The constraints on the λ' and λ'' couplings are much less stringent. However, they cannot be present simultaneously in the Lagrangian since this would lead to unacceptably fast proton decay [1]. Therefore, we can make the further simplifying assumption that only one or other of the operators $\hat{L}_i\hat{Q}_j\hat{D}_k$ and $\hat{U}_i\hat{D}_j\hat{D}_k$ is present at a time.

When constraining R-violating interactions using experimental data, it is important to provide a consistent accounting of the corrections from the R-conserving sector also since they may be sizable depending on the choice of SUSY parameters. It is also important to include *all* the affected observables in a global fit since different observables may pull the fit values in opposite directions. This was illustrated in our previous paper [7] in which the violation of lepton universality was used to constrain the λ' couplings. There, the Z -lineshape observables alone preferred a 2σ limit of $|\lambda'_{33k}| < 0.30$, but a global fit resulted

¹They do not affect the quark couplings in any case.

in $|\lambda'_{33k}| < 0.42$. Neither of these points were considered in previous works such as Ref. [8] where R-conserving corrections were neglected altogether, and only corrections to the ratios of hadronic to leptonic partial widths $R_\ell = \Gamma_{\text{had}}/\Gamma_{\ell\bar{\ell}}$ ($\ell = e, \mu, \tau$) were considered. It is clear that these ratios receive R-conserving corrections from top-Higgs and chargino-sfermion loops, as well as QCD and gluino corrections which depend strongly on $\alpha_s(M_Z)$. Therefore, the resulting 1σ bound of $|\lambda''_{3jk}| \leq 0.50$ of Ref. [8] is hardly robust.

In this paper, we consider all the purely hadronic observables which can be expressed as ratios of the quark couplings to the Z , *i.e.* the ratios of hadronic partial widths and the parity violating asymmetry parameters. These are unaffected by QCD and gluino corrections since they modify the left- and right-handed quark couplings multiplicatively, leaving the ratios of the couplings intact.² The rest of the R-conserving sector induces relevant corrections to the *left-handed* quark couplings only, whereas the R-breaking sector affects predominantly the *right-handed* quark couplings. This allows us to parametrize and constrain the R-conserving and R-breaking corrections separately, thereby constraining the R-breaking sector without making *ad hoc* assumptions about the R-conserving sector.³ Also, since we incorporate into our fit the corrections to the forward-backward and polarization asymmetries which are much more sensitive than R_ℓ to the shifts in the *right-handed* quark couplings, we are able to substantially improve the limits on the R-breaking interactions.

This paper is organized as follows: In section II we discuss the approximations we make to simplify our analysis. In sections III and IV we discuss how the λ' and λ'' interactions affect the couplings of the quarks to the Z . Section V discusses the corrections from the R-conserving sector. In sections VI and VII, we parametrize the R-conserving and R-violating corrections to the LEP/SLD observables and fit them to the latest experimental data, and then translate the result into limits on λ' and λ'' . In section VIII, we provide the Bayesian confidence limits on λ' and λ'' with the a priori assumption that the MSSM with R-violation is the correct underlying theory. Section IX concludes.

II. PRELIMINARY SIMPLIFICATIONS

As we stated in the introduction, we only consider supersymmetric R-violating interactions and neglect the effects of soft-breaking R-violating terms.⁴ We also neglect the λ'' interactions and consider only the λ' or the λ'' interactions at a time. In addition, left-right squark mixing is neglected since their effects are expected to be unimportant [7]. Even with these simplifications, we still have 27 independent λ' couplings or 9 independent λ'' couplings which must be considered.

²We assume degenerate squark masses.

³Similar methods have been used in Ref. [9] and [10] to constrain flavor specific vertex corrections while taking into account the flavor universal oblique corrections.

⁴See Ref. [3] for a discussion on their possible effects. LEP/SLD hadronic observables can also be affected by resonant sneutrino production [12].

However, a careful look at the diagrams which must be calculated begets a further simplification. The corrections to the $Zq\bar{q}$ vertex generated by the λ' and λ'' interactions in the superpotential fall into four classes:

1. One particle irreducible (1PI) diagrams with two scalars and one fermion in the loop.
2. 1PI diagrams with two fermions and one scalar in the loop.
3. 1PI diagrams with two fermions and one scalar in the loop, with two mass insertions on the fermion lines.
4. Fermion wavefunction renormalization diagrams.

In these diagrams, it is clear that the scalar must be the sparticle while the internal fermion must be an ordinary lepton or quark. The invariant masses of the external gauge boson and the external fermions must be set to m_Z^2 and $m_q^2 \approx 0$, respectively.

Of the four classes, the third class is finite while the $1/\epsilon$ poles of the first two classes cancel against the poles in the fermion wavefunction renormalizations. An explicit evaluation of the finite pieces of the diagrams reveal [7] that they lead to numerically significant contributions only when the fermion running in the loop is heavy. In fact, the amplitude of a diagram with a massless internal fermion is only about 10% of that with an internal top-quark, assuming that the scalar (sfermion) mass is the same. Since each diagram is proportional to λ' or λ'' squared, dropping these 10% contributions to the amplitude will result in a 5% uncertainty in the limits obtained for the λ' and λ'' . We can therefore neglect any diagram which does not involve a top-quark. This means that the only R-violating couplings which are relevant to our discussion are λ'_{i3k} (9 parameters) and λ''_{3jk} (3 parameters).

Furthermore, the values of the top-quark diagrams at $m_Z^2 \rightarrow 0$ provide an excellent approximation to the full integral. Henceforth we work in this approximation. (We note that the diagrams carrying only massless fermions would vanish in this limit even if we had previously retained them.)

In the limit $m_Z^2 \rightarrow 0$, the four classes of diagrams can be written in terms of the $1/\epsilon$ pole piece and two independent functions of the fermion-scalar mass ratio $x = m_f^2/m_s^2$ which we call $f(x)$ and $g(x)$. Their explicit forms are shown in the Appendix. We note that $g(x)$, the function which appears in the two-scalar one-fermion, and the fermion wavefunction renormalization diagrams, vanishes rapidly as $x \rightarrow 1$. Thus, the finite pieces of the the two-scalar one-fermion and the wavefunction renormalization diagrams may be neglected for small scalar-fermion mass splittings. Note further that if the poles of these diagrams cancel (as is the case for diagrams involving gluinos, for example), the $m_Z^2 = 0$ finite pieces will also cancel. These considerations apply equally to R-conserving corrections leading to significant simplifications in their contributions as well, the details of which will be discussed in Sec. V.

III. CORRECTIONS FROM THE λ' INTERACTIONS

The R-parity violating λ' interactions expressed in terms of the component fields take the form

$$\begin{aligned} \Delta\mathcal{L}'_R = & \lambda'_{ijk} \left[\tilde{\nu}_{iL} \bar{d}_{kR} d_{jL} + \tilde{d}_{jL} \bar{d}_{kR} \nu_{iL} + \tilde{d}_{kR}^* \bar{\nu}_{iL}^c d_{jL} \right. \\ & \left. - (\tilde{e}_{iL} \bar{d}_{kR} u_{jL} + \tilde{u}_{jL} \bar{d}_{kR} e_{iL} + \tilde{d}_{kR}^* \bar{e}_{iL}^c u_{jL}) \right] + h.c. \end{aligned} \quad (3.1)$$

As discussed in the previous section, the dominant corrections to hadronic Z decays from these interactions are those which involve the top-quark. These are shown in Fig. 1. (The diagrams with an internal top-quark and external leptons were considered in Ref. [7].) This necessarily means that only the couplings of the *right-handed down-type* quarks d_{iR} to the Z are corrected in our approximation.

Using notation established in Ref. [7], the corrections to the Z decay amplitude from these diagrams are

$$\begin{aligned} & -|\lambda'_{i3k}|^2 \left[-i \frac{g}{\cos \theta_W} Z^\mu (p+q) \bar{q}_{kR}(p) \gamma_\mu q_{kR}(q) \right] \times \\ (1a) : & 2h_{eL} \hat{C}_{24} (0, 0, m_Z^2; m_t, m_{\tilde{e}_{iL}}, m_{\tilde{e}_{iL}}) \\ (1b) : & h_{uL} \left[(d-2) \hat{C}_{24} (0, 0, m_Z^2; m_{\tilde{e}_{iL}}, m_t, m_t) \right. \\ & \quad \left. - m_Z^2 \hat{C}_{23} (0, 0, m_Z^2; m_{\tilde{e}_{iL}}, m_t, m_t) \right] \\ (1c) : & -h_{uR} m_t^2 \hat{C}_0 (0, 0, m_Z^2; m_{\tilde{e}_{iL}}, m_t, m_t) \\ (1d) + (1e) : & 2h_{dR} B_1 (0; m_t, m_{\tilde{e}_{iL}}) \end{aligned} \quad (3.2)$$

where

$$h_{fL} = I_{3f} - Q_f \sin^2 \theta_W, \quad h_{fR} = -Q_f \sin^2 \theta_W. \quad (3.3)$$

The tree level amplitude is $h_{d_{iR}}$ times the expression in the square brackets. These corrections can be expressed as a shift in the coupling $h_{d_{iR}}$:

$$\begin{aligned} \delta h_{i3k} \equiv & -|\lambda'_{i3k}|^2 \left[2h_{eL} \hat{C}_{24} (m_t, m_{\tilde{e}_{iL}}, m_{\tilde{e}_{iL}}) \right. \\ & + h_{uL} \left\{ (d-2) \hat{C}_{24} (m_{\tilde{e}_{iL}}, m_t, m_t) - m_Z^2 \hat{C}_{23} (m_{\tilde{e}_{iL}}, m_t, m_t) \right\} \\ & - h_{uR} m_t^2 \hat{C}_0 (m_{\tilde{e}_{iL}}, m_t, m_t) \\ & \left. + h_{dR} B_1 (m_t, m_{\tilde{e}_{iL}}) \right] \end{aligned} \quad (3.4)$$

Henceforth we assume a common slepton mass $m_{\tilde{e}_{iL}} = m_{\tilde{e}}$, $i = 1, 2, 3$. The full expression for δh_{i3k} is well approximated by the leading $m_Z^2 = 0$ piece of the expansion in the Z mass:

$$\delta h_{i3k} \approx \frac{1}{2(4\pi)^2} |\lambda'_{i3k}|^2 F(x) \quad (3.5)$$

where

$$F(x) = f(x) + g(x) = \frac{x}{1-x} \left(1 + \frac{1}{1-x} \ln x \right), \quad x = \frac{m_t^2}{m_{\tilde{e}}^2}. \quad (3.6)$$

For $m_{\tilde{e}} = 100\text{GeV}$, this becomes

$$\delta h_{i3k} \approx -0.215\% |\lambda'_{i3k}|^2. \quad (3.7)$$

The full shift to the coupling of the quark d_{kR} to the Z due to R-violating λ' interactions is then obtained by summing over the slepton generation index i

$$\begin{aligned} \delta h_{d_k}^R &= \sum_i \delta h_{i3k} \\ &\approx -0.215\% \sum_i |\lambda'_{i3k}|^2 \end{aligned} \quad (3.8)$$

Observe that this is a different combination of λ' couplings than the combination $\sum_k |\lambda'_{i3k}|^2$ which is constrained by lepton universality in Ref. [7].

IV. CORRECTIONS FROM THE λ'' INTERACTIONS

The R-parity violating λ'' interactions expressed in terms of the component fields take the form

$$\Delta \mathcal{L}''_R = \frac{1}{2} \lambda''_{ijk} \left[u_i^c d_j^c \tilde{d}_k^* + u_i^c \tilde{d}_j^* d_k^c + \tilde{u}_i^* d_j^c d_k^c \right] + h.c. \quad (4.1)$$

The $SU(3)$ color indices are suppressed. Note that λ''_{ijk} is antisymmetric in the last two indices due to color anti-symmetrization.

Again, the corrections involving a top-quark are necessarily those with a right-handed down-type quark on the external legs as shown in Fig. 2. Their respective contributions to the amplitude are:

$$\begin{aligned} &-2|\lambda''_{3jk}|^2 \left[-i \frac{g}{\cos \theta_W} Z^\mu (p+q) \bar{q}_{jR}(p) \gamma_\mu q_{jR}(q) \right] \times \\ (2a) &: -2h_{dR} \hat{C}_{24} (0, 0, m_Z^2; m_t, m_{\tilde{d}_{kR}}, m_{\tilde{d}_{kR}}) \\ (2b) &: -h_{uR} \left[(d-2) \hat{C}_{24} (0, 0, m_Z^2; m_{\tilde{d}_{kR}}, m_t, m_t) \right. \\ &\quad \left. - m_Z^2 \hat{C}_{23} (0, 0, m_Z^2; m_{\tilde{d}_{kR}}, m_t, m_t) \right] \\ (2c) &: h_{uL} m_t^2 \hat{C}_0 (0, 0, m_Z^2; m_{\tilde{d}_{kR}}, m_t, m_t) \\ (2d) + (2e) &: 2h_{dR} B_1 (0; m_t, m_{\tilde{d}_{kR}}) \end{aligned} \quad (4.2)$$

The common leading factor of 2 in this equation is a consequence of the identity

$$\varepsilon_{abc} \varepsilon_{a'bc} = 2\delta_{aa'}.$$

These corrections shift the coupling of the right-handed down-type quark $h_{d_{jR}}$ to the Z by

$$\begin{aligned} \delta h_{3jk} &\equiv -2|\lambda''_{3jk}|^2 \left[-2h_{dR} \hat{C}_{24} (m_t, m_{\tilde{d}_{kR}}, m_{\tilde{d}_{kR}}) \right. \\ &\quad \left. - h_{uR} \left\{ (d-2) \hat{C}_{24} (m_{\tilde{d}_{kR}}, m_t, m_t) - m_Z^2 \hat{C}_{23} (m_{\tilde{d}_{kR}}, m_t, m_t) \right\} \right. \\ &\quad \left. + h_{uL} m_t^2 \hat{C}_0 (m_{\tilde{d}_{kR}}, m_t, m_t) \right] \end{aligned}$$

$$+h_{d_R} B_1(m_t, m_{\tilde{d}_{kR}}) \Big] \quad (4.3)$$

We assume a common squark mass $m_{\tilde{d}_{kR}} = m_{\tilde{d}}$, $k = 1, 2, 3$. As in the λ' case, we have neglected all diagrams which vanish in the limit $m_Z \rightarrow 0$ in the above expression. Applying the same approximation to the leading diagrams leaves:

$$\delta h_{3jk} \approx \frac{1}{(4\pi)^2} |\lambda''_{3jk}|^2 F(x) \quad (4.4)$$

with $x = m_t^2/m_{\tilde{d}}^2$. For $m_{\tilde{d}} = 100\text{GeV}$, this becomes

$$\delta h_{3jk} \approx -0.43\% |\lambda''_{3jk}|^2. \quad (4.5)$$

The full shift to the coupling of the quark d_{jR} to the Z due to R-violating λ'' interactions is then obtained by summing over the slepton generation index k

$$\begin{aligned} \delta h_{d_{jR}}^R &= \sum_k \delta h_{3jk} \\ &\approx -0.43\% \sum_k |\lambda''_{3jk}|^2. \end{aligned} \quad (4.6)$$

In contrast to the λ' case, λ'' interactions do *not* correct any of the lepton couplings to the Z . Thus they do not give rise to lepton universality violations, and no additional constraints on λ'' couplings arise from analysis of the lepton sector. Thus, all significant R-violating λ'' shifts to Z pole observables appear as shifts to the effective coupling of the Z to right-handed down-type quarks.

V. CORRECTIONS FROM R-CONSERVING INTERACTIONS

As stressed in the introduction, in order to isolate the effects of R-violating interactions we must properly parametrize the R-conserving radiative corrections (a partial study of these effects has also been performed in [25]). We work in the limit of degenerate sfermion masses and $\tan\beta$ not large. In this limit, only two parameters are necessary to account for R-conserving effects.

We list all relevant vertex corrections from R-conserving MSSM interactions:

chargino-sfermion loops :

The fermion interactions with the gaugino component of the chargino can generate substantial corrections to the left-handed couplings of all the fermions (Fig. 3). The correction to the up-type and down-type quark couplings from the diagrams shown in Figs. 3b,c,d are proportional to

$$\begin{aligned} \delta h_{u_L}^{(3b,c,d)} &\propto 2h_{d_L} \hat{C}_{24}(m_{\tilde{\chi}}, m_{\tilde{d}_L}, m_{\tilde{d}_L}) + h_{u_L} B_1(m_{\tilde{\chi}}, m_{\tilde{d}_L}), \\ \delta h_{d_L}^{(3b,c,d)} &\propto 2h_{u_L} \hat{C}_{24}(m_{\tilde{\chi}}, m_{\tilde{u}_L}, m_{\tilde{u}_L}) + h_{d_L} B_1(m_{\tilde{\chi}}, m_{\tilde{u}_L}), \end{aligned} \quad (5.1)$$

where the dependence on the external momenta have been suppressed. In the limit $m_Z^2 \rightarrow 0$ and $m_{\tilde{u}_L} = m_{\tilde{d}_L}$, it is clear (see Appendix) that

$$\delta h_{u_L}^{(3b,c,d)} = -\delta h_{d_L}^{(3b,c,d)} \propto (h_{u_L} - h_{d_L}) = (1 - \sin^2 \theta_W). \quad (5.2)$$

A similar relation exists for the correction to the leptonic vertices provided $m_{\tilde{\nu}_L} = m_{\tilde{e}_L}$. In addition, the diagram of Fig. 3a changes sign with the isospin of the final-state fermion. As a result, the combined contribution from all the diagrams in Fig. 3 is proportional to the isospin of the final-state fermion but otherwise universal in the limit that all the (left-handed) squark and slepton masses are degenerate.

A shift proportional to the isospin can be written as an overall multiplicative change in the coupling and a shift in the effective value of $\sin^2 \theta_W$:

$$\begin{aligned} h_{f_L} &= I_{3f}(1 + \delta) - Q \sin^2 \theta_W = (1 + \delta) \left(I_{3f} - Q \frac{\sin^2 \theta_W}{1 + \delta} \right) \\ h_{f_R} &= -Q \sin^2 \theta_W = (1 + \delta) \left(-Q \frac{\sin^2 \theta_W}{1 + \delta} \right) \end{aligned} \quad (5.3)$$

Since we utilize only observables which are ratios of couplings, the multiplicative correction cancels and only the shift in $\sin^2 \theta_W$ is measurable.

charged Higgs–top (Higgsino–stop) loops :

The charged Higgs–top corrections (Figs. 4a,d,e) and the supersymmetrized versions of these diagrams containing the chargino–right handed stop loops (Figs. 4b,c), as well as the corresponding wavefunction renormalizations are peculiar to the b_L final states. Higgs and higgsino couplings to the b_R and other fermion final states are suppressed by the light fermion masses and are neglected. The model generically predicts $\delta h_{b_L}^{\text{Higgs}} > 0$. This is a result of the fact that (1) the charged Higgs contribution is always positive [24] and (2) explicit calculation shows that the leading p^2/m^2 Higgsino contribution vanishes.⁵

gluino–squark loops :

The leading ($m_Z^2 = 0$) contributions from the diagrams shown in Fig. 5 vanish as a result of the relation (see Appendix)

$$\left[2 \hat{C}_{24}(0, 0, m_Z^2; m_{\tilde{g}}, m_{\tilde{q}}, m_{\tilde{q}}) + B_1(0; m_{\tilde{g}}, m_{\tilde{q}}) \right]_{m_Z^2=0} = 0. \quad (5.4)$$

Even for the subleading terms, in the limit of degenerate squark masses the gluino–squark loops induce only a universal shift to all of the Z –quark couplings. Just as for QCD corrections, this shift cancels in the ratios of hadronic widths and asymmetries and therefore does not enter into our analysis.

neutralino–sfermion loops :

The gaugino component of the neutralino generates shifts to all of the couplings

⁵For the purpose of this analysis, we treat Higgsino and gaugino contributions separately.

(Fig. 6). However, the only (potentially) significant diagrams are all of the two scalar, three particle variety. When these are combined with wavefunction renormalization diagrams, the leading $m_Z^2 = 0$ pieces cancel in the sum (see Eq. 5.4). Therefore, these can be neglected altogether.

oblique corrections :

In addition to all these vertex corrections, R-conserving interactions can also affect Z -peak observables through vacuum polarization diagrams, aka the oblique corrections. Oblique corrections can all be subsumed into a shift in the ρ parameter and the effective value of $\sin^2 \theta_W$, the first of which cancels in all of the observables that we consider [11].

Thus, in our approximation, the only R-conserving effects we need to consider are (1) a shift in the left-handed b coupling from charged Higgs/Higgsino corrections, and (2) a universal shift in the effective value of $\sin^2 \theta_W$ which subsumes the isospin-proportional correction due to chargino-squark loops as well as the oblique corrections.

VI. FIT TO THE DATA

As we have seen, the R-violating λ' couplings correct the left-handed couplings of the charged leptons and the right-handed couplings of the down-type quarks while the λ'' couplings correct the right-handed couplings of the down-type quarks only. The R-conserving chargino-sfermion correction is absorbed into a universal shift of $\sin^2 \theta_W$ (provided that all the sfermions are degenerate) while the Higgs-top correction is only relevant for the left-handed b quark. Since we have already discussed the limits placed on the λ' couplings from the leptonic observables in a previous paper [7], we will concentrate on the corrections to the quark observables and perform a fit which encompassed both the λ' and λ'' cases.

In order to constrain the size of these corrections we will use the *ratios* of the hadronic parital widths

$$R_q = \frac{\Gamma_{q\bar{q}}}{\Gamma_{\text{had}}} = \frac{h_{qL}^2 + h_{qR}^2}{\sum_{q'=u,d,s,c,b} (h_{q'L}^2 + h_{q'R}^2)}, \quad (q = c, b)$$

$$R'_q = \frac{\Gamma_{q\bar{q}}}{\Gamma_{u\bar{u}} + \Gamma_{d\bar{d}} + \Gamma_{s\bar{s}}} = \frac{h_{qL}^2 + h_{qR}^2}{\sum_{q=u,d,s} (h_{q'L}^2 + h_{q'R}^2)}, \quad (q = u, d, s)$$

and the parity-violating asymmetry parameters

$$A_q = \frac{h_{qL}^2 - h_{qR}^2}{h_{qL}^2 + h_{qR}^2}, \quad A_{\text{FB}}(q) = \frac{3}{4} A_e A_q, \quad (q = u, d, s, c, b).$$

These observables have the convenient property that (1) they are insensitive to QCD and gluino-squark corrections, and (2) the only dependence on oblique corrections (vacuum polarizations) comes from a shift in the effective value of $\sin^2 \theta_W$. This will permit us to

constrain the parameters we are interested in without complicating the fit procedure by introducing gluon/gluino corrections or corrections to the ρ parameter.

Of the leptonic observables, we will include the ratio of electron to neutrino widths $R_{\nu/e} = \Gamma_{\nu\bar{\nu}}/\Gamma_{e^+e^-}$ and the electron asymmetry parameters A_e and $A_{\text{FB}}(e) = \frac{3}{4}A_e^2$ to help constrain the universal R-conserving and oblique corrections. Corrections to A_e must be considered in any case since it is present in the hadronic observables $A_{\text{FB}}(q)$. Though the left-handed lepton couplings receive corrections from the λ' interactions, the size of the correction particular to the electron is already so tightly constrained to be small by other experiments that we can neglect it entirely. We drop all μ or τ dependent observables from our fit so that we can use the result to constrain both the λ' and λ'' cases.

In table I we list the experimental data we use in our fit with correlation matrices shown in tables II and III. We caution the reader that many of these numbers are preliminary results announced during the summer 1999 conferences so they, and our resulting fit derived from them, may be subject to change. Some comments are in order:

1. The ratio

$$R_{\nu/e} = \frac{\Gamma_{\nu\bar{\nu}}}{\Gamma_{e^+e^-}} = \frac{h_{\nu L}^2}{h_{eL}^2 + h_{eR}^2}$$

is calculated from the first six Z -lineshape observables. Its correlation to $A_{\text{FB}}(e)$ is +28%. Its correlations to the μ and τ observables, which we drop, are negligibly small.

2. The τ polarization data has been updated from Ref. [13] with new numbers from DELPHI [14,15]. We keep only A_e and drop A_τ .
3. The SLD value of A_{LR} (which is the same thing as A_e) is from hadronic events only. A_e is from the leptonic events. Its correlations to the dropped A_μ and A_τ are negligibly weak. (The errors are dominated by statistics [16].)
4. The OPAL measurements of R'_s , $A_{\text{FB}}(s)$, and $A_{\text{FB}}(u)$ assume Standard Model values of $R'_d = 0.359$ and $A_{\text{FB}}(d) = 0.100$. To account for the shifts in the down observables in our model, the data should be interpreted as constraining the following linear combinations:

$$\begin{aligned} R'_s &= R'_s + 1.83 [R'_d - 0.359] \\ A_{\text{FB}}^*(s) &= A_{\text{FB}}(s) - 0.32 [A_{\text{FB}}(d) - 0.100] \\ A_{\text{FB}}^*(u) &= A_{\text{FB}}(u) - 1.42 [A_{\text{FB}}(d) - 0.100] \end{aligned}$$

There is a +31% correlation between $A_{\text{FB}}^*(s)$ and $A_{\text{FB}}^*(u)$ [17].

5. The DELPHI measurement of $A_{\text{FB}}(s)$ assumes standard model values of $A_{\text{FB}}(u) = 0.0736$ and $A_{\text{FB}}(d) = 0.1031$. It should be interpreted as a measurement of the following linear combination [18]:

$$A_{\text{FB}}^{**}(s) = A_{\text{FB}}(s) - 0.156 [A_{\text{FB}}(u) - 0.0736] - 0.117 [A_{\text{FB}}(d) - 0.1031] .$$

6. The SLD measurement of A_s [19] assumes standard model values for A_u , A_d , R'_u , and R'_d . (The dependence on the heavy flavor variables are weak and negligible.) To account for shifts in these input parameters the measurement should be interpreted as constraining [20]

$$A_s^* = A_s - 0.0602 [A_u - 0.668] - 0.0467 [A_d - 0.936] \\ - 1.32 [R'_u - 0.280] - 1.20 [R'_d - 0.360]$$

7. The heavy flavor data is the combined fit to the LEP and SLD data compiled by the LEP Electroweak Working Group [14]. The central values of A_b and A_c are shifted compared to the original SLD values of

$$A_b = 0.905 \pm 0.026 \\ A_c = 0.634 \pm 0.027$$

Using these numbers instead of those shown in Table I will result in a slightly tighter constraint on the R-violating couplings, but we will present the results using the LEPEWWG numbers to be on the conservative side.

We denote the shift in $\sin^2 \theta_W$ due to oblique and chargino–sfermion corrections by δs^2 , and the shift from the Higgs interactions specific to the left-handed coupling of the b by $\delta h_{b_L}^{\text{Higgs}}$. The R-violating shifts specific to the right-handed couplings of the d , s , and b quarks are denoted $\delta h_{d_R}^R$, $\delta h_{s_R}^R$, and $\delta h_{b_R}^R$. Then the shifts in the couplings of the quarks, the electron, and the neutrino are given by:

$$\begin{aligned} \delta h_{\nu_L} &= 0 \\ \delta h_{e_L} &= \delta s^2 \\ \delta h_{e_R} &= \delta s^2 \\ \delta h_{u_L} &= -\frac{2}{3} \delta s^2 \\ \delta h_{u_R} &= -\frac{2}{3} \delta s^2 \\ \delta h_{d_L} &= \frac{1}{3} \delta s^2 \\ \delta h_{d_R} &= \frac{1}{3} \delta s^2 + \delta h_{d_R}^R \\ \delta h_{c_L} &= -\frac{2}{3} \delta s^2 \\ \delta h_{c_R} &= -\frac{2}{3} \delta s^2 \\ \delta h_{s_L} &= \frac{1}{3} \delta s^2 \\ \delta h_{s_R} &= \frac{1}{3} \delta s^2 + \delta h_{s_R}^R \\ \delta h_{b_L} &= -\frac{1}{3} \delta s^2 + \delta h_{b_L}^{\text{Higgs}} \\ \delta h_{b_R} &= -\frac{1}{3} \delta s^2 + \delta h_{b_R}^R \end{aligned}$$

The dependence of the observables on these fit parameters can be calculated in a straightforward manner. For instance, we find:

$$\begin{aligned}\frac{\delta R_{\nu/e}}{R_{\nu/e}} &= \frac{2 \delta h_{\nu L}}{h_{\nu L}} - \frac{2h_{e_L} \delta h_{e_L} + 2h_{e_R} \delta h_{e_R}}{h_{e_L}^2 + h_{e_R}^2} \\ &= - \left(\frac{2h_{e_L} + 2h_{e_R}}{h_{e_L}^2 + h_{e_R}^2} \right) \delta s^2 \\ &= 0.64 \delta s^2\end{aligned}$$

or

$$\delta R_{\nu/e} = 1.17 \delta s^2$$

where the coefficient has been calculated assuming $\sin^2 \theta_W = 0.2315$. Similarly,

$$\begin{aligned}\delta A_e &= -7.61 \delta s^2 \\ \delta A_{\text{FB}}(e) &= -1.63 \delta s^2 \\ \delta R'_s &= 0.151 \delta s^2 + 0.242 \delta h_{d_R}^{\mathcal{R}} - 0.0058 \delta h_{s_R}^{\mathcal{R}} \\ \delta A_{\text{FB}}^*(u) &= 3.74 \delta s^2 + 0.262 \delta h_{d_R}^{\mathcal{R}} \\ \delta A_{\text{FB}}^*(s) &= -3.72 \delta s^2 + 0.0558 \delta h_{d_R}^{\mathcal{R}} - 0.174 \delta h_{s_R}^{\mathcal{R}} \\ \delta A_{\text{FB}}^{**}(s) &= -4.15 \delta s^2 + 0.020 \delta h_{d_R}^{\mathcal{R}} - 0.174 \delta h_{s_R}^{\mathcal{R}} \\ \delta A_s^* &= -0.321 \delta s^2 - 0.0444 \delta h_{d_R}^{\mathcal{R}} - 1.37 \delta h_{s_R}^{\mathcal{R}} \\ \delta R_b &= 0.0392 \delta s^2 - 0.0396 \delta h_{d_R}^{\mathcal{R}} - 0.0396 \delta h_{s_R}^{\mathcal{R}} + 0.141 \delta h_{b_R}^{\mathcal{R}} - 0.771 \delta h_{b_L}^{\text{Higgs}} \\ \delta R_c &= -0.0605 \delta s^2 - 0.0316 \delta h_{d_R}^{\mathcal{R}} - 0.0316 \delta h_{s_R}^{\mathcal{R}} - 0.0316 \delta h_{b_R}^{\mathcal{R}} + 0.173 \delta h_{b_L}^{\text{Higgs}} \\ \delta A_{\text{FB}}(b) &= -5.40 \delta s^2 - 0.172 \delta h_{b_R}^{\mathcal{R}} - 0.0315 \delta h_{b_L}^{\text{Higgs}} \\ \delta A_{\text{FB}}(c) &= -4.17 \delta s^2 \\ \delta A_b &= -0.636 \delta s^2 - 1.61 \delta h_{b_R}^{\mathcal{R}} - 0.295 \delta h_{b_L}^{\text{Higgs}} \\ \delta A_c &= -3.45 \delta s^2\end{aligned}\tag{6.1}$$

Fitting these expressions to the table I data, we obtain:

$$\begin{aligned}\delta s^2 &= -0.00092 \pm 0.00022 \\ \delta h_{d_R}^{\mathcal{R}} &= 0.081 \pm 0.077 \\ \delta h_{s_R}^{\mathcal{R}} &= 0.055 \pm 0.043 \\ \delta h_{b_R}^{\mathcal{R}} &= 0.026 \pm 0.010 \\ \delta h_{b_L}^{\text{Higgs}} &= -0.0031 \pm 0.0042\end{aligned}\tag{6.2}$$

with the correlation matrix shown in table IV. The quality of the fit was $\chi^2 = 12.0/(16 - 5)$. The standard model predictions were obtained using ZFITTER v.6.21 [21] using $m_t = 174.3$ GeV [22] and $m_h = 300$ GeV. Except for δs^2 , the best-fit values and uncertainties of the parameters are virtually unchanged when the Standard Model Higgs mass is varied between 100 GeV and 1 TeV. By far the largest contribution to the χ^2 is from those observables ($R_{\nu/e}$, $A_{\text{FB}}(c)$ and A_c contribute a combined 8.6) which serve only to compete with A_{LR} in determining δs^2 .

In Figs. 7 through 16, we show the limits placed on the five parameters by various observables projected onto two dimensional planes. Figs. 7, 11, 12, and 13 show that the

most stringent constraint on δh_{dR}^R comes from $A_{FB}^*(u)$, while Figs. 8, 11, 14, and 15 show that the δh_{sR}^R is constrained by A_s^* and $A_{FB}^{**}(s)$. Figs. 10, 13, 15, and 16 show that $\delta h_{bL}^{\text{Higgs}}$ is largely fixed by R_b . It is clear from figs. 12, 14, and 16 that the strongest constraint on δh_{bR}^R comes from A_b and $A_{FB}(b)$. However, a careful look at Fig. 9 shows that the limit on δh_{bR}^R is strongly correlated with the value of δs^2 . Because A_{LR} and other measurements prefer a slightly negative δs^2 , the preferred value of δh_{bR}^R from $A_{FB}(b)$ is shifted to the positive side [9].

VII. LIMITS ON λ' AND λ''

Using Eq. 3.7, we can translate our fit results in Eq. 6.2, to limits on the λ' couplings constants:

$$\begin{aligned}\sum_i |\lambda'_{i31}|^2 &= -38 \pm 36 \\ \sum_i |\lambda'_{i32}|^2 &= -26 \pm 20 \\ \sum_i |\lambda'_{i33}|^2 &= -12.1 \pm 4.7.\end{aligned}\tag{7.1}$$

The correlations between the fit values of the couplings are relatively small (see table IV). The 1σ (2σ) [3σ] upper bounds are then

$$\begin{aligned}\sum_i |\lambda'_{i31}|^2 &\leq -2 \quad (34) [70] \\ \sum_i |\lambda'_{i32}|^2 &\leq -6 \quad (14) [34] \\ \sum_i |\lambda'_{i33}|^2 &\leq -7.4 \quad (-2.8) [1.9]\end{aligned}\tag{7.2}$$

This imposes the following (2σ) [3σ] limits on the individual couplings in the sum:

$$\begin{aligned}|\lambda'_{i31}| &\leq (5.8) [8.4] \\ |\lambda'_{i32}| &\leq (3.8) [5.9] \\ |\lambda'_{i33}| &\leq () [1.4]\end{aligned}\tag{7.3}$$

For $i = 1$ and $i = 2$, stronger constraints at the 2σ level on the relevant couplings are available from other types of experiments [6], so these constraints fail to improve previous results. The strongest constraint is on $i = 3$, where the best-fit value of the sum of squared couplings is negative even at 2σ . This constitutes a significant improvement in the upper bound on $|\lambda'_{i33}|$ over previous bounds on these couplings which were nonzero at the 2σ level. These results are complementary to those obtained in Ref. [7], in which a different combination of λ' couplings was constrained. In particular, for the λ'_{i33} couplings, the σ from the lepton universality constraints is much smaller, but the best-fit value of the squared couplings from the hadronic constraint is negative by an even greater statistical significance.⁶

⁶A strong independent constraint on λ'_{i33} will be available from the measurement of the invisible width of Υ resonance [23].

Next, we consider the constraints on the λ'' couplings. These couplings have hitherto been constrained by experiment only weakly or not at all. Using Eq. 4.5, we can translate Eq. 6.2 into the bounds:

$$\begin{aligned}\sum_k |\lambda''_{31k}|^2 &= -19 \pm 18 \\ \sum_k |\lambda''_{32k}|^2 &= -13 \pm 10 \\ \sum_k |\lambda''_{33k}|^2 &= -6.0 \pm 2.3.\end{aligned}\tag{7.4}$$

Again, the correlations between these constraints are relatively weak, so we neglect them henceforth. The 1σ (2σ) [3σ] upper bounds are then:

$$\begin{aligned}\sum_k |\lambda''_{31k}|^2 &\leq -1 \quad (17) [35] \\ \sum_k |\lambda''_{32k}|^2 &\leq -3 \quad (7) [17] \\ \sum_k |\lambda''_{33k}|^2 &\leq -3.7 (-1.4) [0.9].\end{aligned}\tag{7.5}$$

Recall that the λ'' couplings are antisymmetric in the last two indices; thus, each of the sums above consists of only two terms. The (2σ) [3σ] upper bounds on the individual λ'' couplings are then:

$$\begin{aligned}|\lambda''_{321}| &\leq (2.7) [4.1] \\ |\lambda''_{33i}| &\leq () [0.96].\end{aligned}\tag{7.6}$$

Thus, λ''_{331} and λ''_{332} are excluded at the 2σ level, and λ''_{321} is excluded at the 1σ level. These bounds significantly improve the 1σ bound of $|\lambda''_{33k}| < 0.50$ from R_ℓ [6,8].

These improvements on the bounds of λ' and λ'' are a consequence of the fact that while the data prefers a *positive* shift in the right-handed coupling of the b , which is non-zero by 2.6σ , both λ' and λ'' corrections shift the coupling in the negative direction. This situation is mitigated neither by introducing sfermion mass splittings nor by increasing $\tan\beta$ [26].

VIII. BAYESIAN CONFIDENCE INTERVALS FOR λ' AND λ''

In the previous section we performed a *classical* statistical analysis, i.e. we performed a fit to the data without any *a priori* assumptions about the viability of the model. In particular, we made no assumptions about the signs of the coupling shifts when fitting the data. As a consequence, the best-fit values for the squares of the R-violating couplings were negative, resulting in strong 1σ and 2σ bounds.

An alternate method for calculating confidence levels is to use Bayesian statistical analysis. This technique assumes that R-violating SUSY is the correct underlying theory, and therefore that the shifts to the right-handed couplings are only permitted to be negative and

$\delta h_{b_L}^{\text{Higgs}}$ positive.⁷ The resulting confidence intervals for the couplings squared are positive, and the preferred values are those of the Standard Model (i.e. zero).

However, care should be taken when using these bounds, since they hide the fact that the χ^2 of the corresponding fit is quite large even at low confidence levels. The probability of these bounds arising as a result of statistical fluctuations is therefore quite small.

Below we list the 68% (95%) confidence levels from the constrained fit:

$$\begin{aligned}\delta h_{b_R}^R &\geq -0.0046 \text{ } (-0.010) \\ \delta h_{s_R}^R &\geq -0.031 \text{ } (-0.064) \\ \delta h_{d_R}^R &\geq -0.061 \text{ } (-0.123); \end{aligned} \tag{8.1}$$

The corresponding confidence limits on the couplings are:

$$\begin{aligned}|\lambda''_{33i}| &\leq 1.0 \text{ } (1.5) \\ |\lambda''_{321}| &\leq 2.7 \text{ } (3.9) \end{aligned} \tag{8.2}$$

$$\begin{aligned}|\lambda'_{i33}| &\leq 1.4 \text{ } (2.2) \\ |\lambda'_{i32}| &\leq 3.8 \text{ } (5.6) \\ |\lambda'_{i31}| &\leq 5.2 \text{ } (7.6); \end{aligned} \tag{8.3}$$

The best-fit value for $\delta h_{b_L}^{\text{Higgs}}$ is negative. However, the model generically predicts a positive $\delta h_{b_L}^{\text{Higgs}}$. The best-fit value of $\delta h_{b_L}^{\text{Higgs}}$ consistent with the model is zero; as a result of this tension, the corresponding χ^2 increases even further.

To be quantitative concerning the large χ^2 of the constrained fit confidence intervals, we present the following example. The χ^2 corresponding to the 68% and 95% confidence intervals for $\delta h_{b_R}^R$ are:

$$\begin{aligned}68\% : \chi^2/\text{DOF} &= 26.1/(16 - 1) \rightarrow \text{probability} = 3.7\% \\ 95\% : \chi^2/\text{DOF} &= 33.6/(16 - 1) \rightarrow \text{probability} = 0.4\% \end{aligned} \tag{8.4}$$

We see explicitly that the bounds obtained using the Bayesian analysis are weak, but the χ^2 associated with these bounds is uncomfortably large. If the error bars continue to shrink and the central values stay unchanged, the relevance of the constrained fit bounds must be questioned.

IX. SUMMARY AND CONCLUSIONS

We find that the hadronic Z -decay data from LEP and SLD can be used to place significant constraints on the size of R-parity violating λ' and λ'' couplings. This is possible because the dominant R-violating interactions correct the couplings of the right-handed

⁷We take the prior probability for the coupling shifts to be uniform on the region permitted by the theory and zero elsewhere.

down-type quarks only while the dominant R-conserving MSSM interactions correct only the left-handed couplings. The parity violating asymmetry parameters A_q are particularly sensitive to shifts in the right-handed quark couplings while blind to shifts in the left-handed couplings. This allows us to constrain the R-violating interactions independently from the R-conserving sector.

Current data prefer a shift in right-handed quark couplings *opposite* to the direction predicted by the theory. As a consequence, *all* of the R-violating shifts considered in this work are excluded at the 1σ level. In the λ' case the strongest bound is on the λ'_{i33} , which are excluded at 2σ and on which we have set the 3σ bound

$$|\lambda'_{i33}| \leq 1.4. \quad (9.1)$$

For the λ'' case, the λ''_{331} and λ''_{332} couplings are excluded at the 2σ level, and λ''_{321} is excluded at 1σ . The (2σ) [3σ] upper bounds are

$$\begin{aligned} |\lambda''_{321}| &\leq (2.7) [4.1] \\ |\lambda''_{33i}| &\leq () [0.96]. \end{aligned} \quad (9.2)$$

All bounds are calculated assuming a common sfermion mass of 100 GeV. For larger (common) sfermion masses the above bounds may be interpreted as bounds on $(|\lambda'|, |\lambda''|) \times \sqrt{F(x)/F(x_0)}$, where $F(x)$ is defined in Eq. 3.6 and $x_0 = \frac{m_i^2}{(100\text{GeV})^2}$. We have also performed a Bayesian statistical analysis and obtained corresponding confidence levels.

Generically, R-violating interactions *reduce* the magnitude of the couplings of the the right-handed quarks to the Z and leave the left-handed couplings unchanged. Current LEP/SLD data prefers shifts which *increase* the magnitude of the right handed coupling, to the extent that even the Standard Model prediction is in only marginal agreement with the data. Future reductions in the experimental uncertainties in the asymmetry parameters without changes in the central values would eventually rule out both the standard model and the MSSM with R-violating couplings of either the λ' or λ'' variety.

ACKNOWLEDGMENTS

We thank R. Clare and M. Swartz for providing us with the latest LEPWWG data including the correlation matrices, and David Muller for providing us with detailed instructions on how to incorporate the SLD measurement of A_s into our fit. We also gratefully acknowledge helpful communications with B. Allanach, Y. Nir, P. Rowson, D. Su and Z. Sullivan. This work was supported in part (O.L. and W.L.) by the U. S. Department of Energy, grant DE-FG05-92-ER40709, Task A.

APPENDIX: FEYNMAN INTEGRALS

The integrals we use here are defined explicitly in [7]. In the approximation $m_Z^2 = 0$, the one-loop diagrams which appear in this work are proportional to the following expressions:

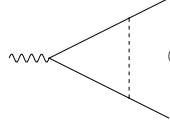

$$\begin{aligned} &\propto \left[(d-2) \hat{C}_{24} (0, 0, m_Z^2; m_s, m_f, m_f) - m_Z^2 \hat{C}_{23} (0, 0, m_Z^2; m_s, m_f, m_f) \right] \\ &\approx -\frac{1}{(4\pi)^2} \left[\frac{1}{2} \left(\Delta_\epsilon - \ln \frac{m_f^2}{\mu^2} \right) + f(x) \right] \end{aligned} \quad (\text{A1})$$

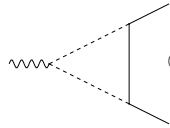

$$\propto 2 \hat{C}_{24} (0, 0, m_Z^2; m_f, m_s, m_s) \approx -\frac{1}{(4\pi)^2} \left[\frac{1}{2} \left(\Delta_\epsilon - \ln \frac{m_f^2}{\mu^2} \right) - g(x) \right] \quad (\text{A2})$$

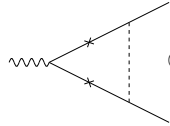

$$\propto m_f^2 \hat{C}_0 (0, 0, m_Z^2; m_s, m_f, m_f) \approx -\frac{1}{(4\pi)^2} [f(x) + g(x)] \quad (\text{A3})$$

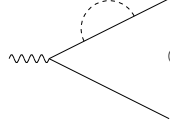

$$\propto \hat{B}_1 (0; m_f, m_s) \approx \frac{1}{(4\pi)^2} \left[\frac{1}{2} \left(\Delta_\epsilon - \ln \frac{m_f^2}{\mu^2} \right) - g(x) \right] \quad (\text{A4})$$

where

$$\begin{aligned} f(x) &= -\frac{1}{4(1-x)^2} (x^2 - 1 - 2 \ln x) \\ g(x) &= -\frac{1}{2} \ln x + \frac{1}{4(1-x)^2} [-(1-x)(1-3x) + 2x^2 \ln x] \end{aligned} \quad (\text{A5})$$

for $x = m_f^2/m_s^2$. For $x \rightarrow 1$ (degenerate scalar and fermion masses),

$$\begin{aligned} f(x) &\approx -\frac{1}{2} + \frac{x-1}{6} + \dots \\ g(x) &\approx -\frac{x-1}{3} + \dots \end{aligned} \quad (\text{A6})$$

For $x \rightarrow 0$ (the decoupling limit of heavy scalar masses),

$$\begin{aligned} f(x) &\approx \frac{1}{2} \ln x + \frac{1}{4} + \dots \\ g(x) &\approx -\frac{1}{2} \ln x - \frac{1}{4} + \dots \sim -f(x). \end{aligned} \quad (\text{A7})$$

TABLES

Observable	Reference	Measured Value	ZFITTER Prediction
<u>Z lineshape variables</u>			
m_Z	[14]	91.1872 ± 0.0021 GeV	input
Γ_Z	[14]	2.4944 ± 0.0024 GeV	—
σ_{had}^0	[14]	41.544 ± 0.037 nb	—
R_e	[14]	20.803 ± 0.049	—
R_μ	[14]	20.786 ± 0.033	—
R_τ	[14]	20.764 ± 0.045	—
$A_{\text{FB}}(e)$	[14]	0.0145 ± 0.0024	0.0152
$A_{\text{FB}}(\mu)$	[14]	0.0167 ± 0.0013	—
$A_{\text{FB}}(\tau)$	[14]	0.0188 ± 0.0017	—
$R_{\nu/e}$		1.9755 ± 0.0080	1.9916
<u>τ polarization at LEP</u>			
A_e	[14]	0.1483 ± 0.0051	0.1423
A_τ	[14]	0.1424 ± 0.0044	—
<u>SLD left–right asymmetries</u>			
A_{LR}	[15]	0.15108 ± 0.00218	0.1423
A_e	[15]	0.1558 ± 0.0064	0.1423
A_μ	[15]	0.137 ± 0.016	—
A_τ	[15]	0.142 ± 0.016	—
<u>light quark flavor</u>			
R_s^{t*} [OPAL]	[17]	0.392 ± 0.062	0.360
$A_{\text{FB}}^*(s)$ [OPAL]	[17]	0.075 ± 0.029	0.100
$A_{\text{FB}}^*(u)$ [OPAL]	[17]	0.086 ± 0.037	0.071
$A_{\text{FB}}^{**}(s)$ [DELPHI]	[18]	0.1008 ± 0.0120	0.1006
A_s^* [SLD]	[19]	0.85 ± 0.092	0.935
<u>heavy quark flavor</u>			
R_b	[14]	0.21642 ± 0.00073	0.21583
R_c	[14]	0.1674 ± 0.0038	0.1722
$A_{\text{FB}}(b)$	[14]	0.0988 ± 0.0020	0.0997
$A_{\text{FB}}(c)$	[14]	0.0692 ± 0.0037	0.0711
A_b	[14]	0.911 ± 0.025	0.934
A_c	[14]	0.630 ± 0.026	0.666

TABLE I. LEP/SLD observables and their Standard Model predictions. The ratio $R_{\nu/e} = \Gamma_{\nu\bar{\nu}}/\Gamma_{e^+e^-}$ was calculated from the Z -lineshape observables. The Standard Model predictions were calculated using ZFITTER v.6.21 [21] with $m_t = 174.3$ GeV [22], $m_H = 300$ GeV, and $\alpha_s(m_Z) = 0.120$ as input.

	m_Z	Γ_Z	σ_{had}^0	R_e	R_μ	R_τ	$A_{\text{FB}}(e)$	$A_{\text{FB}}(\mu)$	$A_{\text{FB}}(\tau)$
m_Z	1.000	-0.008	-0.050	0.073	0.001	0.002	-0.015	0.046	0.034
Γ_Z		1.000	-0.284	-0.006	0.008	0.000	-0.002	0.002	-0.003
σ_{had}^0			1.000	0.109	0.137	0.100	0.008	0.001	0.007
R_e				1.000	0.070	0.044	-0.356	0.023	0.016
R_μ					1.000	0.072	0.005	0.006	0.004
R_τ						1.000	0.003	-0.003	0.010
$A_{\text{FB}}(e)$							1.000	-0.026	-0.020
$A_{\text{FB}}(\mu)$								1.000	0.045
$A_{\text{FB}}(\tau)$									1.000

TABLE II. The correlation of the Z lineshape variables at LEP.

	R_b	R_c	$A_{\text{FB}}(b)$	$A_{\text{FB}}(c)$	A_b	A_c
R_b	1.00	-0.14	-0.03	0.01	-0.03	0.02
R_c		1.00	0.05	-0.05	0.02	-0.02
$A_{\text{FB}}(b)$			1.00	0.09	0.02	0.00
$A_{\text{FB}}(c)$				1.00	-0.01	0.03
A_b					1.00	0.15
A_c						1.00

TABLE III. The correlation of the heavy flavor variables from LEP/SLD.

	δs^2	$\delta h_{dR}^{\mathcal{R}}$	$\delta h_{sR}^{\mathcal{R}}$	$\delta h_{bR}^{\mathcal{R}}$	$\delta h_{bL}^{\text{Higgs}}$
δs^2	1.00	0.01	-0.06	-0.42	-0.15
$\delta h_{dR}^{\mathcal{R}}$		1.00	-0.30	0.09	-0.75
$\delta h_{sR}^{\mathcal{R}}$			1.00	0.05	-0.22
$\delta h_{bR}^{\mathcal{R}}$				1.00	0.30
$\delta h_{bL}^{\text{Higgs}}$					1.00

TABLE IV. The correlation matrix of the fit parameters.

FIGURES

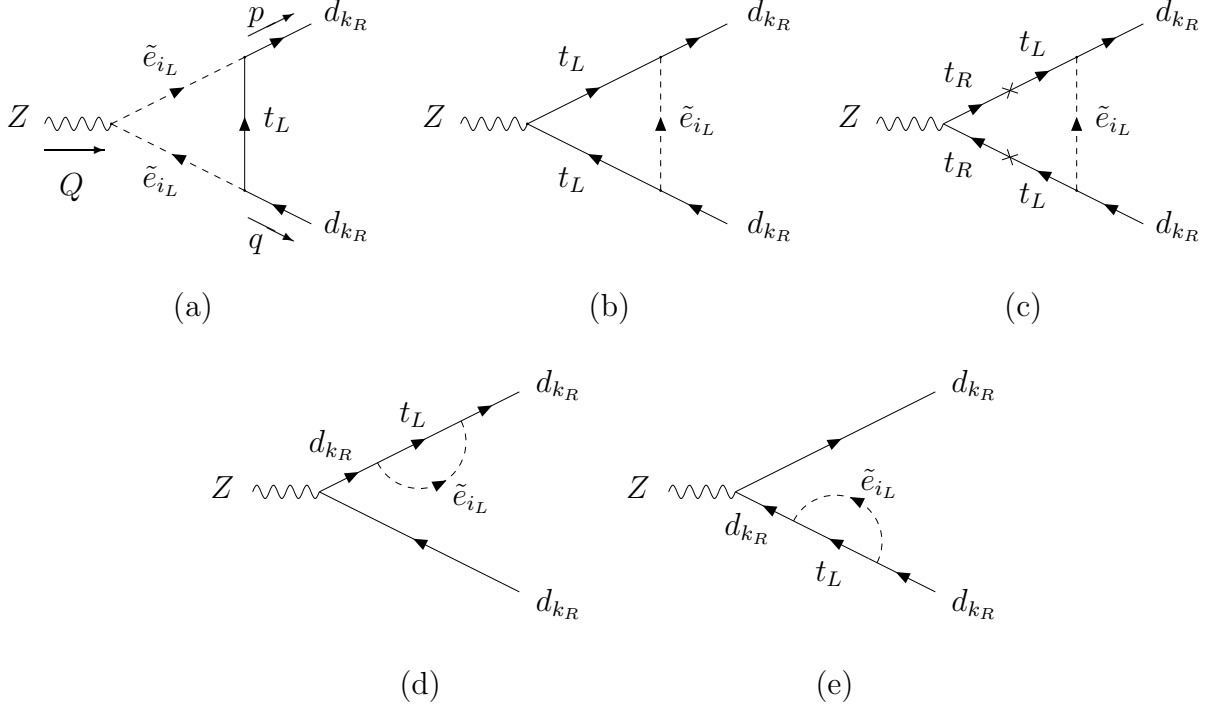

FIG. 1. One-loop corrections to $Z \rightarrow d_{k_R} \bar{d}_{k_R}$ involving the R-parity violating λ' couplings.

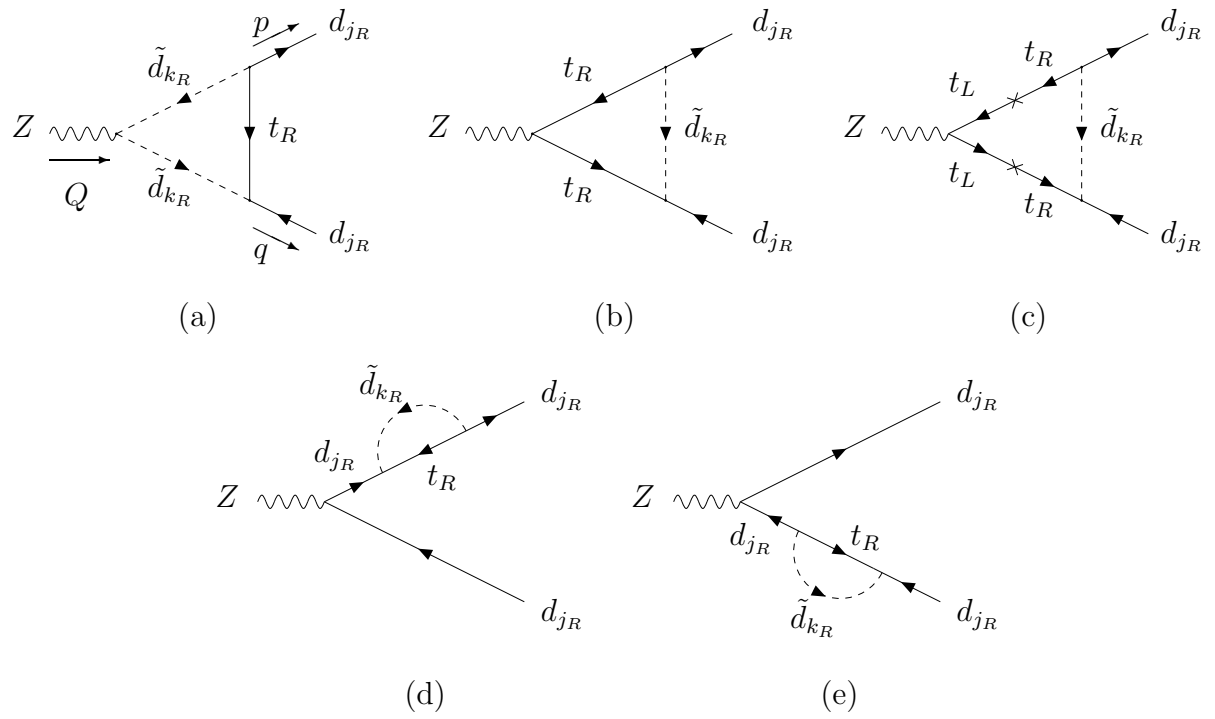

FIG. 2. One-loop corrections to $Z \rightarrow d_{jR} \bar{d}_{jR}$ involving the R-parity violating λ'' couplings.

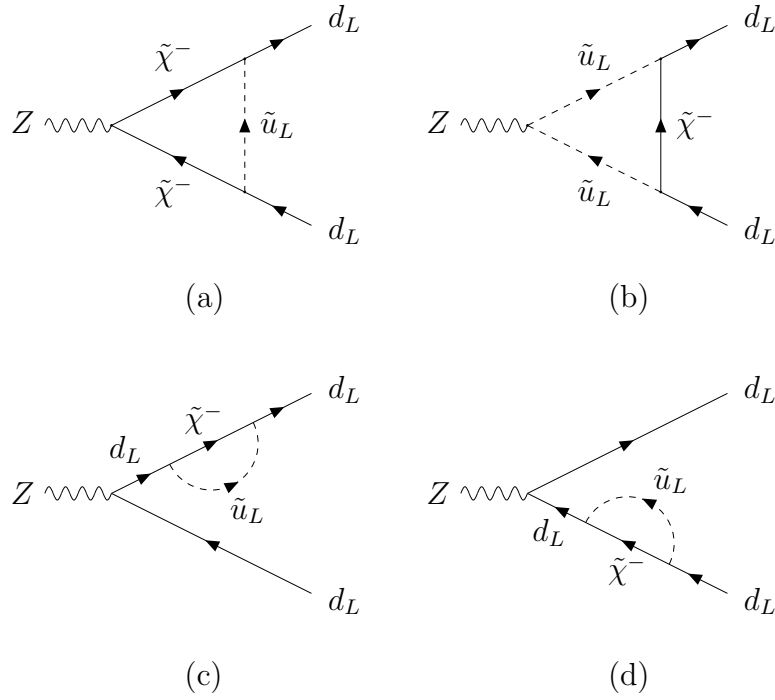

FIG. 3. Examples of leading 1PI R-parity conserving chargino-sfermion contributions subsumed into δs^2 . There are analogous diagrams with u_L quark final states and with lepton final states.

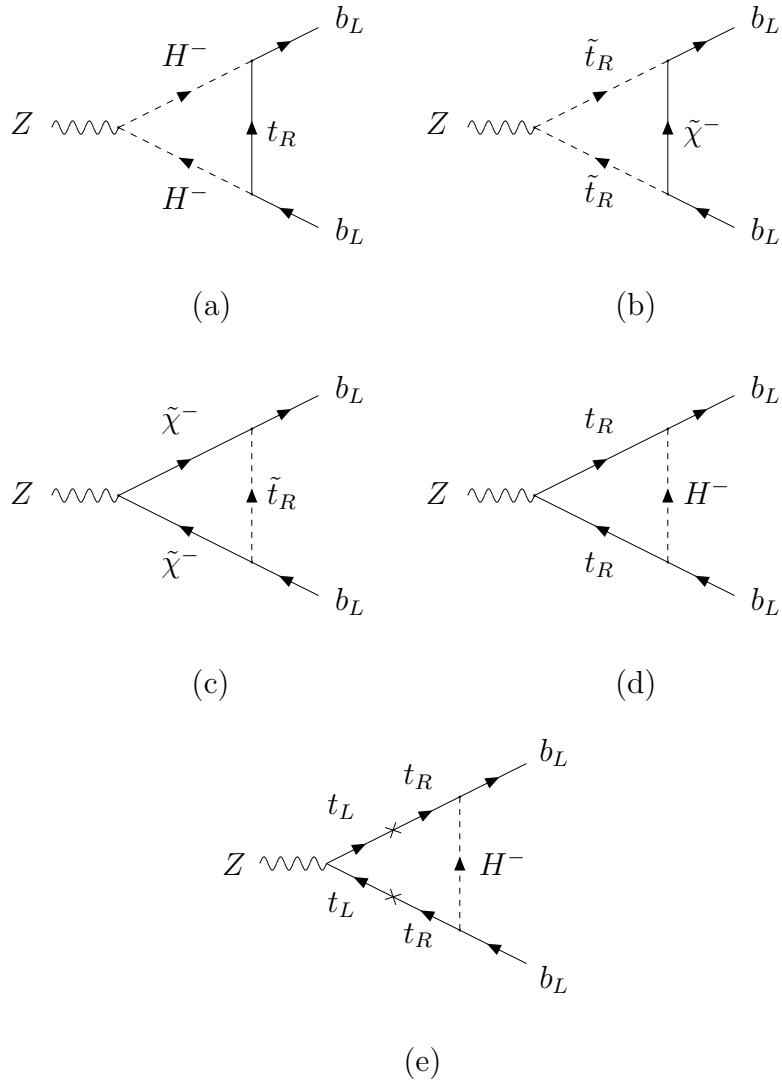

FIG. 4. Leading 1PI R-parity conserving contributions specific to $\delta h_{b_L}^{\text{Higgs}}$.

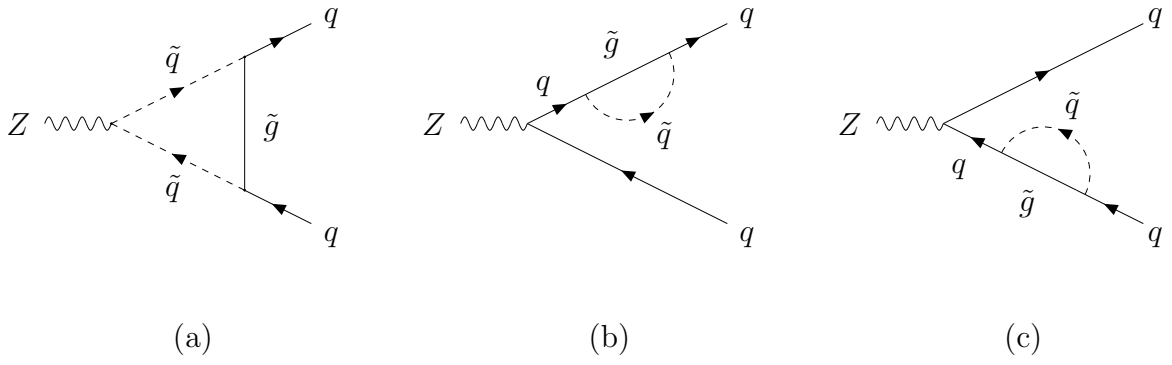

FIG. 5. Gluino–squark corrections to the $Zq\bar{q}$ vertex.

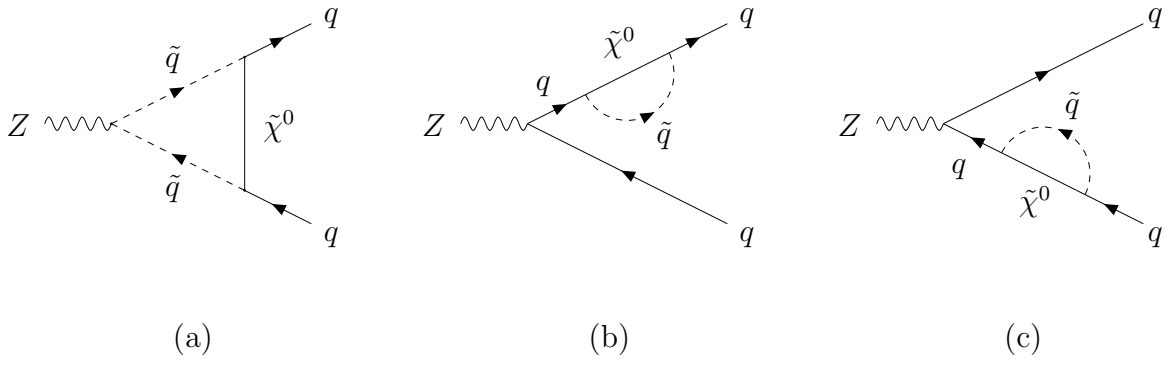

FIG. 6. Neutralino–squark corrections to the $Zq\bar{q}$ vertex.

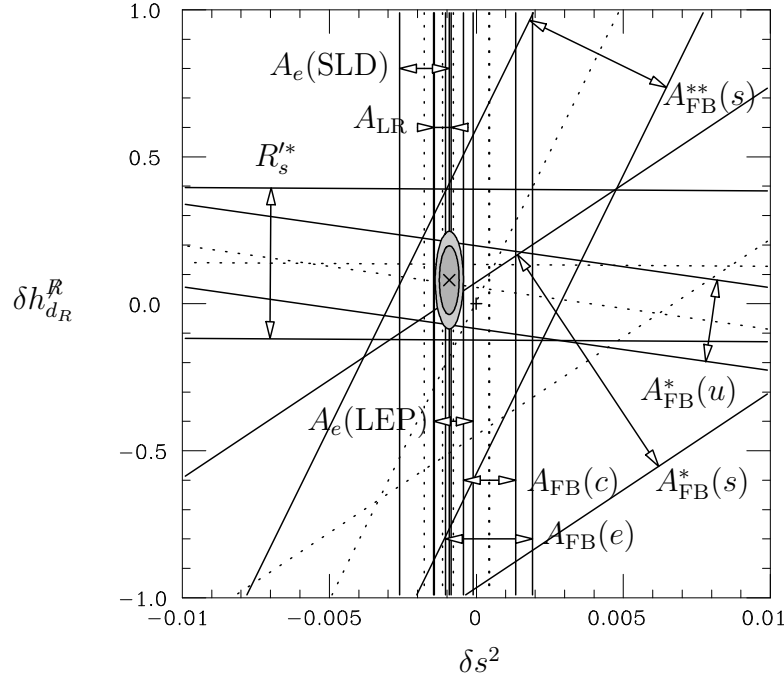

FIG. 7. Constraints in the δs^2 - δh_{dR}^R plane from various observables.

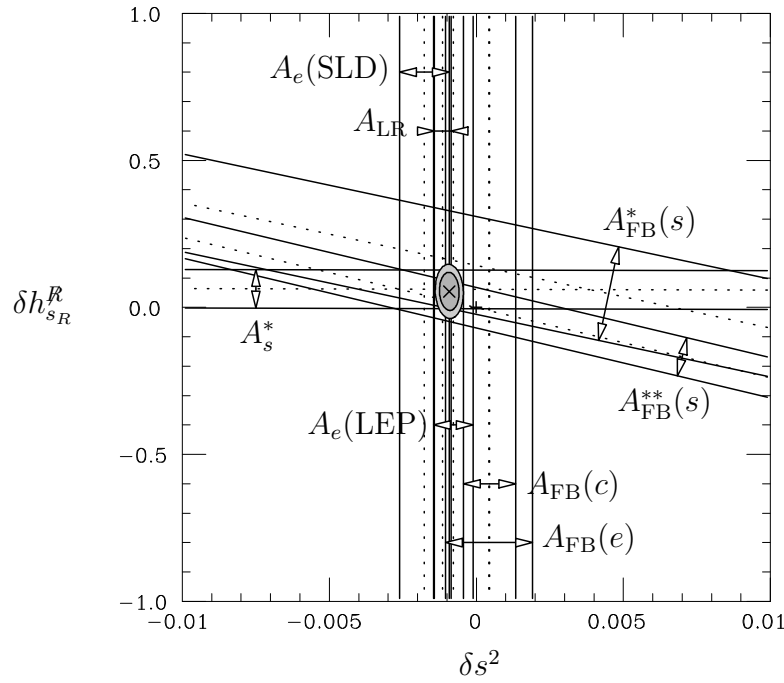

FIG. 8. Constraints in the δs^2 - δh_{sR}^R plane from various observables.

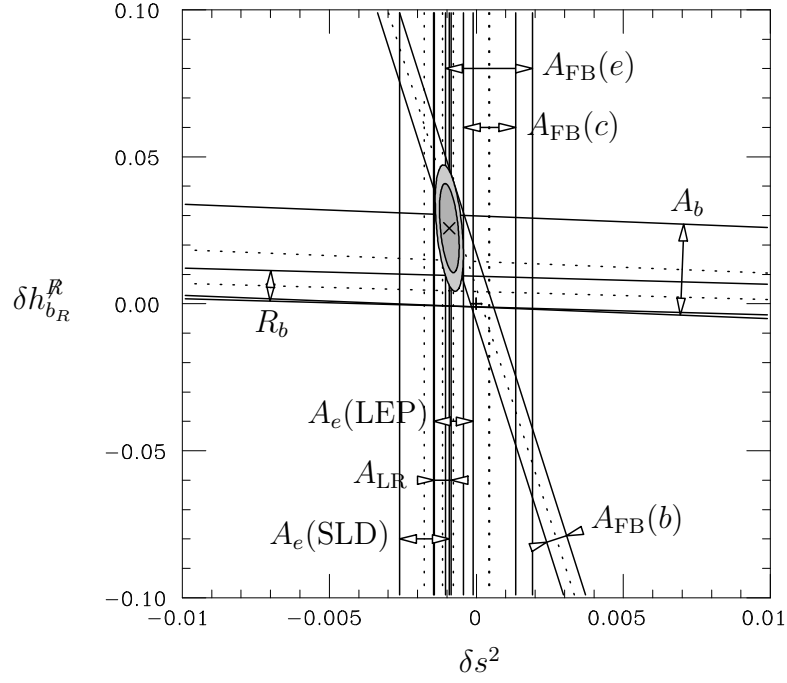

FIG. 9. Constraints in the $\delta s^2 - \delta h_{bR}^R$ plane from various observables.

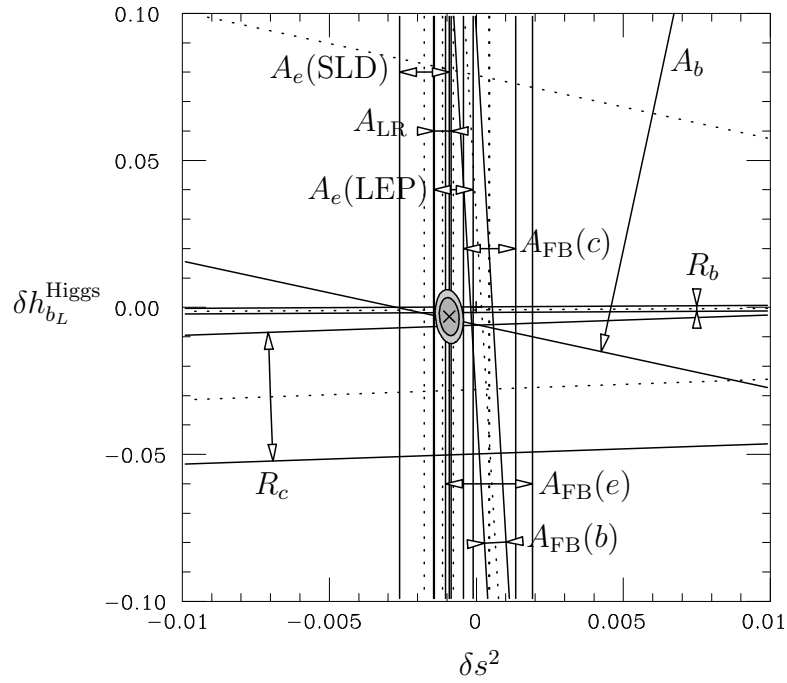

FIG. 10. Constraints in the $\delta s^2 - \delta h_{bL}^{\text{Higgs}}$ plane from various observables.

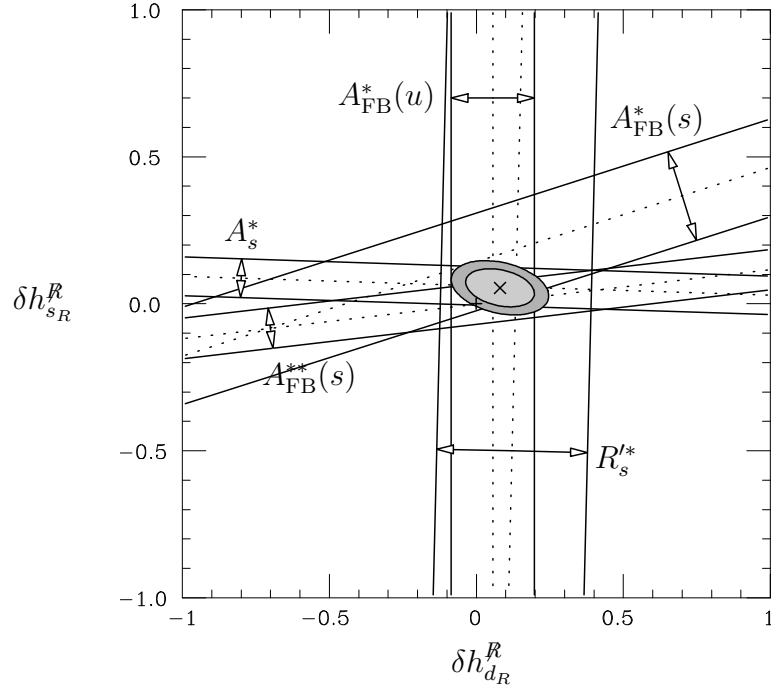

FIG. 11. Constraints in the δh_{dR}^R - δh_{sR}^R plane from various observables.

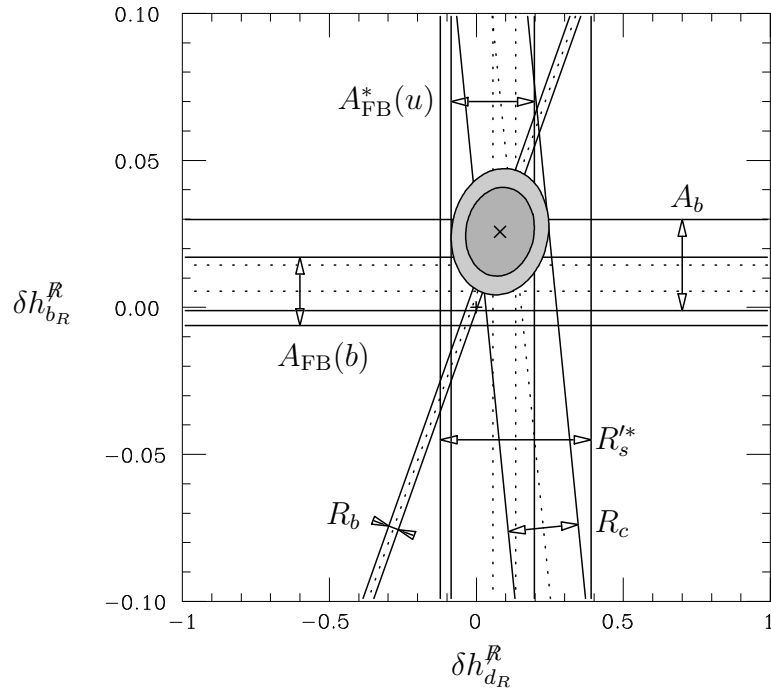

FIG. 12. Constraints in the δh_{dR}^R - δh_{bR}^R plane from various observables.

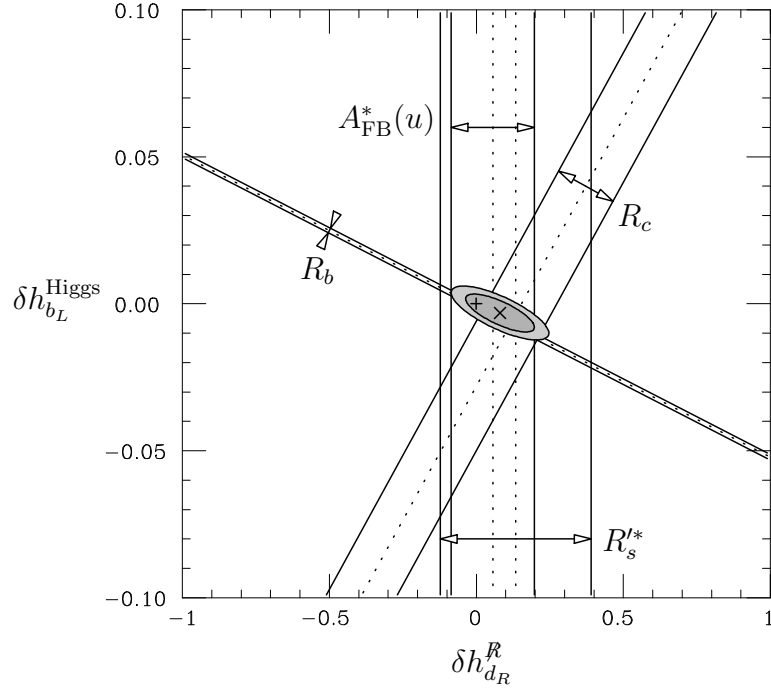

FIG. 13. Constraints in the $\delta h_{dR}^R - \delta h_{bR}^R$ plane from various observables.

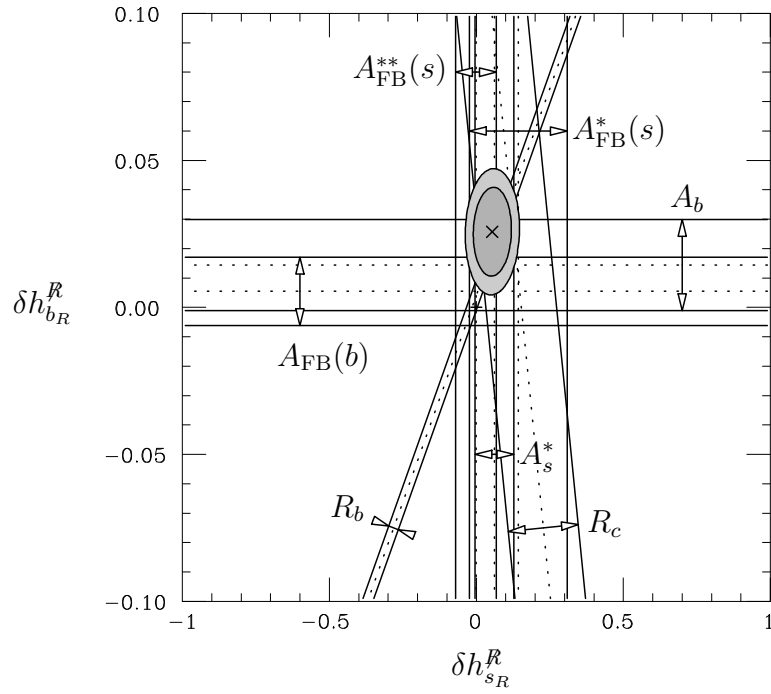

FIG. 14. Constraints in the $\delta h_{dR}^R - \delta h_{bR}^R$ plane from various observables.

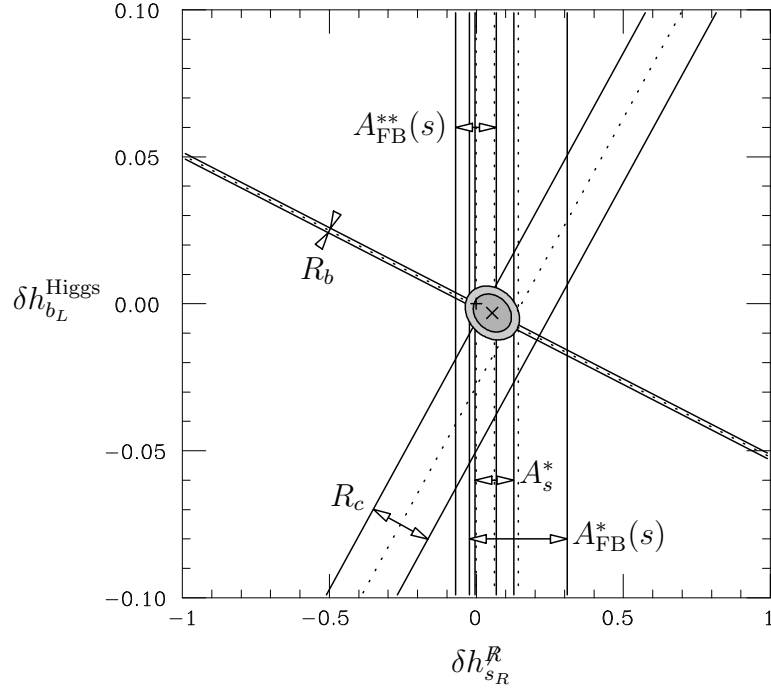

FIG. 15. Constraints in the $\delta h_{dR}^R - \delta h_{bR}^R$ plane from various observables.

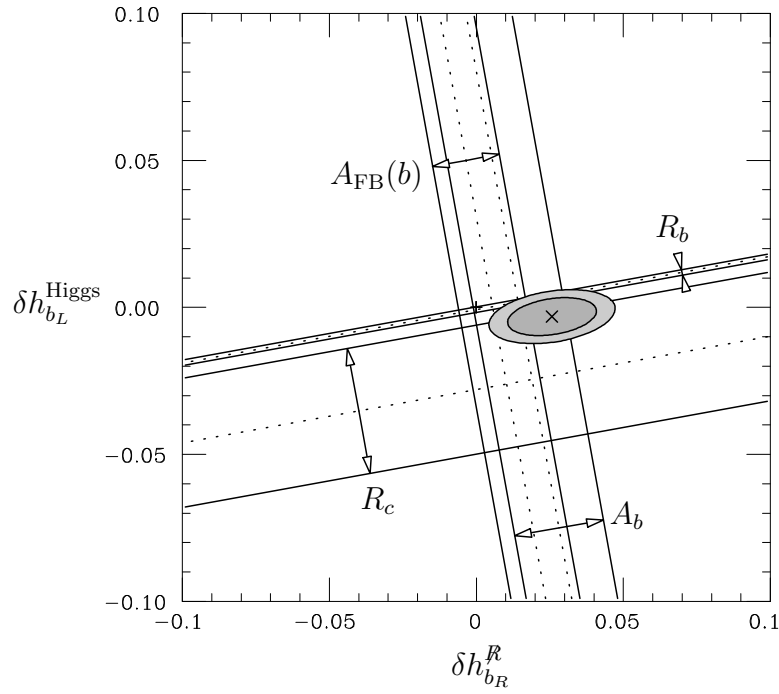

FIG. 16. Constraints in the $\delta h_{bR}^R - \delta h_{bL}^{\text{Higgs}}$ plane from various observables.

REFERENCES

- [1] H. Dreiner, in *“Perspectives on Supersymmetry”*, ed. G. L. Kane, World Scientific, 462–479, hep-ph/9707435; G. Bhattacharyya, hep-ph/9709395; J. W. Valle, hep-ph/9802292.
- [2] Super-Kamiokande Collaboration (Y. Fukuda et al.), Phys. Rev. Lett. **81**, 1562–1567 (1998); Phys. Rev. Lett. **82**, 1810–1814 (1999); Phys. Rev. Lett. **82**, 2430–2434 (1999).
- [3] M. Nowakowski and A. Pilaftsis, Nucl. Phys. B**461**, 19 (1996).
- [4] L. J. Hall and M. Suzuki, Nucl. Phys. B**231**, 419 (1984).
- [5] H. E. Haber and G. L. Kane, Phys. Rep. **117**, 75 (1985); S. P. Martin, hep-ph/9709356.
- [6] B. C. Allanach, A. Dedes and H. K. Dreiner, Phys. Rev. D**60**, 075014 (1999), hep-ph/9906209.
- [7] O. Lebedev, W. Loinaz and T. Takeuchi, hep-ph/9910435.
- [8] G. Bhattacharyya, D. Choudhury and K. Sridhar, Phys. Lett. B**355**, 193 (1995), hep-ph/9504314.
- [9] T. Takeuchi, A. K. Grant, and J. L. Rosner, in *the Proceedings of DPF’94*, ed. S. Seidel (World Scientific, Singapore 1995), hep-ph/9409211.
- [10] W. Loinaz and T. Takeuchi, Phys. Rev. D**60**, 015005 (1999).
- [11] M. E. Peskin and T. Takeuchi, Phys. Rev. Lett. **65**, 964–967 (1990); Phys. Rev. D**46**, 381–409 (1992).
- [12] J. Erler, J. L. Feng and N. Polonsky, Phys. Rev. Lett. **78**, 3063 (1997), hep-ph/9612397.
- [13] D. Abbaneo, et al. [the LEP Collaborations, the LEP Electroweak Working Group, and the SLD Heavy Flavor and Electroweak Groups] CERN-EP-99-015.
- [14] J. Mnich, CERN-EP/99-143; M. Swartz, talk presented at *Lepton-Photon’99, Stanford, 10 August 1999* (transparencies available from <http://www-sldnt.slac.stanford.edu/lp99/>); S. Fahey, G. Quast, talks presented at *EPS-HEP’99, Tampere, Finland, July 1999*, (transparencies available from <http://neutrino.pc.helsinki.fi/hep99/>).
- [15] K. Abe, et al. [SLD Collaboration] hep-ex/9908006; J. E. Brau [The SLD Collaboration] talk presented at *EPS-HEP’99, Tampere, Finland, 15 July 1999* (transparencies available from <http://www-sld.slac.stanford.edu/sldwww/pubs.html>).
- [16] P. C. Rowson, private communication.
- [17] K. Ackerstaff, et al. [OPAL Collaboration] Z. Phys. C**76**, 387 (1997).
- [18] E. Boudinov, et al. [DELPHI Collaboration] *Presented at the EPS-HEP’99, Tampere, Finland, 15–21 July 1999*, DELPHI 99-98 CONF 285.
- [19] K. Abe, et al. [SLD Collaboration] hep-ex/9908038.
- [20] D. Muller, private communication.
- [21] The ZFITTER package: D. Bardin, et al., Z. Phys. C**44**, 493 (1989); Nucl. Phys. B**351**, 1 (1991); Phys. Lett. B**255**, 290 (1991); CERN-TH-6443/92, 1992; DESY 99-070, hep-ph/9908433.
- [22] L. Demortier, et al. [The Top Averaging Group] FERMILAB-TM-2084.
- [23] L. N. Chang, O. Lebedev, J. N. Ng, Phys. Lett. B**441**, 419–424 (1998).
- [24] H. E. Haber and H. E. Logan, hep-ph/9909335.
- [25] J. M. Yang, hep-ph/9905486.
- [26] O. Lebedev, W. Loinaz and T. Takeuchi, in preparation.